



***msi***<sup>™</sup>

# **X58A-GD45 series**

MS-7522 (v5.x) Mainboard

G52-75221XE

## Copyright Notice

---

The material in this document is the intellectual property of **MICRO-STAR INTERNATIONAL**. We take every care in the preparation of this document, but no guarantee is given as to the correctness of its contents. Our products are under continual improvement and we reserve the right to make changes without notice.

## Trademarks

---

All trademarks are the properties of their respective owners.

- MSI® is registered trademark of Micro-Star Int'l Co.,Ltd.
- NVIDIA® is registered trademark of NVIDIA Corporation.
- ATI® is registered trademark of ATI Technologies, Inc.
- AMD® is registered trademarks of AMD Corporation.
- Intel® is registered trademarks of Intel Corporation.
- Windows® is registered trademarks of Microsoft Corporation.
- AMI® is registered trademark of American Megatrends, Inc.
- Award® is a registered trademark of Phoenix Technologies Ltd.
- Sound Blaster® is registered trademark of Creative Technology Ltd.
- Realtek® is registered trademark of Realtek Semiconductor Corporation.
- JMicron® is registered trademark of JMicron Technology Corporation.
- Netware® is a registered trademark of Novell, Inc.

## Revision History

---

| Revision | Revision History | Date         |
|----------|------------------|--------------|
| V5.0     | First release    | October 2010 |

## Technical Support

---

If a problem arises with your system and no solution can be obtained from the user's manual, please contact your place of purchase or local distributor. Alternatively, please try the following help resources for further guidance.

- ☐ Visit the MSI website for FAQ, technical guide, BIOS updates, driver updates, and other information: <http://www.msi.com/index.php?func=service>
- ☐ Contact our technical staff at: <http://ocss.msi.com>

## Safety Instructions

---

- Always read the safety instructions carefully.
- Keep this User's Manual for future reference.
- Keep this equipment away from humidity.
- Lay this equipment on a reliable flat surface before setting it up.
- The openings on the enclosure are for air convection hence protects the equipment from overheating. **DO NOT COVER THE OPENINGS.**
- Make sure the voltage of the power source and adjust properly 110/220V before connecting the equipment to the power inlet.
- Place the power cord such a way that people can not step on it. Do not place anything over the power cord.
- Always Unplug the Power Cord before inserting any add-on card or module.
- All cautions and warnings on the equipment should be noted.
- Never pour any liquid into the opening that could damage or cause electrical shock.
- If any of the following situations arises, get the equipment checked by service personnel:
  - The power cord or plug is damaged.
  - Liquid has penetrated into the equipment.
  - The equipment has been exposed to moisture.
  - The equipment does not work well or you can not get it work according to User's Manual.
  - The equipment has dropped and damaged.
  - The equipment has obvious sign of breakage.

**DO NOT LEAVE THIS EQUIPMENT IN AN ENVIRONMENT UNCONDITIONED, STORAGE TEMPERATURE ABOVE 60°C (140°F), IT MAY DAMAGE THE EQUIPMENT.**

**CAUTION:** Danger of explosion if battery is incorrectly replaced.

Replace only with the same or equivalent type recommended by the manufacturer.

警告使用者:

這是甲類資訊產品，在居住的環境中使用時，可能會造成無線電干擾，在這種情況下，使用者會被要求採取某些適當的對策。



廢電池請回收

For better environmental protection, waste batteries should be collected separately for recycling special disposal.

## FCC-B Radio Frequency Interference Statement

This equipment has been tested and found to comply with the limits for a Class B digital device, pursuant to Part 15 of the FCC Rules. These limits are designed to provide reasonable protection against harmful interference in a residential installation. This equipment generates, uses and can radiate radio frequency energy and, if not installed and used in accordance with the instructions, may cause harmful interference to radio communications. However, there is no guarantee that interference will not occur in a particular installation. If this equipment does cause harmful interference to radio or television reception, which can be determined by turning the equipment off and on, the user is encouraged to try to correct the interference by one or more of the measures listed below.



- Reorient or relocate the receiving antenna.
- Increase the separation between the equipment and receiver.
- Connect the equipment into an outlet on a circuit different from that to which the receiver is connected.
- Consult the dealer or an experienced radio/television technician for help.

### Notice 1

The changes or modifications not expressly approved by the party responsible for compliance could void the user's authority to operate the equipment.

### Notice 2

Shielded interface cables and A.C. power cord, if any, must be used in order to comply with the emission limits.

VOIR LA NOTICE D'INSTALLATION AVANT DE RACCORDER AU RESEAU.

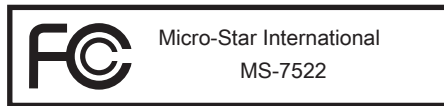

This device complies with Part 15 of the FCC Rules. Operation is subject to the following two conditions:

- 1) this device may not cause harmful interference, and
- 2) this device must accept any interference received, including interference that may cause undesired operation.

## WEEE (Waste Electrical and Electronic Equipment) Statement

### ENGLISH

To protect the global environment and as an environmentalist, MSI must remind you that...



Under the European Union ("EU") Directive on Waste Electrical and Electronic Equipment, Directive 2002/96/EC, which takes effect on August 13, 2005, products of "electrical and electronic equipment" cannot be discarded as municipal waste anymore and manufacturers of covered electronic equipment will be obligated to take back such products at the end of their useful life. MSI will comply with the product take back requirements at the end of life of MSI-branded products that are sold into the EU. You can return these products to local collection points.

### DEUTSCH

Hinweis von MSI zur Erhaltung und Schutz unserer Umwelt

Gemäß der Richtlinie 2002/96/EG über Elektro- und Elektronik-Altgeräte dürfen Elektro- und Elektronik-Altgeräte nicht mehr als kommunale Abfälle entsorgt werden. MSI hat europaweit verschiedene Sammel- und Recyclingunternehmen beauftragt, die in die Europäische Union in Verkehr gebrachten Produkte, am Ende seines Lebenszyklus zurückzunehmen. Bitte entsorgen Sie dieses Produkt zum gegebenen Zeitpunkt ausschliesslich an einer lokalen Altgerätesammelstelle in Ihrer Nähe.

### FRANÇAIS

En tant qu'écologiste et afin de protéger l'environnement, MSI tient à rappeler ceci...

Au sujet de la directive européenne (EU) relative aux déchets des équipement électriques et électroniques, directive 2002/96/EC, prenant effet le 13 août 2005, que les produits électriques et électroniques ne peuvent être déposés dans les décharges ou tout simplement mis à la poubelle. Les fabricants de ces équipements seront obligés de récupérer certains produits en fin de vie. MSI prendra en compte cette exigence relative au retour des produits en fin de vie au sein de la communauté européenne. Par conséquent vous pouvez retourner localement ces matériels dans les points de collecte.

### РУССКИЙ

Компания MSI предпринимает активные действия по защите окружающей среды, поэтому напоминаем вам, что...

В соответствии с директивой Европейского Союза (ЕС) по предотвращению загрязнения окружающей среды использованным электрическим и электронным оборудованием (директива WEEE 2002/96/ЕС), вступающей в силу 13 августа 2005 года, изделия, относящиеся к электрическому и электронному оборудованию, не могут рассматриваться как бытовой мусор, поэтому производители вышеперечисленного электронного оборудования обязаны принимать его для переработки по окончании срока службы. MSI обязуется соблюдать требования по приему продукции, проданной под маркой MSI на территории ЕС, в переработку по окончании срока службы. Вы можете вернуть эти изделия в специализированные пункты приема.

## ESPAÑOL

MSI como empresa comprometida con la protección del medio ambiente, recomienda: Bajo la directiva 2002/96/EC de la Unión Europea en materia de desechos y/o equipos electrónicos, con fecha de rigor desde el 13 de agosto de 2005, los productos clasificados como "eléctricos y equipos electrónicos" no pueden ser depositados en los contenedores habituales de su municipio, los fabricantes de equipos electrónicos, están obligados a hacerse cargo de dichos productos al término de su período de vida. MSI estará comprometido con los términos de recogida de sus productos vendidos en la Unión Europea al final de su período de vida. Usted debe depositar estos productos en el punto limpio establecido por el ayuntamiento de su localidad o entregar a una empresa autorizada para la recogida de estos residuos.

## NEDERLANDS

Om het milieu te beschermen, wil MSI u eraan herinneren dat...

De richtlijn van de Europese Unie (EU) met betrekking tot Vervuiling van Electriche en Electronische producten (2002/96/EC), die op 13 Augustus 2005 in zal gaan kunnen niet meer beschouwd worden als vervuiling. Fabrikanten van dit soort producten worden verplicht om producten retour te nemen aan het eind van hun levenscyclus. MSI zal overeenkomstig de richtlijn handelen voor de producten die de merknaam MSI dragen en verkocht zijn in de EU. Deze goederen kunnen geretourneerd worden op lokale inzamelingspunten.

## SRPSKI

Da bi zaštitili prirodnu sredinu, i kao preduzeće koje vodi računa o okolini i prirodnoj sredini, MSI mora da vas pedesti da...

Po Direktivi Evropske unije ("EU") o odbačenoj ekektronskoj i električnoj opremi, Direktiva 2002/96/EC, koja stupa na snagu od 13. Avgusta 2005, proizvodi koji spadaju pod "elektronsku i električnu opremu" ne mogu više biti odbačeni kao običan otpad i proizvođači ove opreme biće prinuđeni da uzmu natrag ove proizvode na kraju njihovog uobičajenog veka trajanja. MSI će poštovati zahtev o preuzimanju ovakvih proizvoda kojima je istekao vek trajanja, koji imaju MSI oznaku i koji su prodati u EU. Ove proizvode možete vratiti na lokalnim mestima za prikupljanje.

## POLSKI

Aby chronić nasze środowisko naturalne oraz jako firma dbająca o ekologię, MSI przypomina, że...

Zgodnie z Dyrektywą Unii Europejskiej ("UE") dotyczącą odpadów produktów elektrycznych i elektronicznych (Dyrektywa 2002/96/EC), która wchodzi w życie 13 sierpnia 2005, tzw. "produkty oraz wyposażenie elektryczne i elektroniczne" nie mogą być traktowane jako śmieci komunalne, tak więc producenci tych produktów będą zobowiązani do odbierania ich w momencie gdy produkt jest wycofywany z użycia. MSI wypełni wymagania UE, przyjmując produkty (sprzedawane na terenie Unii Europejskiej) wycofywane z użycia. Produkty MSI będzie można zwracać w wyznaczonych punktach zbiorczych.

## TÜRKÇE

Çevreci özelliğiyle bilinen MSI dünyada çevreyi korumak için hatırlatır:

Avrupa Birliği (AB) Kararnamesi Elektrik ve Elektronik Malzeme Atığı, 2002/96/EC Kararnamesi altında 13 Ağustos 2005 tarihinden itibaren geçerli olmak üzere, elektrikli ve elektronik malzemeler diğer atıklar gibi çöpe atılmayacak ve bu elektronik cihazların üreticileri, cihazların kullanım süreleri bittikten sonra ürünleri geri toplamakla yükümlü olacaktır. Avrupa Birliği'ne satılan MSI markalı ürünlerin kullanım süreleri bittiğinde MSI ürünlerin geri alınması isteği ile işbirliği içerisinde olacaktır. Ürünlerinizi yerel toplama noktalarına bırakabilirsiniz.

## ČESKY

Záleží nám na ochraně životního prostředí - společnost MSI upozorňuje...

Podle směrnice Evropské unie ("EU") o likvidaci elektrických a elektronických výrobků 2002/96/EC platné od 13. srpna 2005 je zakázáno likvidovat "elektrické a elektronické výrobky" v běžném komunálním odpadu a výrobci elektrických výrobků, na které se tato směrnice vztahuje, budou povinni odebírat takové výrobky zpět po skončení jejich životnosti. Společnost MSI splní požadavky na odebírání výrobků značky MSI, prodávaných v zemích EU, po skončení jejich životnosti. Tyto výrobky můžete odevzdat v místních sběrnách.

## MAGYAR

Annak érdekében, hogy környezetünket megvédjük, illetve környezetvédőként fellépve az MSI emlékezteti Önt, hogy ...

Az Európai Unió („EU”) 2005. augusztus 13-án hatályba lépő, az elektromos és elektronikus berendezések hulladékairól szóló 2002/96/EK irányelve szerint az elektromos és elektronikus berendezések többé nem kezelhetőek lakossági hulladékként, és az ilyen elektronikus berendezések gyártói köteleessé válnak az ilyen termékek visszavételére azok hasznos élettartama végén. Az MSI betartja a termékvisszavétellel kapcsolatos követelményeket az MSI márkánév alatt az EU-n belül értékesített termékek esetében, azok élettartamának végén. Az ilyen termékeket a legközelebbi gyűjtőhelyre viheti.

## ITALIANO

Per proteggere l'ambiente, MSI, da sempre amica della natura, ti ricorda che....

In base alla Direttiva dell'Unione Europea (EU) sullo Smaltimento dei Materiali Elettrici ed Elettronici, Direttiva 2002/96/EC in vigore dal 13 Agosto 2005, prodotti appartenenti alla categoria dei Materiali Elettrici ed Elettronici non possono più essere eliminati come rifiuti municipali: i produttori di detti materiali saranno obbligati a ritirare ogni prodotto alla fine del suo ciclo di vita. MSI si adegnerà a tale Direttiva ritirando tutti i prodotti marchiati MSI che sono stati venduti all'interno dell'Unione Europea alla fine del loro ciclo di vita. È possibile portare i prodotti nel più vicino punto di raccolta

## Contents

|  |            |
|--|------------|
| Copyright Notice .....   | ii         |
| Trademarks .....   | ii         |
| Revision History.....  | ii         |
| Technical Support.....   | ii         |
| Safety Instructions .....  | iii        |
| FCC-B Radio Frequency Interference Statement.....                | iv         |
| WEEE (Waste Electrical and Electronic Equipment) Statement ..... | v          |
| <b>Chapter 1 Getting Started.....</b>                            | <b>1-1</b> |
| Mainboard Specifications .....                                   | 1-2        |
| Mainboard Layout .....   | 1-4        |
| Packing Checklist.....   | 1-5        |
| <b>Chapter 2 Hardware Setup.....</b>                             | <b>2-1</b> |
| Quick Components Guide .....                                     | 2-2        |
| Screw Holes .....  | 2-3        |
| CPU (Central Processing Unit) .....                              | 2-4        |
| Memory .....   | 2-8        |
| Power Supply .....   | 2-11       |
| Back Panel.....  | 2-12       |
| Connectors.....  | 2-14       |
| Jumpers .....  | 2-20       |
| Buttons .....  | 2-21       |
| Slots .....  | 2-22       |
| LED Status Indicators .....                                      | 2-23       |
| <b>Chapter 3 BIOS Setup.....</b>                                 | <b>3-1</b> |
| Entering Setup .....   | 3-2        |
| The Main Menu .....  | 3-4        |
| Standard CMOS Features.....                                      | 3-6        |
| Advanced BIOS Features .....                                     | 3-8        |
| Integrated Peripherals.....                                      | 3-10       |
| Power Management Setup.....                                      | 3-12       |
| H/W Monitor .....  | 3-14       |
| Green Power .....  | 3-15       |
| BIOS Setting Password.....                                       | 3-16       |
| Cell Menu .....  | 3-18       |
| M-Flash .....  | 3-26       |
| Overclocking Profile .....                                       | 3-29       |
| Load Fail-Safe/ Optimized Defaults .....                         | 3-30       |



|   |            |
|---|------------|
| <b>Appendix A Realtek Audio</b> .....       | <b>A-1</b> |
| Installing the Realtek HD Audio Driver..... | A-2        |
| Software Configuration.....                 | A-3        |
| Hardware Default Setting.....               | A-5        |
| <b>Appendix B Intel RAID</b> .....          | <b>B-1</b> |
| Introduction .....                          | B-2        |
| BIOS Configuration .....                    | B-3        |
| Installing Driver .....                     | B-10       |
| Degraded RAID Array .....                   | B-12       |
| <b>Appendix C Marvell RAID</b> .....        | <b>C-1</b> |
| RAID Configuration .....                    | C-2        |



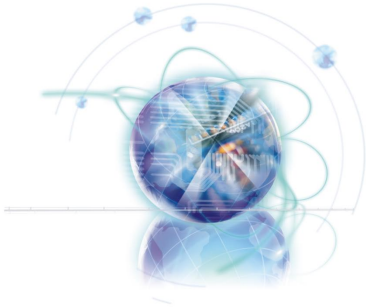

## Chapter 1

# Getting Started

Thank you for choosing the **X58A-GD45** Series (MS-7522 v5.X) ATX mainboard. The **X58A-GD45** Series mainboards are based on **Intel® X58 & ICH10R** chipsets for optimal system efficiency. Designed to fit the advanced **Intel® LGA1366** processor, the **X58A-GD45** Series deliver a high performance and professional desktop platform solution.

## Mainboard Specifications

---

### Processor Support

- Intel® i7 processor in the LGA1366 package  
(For the latest information about CPU, please visit <http://www.msi.com/index.php?func=cpuform2>)

### QPI

- Up to 6.4 GT/s

### Chipset

- North Bridge : Intel® X58 chipset
- South Bridge : Intel® ICH10R chipset

### Memory Support

- 6 DDR3 DIMMs support DDR3 2133\*(OC)/ 1800\*(OC) /1600\*(OC)/ 1333/ 1066 / 800 DRAM (24GB Max)
- Supports Dual-Channel/ Triple-Channel mode  
\*(For more information on compatible components, please visit <http://www.msi.com/index.php?func=testreport>)

### LAN

- Supports LAN 10/100/1000 Fast Ethernet by Realtek® RTL8111E

### IEEE 1394

- 2 IEEE 1394 ports by VIA® VT6308 (pinheader x1, rear panel x1)

### Audio

- Chip integrated by Realtek® ALC892 (True Blu-ray Audio)
- Flexible 8-channel audio with jack sensing
- Compliant with Azalia 1.0 Spec

### SATA

- 7 SATA 3Gb/s ports (SATA1~6) by Intel® ICH10R and (SATA9) by JMicron® JMB362
- 2 SATA 6Gb/s ports (SATA7~8) by Marvell® SE9128
- 1 eSATA ports (back panel) by JMicron® JMB362

### USB 3.0

- 2 USB 3.0 ports by NEC® uPD720200F1

### RAID

- SATA1~6 support Intel® Matrix Storage Technology (AHCI/ RAID 0/1/5/10) by Intel® ICH10R
- SATA7~8 ports support RAID 0/ 1 mode by Marvell® SE9128

## Connectors

- Back panel
  - 1 PS/2 keyboard port
  - 1 PS/2 mouse port
  - 1 Clear CMOS button
  - 1 Optical S/PDIF-Out
  - 1 Coaxial S/PDIF-Out
  - 1 1394 port
  - 8 USB 2.0 ports
  - 1 eSATA port
  - 1 LAN port
  - 6 flexible audio jacks
- On-Board
  - 2 USB 2.0 connectors
  - 1 USB 3.0 connector
  - 1 1394 connector
  - 1 Chassis Intrusion connector
  - 1 TPM Module connector
  - 1 Serial connector
  - 1 CD-In connector
  - 1 S/PDIF-Out connector
  - 1 Front panel audio connector
  - 1 Reset button
  - 1 Power button

## Slots

- 2 PCIe 2.0 x16 slots (PCI\_E2, PCI\_E5)
- 1 PCIe 1.0 x16 slot (PCI\_E6), supports up to PCIe4 speed.
  - When you install expansion cards into the PCIe1 slots (PCI\_E1, PCI\_E3 or PCI\_E4), the PCI\_E6 lanes will auto arrange from x4 to x1.
- 3 PCIe 2.0 x1 slots
- 1 PCI slot

## Form Factor

- ATX (24.4cm X 30.5 cm)

## Mounting

- 9 mounting holes

\* If you need to purchase accessories and request the part numbers, you could search the product web page and find details on our web address below

<http://www.msi.com/index.php>

# Mainboard Layout

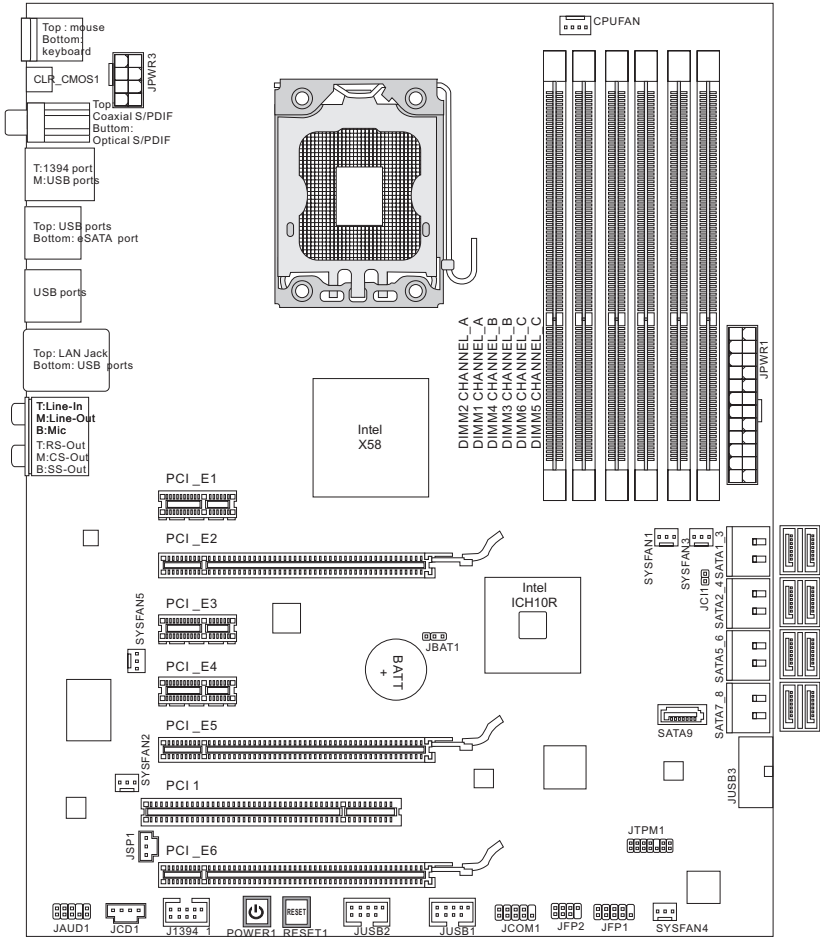

**X58A-GD45 Series (MS-7522 v5.X) Mainboard**

## Packing Checklist



MSI mainboard



MSI Driver/Utility DVD



SATA Cable (Optional)



Power Cable



USB 3.0 Bracket  
(Optional)



User's Guide



Back IO Shield

\* The pictures are for reference only and may vary from the packing contents of the product you purchased.





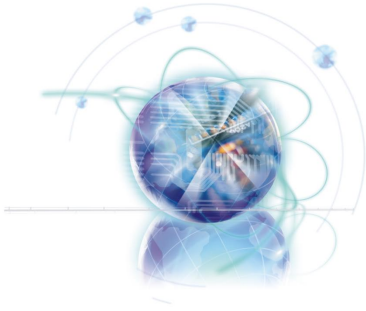

## Chapter 2

# Hardware Setup

This chapter provides you with the information about hardware setup procedures. While doing the installation, be careful in holding the components and follow the installation procedures. For some components, if you install in the wrong orientation, the components will not work properly.

Use a grounded wrist strap before handling computer components. Static electricity may damage the components.

# Quick Components Guide

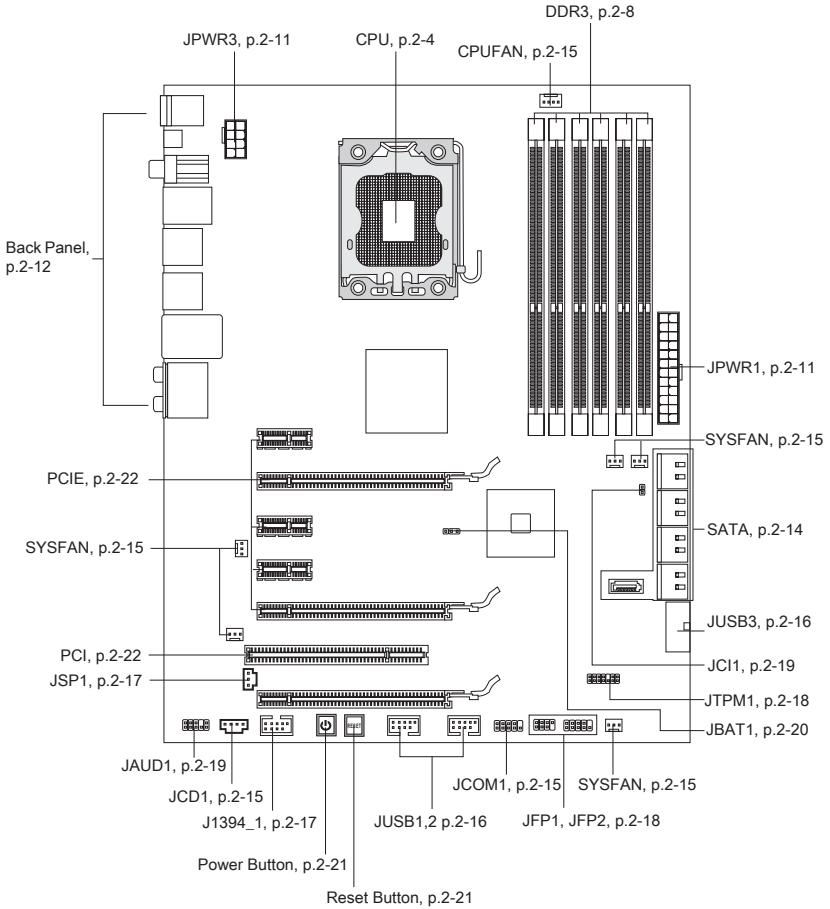

## Screw Holes

When you install the mainboard, you have to place the mainboard into the chassis in the correct direction. The locations of screws holes on the mainboard are shown as below.

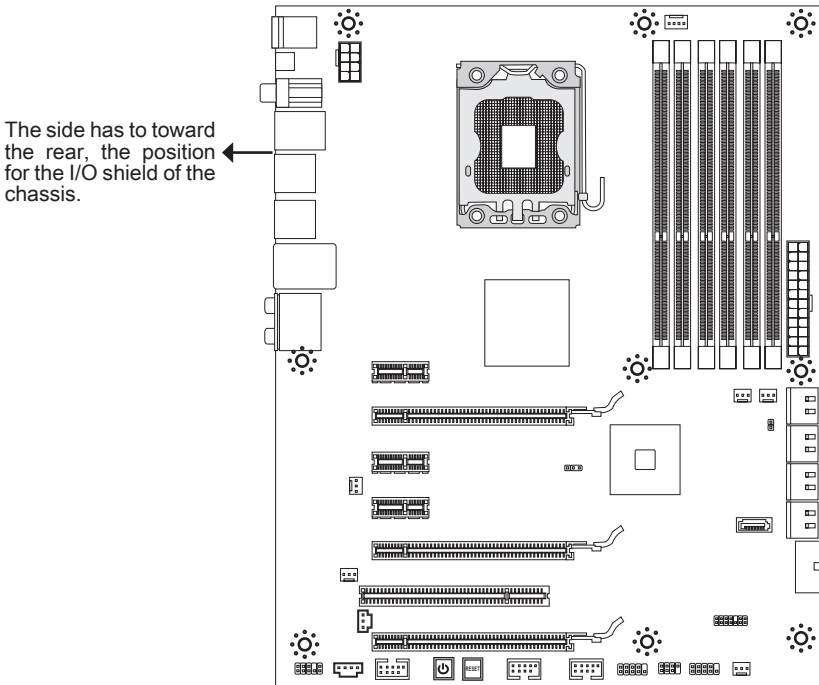

Refer above picture to install standoffs in the appropriate locations on chassis and then screw through the mainboard screw holes into the standoffs.

### **Important**

- To prevent damage to the mainboard, any contact between the mainboard circuit and chassis or unnecessary standoffs mounted on the chassis is prohibited.
- Please make sure there is no metal components placed on the mainboard or within the chassis that may cause short circuit of the mainboard.

## CPU (Central Processing Unit)

When you are installing the CPU, make sure to install the cooler to prevent overheating. If you do not have the CPU cooler, consult your dealer before turning on the computer. For the latest information about CPU, please visit <http://www.msi.com/index.php?func=cpuform2>

### **Important**

#### **Overheating**

*Overheating will seriously damage the CPU and system. Always make sure the cooling fan can work properly to protect the CPU from overheating. Make sure that you apply an even layer of thermal paste (or thermal tape) between the CPU and the heatsink to enhance heat dissipation.*

#### **Replacing the CPU**

*While replacing the CPU, always turn off the ATX power supply or unplug the power supply's power cord from the grounded outlet first to ensure the safety of CPU.*

#### **Overclocking**

*This mainboard is designed to support overclocking. However, please make sure your components are able to tolerate such abnormal setting, while doing overclocking. Any attempt to operate beyond product specifications is not recommended. We do not guarantee the damages or risks caused by inadequate operation or beyond product specifications.*

### Introduction to LGA 1366 CPU

The pin-pad side of LGA 1366 CPU.

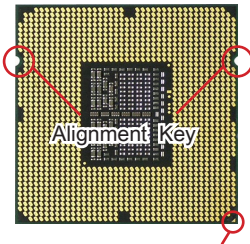

Yellow triangle is the Pin 1 indicator

The surface of LGA 1366 CPU. Remember to apply some thermal paste on it for better heat dispersion.

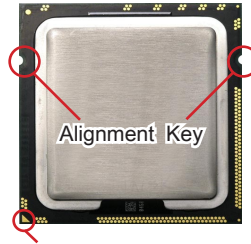

Yellow triangle is the Pin 1 indicator

## CPU & Cooler Installation

When you are installing the CPU, make sure the CPU has a cooler attached on the top to prevent overheating. Meanwhile, do not forget to apply some thermal paste on CPU before installing the heat sink/cooler fan for better heat dispersion.

Follow the steps below to install the CPU & cooler correctly. Wrong installation will cause the damage of your CPU & mainboard.

1. Open the load level.
2. Lift the load lever up and open the load plate.

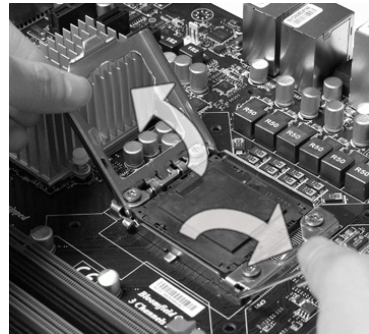
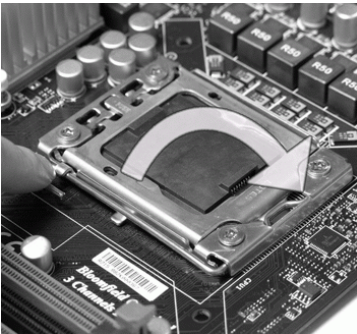

3. The CPU socket has a plastic cap on it to protect the contact from damage. Before you install CPU, always cover it to protect the socket pin. Remove the cap (as the arrow shows).
4. After confirming the CPU direction for correct mating, put down the CPU in the socket housing frame. Be sure to grasp on the edge of the CPU base. Note that the alignment keys are matched.

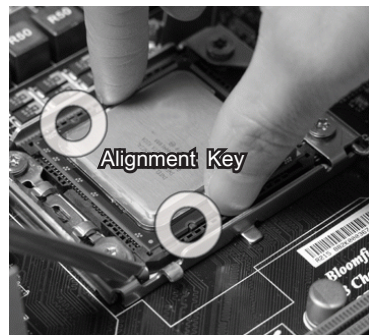
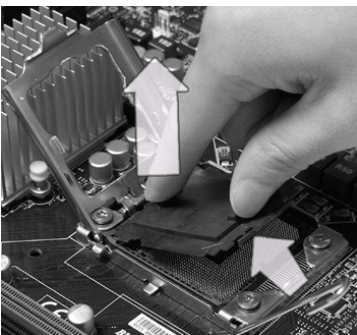

## Hardware Setup

5. Visually inspect if the CPU is seated well into the socket. If not, take out the CPU with pure vertical motion and reinstall.

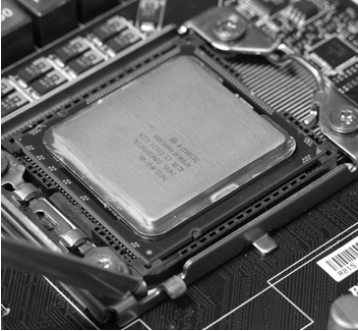

6. Cover the load plate onto the package.

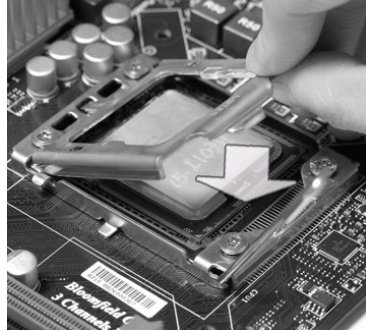

7. Press down the load lever lightly onto the load plate, and then secure the lever with the hook under retention tab.

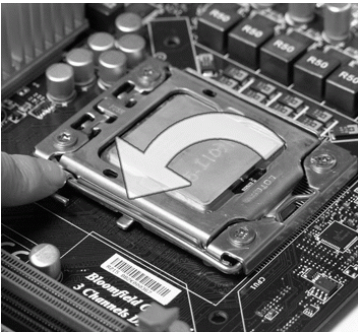

8. Align the holes on the mainboard with the heatsink. Push down the cooler until its four clips get wedged into the holes of the mainboard.

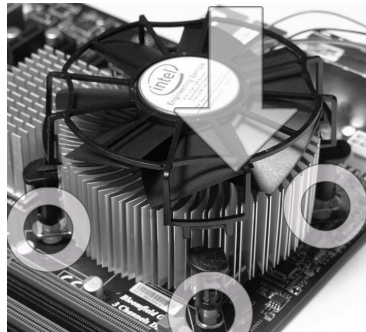

### **Important**

- Confirm if your CPU cooler is firmly installed before turning on your system.
- Do not touch the CPU socket pins to avoid damaging.

9. Press the four hooks down to fasten the cooler.

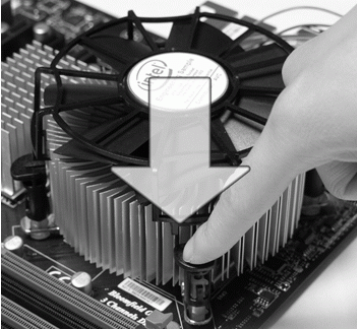

10. Turn over the mainboard to confirm that the clip-ends are correctly inserted.

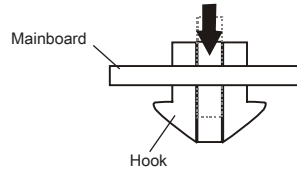

11. Finally, attach the CPU Fan cable to the CPU fan connector on the mainboard.

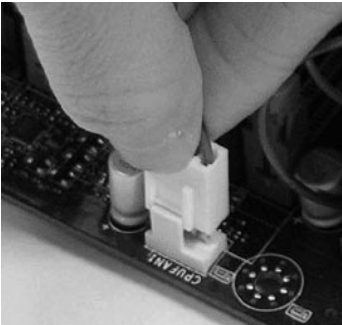

### **Important**

- Read the CPU status in BIOS.
- Whenever CPU is not installed, always protect your CPU socket pin with the plastic cap covered (shown in Figure 1) to avoid damaging.
- Mainboard photos shown in this section are for demonstration of the CPU/ cooler installation only. The appearance of your mainboard may vary depending on the model you purchase.
- Please refer to the documentation in the CPU fan package for more details about the CPU fan installation.

# Memory

These DIMM slots are used for installing memory modules. For more information on compatible components, please visit <http://www.msi.com/index.php?func=testreport>

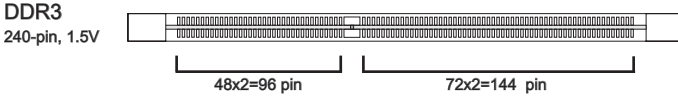

## Memory Population Rule

Please refer to the following illustrations for memory population rules.

### Single-Channel mode Population Rule

When you have only **one** memory module, please always insert it into the DIMM\_1 first.

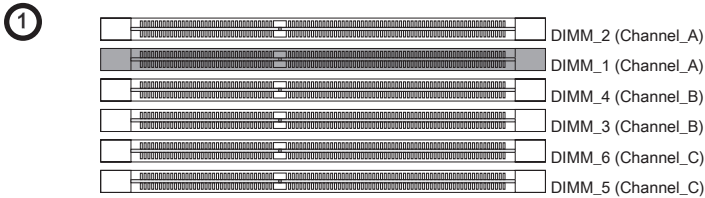

### Dual-Channel mode Population Rule

In Dual-Channel mode, the memory modules can transmit and receive data with two data bus lines simultaneously. Enabling Dual-Channel mode can enhance the system performance. When you have **two** memory modules, please always insert them as the figures shown in below.

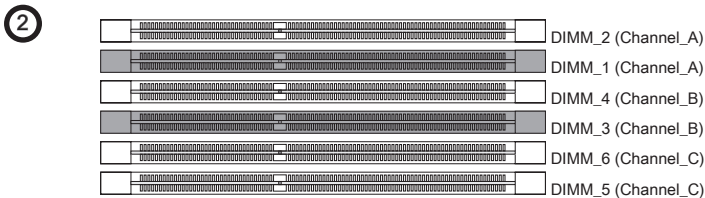



### Triple-Channel mode Population Rule

In Triple-Channel mode, the memory modules can transmit and receive data with three data bus lines simultaneously. Enabling Triple-Channel mode can enhance the best system performance. When you have **three or more** memory modules, please always insert them as the figures shown in below.

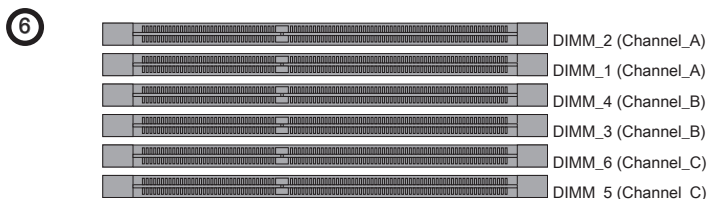
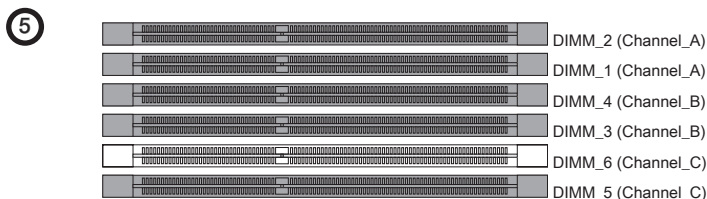
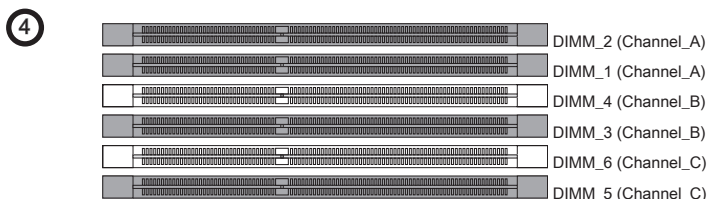
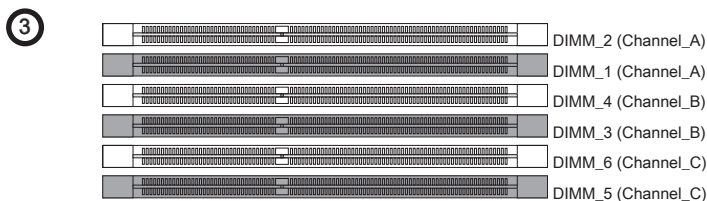

### **Important**

- *DDR3 memory modules are not interchangeable with DDR2 and the DDR3 standard is not backwards compatible. You should always install DDR3 memory modules in the DDR3 DIMM slots.*
- *In Triple-Channel/ Dual-Channel mode, make sure that you install memory modules of the same type and density in different channel DIMM slots.*

- To enable successful system boot-up, always insert the memory modules into the DIMM\_1 first.
- Due to the chipset resource deployment, the system density will only be detected up to 23+GB (not full 24GB) when each DIMM is installed with a 4GB memory module.

### Installing Memory Modules

1. The memory module has only one notch on the center and will only fit in the right orientation.
2. Insert the memory module vertically into the DIMM slot. Then push it in until the golden finger on the memory module is deeply inserted in the DIMM slot. The plastic clip at each side of the DIMM slot will automatically close when the memory module is properly seated.
3. Manually check if the memory module has been locked in place by the DIMM slot clips at the sides.

#### **Important**

*You can barely see the golden finger if the memory module is properly inserted in the DIMM slot.*

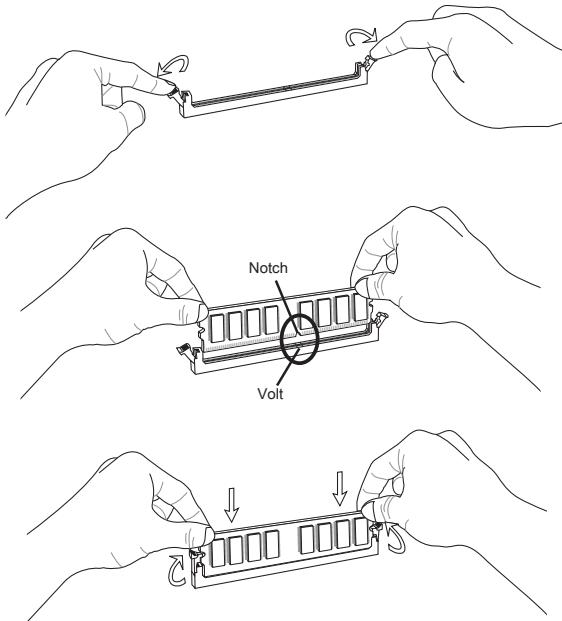

#### **Important**

*You can barely see the golden finger if the memory module is properly inserted in the DIMM slot.*

## Power Supply

### ATX 24-pin Power Connector: JPWR1

This connector allows you to connect an ATX 24-pin power supply. To connect the ATX 24-pin power supply, make sure the plug of the power supply is inserted in the proper orientation and the pins are aligned. Then push down the power supply firmly into the connector.

You may use the 20-pin ATX power supply as you like. If you'd like to use the 20-pin ATX power supply, please plug your power supply along with pin 1 & pin 13.

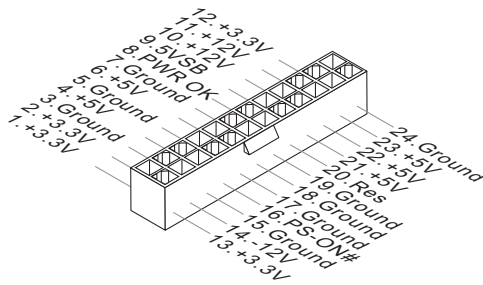

### ATX 8-pin Power Connector: JPWR3

These connectors provide 12V power output to the CPUs.

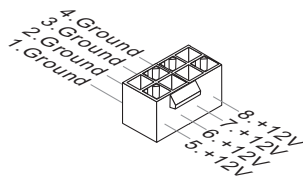

## Back Panel

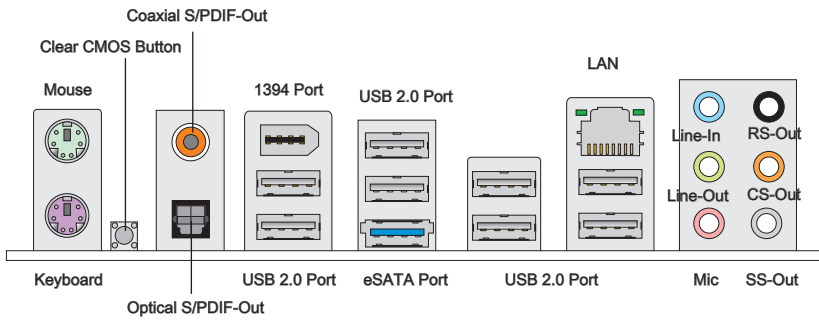

### ▶ Mouse/Keyboard

The standard PS/2<sup>®</sup> mouse/keyboard DIN connector is for a PS/2<sup>®</sup> mouse/keyboard.

### ▶ Clear CMOS Button

There is a CMOS RAM on board that has a power supply from external battery to keep the system configuration data. With the CMOS RAM, the system can automatically boot OS every time it is turned on. If you want to clear the system configuration, use the button to clear data. Press the button to clear the data.

### **Important**

*Make sure that you power off the system before clearing CMOS data.*

*After pressing this button to clear CMOS data in power off (G3) state, the system will boot automatically.*

### ▶ Coaxial S/PDIF-Out

This SPDIF (Sony & Philips Digital Interconnect Format) connector is provided for digital audio transmission to external speakers through a coaxial cable.

### ▶ Optical S/PDIF-Out

This SPDIF (Sony & Philips Digital Interconnect Format) connector is provided for digital audio transmission to external speakers through an optical fiber cable.

### ▶ IEEE 1394 Port

The IEEE 1394 port on the back panel provides connection to IEEE 1394 devices.

### ▶ USB 2.0 Port

The USB (Universal Serial Bus) port is for attaching USB devices such as keyboard, mouse, or other USB-compatible devices. Supports data transfer rate up to 480Mbit/s (Hi-Speed).

### ► eSATA Port

The eSATA (External SATA) port is for attaching the eSATA hard drive.

### ► LAN

The standard RJ-45 LAN jack is for connection to the Local Area Network (LAN). You can connect a network cable to it.

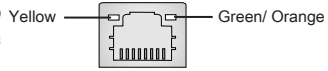

| LED   | Color  | LED State              | Condition   |
|-------|--------|------------------------|---|
| Left  | Yellow | Off                    | LAN link is not established.                                    |
|       |        | On(Steady state)       | LAN link is established.  |
|       |        | On(brighter & pulsing) | The computer is communicating with another computer on the LAN. |
| Right | Green  | Off                    | 10 Mbit/sec data rate is selected.                              |
|       |        | On                     | 100 Mbit/sec data rate is selected.                             |
|       | Orange | On                     | 1000 Mbit/sec data rate is selected.                            |

### ► Audio Ports

These audio connectors are used for audio devices. It is easy to differentiate between audio effects according to the color of audio jacks.

- Line-In (Blue) - Line In, is used for external CD player, tape-player or other audio devices.
- Line-Out (Green) - Line Out, is a connector for speakers or headphones.
- Mic (Pink) - Mic, is a connector for microphones.
- RS-Out (Black) - Rear-Surround Out in 4/ 5.1/ 7.1 channel mode.
- CS-Out (Orange) - Center/ Subwoofer Out in 5.1/ 7.1 channel mode.
- SS-Out (Gray) - Side-Surround Out 7.1 channel mode.

## Connectors

### Serial ATA Connector: SATA1~9

This connector is a high-speed Serial ATA interface port. Each connector can connect to one Serial ATA device.

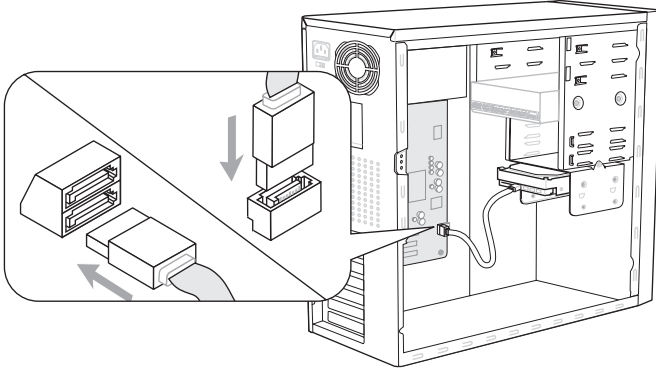

\* The MB layout in this figure is for reference only.

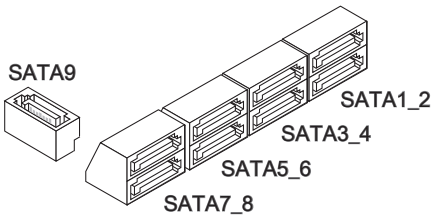

SATA1~6 (3Gb/s)  
supported by Intel® ICH10R

SATA7/ SATA8 (6Gb/s)  
supported by Marvell® SE9128

SATA9 (3Gb/s)  
supported by JMicron® JMB362

### **Important**

Please do not fold the Serial ATA cable into 90-degree angle. Otherwise, data loss may occur during transmission.

## Fan Power Connectors: CPUFAN, SYSFAN1~5

The fan power connectors support system cooling fan with +12V. When connecting the wire to the connectors, always note that the red wire is the positive and should be connected to the +12V; the black wire is Ground and should be connected to GND. If the mainboard has a System Hardware Monitor chipset on-board, you must use a specially designed fan with speed sensor to take advantage of the CPU fan control.

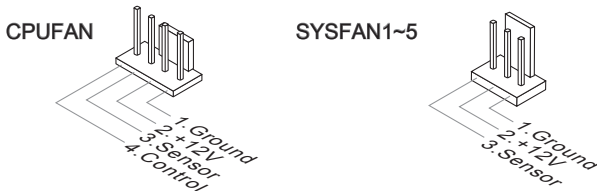

### **Important**

- Please refer to the recommended CPU fans at processor's official website or consult the vendors for proper CPU cooling fan.
- CPUFAN support Smart fan control. You can install **Control Center** utility that will automatically control the CPUFAN speeds according to the actual CPUFAN temperatures.

## CD-In Connector: JCD1

This connector is provided for external audio input.

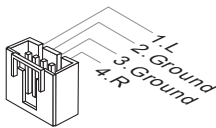

## Serial Port Connector: JCOM1

This connector is a 16550A high speed communication port that sends/receives 16 bytes FIFOs. You can attach a serial device.

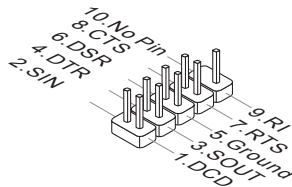

### Front USB Connector: JUSB1, JUSB2

This connector, compliant with Intel® I/O Connectivity Design Guide, is ideal for connecting high-speed USB interface peripherals such as USB HDD, digital cameras, MP3 players, printers, modems and the like.

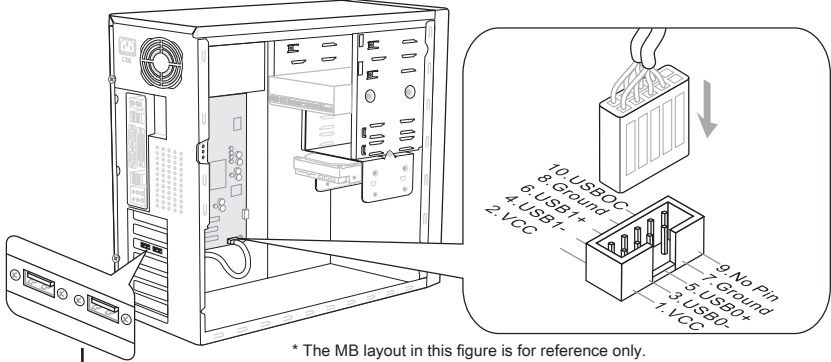

\* The MB layout in this figure is for reference only.

USB 2.0 Bracket (optional)

### Front USB Connector: JUSB3

USB 3.0 port is backward-compatible with USB 2.0 devices. Supports data transfer rate up to 5 Gbit/s (SuperSpeed).

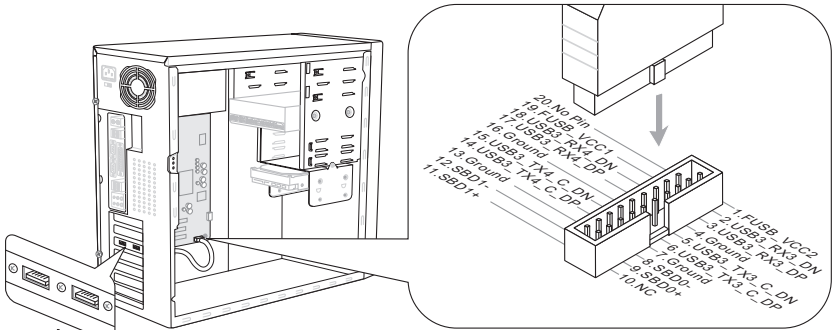

\* The MB layout in this figure is for reference only.

USB 3.0 Bracket (optional)

### **Important**

- Note that the pins of VCC and GND must be connected correctly to avoid possible damage.
- If you want to use a USB 3.0 device, you must use the USB 3.0 cable to connect to the USB 3.0 port.



### IEEE1394 Connector: J1394\_1

This connector allows you to connect the IEEE1394 device via an optional IEEE1394 bracket.

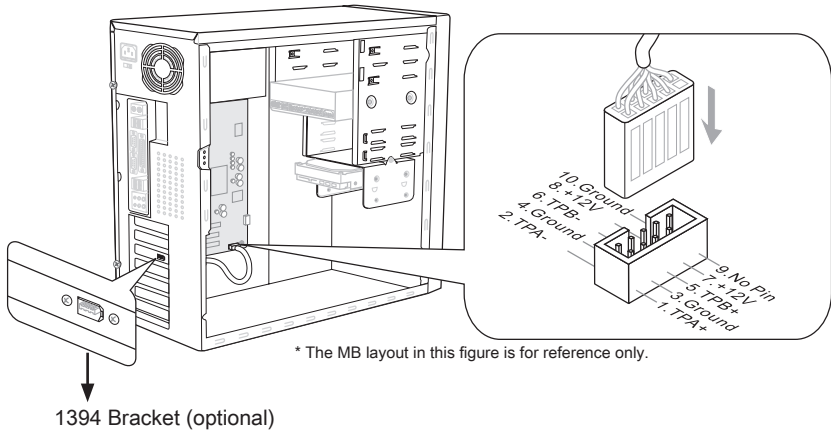

### S/PDIF-Out Connector: JSP1

This connector is used to connect S/PDIF (Sony & Philips Digital Interconnect Format) interface for digital audio transmission.

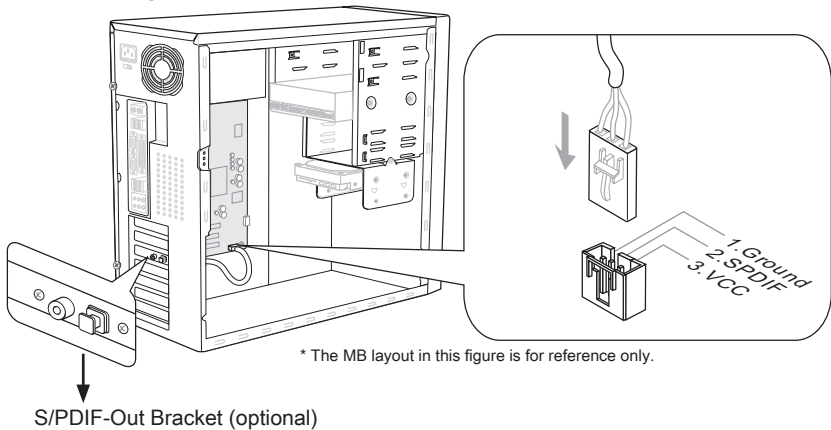

### Front Panel Connectors: JFP1, JFP2

These connectors are for electrical connection to the front panel switches and LEDs. The JFP1 is compliant with Intel® Front Panel I/O Connectivity Design Guide.

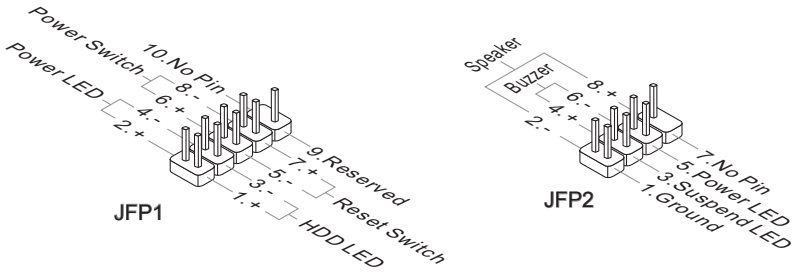

### TPM Module connector: JTPM1

This connector connects to a TPM (Trusted Platform Module) module (optional). Please refer to the TPM security platform manual for more details and usages.

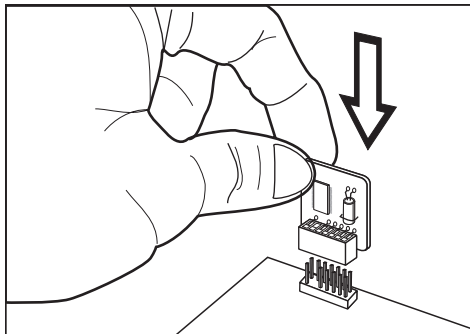
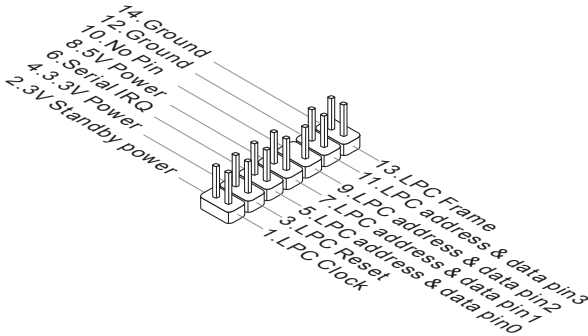

## Front Panel Audio Connector: JAUD1

This connector allows you to connect the front panel audio and is compliant with Intel® Front Panel I/O Connectivity Design Guide.

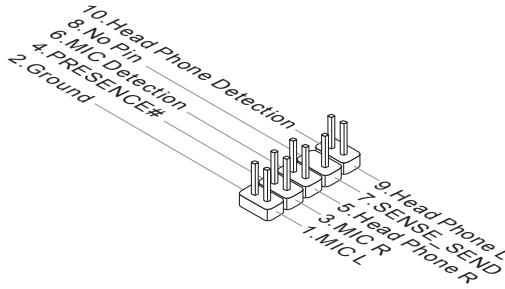

## Chassis Intrusion Connector: JCI1

This connector connects to the chassis intrusion switch cable. If the chassis is opened, the chassis intrusion mechanism will be activated. The system will record this status and show a warning message on the screen. To clear the warning, you must enter the BIOS utility and clear the record.

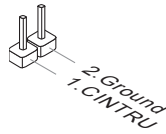

## Jumpers

---

### Clear CMOS Jumper: JBAT1

There is a CMOS RAM on board with an external battery power supply to preserve the system configuration data. With the CMOS RAM, the system can automatically boot OS every time it is turned on. If you want to clear the system configuration, set the jumper to clear data.



JBAT1



Keep Data



Clear Data

### **Important**

*You can clear CMOS by shorting 2-3 pin while the system is off. Then return to 1-2 pin position. Avoid clearing the CMOS while the system is on; it will damage the mainboard.*

## Buttons

---

The mainboard provides the following buttons for you to set the computer's function. This section will explain how to change your mainboard's function through the use of button.

### Power Button

This button is used to turn-on or turn-off the system. Press the button to turn-on or turn-off the system.



---

### Reset Button

This button is used to reset the system. Press the button to reset the system.

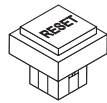

## Slots

---

### PCIE (Peripheral Component Interconnect Express) Slot

The PCIE slot supports the PCIE interface expansion card.

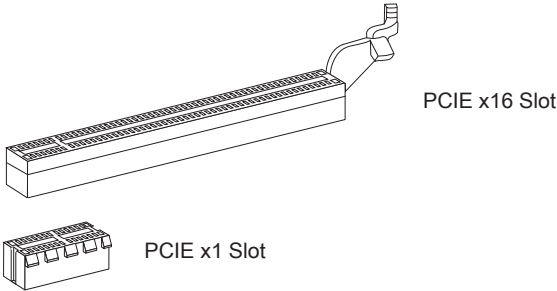

---

### PCI (Peripheral Component Interconnect) Slot

The PCI slot supports LAN card, SCSI card, USB card, and other add-on cards that comply with PCI specifications.

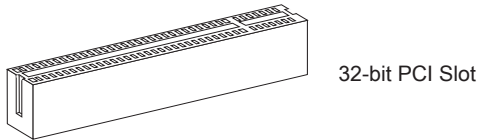

### **Important**

*When adding or removing expansion cards, make sure that you unplug the power supply first. Meanwhile, read the documentation for the expansion card to configure any necessary hardware or software settings for the expansion card, such as jumpers, switches or BIOS configuration.*

---

### PCI Interrupt Request Routing

The IRQ, acronym of interrupt request line and pronounced I-R-Q, are hardware lines over which devices can send interrupt signals to the microprocessor. The PCI IRQ pins are typically connected to the PCI bus pins as follows:

|           | Order1 | Order2 | Order3 | Order4 |
|-----------|--------|--------|--------|--------|
| PCI Slot1 | INT E# | INT F# | INT G# | INT H# |

## LED Status Indicators

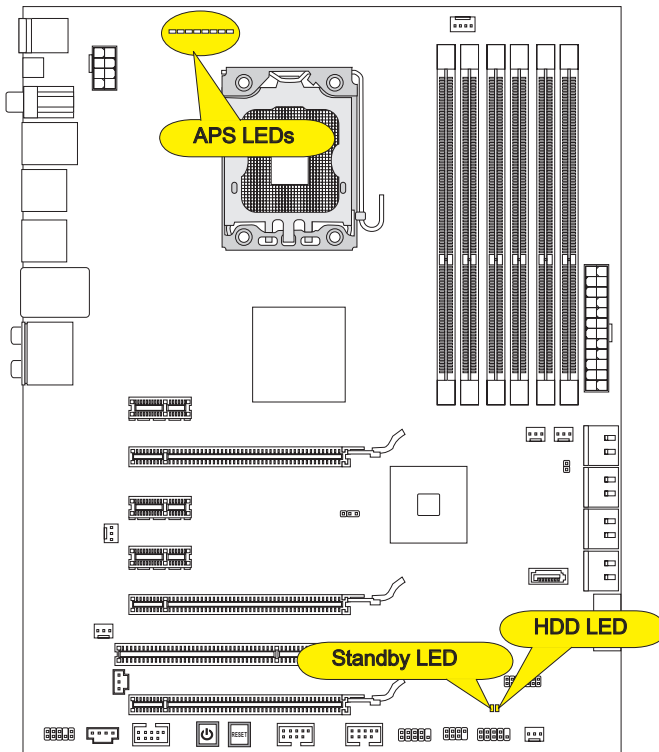

### APS LEDs

These APS (Active Phase Switching) LEDs indicate the current CPU power phase mode. Follow the instructions below to read.

■ : Lights      □ : Off

- CPU is in 1 phase power mode.
- CPU is in 2 phase power mode.
- CPU is in 3 phase power mode.
- CPU is in 4 phase power mode.
- CPU is in 5 phase power mode.
- CPU is in 6 phase power mode.
- CPU is in 7 phase power mode.
- CPU is in 8 phase power mode.

### **HDD LED**

Lights red when the hard drive is operating.

---

### **Standby LED**

Lights orange when the system is in standby (S4/S5 ) status.



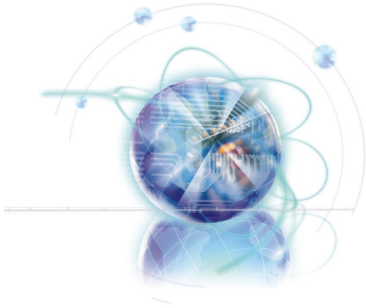

## Chapter 3

# BIOS Setup

This chapter provides information on the BIOS Setup program and allows you to configure the system for optimum use.

You may need to run the Setup program when:

- An error message appears on the screen during the system booting up, and requests you to run SETUP.
- You want to change the default settings for customized features.

## Entering Setup

---

Power on the computer and the system will start POST (Power On Self Test) process. When the message below appears on the screen, press <DEL> key to enter Setup.

### Press DEL to enter SETUP

If the message disappears before you respond and you still wish to enter Setup, restart the system by turning it OFF and On or pressing the RESET button. You may also restart the system by simultaneously pressing <Ctrl>, <Alt>, and <Delete> keys.

### **Important**

- *The items under each BIOS category described in this chapter are under continuous update for better system performance. Therefore, the description may be slightly different from the latest BIOS and should be held for reference only.*
- *Upon boot-up, the 1st line appearing after the memory count is the BIOS version. It is usually in the format:*

*A7522IMS V5.2 100610 where:*

*1st digit refers to BIOS maker as A = AMI, W = AWARD, and P = PHOENIX.*

*2nd - 5th digit refers to the model number.*

*6th digit refers to the chipset as I = Intel, N = NVIDIA, A = AMD and V = VIA.*

*7th - 8th digit refers to the customer as MS = all standard customers.*

*V5.2 refers to the BIOS version.*

*100610 refers to the date this BIOS was released.*

## Control Keys

|         |   |
|---------|---|
| <↑>     | Move to the previous item   |
| <↓>     | Move to the next item   |
| <←>     | Move to the item in the left hand                                 |
| <→>     | Move to the item in the right hand                                |
| <Enter> | Select the item   |
| <Esc>   | Jumps to the Exit menu or returns to the main menu from a submenu |
| <+ /PU> | Increase the numeric value or make changes                        |
| <- /PD> | Decrease the numeric value or make changes                        |
| <F1>    | General Help  |
| <F4>    | Enter the CPU Spec. menu, and read the CPU information            |
| <F5>    | Enter the Memory-Z menu, and read the memory information          |
| <F6>    | Load Optimized Defaults   |
| <F8>    | Load Fail-Safe Defaults   |
| <F10>   | Save all the CMOS changes and exit                                |

## Getting Help

After entering the Setup menu, the first menu you will see is the Main Menu.

### Main Menu

The main menu lists the setup functions you can make changes to. You can use the arrow keys ( ↑ ↓ ) to select the item. The on-line description of the highlighted setup function is displayed at the bottom of the screen.

### Sub-Menu

If you find a right pointer symbol (as shown in the right view) appears to the left of certain fields that means a sub-menu can be launched from this field. A sub-menu contains additional options for a field parameter. You can use arrow keys ( ↑ ↓ ) to highlight



▶ SATA1  
▶ SATA2  
▶ SATA3  
▶ SATA4

the field and press <Enter> to call up the sub-menu. Then you can use the control keys to enter values and move from field to field within a sub-menu. If you want to return to the main menu, just press the <Esc>.

### General Help <F1>

The BIOS setup program provides a General Help screen. You can call up this screen from any menu by simply pressing <F1>. The Help screen lists the appropriate keys to use and the possible selections for the highlighted item. Press <Esc> to exit the Help screen.

## The Main Menu

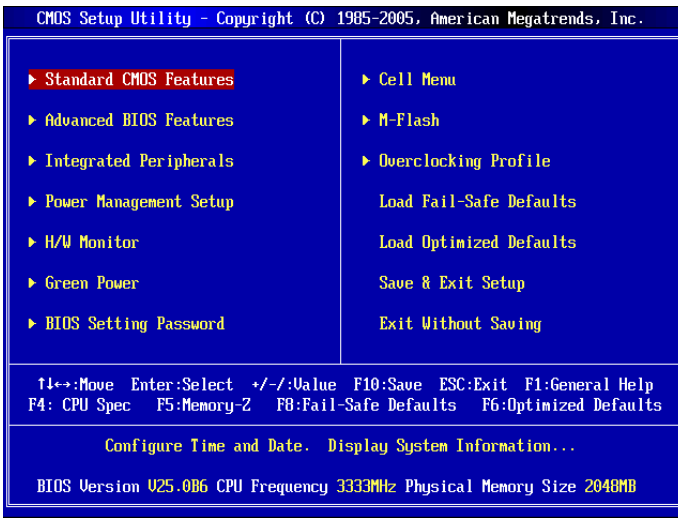

▶ **Standard CMOS Features**

Use this menu for basic system configurations, such as time, date etc.

▶ **Advanced BIOS Features**

Use this menu to setup the items of the BIOS special enhanced features.

▶ **Integrated Peripherals**

Use this menu to specify your settings for integrated peripherals.

▶ **Power Management Setup**

Use this menu to specify your settings for power management.

▶ **H/W Monitor**

This entry shows your PC health status.

▶ **Green Power**

Use this menu to specify the power phase.

▶ **BIOS Setting Password**

Use this menu to set the password for BIOS.

▶ **Cell Menu**

Use this menu to specify your settings for frequency/voltage control and overclocking.

**► M-Flash**

Use this menu to read/ flash the BIOS from storage drive (FAT/ FAT32 format only).

**► Overclocking Profile**

Use this menu to save/ load your settings to/ from CMOS for BIOS.

**► Load Fail-Safe Defaults**

Use this menu to load the default values set by the BIOS vendor for stable system performance.

**► Load Optimized Defaults**

Use this menu to load the default values set by the mainboard manufacturer specifically for optimal performance of the mainboard.

**► Save & Exit Setup**

Save changes to CMOS and exit setup.

**► Exit Without Saving**

Abandon all changes and exit setup.

## Standard CMOS Features

The items in Standard CMOS Features Menu include some basic setup items. Use the arrow keys to highlight the item and then use the <PgUp> or <PgDn> keys to select the value you want in each item.

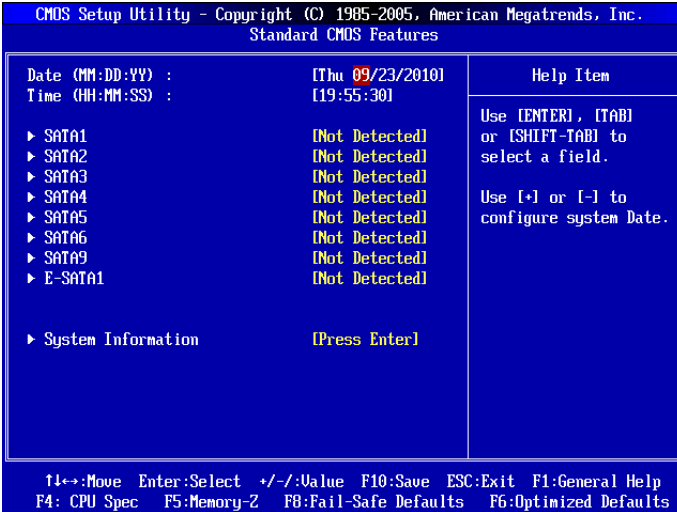

### ► Date (MM:DD:YY)

This allows you to set the system to the date that you want (usually the current date). The format is <day><month> <date> <year>.

- [day] Day of the week, from Sun to Sat, determined by BIOS. Read-only.
- [month] The month from Jan. through Dec.
- [date] The date from 1 to 31 can be keyed by numeric function keys.
- [year] The year can be adjusted by users.

### ► Time (HH:MM:SS)

This allows you to set the system time that you want (usually the current time). The time format is <hour> <minute> <second>.

► **SATA1~6/ SATA9/ E-SATA1**

Press <Enter> to enter the sub-menu and the following screen appears:

| CMOS Setup Utility - Copyright (C) 1985-2005, American Megatrends, Inc. |           |
|---|-----------|
| SATA1   |           |
| SATA1   | Help Item |
| Device :Hard Disk   |           |
| Vendor :WDC WD2000JS-19NCB1   |           |
| Size :200.0GB   |           |

► **Device / Vendor / Size**

It will show the device information that you connected to the SATA connector.

**Important**

*SATA1~6, SATA9 & E-SATA1 are appearing when you connect the HD devices to the SATA connectors on the mainboard.*

*Standard CMOS Features Menu does not display SATA 7 and SATA 8 items, which are supported by the external controller chip. For how to setup HDDs with the external controller, please refer to Appendix.*

► **System Information**

Press <Enter> to enter the sub-menu, and the following screen appears.

| CMOS Setup Utility - Copyright (C) 1985-2005, American Megatrends, Inc. |           |
|---|-----------|
| System Information  |           |
|   | Help Item |
| Intel(R) Core(TM) i7 CPU X 980 @ 3.33GHz                                |           |
| CPUID/MicroCode 206C2/05  |           |
| CPU Frequency 3.32GHz (133x25)  |           |
| BIOS Version U25.0B6 092410   |           |
| Physical Memory 2048MB  |           |
| Cache Size 1536 KB  |           |
| L3 Cache Size 12288 KB  |           |

This sub-menu shows the CPU information, BIOS version and memory status of your system (read only).

## Advanced BIOS Features

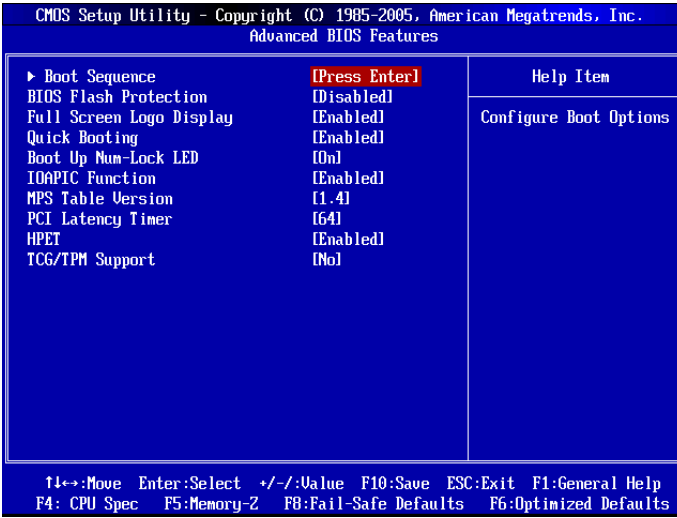

### ► Boot Sequence

Press <Enter> to enter the sub-menu.

#### ► 1st/ 2nd/ 3rd/ — Boot Device

These items allow you to set the first/ second/ third boot device where BIOS attempts to load the disk operating system.

#### ► Boot From Other Device

Setting the option to [Yes] allows the system to try to boot from other device, if the system fails to boot from 1st boot device.

### ► BIOS Flash Protection

This function protects the BIOS from accidental corruption by unauthorized users or computer viruses. When enabled, the BIOS' data cannot be changed when attempting to update the BIOS with a Flash utility. To successfully update the BIOS, you will need to disable this Flash BIOS Protection function. You should enable this function at all times. The only time when you need to disable it is when you want to update the BIOS. After updating the BIOS, you should immediately re-enable it to protect it against viruses.

### ► Full Screen Logo Display

This item enables this system to show the company logo on the boot-up screen. Settings are:

- [Enabled]      Shows a still image (logo) on the full screen at boot.
- [Disabled]     Shows the POST messages at boot.



**▶ Quick Booting**

Setting the item to [Enabled] allows the system to boot within 10 seconds since it will skip some check items.

**▶ Boot Up Num-Lock LED**

This setting is to set the Num Lock status when the system is powered on. Setting to [On] will turn on the Num Lock key when the system is powered on. Setting to [Off] will allow users to use the arrow keys on the numeric keypad.

**▶ IOAPIC Function**

This field is used to enable or disable the APIC (Advanced Programmable Interrupt Controller). Due to compliance with PC2001 design guide, the system is able to run in APIC mode. Enabling APIC mode will expand available IRQ resources for the system.

**▶ MPS Table Version**

This field allows you to select which MPS (Multi-Processor Specification) version to be used for the operating system. You need to select the MPS version supported by your operating system. To find out which version to use, consult the vendor of your operating system.

**▶ PCI Latency Timer**

This item controls how long each PCI device can hold the bus before another takes over. When set to higher values, every PCI device can conduct transactions for a longer time and thus improve the effective PCI bandwidth. For better PCI performance, you should set the item to higher values.

**▶ HPET**

The HPET (High Precision Event Timers) is a component that is part of the chipset. You can enable it, and will provide you with the means to get to it via the various ACPI methods.

**▶ TCG/TPM SUPPORT**

After installing the Trusted Platform Module, this field becomes available. Setting the option to [Yes] enables TPM (Trusted Platform Module) for the system.

## Integrated Peripherals

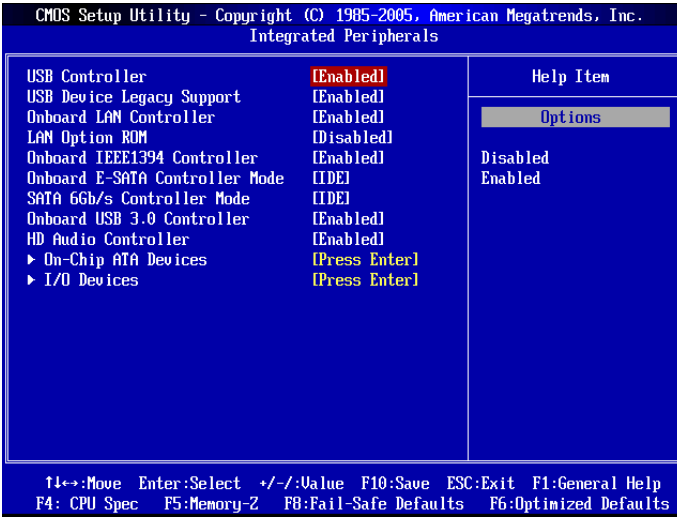

▶ **USB Controller**

This setting allows you to enable/disable the onboard USB controller.

▶ **USB Device Legacy Support**

Select [Enabled] if you need to use a USB-interfaced device in the operating system.

▶ **Onboard LAN Controller**

This setting allows you to enable/disable the onboard LAN controller.

▶ **LAN Option ROM**

This item is used to decide whether to invoke the Boot ROM of the onboard LAN.

▶ **Onboard IEEE1394 Controller**

This setting allows you to enable/disable the onboard IEEE1394 controller.

▶ **Onboard E-SATA Controller**

This item is used to select mode for E-SATA connectors.

▶ **SATA 6Gb/s Controller Mode**

This item is used to select mode for SATA 6Gb/s devices. When you set "Disabled" in this field, the 6Gb/s controller will be disabled.

▶ **Onboard USB 3.0 Controller**

This setting is used to enable/disable the onboard USB 3.0 controller.

▶ **HD Audio Controller**

This setting is used to enable/disable the onboard audio controller.

### ► On-Chip ATA Devices

Press <Enter> to enter the sub-menu and the following screen appears:

| CMOS Setup Utility - Copyright (C) 1985-2005, American Megatrends, Inc. |               |                                 |
|---|---------------|---------------------------------|
| On-Chip ATA Devices   |               |                                 |
| PCI IDE BusMaster   | [Enabled]     | Help Item                       |
| On-Chip SATA Controller   | [Enabled]     |                                 |
| RAID Mode   | [AHCI]        | Section for AHCI Configuration. |
| ► AHCI Configuration  | [Press Enter] |                                 |

#### ► PCI IDE BusMaster

This item allows you to enable/ disable BIOS to used PCI busmastering for reading/ writing to IDE drives.

#### ► On-Chip SATA Controller

This item allows users to enable or disable the on-chip SATA controller.

#### ► RAID Mode

This item is used to select mode for on-chip SATA connectors.

#### ► AHCI Configuration

When the “RAID Mode” sets to [AHCI], this field is available. Press <Enter> to enter the sub-menu and the following screen appears:

| CMOS Setup Utility - Copyright (C) 1985-2005, American Megatrends, Inc. |                |  |
|---|----------------|--|
| AHCI Configuration  |                |  |
| ► SATA1   | [Not Detected] | Help Item<br>While entering setup, BIOS auto detects the presence of IDE devices. This displays the status of auto |
| ► SATA2   | [Not Detected] |  |
| ► SATA3   | [Not Detected] |  |
| ► SATA4   | [Not Detected] |  |
| ► SATA5   | [Not Detected] |  |
| ► SATA6   | [Not Detected] |  |

#### ► AHCI Port 1/2/3/4/5/6

Press <Enter> to enter the sub-menu.

#### ► AHCI Port 1/2/3/4/5/6

Select the type of device.

### ► I/O Devices

Press <Enter> to enter the sub-menu and the following screen appears:

| CMOS Setup Utility - Copyright (C) 1985-2005, American Megatrends, Inc. |            |           |
|---|------------|-----------|
| I/O Devices   |            |           |
| COM Port 1  | [3F8/IRQ4] | Help Item |

#### ► COM Port 1

Select an address and corresponding interrupt for the serial port.

## Power Management Setup

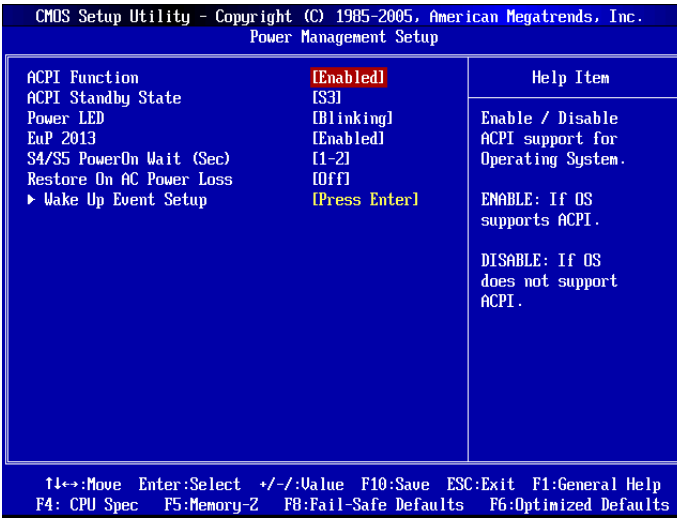

### Important

*S3-related functions described in this section are available only when the BIOS supports S3 sleep mode.*

#### ▶ ACPI Function

This item is to activate the ACPI (Advanced Configuration and Power Management Interface) Function. If your operating system is ACPI-aware, select [Enabled].

#### ▶ ACPI Standby State

This item specifies the power saving modes for ACPI function.

#### ▶ Power LED

This item configures how the system uses power LED to indicate the sleep state. The settings are:

- [Singal]      The power LED remains the same color.
- [Dual]        The power LED changes its color to indicate the sleep state.
- [Blinking]    The power LED blinks to indicate the sleep state.

#### ▶ EuP 2013

This item is designed for Energy Using Products Lot 6 2013 (EuP) aka Energy Related Products (ErP). To reduce Power Consumption when system off or standby mode.

Note: When "Enabled" EuP 2013 setting, system don't support RTC wake up event function.

#### ▶ S4/S5 PowerOn Wait (Sec)

This item allows you to select a waiting period when system wake-up from power state S4/S5.

### ► Restore On AC Power Loss

This item specifies whether your system will reboot after a power failure or interrupt occurs. Settings are:

- [Off] Always leaves the computer in the power off state.
- [On] Always leaves the computer in the power on state.
- [Last State] Restore the system to the status before power failure or interrupt occurred.

### ► Wake Up Event Setup

Press <Enter> and the following sub-menu appears.



### ► Wake up Event By

Setting to [BIOS] activates the following fields, and use the following fields to set the wake up events. Setting to [OS], the wake up events will be defined by OS.

### ► Resume From S3 By USB Device

The item allows the activity of the USB device to wake up the system from S3 (Suspend to RAM) sleep state.

### ► Resume From S3 By PS/2 Keyboard / Mouse

These items determine whether the system will be awakened from what power saving modes when input signal of the PS/2 keyboard/ mouse is detected.

### ► Resume By PCI-E Device

When set to [Enabled], the feature allows your system to be awakened from the power saving modes through any event on PCIE device.

### ► Resume By RTC Alarm

The field is used to enable or disable the feature of booting up the system on a scheduled time/date.

### ► Date/ HH:MM:SS

If Resume By RTC Alarm is set to [Enabled], the system will automatically resume (boot up) on a specific date/hour/minute/second specified in these fields (using the <+> and <-> to select the date & time settings). Available settings for each item are:

- [Date] 01 ~ 31, Every Day
- [HH:MM:SS] 00 ~ 23 : 00 ~ 59 : 00 ~ 59

## H/W Monitor

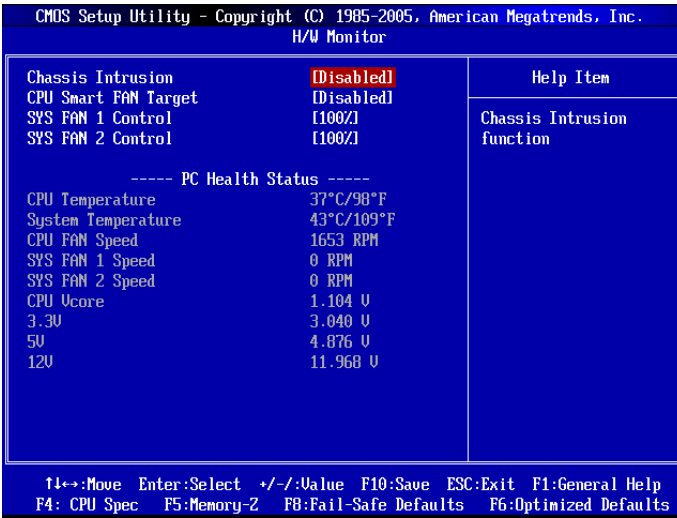

► **Chassis Intrusion**

The field enables or disables the feature of recording the chassis intrusion status and issuing a warning message if the chassis is once opened. To clear the warning message, set the field to [Reset]. The setting of the field will automatically return to [Enabled] later.

► **CPU Smart FAN Target**

The mainboard provides the Smart Fan function which can control the CPU fan speed automatically depending on the current temperature to keep it with in a specific range. You can enable a fan target value here. If the current CPU fan temperature reaches to the target value, the smart fan function will be activated. It provides several sections to speed up for cooling down automatically.

► **SYS FAN 1/ 2 Control**

These items allow users to select how percentage of speed for the SYSFAN1/ 2/ 3/ 4.

► **PC Health Status**

- CPU/ System Temperature, CPU FAN/ SYS FAN 1/ 2 Speed, CPU Vcore, 3.3V, 5V, 12V

These items display the current status of all of the monitored hardware devices/components such as CPU voltage, temperatures and all fans' speeds.

## Green Power

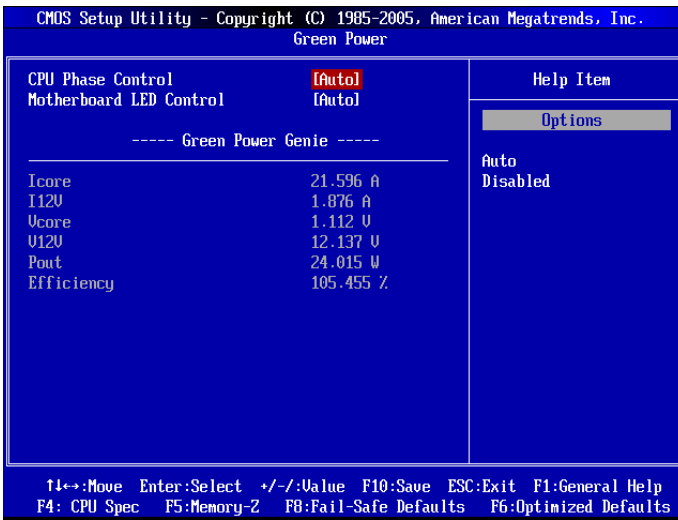

### ► CPU Phase Control

When set to [Auto], the hardware will auto adjust the CPU power phase according to the loading of CPU to reach the best power saving function.

### ► Motherboard LED Control

This item is used to turn on (Auto)/ turn off (Disabled) the power phase LEDs of the mainboard.

### ----- GreenPower Genie-----

#### ► Icore/ I12V/ Vcore/ V12V

These items show the amperage of I core/ V core/ I12V/ V12V. Read only.

#### ► Pout/ Efficiency

These items show the power consumption & efficiency of the system. Read only.

## BIOS Setting Password

When you select this function, a message as below will appear on the screen:

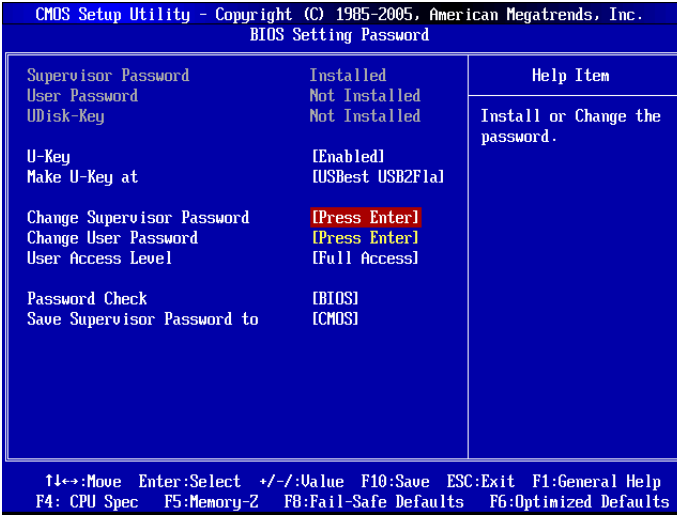

► **U-Key**

This item is used to enable/ disable USB driver device as a key.

► **Make U-Key at**

This item appears when U-Key is set to Enabled, it can be used to specify the USB driver device as a key.

► **Change Supervisor Password**

This item is used to set the supervisor password.

► **Change User Password**

This item is used to set the user password.

### **Important**

Type the password, up to eight characters in length, and press <Enter>. The password typed now will replace any previously set password. You will be prompted to confirm the password. Retype the password and press <Enter>. You may also press <Esc> to abort the selection and not enter a password.

To clear a set password, just press <Enter> when you are prompted to enter the password. A message will show up confirming the password will be disabled. Once the password is disabled, the system will boot and you can enter Setup without entering any password.

When a password has been set, you will be prompted to enter it every time you try to enter Setup/ System. This prevents an unauthorized person from changing any part of



*your system configuration.*

*About Supervisor Password & User Password:*

**Supervisor password:** *Can enter and change the settings of the setup menu.*

**User password:** *Can only enter but do not have the right to change the settings of the setup menu.*

► **User Access Level**

This item is used to limit the user access level.

► **Passwrod Check**

This specifies the type of BIOS password protection that is implemented. Settings are described below:

| Option   | Description  |
|----------|--|
| [BIOS]   | The password prompt appears only when end users try to run Setup.  |
| [System] | A password prompt appears every time when the computer is powered on or when end users try to run Setup. |

► **Save Supervisor Password to**

This item is used to assign a place to save the supervisor password.

## Cell Menu

| CMOS Setup Utility - Copyright (C) 1985-2005, American Megatrends, Inc.   |                  | Help Item |
|---|------------------|-----------|
| Cell Menu   |                  |           |
| Current Core Frequency  | 3.32GHz (133x25) |           |
| Current DRAM Frequency  | 1066MHz          |           |
| Current QPI Frequency   | 6.400GT          |           |
| -----   |                  |           |
| ▶ CPU Specifications  | [Press Enter]    |           |
| ▶ CPU Feature   | [Press Enter]    |           |
| Intel EIST  | [Auto]           |           |
| CIE Support   | [Enabled]        |           |
| Intel Turbo Boost   | [Enabled]        |           |
| ▶ Turbo Boost Tech Config   | [Press Enter]    |           |
| Adjust CPU Base Frequency (MHz)   | [133]            |           |
| Adjusted CPU Frequency (MHz)  | 3325             |           |
| -----   |                  |           |
| ▶ MEMORY-Z  | [Press Enter]    |           |
| Current DRAM Channel 1 Timing   | 8-8-8-19         |           |
| Current DRAM Channel 2 Timing   | 8-8-8-19         |           |
| Current DRAM Channel 3 Timing   | 8-8-8-19         |           |
| DRAM Timing Mode  | [Auto]           |           |
| Advance DRAM Configuration  | [Press Enter]    |           |
| Memory Ratio  | [Auto]           |           |
| Adjusted DRAM Frequency (MHz)   | 1066             |           |
| Uncore Ratio  | [Auto]           |           |
| Adjusted Uncore Frequency (MHz)   | 2133             |           |
| -----   |                  |           |
| ▶ QPI Configuration   | [Press Enter]    |           |
| ▶ ClockGen Tuner  | [Press Enter]    |           |
| Adjust PCI Frequency (MHz)  | [Auto]           |           |
| Adjust PCI-E Frequency (MHz)  | [100]            |           |
| Auto Disable PCI/PCI-E Frequency  | [Enabled]        |           |
| -----   |                  |           |
| CPU Voltage (V)   | [Auto]           |           |
| CPU PLL Voltage (V)   | [Auto]           |           |
| QPI Voltage (V)   | [Auto]           |           |
| DRAM Voltage (V)  | [Auto]           |           |
| DDR_VREF_CA_A (V)   | [Auto]           |           |
| DDR_VREF_CA_B (V)   | [Auto]           |           |
| DDR_VREF_CA_C (V)   | [Auto]           |           |
| DDR_VREF_DQ_A (V)   | [Auto]           |           |
| DDR_VREF_DQ_B (V)   | [Auto]           |           |
| DDR_VREF_DQ_C (V)   | [Auto]           |           |
| IOH Voltage (V)   | [Auto]           |           |
| ICH Voltage (V)   | [Auto]           |           |
| -----   |                  |           |
| Spread Spectrum   | [Enabled]        |           |
| ↑←→:Move Enter:Select +/-:Value F10:Save ESC:Exit F1:General Help<br>F4: CPU Spec F5:Memory-Z F8:Fail-Safe Defaults F6:Optimized Defaults |                  |           |

### Important

Change these settings only if you are familiar with the chipset.

▶ Current CPU / DRAM / QPI Frequency

These items show the current frequencies of CPU, Memory and QPI. Read-only.

### ► CPU Specifications

Press <Enter> to enter the sub-menu and the following screen appears. This sub-menu shows the information of installed CPU.

| CMOS Setup Utility - Copyright (C) 1985-2005, American Megatrends, Inc. |                                  |               |
|---|----------------------------------|---------------|
| CPU Specifications  |                                  |               |
|   |                                  | Help Item     |
| Intel(R) Core(TM) i7 CPU  | X 980 @ 3.33GHz                  |               |
| CPUID/MicroCode   | 206C2/05                         |               |
| CPU Frequency   | 3361MHz                          |               |
| Ratio Status  | Unlocked (Min:12, Max:Unlimited) |               |
| CPU Ratio   | 25                               |               |
| CPU Stepping  | B1                               |               |
| Cache L1  | 384KB                            |               |
| Cache L2  | 1536KB                           |               |
| Cache L3  | 12288KB                          |               |
| Core VID  | N/A                              |               |
| Current Core VID  | 1.104 V                          |               |
| Core Number   | 6                                |               |
| ► CPU Technology Support  |                                  | [Press Enter] |

### ► CPU Technology Support

Press <Enter> to enter the sub-menu. In this sub-menu, it shows the installed CPU technologies. Read only.

### ► CPU Feature

Press <Enter> to enter the sub-menu and the following screen appears:

| CMOS Setup Utility - Copyright (C) 1985-2005, American Megatrends, Inc. |            |  |
|---|------------|--|
| CPU Feature   |            |  |
|   |            | Help Item                                  |
| Intel EIST  | [Auto]     |  |
| Intel C-STATE   | [Enabled]  |  |
| C State package limit setting   | [Auto]     | Disable: Disable G03<br>Enable: Enable G03 |
| C1E Support   | [Enabled]  |  |
| Overspeed Protection  | [Enabled]  |  |
| Hyper-Threading Function  | [Enabled]  |  |
| Execute Bit Support   | [Enabled]  |  |
| Set Limit CPUID MaxVal to 3   | [Disabled] |  |
| Intel Virtualization Tech   | [Enabled]  |  |
| Intel VT-d Tech   | [Disabled] |  |

### ► Intel EIST

The Enhanced Intel SpeedStep technology allows you to set the performance level of the microprocessor whether the computer is running on battery or AC power. This field will appear after you installed the CPU which supports speedstep technology.

### ► Intel C-STATE

C-state is a power management state that significantly reduces the power of the processor during idle. This field will appear after you installed the CPU which supports c-state technology.

### ► C State package limit setting

This field allows you to select a C-state level. We recommend that you leave this setting to Auto.

### ► C1E Support

To enable this item to read the CPU power consumption while idle. Not all processors

support Enhanced Halt state (C1E).

### ► Overspeed Protection

Overspeed Protection function can monitor the current CPU draws as well as its power consumption. If it exceeds a certain level, the processor automatically reduces its clock speed. If you want to overclock your CPU, set it to [Disabled].

### ► Hyper-Threading Function

The processor uses Hyper-Threading technology to increase transaction rates and reduces end-user response times. The technology treats the two cores inside the processor as two logical processors that can execute instructions simultaneously. In this way, the system performance is highly improved. If you disable the function, the processor will use only one core to execute the instructions. Please disable this item if your operating system doesn't support HT Function, or unreliability and instability may occur.

## **Important**

*Enabling the functionality of Hyper-Threading Technology for your computer system requires ALL of the following platform Components:*

- CPU: An Intel® Processor with HT Technology;
- Chipset: An Intel® Chipset that supports HT Technology;
- BIOS: A BIOS that supports HT Technology and has it enabled;
- OS: An operating system that supports HT Technology.

*For more information on Hyper-threading Technology, go to:*

*[http://www.intel.com/products/ht/hyperthreading\\_more.htm](http://www.intel.com/products/ht/hyperthreading_more.htm)*

### ► Execute Bit Support

Intel's Execute Disable Bit functionality can prevent certain classes of malicious "buffer overflow" attacks when combined with a supporting operating system. This functionality allows the processor to classify areas in memory by where application code can execute and where it cannot. When a malicious worm attempts to insert code in the buffer, the processor disables code execution, preventing damage or worm propagation.

### ► Set Limit CPUID MaxVal to 3

The Max CPUID Value Limit is designed limit the listed speed of the processor to older operating systems.

### ► Intel Virtualization Tech

This item is used to enable/disable the Intel Virtualization technology. For further information please refer to Intel's official website.

### ► Intel VT-d

This item is used to enable/disable the Intel Virtualization Technology for Directed I/O (VT-d). For further information please refer to Intel's official website.

### ► Intel EIST

The Enhanced Intel SpeedStep technology allows you to set the performance level of the microprocessor whether the computer is running on battery or AC power. This field will appear after you installed the CPU which supports speedstep technology.

### ► C1E Support

To enable this item to read the CPU power consumption while idle. Not all processors support Enhanced Halt state (C1E).

### ► Intel Turbo Boost

This item will appear when you install a CPU with Intel Turbo Boost technology. This item is used to enable/ disable Intel Turbo Boost technology. It can scale processor frequency higher dynamically when applications demand more performance and TDP headroom exists. It also can deliver seamless power scalability (Dynamically scale up, Speed-Step Down). It is the Intel newly technology within i7 CPU.

### ► Turbo Boost Tech Config

Press <Enter> to enter the sub-menu and the following screen appears:

| CMOS Setup Utility - Copyright (C) 1985-2005, American Megatrends, Inc. |           |   |
|---|-----------|---|
| Turbo Boost Tech Config   |           |   |
|   |           | Help Item   |
| Turbo Ratio Limit Program   | [Enabled] |   |
| 1-Core Ratio Limit  | [27]      | Enable it to allow that the CPU will overlocked by raising the CPU-Ratio dynamically to the Core Ratio Limit you set. |
| 2-Core Ratio Limit  | [27]      |   |
| 3-Core Ratio Limit  | [26]      |   |
| 4-Core Ratio Limit  | [26]      |   |
| 5-Core Ratio Limit  | [26]      |   |
| 6-Core Ratio Limit  | [26]      |   |
| TDC Limit Override  | [Enabled] |   |
| Factory default TDC limit value : 110                                   |           |   |
| TDC Limit value (A)   | [ 110]    |   |
| TDP Limit Override  | [Enabled] |   |
| Factory default TDP limit value : 130                                   |           |   |
| TDP Limit value (W)   | [ 130]    |   |

### ► Turbo Ratio Limit Program

This item is used to enable/ disable the turbo ratio limit program. Setting to [Enable] activates the following fields.

### ► 1/2/3/4/5/6-Core Ratio Limit

These items allow you to select the CPU core ratio limit.

### ► TDC Limit Override

Setting to [Enable] activates the TDC Limit value field, and use the TDC Limit value field to set the CPU TDC value.

### ► TDC Limit value (A)

This item allows you to select the CPU TDC value (ampere).

### ► TDP Limit Override

Setting to [Enable] activates the TDP Limit value field, and use the TDP Limit value field to set the CPU TDP value.

### ► TDP Limit value (W)

This item allows you to select the CPU TDP value (watt).

### ► Adjust CPU Base Frequency (MHz)

This item allows you to set the CPU Base clock (in MHz). You may overclock the CPU by adjusting this value. Please note the overclocking behavior is not guaranteed.

▶ Adjusted CPU Frequency (MHz)

It shows the adjusted CPU frequency. Read-only.

▶ MEMORY-Z

Press <Enter> to enter the sub-menu and the following screen appears.

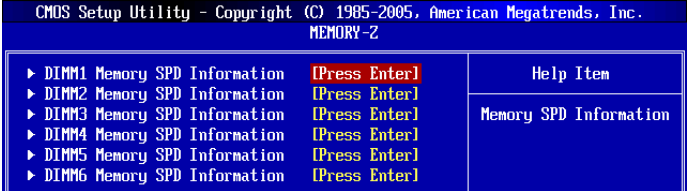

▶ DIMM1~6 Memory SPD Information

Press <Enter> to enter the sub-menu. The sub-menu displays the informations of installed memory.

▶ Current DRAM Channel Timing

It shows the installed DRAM Timing. Read-only.

▶ DRAM Timing Mode

Select whether DRAM timing is controlled by the SPD (Serial Presence Detect) EEPROM on the DRAM module. Setting to [Auto] enables DRAM timings and the following "Advance DRAM Configuration" sub-menu to be determined by BIOS based on the configurations on the SPD. Selecting [Manual] allows users to configure the DRAM timings and the following related "Advance DRAM Configuration" sub-menu manually.

▶ Advance DRAM Configuration

Press <Enter> to enter the sub-menu.

▶ CH1/ CH2/ CH3 1T/2T Memory Timing

This item controls the SDRAM command rate. Select [1N] makes SDRAM signal controller to run at 1N (N=clock cycles) rate. Selecting [2N] makes SDRAM signal controller run at 2N rate.

▶ CH1/ CH2/ CH3 CAS Latency (CL)

This controls the CAS latency, which determines the timing delay (in clock cycles) before SDRAM starts a read command after receiving it.

▶ CH1/ CH2/ CH3 tRCD

When DRAM is refreshed, both rows and columns are addressed separately. This setup item allows you to determine the timing of the transition from RAS (row address strobe) to CAS (column address strobe). The less the clock cycles, the faster the DRAM performance.

▶ CH1/ CH2/ CH3 tRP

This setting controls the number of cycles for Row Address Strobe (RAS) to be allowed to precharge. If insufficient time is allowed for the RAS to accumulate its charge before DRAM refresh, refresh may be incomplete and DRAM may fail to retain data. This item applies only when synchronous DRAM is installed in the system.

▶ **CH1/ CH2/ CH3 tRAS**

This setting determines the time RAS takes to read from and write to memory cell.

▶ **CH1/ CH2/ CH3 tRFC**

This setting determines the time RFC takes to read from and write to a memory cell.

▶ **CH1/ CH2/ CH3 tWR**

Minimum time interval between end of write data burst and the start of a precharge command. Allows sense amplifiers to restore data to cells.

▶ **CH1/ CH2/ CH3 tWTR**

Minimum time interval between the end of write data burst and the start of a column-read command. It allows I/O gating to overdrive sense amplifiers before read command starts.

▶ **CH1/ CH2/ CH3 tRRD**

Specifies the active-to-active delay of different banks.

▶ **CH1/ CH2/ CH3 tRTP**

Time interval between a read and a precharge command.

▶ **CH1/ CH2/ CH3 tFAW**

This item is used to set the tFAW timing.

▶ **Current CH1/ CH2/ CH3 tdrRdTRd/ tddRdTRd/ tsrRdTWrr/ tdrRdTWrr/ tddRdTWrr/ tsrWrTRd/ tddWrTWrr/ tsrRDTRd/ tsrWrTWrr**

These items show the advanced DRAM timings.

▶ **Channel 1/ Channel2 Advanced Memory Setting**

Setting to [Auto] enables the advanced memory timing automatically to be determined by BIOS. Setting to [Manual] allows you to set the following advanced memory timings.

▶ **Memory Ratio**

This item allows you to set the memory multiplier.

▶ **Adjusted DRAM Frequency (MHz)**

It shows the adjusted DRAM frequency. Read-only.

▶ **Uncore Ratio**

This item allows you to set the uncore multiplier.

▶ **Adjusted Uncore Frequency (MHz)**

It shows the adjusted uncore frequency. Read-only.

▶ **QPI Configuration**

Press <Enter> to enter the sub-menu.

▶ **QPI Links Speed**

This item allows you to select the QPI links speed type.

▶ **QPI Frequency**

This item allows you to select the QPI frequency.

▶ **ClockGen Tuner**

Press <Enter> to enter the sub-menu and the following screen appears.

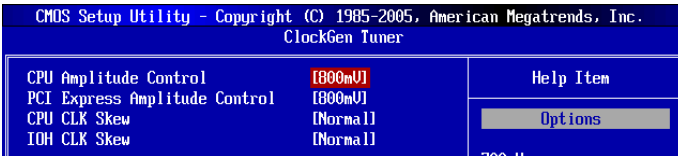

▶ **CPU Amplitude Control/ PCI Express Amplitude Control**

These items are used to select the CPU/ PCI Express clock amplitude.

▶ **CPU CLK Skew/ MCH CLK Skew**

These items are used to select the CPU/ MCH chipset clock skew. They can help CPU to reach the higher overclocking performance.

▶ **Adjust PCI Frequency (MHz)**

This field allows you to select the PCI frequency (in MHz).

▶ **Adjust PCI-E Frequency (MHz)**

This field allows you to select the PCIE frequency (in MHz).

▶ **Auto Disable PCI/PCI-E Frequency**

When set to [Enabled], the system will remove (turn off) clocks from empty PCI and PCI-E slots to minimize the electromagnetic interference (EMI).

▶ **CPU Voltage (V)/ CPU PLL Voltage (V)/ QPI Voltage (V)/ DRAM Voltage (V)/ DDR\_VREF\_CA\_A (V)/ DDR\_VREF\_CA\_B (V)/ DDR\_VREF\_CA\_C (V)/ DDR\_VREF\_DQ\_A (V)/ DDR\_VREF\_DQ\_B (V)/ DDR\_VREF\_DQ\_C (V)/ IOH Voltage (V)/ ICH Voltage (V)**

These items are used to adjust the voltage of CPU, Memory and chipset.

▶ **Spread Spectrum**

When the mainboard's clock generator pulses, the extreme values (spikes) of the pulses create EMI (Electromagnetic Interference). The Spread Spectrum function reduces the EMI generated by modulating the pulses so that the spikes of the pulses are reduced to flatter curves.

**Important**

- If you do not have any EMI problem, leave the setting at [Disabled] for optimal system stability and performance. But if you are plagued by EMI, select the value of Spread Spectrum for EMI reduction.
- The greater the Spread Spectrum value is, the greater the EMI is reduced, and the system will become less stable. For the most suitable Spread Spectrum value, please consult your local EMI regulation.
- Remember to disable Spread Spectrum if you are overclocking because even a slight jitter can introduce a temporary boost in clock speed which may just cause your over-clocked processor to lock up.



## **Important**

### **Failed Overclocking Resolution**

This mainboard supports overclocking greatly. However, please make sure your peripherals and components are bearable for some special settings. Any operation that exceeds product specification is not recommended. Any risk or damage resulting from improper operation will not be under our product warranty.

**Two ways to save your system from failed overclocking...**

- **Reboot**

Press the Power button to reboot the system three times. Please note that, to avoid electric current to affect other devices or components, we suggest an interval of more than 10 seconds among the reboot actions.

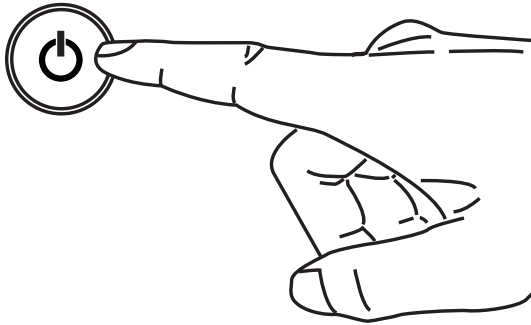

At the fourth reboot, BIOS will determine that the previous overclocking is failed and restore the default settings automatically. Please press any key to boot the system normally when the following message appears on screen.

**Warning !!!** The previous overclocking had failed,  
and system will restore its defaults setting,  
Press any key to continue.....

- **Clear CMOS**

Please refer to "Chapter 2" for more information about how to clear CMOS data.

## M-Flash

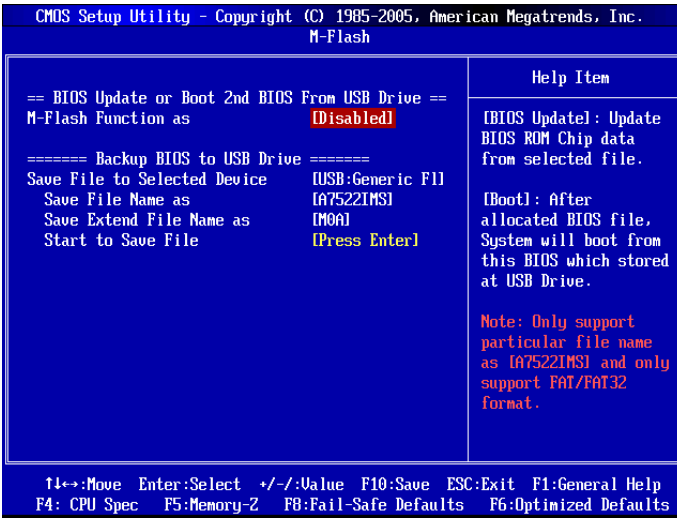

== BIOS Update or Boot 2nd BIOS From USB drive ==

► **M-Flash function as**

M-Flash function allows you to flash BIOS from USB drive/ storage drive (FAT/ FAT32 format only), or allows the system to boot from the BIOS file inside USB drive (FAT/ FAT32 format only).

[Disabled] Disable M-Flash function.

[BIOS Update] Flash BIOS via the USB/ Storage drive directly. Update BIOS ROM chip data from selected file, which was be download from official website and must be saved in the root directory of the USB/ Storage drive. It only supports particular file name, which is the official BIOS file name from us.

[Boot] After allocated particular BIOS file, system will boot from this BIOS file which saved in the root directory of USB drive. System will skip MB ROM chip data and boot with this particular BIOS inside USB drive. Note: this option is for USB drive only.

**Important**

- Please refer to the block diagram below about the M-Flash function.

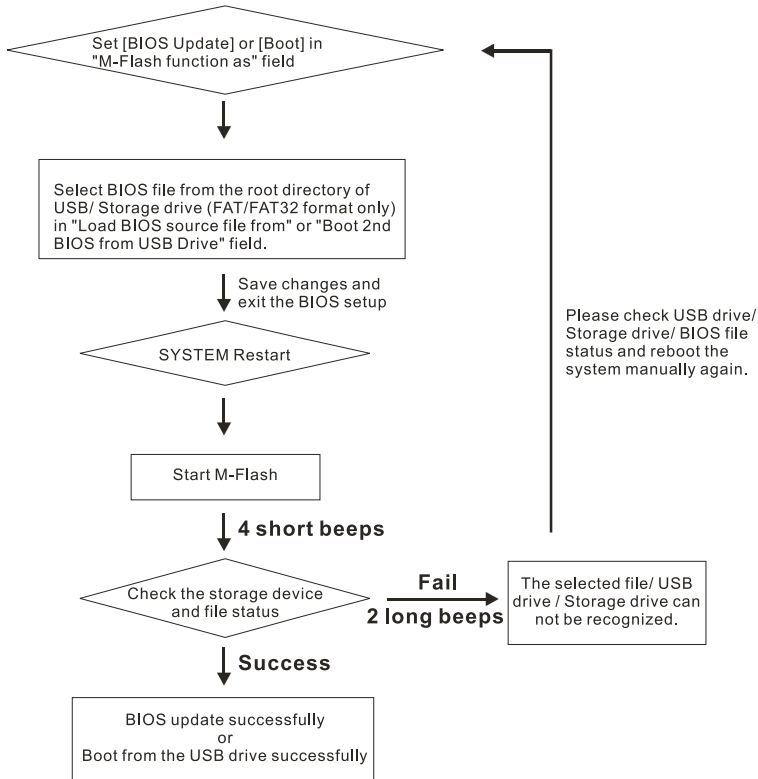

- Due to the special design of some graphics cards will cause dark screen during M-flash operation, and you may refer the beeps from the system to confirm the current M-flash process.

▶ **Load BIOS source File from**

When the M-Flash function as sets to [BIOS Update], this item is selectable. Use this item to select particular BIOS file from the USB/ Storage (FAT/32 format only) drive.

▶ **Boot 2nd BIOS from USB Drive**

When the M-Flash function as sets to [Boot] ], this item is selectable. Use this item to select particular BIOS file from the USB drive.

== Backup BIOS to USB Drive ==

The following fields are used to read the onboard BIOS ROM data, and save it to USB drive/ storage drive.

▶ **Save File to Selected Device**

Please setup a specific folder in specific USB drive/ storage drive to save BIOS file from BIOS ROM chip data. Note: it only supports FAT/ FAT32 file system drive.

▶ **Save File Name as**

Please setup a specific name for the BIOS file, which will be saved into the USB drive/ storage drive. Note: we suggest you using the official name as the default name.

▶ **Save Extend File Name as**

Please setup a specific extend name for the BIOS file, which will be saved into the USB drive/ storage drive. Note: we suggest you using [ROM] as default name.

▶ **Start to Save File**

Press "Enter" and select "OK" the system will stare to save the onboard ROM chip data to the selected USB drive/ storage drive.

## Overclocking Profile

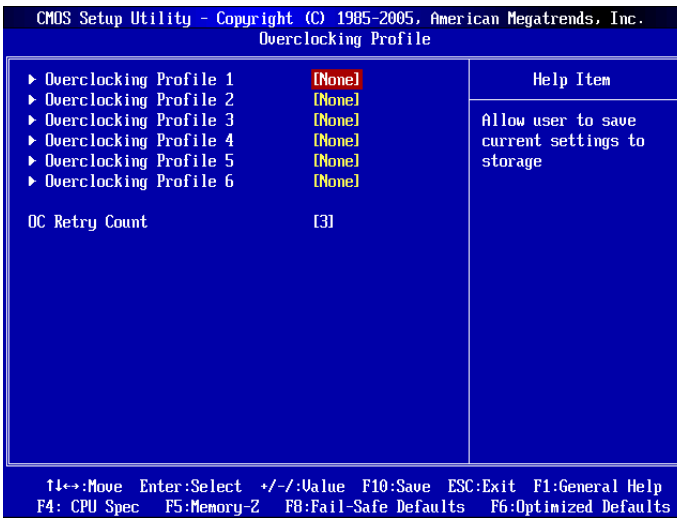

### ▶ Overclocking Profile 1/ 2/ 3/ 4/ 5/ 6

These items are used to save the current settings to selected profile, and they are also used to load the settings from the selected profile.

### ▶ OC Retry Count

When overclocking has failed, setting this item to [3,5] will allow system to reboot 3/ 5 times with the same overclocked configuration. If overclocking has failed every time, the system will restore the defaults.

## Load Fail-Safe/ Optimized Defaults

---

The two options on the main menu allow users to restore all of the BIOS settings to the default Fail-Safe or Optimized values. The Optimized Defaults are the default values set by the mainboard manufacturer specifically for optimal performance of the mainboard. The Fail-Safe Defaults are the default values set by the BIOS vendor for stable system performance.

When you select Load Fail-Safe Defaults, a message as below appears:



Selecting Ok and pressing Enter loads the BIOS default values for the most stable, minimal system performance.

When you select Load Optimized Defaults, a message as below appears:



Selecting Ok and pressing Enter loads the default factory settings for optimal system performance.

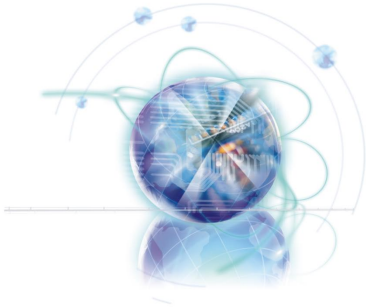

## *Appendix A*

# *Realtek Audio*

The Realtek audio provides 10-channel DAC that simultaneously supports 7.1 sound playback and 2 channels of independent stereo sound output (multiple streaming) through the Front-Out-Left and Front-Out-Right channels.

## Installing the Realtek HD Audio Driver

You need to install the HD audio driver for Realtek audio codec to function properly before you can get access to 2-, 4-, 6-, 8- channel or 7.1+2 channel audio operations. Follow the procedures described below to install the drivers for different operating systems.

### Installation for Windows®

For Windows® XP, you must install Windows® XP Service Pack3 or later before installing the driver.

The following illustrations are based on Windows®7 environment and could look slightly different if you install the drivers in different operating systems.

1. Insert the application DVD into the DVD-ROM drive. The setup screen will automatically appear.
2. Click Driver tab.
3. Click Audio button.



4. Select Realtek HD Audio Drivers to start installing the drivers.
5. Click Next to install the Realtek High Definition Audio Driver.
6. Follow the on-screen instructions to install drivers.
7. Click Finish to restart the system.

### **Important**

*The HD Audio Configuration software utility is under continuous update to enhance audio applications. Hence, the program screens shown here in this section may be slightly different from the latest software utility and shall be held for reference only.*



## Software Configuration

After installing the audio driver, the “Realtek HD Audio Manager” icon will appear at the notification area (lower right of the screen). You may double click the icon and the GUI will pop up accordingly.



It is also available to enable the audio driver by clicking the Realtek HD Audio Manager from the Control Panel.

## Software panel overview

The following figure describes the function of the Realtek HD Audio Manager panel.

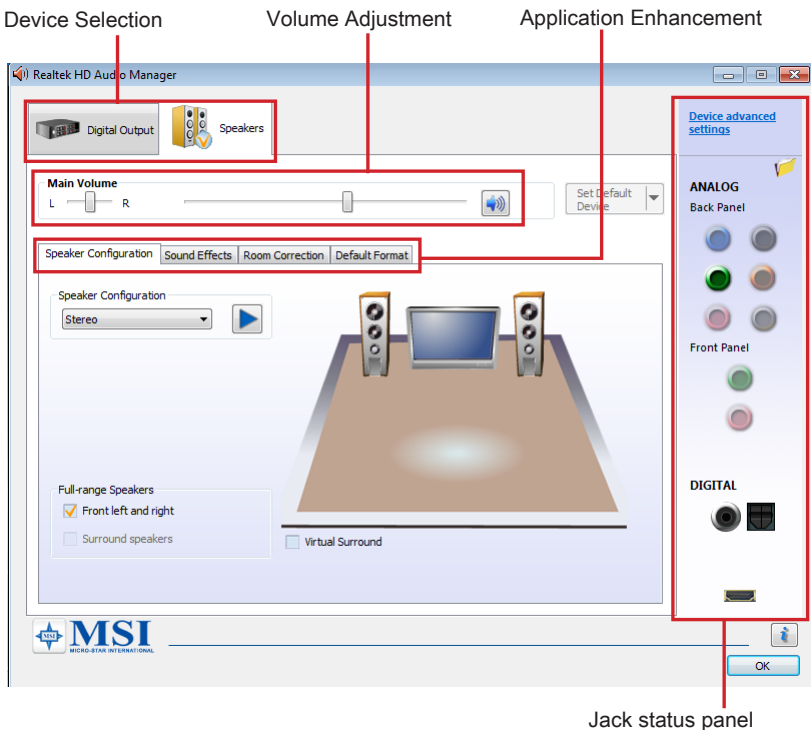

Jack status panel

■ **Device Selection**

Here you can select a audio output source to change the related options. the “check” sign (in orange) indicates the devices as default.

■ **Volume Adjustment**

You can control the volume or balance the right/left side of the speakers that you plugged in front or rear panel by adjust the bar.

■ **Application Enhancement**

The array of options will provide you a complete guidance of anticipated sound effect for both output and input device.

■ **Jack status panel**

This panel depicts all render and capture devices currently connected with your computer. Additionally, more applications would be found at the option of “Device Advanced Settings”.

### Auto popup dialog

When you plug into the device at the jack, a dialogue window will pop up asking you which device is current connected.

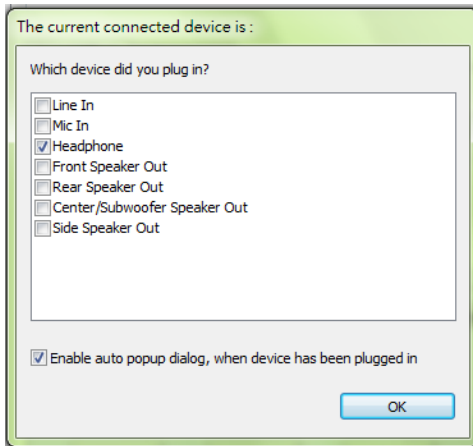

As you know, each jack corresponds to its default setting, you can refer to the next section “Hardware Default Setting”.

## Hardware Default Setting

The following diagrams are audio back panel default setting.

- Backpanel audio jacks to 2-channel speakers diagram

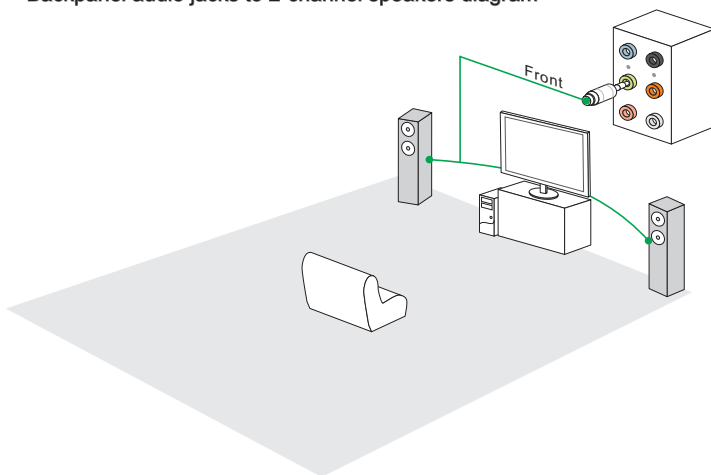

- Backpanel audio jacks to 4-channel speakers diagram

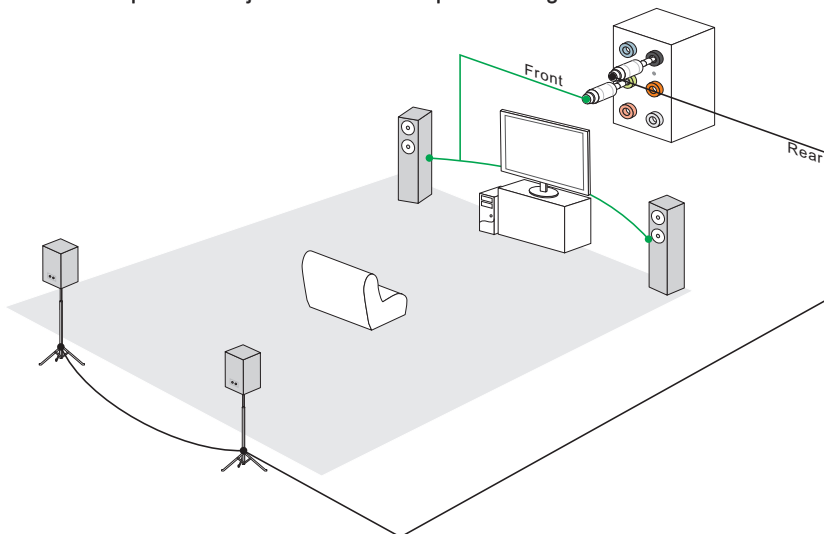

■ Backpanel audio jacks to 6-channel speakers diagram

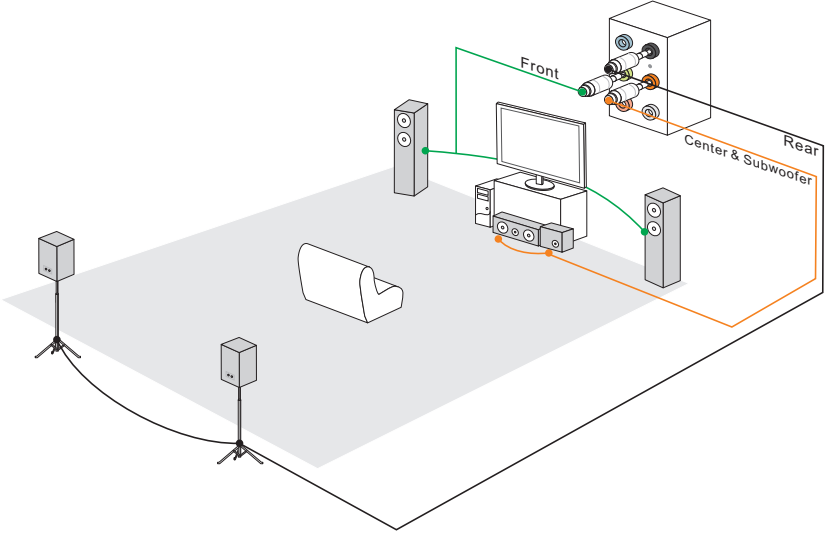

■ Backpanel audio jacks to 8-channel speakers diagram

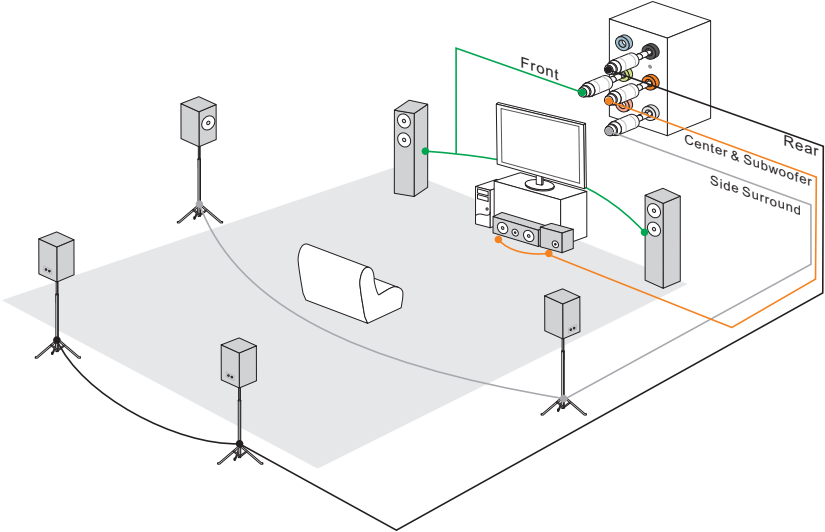

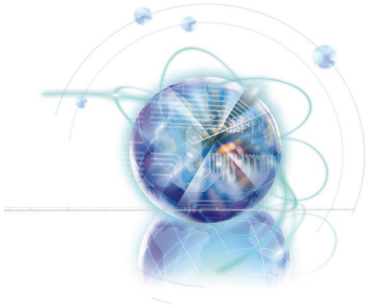

## *Appendix B*

# *Intel RAID*

This appendix will assist users in configuring and enabling RAID functionality on platforms

## Introduction

---

The mainboard comes with the Intel RAID controller that allows you to configure SATA hard drives as RAID sets.

SATA hard drives deliver blistering transfer speeds up to 3 Gb/s. Serial ATA uses long, thin cables, making it easier to connect your drive and improving the airflow inside your PC. The most outstanding features are:

1. Supports 3 Gb/s transfers with CRC error checking.
2. Supports Hot-plug-n-play feature.
3. Data handling optimizations including tagged command queuing, elevator seek and packet chain command.

Intel® RAID controller offers RAID level 0 (Striping), RAID level 1 (Mirroring and Duplexing), RAID level 5 (Block Interleaved Distributed Parity), RAID level 10 (A Stripe of Mirrors) , Intel® Matrix Storage Technology and Intel® Rapid Recover Technology.

RAID 0 breaks the data into blocks which are written to separate hard drives. Spreading the hard drive I/O load across independent channels greatly improves I/O performance.

RAID 1 provides data redundancy by mirroring data between the hard drives and provides enhanced read performance.

RAID 5 Provides data striping at the byte level and also stripe error correction information. This results in excellent performance and good fault tolerance. Level 5 is one of the most popular implementations of RAID.

RAID 10 Not one of the original RAID levels, multiple RAID 1 mirrors are created, and a RAID 0 stripe is created over these.

Intel® Matrix RAID Technology is the advanced ability for two RAID volumes to share the combined space of two hard drives being used in unison.

Intel® Rapid Recover Technology utilizes RAID 1 functionality to copy data from a designated Master drive to a designated Recovery drive. The size of the Master drive must be less than or equal to the size of the Recovery drive. When a Recovery volume is created, complete capacity of the Master drive will be used as the Master volume. Only one Recovery Volume can exist on a system. There are 2 methods of updating the data on the Master to the Recovery drive. They are Continuous Update Policy and On Request Update Policy.

### **Important**

*The least number of hard drives for RAID 0, RAID 1, Recovery or Matrix mode is 2. The least number of hard drives for RAID 10 mode is 4. And the least number of hard drives for RAID 5 mode is 3.*

*All the information/ volumes/ pictures listed in your system might differ from the illustrations in this appendix.*

## BIOS Configuration

The Intel Matrix Storage Manager Option ROM should be integrated with the system BIOS on all motherboards with a supported Intel chipset. The Intel Matrix Storage Manager Option ROM is the Intel RAID implementation and provides BIOS and DOS disk services. Please use <Ctrl> + <I> keys to enter the "Intel® RAID for Serial ATA" status screen, which should appear early in system boot-up, during the POST (Power-On Self Test). Also, you need to enable the RAID function in BIOS to create, delete and reset RAID volumes.

### Using the Intel Matrix Storage Manager Option ROM

#### Creating, Deleting and Resetting RAID Volumes:

The Serial ATA RAID volume may be configured using the RAID Configuration utility stored within the Intel RAID Option ROM. During the Power-On Self Test (POST), the following message will appear for a few seconds:

#### Important

The "Device Model", "Serial #" and "Size" in the following example might be different from your system.

```

RAID Volumes
None defined.

Physical Disks::
Port Device Model      Serial #              Size  Type/Status(Vol ID)
0   HDS722580VLSA80    VNRB3EC20549SL      76.7GB Non-RAID Disk
1   HDS722580VLSA80    VNRB3EC20559SL      76.7GB Non-RAID Disk
2   HDS722580VLSA80    VNRB3EC20569SL      76.7GB Non-RAID Disk
3   HDS722580VLSA80    VNRB3EC20579SL      76.7GB Non-RAID Disk

Press <CTRL-I> to enter Configuration Utility..

```

After the above message shows, press <Ctrl> and <I> keys simultaneously to enter the RAID Configuration Utility.

#### Important

The following procedure is only available with a newly-built system or if you are reinstalling your OS. It should not be used to migrate an existing system to RAID.

After pressing the <Ctrl> and <I> keys simultaneously, the following window will appear:

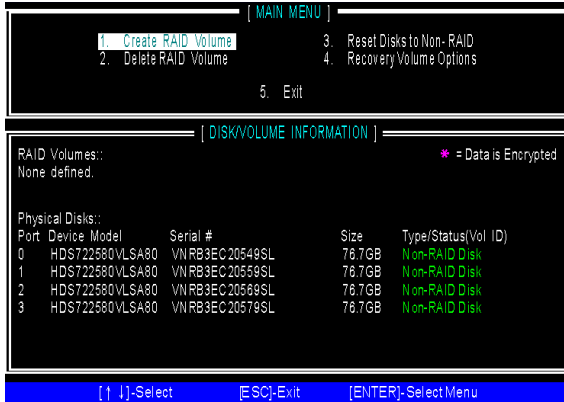

■ Create RAID Volume

1. Select option 1 "Create RAID Volume" and press <Enter> key. The following screen appears. Then in the Name field, specify a RAID Volume name and then press the <TAB> or <Enter> key to go to the next field.
2. Use the arrow keys to select the RAID level best suited to your usage model in RAID Level.

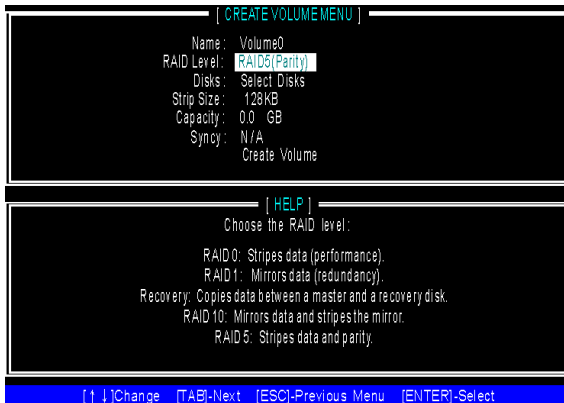



- In the Disk field, press <Enter> key and the following screen appears. Use <Space> key to select the disks you want to create for the RAID volume, then click <Enter> key to finish selection.

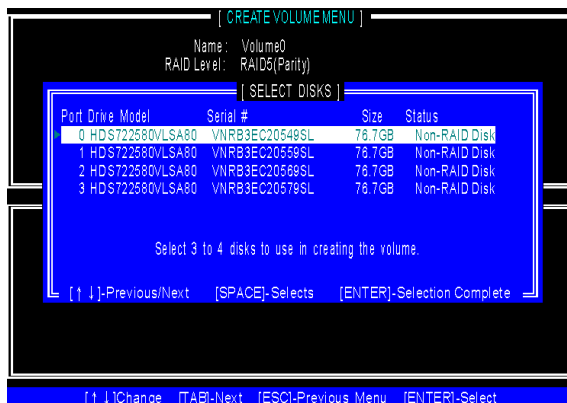

- Then select the strip value for the RAID array by using the “upper arrow” or “down arrow” keys to scroll through the available values, and pressing the <Enter> key to select and advance to the next field. The available values range from 4KB to 128 KB in power of 2 increments. The strip value should be chosen based on the planned drive usage. Here are some typical values: RAID0 -128KB / RAID10 - 64KB / RAID5 - 64KB.
- Then select the capacity of the volume in the Capacity field. The default value is the maximum volume capacity of the selected disks.



***Important***

Since you want to create two volumes (Intel Matrix RAID Technology), this default size (maximum) needs to be reduced. Type in a new size for the first volume. As an example: if you want the first volume to span the first half of the two disks, re-type the size to be half of what is shown by default. The second volume, when created, will automatically span the remainder of two hard drives.

- Then the following screen appears for you to confirm if you are sure to create the RAID volume. Press <Y> to continue.

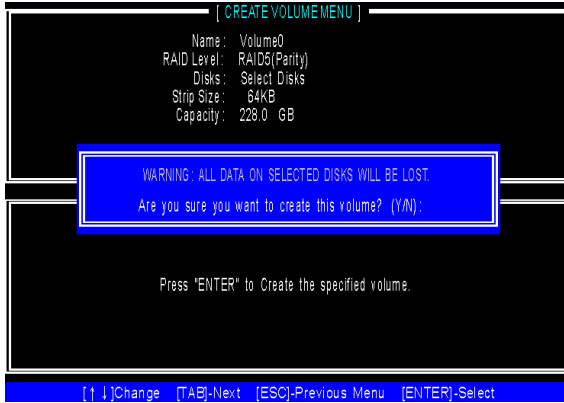

- Then the following screen appears to indicate that the creation is finished.

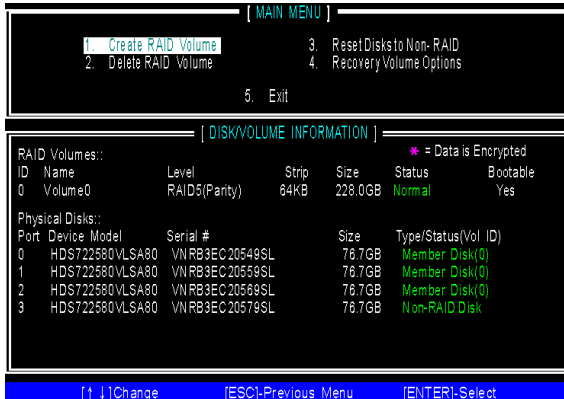

### ■ Delete RAID Volume

Here you can delete the RAID volume, but please be noted that all data on RAID drives will be lost.

### Important

*If your system currently boots to RAID and you delete the RAID volume in the Intel RAID Option ROM, your system will become unbootable.*

Select option 2 **Delete RAID Volume** from the main menu window and press <Enter> key to select a RAID volume for deletion. Then press <Delete> key to delete the selected RAID volume. The following screen appears.

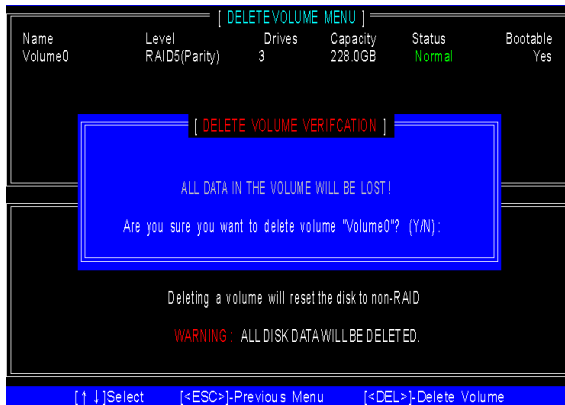

Press <Y> key to accept the volume deletion.

■ **Reset Disks to Non-RAID**

Select option 3 Reset Disks to Non-RAID and press <Enter> to delete the RAID volume and remove any RAID structures from the drives. The following screen appears:

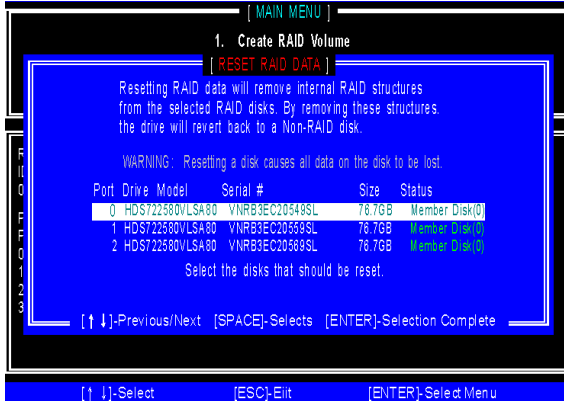

Press <Y> key to accept the selection.

**Important**

- You will lose all data on the RAID drives and any internal RAID structures when you perform this operation.
- Possible reasons to "Reset Disks to Non-RAID" could include issues such as incompatible RAID configurations or a failed volume or failed disk.

### ■ Recovery Volume Options

Select option 4 Recovery Volume Options and press <Enter> to change recovery volume mode. The following screen appears:

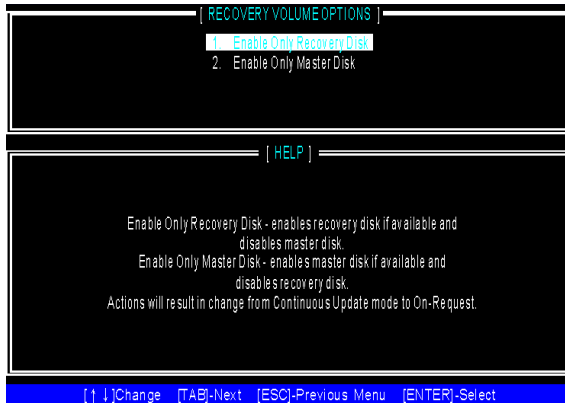

Recovery mode will change from Continuous Update to On-Request after you enable "Only Recovery Disk" or "Only Master Disk".

## Installing Driver

---

### ■ New Windows 7/ Vista / XP Installation

The following details the installation of the drivers while installing operating system.

1. When you start installing Windows XP, you may encounter a message stating, "Setup could not determine the type of one or more mass storage devices installed in your system". If this is the case, then you are already in the right place and are ready to supply the driver. If this is not the case, then press F6 when prompted at the beginning of Windows setup.
2. Press the "S" key to select "Specify Additional Device".
3. You should be prompted to insert a floppy disk containing the Intel® RAID driver into the A: drive.

Note: For Windows XP, you can use the USB floppy drive only.

For Windows Vista/ Windows 7 you can use CD/ DVD/ USB drive.

### **Important**

*Please follow the instruction below to make an "Intel® RAID Driver" for yourself.*

- Insert the MSI DVD into the DVD-ROM drive.
  - Click the "Browse DVD" on the Setup screen.
  - Copy all the contents in \\RAID\ Intel\ ICH10R\ floppy\ f6flpy32 or f6flpy64 to a formatted floppy diskette.
  - The driver diskette for Intel® ICH10R RAID Controller is done.
4. For Windows Vista/ Windows 7:  
During the Operating system installation, after selecting the location to install Vista / Windows 7 click on "Load Driver" button to install a third party SCSI or RAID driver.
  5. When prompted, insert the floppy disk or media (CD/DVD or USB) you created in step 3 and press Enter.
  6. You should be shown a list of available SCSI Adapters.
  7. Select the appropriate Intel RAID controller and press ENTER.
  8. The next screen should confirm that you have selected the Intel® RAID controller. Press ENTER again to continue.
  9. You have successfully installed the Intel® Matrix Storage Manager driver, and Windows setup should continue.
  10. Leave the disk in the floppy drive until the system reboots itself. Windows setup will need to copy the files from the floppy again after the RAID volume is formatted, and Windows setup starts copying files.

**■ Existing Windows Vista/ Windows 7/ XP Driver Installation**

1. Insert the MSI DVD into the DVD-ROM drive.
2. The DVD will auto-run and the setup screen will appear.
3. Under the Driver tab, click on Intel RAID Drivers.
4. The drivers will be automatically installed.

**■ Confirming Windows Vista/ Windows 7/ XP Driver Installation**

1. From Windows 7/ Vista/ XP, open the Control Panel from My Computer followed by the System icon.
2. Choose the Hardware tab, then click the Device Manager tab.
3. Click the "+" in front of the SCSI and RAID Controllers hardware type. The driver Intel(R) ICH10R SATA RAID Controller should appear.

## Degraded RAID Array

A RAID 1, RAID 5 or RAID 10 volume is reported as degraded when one of its hard drive members fails or is temporarily disconnected, and data mirroring is lost. As a result, the system can only utilize the remaining functional hard drive member. To re-establish data mirroring and restore data redundancy, refer to the procedure below that corresponds to the current situation.

### Missing Hard Drive Member

1. Make sure the system is powered off.
2. Reconnect the hard drive.
3. Reboot the system to Windows; the rebuild will occur automatically.

### Failed Hard Drive Member

1. Make sure the system is powered off.
2. Replace the failed hard drive with a new one that is of equal or greater capacity.
3. Reboot the system to Intel RAID Option ROM by press <Ctrl> and <I> keys simultaneously during the Power-On Self Test (POST).

```

Intel(R) Matrix Storage Manager option ROM v8.5.0.1013 ICH10R wRAID5
Copyright(C) 2003-08 Intel Corporation, All Rights Reserved.

RAID Volumes
ID Name Level Strip Size Status Bootable
0 Volume0 RAID 10(RAID0+1) 64KB 153.4GB Degraded Yes

Physical Disks::
Port Device Model Serial # Size Type/Status(Vol ID)
0 HDS722580VLSA80 VNRB3EC20549SL 76.7GB Member Disk (0)
1 HDS722580VLSA80 VNRB3EC20559SL 76.7GB Member Disk (0)
2 HDS722580VLSA80 VNRB3EC20569SL 76.7GB Member Disk (0)
3 HDS722580VLSA80 VNRB3EC20569SL 76.7GB Non-RAID Disk

Press <CTRL-I> to enter Configuration Utility..
    
```

4. Select the port of the destination disk for rebuilding, and then press ENTER.

```

[ MAIN MENU ]
[ DEGRADED VOLUME DETECTED ]
Degraded volume and disk available for rebuilding detected. Selecting
a disk initiates a rebuild. Rebuild completes in the operating system.

Select the port of the destination disk for rebuilding (ESC to exit):

Port Drive Model Serial # Size
0 HDS722580VLSA80 VNRB3EC20549SL 76.7GB
[↑ ↓]-Previous/Next [ENTER]-Select [ESC]-Exit

Port Device Model Serial # Size Type/Status(Vol ID)
0 HDS722580VLSA80 VNRB3EC20549SL 76.7GB Member Disk (0)
1 HDS722580VLSA80 VNRB3EC20559SL 76.7GB Member Disk (0)
2 HDS722580VLSA80 VNRB3EC20569SL 76.7GB Member Disk (0)
3 HDS722580VLSA80 VNRB3EC20579SL 76.7GB Non-RAID Disk

[↑ ↓]Change [ESC]-Previous Menu [ENTER]-Select
    
```



5. Exit Intel RAID Option ROM, and then reboot to Windows system.
6. When prompted to rebuild the RAID volume, click 'Yes'.
7. The Intel(R) Storage Utility will be launched. Right-click the new hard drive and select 'Rebuild to this Disk'. The 'Rebuild Wizard' will be launched which will guide you through the process of rebuilding to the new hard drive.



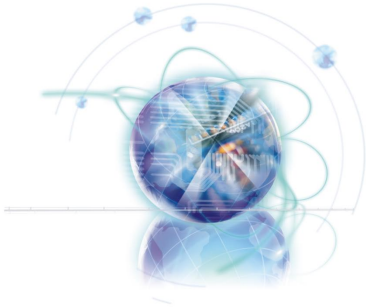

## *Appendix C*

# *Marvell RAID*

This chapter provides an overview of the Marvell RAID Driver and Utility, also describes the installation procedure.

## RAID Configuration

During bootup, a screen similar to the one below will appear for about few seconds. Press <Ctrl>+<M> to enter Marvell BIOS setup utility.

Press <Ctrl>+<M> to enter BIOS Setup or <Space> to continue

### Important

Be sure to enable the RAID function for SATA device in mainboard BIOS before configuring the Marvell BIOS setup utility.

The RAID setup utility menu screen will appear. The Main Menu shows as below.

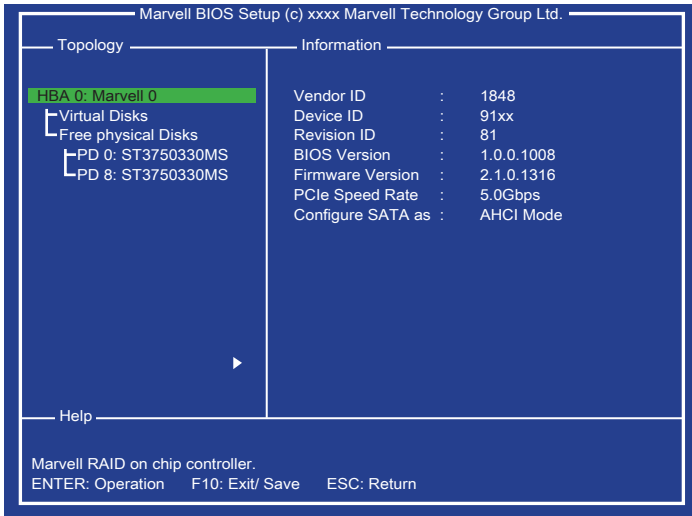

- **Topology** - this pane used a tree view to list and show the relationships between the various physical/ virtual devices attached to system.
- **Information** - this pane is populated based on the selection in the Topology pane.
- **Help** - this pane is used to display important information relevant to the selection. It may contain short descriptions on selections, messages on setting list items, default values for settings, among others.

## Creating Virtual Disks

This topic describes the procedure for creating virtual disks by using the Marvell BIOS setup utility.

1. In the Topology pane, scroll to [HBA 0: Marvell 0] and press Enter. A menu pops-up as shown below. Select "Configuration Wizard" and press Enter to begin creating the virtual disk.

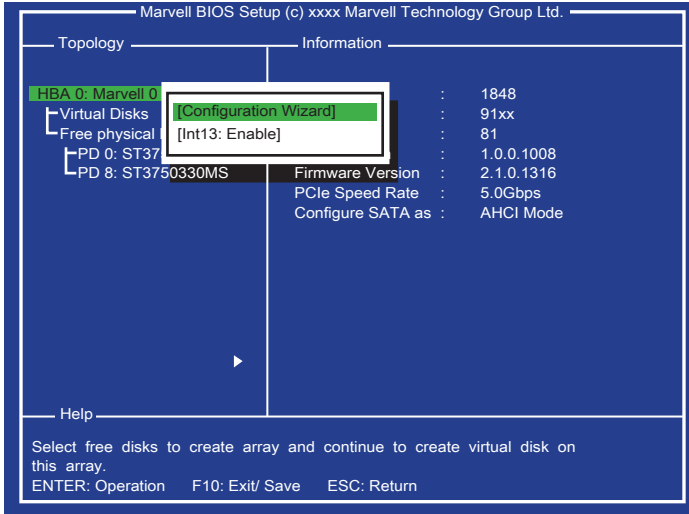

2. Press Space to select the disk, use the arrow keys to scroll the list of free disks. After select the required disks as shown below, press Enter to continue.

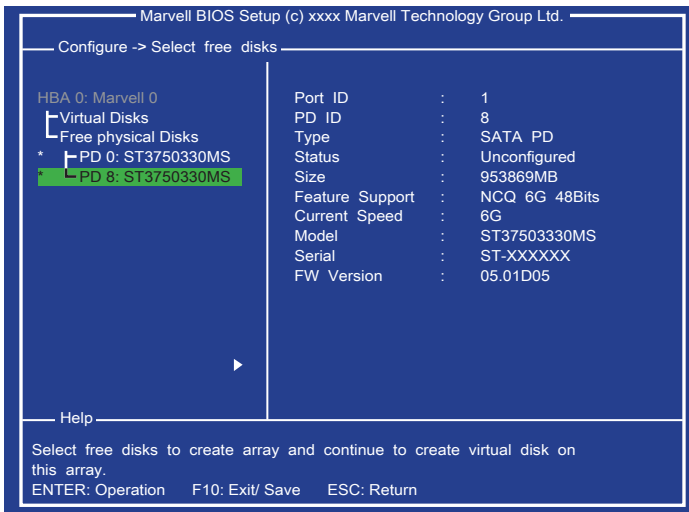

3. Create virtual disk by configuring its settings in the “Information” pane. as shown below. And refer the description below to configure the virtual disk settings.

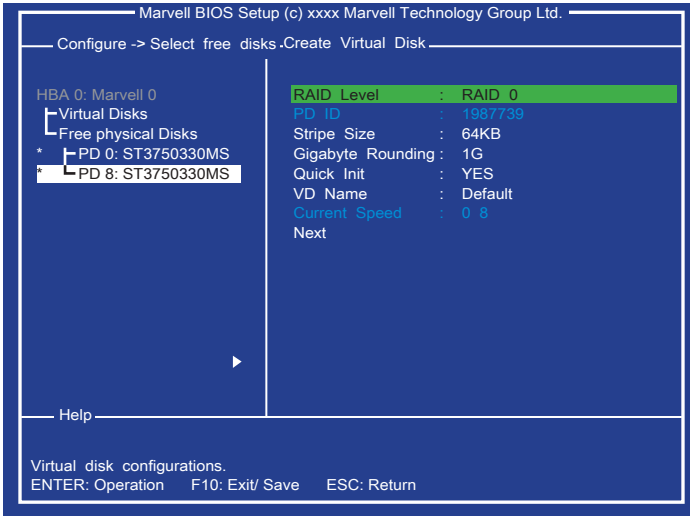

- RAID Level, select a RAID level (RAID 0, RAID 1).
- Max Size (MB), is the size of the RAID virtual disk as determined by the selected RAID level. It is property of the virtual disk that cannot be edited.
- Stripe Size, specifies the size (32K, 64K) of single data block on the virtual disk. The larger the stripe size, the longer it takes for the controller to read from and write to data blocks on the physical disks. In general, a larger stripe size is recommended for most applications. The default size is 64K.
- Gigabyte Rounding, define the flexibility in size for a replacement physical disk that is used to rebuild a degraded virtual disk. It is applicable to RAID 1 level only. Although the selection remains available for RAID 0, it only affects the size of the RAID 0 virtual disk (because RAID 0 does not offer redundancy).
- Quick Init, enable or disable quick initialization of the virtual disk. The default setting for [Quick Init] is “Yes”.
- VD Name, type a new virtual disk name.
- Disk ID, lists the IDs of the physical disks comprising the virtual disk. It is property of the virtual disk that cannot be edited.

4. After configure all settings for the virtual disk, scroll to the [Next] and press Enter to continue. And the screen shows as below, press Y to confirm the creation for the virtual disk.

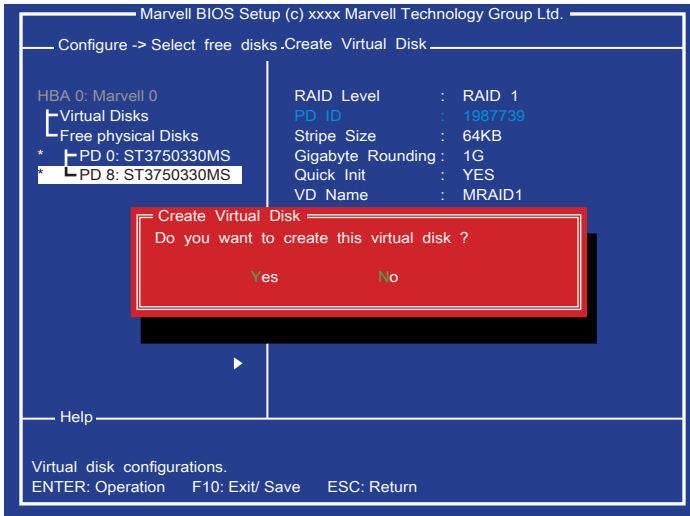

5. The creation is done. The virtual disk is now listed in [Topology] pane, as shown below.

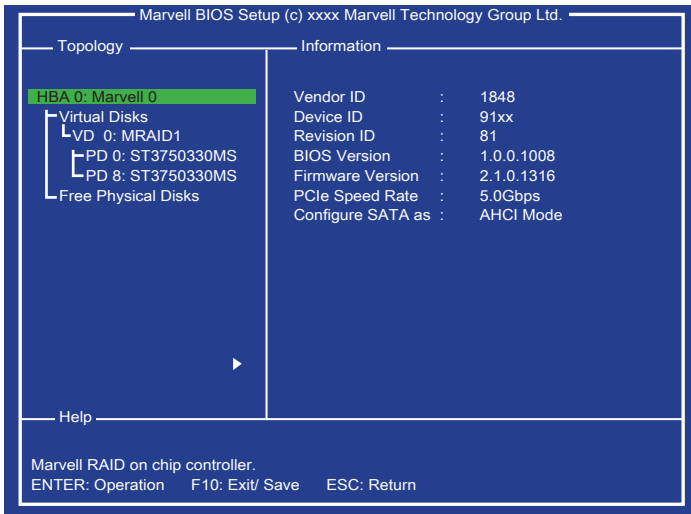

### Deleting Virtual Disk

This topic describes the procedure to delete a virtual disk by using the Marvell BIOS setup utility.

#### **Important**

Using "Delete" permanently erases all data on the virtual disk.

1. In the [Topology] pane, select "Virtual Disk" (VD 0: MRAID1, shown as below) and press Enter.
2. Select "Delete" to delete the virtual disk, shown as below.
3. Press Y to confirm the request when prompted **Do you want to delete this virtual disk?**
4. Press Y to confirm the request when prompted **Do you want to delete MBR from this virtual disk?**

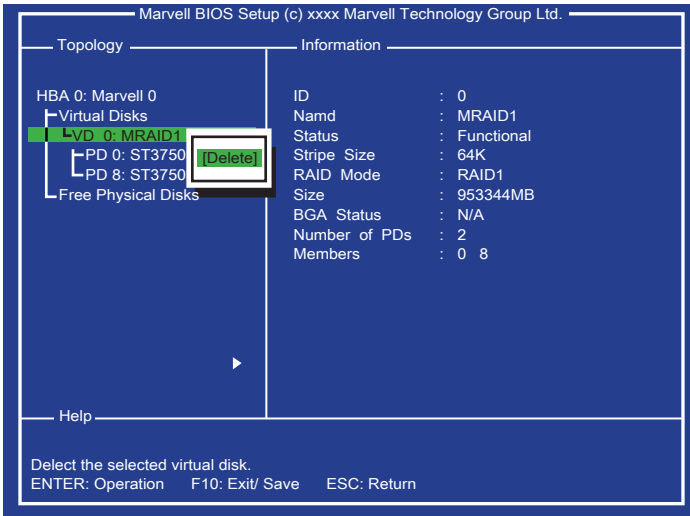



## Rebuilding Virtual Disk

This topic describes the procedure to manually rebuild a degraded virtual disk by using the Marvell BIOS setup utility. This is applicable to the RAID 1 virtual disk.

### **Important**

The rebuild process is both initiated and completed in the Marvell BIOS setup. The Marvell RAID Utility (MRU), which runs in an OS environment, cannot be used to either initiate, resume, or complete the rebuild process. Spare physical disks are not supported.

1. When a virtual disk is degraded, the “Status” of a virtual disk is changed from **Functional** to **Degrade**.
2. Replace the faulty physical disk with an identical physical disk. (Note: If an identical disk is unavailable, use a replacement physical disk of larger size or one with a slightly smaller size as determined by the Gigabyte Rounding setting for the virtual disk.) The BIOS detects the new physical disk and lists the device under “Free Physical Disks” in the [Topology] pane.
3. In the [Topology] pane, scroll to “Virtual Disk” (VD 0: XXXX), and press Enter to select. A menu pops-up as shown below. Scroll to “Rebuild” and press Enter to configure the rebuild process.

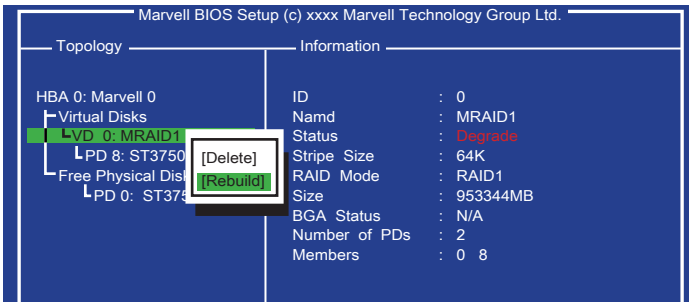

4. Scroll through the list of free disks, and press Space to select a replacement physical disk. Press Enter to continue.
5. Press Y to confirm the request when prompted **Do you want to rebuild with selected physical disk on this vd?**
6. The status of the rebuild process is reflected in the properties of the virtual disk.

## Installing the RAID Driver (for bootable RAID Array)

### **Important**

Only when you set the "AHCI" mode in Integrated Peripherals menu (the default is IDE mode) of mainboard BIOS setup, you have to install the RAID Driver for the SATA devices.

1. After you complete the RAID BIOS setup, boot from the Windows CD, and the Windows Setup program starts.
2. Press F6 and wait for the Windows Setup screen to appear.
3. Insert the floppy that contains the RAID driver, press the "S" key to select "Specify Additional Device".  
**Note:** for Windows Vista/ Windows 7, you can copy the files to a medium (floppy/ CD/ DVD or USB)

### **Important**

Please follow the instruction below to make a SATA RAID driver for yourself.

- Insert the MSI DVD into the DVD-ROM drive.
  - Click the "Browse CD" on the Setup screen.
  - Copy all the contents in the : \\RAID\Marvell9128 sp1116\miniport\Floppy32 or Floppy 64
  - The driver disk for RAID controller is done.
4. When prompted, insert the medium disk and press Enter.  
For Windows Vista/ Windows 7:  
During the Operating system installation, after selecting the location to install Vista/ Windows 7 click on "Load Driver" button to load RAID drive.
  5. You should be shown a list of available RAID controller(s).
  6. Select the compatible RAID controller for 32-bit/ 64-bit version system and then press ENTER.
  7. The next screen should confirm that you have selected the RAID controller. Press ENTER again to continue.
  8. You have successfully installed the RAID driver, and Windows setup should continue.
  9. Leave the medium until the system reboots itself. Windows setup will need to copy the files from the medium again after the RAID volume is formatted, and Windows setup starts copying files.

## Installing the RAID Driver Under Windows (for Non-bootable RAID Array)

1. Insert the MSI DVD into the DVD-ROM drive.
2. The DVD will auto-run and the setup screen will appear.
3. Under the Driver tab, click on Marvell 91XX SATA Driver.
4. The driver will be automatically installed.

