



# iNSPIRE iP3000

2,000 Watt Powered Column Loudspeaker with a 2 x 12" Subwoofer,  
18 Neodymium Drivers, KLARK TEKNIK Spatial Sound Technology,  
Digital Mixer, Remote Control via iPhone/iPad and  
Bluetooth Audio Streaming

## Quick Start Guide



EN

**EN Important Safety Instructions**

Terminals marked with this symbol carry electrical current of sufficient magnitude to constitute risk of electric shock.

Use only high-quality professional speaker cables with ¼" TS or twist-locking plugs pre-installed. All other installation or modification should be performed only by qualified personnel.



This symbol, wherever it appears, alerts you to the presence of uninsulated dangerous voltage inside the enclosure - voltage that may be sufficient to constitute a risk of shock.



This symbol, wherever it appears, alerts you to important operating and maintenance instructions in the accompanying literature. Please read the manual.

**Caution**

To reduce the risk of electric shock, do not remove the top cover (or the rear section). No user serviceable parts inside. Refer servicing to qualified personnel.

**Caution**

To reduce the risk of fire or electric shock, do not expose this appliance to rain and moisture. The apparatus shall not be exposed to dripping or splashing liquids and no objects filled with liquids, such as vases, shall be placed on the apparatus.

**Caution**

These service instructions are for use by qualified service personnel only. To reduce the risk of electric shock do not perform any servicing other than that contained in the operation instructions. Repairs have to be performed by qualified service personnel.

1. Read these instructions.
2. Keep these instructions.
3. Heed all warnings.
4. Follow all instructions.
5. Do not use this apparatus near water.
6. Clean only with dry cloth.
7. Do not block any ventilation openings. Install in accordance with the manufacturer's instructions.
8. Do not install near any heat sources such as radiators, heat registers, stoves, or other apparatus (including amplifiers) that produce heat.

9. Do not defeat the safety purpose of the polarized or grounding-type plug. A polarized plug has two blades with one wider than the other. A grounding-type plug has two blades and a third grounding prong. The wide blade or the third prong are provided for your safety. If the provided plug does not fit into your outlet, consult an electrician for replacement of the obsolete outlet.

10. Protect the power cord from being walked on or pinched particularly at plugs, convenience receptacles, and the point where they exit from the apparatus.

11. Use only attachments/accessories specified by the manufacturer.



12. Use only with the cart, stand, tripod, bracket, or table specified by the manufacturer, or sold with the apparatus. When a cart is used, use caution when moving the cart/apparatus combination to avoid

injury from tip-over.

13. Unplug this apparatus during lightning storms or when unused for long periods of time.

14. Refer all servicing to qualified service personnel. Servicing is required when the apparatus has been damaged in any way, such as power supply cord or plug is damaged, liquid has been spilled or objects have fallen into the apparatus, the apparatus has been exposed to rain or moisture, does not operate normally, or has been dropped.

15. The apparatus shall be connected to a MAINS socket outlet with a protective earthing connection.

16. Where the MAINS plug or an appliance coupler is used as the disconnect device, the disconnect device shall remain readily operable.



17. Correct disposal of this product: This symbol indicates that this product must not be disposed of with household waste, according to the WEEE Directive (2012/19/EU) and your national law. This product should be taken

to a collection center licensed for the recycling of waste electrical and electronic equipment (EEE). The mishandling of this type of waste could have a possible negative impact on the environment and human health due to potentially hazardous substances that are generally associated with EEE. At the same time, your cooperation in the correct disposal of this product will contribute to the efficient use of natural resources. For more information about where you can take your waste equipment for recycling, please contact your local city office, or your household waste collection service.

18. Do not install in a confined space, such as a book case or similar unit.

19. Do not place naked flame sources, such as lighted candles, on the apparatus.

20. Please keep the environmental aspects of battery disposal in mind. Batteries must be disposed of at a battery collection point.

21. Use this apparatus in tropical and/or moderate climates.

**LEGAL DISCLAIMER**

MUSIC Group accepts no liability for any loss which may be suffered by any person who relies either wholly or in part upon any description, photograph, or statement contained herein. Technical specifications, appearances and other information are subject to change without notice. All trademarks are the property of their respective owners. MIDAS, KLARK TEKNIK, LAB GRUPPEN, LAKE, TANNOY, TURBOSOUND, TC ELECTRONIC, TC HELICON, BEHRINGER, BUGERA and DDA are trademarks or registered trademarks of MUSIC Group IP Ltd. © MUSIC Group IP Ltd. 2017 All rights reserved.

**LIMITED WARRANTY**

For the applicable warranty terms and conditions and additional information regarding MUSIC Group's Limited Warranty, please see complete details online at [music-group.com/warranty](http://music-group.com/warranty).

**ES Instrucciones de seguridad**

Las terminales marcadas con este símbolo transportan corriente eléctrica de magnitud suficiente como para constituir un riesgo de descarga eléctrica. Utilice solo cables de altavoz profesionales y de alta calidad con conectores TS de 6,3 mm o de bayoneta prefijados. Cualquier otra instalación o modificación debe ser realizada únicamente por un técnico cualificado.



Este símbolo, siempre que aparece, le advierte de la presencia de voltaje peligroso sin aislar dentro de la caja; este voltaje puede ser suficiente para constituir un riesgo de descarga.



Este símbolo, siempre que aparece, le advierte sobre instrucciones operativas y de mantenimiento que aparecen en la documentación adjunta. Por favor, lea el manual.

**Atención**

Para reducir el riesgo de descarga eléctrica, no quite la tapa (o la parte posterior). No hay piezas en el interior del equipo que puedan ser reparadas por el usuario. Si es necesario, póngase en contacto con personal cualificado.

**Atención**

Para reducir el riesgo de incendio o descarga eléctrica, no exponga este aparato a la lluvia, humedad o alguna otra fuente que pueda salpicar o derramar algún líquido sobre el aparato. No coloque ningún tipo de recipiente para líquidos sobre el aparato.

**Atención**

Las instrucciones de servicio deben llevarlas a cabo exclusivamente personal cualificado. Para evitar el riesgo de una descarga eléctrica, no realice reparaciones que no se encuentren descritas en el manual de operaciones. Las reparaciones deben ser realizadas exclusivamente por personal cualificado.

1. Lea las instrucciones.
2. Conserve estas instrucciones.
3. Preste atención a todas las advertencias.
4. Siga todas las instrucciones.
5. No use este aparato cerca del agua.
6. Limpie este aparato con un paño seco.
7. No bloquee las aberturas de ventilación. Instale el equipo de acuerdo con las instrucciones del fabricante.
8. No instale este equipo cerca de fuentes de calor tales como radiadores, acumuladores de calor, estufas u otros aparatos (incluyendo amplificadores) que puedan producir calor.

9. No elimine o deshabilite nunca la conexión a tierra del aparato o del cable de alimentación de corriente. Un enchufe polarizado tiene dos polos, uno de los cuales tiene un contacto más ancho que el otro. Una clavija con puesta a tierra dispone de tres contactos: dos polos y la puesta a tierra. El contacto ancho y el tercer contacto, respectivamente, son los que garantizan una mayor seguridad. Si el enchufe suministrado con el equipo no concuerda con la toma de corriente, consulte con un electricista para cambiar la toma de corriente obsoleta.

10. Coloque el cable de suministro de energía de manera que no pueda ser pisado y que esté protegido de objetos afilados. Asegúrese de que el cable de suministro de energía esté protegido, especialmente en la zona de la clavija y en el punto donde sale del aparato.

11. Use únicamente los dispositivos o accesorios especificados por el fabricante.



12. Use únicamente la carretilla, plataforma, trípode, soporte o mesa especificados por el fabricante o suministrados junto con el equipo. Al transportar el equipo, tenga cuidado para evitar daños y caídas al tropezar con algún obstáculo.

13. Desenchufe el equipo durante tormentas o si no va a utilizarlo durante un periodo largo.

14. Confíe las reparaciones únicamente a servicios técnicos cualificados. La unidad requiere mantenimiento siempre que haya sufrido algún daño, si el cable de suministro de energía o el enchufe presentaran daños, se hubiera derramado un líquido o hubieran caído objetos dentro del equipo, si el aparato hubiera estado expuesto a la humedad o la lluvia, si ha dejado de funcionar de manera normal o si ha sufrido algún golpe o caída.

15. Al conectar la unidad a la toma de corriente eléctrica asegúrese de que la conexión disponga de una unión a tierra.

16. Si el enchufe o conector de red sirve como único medio de desconexión, éste debe ser accesible fácilmente.



17. Cómo debe deshacerse de este aparato: Este símbolo indica que este aparato no debe ser tratado como basura orgánica, según lo indicado en la Directiva WEEE (2012/19/EU) y a las normativas aplicables en su país.

En lugar de ello deberá llevarlo al punto limpio más cercano para el reciclaje de sus elementos eléctricos / electrónicos (EEE). Al hacer esto estará ayudando a prevenir las posibles consecuencias negativas para el medio ambiente y la salud que podrían ser provocadas por una gestión inadecuada de este tipo de aparatos. Además, el reciclaje de materiales ayudará a conservar los recursos naturales. Para más información acerca del reciclaje de este aparato, póngase en contacto con el Ayuntamiento de su ciudad o con el punto limpio local.

18. No instale esta unidad en un espacio muy reducido, tal como encastrada en una librería o similar.

19. No coloque objetos con llama, como una vela encendida, sobre este aparato.

20. Tenga presentes todas las advertencias relativas al reciclaje y correcta eliminación de las pilas. Las pilas deben ser siempre eliminadas en un punto limpio y nunca con el resto de la basura orgánica.

21. Use este aparato en rangos de temperatura moderados y/o tropicales.

**NEGACIÓN LEGAL**

MUSIC Group no admite ningún tipo de responsabilidad por cualquier daño o pérdida que pudiera sufrir cualquier persona por confiar total o parcialmente en la descripciones, fotografías o afirmaciones contenidas en este documento. Las especificaciones técnicas, imágenes y otras informaciones contenidas en este documento están sujetas a modificaciones sin previo aviso. Todas las marcas comerciales que aparecen aquí son propiedad de sus respectivos dueños. MIDAS, KLARK TEKNIK, LAB GRUPPEN, LAKE, TANNOY, TURBOSOUND, TC ELECTRONIC, TC HELICON, BEHRINGER, BUGERA y DDA son marcas comerciales o marcas registradas de MUSIC Group IP Ltd. © MUSIC Group IP Ltd. 2017 Reservados todos los derechos.

**GARANTÍA LIMITADA**

Si quiere conocer los detalles y condiciones aplicables de la garantía así como información adicional sobre la Garantía limitada de MUSIC Group, consulte online toda la información en la web [music-group.com/warranty](http://music-group.com/warranty).

EN

ES

**FR** Consignes de sécurité

 Les points repérés par ce symbole portent une tension électrique suffisante pour constituer un risque d'électrocution.

Utilisez uniquement des câbles d'enceintes professionnels de haute qualité avec fiches Jack mono 6,35 mm ou fiches à verrouillages déjà installées. Toute autre installation ou modification doit être effectuée uniquement par un personnel qualifié.

 Ce symbole avertit de la présence d'une tension dangereuse et non isolée à l'intérieur de l'appareil - elle peut provoquer des chocs électriques.

 **Attention**  
Ce symbole signale les consignes d'utilisation et d'entre ! Tien importantes dans la documentation fournie. Lisez les consignes de sécurité du manuel d'utilisation de l'appareil.

 **Attention**  
Pour éviter tout risque de choc électrique, ne pas ouvrir le capot de l'appareil ni démonter le panneau arrière. L'intérieur de l'appareil ne possède aucun élément réparable par l'utilisateur. Laisser toute réparation à un professionnel qualifié.

 **Attention**  
Pour réduire les risques de feu et de choc électrique, n'exposez pas cet appareil à la pluie, à la moisissure, aux gouttes ou aux éclaboussures. Ne posez pas de récipient contenant un liquide sur l'appareil (un vase par exemple).

 **Attention**  
Ces consignes de sécurité et d'entretien sont destinées à un personnel qualifié. Pour éviter tout risque de choc électrique, n'effectuez aucune réparation sur l'appareil qui ne soit décrite par le manuel d'utilisation. Les éventuelles réparations doivent être effectuées uniquement par un technicien spécialisé.

1. Lisez ces consignes.
2. Conservez ces consignes.
3. Respectez tous les avertissements.
4. Respectez toutes les consignes d'utilisation.
5. N'utilisez jamais l'appareil à proximité d'un liquide.
6. Nettoyez l'appareil avec un chiffon sec.
7. Veillez à ne pas empêcher la bonne ventilation de l'appareil via ses ouïes de ventilation. Respectez les consignes du fabricant concernant l'installation de l'appareil.
8. Ne placez pas l'appareil à proximité d'une source de chaleur telle qu'un chauffage, une cuisinière ou tout appareil dégageant de la chaleur (y compris un ampli de puissance).

9. Ne supprimez jamais la sécurité des prises bipolaires ou des prises terre. Les prises bipolaires possèdent deux contacts de largeur différente. Le plus large est le contact de sécurité. Les prises terre possèdent deux contacts plus une mise à la terre servant de sécurité. Si la prise du bloc d'alimentation ou du cordon d'alimentation fourni ne correspond pas à celles de votre installation électrique, faites appel à un électricien pour effectuer le changement de prise.

10. Installez le cordon d'alimentation de telle façon que personne ne puisse marcher dessus et qu'il soit protégé d'arêtes coupantes. Assurez-vous que le cordon d'alimentation est suffisamment protégé, notamment au niveau de sa prise électrique et de l'endroit où il est relié à l'appareil; cela est également valable pour une éventuelle rallonge électrique.

11. Utilisez exclusivement des accessoires et des appareils supplémentaires recommandés par le fabricant.



12. Utilisez exclusivement des chariots, des diables, des présentoirs, des pieds et des surfaces de travail recommandés par le fabricant ou livrés avec le produit.

Déplacez précautionneusement tout chariot ou diable chargé pour éviter d'éventuelles blessures en cas de chute.

13. Débranchez l'appareil de la tension secteur en cas d'orage ou si l'appareil reste inutilisé pendant une longue période de temps.

14. Les travaux d'entretien de l'appareil doivent être effectués uniquement par du personnel qualifié. Aucun entretien n'est nécessaire sauf si l'appareil est endommagé de quelque façon que ce soit (dommages sur le cordon d'alimentation ou la prise par exemple), si un liquide ou un objet a pénétré à l'intérieur du châssis, si l'appareil a été exposé à la pluie ou à l'humidité, s'il ne fonctionne pas correctement ou à la suite d'une chute.

15. L'appareil doit être connecté à une prise secteur dotée d'une protection par mise à la terre.

16. La prise électrique ou la prise IEC de tout appareil dénué de bouton marche/arrêt doit rester accessible en permanence.

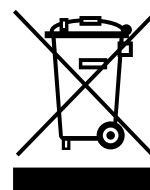

17. Mise au rebut appropriée de ce produit: Ce symbole indique qu'en accord avec la directive DEEE (2012/19/EU) et les lois en vigueur dans votre pays, ce produit ne doit pas être jeté avec les déchets ménagers. Ce produit doit être

déposé dans un point de collecte agréé pour le recyclage des déchets d'équipements électriques et électroniques (EEE). Une mauvaise manipulation de ce type de déchets pourrait avoir un impact négatif sur l'environnement et la santé à cause des substances potentiellement dangereuses généralement associées à ces équipements. En même temps, votre coopération dans la mise au rebut de ce produit contribuera à l'utilisation efficace des ressources naturelles. Pour plus d'informations sur l'endroit où vous pouvez déposer vos déchets

d'équipements pour le recyclage, veuillez contacter votre mairie ou votre centre local de collecte des déchets.

18. N'installez pas l'appareil dans un espace confiné tel qu'une bibliothèque ou meuble similaire.

19. Ne placez jamais d'objets enflammés, tels que des bougies allumées, sur l'appareil.

20. Gardez à l'esprit l'impact environnemental lorsque vous mettez des piles au rebus. Les piles usées doivent être déposées dans un point de collecte adapté.

21. Utilisez l'appareil dans un climat tropical et/ou modéré.

**DÉNI LÉGAL**

MUSIC Group ne peut être tenu pour responsable pour toute perte pouvant être subie par toute personne se fiant en partie ou en totalité à toute description, photographie ou affirmation contenue dans ce document. Les caractéristiques, l'apparence et d'autres informations peuvent faire l'objet de modifications sans notification. Toutes les marques appartiennent à leurs propriétaires respectifs. MIDAS, KLARK TEKNIK, LAB GRUPPEN, LAKE, TANNOY, TURBOSOUND, TC ELECTRONIC, TC HELICON, BEHRINGER, BUGERA et DDA sont des marques ou marques déposées de MUSIC Group IP Ltd. © MUSIC Group IP Ltd. 2017 Tous droits réservés.

**GARANTIE LIMITÉE**

Pour connaître les termes et conditions de garantie applicables, ainsi que les informations supplémentaires et détaillées sur la Garantie Limitée de MUSIC Group, consultez le site Internet [music-group.com/warranty](http://music-group.com/warranty).

**DE** Wichtige Sicherheitshinweise

 **Vorsicht**  
Die mit dem Symbol markierten Anschlüsse führen so viel Spannung, dass die Gefahr eines Stromschlags besteht.

Verwenden Sie nur hochwertige, professionelle Lautsprecherkabel mit vorinstallierten 6,35 mm MONO-Klinkensteckern oder Lautsprecherstecker mit Drehverriegelung. Alle anderen Installationen oder Modifikationen sollten nur von qualifiziertem Fachpersonal ausgeführt werden.

 **Achtung**  
Um eine Gefährdung durch Stromschlag auszuschließen, darf die Geräteabdeckung bzw. Geräterückwand nicht abgenommen werden. Im Innern des Geräts befinden sich keine vom Benutzer reparierbaren Teile. Reparaturarbeiten dürfen nur von qualifiziertem Personal ausgeführt werden.

 **Achtung**  
Um eine Gefährdung durch Feuer bzw. Stromschlag auszuschließen, darf dieses Gerät weder Regen oder Feuchtigkeit ausgesetzt werden noch sollten Spritzwasser oder tropfende Flüssigkeiten in das Gerät gelangen können. Stellen Sie keine mit Flüssigkeit gefüllten Gegenstände, wie z. B. Vasen, auf das Gerät.

 **Achtung**  
Die Service-Hinweise sind nur durch qualifiziertes Personal zu befolgen. Um eine Gefährdung durch Stromschlag zu vermeiden, führen Sie bitte keinerlei Reparaturen an dem Gerät durch, die nicht in der Bedienungsanleitung beschrieben sind. Reparaturen sind nur von qualifiziertem Fachpersonal durchzuführen.

1. Lesen Sie diese Hinweise.
2. Bewahren Sie diese Hinweise auf.
3. Beachten Sie alle Warnhinweise.
4. Befolgen Sie alle Bedienungshinweise.
5. Betreiben Sie das Gerät nicht in der Nähe von Wasser.
6. Reinigen Sie das Gerät mit einem trockenen Tuch.
7. Blockieren Sie nicht die Belüftungsschlitze. Beachten Sie beim Einbau des Gerätes die Herstellerhinweise.
8. Stellen Sie das Gerät nicht in der Nähe von Wärmequellen auf. Solche Wärmequellen sind z. B. Heizkörper, Herde oder andere Wärme erzeugende Geräte (auch Verstärker).
9. Entfernen Sie in keinem Fall die Sicherheitsvorrichtung von Zweipol- oder geerdeten Steckern. Ein Zweipolstecker hat zwei unterschiedlich breite Steckkontakte. Ein geerdeter Stecker hat zwei Steckkontakte und einen dritten Erdungskontakt. Der breitere Steckkontakt oder der zusätzliche

Erdungskontakt dient Ihrer Sicherheit. Falls das mitgelieferte Steckerformat nicht zu Ihrer Steckdose passt, wenden Sie sich bitte an einen Elektriker, damit die Steckdose entsprechend ausgetauscht wird.

10. Verlegen Sie das Netzkabel so, dass es vor Tritten und scharfen Kanten geschützt ist und nicht beschädigt werden kann. Achten Sie bitte insbesondere im Bereich der Stecker, Verlängerungskabel und an der Stelle, an der das Netzkabel das Gerät verlässt, auf ausreichenden Schutz.

11. Das Gerät muss jederzeit mit intaktem Schutzleiter an das Stromnetz angeschlossen sein.

12. Sollte der Hauptnetzstecker oder eine Gerätesteckdose die Funktionseinheit zum Abschalten sein, muss diese immer zugänglich sein.

13. Verwenden Sie nur Zusatzgeräte/Zubehörteile, die laut Hersteller geeignet sind.



14. Verwenden Sie nur Wagen, Standvorrichtungen, Stative, Halter oder Tische, die vom Hersteller benannt oder im Lieferumfang des Geräts enthalten sind. Falls Sie einen

Wagen benutzen, seien Sie vorsichtig beim Bewegen der Wagen-Gerätkombination, um Verletzungen durch Stolpern zu vermeiden.

15. Ziehen Sie den Netzstecker bei Gewitter oder wenn Sie das Gerät längere Zeit nicht benutzen.

16. Lassen Sie alle Wartungsarbeiten nur von qualifiziertem Service-Personal ausführen. Eine Wartung ist notwendig, wenn das Gerät in irgendeiner Weise beschädigt wurde (z. B. Beschädigung des Netzkabels oder Steckers), Gegenstände oder Flüssigkeit in das Geräteinnere gelangt sind, das Gerät Regen oder Feuchtigkeit ausgesetzt wurde, das Gerät nicht ordnungsgemäß funktioniert oder auf den Boden gefallen ist.



17. Korrekte Entsorgung dieses Produkts: Dieses Symbol weist darauf hin, das Produkt entsprechend der WEEE Richtlinie (2012/19/EU) und der jeweiligen nationalen Gesetze nicht zusammen mit Ihren

Haushaltsabfällen zu entsorgen. Dieses Produkt sollte bei einer autorisierten Sammelstelle für Recycling elektrischer und elektronischer Geräte (EEE) abgegeben werden. Wegen bedenkllicher Substanzen, die generell mit elektrischen und elektronischen Geräten in Verbindung stehen, könnte eine unsachgemäße Behandlung dieser Abfallart eine negative Auswirkung auf Umwelt und Gesundheit haben. Gleichzeitig gewährleistet Ihr Beitrag zur richtigen Entsorgung dieses Produkts die effektive Nutzung natürlicher Ressourcen. Für weitere Informationen zur Entsorgung Ihrer Geräte bei einer Recycling-Stelle nehmen Sie bitte Kontakt zum zuständigen städtischen Büro, Entsorgungsamt oder zu Ihrem Haushaltsabfallentsorger auf.

18. Installieren Sie das Gerät nicht in einer beengten Umgebung, zum Beispiel Bücherregal oder ähnliches.

19. Stellen Sie keine Gegenstände mit offenen Flammen, etwa brennende Kerzen, auf das Gerät.

20. Beachten Sie bei der Entsorgung von Batterien den Umweltschutz-Aspekt. Batterien müssen bei einer Batterie-Sammelstelle entsorgt werden.

21. Verwenden Sie das Gerät in tropischen und/oder gemäßigten Klimazonen.

**HAFTUNGSAUSSCHLUSS**

MUSIC Group übernimmt keine Haftung für Verluste, die Personen entstanden sind, die sich ganz oder teilweise auf hier enthaltene Beschreibungen, Fotos oder Aussagen verlassen haben. Technische Daten, Erscheinungsbild und andere Informationen können ohne vorherige Ankündigung geändert werden. Alle Warenzeichen sind Eigentum der jeweiligen Inhaber. MIDAS, KLARK TEKNIK, LAB GRUPPEN, LAKE, TANNOY, TURBOSOUND, TC ELECTRONIC, TC HELICON, BEHRINGER, BUGERA und DDA sind Warenzeichen oder eingetragene Warenzeichen der MUSIC Group IP Ltd. © MUSIC Group IP Ltd. 2017 Alle Rechte vorbehalten.

**BESCHRÄNKTE GARANTIE**

Die geltenden Garantiebedingungen und zusätzliche Informationen bezüglich der von MUSIC Group gewährten beschränkten Garantie finden Sie online unter [music-group.com/warranty](http://music-group.com/warranty).

## PT Instruções de Segurança Importantes



**Aviso!**  
Terminais marcados com o símbolo carregam corrente elétrica de magnitude suficiente para constituir um risco de choque elétrico. Use apenas cabos de alto-falantes de alta qualidade com plugues TS de ¼" ou plugues com trava de torção pré-instalados. Todas as outras instalações e modificações devem ser efetuadas por pessoas qualificadas.

Este símbolo, onde quer que o encontre, alerta-o para a leitura das instruções de manuseamento que acompanham o equipamento. Por favor leia o manual de instruções.

**Atenção**  
De forma a diminuir o risco de choque elétrico, não remover a cobertura (ou a secção de trás). Não existem peças substituíveis por parte do utilizador no seu interior. Para esse efeito recorrer a um técnico qualificado.

**Atenção**  
Para reduzir o risco de incêndios ou choques elétricos o aparelho não deve ser exposto à chuva nem à humidade. Além disso, não deve ser sujeito a salpicos, nem devem ser colocados em cima do aparelho objectos contendo líquidos, tais como jarras.

**Atenção**  
Estas instruções de operação devem ser utilizadas, em exclusivo, por técnicos de assistência qualificados. Para evitar choques elétricos não proceda a reparações ou intervenções, que não as indicadas nas instruções de operação, salvo se possuir as qualificações necessárias. Para evitar choques elétricos não proceda a reparações ou intervenções, que não as indicadas nas instruções de operação. Só o deverá fazer se possuir as qualificações necessárias.

1. Leia estas instruções.
2. Guarde estas instruções.
3. Preste atenção a todos os avisos.
4. Siga todas as instruções.
5. Não utilize este dispositivo perto de água.
6. Limpe apenas com um pano seco.
7. Não obstrua as entradas de ventilação. Instale de acordo com as instruções do fabricante.
8. Não instale perto de quaisquer fontes de calor tais como radiadores, bocas de ar quente, fogões de sala ou outros aparelhos (incluindo amplificadores) que produzam calor.
9. Não anule o objectivo de segurança das fichas polarizadas ou do tipo de ligação à terra. Uma ficha polarizada dispõe de duas palhetas sendo uma mais larga do que a outra. Uma ficha do tipo ligação à terra dispõe

de duas palhetas e um terceiro dente de ligação à terra. A palheta larga ou o terceiro dente são fornecidos para sua segurança. Se a ficha fornecida não encaixar na sua tomada, consulte um electricista para a substituição da tomada obsoleta.

10. Proteja o cabo de alimentação de pisadelas ou apertos, especialmente nas fichas, extensões, e no local de saída da unidade. Certifique-se de que o cabo eléctrico está protegido. Verifique particularmente nas fichas, nos receptáculos e no ponto em que o cabo sai do aparelho.

11. O aparelho tem de estar sempre conectado à rede eléctrica com o condutor de protecção intacto.

12. Se utilizar uma ficha de rede principal ou uma tomada de aparelhos para desligar a unidade de funcionamento, esta deve estar sempre acessível.

13. Utilize apenas ligações/acessórios especificados pelo fabricante.



14. Utilize apenas com o carrinho, estrutura, tripé, suporte, ou mesa especificados pelo fabricante ou vendidos com o dispositivo. Quando utilizar um carrinho, tenha cuidado ao

mover o conjunto carrinho/dispositivo para evitar danos provocados pela terpidação.

15. Desligue este dispositivo durante as trovoadas ou quando não for utilizado durante longos períodos de tempo.

16. Qualquer tipo de reparação deve ser sempre efectuado por pessoal qualificado. É necessária uma reparação sempre que a unidade tiver sido de alguma forma danificada, como por exemplo: no caso do cabo de alimentação ou ficha se encontrarem danificados; na eventualidade de líquido ter sido derramado ou objectos terem caído para dentro do dispositivo; no caso da unidade ter estado exposta à chuva ou à humidade; se esta não funcionar normalmente, ou se tiver caído.



17. Correcta eliminação deste produto: este símbolo indica que o produto não deve ser eliminado juntamente com os resíduos domésticos, segundo a Directiva REEE (2012/19/EU) e a legislação nacional. Este produto deverá

ser levado para um centro de recolha licenciado para a reciclagem de resíduos de equipamentos eléctricos e electrónicos (EEE). O tratamento incorrecto deste tipo de resíduos pode ter um eventual impacto negativo no ambiente e na saúde humana devido a substâncias potencialmente perigosas que estão geralmente associadas aos EEE. Ao mesmo tempo, a sua colaboração para a eliminação correcta deste produto irá contribuir para a utilização eficiente dos recursos naturais. Para mais informação acerca dos locais onde poderá deixar o seu equipamento usado para reciclagem, é favor contactar os serviços municipais locais, a entidade de gestão de resíduos ou os serviços de recolha de resíduos domésticos.

18. Não instale em lugares confinados, tais como estantes ou unidades similares.

19. Não coloque fontes de chama, tais como velas acesas, sobre o aparelho.

20. Favor, obedecer os aspectos ambientais de descarte de bateria. Baterias devem ser descartadas em um ponto de coletas de baterias.

21. Use este aparelho em climas tropicais e/ou moderados.

## LEGAL RENUNCIANTE

O MUSIC Group não se responsabiliza por perda alguma que possa ser sofrida por qualquer pessoa que dependa, seja de maneira completa ou parcial, de qualquer descrição, fotografia, ou declaração aqui contidas. Dados técnicos, aparências e outras informações estão sujeitas a modificações sem aviso prévio. Todas as marcas são propriedade de seus respectivos donos. MIDAS, KLARK TEKNIK, LAB GRUPPEN, LAKE, TANNOY, TURBOSOUND, TC ELECTRONIC, TC HELICON, BEHRINGER, BUGERA e DDA são marcas ou marcas registradas do MUSIC Group IP Ltd. © MUSIC Group IP Ltd. 2017 Todos direitos reservados.

## GARANTIA LIMITADA

Para obter os termos de garantia aplicáveis e condições e informações adicionais a respeito da garantia limitada do MUSIC Group, favor verificar detalhes na íntegra através do website [music-group.com/warranty](http://music-group.com/warranty).

## JP 安全にお使いいただくために



**注意**  
感電の恐れがありますので、カバーやその他の部品を取り外したり、開けたりしないでください。高品質なプロ用スピーカーケーブル (¼" TS 標準ケーブルおよびツイスト ロッキング プラグケーブル) を使用してください。

**注意**  
火事および感電の危険を防ぐため、本装置を水分や湿気のあるところには設置しないで下さい。装置には決して水分がかからないように注意し、花瓶など水分を含んだものは、装置の上には置かないようにしてください。

**注意**  
このマークが表示されている箇所には、内部に高圧電流が生じています。手を触れると感電の恐れがあります。

**注意**  
取り扱いとお手入れの方法についての重要な説明が付属の取扱説明書に記載されています。ご使用前に良くお読みください。

- 注意**
1. 取扱説明書を通してご覧ください。
  2. 取扱説明書を大切に保管してください。
  3. 警告に従ってください。
  4. 指示に従ってください。
  5. 本機を水の近くで使用しないでください。
  6. お手入れの際は常に乾燥した布巾を使ってください。
  7. 本機は、取扱説明書の指示に従い、適切な換気を妨げない場所に設置してください。取扱説明書に従って設置してください。
  8. 本機は、電気ヒーターや温風機器、ストーブ、調理台やアンプといった熱源から離して設置してください。

9. 二極式プラグおよびアースタイプ (三芯) プラグの安全ピンは取り外さないでください。二極式プラグにはピンが二本ついており、そのうち一本はもう一方よりも幅が広がっています。アースタイプの三芯プラグには二本のピンに加えてアース用のピンが一本ついています。これらの幅の広いピン、およびアースピンは、安全のためのものです。備え付けのプラグが、お使いのコンセントの形状と異なる場合は、電器技師に相談してコンセントの交換をして下さい。

10. 電源コードを踏みつけたり、挟んだりしないようご注意ください。電源コードやプラグ、コンセント及び製品との接続には十分にご注意ください。

11. すべての装置の接地 (アース) が確保されていることを確認して下さい。



12. 電源タップや電源プラグは電源遮断機として利用されている場合には、これが直ぐに操作できるように手元に設置して下さい。

13. 付属品は本機製造元が指定したもののみをお使いください。

14. カートスタンド、三脚、ブラケット、テーブルなどは、本機製造元が指定したものの、もしくは本機の付属品となるもののみをお使いください。カートを使用時の運搬の際は、器具の落下による怪我に十分ご注意ください。

15. 雷雨の場合、もしくは長期間ご使用にならない場合は、電源プラグをコンセントから抜いてください。

16. 故障の際は当社指定のサービス技術者にお問い合わせください。電源コードもしくはプラグの損傷、液体の装置内への浸入、装置の上に物が落下した場合、雨や湿気に装置が晒されてしまった場合、正常に作動しない場合、もしくは装置を地面に落下させてしまった場合など、いかなる形であれ装置に損傷が加わった場合は、装置の修理・点検を受けてください。

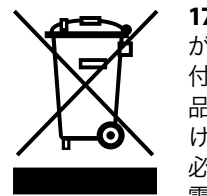

17. 本製品に電源コードが付属されている場合、付属の電源コードは本製品以外ではご使用いただけません。電源コードは必ず本製品に付属された電源コードのみご使用ください。

18. ブックケースなどのような、閉じたスペースには設置しないでください。

19. 本機の上に点火した蝋燭などの裸火を置かないでください。

20. 電池廃棄の際には、環境へのご配慮をお願いします。電池は、かならず電池回収場所に廃棄してください。

21. 本機器は熱帯気候および / または温帯気候下でご使用ください。

## 法的放棄

ここに含まれる記述、写真、意見の全体または一部に依拠して、いかなる人が損害を生じさせた場合にも、MUSIC Groupは一切の賠償責任を負いません。技術仕様、外観およびその他の情報は予告なく変更になる場合があります。商標はすべて、それぞれの所有者に帰属します。MIDAS, KLARK TEKNIK, LAB GRUPPEN, LAKE, TANNOY, TURBOSOUND, TC ELECTRONIC, TC HELICON, BEHRINGER, BUGERA および DDA は MUSIC Group IP Ltd. の商標または登録商標です。© MUSIC Group IP Ltd. 2017 無断転用禁止。

## 限定保証

適用される保証条件と MUSIC Group の限定保証に関する概要については、オンライン上 [music-group.com/warranty](http://music-group.com/warranty) にて詳細をご確認ください。

**CN** 其他的重要信息

 带有此标志的终端设备具有强大的电流, 存在触电危险。仅限使用带有 ¼" TS 或扭锁式插头的高品质专业扬声器线。所有的安装或调整均须由合格的专业人员进行。

 此标志提醒您, 产品内存在未绝缘的危险电压, 有触电危险。

 此标志提醒您查阅所附的重要的使用及维修说明。请阅读有关手册。

 **小心**  
为避免触电危险, 请勿打开机顶盖 (或背面挡板)。设备内没有可供用户维修使用的部件。请将维修事项交由合格的专业人员进行。

 **小心**  
为避免着火或触电危险, 请勿将此设备置于雨淋或潮湿中。此设备也不可受液体滴溅, 盛有液体的容器也不可置于其上, 如花瓶等。

 **小心**  
维修说明仅是给合格的专业维修人员使用的。为避免触电危险, 除了使用说明书提到的以外, 请勿进行任何其它维修。所有维修均须由合格的专业人员进行。

1. 请阅读这些说明。
2. 请妥善保存这些说明。
3. 请注意所有的警示。
4. 请遵守所有的说明。
5. 请勿在靠近水的地方使用本产品。
6. 请用干布清洁本产品。
7. 请勿堵塞通风口。安装本产品时请遵照厂家的说明。
8. 请勿将本产品安装在热源附近, 如暖气片, 炉子或其它产生热量的设备 (包括功放器)。
9. 请勿移除极性插头或接地插头的安全装置。接地插头是由两个插塞接点及一个接地头构成。若随货提供的插头不适合您的插座, 请找电工更换一个合适的插座。
10. 妥善保护电源线, 使其不被践踏或刺破, 尤其注意电源插头、多用途插座及设备连接处。

11. 请只使用厂家指定的附属设备和配件。



12. 请只使用厂家指定的或随货销售的手推车, 架子, 三角架, 支架和桌子。若使用手推车来搬运设备, 请注意安全放置设备, 以避免手推车和设备

倾倒而受伤。

13. 遇闪电雷鸣或长期不使用本设备时, 请拔出电源插头。

14. 所有维修均须由合格的维修人员进行。设备受损时需进行维修, 例如电源线或电源插头受损, 液体流入或异物落入设备内, 设备遭雨淋或受潮, 设备不能正常运作或被摔坏。

15. 本设备连接电源时一定要接地保护。

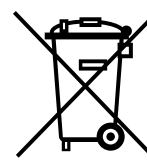

16. 若电源插头或器具耦合器用作断电装置, 应当保证它们处于随时可方便操作状态。

17. 本产品仅适用于海拔 2000 米以下地区, 本产品仅适用于非热带气候条件下。

**法律声明**

对于任何因在此说明书提到的全部或部份描述、图片或声明而造成的损失, MUSIC Group 不负任何责任。技术参数和外观若有更改, 恕不另行通知。所有的商标均为其各自所有者的财产。MIDAS, KLARK TEKNIK, LAB GRUPPEN, LAKE, TANNOY, TURBOSOUND, TC ELECTRONIC, TC HELICON, BEHRINGER, BUGERA 和 DDA 是 MUSIC Group IP Ltd. 公司的商标或注册商标。© MUSIC Group IP Ltd. 2017 版权所有。

**保修条款**

有关音乐集团保修的适用条款及其它相关信息, 请登陆 [music-group.com/warranty](http://music-group.com/warranty) 网站查看完整的详细信息。

Thank you for choosing a TURBOSOUND loudspeaker product for your application. If you would like further information about this or any other TURBOSOUND product, please visit our website at [turbosound.com](http://turbosound.com).

**Unpacking the Loudspeaker**

After unpacking the unit please check carefully for damage. If damage is found, please notify your supplier at once. You, the consignee, must instigate any claim. Please retain all packaging in case of future re-shipment.

For iP3000, covers and shoulder bags are available separately.

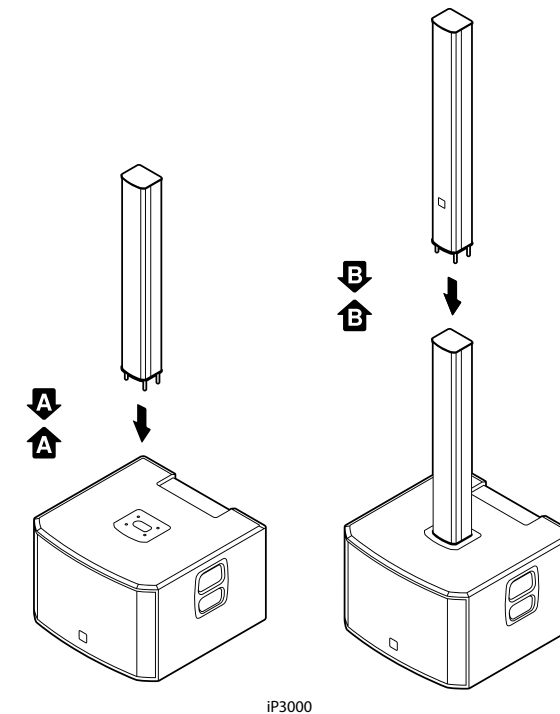
**Assembly**

iP3000 speakers ship with separate base and column elements that will need to be assembled.

To assemble the speakers, follow these steps:

1. Make sure the unit is switched off.
2. Place the base unit onto a firm, level surface, with the column connection inputs facing upward.
3. Align the speaker column over the base unit's connection inputs with the column connectors facing downward.
4. Lower the speaker column into the connection input and gently press downward until the column connectors slot into place.

**Note:** iP3000 features a 2-piece column assembly. Connect the lower column assembly to the base unit first, and then connect the upper column segment directly on top of the lower segment.

Once the column assembly is firmly slotted into place, the iP speakers will automatically make all power and audio connections between the base unit and the speaker column.

# Controls

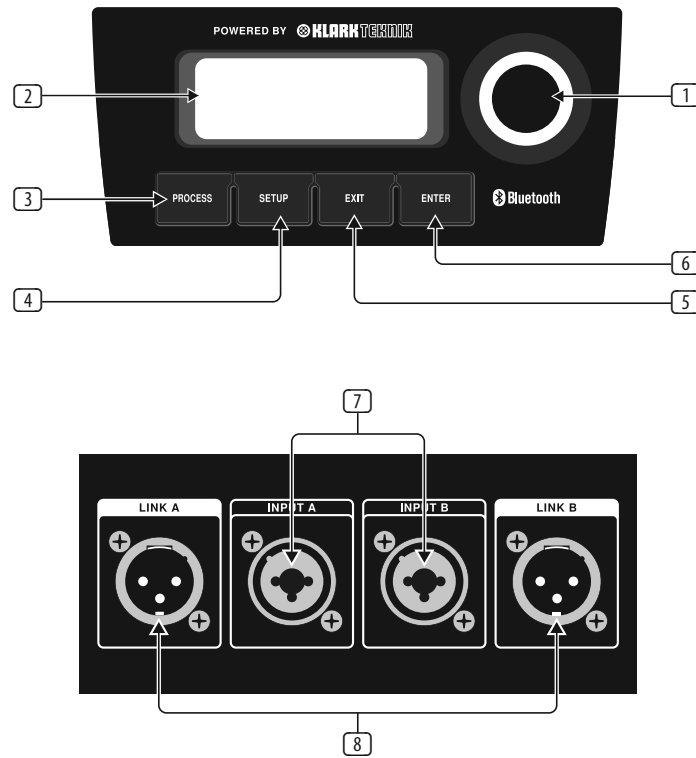

- 1 **ENCODER KNOB** toggles between Graphic and Edit modes (when pressed) and changes parameter values (when rotated).
- 2 **LCD SCREEN** displays the current DSP module and parameter settings.
- 3 **PROCESS** button accesses the DSP signal processing menu.
- 4 **SETUP** accesses the setup features menu.
- 5 **EXIT** button saves changes and returns to the previous menu screen.
- 6 **ENTER** button selects sub-menu or confirms parameter changes.
- 7 **INPUT A/INPUT B** combo jacks accept input signals using XLR, balanced ¼" TRS or unbalanced ¼" TS connectors.
- 8 **LINK A/LINK B XLR** connectors provide un-processed copies of the INPUT A or INPUT B signals.

# iP DSP Menu Structure

Menu	Sub-Menu	Fullrange	Function
		<b>Main Screen</b>	Displays level indicators and model name. Displays the following Bluetooth* status information: <ul style="list-style-type: none"> <li>Bluetooth symbol indicates connection to audio and remote control device (iPhone*, etc.).</li> <li>"M" or "S" below the Bluetooth symbol indicate that the speaker is linked to another iP speaker as MASTER (left channel, "M") or SLAVE (right channel, "S").</li> </ul> Rotate the encoder knob to adjust the output volume. Press the encoder knob enter the last used sub-menu. Press the Process and Setup buttons to access sub-menus.
		<b>Volume</b>	Rotate the encoder to change the output volume.
		<b>MODE</b>	Selects from 4 preset equalisations, depending on function and music type.
		<b>INPUT</b>	Sets input mixer gain for analogue input A and B, as well as Bluetooth.
		<b>EQ (Equalisation)</b>	Allows adjustment of three band equaliser control, bass, midrange and treble.
		<b>POSIT. (Position)</b>	Selects DSP compensation depending on the speaker position: corner, wall or floor.
		<b>BT (Bluetooth)</b>	Lets you pair the speaker with mobile Bluetooth devices and link to another iP speaker as master / slave.
		<b>SUBWOOFER</b>	Allows control of subwoofer relative level.
		<b>SETUP</b>	Sets LCD back panel contrast, device lock and factory reset.
		<b>INFO</b>	Displays model and firmware information.

\*iPhone is a trademark of Apple Inc. The Bluetooth word mark and logos are registered trademarks owned by Bluetooth SIG, Inc. and any use of such marks is under license.

## iP Series Analogue Connection

Despite their sophistication, iP speakers offer straightforward analogue connectivity, and you can easily arrange the iP system to allow simple control of levels from other devices, such as mixers. You can also daisy-chain multiple iP speakers using only the analogue connections, and then directly control the overall level from your mixer's master fader.

For example, you have four iP speakers and a mixer with simple left-right stereo outputs. For typical operation, set the DSP volume and input gain settings on all speakers to a flat "0 dB" setting. Connect the mixer's left and right stereo outputs to the first two speakers' analogue INPUT A connections (the left and right mixer outputs will go to separate speakers). Then, run cables from the OUTPUT analogue connections to the remaining two speakers. In a similar way, subwoofers can also be linked to the analogue OUTPUT.

## EN iP Series Bluetooth Instructions

### Bluetooth Connection

To play audio from a Bluetooth-enabled device, you will need at least one iP speaker and an iPad\*/iPhone/Android\*/Windows\* device with basic Bluetooth connectivity. With a basic Bluetooth connection, all related iP DSP functions must still be controlled directly from the iP rear panel via the rotary encoder.

For Apple\* iOS devices, you can also download a dedicated TURBOSOUND iP Bluetooth app from the App Store. This iP Bluetooth app allows you to control a single or stereo pair of iP speakers, including all DSP functions, remotely from your iOS device (see "Bluetooth Control" below for more information).

### Bluetooth Streaming

To stream Bluetooth audio with any Bluetooth device (iPad/iPhone/Android/Windows, etc.)

#### Mono operation

1. Enable Bluetooth on your remote device.
  2. Switch on your iP speaker and minimize the volume.
  3. Select "Pair device" from the iP speaker's Bluetooth menu.
- 
4. Check that your remote device is searching for a connection.
  5. Once your device detects the iP speaker, select the iP speaker from your remote device's menu (e.g., "TURBOSOUND iP2000").
  6. Wait until the remote device shows an active connection, and then check the speaker's Bluetooth menu, which should display the name of the remote device (e.g., "HUAWEI P7-L07").



7. Bluetooth music can now be streamed to your iP speaker. The stereo signal will automatically mix down to mono.
8. The iP speaker will display the Bluetooth indicator on the main, top-level DSP screen.



#### Stereo operation

1. Complete the steps above to connect the first speaker to Bluetooth audio.
  2. The first connected speaker automatically becomes the MASTER speaker.
  3. Switch on the second speaker, which becomes the SLAVE speaker.
  4. Select "Link speaker" from the SLAVE speaker's Bluetooth menu.
- 
5. The SLAVE speaker will display "Slave linking..."
  6. Select "Link speaker" from the MASTER speaker's Bluetooth menu.
  7. The MASTER speaker will display "Master Linking..."
  8. WAIT for the speakers to link.
  9. Once the linking process is complete, Bluetooth audio will stream to the two speakers. The MASTER speaker will receive the left channel, and the SLAVE speaker will receive the right channel.
  10. MASTER and SLAVE connection will be indicated on the main, top-level DSP screens.



\*iPad and Apple are trademarks of Apple Inc. Android is a trademark of Google Inc. Windows is either a registered trademark or trademark of Microsoft Corporation in the United States and/or other countries.

### Bluetooth Control

A dedicated iOS control app for TURBOSOUND Bluetooth speakers can be downloaded from the App Store.

This iOS control app can be used with Bluetooth pairing, or without pairing if only analogue inputs are used.

#### Operation with Bluetooth Pairing

- In both mono and stereo mode, first pair the MASTER speaker, and then launch the iOS control app.
- The iOS control app will automatically detect and adapt for mono or stereo mode.
- To alter the speaker settings, swipe the screen or press the settings icon. All iP speaker settings can be accessed from the iOS control app.

#### Operation without Bluetooth Pairing (Analogue Input Only)

- Power on the first (usually left-hand) speaker – this speaker will become the MASTER speaker.
- Start the control app on the IOS device.
- Check that the app is connected and functioning with the single MASTER speaker.
- Power up the second speaker – this speaker becomes the SLAVE speaker.
- Check that the app's Main Page shows both MASTER and SLAVE input and balance control.

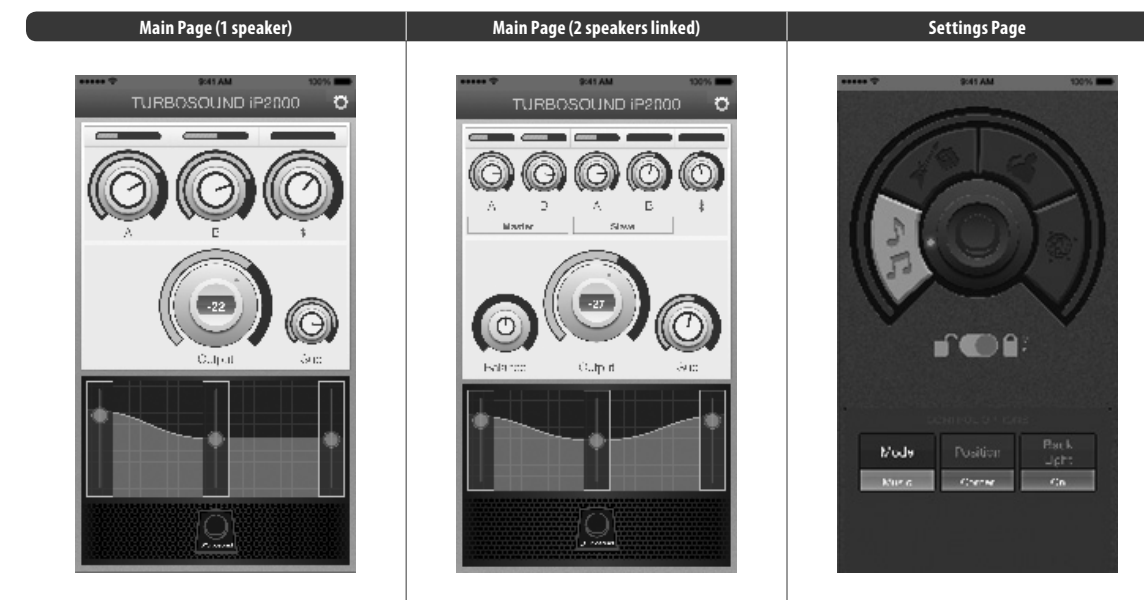

**IMPORTANT NOTE:** The mounting of a permanently installed sound system may be dangerous unless undertaken by qualified personnel with the required experience and certification to perform the necessary tasks. Walls, floors or ceilings must be capable of safely and securely supporting the actual load. The mounting accessory used must be safely and securely fixed both to the loudspeaker and to the wall, floor or ceiling.

When mounting rigging components on walls, floors or ceilings, ensure that all fixings and fasteners used are of an appropriate size and load rating. Wall and ceiling claddings, and the construction and composition of walls and ceilings, all need to be taken into account when determining whether a particular fixing arrangement can be safely employed for a particular load. Cavity plugs or other specialist fixings, if required, must be of an appropriate type, and must be fitted and used in accordance with the maker's instructions.

The operation of your speaker cabinet as part of a flown system, if installed incorrectly and improperly, can potentially expose persons to serious health risks and even death. In addition, please ensure that electrical, mechanical and acoustic considerations are discussed with qualified and certified (by local state or national authorities) personnel prior to any installation or flying.

Make sure that speaker cabinets are set up and flown by qualified and certified personnel only, using dedicated equipment and original parts and components delivered with the unit. If any parts or components are missing please contact your Dealer before attempting to set up the system.

Be sure to observe the local, state and other safety regulations applicable in your country. MUSIC Group, including the MUSIC Group companies listed on the enclosed "Service Information Sheet", assumes no liability for any damage or personal injury resulting from improper use, installation or operation of the product. Regular checks must be conducted by qualified personnel to ensure that the system remains in a secure and stable condition. Make sure that, where the speaker is flown, the area underneath the speaker is free of human traffic. Do not fly the speaker in areas that can be entered or used by members of the public.

Speakers create a magnetic field, even if not in operation. Therefore, please keep all materials that can be affected by such fields (discs, computers, monitors, etc) at a safe distance. A safe distance is usually between 1 and 2 metres.



# EN Technical Specifications

EN

iP3000	
<b>System</b>	
<b>Frequency response</b>	45 Hz – 20 kHz ±3 dB 40Hz – 20 kHz -10 dB
<b>Nominal dispersion</b>	120° H @ -6 dB points
<b>Maximum SPL</b>	130 dB
<b>Crossover type</b>	55 way, active
<b>Transducers</b>	2 x 12" (308mm) LF driver 16 x 3.5" (88.9 mm) MF drivers 2 x 1" (25.4 mm) HF drivers
<b>Limiters</b>	Independent high and low frequency limiters
<b>Amplifier</b>	
<b>Maximum output power*</b>	2000 W
<b>Type</b>	Class-D
<b>Protection</b>	Short circuit, open circuit, thermal
<b>Amplifier channels</b>	6
<b>Connectors</b>	
<b>Input A / B</b>	2 x combo jack / XLR
Sensitivity	4 dBu, nominal
Input impedance	16 kΩ unbalanced, 33 kΩ balanced
Maximum input level	+22 dBu
<b>Link output</b>	XLR
<b>Mains supply</b>	IEC mains connector with integrated power switch
<b>Controls</b>	
<b>Hardware</b>	Rotary push-encoder
<b>Software</b>	iOS interface via Bluetooth
<b>User DSP Functions</b>	
<b>Factory EQ presets</b>	Positioning, sound mode
<b>Display</b>	LCD 128 x 32, blue, backlit
<b>Equalisation</b>	
<b>Bass</b>	±10 dB @ 80 Hz, shelving
<b>Trebel</b>	±10 dB @ 12 kHz, shelving
<b>Reverb</b>	
<b>Converter</b>	24-bit Delta-Sigma 64/128-times oversampling
<b>Sampling rate</b>	40Khz
<b>Protection</b>	Lock-out function for all settings
<b>Bluetooth Wireless Technology</b>	
<b>Frequency range</b>	2402 MHz ~ 2480 MHz
<b>Channel number</b>	79
<b>Version</b>	Bluetooth 4.0 dual mode
<b>Output</b>	8 dBm
<b>Compatibility</b>	Supports A2DP 1.2 profile
<b>Maximum communication range</b>	30 m
<b>Connectivity</b>	Master-slave: stereo pairing link

iP3000	
<b>Power Supply</b>	
<b>Power consumption</b>	110 W @ ½ max power
<b>Voltage (fuses)</b>	USA / Canada / Japan UK / Australia / Europe Korea / China
	100-120 V~, 50/60 Hz (T 10A H 250 V) 220-240 V~, 50/60 Hz (T 5 A H 250 V) 220-240 V~, 50/60 Hz (T 5 A H 250 V)
<b>Enclosure</b>	
<b>Dimensions (H x W x D)</b>	2214 x 620 x 620 mm (87.2 x 24.4 x 24.4")
<b>Base</b>	415 x 620 x 620 mm (16.3 x 24.4 x 24.4")
<b>Tower</b>	1011 x 119 x 137 mm (39.8 x 4.7 x 5.4")
<b>Net weight</b>	51.8kg (114 lbs)
<b>Construction, base</b>	15 mm (½") birch plywood
<b>Construction, tower</b>	Aluminium alloy
<b>Finish</b>	Semi matt black paint
<b>Grille</b>	Powder coated perforated steel
<b>Accessories</b>	

\*independent of limiters and driver protection circuits

†Only qualified personnel are allowed to modify the AC-Main cord and to adhere to all applicable national standards.



# EN Other important information

## EN Important information

**1. Register online.** Please register your new MUSIC Group equipment right after you purchase it by visiting [turbosound.com](http://turbosound.com). Registering your purchase using our simple online form helps us to process your repair claims more quickly and efficiently. Also, read the terms and conditions of our warranty, if applicable.

**2. Malfunction.** Should your MUSIC Group Authorized Reseller not be located in your vicinity, you may contact the MUSIC Group Authorized Fulfiller for your country listed under "Support" at [turbosound.com](http://turbosound.com). Should your country not be listed, please check if your problem can be dealt with by our "Online Support" which may also be found under "Support" at [turbosound.com](http://turbosound.com). Alternatively, please submit an online warranty claim at [turbosound.com](http://turbosound.com) BEFORE returning the product.

**3. Power Connections.** Before plugging the unit into a power socket, please make sure you are using the correct mains voltage for your particular model. Faulty fuses must be replaced with fuses of the same type and rating without exception.

## FEDERAL COMMUNICATIONS COMMISSION COMPLIANCE INFORMATION

### TURBOSOUND

#### iNSPIRE iP3000

Responsible Party Name: MUSIC GROUP SERVICES NV INC.

Address: 5270 PROCYON STREET  
LAS VEGAS, NV 89118 USA

Phone Number: +1 702 800 8290

#### iNSPIRE iP3000

This equipment has been tested and found to comply with the limits for a Class A digital device, pursuant to part 15 of the FCC Rules. These limits are designed to provide reasonable protection against harmful interference when the equipment is operated in a commercial environment. This equipment generates, uses, and can radiate radio frequency energy and, if not installed and used in accordance with the instruction manual, may cause harmful interference to radio communications. Operation of this equipment in a residential area is likely to cause harmful interference in which case the user will be required to correct the interference at his own expense. This transmitter must not be co-located or operating in conjunction with any other antenna or transmitter.

#### FCC Radiation Exposure Statement

This equipment complies with FCC RF radiation exposure limits set forth for an uncontrolled environment. This equipment should be installed and operated with a minimum distance of 20 centimeters between the radiator and your body.

#### Caution!

The manufacturer is not responsible for any radio or TV interference caused by unauthorized modifications to this equipment. Such modifications could void the user authority to operate the equipment.

This equipment complies with Part 15 of the FCC Rules. Operation is subject to the following two conditions:

- (1) This device may not cause harmful interference, and
- (2) This device must accept any interference received, including interference that may cause undesired operation.



This product complies with the requirements of Directive of 2014/53/EU.