





## LIVE MINI

Portable Mini Bluetooth Loudspeaker with  
Advanced Acoustics

EN

**EN Important Safety Instructions**

 Terminals marked with this symbol carry electrical current of sufficient magnitude to constitute risk of electric shock. Use only high-quality professional speaker cables with ¼" TS or twist-locking plugs pre-installed. All other installation or modification should be performed only by qualified personnel.

 This symbol, wherever it appears, alerts you to the presence of uninsulated dangerous voltage inside the enclosure - voltage that may be sufficient to constitute a risk of shock.

 This symbol, wherever it appears, alerts you to important operating and maintenance instructions in the accompanying literature. Please read the manual.

 **Caution**  
To reduce the risk of electric shock, do not remove the top cover (or the rear section). No user serviceable parts inside. Refer servicing to qualified personnel.

 **Caution**  
To reduce the risk of fire or electric shock, do not expose this appliance to rain and moisture. The apparatus shall not be exposed to dripping or splashing liquids and no objects filled with liquids, such as vases, shall be placed on the apparatus.

 **Caution**  
These service instructions are for use by qualified service personnel only. To reduce the risk of electric shock do not perform any servicing other than that contained in the operation instructions. Repairs have to be performed by qualified service personnel.

1. Read these instructions.
2. Keep these instructions.
3. Heed all warnings.
4. Follow all instructions.
5. Do not use this apparatus near water.
6. Clean only with dry cloth.
7. Do not block any ventilation openings. Install in accordance with the manufacturer's instructions.
8. Do not install near any heat sources such as radiators, heat registers, stoves, or other apparatus (including amplifiers) that produce heat.
9. Do not defeat the safety purpose of the polarized or grounding-type plug. A polarized plug has two blades with one wider than the other. A grounding-type plug has two blades and a third grounding prong. The wide blade or the third prong are provided for your safety. If the provided plug does not fit into your outlet, consult an electrician for replacement of the obsolete outlet.
10. Protect the power cord from being walked on or pinched particularly at plugs, convenience receptacles, and the point where they exit from the apparatus.
11. Use only attachments/accessories specified by the manufacturer.



12. Use only with the cart, stand, tripod, bracket, or table specified by the manufacturer, or sold with

the apparatus. When a cart is used, use caution when moving the cart/apparatus combination to avoid injury from tip-over.

13. Unplug this apparatus during lightning storms or when unused for long periods of time.
14. Refer all servicing to qualified service personnel. Servicing is required when the apparatus has been damaged in any way, such as power supply cord or plug is damaged, liquid has been spilled or objects have fallen into the apparatus, the apparatus has been exposed to rain or moisture, does not operate normally, or has been dropped.

15. The apparatus shall be connected to a MAINS socket outlet with a protective earthing connection.
16. Where the MAINS plug or an appliance coupler is used as the disconnect device, the disconnect device shall remain readily operable.



17. Correct disposal of this product: This symbol indicates that this product must not be disposed of with household waste, according to the WEEE Directive (2012/19/EU) and your national law. This product should be taken to a collection center licensed for the recycling of waste electrical and electronic equipment (EEE). The mishandling of this type of waste could have a possible negative impact on the environment and human health due to potentially hazardous substances that are generally associated with EEE. At the same time, your cooperation in the correct disposal of this product will contribute to the efficient use of natural resources. For more information about where you can take your waste equipment for recycling, please contact your local city office, or your household waste collection service.
18. Do not install in a confined space, such as a book case or similar unit.
19. Do not place naked flame sources, such as lighted candles, on the apparatus.
20. Please keep the environmental aspects of battery disposal in mind. Batteries must be disposed of at a battery collection point.
21. Use this apparatus in tropical and/or moderate climates.

**LEGAL DISCLAIMER**

MUSIC Group accepts no liability for any loss which may be suffered by any person who relies either wholly or in part upon any description, photograph, or statement contained herein. Technical specifications, appearances and other information are subject to change without notice. All trademarks

are the property of their respective owners. MIDAS, KLARK TEKNIK, LAB GRUPPEN, LAKE, TANNOY, TURBOSOUND, TC ELECTRONIC, TC HELICON, BEHRINGER, BUGERA, COOLAUDIO and EUROCOM are trademarks or registered trademarks of MUSIC Group IP Ltd. © MUSIC Group IP Ltd. 2017 All rights reserved.

**LIMITED WARRANTY**

For the applicable warranty terms and conditions and additional information regarding MUSIC Group's Limited Warranty, please see complete details online at [music-group.com/warranty](http://music-group.com/warranty).

**ES Instrucciones de seguridad**

 Las terminales marcadas con este símbolo transportan corriente eléctrica de magnitud suficiente como para constituir un riesgo de descarga eléctrica. Utilice solo cables de altavoz profesionales y de alta calidad con conectores TS de 6,3 mm o de bayoneta prefijados. Cualquier otra instalación o modificación debe ser realizada únicamente por un técnico cualificado.

 Este símbolo, siempre que aparece, le advierte de la presencia de voltaje peligroso sin aislar dentro de la caja; este voltaje puede ser suficiente para constituir un riesgo de descarga.

 Este símbolo, siempre que aparece, le advierte sobre instrucciones operativas y de mantenimiento que aparecen en la documentación adjunta. Por favor, lea el manual.



**Atención**  
Para reducir el riesgo de descarga eléctrica, no quite la tapa (o la parte posterior). No hay piezas en el interior del equipo que puedan ser reparadas por el usuario. Si es necesario, póngase en contacto con personal cualificado.



**Atención**  
Para reducir el riesgo de incendio o descarga eléctrica, no exponga este aparato a la lluvia, humedad o alguna otra fuente que pueda salpicar o derramar algún líquido sobre el aparato. No coloque ningún tipo de recipiente para líquidos sobre el aparato.



**Atención**  
Las instrucciones de servicio deben llevarlas a cabo exclusivamente personal cualificado. Para evitar el riesgo de una descarga eléctrica, no realice reparaciones que no se encuentren descritas en el manual de operaciones. Las reparaciones deben ser realizadas exclusivamente por personal cualificado.

1. Lea las instrucciones.
2. Conserve estas instrucciones.
3. Preste atención a todas las advertencias.
4. Siga todas las instrucciones.
5. No use este aparato cerca del agua.
6. Limpie este aparato con un paño seco.
7. No bloquee las aberturas de ventilación. Instale el equipo de acuerdo con las instrucciones del fabricante.
8. No instale este equipo cerca de fuentes de calor tales como radiadores, acumuladores de calor, estufas u otros aparatos (incluyendo amplificadores) que puedan producir calor.
9. No elimine o deshabilite nunca la conexión a tierra del aparato o del cable de alimentación de corriente. Un enchufe polarizado tiene dos polos, uno de los cuales tiene un contacto más ancho que el otro. Una clavija con puesta a tierra dispone de tres



por el fabricante o suministrados junto con el equipo. Al transportar el equipo, tenga cuidado para evitar daños y caídas al tropezar con algún obstáculo.

13. Desenchufe el equipo durante tormentas o si no va a utilizarlo durante un periodo largo.
14. Confíe las reparaciones únicamente a servicios técnicos cualificados. La unidad requiere mantenimiento siempre que haya sufrido algún daño, si el cable de suministro de energía o el enchufe presentaran daños, se hubiera derramado un líquido o hubieran caído objetos dentro del equipo, si el aparato hubiera estado expuesto a la humedad o la lluvia, si ha dejado de funcionar de manera normal o si ha sufrido algún golpe o caída.
15. Al conectar la unidad a la toma de corriente eléctrica asegúrese de que la conexión disponga de una unión a tierra.
16. Si el enchufe o conector de red sirve como único medio de desconexión, éste debe ser accesible fácilmente.

EN

ES

FR

DE

PT



**17.** Cómo debe deshacerse de este aparato: Este símbolo indica que este aparato no debe ser tratado como basura orgánica, según lo indicado en la Directiva WEEE (2012/19/EU) y a las normativas aplicables en su país. En lugar de ello deberá llevarlo al punto limpio más cercano para el reciclaje de sus elementos eléctricos / electrónicos (EEE). Al hacer esto estará ayudando a prevenir las posibles consecuencias negativas para el medio ambiente y la salud que podrían ser provocadas por una gestión inadecuada de este tipo de aparatos. Además, el reciclaje de materiales ayudará a conservar los recursos naturales. Para más información acerca del reciclaje de este aparato, póngase en contacto con el Ayuntamiento de su ciudad o con el punto limpio local.

**18.** No instale esta unidad en un espacio muy reducido, tal como encastrada en una librería o similar.

**19.** No coloque objetos con llama, como una vela encendida, sobre este aparato.

**20.** Tenga presentes todas las advertencias relativas al reciclaje y correcta eliminación de las pilas. Las pilas deben ser siempre eliminadas en un punto limpio y nunca con el resto de la basura orgánica.

**21.** Use este aparato en rangos de temperatura moderados y/o tropicales.

## NEGACIÓN LEGAL

MUSIC Group no admite ningún tipo de responsabilidad por cualquier daño o pérdida que pudiera sufrir cualquier persona por confiar total o parcialmente en la descripciones, fotografías o afirmaciones contenidas en este documento. Las especificaciones técnicas, imágenes y otras informaciones contenidas en este documento están sujetas a modificaciones sin previo aviso. Todas las marcas comerciales que aparecen aquí son propiedad de sus respectivos dueños. MIDAS, KLARK TEKNIK, LAB GRUPPEN,

LAKE, TANNOY, TURBOSOUND, TC ELECTRONIC, TC HELICON, BEHRINGER, BUGERA, COOLAUDIO y EUROCOM son marcas comerciales o marcas registradas de MUSIC Group IP Ltd. © MUSIC Group IP Ltd. 2017 Reservados todos los derechos.

## GARANTÍA LIMITADA

Si quiere conocer los detalles y condiciones aplicables de la garantía así como información adicional sobre la Garantía limitada de MUSIC Group, consulte online toda la información en la web [music-group.com/warranty](http://music-group.com/warranty).

### FR Consignes de sécurité



Les points repérés par ce symbole portent une tension électrique suffisante pour constituer un risque d'électrocution. Utilisez uniquement des câbles d'enceintes professionnels de haute qualité avec fiches Jack mono 6,35 mm ou fiches à verrouillages déjà installées. Toute autre installation ou modification doit être effectuée uniquement par un personnel qualifié.



Ce symbole avertit de la présence d'une tension dangereuse et non isolée à l'intérieur de l'appareil - elle peut provoquer des chocs électriques.



**Attention** Ce symbol signale les consignes d'utilisation et d'entre ! Tien importantes dans la documentation fournie. Lisez les consignes de sécurité du manuel d'utilisation de l'appareil.



**Attention** Pour éviter tout risque de choc électrique, ne pas ouvrir le capot de l'appareil ni démonter le panneau arrière.

L'intérieur de l'appareil ne possède aucun élément réparable par l'utilisateur. Laisser toute réparation à un professionnel qualifié.



**Attention** Pour réduire les risques de feu et de choc électrique, n'exposez pas cet appareil à la pluie, à la moisissure, aux gouttes ou aux éclaboussures. Ne posez pas de récipient contenant un liquide sur l'appareil (un vase par exemple).



**Attention** Ces consignes de sécurité et d'entretien sont destinées à un personnel qualifié. Pour éviter tout risque de choc électrique, n'effectuez aucune réparation sur l'appareil qui ne soit décrite par le manuel d'utilisation. Les éventuelles réparations doivent être effectuées uniquement par un technicien spécialisé.

1. Lisez ces consignes.
2. Conservez ces consignes.
3. Respectez tous les avertissements.
4. Respectez toutes les consignes d'utilisation.
5. N'utilisez jamais l'appareil à proximité d'un liquide.
6. Nettoyez l'appareil avec un chiffon sec.
7. Veillez à ne pas empêcher la bonne ventilation de l'appareil via ses ouïes de ventilation. Respectez les consignes du fabricant concernant l'installation de l'appareil.
8. Ne placez pas l'appareil à proximité d'une source de chaleur telle qu'un chauffage, une cuisinière ou tout appareil dégageant de la chaleur (y compris un ampli de puissance).
9. Ne supprimez jamais la sécurité des prises bipolaires ou des prises terre. Les prises bipolaires possèdent deux contacts de largeur différente. Le plus large est le contact de sécurité. Les prises terre possèdent deux contacts plus une mise à la terre servant de sécurité. Si la prise du bloc d'alimentation ou du cordon d'alimentation fourni ne correspond pas à celles de votre installation électrique,

faites appel à un électricien pour effectuer le changement de prise.

**10.** Installez le cordon d'alimentation de telle façon que personne ne puisse marcher dessus et qu'il soit protégé d'arêtes coupantes. Assurez-vous que le cordon d'alimentation est suffisamment protégé, notamment au niveau de sa prise électrique et de l'endroit où il est relié à l'appareil; cela est également valable pour une éventuelle rallonge électrique.

**11.** Utilisez exclusivement des accessoires et des appareils supplémentaires recommandés par le fabricant.



**12.** Utilisez exclusivement des chariots, des diables, des présentoirs, des pieds et des surfaces de travail recommandés par le fabricant ou livrés avec le produit. Déplacez précautionneusement tout chariot ou diable chargé pour éviter d'éventuelles blessures en cas de chute.

**13.** Débranchez l'appareil de la tension secteur en cas d'orage ou si l'appareil reste inutilisé pendant une longue période de temps.

**14.** Les travaux d'entretien de l'appareil doivent être effectués uniquement par du personnel qualifié. Aucun entretien n'est nécessaire sauf si l'appareil est endommagé de quelque façon que ce soit (dommages sur le cordon d'alimentation ou la prise par exemple), si un liquide ou un objet a pénétré à l'intérieur du châssis, si l'appareil a été exposé à la pluie ou à l'humidité, s'il ne fonctionne pas correctement ou à la suite d'une chute.

**15.** L'appareil doit être connecté à une prise secteur dotée d'une protection par mise à la terre.

**16.** La prise électrique ou la prise IEC de tout appareil dénué de bouton marche/arrêt doit rester accessible en permanence.



**17.** Mise au rebut appropriée de ce produit: Ce symbole indique qu'en accord avec la directive DEEE (2012/19/EU) et les lois en vigueur dans votre pays, ce produit ne doit pas être jeté avec les déchets ménagers. Ce produit doit être déposé dans un point de collecte agréé pour le recyclage des déchets d'équipements électriques et électroniques (EEE). Une mauvaise manipulation de ce type de déchets pourrait avoir un impact négatif sur l'environnement et la santé à cause de substances potentiellement dangereuses généralement associées à ces équipements. En même temps, votre coopération dans la mise au rebut de ce produit contribuera à l'utilisation efficace des ressources naturelles. Pour plus d'informations sur l'endroit où vous pouvez déposer vos déchets d'équipements pour le recyclage, veuillez contacter votre mairie ou votre centre local de collecte des déchets.

**18.** N'installez pas l'appareil dans un espace confiné tel qu'une bibliothèque ou meuble similaire.

**19.** Ne placez jamais d'objets enflammés, tels que des bougies allumées, sur l'appareil.

**20.** Gardez à l'esprit l'impact environnemental lorsque vous mettez des piles au rebut. Les piles usées doivent être déposées dans un point de collecte adapté.

**21.** Utilisez l'appareil dans un climat tropical et/ou modéré.

## DÉNI LÉGAL

MUSIC Group ne peut être tenu pour responsable pour toute perte pouvant être subie par toute personne se fiant en partie ou en totalité à toute description, photographie ou affirmation contenue dans ce document. Les caractéristiques, l'apparence et d'autres informations peuvent faire l'objet de modifications sans notification. Toutes les marques appartiennent à leurs propriétaires respectifs. MIDAS, KLARK TEKNIK,

LAB GRUPPEN, LAKE, TANNOY, TURBOSOUND, TC ELECTRONIC, TC HELICON, BEHRINGER, BUGERA, COOLAUDIO et EUROCOM sont des marques ou marques déposées de MUSIC Group IP Ltd. © MUSIC Group IP Ltd. 2017 Tous droits réservés.

## GARANTIE LIMITÉE

Pour connaître les termes et conditions de garantie applicables, ainsi que les informations supplémentaires et détaillées sur la Garantie Limitée de MUSIC Group, consultez le site Internet [music-group.com/warranty](http://music-group.com/warranty).

### DE Wichtige Sicherheitshinweise



**Vorsicht** Die mit dem Symbol markierten Anschlüsse führen so viel Spannung, dass die Gefahr eines Stromschlags besteht. Verwenden Sie nur hochwertige, professionelle Lautsprecherkabel mit vorinstallierten 6,35 mm MONO-Klinkensteckern oder Lautsprecherstecker mit Drehverriegelung. Alle anderen Installationen oder Modifikationen sollten nur von qualifiziertem Fachpersonal ausgeführt werden.



**Achtung** Um eine Gefährdung durch Stromschlag auszuschließen, darf die Geräteabdeckung bzw. Geräterückwand nicht abgenommen werden. Im Innern des Geräts befinden sich keine vom Benutzer reparierbaren Teile. Reparaturarbeiten dürfen nur von qualifiziertem Personal ausgeführt werden.

**Achtung**  
Um eine Gefährdung durch Feuer bzw. Stromschlag auszuschließen, darf dieses Gerät weder Regen oder Feuchtigkeit ausgesetzt werden noch sollten Spritzwasser oder tropfende Flüssigkeiten in das Gerät gelangen können. Stellen Sie keine mit Flüssigkeit gefüllten Gegenstände, wie z. B. Vasen, auf das Gerät.

**Achtung**  
Die Service-Hinweise sind nur durch qualifiziertes Personal zu befolgen. Um eine Gefährdung durch Stromschlag zu vermeiden, führen Sie bitte keinerlei Reparaturen an dem Gerät durch, die nicht in der Bedienungsanleitung beschrieben sind. Reparaturen sind nur von qualifiziertem Fachpersonal durchzuführen.

1. Lesen Sie diese Hinweise.
2. Bewahren Sie diese Hinweise auf.
3. Beachten Sie alle Warnhinweise.
4. Befolgen Sie alle Bedienungshinweise.
5. Betreiben Sie das Gerät nicht in der Nähe von Wasser.
6. Reinigen Sie das Gerät mit einem trockenen Tuch.
7. Blockieren Sie nicht die Belüftungsschlitze. Beachten Sie beim Einbau des Gerätes die Herstellerhinweise.
8. Stellen Sie das Gerät nicht in der Nähe von Wärmequellen auf. Solche Wärmequellen sind z. B. Heizkörper, Herde oder andere Wärme erzeugende Geräte (auch Verstärker).
9. Entfernen Sie in keinem Fall die Sicherheitsvorrichtung von Zweipol- oder geerdeten Steckern. Ein Zweipolstecker hat zwei unterschiedlich breite Steckkontakte. Ein geerdeter Stecker hat zwei Steckkontakte und einen dritten Erdungskontakt. Der breitere Steckkontakt oder der zusätzliche Erdungskontakt dient Ihrer Sicherheit. Falls das mitgelieferte Steckerformat nicht zu Ihrer Steckdose passt, wenden Sie sich bitte an einen Elektriker, damit die Steckdose

entsprechend ausgetauscht wird.  
**10.** Verlegen Sie das Netzkabel so, dass es vor Tritten und scharfen Kanten geschützt ist und nicht beschädigt werden kann. Achten Sie bitte insbesondere im Bereich der Stecker, Verlängerungskabel und an der Stelle, an der das Netzkabel das Gerät verlässt, auf ausreichenden Schutz.

**11.** Das Gerät muss jederzeit mit intaktem Schutzleiter an das Stromnetz angeschlossen sein.

**12.** Sollte der Hauptnetzstecker oder eine Gerätesteckdose die Funktionseinheit zum Abschalten sein, muss diese immer zugänglich sein.

**13.** Verwenden Sie nur Zusatzgeräte/ Zubehörfteile, die laut Hersteller geeignet sind.



**14.** Verwenden Sie nur Wagen, Standvorrichtungen, Stative, Halter oder Tische, die vom Hersteller

benannt oder im Lieferumfang des Geräts enthalten sind. Falls Sie einen Wagen benutzen, seien Sie vorsichtig beim Bewegen der Wagen-Gerätkombination, um Verletzungen durch Stolpern zu vermeiden.

**15.** Ziehen Sie den Netzstecker bei Gewitter oder wenn Sie das Gerät längere Zeit nicht benutzen.

**16.** Lassen Sie alle Wartungsarbeiten nur von qualifiziertem Service-Personal ausführen. Eine Wartung ist notwendig, wenn das Gerät in irgendeiner Weise beschädigt wurde (z. B. Beschädigung des Netzkabels oder Steckers), Gegenstände oder Flüssigkeit in das Geräteinnere gelangt sind, das Gerät Regen oder Feuchtigkeit ausgesetzt wurde, das Gerät nicht ordnungsgemäß funktioniert oder auf den Boden gefallen ist.



**17.** Korrekte Entsorgung dieses Produkts: Dieses Symbol weist darauf hin, das Produkt entsprechend der WEEE Richtlinie (2012/19/EU) und der jeweiligen nationalen Gesetze nicht

zusammen mit Ihren Haushaltsabfällen zu entsorgen. Dieses Produkt sollte bei einer autorisierten Sammelstelle für Recycling elektrischer und elektronischer Geräte (EEE) abgegeben werden. Wegen bedenkllicher Substanzen, die generell mit elektrischen und elektronischen Geräten in Verbindung stehen, könnte eine unsachgemäße Behandlung dieser Abfallart eine negative Auswirkung auf Umwelt und Gesundheit haben. Gleichzeitig gewährleistet Ihr Beitrag zur richtigen Entsorgung dieses Produkts die effektive Nutzung natürlicher Ressourcen. Für weitere Informationen zur Entsorgung Ihrer Geräte bei einer Recycling-Stelle nehmen Sie bitte Kontakt zum zuständigen städtischen Büro, Entsorgungsamts oder zu Ihrem Haushaltsabfallentsorger auf.

**18.** Installieren Sie das Gerät nicht in einer beengten Umgebung, zum Beispiel Bücherregal oder ähnliches.

**19.** Stellen Sie keine Gegenstände mit offenen Flammen, etwa brennende Kerzen, auf das Gerät.

**20.** Beachten Sie bei der Entsorgung von Batterien den Umweltschutz-Aspekt. Batterien müssen bei einer Batterie-Sammelstelle entsorgt werden.

**21.** Verwenden Sie das Gerät in tropischen und/oder gemäßigten Klimazonen.

## HAFTUNGSAUSSCHLUSS

MUSIC Group übernimmt keine Haftung für Verluste, die Personen entstanden sind, die sich ganz oder teilweise auf hier enthaltene Beschreibungen, Fotos oder Aussagen verlassen haben. Technische Daten, Erscheinungsbild und andere Informationen können ohne vorherige Ankündigung geändert werden. Alle Warenzeichen sind Eigentum der jeweiligen Inhaber. MIDAS, KLARK TEKNIK, LAB GRUPPEN, LAKE, TANNOY, TURBOSOUND, TC ELECTRONIC, TC HELICON, BEHRINGER, BUGERA, COOLAUDIO und EUROCOM sind Warenzeichen

oder eingetragene Warenzeichen der MUSIC Group IP Ltd. © MUSIC Group IP Ltd. 2017 Alle Rechte vorbehalten.

## BESCHRÄNKTE GARANTIE

Die geltenden Garantiebedingungen und zusätzliche Informationen bezüglich der von MUSIC Group gewährten beschränkten Garantie finden Sie online unter [music-group.com/warranty](http://music-group.com/warranty).

## PT Instruções de Segurança Importantes



**Aviso!**  
Terminais marcados com o símbolo carregam corrente elétrica de magnitude suficiente para constituir um risco de choque elétrico. Use apenas cabos de alto-falantes de alta qualidade com plugues TS de ¼" ou plugues com trava de torção pré-instalados. Todas as outras instalações e modificações devem ser efetuadas por pessoas qualificadas.

**!** Este símbolo, onde quer que o encontre, alerta-o para a leitura das instruções de manuseamento que acompanham o equipamento. Por favor leia o manual de instruções.

**Atenção**  
De forma a diminuir o risco de choque eléctrico, não remover a cobertura (ou a secção de trás). Não existem peças substituíveis por parte do utilizador no seu interior. Para esse efeito recorrer a um técnico qualificado.

**Atenção**  
Para reduzir o risco de incêndios ou choques eléctricos o aparelho não deve ser exposto à chuva nem à humidade.

Além disso, não deve ser sujeito a salpicos, nem devem ser colocados em cima do aparelho objectos contendo líquidos, tais como jarras.

**Atenção**  
Estas instruções de operação devem ser utilizadas, em exclusivo, por técnicos de assistência qualificados. Para evitar choques eléctricos não proceda a reparações ou intervenções, que não as indicadas nas instruções de operação, salvo se possuir as qualificações necessárias. Para evitar choques eléctricos não proceda a reparações ou intervenções, que não as indicadas nas instruções de operação. Só o deverá fazer se possuir as qualificações necessárias.

1. Leia estas instruções.
2. Guarde estas instruções.
3. Preste atenção a todos os avisos.
4. Siga todas as instruções.
5. Não utilize este dispositivo perto de água.
6. Limpe apenas com um pano seco.
7. Não obstrua as entradas de ventilação. Instale de acordo com as instruções do fabricante.
8. Não instale perto de quaisquer fontes de calor tais como radiadores, bocas de ar quente, fogões de sala ou outros aparelhos (incluindo amplificadores) que produzam calor.
9. Não anule o objectivo de segurança das fichas polarizadas ou do tipo de ligação à terra. Uma ficha polarizada dispõe de duas palhetas sendo uma mais larga do que a outra. Uma ficha do tipo ligação à terra dispõe de duas palhetas e um terceiro dente de ligação à terra. A palheta larga ou o terceiro dente são fornecidos para sua segurança. Se a ficha fornecida não encaixar na sua tomada, consulte um electricista para a substituição da tomada obsoleta.
10. Proteja o cabo de alimentação de pisadelas ou apertos, especialmente nas fichas, extensões, e no local de saída da unidade. Certifique-se de que o cabo eléctrico está protegido. Verifique particularmente nas fichas,

nos receptáculos e no ponto em que o cabo sai do aparelho.

**11.** O aparelho tem de estar sempre conectado à rede eléctrica com o condutor de protecção intacto.

**12.** Se utilizar uma ficha de rede principal ou uma tomada de aparelhos para desligar a unidade de funcionamento, esta deve estar sempre acessível.

**13.** Utilize apenas ligações/acessórios especificados pelo fabricante.



**14.** Utilize apenas com o carrinho, estrutura, tripé, suporte, ou mesa especificados pelo fabricante ou

vendidos com o dispositivo. Quando utilizar um carrinho, tenha cuidado ao mover o conjunto carrinho/dispositivo para evitar danos provocados pela terpedação.

**15.** Desligue este dispositivo durante as trovoadas ou quando não for utilizado durante longos períodos de tempo.

**16.** Qualquer tipo de reparação deve ser sempre efectuado por pessoal qualificado. É necessária uma reparação sempre que a unidade tiver sido de alguma forma danificada, como por exemplo: no caso do cabo de alimentação ou ficha se encontrarem danificados; na eventualidade de líquido ter sido derramado ou objectos terem caído para dentro do dispositivo; no caso da unidade ter estado exposta à chuva ou à humidade; se esta não funcionar normalmente, ou se tiver caído.



**17.** Correcta eliminação deste produto: este símbolo indica que o produto não deve ser eliminado juntamente com os resíduos domésticos, segundo a Directiva REEE (2012/19/EU) e a legislação nacional. Este produto deverá ser levado para um centro de recolha licenciado para a reciclagem de resíduos de equipamentos eléctricos e electrónicos (EEE). O tratamento incorrecto deste tipo de resíduos pode ter um eventual impacto negativo no ambiente e na

saúde humana devido a substâncias potencialmente perigosas que estão geralmente associadas aos EEE. Ao mesmo tempo, a sua colaboração para a eliminação correcta deste produto irá contribuir para a utilização eficiente dos recursos naturais. Para mais informação acerca dos locais onde poderá deixar o seu equipamento usado para reciclagem, é favor contactar os serviços municipais locais, a entidade de gestão de resíduos ou os serviços de recolha de resíduos domésticos.

**18.** Não instale em lugares confinados, tais como estantes ou unidades similares.

**19.** Não coloque fontes de chama, tais como velas acesas, sobre o aparelho.

**20.** Favor, obedecer os aspectos ambientais de descarte de bateria. Baterias devem ser descartadas em um ponto de coletas de baterias.

**21.** Use este aparelho em climas tropicais e/ou moderados.

## GARANTIA LIMITADA

Para obter os termos de garantia aplicáveis e condições e informações adicionais a respeito da garantia limitada do MUSIC Group, favor verificar detalhes na íntegra através do website [music-group.com/warranty](http://music-group.com/warranty).

## LEGAL RENUNCIANTE

O MUSIC Group não se responsabiliza por perda alguma que possa ser sofrida por qualquer pessoa que dependa, seja de maneira completa ou parcial, de qualquer descrição, fotografia, ou declaração aqui contidas. Dados técnicos, aparências e outras informações estão sujeitas a modificações sem aviso prévio. Todas as marcas são propriedade de seus respectivos donos. MIDAS, KLARK TEKNIK, LAB GRUPPEN, LAKE, TANNØY, TURBOSOUND, TC ELECTRONIC, TC HELICON, BEHRINGER, BUGERA, COOLAUDIO e EUROCOM são marcas ou marcas registradas do MUSIC Group IP Ltd. © MUSIC Group IP Ltd. 2017 Todos direitos reservados.

# EN LIVE MINI Hook-up

## EN Step 1: Hook-Up

Power Connection direct to LIVE MINI

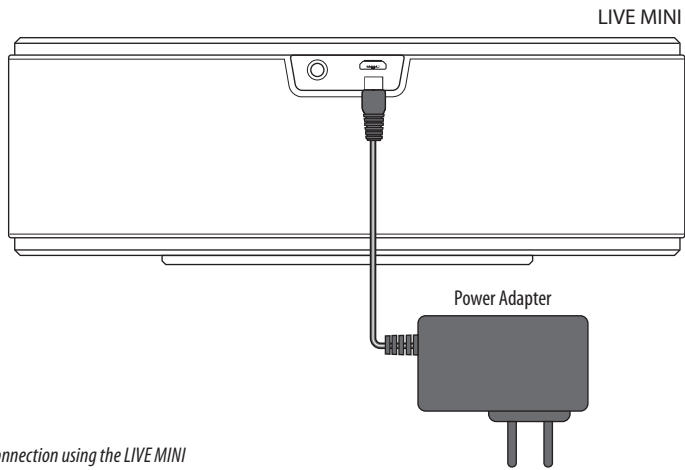

Power Connection using the LIVE MINI charging base (recommended)

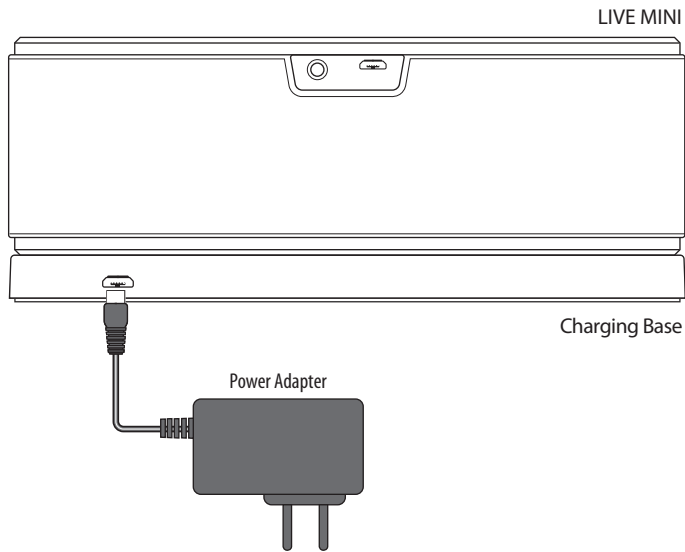

Bluetooth Connection to LIVE MINI

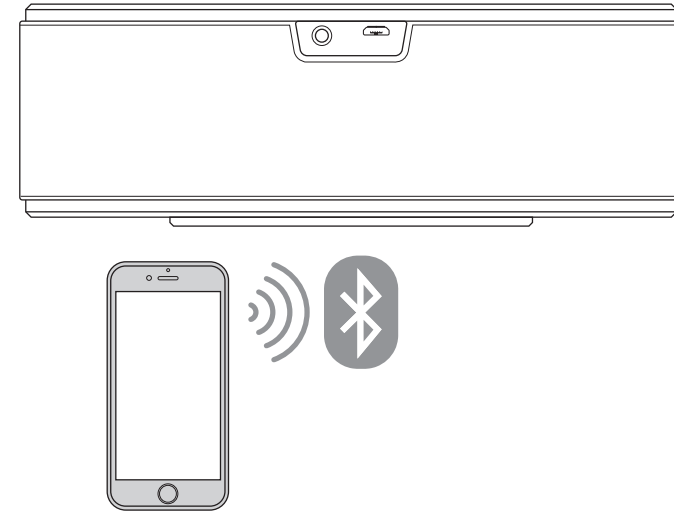

Auxiliary Connection to LIVE MINI

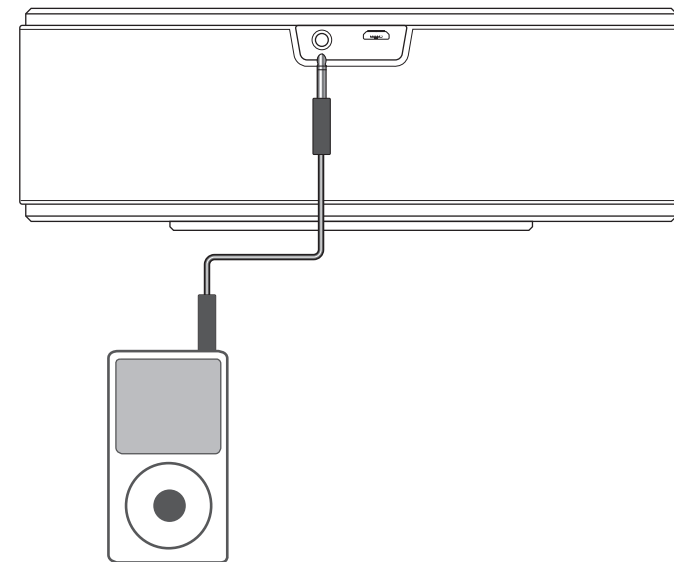

# LIVE MINI Controls

## EN Step 2: Controls

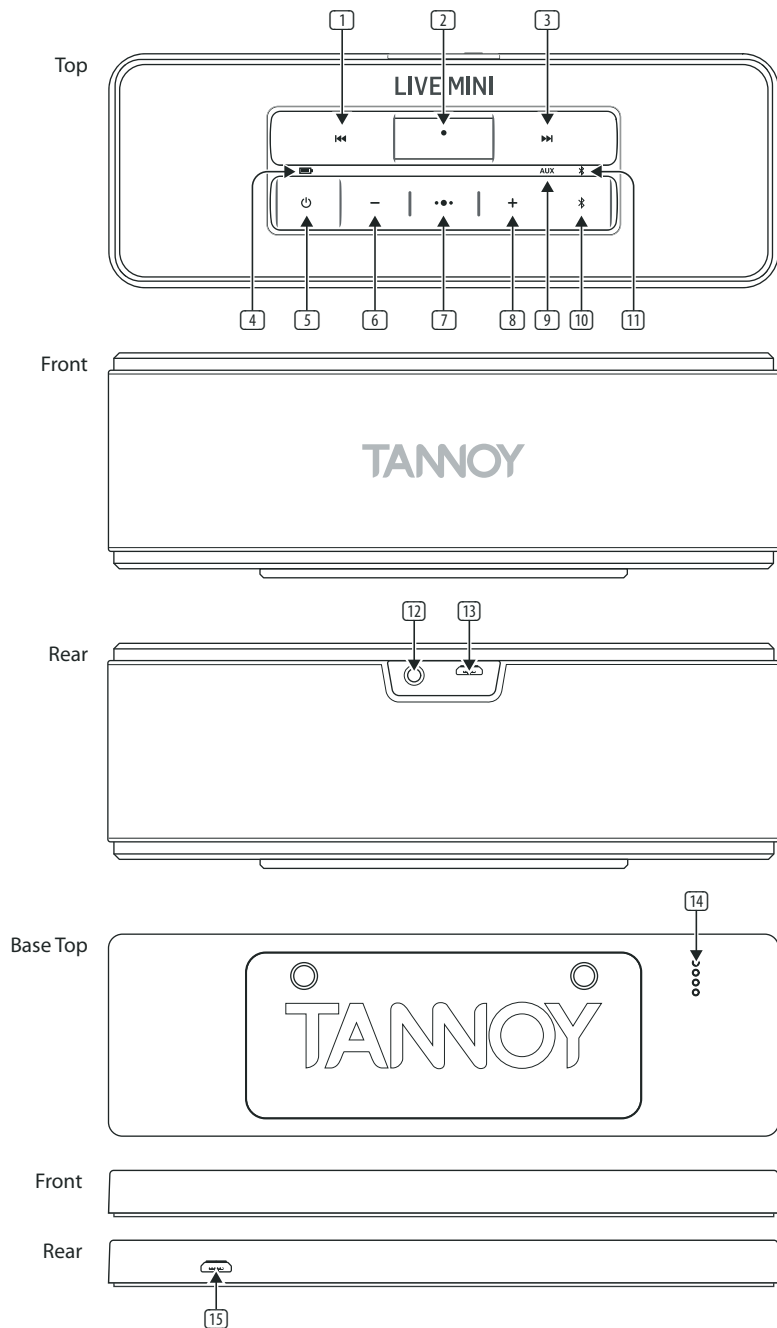

# LIVE MINI Controls

## EN Step 2: Controls

### Top Panel Controls

- 1 **Previous** – this button is used for playing the previous song in the play list.
- 2 **Microphone Aperture** – below this small hole is the element for the internal microphone. This microphone is used for phone calls and voice interaction with your mobile devices. Keep this area clean and dry, and do not cover, or the microphone response will be degraded.
- 3 **Next** – this button is used for playing the next song in the play list.
- 4 **Power ON/Battery Indicator** – this is illuminated steadily for about 10 seconds when the LIVE MINI Power button is pressed ON.

When the LIVE MINI is charging, the indicator will slowly flash. The color indicates the battery status as follows:

**Red:** Battery charge is low

**Yellow:** Battery charge is less than 20%

**Green:** Battery charge is greater than 50%

The LIVE MINI does not need to be on when charging.

The indicator will turn on and flash red when the battery charge is very low and the LIVE MINI is about to shut down.

- 5 **Power Button** – press this button once to turn the LIVE MINI on. The Power ON indicator will turn on when the LIVE MINI is on. Press the button for about 1 second to turn off the LIVE MINI.
- 6 **- Button** – this button is used for various operations, including Volume Down.

- 7 **Multi-Function Button** – this MFB button is used in various operations of the LIVE MINI, including Pause and Play.
- 8 **+ Button** – this button is used for various operations, including Volume UP.
- 9 **Aux Input Indicator** – this indicates that the LIVE MINI is connected to an auxiliary device such as an MP3 player, via the rear panel 3.5 mm TRS Aux connector.
- 10 **Bluetooth Button** – this button is used in various operations such as Bluetooth pairing to compatible devices.  
See the Getting Started section of this manual for details of setting up the Bluetooth connection.
- 11 **Bluetooth Indicator** – this indicates the status of the bluetooth connection.

### Rear Panel Connectors

- 12 **Aux Input** – this 3.5 mm TRS connector accepts line-level stereo input signals from external devices such as MP3 players or computer audio outputs.
- 13 **Power Input** – this connector is used with the supplied power adapter to charge the internal battery of the LIVE MINI when it is not attached to its charging base.  
The LIVE MINI can be charged using this power input connector, or charged when it is connected to the charging base (this is the recommended method).  
Use only the supplied power adapter.

### Charging Base

The LIVE MINI is supplied with a charging base. This base should be placed on a dry and clean, horizontal surface.

We recommend charging using the charging base, because the power connection can be left in place on the charging base. This reduces the chance of damage due to multiple connecting and disconnecting of the power connection directly to the LIVE MINI.

- 14 **Power Connector** – these four spring terminals make the power connection to the bottom of the LIVE MINI when it is connected to the charging base.

When fitting the LIVE MINI to the charging base, make sure this connector lines up correctly to the corresponding connector on the bottom of the LIVE MINI.

Keep this connector clean and dry, as well as the corresponding mating connector on the bottom of the LIVE MINI.

- 15 **Power Input** – this connector is used with the supplied power adapter to charge the internal battery of the LIVE MINI when it is connected to the charging base.

The supplied power adapter can be left connected to the charging base.

Use only the supplied power adapter.

# LIVE MINI Getting started

## EN Step 3: Getting started

### OVERVIEW

This Getting Started guide will help you set up the LIVE MINI and briefly introduce its capabilities. The LIVE MINI contains 2 premium transducers and a unique bass radiator design that allows for excellent music reproduction wherever you go. The Bluetooth connectivity and 3.5 mm auxilliary input allow a wide variety of connection options.

### POWER CONNECTIONS

Before using the LIVE MINI for the very first time, we recommend that you make sure it is fully charged first.

Use the supplied power adapter only, and connect it either directly to the rear power connector on the LIVE MINI, or the charging base.

Make sure the charging base is placed on a clean, dry, and flat horizontal surface, and that the LIVE MINI is correctly fitted into the base.

When charging the LIVE MINI, the Power LED will show the charge status. When the LIVE MINI is fully charged, the Power LED will show a steady green.

Do not leave the LIVE MINI unattended during charging.

Please note that the battery is not user-replaceable. It can be replaced by an authorised repair center.

### Battery Notes

The LIVE MINI internal battery type is Li-ion. To maximise the battery life, we recommend that you do not run the battery down to a very low charge. Keep it out of the "battery low" charge range (red POWER LED) as much as possible. It is better to recharge the battery from a medium charge (even if you have to charge it more often).

There is no need to fully discharge the battery at any time.

The playing time will vary depending upon the volume and type of music program. The louder the music, and

the more bass content, then the less battery time is available.

Operation of the LIVE MINI at high temperatures will also affect battery life. Do not place the LIVE MINI near to radiators, fireplaces, heaters, or other sources of heat, such as power amplifiers. Do not place the LIVE MINI in direct sunlight during high daytime temperatures.

When the LIVE MINI is not going to be used for a long time, such as storage, make sure it is charged first.

Unplug the external power adapter from the AC Mains when the LIVE MINI is not in its charging base.

### BLUETOOTH CONNECTION

The procedure for setting up a typical Bluetooth connection is as follows:

First, read the documentation that came with your device, and become familiar with the Bluetooth operation procedures and details.

Make sure that your device has Bluetooth enabled.

Turn on the Power to the LIVE MINI. The BT LED will flash, showing it is trying to pair with your device.

If the TANNØY LIVE MINI does not appear in your device list, press the BT button on the LIVE MINI for 3 seconds.

When the TANNØY LIVE MINI appears in your device list, select it and it will be paired. The BT LED will turn on steady.

In operation, the + and - buttons can be used to increase and decrease the volume, and the previous and next buttons can be used to move up and down your playlist.

While connected via Bluetooth, incoming calls can be answered by pressing the Multi Function Button (MFB), and using the internal microphone on the LIVE MINI to talk.

The following table shows some of the details of operation.

### Troubleshooting

Problems with the Bluetooth connection may be fixed using the following points:

Try pressing and holding the + and - buttons on the LIVE MINI for 5 seconds. This will reset the Bluetooth connection list within the LIVE MINI.

Try deleting any previous instances of "TANNØY LIVE MINI" in your device, and then try pairing again from new.

### AUX CONNECTION

The 3.5 mm TRS input connection on the rear of the LIVE MINI allows connection to the line-level audio output of various devices including computers and MP3 players, for example.

When a connection is made to the Aux input, the LIVE MINI will automatically switch to play the incoming audio, rather than Bluetooth devices.

In operation, the + and - buttons can be used to increase and decrease the volume, and the MFB button can be used to Mute the sound.

# Operations Table

Function Name	Status	Operation	Remark	LED Status
Turn On	Off	Press and hold the POWER button until the power LED lights up	LIVE MINI will start to connect to the last used device, if the device list is not empty. Otherwise it will enter pairing mode.	Power LED will light for 10 seconds. The Power LED color indicates the battery status: Green : >50% Yellow : >20% Red: Battery Low
Turn Off	On	Press and hold the POWER button until the Power LED turns red and then off		Power LED Off
Show battery status	On	Press the POWER button	Power LED turns on for 3 seconds	Power LED color shows the charge status as above.
<b>Bluetooth mode (BT=Bluetooth, MFB=Multi-Function Button)</b>				
Enter pairing	On, but not in call-active state	Hold BT button for 3 seconds	LIVE MINI is ready for pairing and connecting. This expires in 5 minutes.	BT LED flashes blue slowly
Manual Connection Request	Idle state	Press MFB button	LIVE MINI starts to connect to the last used device.	No change
<b>BT connection established</b>				<b>BT LED On steady</b>
Volume Up	Music playing or a call is active	Press '+' button		BT LED flashes once
Volume Down	Music playing or a call is active	Press '-' button		BT LED flashes once
Volume maximum/minimum	Music playing or a call is active	'+' / '-'	Press and hold the + or - buttons to keep increasing or decreasing volume	BT LED flashes twice
Play/Pause music player	A2dp profile connected	Press MFB once		BT LED flashes once
Forward	Audio streaming	Press PREV button	Jump to next song	BT LED flashes once
Backward	Audio streaming	Press NEXT button	Jump to previous song	BT LED flashes once
<b>Incoming call</b>				<b>BT LED flashes</b>
Answer a call	Incoming call	Press MFB once		BT LED On steady
Reject an incoming call	Incoming call	Hold MFB for 1 second		No change
End/cancel a call	Call active	Press MFB once		No change
Last number redial	HFP connected	Press MFB twice	HFP = Hands Free Protocol	No change
Voice dial	HFP connected	Press MFB three times		No change



## EN Operations Table continued

Three way call				
Place an incoming call on hold	Incoming call	Press MFB twice		LED Status No change
Accept waiting release active	Second call on hold/ waiting	Press MFB once		No change
Accept waiting hold active	Second call on hold/ waiting	Press MFB twice		No change
Accept held incoming call	Incoming call on hold	Press MFB once		No change
Reject held incoming call	Incoming call on hold	Hold MFB for 1 second		No change
Release all held	Call on hold/ waiting	Press MFB+BT buttons		No change
Add held to 3 way	Call on hold/ waiting	Double press MFB+BT buttons		No change
Reset Bluetooth paired device list				
Reset BT paired device list	Idle state	Hold '+' & '-' together for 5 seconds		BT LED flashes several times
AUX mode				
Volume up	AUX mode	Press '+' button		AUX LED flashes once
Volume down	AUX mode	Press '-' button		AUX LED flashes once
Volume maximum/ minimum	AUX mode	'+' / '-'	Press and hold the + or - buttons to keep increasing or decreasing volume	AUX LED flashes twice
Mute/unmute	AUX mode	Press MFB		AUX LED flashes once
Switch BT mode	AUX mode	Press BT button or Unplug the 3.5mm jack		Change to BT led
Switch AUX mode	BT mode	Plug in 3.5mm jack		AUX LED ON
Battery Status				
Full charged	Any state	Plug in charger		POWER LED Green steady
> 50% full	Any state	Plug in charger		POWER LED slowly flashing Yellow
< 50% full	Any state	Plug in charger		POWER LED slowly flashing Red

**Note:**

LIVE MINI will automatically turn itself off if there is no audio input for 20 minutes.

## Specifications

Performance	
Audio output power	2 x 8 Watts RMS @ 4 Ohms
Transducers	2 x 1.75" with neodymium magnets
Passive radiators	2 x
Aux input	3.5 mm TRS
Power Requirements	
External power adapter input	100-240 VAC 50/60 Hz
External power adapter output	5 VDC, 2A maximum
Internal Battery	
Type	Li-ion
Rating voltage	7.4 V
Capacity	2600 mAh
Bluetooth Wireless Technology	
Version	Bluetooth 4.2
RF frequency range	2402 to 2480 MHz
Channel No.	79
Maximum output power	10 dBm
Environmental	
Operating temperature range	5°C to 40°C (41°F to 104°F)
Physical	
Dimensions (H x W x D)	63 x 186 x 65 mm (0.5 x 7.3 x 2.6")
Weight	0.89 kg (1.96 lbs)

## Other important information

### EN Important information

#### 1. Register online.

Please register your new MUSIC Group equipment right after you purchase it by visiting [tannoy.com](http://tannoy.com). Registering your purchase using our simple online form helps us to process your repair claims more quickly and efficiently. Also, read the terms and conditions of our warranty, if applicable.

**2. Malfunction.** Should your MUSIC Group Authorized Reseller not be located in your vicinity, you may contact the MUSIC Group Authorized Fulfiller for your country listed under “Support” at [tannoy.com](http://tannoy.com). Should your country not be listed, please check if your problem can be dealt with by our “Online Support” which may also be found under “Support” at [tannoy.com](http://tannoy.com). Alternatively, please submit an online warranty claim at [tannoy.com](http://tannoy.com) BEFORE returning the product.

#### 3. Power Connections.

Before plugging the unit into a power socket, please make sure you are using the correct mains voltage for your particular model. Faulty fuses must be replaced with fuses of the same type and rating without exception.

## FEDERAL COMMUNICATIONS COMMISSION COMPLIANCE INFORMATION



Responsible Party Name: MUSIC GROUP SERVICES NV INC.

Address: 5270 PROCVON STREET,  
LAS VEGAS, NV89118  
USA.

Phone Number: +1 702 800 8290

#### LIVE MINI

complies with the FCC rules as mentioned in the following paragraph:

This equipment has been tested and found to comply with the limits for a ClassB digital device, pursuant to part 15 of the FCC Rules. These limits are designed to provide reasonable protection against harmful interference in a residential installation. This equipment generates, uses and can radiate radio frequency energy and, if not installed and used in accordance with the instructions, may cause harmful interference to radio communications. However, there is no guarantee that interference will not occur in a particular installation. If this equipment does cause harmful interference to radio or television reception, which can be determined by turning the equipment off and on, the user is encouraged to try to correct the interference by one or more of the following measures:

- Reorient or relocate the receiving antenna.
- Increase the separation between the equipment and receiver.
- Connect the equipment into an outlet on a circuit different from that to which the receiver is connected.
- Consult the dealer or an experienced radio/TV technician for help.

This equipment complies with Part 15 of the FCC Rules. Operation is subject to the following two conditions:

- (1) This device may not cause harmful interference, and
- (2) This device must accept any interference received, including interference that may cause undesired operation.

This transmitter must not be co-located or operating in conjunction with any other antenna or transmitter.

#### Caution!

The MUSIC Group is not responsible for any radio or TV interference caused by unauthorized modifications to this equipment.

Such modifications could void the user authority to operate the equipment

FCC RF Radiation Exposure Statement:

- (1) This Transmitter must not be co-located or operating in conjunction with any other antenna or transmitter.
- (2) This equipment complies with FCC RF radiation exposure limits set forth for an uncontrolled environment. This equipment should be installed and operated with a minimum distance of 20 centimeters between the radiator and your body.

