



# NETGEAR®

## 5-Port Switch

10/100/1000 Mbps Gigabit Ethernet **GS105**



Installation Guide

# Introduction

The NETGEAR® 5-Port Gigabit Ethernet Switch Model GS105 provides you with a low-cost, reliable, high-performance switch to connect up to five different Ethernet-enabled devices (such as computers, file servers and routers) at blazing Gigabit Ethernet speeds.

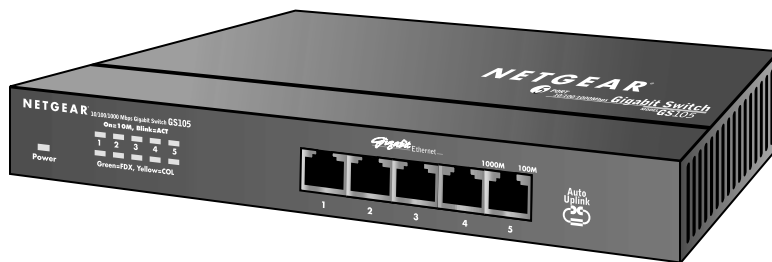

Model GS105 5-Port 10/100/1000 Mbps Gigabit Ethernet Switch

The GS105 Gigabit Ethernet Switch enables you to build a small network that gives you 10, 100, or 1000 Mbps access to other devices on the network. It provides a full, dedicated 1000 (or 100, or 10 Mbps) connection between two devices. If a device has full-duplex capability, the GS105 switch provides a 2000 Mbps (or 200, or 20 Mbps) connection. This means the GS105 can instantly move even very large files across your network. As an added benefit, this switch works with both Windows and Macintosh computers.

Ethernet cables come as either straight-through or crossover cables—depending on whether you're connecting to a device (computer, server, or printer) or networking equipment (hub, switch, or router). With the Auto Uplink™ feature, you don't have to worry about which one you use. Each port on the GS105 switch automatically configures itself correctly when you plug in a device's cable.

If you have a problem with your switch, NETGEAR offers support 24 hours a day and 7 days a week on the Web ([www.NETGEAR.com](http://www.NETGEAR.com)), by e-mail ([support@NETGEAR.com](mailto:support@NETGEAR.com)) and by phone (see the provided support information card for phone numbers).

## Installation Overview

Estimated Time: 5–10 minutes

1. Unpack the box and verify the contents.
2. Prepare to install the switch.
3. Install the switch and connect the other devices.

# 1 Unpack the Box and Verify the Contents

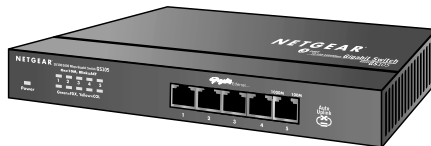

Model GS105 5-Port 10/100/1000 Mbps  
Gigabit Ethernet Switch

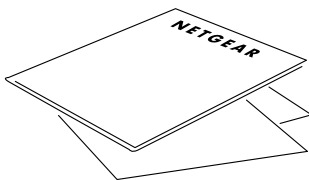

Installation guide,  
warranty card and  
Support information card

Wall-mount  
hardware

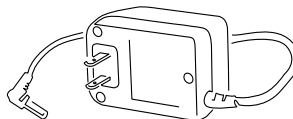

Power adapter

When you open the box, verify that you received everything. The package includes:

- 5-Port Gigabit Ethernet Switch GS105
- AC power adapter
- Wall-mounting screws
- *GS105 Installation Guide* (this document)
- Warranty card
- Support information card

If you don't have everything listed above, see the support information card for contact information. If you're missing the support information card itself, get contact information at [www.NETGEAR.com](http://www.NETGEAR.com) in the Technical Support area.

## 2 Prepare to Install the Switch

Decide where you want to place the switch. Find a flat horizontal surface — such as a table, desk or shelf. The switch comes with wall-mounting screws. You're welcome to use the screws if you want to hang the switch in an open space on a wall.

Make sure the selected location is:

- Not in direct sunlight or near a heater or heating vent.
- Not cluttered or crowded. There should be at least 2 inches (5 cm) of clear space on all sides of the switch.
- Well ventilated (especially if it is in a closet).

Also, you'll need one Category 5 (Cat 5) Ethernet cable with RJ-45 connectors for each device you want to connect to the switch. Each Ethernet cable must be less than 328 feet (100 meters).

# 3 Install the Switch and Connect the Other Devices

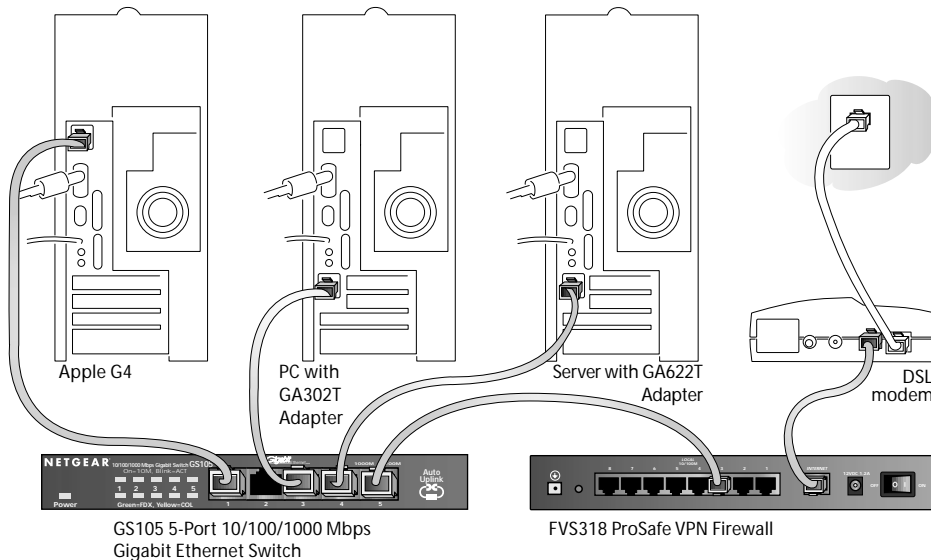

1. Place the switch on a flat surface or hook onto the screws.
2. For each device, insert one end of an Ethernet cable into the port in the device and insert the other end into one of the Ethernet ports on the switch.
3. Connect the power adapter's cord into the back of the switch and then plug the adapter into a power source (such as a wall socket or power strip).

The Power light should light up.

The corresponding Link LED for each connected and powered device

should light and flash when activity occurs. If the connection is 1,000 Mbps or 100 Mbps, the LED in the RJ-45 jack will light up. If the connection is 10 Mbps, the 10M LED on the left side of the front panel will light up.

**Note:** If any light doesn't operate as indicated, go to the *Troubleshooting* section.

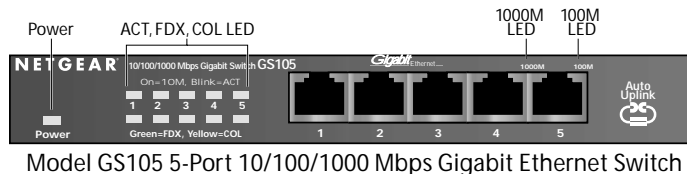

# Troubleshooting

## The Power light is not lit

The switch has no power.

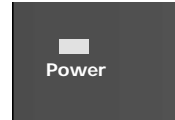

- Make sure the power cord is properly connected to the switch.
- Make sure the power adapter is properly connected to a functioning power outlet. If it's in a power strip, make sure the power strip is turned on. If the socket is controlled by a light switch, make sure the switch is in the on position.
- Make sure you are using the NETGEAR power adapter supplied with your switch.

## The Port number light is not lit for a connected device or stays on continuously

There's a hardware connection problem.

- Make sure the cable connectors are securely plugged in at the switch and the device.
- Make sure the connected device is turned on.
- If the Ethernet cable is connected to a NIC or other Ethernet adapter, make sure the card or adapter is installed correctly and is working.
- Make sure the cable is less than 328 feet (100 meters).

# Technical Specifications

<b>Standards Compatibility:</b>	ISO/IEC 802.3i (ANSI/IEEE 802.3i) 10BASE-T, IEEE 802.3i 10BASE-T, IEEE 802.3u 100BASE-TX, IEEE 802.3z 1000BASE-T, IEEE 802.3x Flow Control; compatible with Windows®, Mac® OS, NetWare®, Linux®
<b>Network Interface:</b>	RJ-45 connector for 10BASE-T, 100BASE-TX, or 1000BASE-T Ethernet interface
<b>Power:</b>	14.4 W max and 12V@1.2A DC input
<b>Physical Dimensions:</b>	W: 158 mm (6.22") D: 105 mm (4.13") H: 25mm (0.98")
<b>Weight:</b>	0.49 kg (1.0829 lbs)
<b>Operating Temperature:</b>	0 to 40° C (32 to 104° F)
<b>Operating Humidity:</b>	10% to 90% relative humidity, noncondensing
<b>Electromagnetic Compliance:</b>	CE mark, Commercial; FCC Part 15, Class A; EN 55 022 (CISPR 22), C-Tick
<b>Safety Agency Approvals for the Power Adapter:</b>	CE mark, Commercial UL listed (UL 1950), TUV licensed (EN 60950), C-Tick

### Performance Specifications

<b>Frame Filter Rate:</b>	14,800 frames/sec max for 10M port / 148,800 frames/sec max for 100M port / 1,488,000 frames/sec for 1000M port
<b>Frame Forward Rate:</b>	14,800 frames/sec max for 10M port / 148,800 frames/sec max for 100M port / 1,488,000 frames/sec max for 1000M port
<b>Network Latency:</b> (using 64-byte packets)	100 Mbps to 100 Mbps: 20 µs max 1000 Mbps to 1000 Mbps: 10 µs max
<b>Address Database Size:</b>	8000 MAC addresses
<b>Addressing:</b>	48-bit MAC address
<b>Queue Buffer:</b>	12 kilobytes per port

## Statement of Conditions

In the interest of improving internal design, operational function, and/or reliability, NETGEAR reserves the right to make changes to the product described in this document without notice.

NETGEAR does not assume any liability that may occur due to the use or application of the product(s) or circuit layout(s) described herein.

## Certificate of the Manufacturer/Importer

It is hereby certified that the NETGEAR Model GS105 Gigabit Ethernet Switch has been suppressed in accordance with the conditions set out in the BMPT-AmtsblVfg 243/1991 and Vfg 46/1992. The operation of some equipment (for example, test transmitters) in accordance with the regulations may, however, be subject to certain restrictions. Please refer to the notes in the operating instructions.

Federal Office for Telecommunications Approvals has been notified of the placing of this equipment on the market and has been granted the right to test the series for compliance with the regulations.

## Federal Communications Commission (FCC) Compliance Notice: Radio Frequency Notice

This device complies with part 15 of the FCC Rules. Operation is subject to the following two conditions:

- This device may not cause harmful interference.
- This device must accept any interference received, including interference that may cause undesired operation.

**Note:** This equipment has been tested and found to comply with the limits for a Class A digital device, pursuant to part 15 of the FCC Rules. These limits are designed to provide reasonable protection against harmful interference in a residential installation. This equipment generates, uses, and can radiate radio frequency energy and, if not installed and used in accordance with the instructions, may cause harmful interference to radio communications. However, there is no guarantee that interference will not occur in a particular installation. If this equipment does cause harmful interference to radio or television reception, which can be determined by turning the equipment off and on, the user is encouraged to try to correct the interference by one or more of the following measures:

- Reorient or relocate the receiving antenna.
- Increase the separation between the equipment and receiver.
- Connect the equipment into an outlet on a circuit different from that to which the receiver is connected.
- Consult the dealer or an experienced radio/TV technician for help.

## EN 55 022 Declaration of Conformance

This is to certify that the NETGEAR Model GS105 Gigabit Ethernet Switch is shielded against the generation of radio interference in accordance with the application of Council Directive 89/336/EEC, Article 4a. Conformity is declared by the application of EN 55 022 Class A (CISPR 22).

## Canadian Department of Communications Radio Interference Regulations

This digital apparatus (NETGEAR Model GS105 Gigabit Ethernet Switch) does not exceed the Class A limits for radio-noise emissions from digital apparatus as set out in the Radio Interference Regulations of the Canadian Department of Communications.

## Règlement sur le brouillage radioélectrique du ministère des Communications

Cet appareil numérique (NETGEAR Model GS105 Gigabit Ethernet Switch) respecte les limites de bruits radioélectriques visant les appareils numériques de classe A prescrites dans le Règlement sur le brouillage radioélectrique du ministère des Communications du Canada.

# Technical Support

PLEASE REFER TO THE SUPPORT INFORMATION CARD THAT SHIPPED WITH YOUR PRODUCT.

By registering your product at [www.NETGEAR.com/register](http://www.NETGEAR.com/register), we can provide you with faster expert technical support and timely notices of product and software upgrades.

NETGEAR, INC.

## Support Information

Phone: 1-888-NETGEAR (For US & Canada only) - 24 x7 phone support

See Support Information card for other countries.

E-mail: [support@NETGEAR.com](mailto:support@NETGEAR.com) (24 x 7 online support)

[www.NETGEAR.com](http://www.NETGEAR.com)

©2003 NETGEAR, Inc. NETGEAR, the Netgear logo, The Gear Guy, Auto Uplink and Everybody's Connecting are trademarks or registered trademarks of Netgear, Inc. in the United States and/or other countries. Microsoft and Windows are registered trademarks of Microsoft Corporation in the United States and/or other countries. Other brand and product names are trademarks or registered trademarks of their respective holders. Information is subject to change without notice. All rights reserved



M - 1 0 1 3 6 - 0 1

June 2003