



# **OPTIVIEW<sup>®</sup> XG**

## **NETWORK ANALYSIS TABLET**

### **Getting Started Guide**

## **LIMITED WARRANTY & LIMITATION OF LIABILITY**

Each Fluke Networks product is warranted to be free from defects in material and workmanship under normal use and service. The warranty period for the mainframe is one year and begins on the date of purchase. Parts, accessories, product repairs and services are warranted for 90 days, unless otherwise stated. Ni-Cad, Ni-MH and Li-Ion batteries, cables or other peripherals are all considered parts or accessories. The warranty extends only to the original buyer or end user customer of a Fluke Networks authorized reseller, and does not apply to any product which, in Fluke Networks' opinion, has been misused, abused, altered, neglected, contaminated, or damaged by accident or abnormal conditions of operation or handling. Fluke Networks warrants that software will operate substantially in accordance with its functional specifications for 90 days and that it has been properly recorded on non-defective media. Fluke Networks does not warrant that software will be error free or operate without interruption.

Fluke Networks authorized resellers shall extend this warranty on new and unused products to end-user customers only but have no authority to extend a greater or different warranty on behalf of Fluke Networks. Warranty support is available only if product is purchased through a Fluke Networks authorized sales outlet or Buyer has paid the applicable international price. Fluke Networks reserves the right to invoice Buyer for importation costs of repair/ replacement parts when product purchased in one country is submitted for repair in another country.

Fluke Networks warranty obligation is limited, at Fluke Networks option, to refund of the purchase price, free of charge repair, or replacement of a defective product which is returned to a Fluke Networks authorized service center within the warranty period.

To obtain warranty service, contact your nearest Fluke Networks authorized service center to obtain return authorization information, then send the product to that service center, with a description of the difficulty, postage and insurance prepaid (FOB destination). Fluke Networks assumes no risk for damage in transit. Following warranty repair, the product will be returned to Buyer, transportation prepaid (FOB destination). If Fluke Networks determines that failure was caused by neglect, misuse, contamination, alteration, accident or abnormal condition of operation or handling, or normal wear and tear of mechanical components, Fluke Networks will provide an estimate of repair costs and obtain authorization before commencing the work. Following repair, the product will be returned to the Buyer transportation prepaid and the Buyer will be billed for the repair and return transportation charges (FOB Shipping point).

**THIS WARRANTY IS BUYER'S SOLE AND EXCLUSIVE REMEDY AND IS IN LIEU OF ALL OTHER WARRANTIES, EXPRESS OR IMPLIED, INCLUDING BUT NOT LIMITED TO ANY IMPLIED WARRANTY OR MERCHANTABILITY OR FITNESS FOR A PARTICULAR PURPOSE. FLUKE NETWORKS SHALL NOT BE LIABLE FOR ANY SPECIAL, INDIRECT, INCIDENTAL OR CONSEQUENTIAL DAMAGES OR LOSSES, INCLUDING LOSS OF DATA, ARISING FROM ANY CAUSE OR THEORY.**

Since some countries or states do not allow limitation of the term of an implied warranty, or exclusion or limitation of incidental or consequential damages, the limitations and exclusions of this warranty may not apply to every buyer. If any provision of this Warranty is held invalid or unenforceable by a court or other decision-maker of competent jurisdiction, such holding will not affect the validity or enforceability of any other provision.

4/04

Fluke Networks  
PO Box 777  
Everett, WA 98206-0777  
USA

# Table of Contents

Title	Page
Safety Information .....	1
Symbols .....	2
Introduction .....	3
Package Contents .....	4
Optional Accessories .....	6
Shipping Damage .....	8
Registering the OptiView XG .....	8
Getting Help .....	8
Contacting Fluke Networks .....	8
Connectors, Controls, and Indicators .....	9
Powering On .....	13
Sleep Mode .....	14
Powering-Off .....	15
Stylus .....	16
Extending the Stand .....	17
Connecting the OptiView XG to a Network .....	18
Establishing a Wired or Fiber Connection .....	18
Establishing a Wireless Connection .....	20
Enabling the Wi-Fi Adapters .....	21
Configuring the OptiView XG for Use with Your Network .....	25
Context-Sensitive Help System .....	26
Operating the OptiView XG on Battery Power .....	27
Battery Operation .....	27
Charging the Batteries .....	27
Power/Charge Indicator .....	27
Displaying the Battery Charge Status Window .....	28
Battery Charge Indicators (on batteries) .....	28
Replacing/Hot Swapping the Batteries .....	29
Battery Life in Sleep or Shut down Modes .....	30
Battery Care .....	30
Extending Battery Operating Time .....	30
Using the Touchscreen, Stylus, Keyboard, and Mouse .....	32
Multi-Touch Screen Use and Care .....	32
Multi-Touch Screen Calibration .....	32
Touchscreen Features (Right-click, etc.) and Virtual Keyboard Settings .....	33
Virtual Keyboard .....	34
Connecting External Devices .....	35
Keyboard, Mouse, Flash Drive, Printer, and Other USB Devices .....	35
External eSATA Hard Drive .....	35
External Antenna .....	35

---

Power Connector .....	36
VGA Port for External Monitor .....	36
Controlling the OptiView XG from a Remote Computer .....	37
Remote PC Requirements .....	37
Installing the Remote User Interface .....	37
Using the Remote User Interface .....	38
Encrypting Data Over the Remote User Interface .....	39
Remote Connection Termination .....	41
Security .....	41
Physical Security: Kensington Lock .....	41
Controlling Access to the OptiView XG .....	42
Removing and Replacing the Hard Drive .....	45
Removing the Hard Drive .....	45
Replacing the Hard Drive .....	46
Cleaning .....	46
Troubleshooting .....	47
Windows Restore Options .....	48
Windows System Restore .....	48
Windows System Recovery .....	48
Specifications .....	53
Physical Specifications .....	53
Environmental Specifications .....	53
Electrical Specifications .....	54
Cables .....	55
Wireless Antennas .....	55
Wireless Adapters 1 & 2 .....	56
Supported Network Standards .....	57
Compliance Statements .....	57
Federal Communication Commission and Industry Canada Interference Statement .....	58
Exposure to RF Energy .....	60
Europe-EU Declaration of Conformity .....	61
Contacting Fluke Networks .....	63

## Safety Information

### **Warning**

- With an optional SFP or SFP+ fiber adapter installed, the Product contains a Class 1 laser.
- Do not look directly into optical connectors while powered on. Some optical equipment emits invisible radiation that can cause permanent damage to your eyes.
- Do not look directly into the laser with optical tools (for example, binoculars, telescopes, microscopes). Optical tools can focus the laser and be dangerous to the eye.
- Use the Product only as specified or hazardous laser radiation exposure can occur.
- Carefully read all instructions and safety information before using the Product.
- Do not use the Product if it operates incorrectly.
- Use the Product only as specified, or the protection supplied by the Product can be compromised.
- Do not operate the Product around explosive gas, vapor or in damp or wet environments.
- Do not expose batteries to fire.
- Do not short circuit or disassemble batteries.
- Do not expose batteries to temperatures above 70°C.
- Use charging procedures specified in manual.
- Use only Fluke Networks supplied charger and battery packs in the instrument.
- Batteries must be recycled or disposed of properly.

### **Caution**

This equipment generates, uses, and can radiate radio frequency energy, and, if not installed and used in accordance with its intended use, may cause interference to radio communications. This device has been tested and found to comply with the limits for a Class A digital device pursuant to Part 15 of the FCC rules, which are designed to provide reasonable protection against such interference when operated in a commercial environment. Operation of the equipment in a residential area is likely to cause interference, in which case the user, at his own expense, will be required to take appropriate measures to correct the interference.













### **Caution**

- Do not connect the Product to a telephone line or an ISDN line.
- Use the correct cables and connectors when connecting the Product to a network.
- Do not block or restrict the Product's air intake or exhaust ports.

## Symbols

The following symbols appear on the product or in the manual.

**Table 1. Symbols**

	Not for connection to public telephone systems.
	Please read manual for safety.
	Shock hazard.
	Class 1 laser product. Do not look into laser. Complies with EN/IEC 60825-1:2007
	Do not put products that contain circuit boards into waste containers. Refer to local regulations for disposal procedures.
	Recycle lithium-ion batteries.
	Complies with European Union directives.
	Complies with CAN/CSA-C22.2 no. 61010-1-04 Canadian standards, and UL61010-1:2004 (US standards).
	Meets Australia EMC requirements.
	Conforms to FCC rules, parts 15.107, 15.109.
	Industry Canada, complies with Canadian safety standards.
	Batteries: Useful life is approximately 5 years. Year of battery manufacture is shown beneath symbol.
	TUV Rheinland safety and EMC compliant.

## Introduction

The OptiView® XG Network Analysis Tablet provides 10/100/1000Mbps/10Gbps wired and 802.11 wireless network analysis anywhere in the network. The tablet enables users to monitor and analyze key assets remotely from the desk and troubleshoot locally "on-the-wire." It's an all-in-one portable network analysis tool designed to help network professionals save time resolving performance problems that are impacting the end-user experience. The flexible user interface allows for custom presentation of information and test results to meet specific needs. The OptiView XG also provides accurate reporting and documentation of the network.

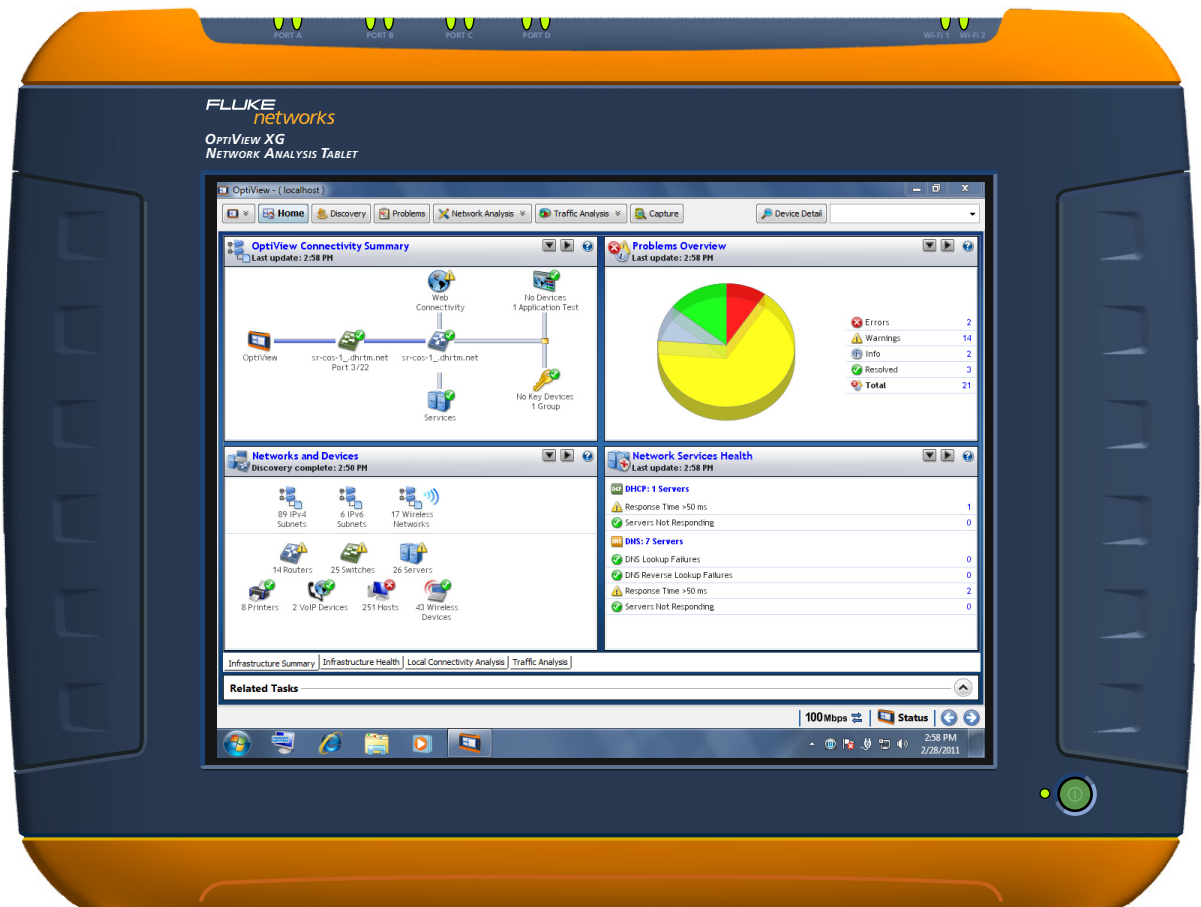

Figure 1. OptiView XG Network Analysis Tablet

## Package Contents

Verify that the following items are supplied with your OptiView XG Network Analysis Tablet.

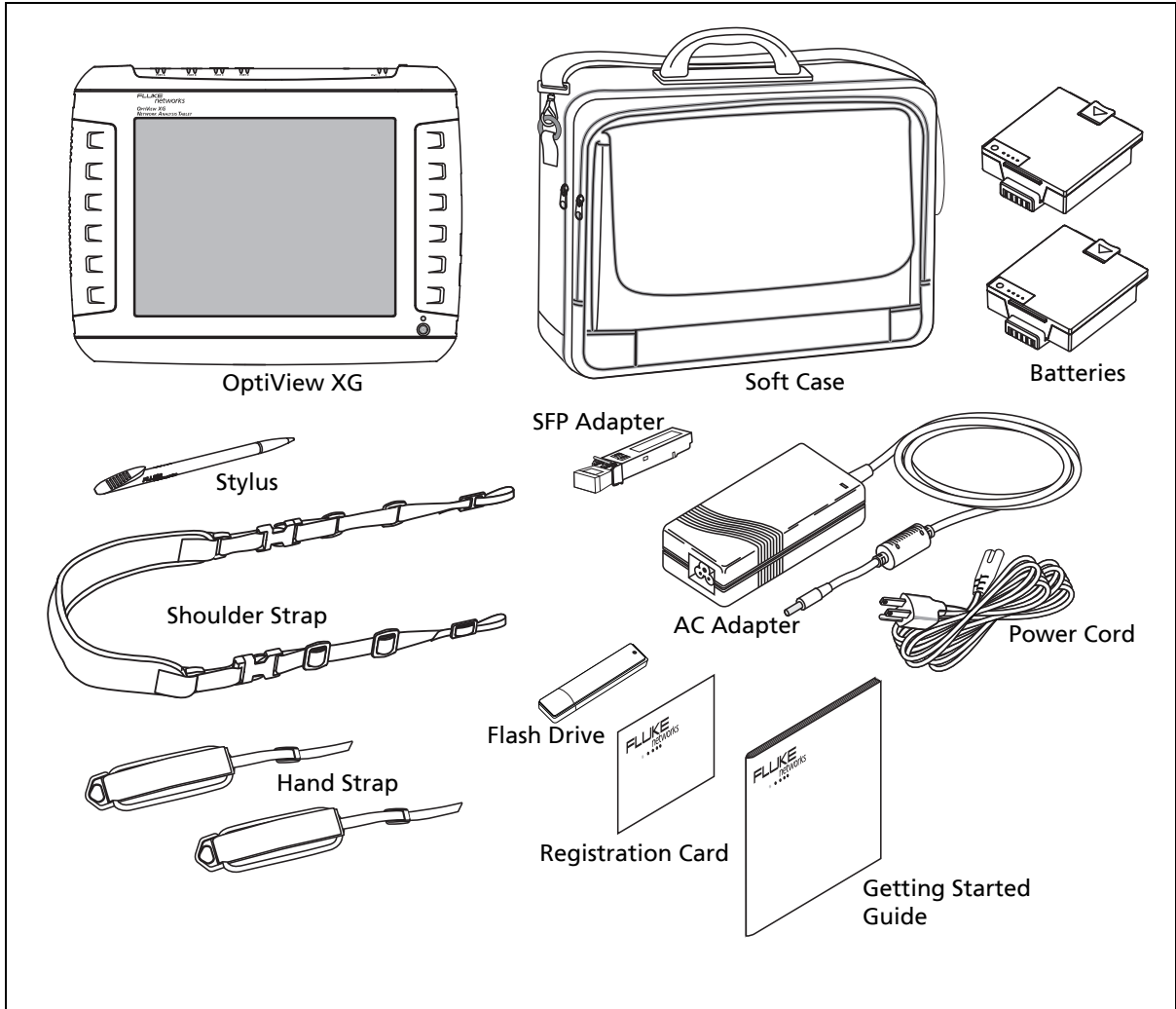

Figure 2. Supplied Items

GLZ20.EPS



Table 2. Supplied Items

Item	Description	Model Number
OptiView XG	Network Analysis Tablet.	—
1000BASE-SX SFP	1000BASE-SX SFP optical transceiver module (adapter), 850 nm, 50 and 62.5 micron multi-mode.	OPV-SFP-SX
Stylus	Stylus for use on OptiView XG touchscreen.	OPVXG-STYLUS
Batteries	Set of two lithium-ion batteries with built-in charge indicators. Provides approximately two hours of run time.	OPVXG-BATTERY
Hand and Shoulder Straps	Attach to the OptiView XG for easy carrying.	OPVXG-STRAPS
Soft Case	Protective soft case.	OPVXG-CCASE
AC Adapter	Input: 90-264 VAC, 47-63 Hz, 2.0 A max Output: 19 VDC, 4.74 A, 90 W.  <b>⚠ Caution:</b> For safe operation, use only the supplied AC adapter.	OPVXG-PS
AC power cord	Country-specific AC power cord (line cord).	—
Getting Started Guide	This document.	—
Flash Drive	Includes Remote User Interface software, Help System, and Getting Started Guide in multiple languages, PDF format.	—
Registration Card	Fluke Networks can best serve you when you register online at <a href="http://www.flukenetworks.com">www.flukenetworks.com</a> .  If you cannot register online, please fill out and return the supplied registration card.	—

## Optional Accessories

The following accessories were available when this manual was printed. For an updated list see [www.flukenetworks.com](http://www.flukenetworks.com).

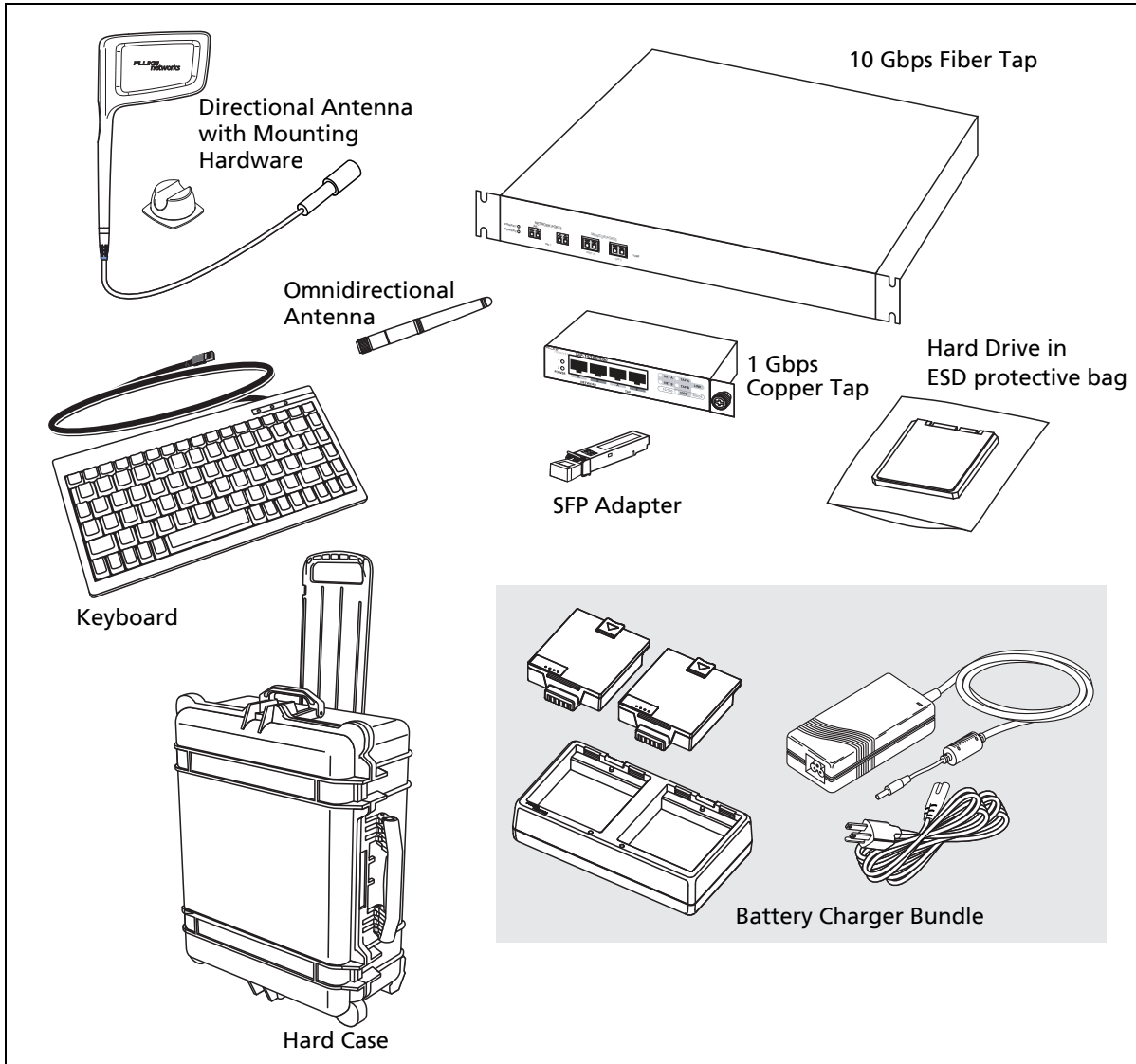

Figure 3. Optional Accessories

GLZ21.EPS

**Table 3. Optional Accessories**

<b>Item</b>	<b>Description</b>	<b>Model Number</b>
Directional Antenna	Directional Antenna for use with AirMagnet WiFi Analyzer PRO and Spectrum XT applications.	OPV-DIRECT-ANT
Omnidirectional Antenna	Omnidirectional antenna for use with AirMagnet applications.	OPV-OMNI-ANT
Keyboard	Small-footprint USB keyboard for connection to OptiView XG.	OPVS2-KB
Hard Case	Hard-sided carrying case.	OPVXG-HCASE
Removable Hard Drive <sup>1</sup>	Removable hard drive, supplied in static-resistive bag.	OPVXG-RHD
Tap, Fiber	10 Gbps in-line filtering fiber tap with two XFP any-to-any ports.	FAXTAP1204SR-10G
Tap, Copper	1 Gbps in-line copper tap. Passive @ 10/100 Mbps, active @ 1000 Mbps.	TAP-10/100/1000
Battery Charger Bundle	Set of two battery packs, charging station, AC adapter, and line cord.	OPVXG-BATT-KIT
10G Fiber SFP+ SR adapter	10GBASE-SR SFP+ optical transceiver module (adapter), 850 nm multi-mode.	OPVXG-SFP-PLUS-SR
10G Fiber SFP+ LR adapter	10GBASE-LR SFP+ optical transceiver module (adapter), 1310 nm single mode.	OPVXG-SFP-PLUS-LR
10G Fiber SFP+ LRM adapter	10GBASE-LRM SFP+ optical transceiver module (adapter), 1310 nm multi-mode.	OPVXG-SFP-PLUS-LRM
1G Fiber SFP SX adapter	1000BASE-SX SFP optical transceiver module (adapter), 850nm, 50 and 62.5 micron multi-mode.	OPV-SFP-SX
1G Fiber SFP LX adapter	1000BASE-LX SFP optical transceiver module (adapter), 1300 nm, 10 micron single mode.	OPV-SFP-LX
1G Fiber SFP ZX adapter	1000BASE-ZX SFP optical transceiver module (adapter), 1550 nm, single mode.	OPV-SFP-ZX
100M Fiber SFP FX adapter	100BASE-FX SFP optical transceiver module (adapter), 1310 nm.	OPV-SFP-100FX

<sup>1</sup>Use standard ESD protection practices when handling this item.

## Shipping Damage

If shipping damage has occurred, call the carrier immediately and file a claim. Then contact Fluke Networks (see page 8) to arrange repair or replacement.

## Registering the OptiView XG

To register, go to <http://www.flukenetworks.com/registration>. If you do not already have an account, select the **Create Account** button to proceed.

You can also register the OptiView XG by filling out the registration card and sending it to Fluke Networks.

Registration provides the following benefits:

- Notification of software updates
- Three free telephone support incidences during the first 60 days of product ownership
- Access to the online Knowledge Base
- Web-based trouble ticket support

## Getting Help

- For context-sensitive help, select the **Help** button (at the top of most OptiView XG screens)

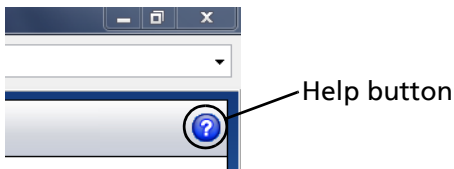

- Go to <http://www.flukenetworks.com/optiviewxg> for downloads, demos, manuals, and more
- OptiView XG training courses may be offered at <http://www.flukenetworks.com/training>

## Contacting Fluke Networks

Web: [www.flukenetworks.com/contact](http://www.flukenetworks.com/contact)

e-mail: [support@flukenetworks.com](mailto:support@flukenetworks.com)

Phone: (USA) 1-800-283-5853

(Please see "Contacting Fluke Networks" on page 63 for international numbers.)

## Connectors, Controls, and Indicators

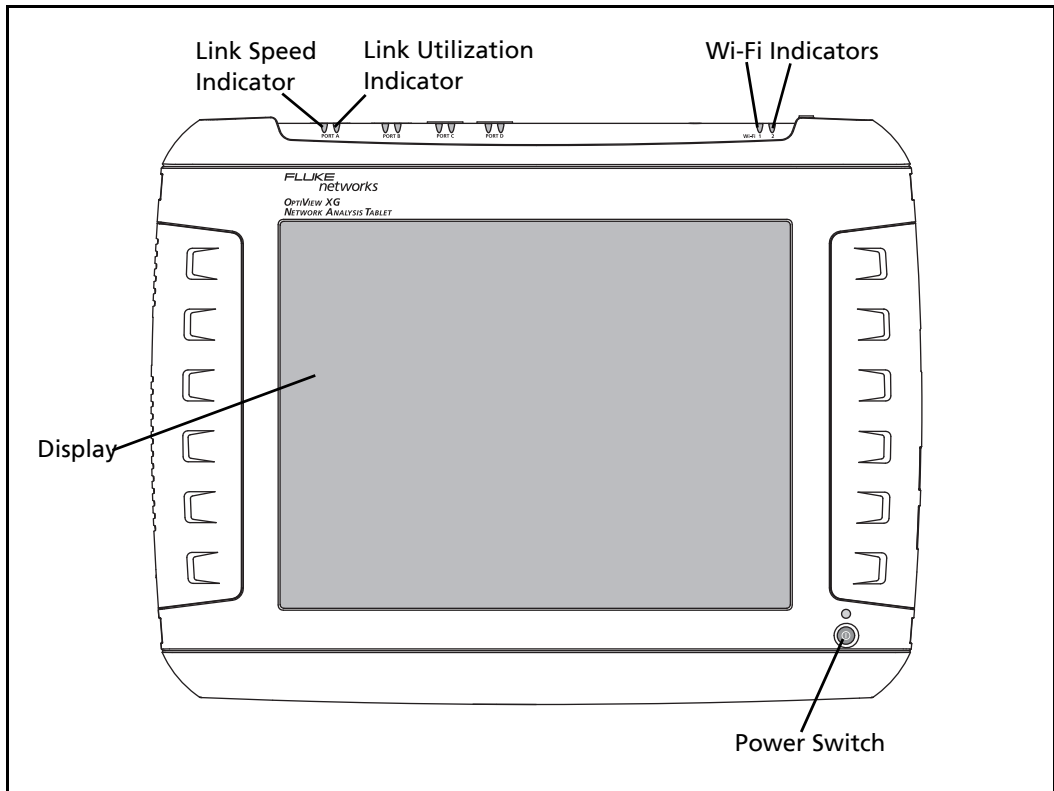

GLZ01.EPS

**Figure 4. Front View**

Link Speed Indicator, see page 19.

Link Utilization Indicator, see page 19.

Wi-Fi Indicators, see page 24.

Power Switch, see page 13.

Multi-Touch Display, see page 32.

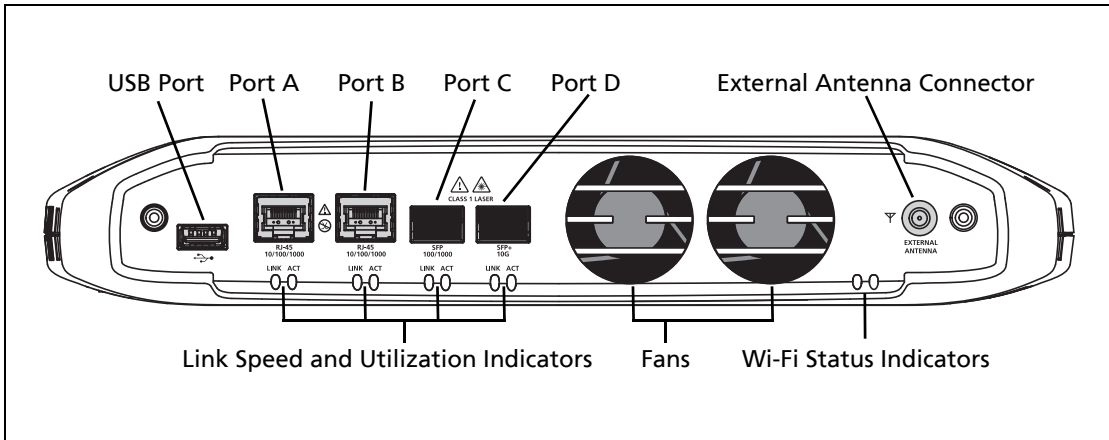

GLZ02.EPS

Figure 5. Top View

USB Port, see page 35.

Network Ports A, B, C, and D; see page 18.

External Antenna Connector, see page 35.

Link Speed Indicator, see page 19.

Link Utilization Indicator, see page 19.

Wi-Fi Indicators, see page 24.

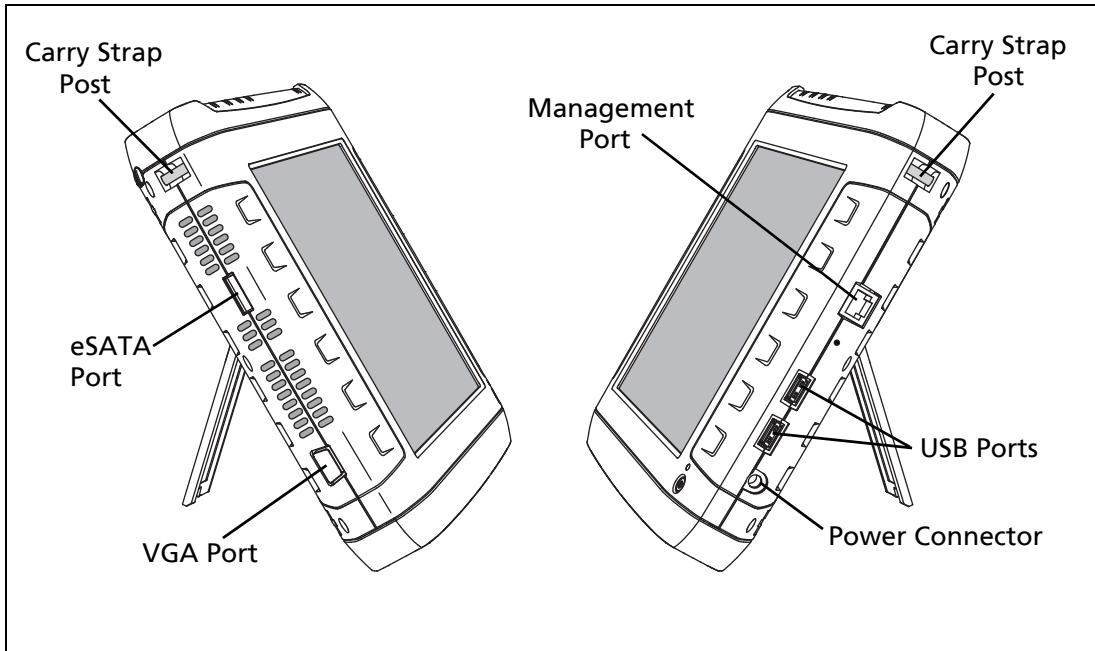

GLZ05.EPS

**Figure 6. Left and Right Side Views**

Carry strap post, for connecting carry strap.

eSATA connector, see page 35.

VGA Port, see page 36.

Management Port, see page 18.

USB Ports, see page 35.

Power Connector, see page 13.

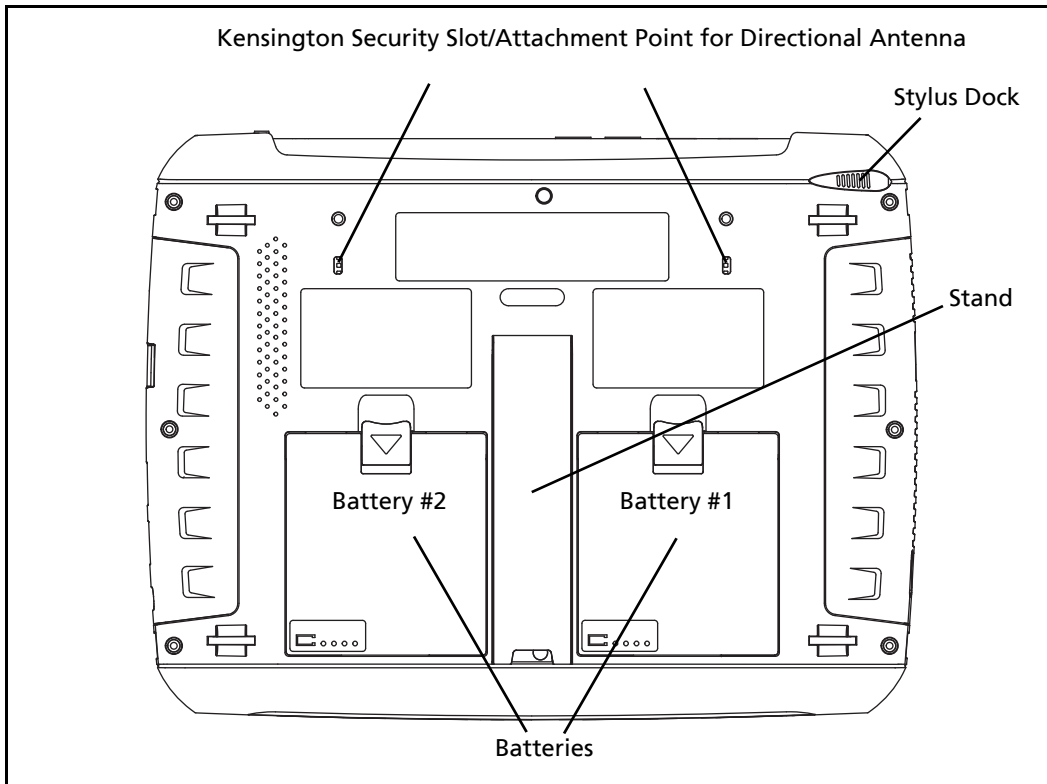

GLZ08.EPS

**Figure 7. Rear View**

Batteries, see page 27.

Stand, see page 17.

Stylus and Dock, see page 16.

Kensington Security Slot, see page 41.



## Powering On

1. Connect the AC adapter to a power source and to the OptiView XG Network Analysis Tablet. See Figure 8, "Powering On" for the location of the power connector and power button. The batteries are not fully charged before shipment due to transportation regulations.
2. Charge the batteries to full capacity before disconnecting the AC adapter. Charge time is approximately 3 hours. Run time is approximately 2 hours with fully charged batteries.
  - If the OptiView XG is powered-on, see the Battery Status Window (see page 28) to verify that batteries are fully charged.
  - If the OptiView XG is powered-off use the Battery Charge Status LED (see page 27) or the Battery Charge Indicators on the batteries (see page 28) to verify that batteries are fully charged.
3. Press the green On/Off button to power-on the OptiView XG.

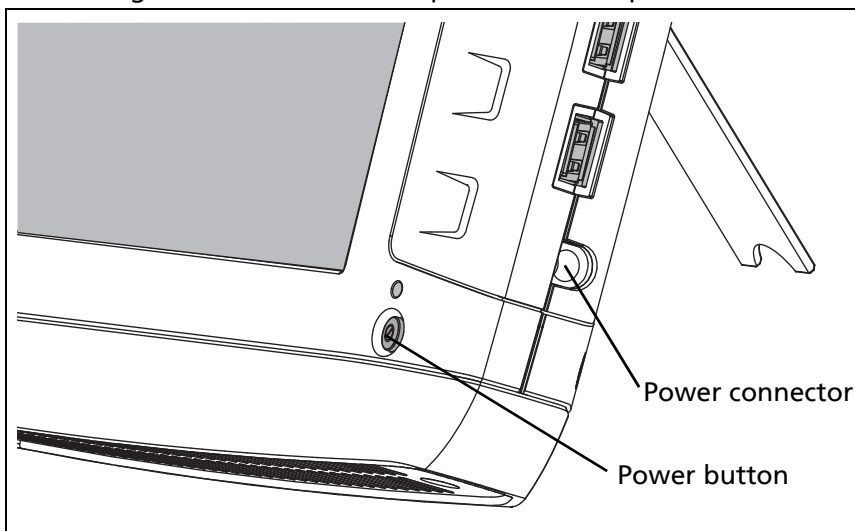

GLZ04.EPS

**Figure 8. Powering On**

The OptiView XG will power-up. The following screens will be displayed during power up:

1. Blank screen.
2. Fluke Networks splash screen.
3. Windows 7<sup>®</sup> operating system startup screens.
4. Fluke Networks desktop background.

5. The OptiView XG application.
6. When power-on is complete, the default Home page is displayed.

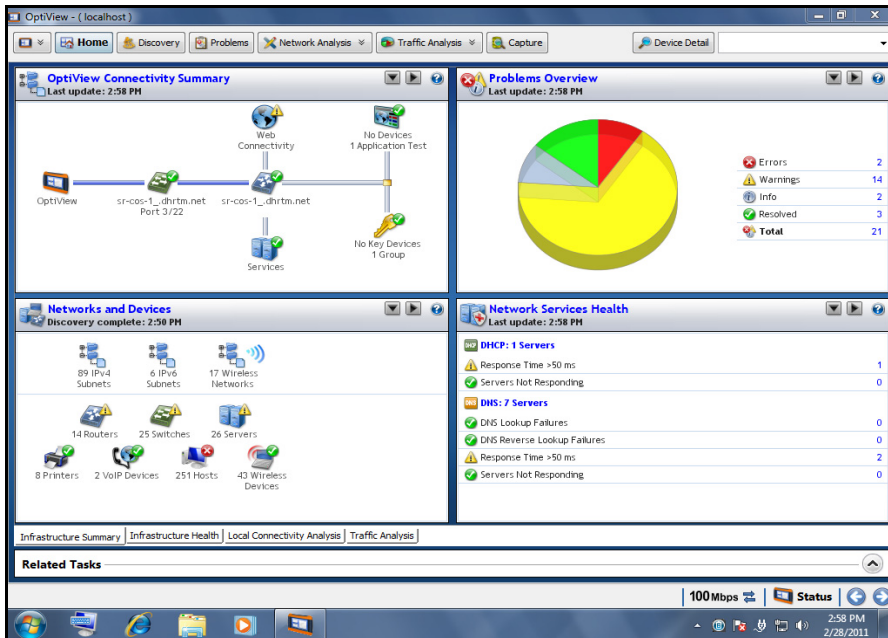

Figure 9. OptiView XG Home Screen

For more information, see "Context-Sensitive Help System" on page 26.

## Sleep Mode

In the factory-default configuration, when you press the OptiView's power button the Windows Sleep sequence is activated and the unit goes into a low power state. The Power/Charge LED indicator behavior is described on page 27.

Settings that you configure in the **OptiView Settings** screens are retained through Sleep and Shutdown cycles. Discovery and Traffic Analysis *data* are not retained.

To resume from Sleep mode, press the power button.

Two fully-charged batteries will last approximately 36 hours when the OptiView XG is in Sleep mode.

## Powering-Off

If you plan to leave the OptiView XG in Sleep mode while unplugged from the AC adapter for an extended period, power-off the OptiView XG to avoid fully discharging the batteries.

When the OptiView XG has been powered-off (using Windows Shut down), battery life is determined by the internal discharge rate of the lithium-ion batteries, which is approximately 5-10% per month.

To power-off the OptiView XG:

1. Select the Windows 7 button. 
2. Select the **Shutdown** button.

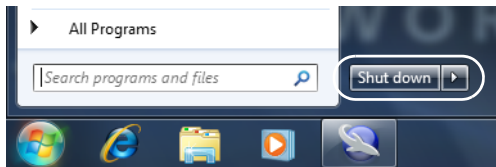

The Windows 7 Shutdown sequence will be activated, and the OptiView XG will power-off.

Settings that you configure in the **OptiView Settings** screens are retained through Sleep and Shutdown cycles. Discovery and Traffic Analysis *data* are not retained.

See also: "Battery Life in Sleep or Shut down Modes" on page 30.

## Stylus

The stylus is docked in the upper right corner of the rear panel. Slide it out to use it; slide it back in for storage.

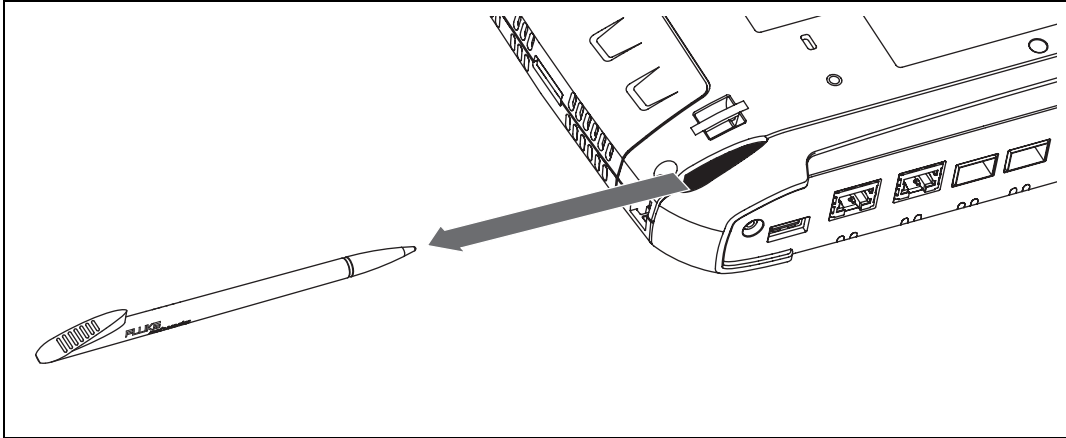

GLZ07.EPS

**Figure 10. Stylus and Dock**

The multi-touch screen is designed for use with a stylus. However, you can also use your fingertip. Your fingernail or a stylus provide more accurate control than the pad of your fingertip. Use of sharp objects or excessive pressure on the multi-touch screen may cause permanent damage.

See also: "Multi-Touch Screen Use and Care" on page 32.

## Extending the Stand

The stand is a convenient feature for desktop use. To extend the stand, pull at the recessed portion located at the bottom of the stand. To retract the stand, push it back in until it snaps in place.

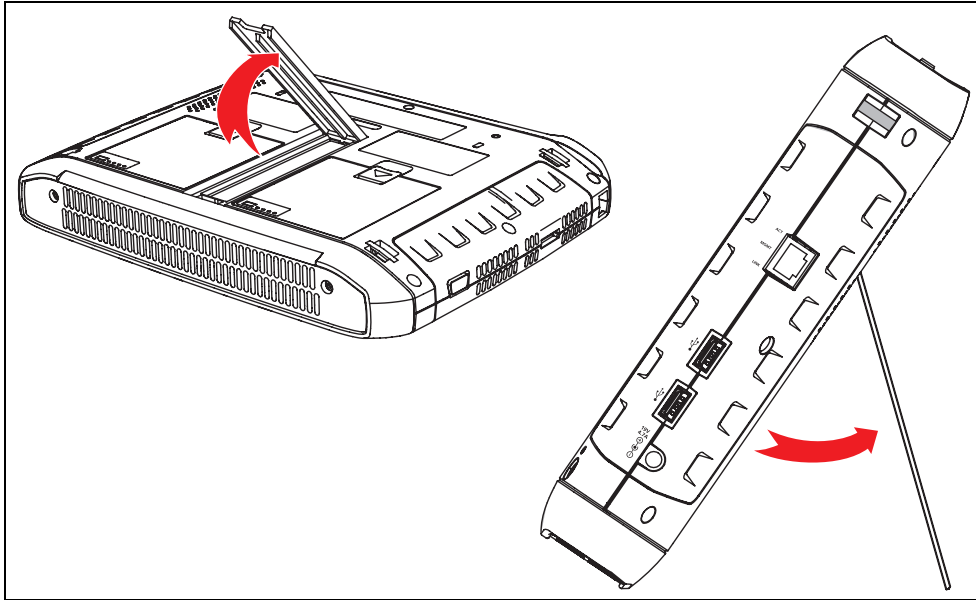

GLZ03.EPS

Figure 11. Extending the Stand

## Connecting the OptiView XG to a Network

You can connect the OptiView XG to a network via network ports A, B, C, or D, or via the built-in wireless adapters.

The OptiView XG's management port can be used for remote control of the analyzer (from a separate network). This lets you control the analyzer from a management network while using the OptiView XG to test a production network.

## Establishing a Wired or Fiber Connection

Connect an appropriate cable from one of the OptiView XG's network ports to the network that you want to test. The OptiView XG will find the active network interface and obtain an IP address. Then it will begin discovering the network.

### Network Ports

The OptiView XG has the following network ports:

- Port A: RJ45 Ethernet connector, 10/100/1000 Mbps
- Port B: RJ45 Ethernet connector, 10/100/1000 Mbps
- Port C: 100/1000 Mbps Ethernet over fiber on standard SFP socket
- Port D: 10 Gbps Ethernet over fiber on standard SFP+ socket
- Management Port: RJ45 Ethernet connector, 10/100/1000 Mbps

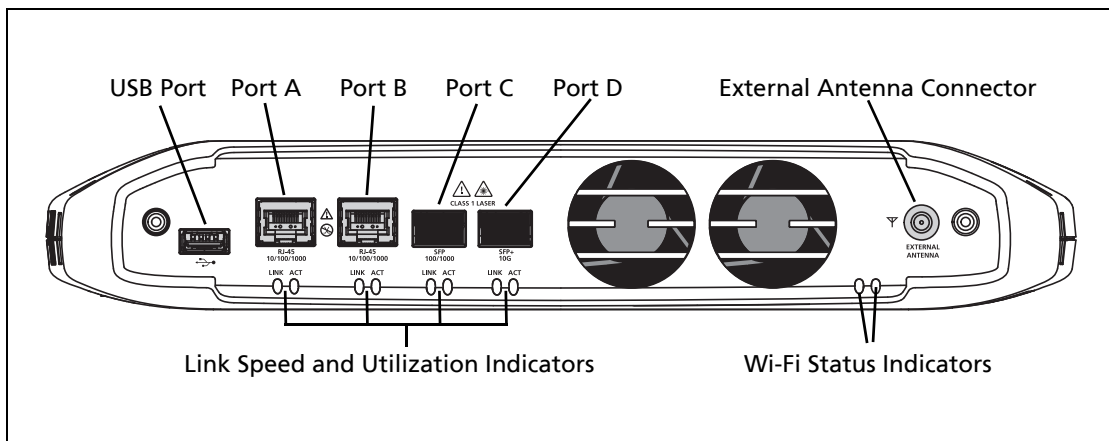

GLZ02.EPS

Figure 12. OptiView XG Network Ports

**⚠ Caution**

To prevent equipment damage, do not connect the OptiView XG Port A or Port B to a telephone line or an ISDN line.

**Link Speed and Utilization Indicators**

There are two link status indicators for each network port: Link Speed (on the left) and Utilization (on the right).

**Table 4. Network Port Link Speed Indicator**

Color	Link Speed
Green	10 Mbps
Blue	100 Mbps
White	1000 Mbps
Magenta	10 Gbps

**Table 5. Network Port Link Utilization Indicator**

Color	Link Utilization
Flashing Green	0% - 9%
Green	10% - 50%
Yellow	51% - 80%
Red	81% - 100%

**Installing/Removing the SFP or SFP+ Fiber Adapter (Transceiver)**

To install an SFP or SFP+ Fiber adapter, remove the protective cap from the adapter and slide the adapter into Port C or Port D. To remove, gently pull the SFP's bail. If the SFP has retention tabs, press and hold the tabs on the sides of the adapter and pull it from the fiber port.

A list of supported SFP and SFP+ modules is given in the specifications on page 54. See [www.flukenetworks.com](http://www.flukenetworks.com) for a complete list of supported SFP and SFP+ modules.

## Establishing a Wireless Connection

### OptiView XG Wireless Capabilities

Wireless capabilities are an option at time of purchase, or may be enabled after purchase in certain circumstances. If you purchased wireless capability and you reside in a country for which RF certification has been received, the Wi-Fi adapters were enabled at the factory prior to shipment.

The OptiView XG Network Analysis Tablet includes internal wireless adapters and a spectrum analyzer. They are available to the OptiView XG application and Fluke Networks AirMagnet mobility applications for wireless network access and wireless LAN analysis and troubleshooting.

The OptiView XG application can use the Wi-Fi adapter for network access. Once connected, you can analyze and troubleshoot the LAN.

The Fluke Networks AirMagnet mobility product suite uses the Wi-Fi adapters and spectrum analyzer for comprehensive 802.11 and RF interference analysis as well as for site survey projects.

The OptiView XG tablet includes two Wi-Fi adapters: Wi-Fi 1 is for general use. Wi-Fi 2 and the spectrum analyzer are reserved for use by Fluke Networks AirMagnet applications.

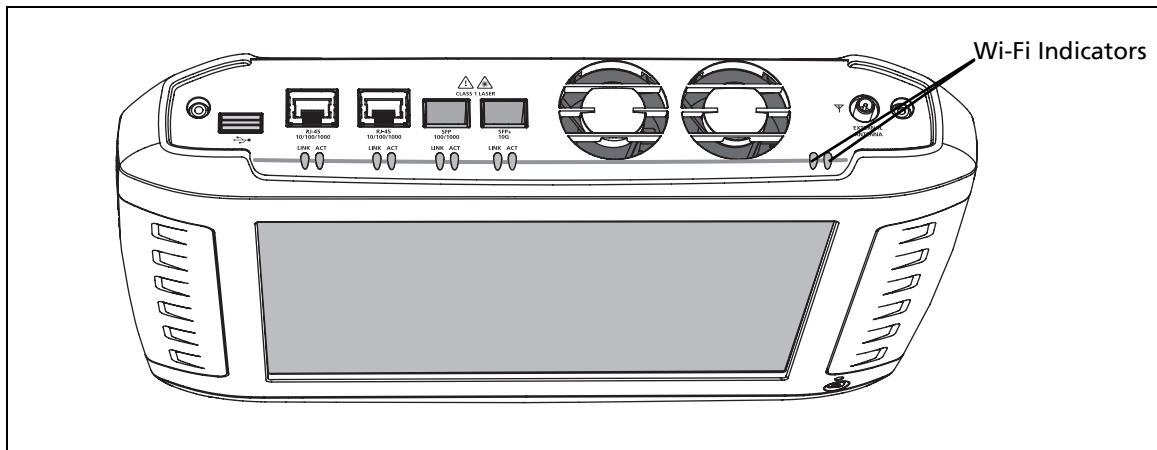

GLZ22.EPS

Figure 13. Wi-Fi Indicators



## Enabling the Wi-Fi Adapters

If Fluke Networks received approval to enable the Wi-Fi adapters for use in your country before your OptiView XG was shipped to you, and you purchased a model with wireless capabilities, the Wi-Fi adapters are already enabled.

If Fluke Networks received approval to enable the Wi-Fi adapters for use in your country after your OptiView XG was shipped to you and you purchased a model with wireless capabilities, you can enable your Wi-Fi adapters by contacting your Fluke sales representative and obtaining a power control key free-of-charge. Additionally, if you purchase AirMagnet applications a card will be included. The card explains the procedure for obtaining the software license to enable the Wi-Fi adapters.

To determine whether the Wi-Fi adapters are enabled *and* powered on, select the OptiView Power Control icon in the system tray.



## Wi-Fi Adapters Not Enabled

If the Wi-Fi adapters have not been enabled, a dialog will be displayed as shown below. To enable the wireless capabilities, enter a power control key.

- If Fluke Networks receives approval to enable Wi-Fi adapters in your country after you purchase the OptiView XG, you can call Fluke Networks Technical Assistance Center to obtain a power control key free-of-charge. Please see “Contacting Fluke Networks” on page 8.

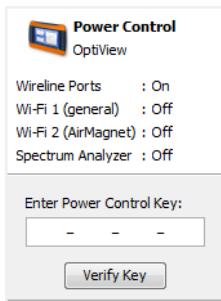

### Wi-Fi Adapters Enabled

If the Wi-Fi adapters are enabled, the OptiView Power Control application will open as shown below. Use the application to manage power for the adapters you want to use.

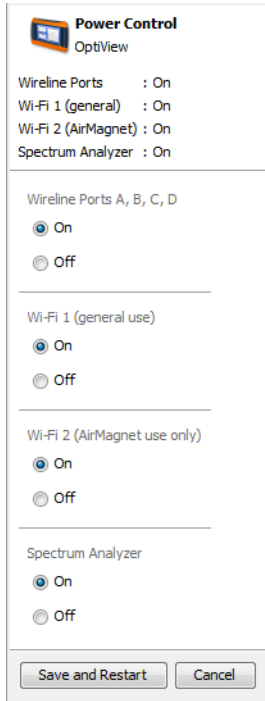

The Wi-Fi adapters and the spectrum analyzer consume small amounts of power, so it's fine to leave them powered-on even when operating on battery power.

Select the "Save and Restart" button to reboot the system and make the changes effective.

### Setting Up a Wi-Fi Profile and Security

1. Select the **Status** button, which is located at the bottom of the screen. The configuration panel will open.



2. Collapse the Network Port section and expand the Wireless Port section using the arrows at the right.

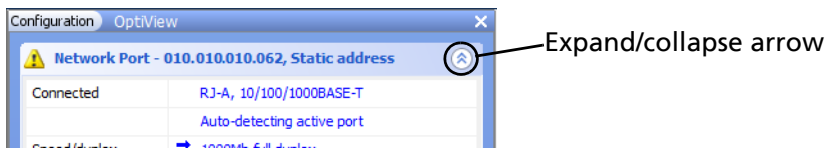

3. Select the word **“Disconnected.”** The OptiView Settings screen will be displayed, with the **Wireless** icon highlighted at the left edge of the screen.

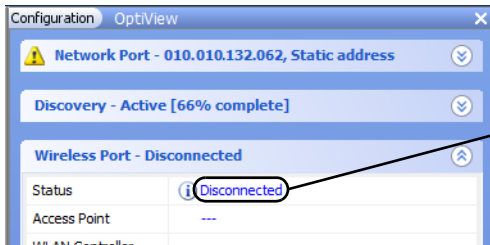

If the wireless adapters have not been enabled, this will say “Disabled.”

4. Select the **Manage Wireless Networks** button and follow the Windows 7 prompts.

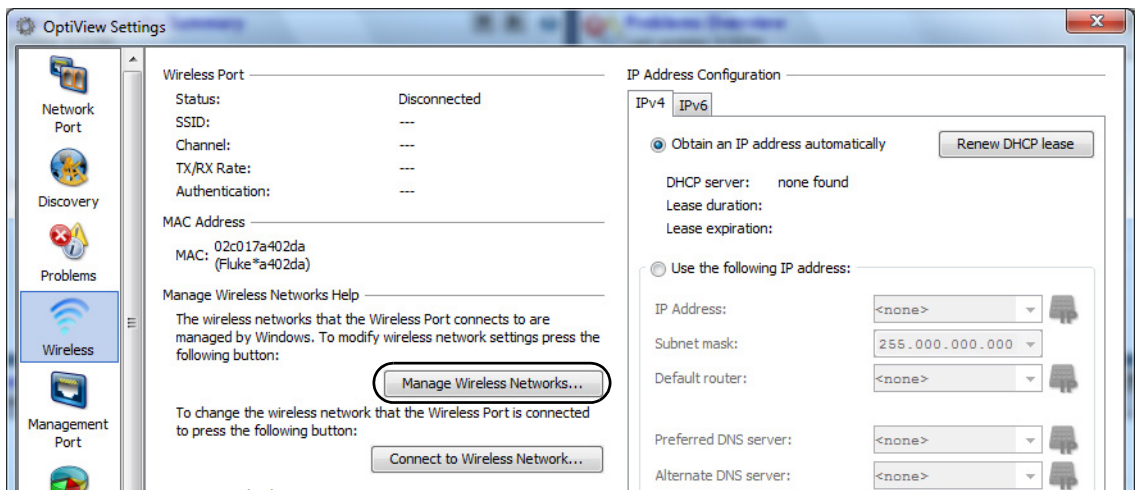

## Connecting to a Wireless Network

1. Select the **Link Status** button.



2. Select the **Wireless** button (which is located at the left side of the screen).

### 3. Select the **Connect to Wireless Network...** button.

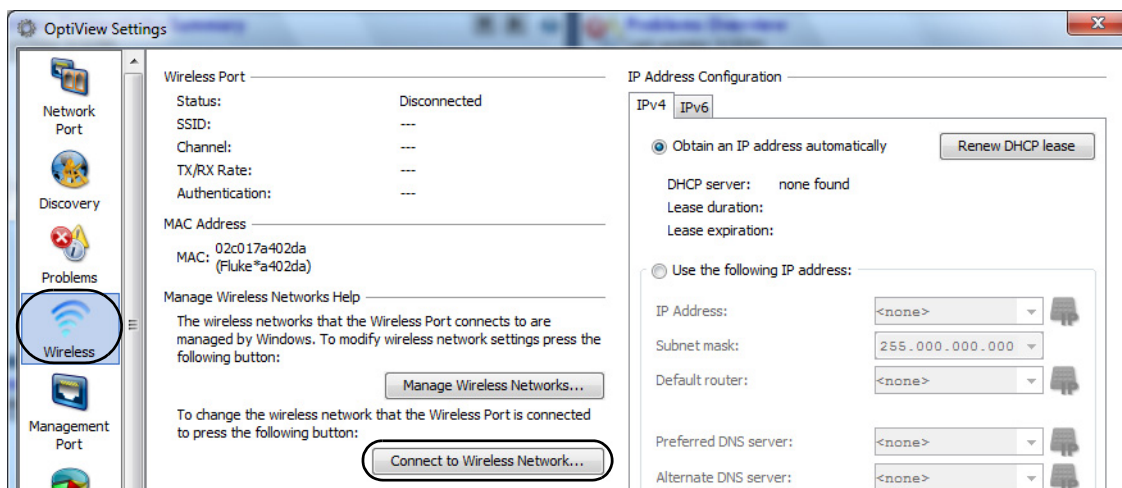

### 4. Select the desired network and follow the Windows 7 prompts.

The OptiView XG will connect to networks based on the profile preferences you create. View and manage your wireless network connections by selecting the **Manage Wireless Networks...** button shown in step 3.

## Wi-Fi Indicators

Each of the two Wi-Fi adapters has a single link status indicator. The LED illuminates when the Wi-Fi adapter is in use. The LED's color indicates the link speed (or that the Wi-Fi adapter is in use by an AirMagnet application). The LED flashes to indicate traffic is present on the link.

**Table 6. Wi-Fi Indicator**

Color	Link Speed	Standard
Green	up to 11 Mbps	802.11b
Blue	up to 54 Mbps	802.11a/g
White	up to 300 Mbps	802.11n, with one or two spatial streams
Magenta	450 Mbps or more	802.11n, with three spatial streams (3x3)
Amber	Wi-Fi adapter is in use by an AirMagnet application	

## Configuring the OptiView XG for Use with Your Network

1. If your network uses a MAC access list, you will need to add the OptiView XG's MAC addresses to the list. See the OptiView XG online help for more information.
2. Configure SNMP community strings and/or credentials to allow the OptiView XG to fully discover and analyze your network.
  - a. Select the top left OptiView button.
  - b. Select the OptiView Settings button.

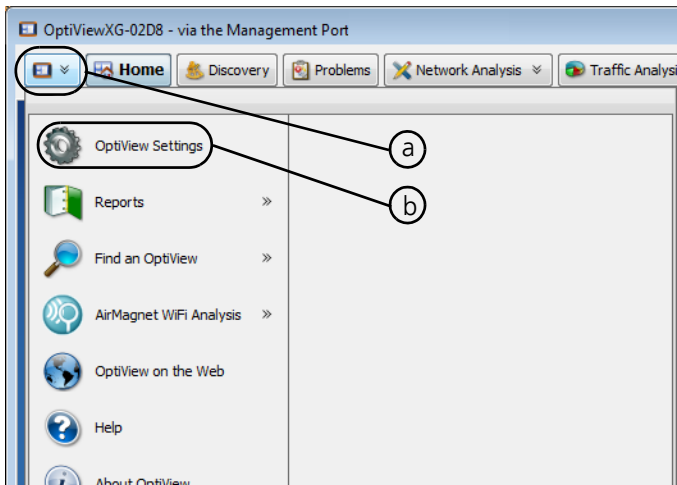

- c. Select the Discovery button.

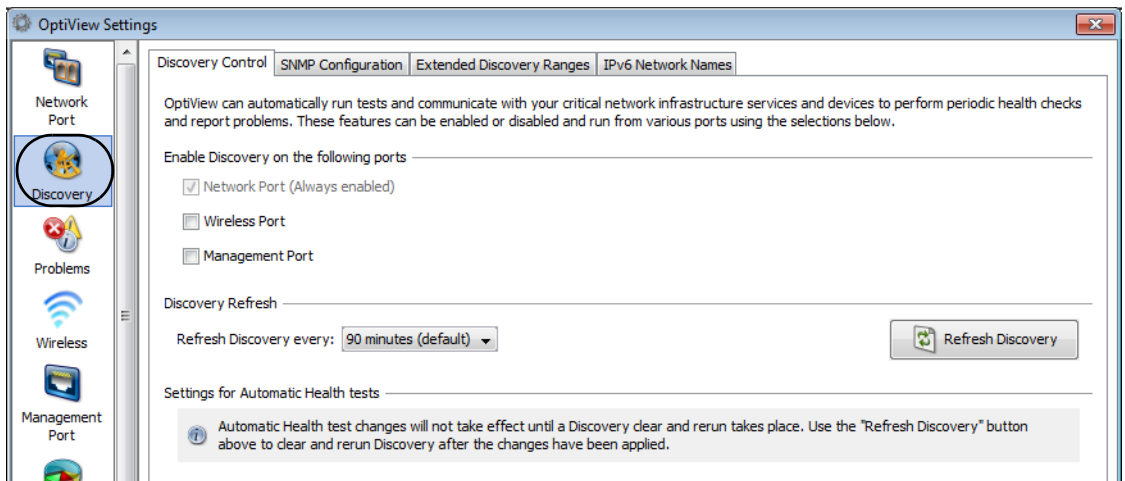

- d. Select the **SNMP Configuration** tab.
  - e. Add SNMP v1 and v2 community strings and/or add SNMP v3 credentials. Select the Help button on the screen for more information.
3. Select the **Extended Discovery Ranges** tab to enable discovery of networks beyond the broadcast domain (off-net networks). Select the Help button on the OptiView Settings screen for more information.

## Context-Sensitive Help System

Select the blue question mark to show help for the current screen.

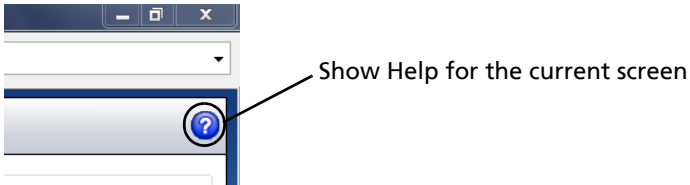

# Operating the OptiView XG on Battery Power

## Battery Operation

The OptiView XG Network Analysis Tablet has two lithium-ion batteries. The batteries are installed into the back of the OptiView XG.

The OptiView XG will run approximately 2 hours using fully-charged batteries. You can hot-swap spare batteries (one at a time if the AC adapter is not connected) to extend run-time.

## Charging the Batteries

Before running the OptiView XG Network Analysis Tablet on batteries, connect the AC adapter to the OptiView XG and charge the batteries. Charge time is approximately 3 hours.

## Power/Charge Indicator

The LED next to the OptiView XG power button indicates the power on/off state and the battery charge status.

**Table 7. Power/Charge Indicator**

LED Color	LED State	Description
Green	On	The OptiView XG is powered-on. Use the battery status window to determine battery charge state. See instructions on page 28.
Yellow	Flashing	The OptiView XG is in sleep mode or powered-off. The AC adapter is connected, and the batteries are charging.
Yellow	On	The OptiView XG is in sleep mode or powered-off. If the AC adapter is connected, the batteries are fully charged.
Off	Off	The OptiView XG is powered-off (shutdown, not in sleep state) and the AC adapter is disconnected.

## Displaying the Battery Charge Status Window

1. The battery status icon is located in the Windows system tray. It appears as a battery, a charging battery, or an electrical plug. Select the icon to open the battery status window.

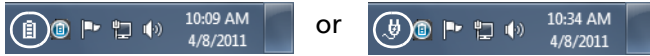

2. The estimated battery capacity is displayed.

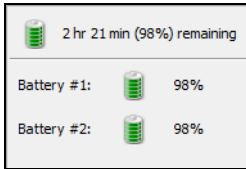

Running on battery power.

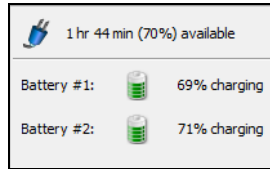

Running on AC power.

3. Touch (or click) the screen outside the battery status window to close the battery status window.

## Battery Charge Indicators (on batteries)

The four LEDs on the back of each battery indicate the battery's approximate charge. Press and release the test button. Each illuminated LED indicates an additional 25% of available charge. When the battery's charge level is less than 10%, the left-most LED flashes.

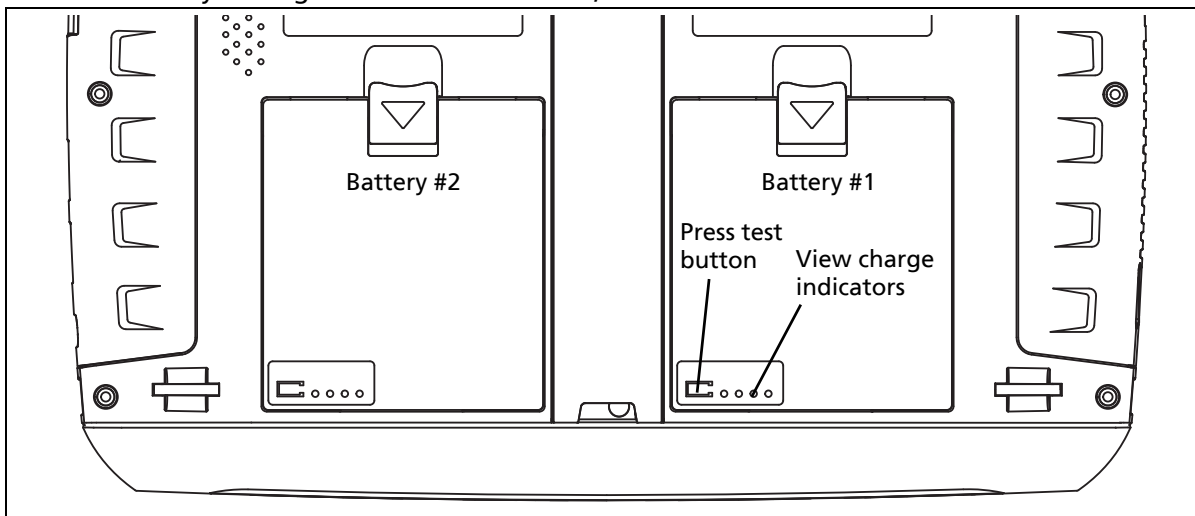

Figure 14. Battery Charge Indicators

GLZ24.EPS



## Replacing/Hot Swapping the Batteries

To remove a battery, (1) press the release clip and (2) pivot the battery out from the OptiView XG case. To replace, pivot the battery in and press until it snaps into place.

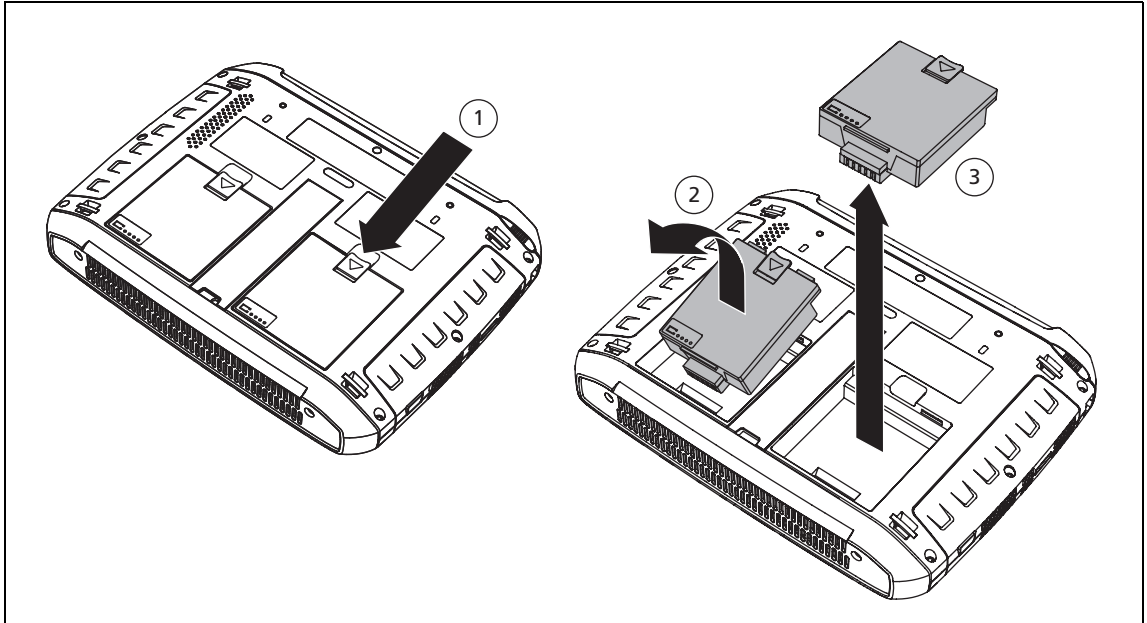

GLZ06.EPS

**Figure 15. Battery Removal and Replacement**

When the AC power adapter is not connected, the OptiView XG is powered by whichever battery contains the most charge. When the batteries have equal amounts of charge, the OptiView XG is powered by both batteries.

The batteries can be hot-swapped. Replacing one battery will not interrupt the OptiView XG's operation as long as the other battery is capable of powering the OptiView XG.

An optional battery kit is available (see page 5). It contains two batteries, a charging station, and an AC adapter for powering the charging station.

## Battery Life in Sleep or Shut down Modes

Two fully-charged batteries will last approximately 36 hours when the OptiView XG is in Sleep mode.

If you plan to leave the OptiView XG in Sleep mode while unplugged from the AC adapter for an extended period, power-off the OptiView XG to avoid fully discharging the batteries.

When the OptiView XG has been powered-off (using Windows Shut down), battery life is determined by the internal discharge rate of the lithium-ion batteries, which is approximately 5-10% per month.

## Battery Care

To maximize the life of lithium-ion batteries, avoid frequent full discharges. Partial discharges with frequent recharges will make the batteries last longer. Lithium-ion battery technology does not suffer from the “memory effect,” so recharge the batteries whenever it’s convenient. Avoid storing the batteries in a hot environment. For optimal long-term storage, store at about 50% charge, in a cool place.

## Extending Battery Operating Time

In its default configuration, the OptiView XG will operate for approximately two hours with fully-charged batteries.

When only using the wireless adapters to connect to the network (not using Network Ports A, B, C, or D) you can approximately double operating time by switching off power to the network ports. You may want to do this when using the following (optional) applications for an extended period of time for field operations:

- AirMagnet WiFi Analyzer PRO
- AirMagnet Spectrum XT
- AirMagnet Survey PRO

## To Switch Off Power to Network Ports A, B, C, and D

1. Select the **OptiView Power Control** icon from the System Tray.



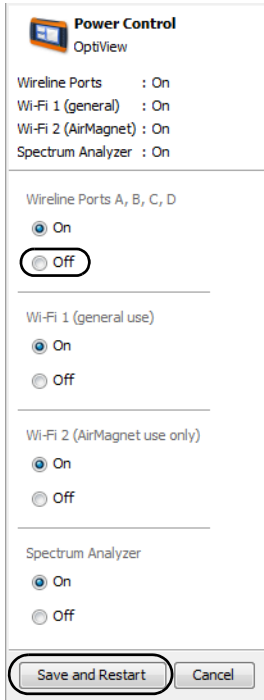

The **OptiView Power Control** screen will appear, as shown.

2. Switch off **Wireline Ports A, B, C, and D**. This will approximately double battery operation time.

3. The system must reboot to make the change. Select the **Save and Restart** button.

*Note*

*Remember to switch on Wireline Ports A, B, C, and D before attempting to use the Network Ports!*

## Using the Touchscreen, Stylus, Keyboard, and Mouse

### Multi-Touch Screen Use and Care

The Multi-Touch Screen supports Windows 7 multi-touch gestures such as Flicks and right-click.

Clean the touchscreen using a soft cloth that has been moistened with mild detergent. Do not spray liquid directly on the touchscreen because the liquid could seep into the OptiView XG housing. Do not use harsh cleaners on the touchscreen.

See also: "Stylus" on page 16.

### Multi-Touch Screen Calibration

The OptiView XG uses a standard Windows 7 touchscreen driver. To calibrate the touchscreen:

1. Select the Windows button  (in the lower left corner of the display).
2. Select **Control Panel**.
3. Select **View by: Small Icons**. This selector is in the upper right area of the screen.
4. Select **Tablet PC Settings**.
5. In the **Tablet PC Settings** window, select the **Calibrate** button.
6. Follow the prompts.

## Touchscreen Features (Right-click, etc.) and Virtual Keyboard Settings

You can customize certain tablet PC features in Windows 7, including “Pen and Touch” and the “Input Panel.” For example, you can adjust the amount of time you need to touch and hold a point on the screen in order to perform a right-click. The right-click is performed when the touch point is circumscribed.

1. Select the Windows button  (in the lower left corner of the display).
2. Select **Control Panel**.
3. (Ensure **View by: Category** is selected in the upper right area of the screen.)
4. Select **Tablet PC Settings**.
5. Select the tab labeled **Other**.
6. Use the links to customize Pen and Touch and Virtual Keyboard (also called Input Panel) settings.

## Virtual Keyboard

The virtual keyboard lets you type without a hardware keyboard. This is convenient when you are on-site with the OptiView XG and a hardware keyboard is not connected.

### To Use the Virtual Keyboard

1. Touch the left edge of the screen to reveal the edge of the virtual keyboard. Note that you can drag the minimized keyboard up or down if it's in your way.

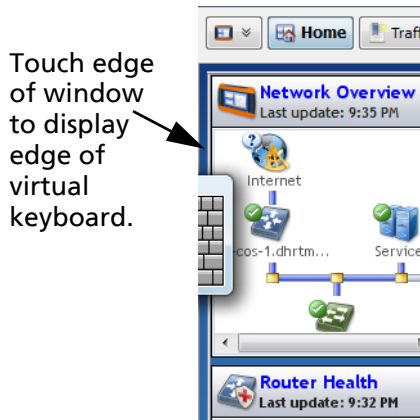

2. When the edge of the keyboard appears, touch it again and it will come into full view. Touch the keys to type. If desired, you can drag the keyboard to a different location on the screen.



3. After use, select the X to close the keyboard.

## Connecting External Devices

### Keyboard, Mouse, Flash Drive, Printer, and Other USB Devices

You can connect an external keyboard, mouse, flash drive, hard drive, or printer to the OptiView XG's USB ports. Windows 7 will automatically recognize the devices and make them ready to use. See page 10 and page 11 for the locations of the USB ports.

### External eSATA Hard Drive

You can connect an external eSATA drive using a shielded cable with a length of one-half meter or less. Restart Windows or use Control Panel→Device Manager→Action→Scan for Hardware Changes to cause Windows to recognize the drive. Note that the eSATA connector does not supply power. An external power supply must power the eSATA drive. See page 11 for the location of the eSATA port.

### External Antenna

The OptiView XG normally uses its internal antennas. When using AirMagnet applications (e.g. for locating rogues or performing spectrum analysis) you can attach and switch to an external antenna. See page 18 for the location of the external antenna connector.

The optional omni-directional antenna offers better scanning sensitivity when using AirMagnet Spectrum XT.

The optional directional antenna can be used in conjunction with AirMagnet Wi-Fi Analyzer PRO and Spectrum XT applications for increasing signal sensitivity when locating devices.

The directional antenna can be attached to the OptiView XG as shown in Figure 16, "Attaching and Swiveling the Directional Antenna."

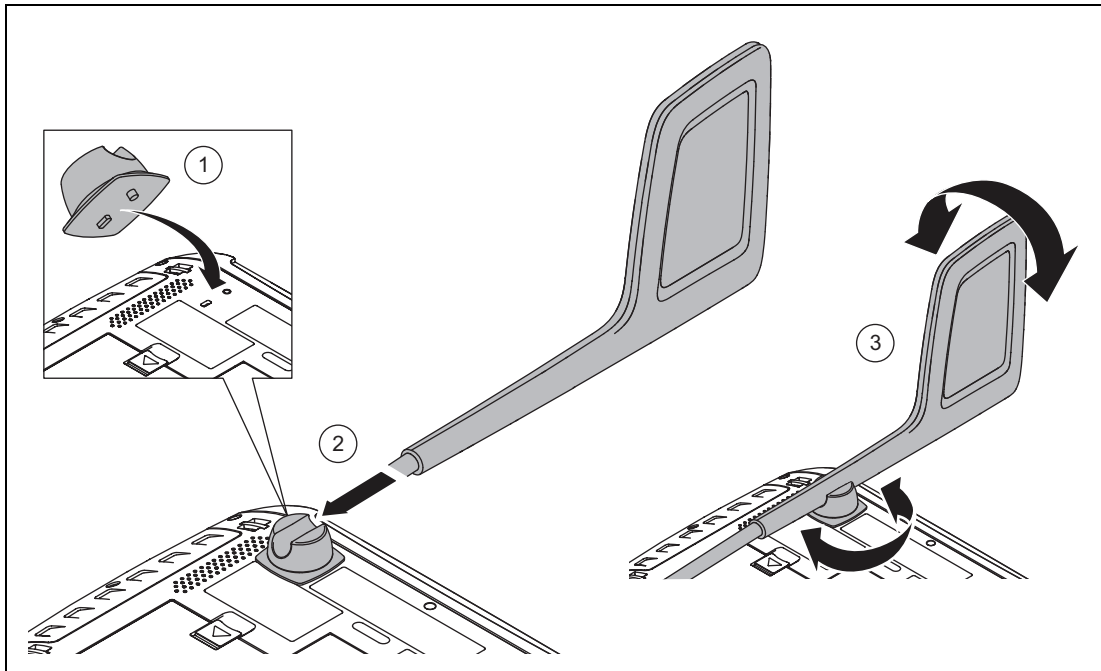

GLZ23.EPS

Figure 16. Attaching and Swiveling the Directional Antenna

## Power Connector

Connect only the supplied AC adapter to the power connector. Connection of any other power source may damage the OptiView XG. See page 13 for the location of the power connector.

## VGA Port for External Monitor

You can connect an external monitor or projector to the VGA port. When connecting to a projector, go to the Windows 7 Control Panel and select **Connect to a projector** under the **Hardware and Sound** heading. See page 11 for the location of the VGA port.



## Controlling the OptiView XG from a Remote Computer

The Remote User Interface application lets you initiate remote sessions with OptiView units over a TCP/IP connection. The software includes a browser that helps you easily find OptiView units and initiate remote sessions.

### Remote PC Requirements

Operating Systems:

- Windows® XP Professional with SP3
- Windows® 7 Professional with SP1, 32 bit and 64 bit

Operating System Languages:

- English, German, Japanese, Simplified Chinese

### Installing the Remote User Interface

The remote user interface software may be installed from the supplied OptiView Resource flash drive, or from the OptiView XG's web server home page.

#### Install from Flash Drive

To install from the flash drive, insert the flash drive in the remote PC's USB port and follow the prompts. If autorun is disabled, execute the Launch.exe file in the flash drive's root directory.

#### Install from the OptiView XG's Home Page

To view the OptiView XG's Home page, enter the OptiView XG's IP address in your PC's web browser. Then select the **Install Remote UI** button.

## Using the Remote User Interface

### Launch OptiView Browser

The first step in using the Remote User Interface is to launch the OptiView Browser. Double-click the desktop icon or select it from the Windows Program Menu. It is in the Fluke Networks program group. The OptiView Browser will launch, and a list of the analyzers in the local network will be displayed.

### Initiate a Remote Session

To initiate a remote session with an OptiView, double-click it in the search results window.

To see an OptiView that is not in the broadcast domain, enter the IP address of the unit in the search bar of the OptiView Browser.

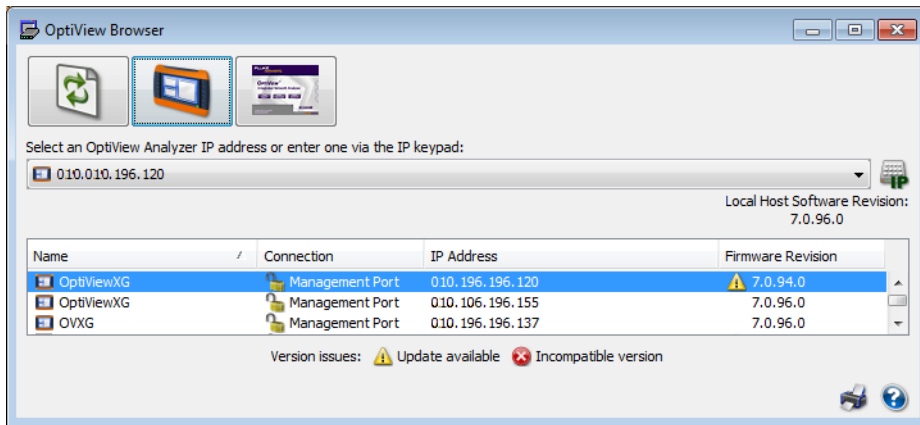

Once you've established a connection, you can close the OptiView Browser window if desired. This will not terminate the remote session.

## Encrypting Data Over the Remote User Interface

A computer can initiate a remote session with an OptiView (see page 37). Data sent to and from the remote analyzer can be encrypted. The OptiView XG uses the Advanced Encryption Standard (AES) 128 bit encryption algorithm. The encryption key can be entered in Hex or ASCII. ASCII is provided for ease of remembering the encryption key. An encryption key containing less than 128 bits (16 ASCII characters) will be padded with 0's.

When an encryption key has been set, each user attempting to open a remote UI session with the OptiView XG will be prompted to enter the encryption key. When a remote encrypted session has been established via a remote PC, the encryption key will be remembered on the remote PC (and it will not have to be entered again).

### Caution

**For security reasons, encryption should be set directly on the OptiView XG and not through a remote session. A remote UI could be capturing packets (and the transmitted encryption key) while another remote UI is setting the data encryption.**

## To Set Up Remote User Interface Encryption

1. Select the **Link Status** button.



2. Select the **Access** button.

### 3. Select the **Remote Access** tab.

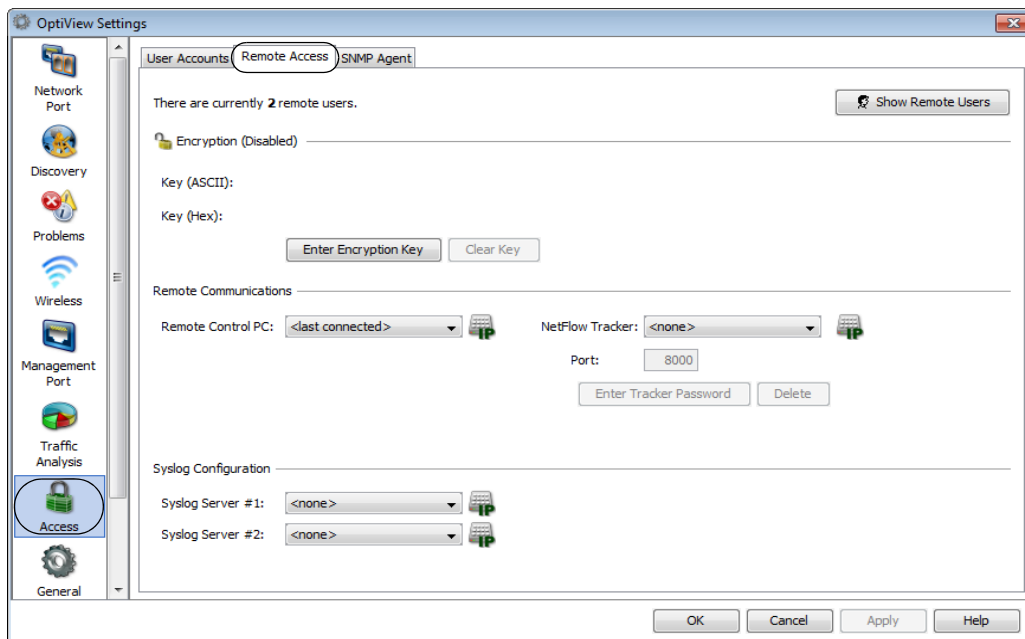

### 4. Press the **Enter Encryption Key** button.

### 5. Select ASCII or Hexadecimal and enter the key. This key will be required when a remote user attempts to initiate a remote session.

You can clear the encryption key by pressing the **Clear Key** button.

## Remote Connection Termination

To terminate a remote connection, close the OptiView Remote User Interface window on the remote computer.

The remote connection will be terminated if the OptiView XG's MAC or IP address is changed, encryption is changed, cable test is executed, the OptiView XG is switched to receive-only mode, or if the TCP/IP session is terminated for any reason.

## Security

It is common practice to leave the OptiView XG powered-on and connected to a network. This lets you become familiar with devices on the network and normal traffic patterns. However, it is important to secure the OptiView XG from theft and unauthorized use.

You can physically secure the OptiView XG in place using a Kensington® lock. You can lock the OptiView XG by locking Windows. And you can create user accounts with specific privileges.

### Physical Security: Kensington Lock

Kensington security slots are provided on the OptiView XG housing. You can reduce the chance of theft by purchasing a Kensington lock and using it to secure the OptiView XG in place.

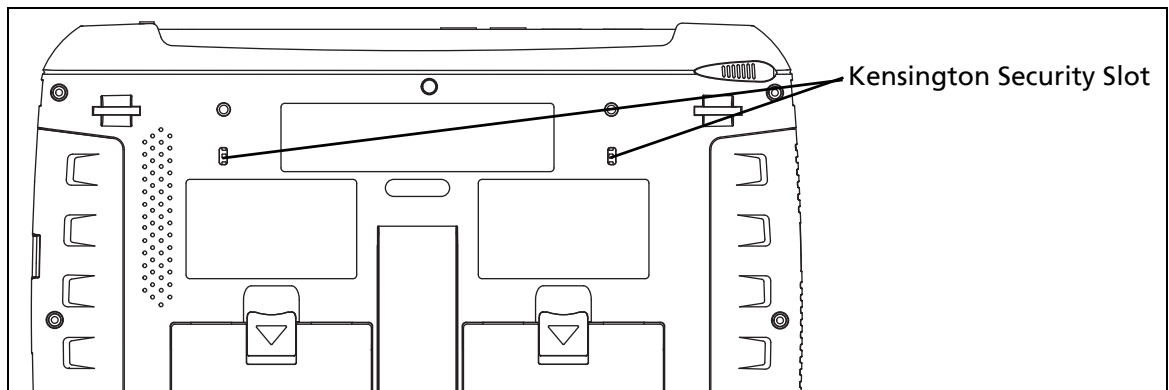

GLZ08.EPS

Figure 17. Kensington Security Slot

## Controlling Access to the OptiView XG

### Locking Windows 7

When the OptiView XG is connected to a network and running, and you want to leave it unattended, you can restrict access by locking Windows 7. Press Ctrl+Alt+Del and choose **Lock the computer**. However, this only provides protection if you have set up a user account in Windows 7. Otherwise, the OptiView XG can be unlocked by pressing the Enter key.

### OptiView XG User Accounts

To control access to certain features of the OptiView XG, set up a User Account for each user. Permissions can be set for each user. The **admin** account must be enabled prior to setting up additional user accounts.

### To Set Up User Accounts

1. Select the **Link Status** button to display the OptiView Settings screen.



2. Select the **Access** button.
3. Select the **User Accounts** tab.

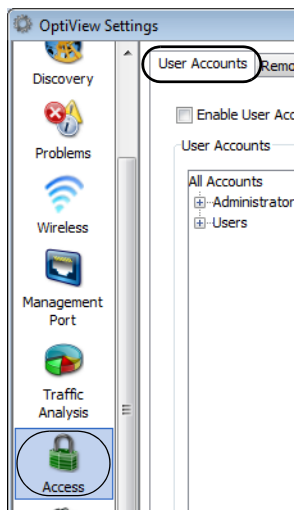

4. Expand the Administrators tree and select the **admin** account.

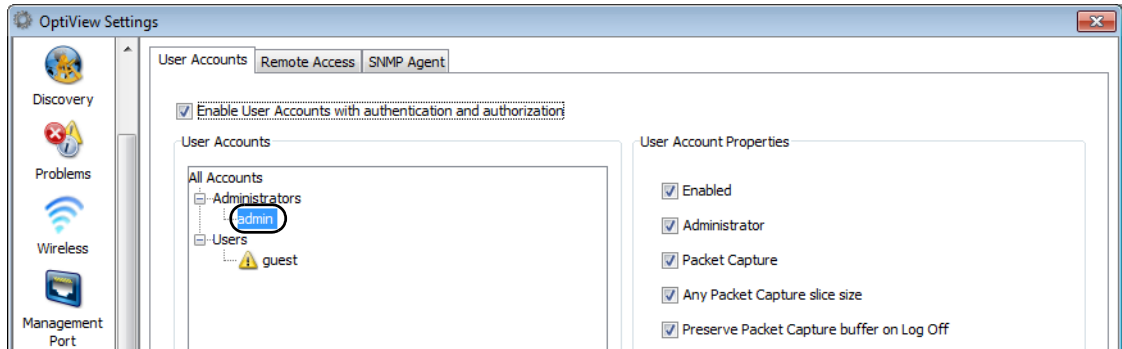

5. Select the **Create Password** button and enter a password. The password field can be up to 40 characters in length. All characters (including spaces) are allowed for the password field.

6. Select the **Enabled** check box under User Account Properties.

Choose options under User Account Properties by checking the check boxes. Normally, all of the boxes are selected for the administrator account. See the OptiView XG online help for descriptions of the User Account check boxes.

7. Select the **Apply** button.

8. *Be sure to select the **Enable User Accounts with authentication and authorization** check box!* When this box is not selected, all user accounts are disabled.

- You may now create additional user accounts if desired. Select the **guest** account if you'd like to use it, or select the **Add** button to create new accounts. The Account name and password fields can be up to 40 characters in length. All characters (including spaces) are allowed for both the Account and password fields.

9. Select the **OK** button.

The user name ("admin" in this case) is displayed in the OptiView title bar.

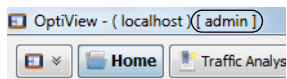

An icon is displayed to the left of an account name to indicate that the user is logged-in.

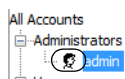

To log off, close the OptiView application by selecting the “X” in the upper right corner or by typing Alt+F4. You will need to log in (as admin or a user) whenever you re-start the OptiView XG Network Analysis Tablet or the OptiView application.

- You can create up to 32 user accounts.
- For remote users, the encryption challenge occurs before the login challenge.



## Removing and Replacing the Hard Drive

The hard drive can be removed from the OptiView XG for secure data management.

### ⚠ Caution ⚠

To prevent damage to the OptiView XG and/or the removable hard drive, use standard ESD (electrostatic discharge) control procedures and equipment.

### Removing the Hard Drive

The analyzer's "Computer name" is stored on the hard drive. You can view the Computer name by following the instructions in "Computer Name" on page 46. If desired, make note of the analyzer's Computer name so you can restore it after replacing the hard drive.

1. Power-off the OptiView XG by selecting Shut down in Windows 7.
2. Disconnect all cables from the OptiView XG.
3. Use a Phillips screwdriver to remove the two screws that secure the bottom panel.
4. Slide the hard drive out.

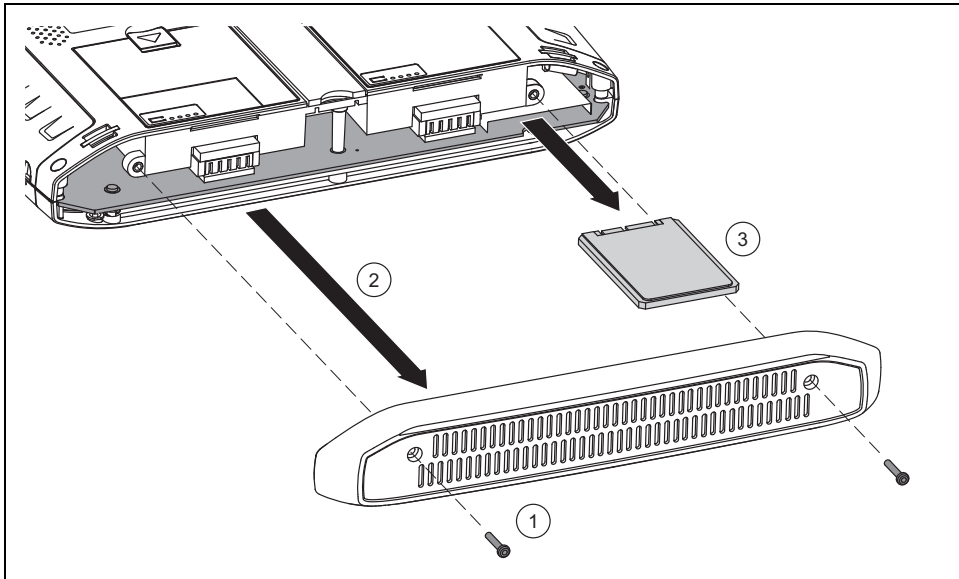

GLZ10.EPS

Figure 18. Replacing the Hard Drive

## Replacing the Hard Drive

To replace the hard drive, reverse the preceding procedure.

The touchscreen calibration data is stored on the hard drive. You will need to re-calibrate the touchscreen after replacing the hard drive. See “Multi-Touch Screen Calibration” on page 32.

## Computer Name

The analyzer’s name is stored on the hard drive. You can change the analyzer’s name as follows.

1. Select the Windows 7 Start button.
2. Right-click (or touch and hold) **Computer**.
3. Select **Properties**.
4. Select **Change settings** in the Computer name, domain, and workgroup settings section.

## Cleaning

Clean the OptiView XG housing, the touchscreen, and the batteries using a soft cloth that has been moistened with mild detergent. Dry with a soft cloth. Do not spray liquid directly on the OptiView XG or the batteries. Do not use harsh cleaners. Do not immerse.

## Troubleshooting

If the OptiView XG is not operating as expected, refer to this table for possible causes and solutions.

**Table 8. Troubleshooting Guide**

Problem	Possible Cause & Solution
Cannot establish a network connection.	The OptiView XG's MAC addresses have not been added to the network's MAC access list.
The OptiView XG fails to get an IP address.	<p>There may be no connectivity to a DHCP server on the link. This could be caused by a DHCP server that is not responding to requests, in which case you would want to investigate the health of the DHCP server.</p> <p>If the analyzer is connected to a trunk port, ensure that the selected VLAN has connectivity to an operational DHCP server, or switch to a different VLAN.</p> <p>Instructions for switching to a different VLAN:</p> <ol style="list-style-type: none"> <li>1. Select the <b>Link Status</b> button. This opens the OptiView Network Port Settings screen.</li> <li>2. In the Active VLAN Configuration section, select a VLAN that has connectivity to a DHCP server.</li> <li>3. Select the <b>OK</b> button at the bottom of the screen.</li> </ol>
Cannot establish a Wi-Fi connection.	Enable Wi-Fi adapters. See page 20.
Cannot establish a network connection on network ports A, B, C, or D.	Enable the Network Ports by switching on power to Network Ports A, B, C, and D. See page 30.
The OptiView XG is not reporting all of the expected networks, devices, and related detail.	<p>To ensure successful discovery both on-net and off-net, it is critical that you configure Discovery. Select the OptiView button (in the upper left corner of the display), then select the <b>OptiView Settings</b> button. Select the <b>Discovery</b> button (at the left side of the screen).</p> <ol style="list-style-type: none"> <li>1. To ensure access to the information (SNMP-MIBs) on the devices' SNMP agent, configure the SNMP credentials on the <b>SNMP Configuration</b> tab.</li> <li>2. Often the devices' SNMP agents are connected to a different subnet than the one to which the OptiView is connected. These SNMP or Management subnets need to be configured on the <b>Extended Discovery Ranges</b> tab.</li> <li>3. To allow the OptiView to discover networks beyond the subnet to which it is connected, configure the remote subnets for discovery using the <b>Extended Discovery Ranges</b> tab.</li> </ol>

## Windows Restore Options

In the event the Windows 7 operating system becomes unstable, there are two methods for restoring stability.

- Windows System Restore restores the Windows configuration to an earlier point in time without erasing your data files.
- Windows System Recovery erases all data files and returns the Windows system to its original condition. Instructions are provided for backing up your data files before they are erased.

## Windows System Restore

The Windows 7 operating system creates a restore point whenever you install new software. This lets you restore the Windows configuration to an earlier point in time if desired. For example, if you install a driver that when accessed, causes the system to hang, you can restore the Windows operating system using Windows System Restore.

1. Select the Windows button, then select **Control Panel**.
2. In the search box, type System Restore.
3. Select **Restore system files and settings from a restore point**.
4. Follow the prompts.

## Windows System Recovery

In the event the OptiView XG's operating system becomes unstable, and you want to return the OptiView XG to its factory default condition, you can restore the hard drive using the System Recovery utility. This will effectively erase changes that were made since the OptiView XG left the factory. It will leave the OptiView XG's operating system and file system in a known, working state.

### Caution

Performing a System Recovery will

- Erase all report, capture, and other data files
- Erase all OptiView XG user accounts and passwords
- Remove all user-installed applications
- Return the OptiView XG to its factory default configuration

The OptiView XG's MAC address, purchased software options, and OptiView Power Control settings will be preserved.

### ⚠ Caution

The OptiView XG could be rendered inoperable if the System Recovery process is interrupted. The AC adapter (not batteries) should be used to power the OptiView XG during the recovery process.

## Procedure

### Back Up Your Files

If you want to keep any files that currently exist on the OptiView XG's hard drive, use Windows Backup to save them to an external drive. You will need to deselect the "postgres" user account from the backup.

1. Select the Windows button, then select **Control Panel**.
2. Set the view control to **View by: Small icons**.
3. Select **Backup and Restore**.

Note that if you have previously set up a backup, the "Set up backup" button will not appear on this screen. In that case you will need to choose **Control Panel**→**Recovery**→**Advanced recovery methods**→**Reinstall Windows**→**Back up now** and then proceed to step 5.

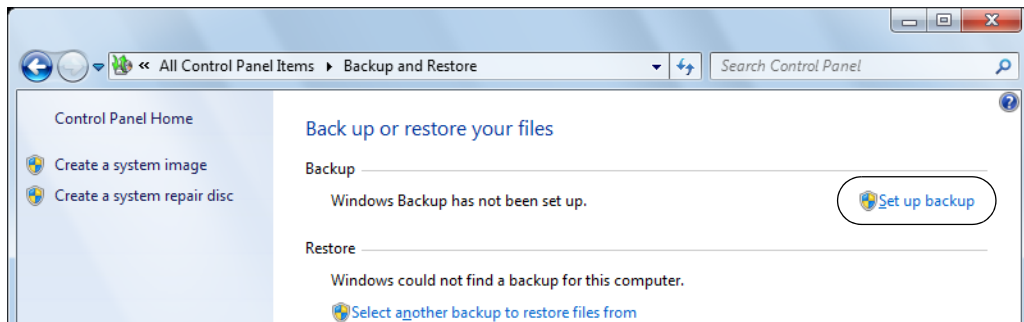

4. Select **Set up backup**.

5. Choose an external destination drive for the backup.

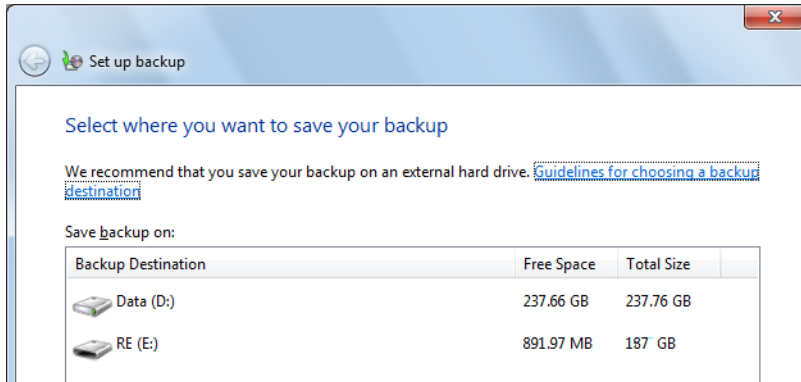

6. At the screen that says "What do you want to back up?" select **Let me choose** and select **Next**.

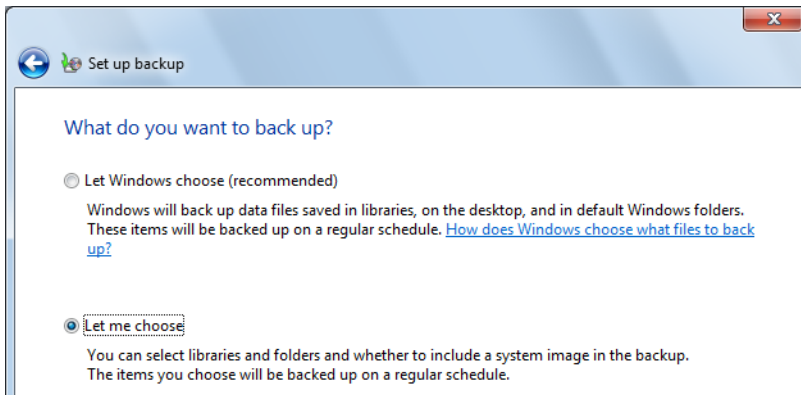

7. At the “What do you want to back up?” screen deselect **postgres’s Libraries** and deselect **Include a system image....**

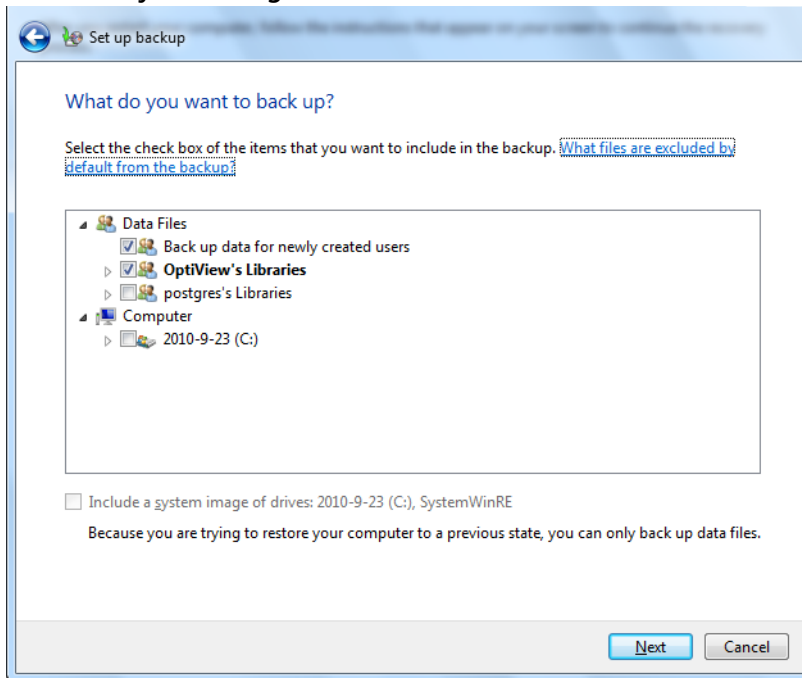

8. At the “Review your backup settings” screen ensure that OptiView’s Libraries are included and postgres’s Libraries are not included.
9. Select **Save settings and run backup**.
10. When the backup completes, disconnect the external drive from the OptiView XG.

## Restore Windows System Files

1. Disconnect all cables from the OptiView XG except the AC adapter, the keyboard, and the mouse.
2. Select the Windows 7 button and Restart the OptiView XG. When the Fluke Networks splash screen appears, press the F8 key multiple times.
3. The Advanced Boot Options screen will appear. Verify that **Repair Your Computer** is selected, then press **Enter**.
4. You can now use the mouse to make your selections. Follow the prompts to choose a language.

5. At the User name and Password window, select the drop-down selector.
6. Select **OptiView** as the User name. You do not need to type anything in the Password box unless you have created a password for this user.
7. Select **OK**.
8. At the Choose a recovery tool window, choose **Reinstall Windows**.

The recovery image will be written to the disk, and the old operating system's directory will be renamed C:\Windows.old. The C:\Windows.old directory consumes several gigabytes of storage space on the disk. Verify that you have already saved any data files you need, then use the Windows Disk Cleanup tool to delete all files (including hidden system files) in the C:\Windows.old directory, as described below.

### **Post-Recovery File Clean-Up**

1. Select the Windows Start Button, then type "free up disk space" in the search box.
2. Choose **Free up disk space by deleting unnecessary files**.
3. In the Drive Selection window, select the C: drive and wait for scanning to complete.
4. Select the **Previous Windows installation(s)** check box.
5. Select the **Temporary Windows installation files** check box.
6. Select or deselect other check boxes as desired.
7. Select **OK**.
8. Select **Delete Files**. The selected files will be deleted.
9. If you previously backed up data files to an external drive, connect the drive and use Windows 7 Backup and Restore to restore your data files.



## Specifications

### Physical Specifications

Dimensions (H,W,D)	9.45" x 12.43" x 2.03" (240 mm x 315.7 mm x 51.6 mm)
Weight	5.5 lb. (2.5 kg) with batteries; 4.5 lb. (1.8 kg) without batteries
Kensington Lock	Kensington security slot on rear panel for connection of security cable

### Environmental Specifications

Operating Temperature <sup>1</sup>	32°F to 122°F (0°C to 50°C), up to 40% RH, non-condensing 32°F to 86°F (0°C to 30°C), up to 95% RH, non-condensing
Storage Temperature	-40°F to +160°F (-40°C to +71°C)
Shock and Vibration	Meets requirements of MIL-PRF-28800F for Class 3 equipment
Safety	EN 61010-1 2nd Edition
Altitude <sup>2</sup>	4600 m (15,000 ft.); Storage: 12000 m (39,000 ft.)
Pollution Degree 2	Normally only nonconductive pollution occurs. Temporary conductivity caused by condensation is to be expected.

<sup>1</sup> Battery charging is disabled when internal temperature rises above 113°F (45°C).

<sup>2</sup> Altitude specification applies to OptiView XG and batteries. Maximum altitude for adapter is 2000 m (6,600 ft.).

## Electrical Specifications

AC Adapter Input	90-264 VAC, 47-63 Hz, 2.0 A max
AC Adapter Output	19 VDC, 4.74 A, 90 W
	<b>⚠ Caution:</b> For safe operation, use only the supplied adapter.
Battery	Two user-replaceable, rechargeable, 45 Watt-hour, lithium-ion battery packs.
Battery Operating Time	2 hr. (typical)
Battery Charge Time*	3 hr. (typical). Charge time depends on residual battery charge and analyzer power consumption while charging batteries.
Display	Color LCD (1024 x 768 pixels) touchscreen
Network Analysis Ports	Two 10/100/1000 Mbps RJ45 Ethernet ports
	1000BASE-FX SFP socket
	10000BASE-X SFP+ socket
Management Port	10/100/1000 Mbps RJ45 Ethernet connector
Supported SFP Modules	100BASE-FX - 1300 nm
	1000BASE-SX - 850 nm
	1000BASE-LX - 1310 nm
	1000BASE-ZX - 1550 nm
Supported SFP+ Modules	10GBASE-LR - 1310 nm
	10GBASE-LRM - 1310 nm
	10GBASE-SR - 850 nm
Fault Tolerance	RJ45 Ports are designed to withstand a maximum of 100 volts.
USB Ports	Three USB 2.0 ports
eSATA Port	eSATA port for connecting external hard drive
Video Port	Standard VGA port for connection to monitor or projector

\*Battery charging is disabled when internal temperature rises above 113°F (45°C).

## Cables

Cable Types	100 $\Omega$ Unshielded Twisted Pair (UTP) LAN cables. 100 $\Omega$ Shielded or Screened Twisted Pair (SeTP) LAN cables. TIA Category 3, 4, 5, 5e, and 6. ISO Class C, D and E).
Cable Length Measurement	Measurable cable lengths are from 3 feet (0.9 meters) to 500 feet (152 meters). Accuracy: $\pm$ 6 feet ( $\pm$ 2 meters). Length measurement is based on Nominal Velocity of Propagation (NVP) for selected cable type.

## Wireless Antennas

Internal Wireless Antennas	Seven internal 2.4 GHz, 1.1 dBi peak, 5 GHz, 3.2 dBi peak antennas.
External Omni-directional Antenna*	Antenna, WLAN, omnidirectional, 2.4 & 5 GHz, 802.11 A/B/G, 50 $\Omega$ . Gain: 2.1 dBi (2.45 GHz), 2.4 dBi (4.9 GHz), 2.6 dBi (5.25 GHz), 2.5 dBi (5.875 GHz).
External Directional Antenna*	Antenna, frequency range 2.4 - 2.5 and 4.9 - 5.9 GHz. Minimum gain 5.0 dBi peak in the 2.4 GHz band, and 7.0 dBi peak in the 5 GHz band.
External Antenna Connector*	Reverse SMA

\*External Antenna port is receive-only (no transmit).

## Wireless Adapters 1 & 2

Data Rate	802.11a: 6/9/12/24/36/48/54 Mbps 802.11b: 1/2/5.5/11 Mbps 802.11g: 6/9/12/24/36/48/54 Mbps 802.11n (20 MHz): MCS0-23, up to 216 Mbps 802.11n (40 MHz): MCS0-23, up to 450 Mbps		
Operating Frequency	2.412 ~ 2.484 GHz (Industrial Scientific Medical Band) 5.170 ~ 5.825 GHz		
Security	64/128-Bit WEP Key, WPA, WPA2, 802.1x		
Transmit Output Power* (Tolerance:±1.5 dBm)	2.4 GHz 802.11b: 16.58 dBm at 2412 MHz 2.4 GHz 802.11g: 17.64 dBm at 2412 MHz 2.4 GHz 802.11 HT20: 27.17 dBm at 2412 MHz 2.4 GHz 802.11 HT40: 23.24 dBm at 2412 MHz  5725 MHz - 5850 MHz 802.11a: 22.69 dBm at 5825 MHz 802.11n HT20: 25.25 dBm at 5745 MHz 802.11n HT40: 23.83 dBm at 5795 MHz.  5150 MHz - 5250 MHz 802.11a: 13.41 dBm at 5220 MHz 802.11n HT20: 13.91 dBm at 5220 MHz 802.11n HT40: 14.06 dBm at 5230 MHz  5250 MHz - 5350 MHz 802.11a: 17.79 dBm at 5260 MHz 802.11n HT20: 18.91 dBm at 5300 MHz 802.11n HT40: 18.56 dBm at 5270 MHz  5470 MHz - 5725 MHz 802.11a: 16.72 dBm at 5500 MHz 802.11n HT20: 18.46 dBm at 5700 MHz 802.11n HT40: 16.49 dBm at 5670 MHz		
Receive Sensitivity (Tolerance: ±2 dBm)	802.11b: 8% PER -90 dBm	802.11g: 10% PER -80 dBm	802.11n: 2.4 GHz 10% PER -72 dBm@HT20 -70 dBm@HT40
		802.11a: 10% PER -78 dBm	802.11n: 5 GHz 10% PER -70 dBm@HT20 -63 dBm@HT40

<p>Power Consumption (Typical)</p>	<p>Transmitting (Legacy mode, HT20 mode): 870 mA @5 GHz, 700 mA @2.4 GHz.</p> <p>Transmitting (HT40 mode): 900 mA @5 GHz, 750 mA @2.4 GHz.</p> <p>Receiving (Legacy mode, HT20 mode): 550 mA @5 GHz, 520 mA @2.4 GHz.</p> <p>Receiving (HT40 mode): 610 mA @5 GHz, 600 mA @2.4 GHz.</p>
------------------------------------	---

\*The maximum power setting will vary by channel and according to individual country regulations.

## Supported Network Standards

<p>IEEE 10BASE-TX, IEEE 100BASE-TX, IEEE 1000BASE-TX, IEEE 1000BASE-X IEEE 10GBASE-X</p>	<p>RFCs: 1213, 1239, 1285, 1512, 1513, 1643, 2108, 2115, 2127, 2515, 2819, 3592, 3895, 3896, 4188, 4502.</p>
--	--

## Compliance Statements

<p>EMC</p>	<p>Complies with IEC/EN61326-1:2006, class A</p>
<p>Safety</p>	<p>Complies with IEC/EN 61010-1:2001, CAN/CSA C22.2 No. 61010-1-04, ANSI/UL 61010-1:2004, EN/IEC 60825-1:2007, EN/IEC 60825-2:2004+ A1:2007</p>
<p>Telephone</p>	<p>The OptiView XG is NOT designed for connection to a telephone network. The OptiView XG is NOT designed for connection to an ISDN line. Do not connect to a telephone network or ISDN line except through a regulatory agency compliant computer network modem device.</p>

## Federal Communication Commission and Industry Canada Interference Statement

This equipment has been tested and found to comply with the limits for a Class A digital device, pursuant to Part 15 of the FCC and IC Rules. These limits are designed to provide reasonable protection against harmful interference in a residential installation. This equipment generates, uses and can radiate radio frequency energy and, if not installed and used in accordance with the instructions, may cause harmful interference to radio communications. However, there is no guarantee that interference will not occur in a particular installation. If this equipment does cause harmful interference to radio or television reception, which can be determined by turning the equipment off and on, the user is encouraged to try to correct the interference by one of the following measures:

- Reorient or relocate the receiving antenna.
- Increase the separation between the equipment and receiver.
- Connect the equipment into an outlet on a circuit different from that to which the receiver is connected.
- Consult the dealer or an experienced radio or TV technician for help.

FCC Caution: Any changes or modifications not expressly approved by the party responsible for compliance could void the user's authority to operate this equipment.

This device complies with Part 15 of the FCC standard(s). Operation is subject to the following two conditions:

- (1) this device may not cause interference, and
- (2) this device must accept any interference, including interference that may cause undesired operation of the device.

This device complies with Industry Canada licence-exempt RSS standard(s). Operation is subject to the following two conditions:

- (1) this device may not cause interference, and
- (2) this device must accept any interference, including interference that may cause undesired operation of the device.

Le présent appareil est conforme aux CNR d'Industrie Canada applicables aux appareils radio exempts de licence. L'exploitation est autorisée aux deux conditions suivantes :

- (1) l'appareil ne doit pas produire de brouillage, et
- (2) l'utilisateur de l'appareil doit accepter tout brouillage radioélectrique subi, même si le brouillage est susceptible d'en compromettre le fonctionnement.

Under Industry Canada regulations, this radio transmitter may only operate using an antenna of a type and maximum (or lesser) gain approved for the transmitter by Industry Canada.

To reduce potential radio interference to other users, the antenna type and its gain should be so chosen that the equivalent isotropically radiated power (e.i.r.p.) is not more than that necessary for successful communication.

Conformément à la réglementation d'Industrie Canada, le présent émetteur radio peut fonctionner avec une antenne d'un type et d'un gain maximal (ou inférieur) approuvé pour l'émetteur par Industrie Canada.

Dans le but de réduire les risques de brouillage radioélectrique à l'intention des autres utilisateurs, il faut choisir le type d'antenne et son gain de sorte que la puissance isotrope rayonnée équivalente (p.i.r.e.) ne dépasse pas l'intensité nécessaire à l'établissement d'une communication satisfaisante.

### **OptiView XG Identification Numbers**

FCC ID: WA7-OPTIVIEW-XG

IC ID: 6627C-OPTIVIEW-XG

## Exposure to RF Energy

THIS MODEL DEVICE MEETS U.S. AND INTERNATIONAL REQUIREMENTS FOR EXPOSURE TO RADIO FREQUENCY RADIATION.

The OptiView XG is a radio transmitter and receiver. It is designed and manufactured not to exceed the emission limits for exposure to radio frequency (RF) energy set by the Federal Communications Commission of the U.S. Government and by the International Commission on Non-Ionizing Radiation Protection (ICNIRP). The device also meets the European Radio and Telecommunications Terminal Equipment (R&TTE) directive, for protecting the health and safety of the user and other persons.

These limits are part of comprehensive guidelines that establish permitted levels of RF energy for the general population. The guidelines are based on standards that were developed by independent scientific organizations through periodic and thorough evaluation of scientific studies. The standards include a substantial safety margin designed to assure the safety of all persons, regardless of age and health.

Before a device model is available for sale to the public, it must be tested and certified to operate within the limits for safe exposure established by the FCC and international organizations. The tests are performed in positions and locations (e.g., next to the body) as required by the FCC for each model. The FCC has granted an Equipment Authorization for this model device with all reported SAR levels (see below) evaluated as in compliance with the FCC RF emission guidelines.

This device meets RF exposure guidelines when the antennas are positioned at a minimum distance from the body. In order to transmit data or messages, this device requires a quality connection to the network. In some cases, transmission of data or messages may be delayed until such a connection becomes available. Be sure that the recommended distance is observed until the transmission is complete.

The exposure standard for wireless devices employs a unit of measurement known as the Specific Absorption Rate, or SAR. Tests for SAR are conducted using standard operating positions specified by the FCC with the device transmitting at its highest certified power level in all tested frequency bands. The SAR limit set by the FCC is 1.6 W/kg. The international guidelines state that the SAR limit for mobile devices used by the public is 2.0 W/kg averaged over 10 grams of body tissue. SAR values may vary depending on national reporting requirements and the network band. Although the SAR is determined at the highest certified power level, the actual SAR level of the device while operating can be well below the maximum value because the device operates at multiple power levels and uses only the power required to reach the network.

SAR information on this model device is on file with the FCC and can be found under the Display Grant section <http://www.fcc.gov/oet/fccid> after searching on FCC ID: WA7-OPTIVIEW-XG.



## Europe-EU Declaration of Conformity

This device complies with the essential requirements of the R&TTE Directive 1999/5/EC. The following test methods have been applied in order to prove presumption of conformity with the essential requirements of the R&TTE Directive 1999/5/EC:

- EN61010-1: 2001 A11: 2004  
Safety requirements for electrical equipment for measurement, control, and laboratory use
- EN50385: (2002-08)  
Product standard to demonstrate the compliance of radio base stations and fixed terminal stations for wireless telecommunication systems with the basic restrictions or the reference levels related to human exposure to radio frequency electromagnetic fields (110 MHz to 40 GHz) -General public
- EN 300 328 V1.7.1: (2006-10)  
Electromagnetic compatibility and Radio spectrum Matters (ERM); Wideband Transmission systems; Data transmission equipment operating in the 2.4 GHz ISM band and using spread spectrum modulation techniques; Harmonized EN covering essential requirements under article 3.2 of the R&TTE Directive
- EN 301 893 V1.4.1: (2007-07)  
Broadband Radio Access Networks (BRAN);5 GHz high performance RLAN; Harmonized EN covering essential requirements of article 3.2 of the R&TTE Directive
- EN 301 489-1 V1.6.1: (2005-09)  
Electromagnetic compatibility and Radio Spectrum Matters (ERM); Electromagnetic Compatibility (EMC) standard for radio equipment and services; Part 1: Common technical requirements
- EN 301 489-17 V1.2.1 (2002-08)  
Electromagnetic compatibility and Radio spectrum Matters (ERM); ElectroMagnetic Compatibility (EMC) standard for radio equipment and services; Part 17: Specific conditions for 2.4 GHz wideband transmission systems and 5 GHz high performance RLAN equipment

This device is a 2.4 GHz wideband transmission system (transceiver), intended for use in all EU member states and EFTA countries, except in France and Italy where restrictive use applies.

In Italy the end-user should apply for a license at the national spectrum authorities in order to obtain authorization to use the device for setting up outdoor radio links and/or for supplying public access to telecommunications and/or network services.

This device may not be used for setting up outdoor radio links in France and in some areas the RF output power may be limited to 10 mW EIRP in the frequency range of 2454 MHz to 2483.5 MHz. For detailed information the end-user should contact the national spectrum authority in France.

## Japan

電波法により 5 GHz 帯は屋内使用に限ります  
(5 GHz radio band method is limited to indoor use.)

## Brazil

Este equipamento opera em caráter secundário, isto é, não tem direito a proteção contra interferência prejudicial, mesmo de estações do mesmo tipo, e não pode causar interferência a sistemas operando em caráter primário.

(This equipment operates on a secondary basis and, consequently, must accept harmful interference, including from stations of the same kind, and may not cause harmful interference to systems operating on a primary basis.)

## Korea

해당 무선설비는 전파혼신 가능성이 있으므로 인명안전과 관련된 서비스는 할 수 없습니다.  
(This radio equipment has the possibility of radio interference and this equipment can not provide function related to health and/or safety.)

- 무선사양: (Wireless specification)

사용주파수 (Used frequency): 2.4 GHz, 5 GHz

채널수 (Number of channels): 38

공중선전력(전계강도) (Antenna Power): 1.1 dBi @ 2 GHz, 3.2 dBi @ 5 GHz

변조 방식 (Type of modulation): OFDM, DSSS

- 인증 사항 표시 (Information for KCC approval)

인증자 상호 (Applicant): Fluke Corporation

기기의 명칭 (Type of equipment): Test and Measurement

모델명 (Model name): OptiView XG

제조연월 (Year of manufacture): 2011

제조자/제조국가 (Manufacturing country of origin): USA

인증자 식별부호 (Applicant code): FKN-OPTIVIEW XG

## Contacting Fluke Networks

Web: [www.flukenetworks.com/contact](http://www.flukenetworks.com/contact)

e-mail: [support@flukenetworks.com](mailto:support@flukenetworks.com)

Phone:

- Australia: 61 (2) 8850-3333 or 61 (3) 9329 0244
- Beijing: 86 (10) 6512-3435
- Brazil: 11 3759 7600
- Canada: 1-800-363-5853
- Europe: +31-(0) 40 2675 600
- Hong Kong: 852 2721-3228
- Japan: 03-6714-3117
- Korea: 82 2 539-6311
- Singapore: +65-6799-5566
- Taiwan: (886) 2-227-83199
- USA: 1-800-283-5853

