

# Tubular Motor- DM18LE/S Specification

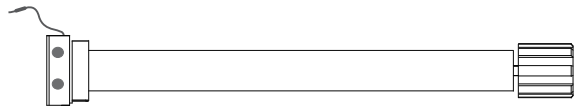

(A-00)

## Product introduction

⚠ Note: When the battery power is low, you can hear the alarm ten "beep" every time the motor runs. It indicates the battery needs to be charged. Then plug in the charger with red light. The light turns green when the battery is fully charged.

Signal wire



Functional features:

- Integrated radio control
- Setting up+add emitter+delete emitter
- Motor direction setting option
- Resistance stop function
- Jogging&tilt function
- Set electronic limit
- Set /delete the third limit position
- Low standby power



Parameter

Type	DM18LE/S
Rated Torque(N.m)	0.2N.m
Rated speed(RPM)	80RPM
Rated Voltage(V)	12V
Emission frequency(MHz)	433.00-433.92MHz

## Motor Installation

- ① Driving tube must be close-fitting with crown and drive adapter.
- ② Choose crown and drive adapter based on the driving tube.

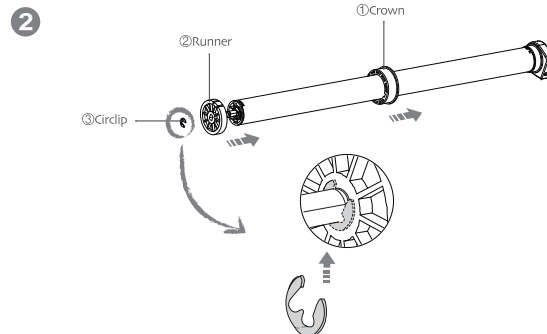
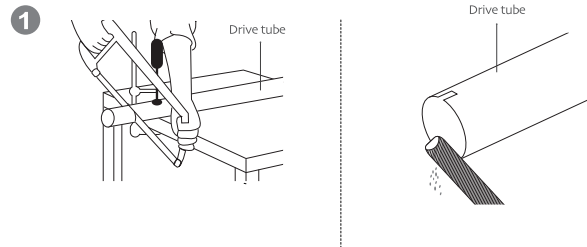

3

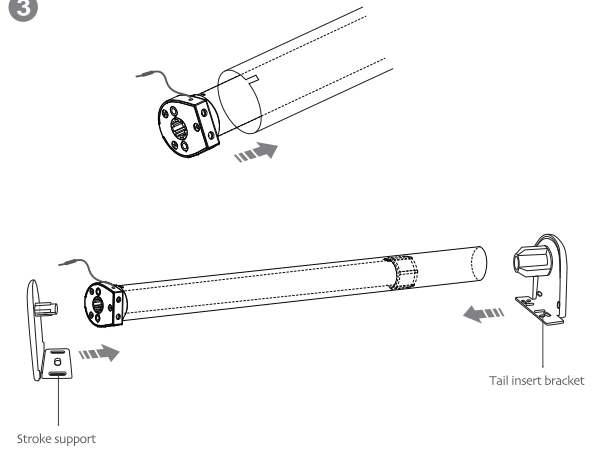

## Rechargeable Description

⚠ The motor has a built-in battery, using the charger to recharge. You can also use solar panels to charge; when the battery is low, insert the charge, charger light shows red light. Batteries are full when the red light turns to green.

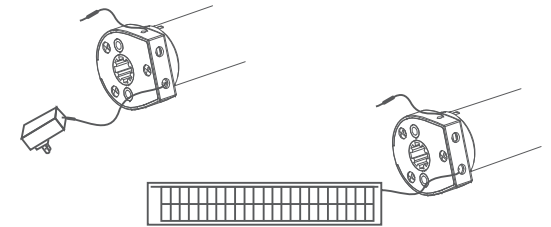

## Operation note

⚠ Please read the following precautions before use:

1. Please charge the battery and make sure it is fully charged before the first use.
2. Don't operate motors when in low voltage alarm:
  - ① Motor stop running. When the supply voltage is lower than 7V, and it will restart again when the voltage is greater than 7.5V.
  - ② If the voltage is less than 10V, the motor will alarm for 10 times to prompt it needs to be charged every time when the motor is working.
3. Operating:
  - ① The valid interval of the emitter button is 10s, the emitter will quit the set after 10s.
  - ② The motor will run or beep for a hint, please do the next step after the hint.
4. Set limit position:
  - ① After the up limit and down limit setting, and the up limit down limit and third limit position are at the same location.
  - ② After limit setting, with power and memory function;
  - ③ Into the match-code status 2 minutes later, it will quit out the setting limits status automatically.
  - ④ It will delete every memory and restore the factory settings.
5. When the motor running without any operation, the maximum running time is 6 minutes, it will stop automatically.
6. If the emitter is lost, please set up again with a new emitter.



**Button specification**

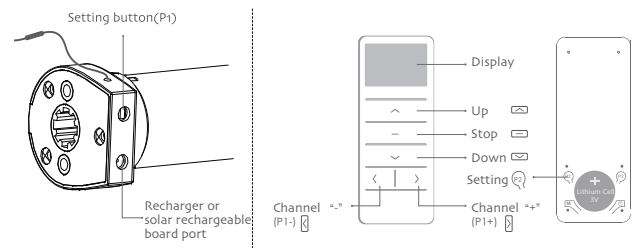

**FACTORY MODE**

**1 Setting up**

If you need to reverse the rotation of the motor controlled by the emitter, please run the reverse of direction setting(as lists in the second point of the P1 button setting)

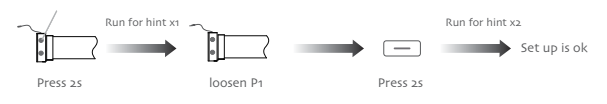

**2 The reverse of direction setting**



**3 limit position**

1, Enter the limit setting mode



2, Set up limit (Up->Up+Stop)

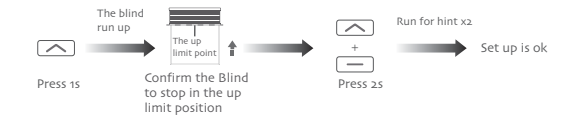

3, Set down limit (Down->Stop+Down)

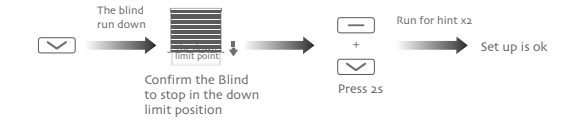

Note: After setting up the up and down limit into user mode.

**USER MODE**

**1 Fine-tune up/down limit position**



Note: Can not be fine-tune up/down limit position at the same time.

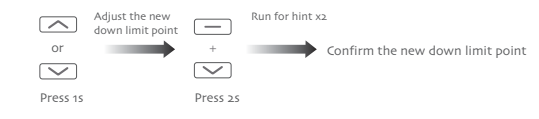
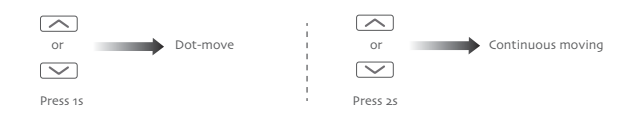

**2 The third limit position setting**

1, The third limit position setting

①After the up limit and down limit setting, you can set the third limit point between them as the half open position;

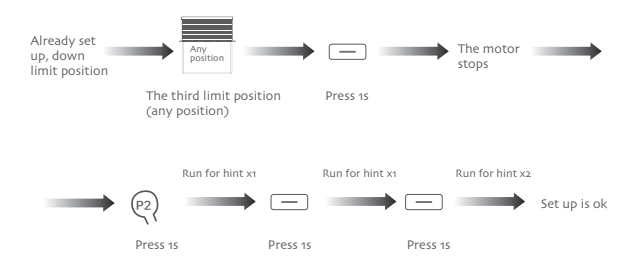

②Long press the stop button for 2s, the roller blinds will move to the third limit

2, The third limit cancel (P2->Stop->Stop)



**3 Dot-move/Continuous moving function switch**



Notes: Repetitive operation dot-move and continuous moving function switching cycle, under the dot-move function, according to the up or down button more than 2s release motor linkage operation.

**4 Add Emitter**

**Method one**

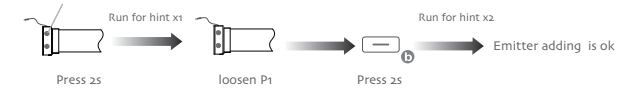

**Method two** P2 a -> P2 a -> P2 b

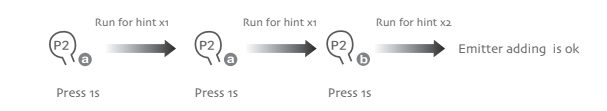

Note: Emitter a is the one already matched code, while emitter b has not

**5 Delete one emitter** P2 a -> P2 a -> P2 b



Note: With the same method, you only can delete the emitter b, not the emitter a

**P1 BUTTON OPERATION**

Functions that can be operated under any mode

1, Activate motor for the first time



2, The reverse of direction setting



3, Restore factory settings

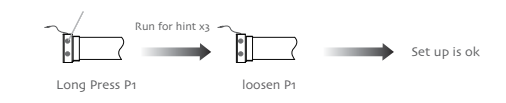

**FAULT AND SOLUTION**

NUMBER	PHENOMENON	REASON	PROCESSING METHOD
1	The motor alarms when it is working	The voltage is low in the alarm mode	Charge the battery
2	The motor is not running	a, The battery is not activated. b, The emitter is not matched. c, If press P1 button for a long time while with no reaction, may be the power is short-circuit or the circuit board or the motor is broken.	a, Activate the motor after fully charged b, Set up the match code c, Contact the engineers for after-sales

## FCC STATEMENT

1. This device complies with Part 15 of the FCC Rules. Operation is subject to the following two conditions:

(1) This device may not cause harmful interference.

(2) This device must accept any interference received, including interference that may cause undesired operation.

2. Changes or modifications not expressly approved by the party responsible for compliance could void the user's authority to operate the equipment.

NOTE: This equipment has been tested and found to comply with the limits for a Class B digital device, pursuant to Part 15 of the FCC Rules. These limits are designed to provide reasonable protection against harmful interference in a residential installation.

This equipment generates uses and can radiate radio frequency energy and, if not installed and used in accordance with the instructions, may cause harmful interference to radio communications. However, there is no guarantee that interference will not occur in a particular installation. If this equipment does cause harmful interference to radio or television reception, which can be determined by turning the equipment off and on, the user is encouraged to try to correct the interference by one or more of the following measures:

- Reorient or relocate the receiving antenna.

- Increase the separation between the equipment and receiver.

- Connect the equipment into an outlet on a circuit different from that to which the receiver is connected.

- Consult the dealer or an experienced radio/TV technician for help.