

NOFIQ® fire prevention system

Manual for design, installation, acceptance, use and maintenance

Reference: 1020.1000.0025 EN

Version number: 6.4 - March 2009

Document name: HL-E

Publication: NOFIQ® systems BV

NOFIQ systems BV – Postbus 510 – 9400 AM Assen – the Netherlands

(T) 0592 – 40 42 01 (F) 0592 – 40 42 82

www.nofiq.com - info@nofiq.com

Declaration of conformity

We, undersigned

NOFIQ® systems BV, Nijverheidsweg 16 9403 VN ASSEN, Nederland

Declare hereby that the following products:

Complete wireless fire protection system consisting of:

- **NOFIQ® N20-BASE** (alarm management station)
- **NOFIQ® N20-BASE_HUB** (radio and transmitting station)
- **NOFIQ® N20-HUB** (signal repeater)
- **NOFIQ® N20-FE** (detection, alarm and extinguishing component)
- **NOFIQ® N80-FE** (detection, alarm and extinguishing component)

are tested and meet the essential requirements of the following European Directives:

- 1999/5/EG, Radio and telecommunication terminal equipment (R&TTE)
- 2004/108/EG, Electromagnetic compatibility (EMC)
- 2006/95/EG, Low voltage directive (LVD)

The aforementioned products meet the essential requirements of the:

R&TTE Directives 1999/5/EC based on the agreement with the following harmonised standards:

- EN 60950-1 (2001)
- EN 301 489-1 V.1.4.1 and EN 301 489-3 V.1.4.1
- EN 300 440-1 V.1.3.1 and EN 300 440-2 V.1.1.1

The equipment also complies with the RECOMMENDATION OF THE COUNCIL (1999/519/EG) of the 12th July 1999 regarding the limited exposure of the population to electromagnetic fields from 0 Hz - 300 GHz, complying the judgement of TÜV Rheinland EPS BV as a Notified Body (nr. 1856).

For the EMC Directives 2004/108/EEG based on the following harmonised standards:

- EN 55022 (1998)
- EN 55024 (1999)
- EN 50130-4 / A2 (2003)
- EN 61000-3-2 (2002)

For the LVD Directives 2006/95/EG based on the following harmonised standards:

- EN 60950-1 (2001)

The equipment also complies with the RECOMMENDATION OF THE COUNCIL (1999/519/EG) of the 12th July 1999 regarding the limited exposure of the population to electromagnetic fields from 0 Hz - 300 GHz, complying the judgement of TÜV Rheinland EPS BV as a Notified Body (nr. 1856).

The technical documentation required regarding the relevant conformity procedures in Directives for proving the presumption of agreement with the directives mentioned has been composed under undersigned's responsibility and will be placed at the disposal of the relevant authorities by request.

The product conformity with the abovementioned standards and directives is confirmed by the EG conformity mark.



The technical documentation required regarding the relevant conformity procedures can be requested at:

NOFIQ® systems BV, Nijverheidsweg, 16, 9403 VN ASSEN, the Netherlands
E-mail: info@NOFIQ.com - Internet: www.NOFIQ.com

A handwritten signature in black ink, appearing to read 'G.M. de Groot', is written over a horizontal line.

G.M. de Groot
General Director
1 March 2009

Extending Declaration of conformity

Beside the Declaration of conformity a extending Declaration for productcertification (EN 45011) is given on basis of the Guideline BRL K21014 of Kiwa Certification and the European Norms EN 54-4 and EN 54-25 by TÜV Rheinland EPS BV.



- EN54-4
- EN54-25

The technical documentation required regarding the relevant conformity procedures can be requested at:

NOFIQ systems B.V.

Nijverheidsweg 16
9403 VN ASSEN
the Netherlands
www.nofiq.com
info@nofiq.com

G.M. de Groot
General Director
1 March 2009

Preamble

Limited liability

The set-up and content of this manual has been composed with the utmost care. Yet we do not accept liability for any mistakes or inaccuracies that might occur in the manual.

NOFIQ® products are updated regularly. Therefore it is possible for certain instructions, specifications or figures in this documentation to be deviating. Furthermore NOFIQ® systems BV and NOFIQ® holding BV are entitled to revise this publication and make changes to its content.

NOFIQ® systems BV and NOFIQ® holding BV do not accept any liability for direct damage caused by incorrect use or use other than mentioned in the manual.

NOFIQ® systems BV and NOFIQ® holding BV only accept legal liability for direct damage for which NOFIQ® is liable based on non-fulfilment and/or unlawful action. This damage however is restricted to compensation charged or to be charged for the performance in question by NOFIQ® systems BV and NOFIQ® holding BV.

No liability for consequential damage

In no case are NOFIQ® systems BV and NOFIQ® holding BV and her distributors liable for damage (including, but not restricted to indemnity for loss of revenue, business interruption, loss of business information or any other financial loss) caused by (incorrect) use of or any prevention from use of these products, even if NOFIQ® systems BV and NOFIQ® holding BV and her distributors are informed about the risk of such damage.

Limited warranty

Limited warranty manufacturer

NOFIQ® systems BV and NOFIQ® Holding BV guarantee that the NOFIQ® products in principle function or will function in pursuance of the information in the manual and accompanying documentation material.

No other warranty

NOFIQ® systems BV, NOFIQ® Holding BV and her distributors offer no warranty, neither explicit, nor implicit, including but not restricted to the salability or suitability regarding the NOFIQ® products and accompanying documentation material for any other application than described in the manual.

Modifications to the product

NOFIQ® systems BV and NOFIQ® Holding BV are not liable for modifications made by the user. Likewise no liability is accepted for consequences of those modifications, whether or not influencing the product conformity of the CE-mark.

Trademarks

NOFIQ® is a registered trademark of NOFIQ® systems BV and NOFIQ® Holding BV. All other company or product names are (registered) trademarks, or service brands owned by (NOFIQ® systems BV and) NOFIQ® Holding BV.

NOFIQ® is a registered European patent.

FirePro is a registered European patent.

Violation of these patents, in any form, will be prosecuted with all means of appeal available.

Table of Contents

| | |
|--|-----------|
| 1. Foreword | 9 |
| 1.1 Manual set-up | 9 |
| 1.2 Use of icons | 10 |
| 2. An overview of the NOFIQ® system | 11 |
| 2.1 General | 11 |
| 2.2 Components of the NOFIQ® system | 11 |
| 2.3 Wireless communication between the components | 13 |
| 2.4 Alarm messages | 14 |
| 2.5 Error messages | 16 |
| 2.6 Authorisation | 16 |
| 3. The NOFIQ® BASE | 17 |
| 3.1 General | 17 |
| 3.2 Functionality of the NOFIQ® BASE | 17 |
| 4. The NOFIQ® BASE-HUB | 19 |
| 4.1 General | 19 |
| 4.2 Functionality of the NOFIQ® BASE-HUB | 19 |
| 5. The NOFIQ® HUB | 21 |
| 5.1 General | 21 |
| 5.2 Functionality of the NOFIQ® HUB | 22 |
| 6. The NOFIQ® FE | 23 |
| 6.1 General | 23 |
| 6.2 Functionality of the NOFIQ® FE | 24 |
| 7. Safety and environment | 25 |
| 7.1 General | 25 |
| 7.2 General safety precautions | 25 |
| 7.3 Use of aerosol extinguishing components | 25 |
| 7.4 Safety precautions during maintenance and installation | 26 |
| 7.5 Safety precautions after a fire | 27 |
| 7.6 Environmental aspects | 27 |
| 8. Designing the installation of the NOFIQ® system | 29 |
| 8.1 General | 29 |
| 8.2 Calculating the amount of extinguishing agent | 31 |
| 9. Installation of the NOFIQ® system | 33 |
| 9.1 General | 33 |
| 9.2 Storage and transport | 33 |
| 9.3 Conditional requirements for an operational system | 34 |
| 9.4 Preparing the installation | 34 |
| 9.5 Concise installation procedure | 36 |
| 10. Installation of the NOFIQ® BASE | 39 |
| 10.1 General | 39 |

| | | |
|------------|--|-----------|
| 10.2 | Conditional requirements for the NOFIQ® BASE | 39 |
| 10.3 | Requirements | 39 |
| 10.4 | Technical specifications of the NOFIQ® BASE | 41 |
| 10.5 | Installation and configuration instructions NOFIQ® BASE | 41 |
| 11. | Installation of the NOFIQ® BASE-HUB | 47 |
| 11.1 | General | 47 |
| 11.2 | Requirements | 47 |
| 11.2 | Technical specifications of the NOFIQ® BASE-HUB | 48 |
| 11.3 | Installation and configuration instructions NOFIQ® BASE-HUB | 48 |
| 12. | Configuration and data management NOFIQ® BASE | 51 |
| 12.1 | General | 51 |
| 12.2 | Requirements | 51 |
| 12.3 | Configuring and managing data in the NOFIQ® BASE | 51 |
| 12.4 | Menu terminal application NOFIQ® BASE | 53 |
| 13. | Installation of a NOFIQ® HUB | 60 |
| 13.1 | General | 60 |
| 13.2 | Requirements | 60 |
| 13.3 | Technical specifications of the NOFIQ® HUB | 61 |
| 13.4 | Installation and configuration instructions NOFIQ® HUB | 61 |
| 14. | Configuration of a NOFIQ® HUB or a NOFIQ® FE | 65 |
| 14.1 | General | 65 |
| 14.2 | Requirements | 65 |
| 14.3 | Configuring a NOFIQ® HUB or NOFIQ® FE | 65 |
| 15. | Installation of a NOFIQ® FE | 73 |
| 15.1 | General | 73 |
| 15.2 | Requirements | 73 |
| 15.3 | Technical specifications of a NOFIQ® FE | 74 |
| 15.4 | Installation and configuration instructions NOFIQ® FE | 74 |
| 15.5 | Additional special instructions for installation of a standalone NOFIQ® FE | 80 |
| 16. | Installation of a InterNOFIQBus | 81 |
| 16.1 | General | 81 |
| 16.2 | Requirements | 81 |
| 16.3 | Installation and configuration instructions InterNOFIQBus | 82 |
| 17. | Putting the NOFIQ® system into operation | 86 |
| 17.1 | General | 86 |
| 17.2 | Putting the system into operation | 86 |
| 18. | Acceptance of the NOFIQ® system | 87 |
| 18.1 | General | 87 |
| 18.2 | Activities for acceptance | 87 |
| 19. | The NOFIQ® BASE in daily use | 88 |
| 19.1 | General | 88 |

| | | |
|------------|---|------------|
| 19.2 | Control panel | 88 |
| 19.3 | Alphanumeric display | 89 |
| 19.4 | Indication LEDs | 89 |
| 19.5 | Buttons (keypad) | 90 |
| 19.6 | Locks | 90 |
| 19.7 | Alarm or error messages and accompanying indicators | 92 |
| 19.8 | Overview alarm messages | 92 |
| 19.9 | Overview error messages | 93 |
| 19.10 | Menu structure | 94 |
| 19.11 | Menu options and their use | 97 |
| 20. | The NOFIQ® BASE-HUB in daily use | 101 |
| 20.1 | General | 101 |
| 20.2 | Statuses of the NOFIQ® BASE-HUB and accompanying indicators | 101 |
| 20.3 | Use of the button of the NOFIQ® BASE-HUB | 101 |
| 21. | The NOFIQ® HUB in daily use | 102 |
| 21.1 | General | 102 |
| 21.2 | Statuses of a NOFIQ® HUB and accompanying indicators | 102 |
| 21.3 | Use of the button of a NOFIQ® HUB | 102 |
| 22. | The NOFIQ® FE in daily use | 103 |
| 22.1 | General | 103 |
| 22.2 | Operation of the NOFIQ® FE's sensors | 103 |
| 22.3 | Statuses of a NOFIQ® FE and accompanying indicators | 104 |
| 22.4 | Use of the button of a NOFIQ® FE | 105 |
| 23. | Alarm or error, what to do? | 106 |
| 23.1 | General | 106 |
| 23.2 | How do you recognize an alarm or error? | 106 |
| 23.3 | How does the system handle an alarm? | 109 |
| 23.4 | What to do yourself in case of an alarm? | 110 |
| 23.5 | How does the system handle an error? | 111 |
| 23.6 | What to do yourself in case of an error? | 111 |
| 24. | Maintenance of the NOFIQ® system | 114 |
| 24.1 | General | 114 |
| 24.2 | Maintenance agreement | 114 |
| 24.3 | Periodical inspections and preventive maintenance | 115 |
| 24.4 | Dismantling equipment | 115 |
| 24.5 | Carrying out software updates | 116 |
| 24.6 | Carrying out hardware updates | 116 |
| 24.7 | Reading out log files of the NOFIQ® BASE | 116 |
| 25. | Maintenance of the NOFIQ® BASE | 118 |
| 25.1 | General | 118 |
| 25.2 | Periodical inspections and preventive maintenance NOFIQ® BASE | 118 |

| | | |
|------------|--|------------|
| 25.3 | Repairs of the NOFIQ® BASE | 119 |
| 25.4 | Replacing the battery of the NOFIQ® BASE | 119 |
| 25.5 | Replacing the NOFIQ® BASE | 119 |
| 26. | Maintenance of the NOFIQ® BASE-HUB | 121 |
| 26.1 | General | 121 |
| 26.2 | Periodical inspections and preventive maintenance BASE-HUB | 121 |
| 26.3 | Repairs of the NOFIQ® BASE-HUB | 122 |
| 26.4 | Replacing the NOFIQ® BASE-HUB | 122 |
| 27. | Maintenance of the NOFIQ® HUB | 123 |
| 27.1 | General | 123 |
| 27.2 | Periodical inspections and preventive maintenance NOFIQ® HUB | 123 |
| 27.3 | Repairs of a NOFIQ® HUB | 123 |
| 27.4 | Replacing the battery-pack of a NOFIQ® HUB | 123 |
| 27.5 | Replacing a NOFIQ® HUB | 125 |
| 28. | Maintenance of the NOFIQ® FE | 126 |
| 28.1 | General | 126 |
| 28.2 | Periodical inspections and preventive maintenance NOFIQ® FE | 126 |
| 28.3 | Repairs of a NOFIQ® FE | 127 |
| 28.4 | Replacing the battery-pack of a NOFIQ® FE | 128 |
| 28.5 | Solving errors in a standalone NOFIQ® FE | 128 |
| 28.5 | Replacing a NOFIQ® FE | 130 |
| 28.6 | Relocating a NOFIQ® FE | 131 |
| 29. | Service and warranty | 132 |
| 30. | Support | 133 |
| 31. | Index | 134 |
| 32. | List of figures and tables | 136 |
| 32.1 | List of figures | 136 |
| 32.2 | List of tables | 137 |
| 33. | Abbreviations | 138 |
| 34. | Glossary | 139 |
| 35. | Certification | 142 |
| 36. | Appendices | 144 |
| 36.1 | Program of Requirements (example) | 144 |
| 36.2 | Installation plan (example) | 148 |
| 36.3 | Acceptance Report (example) | 149 |
| 36.4 | Log book (example) | 152 |
| 36.5 | Maintenance Report (example) | 155 |
| 36.6 | Overview status transitions | 159 |
| 36.7 | Specifications external antenna | 160 |
| 36.8 | Specifications FirePro® aerosol extinguishing components | 161 |
| 36.9 | FirePro® Material Safety Data Sheet | 163 |
| 36.10 | Regulatory information radio communication | 168 |

1. Foreword

This is the manual for the NOFIQ® fire prevention system. This manual describes design, installation, acceptance, use and maintenance of the NOFIQ® system.

For end-users there is a separate user guide. The user guide only focuses on daily use of the NOFIQ® system and is aimed at NOFIQ® users with authorisation level 1 or 2. Authorisation levels and associated powers will be explained in paragraph 2.6.

1.1 Manual set-up

The manual for design, installation, acceptance, use and maintenance is divided as follows:

Chapter 2 states an overview of the NOFIQ® system and its functionality. The chapters 3 through 6 will describe the functionality of the NOFIQ® system's components separately.

Chapter 7 informs you on safety measures during installation and use of the NOFIQ® equipment.

Chapter 8 focuses on designing of the application and installation of the system.

Chapter 9 offers a step-by-step overview of the installation and configuration of a NOFIQ® system.

The chapters 10 through 16 handle the installation and configuration of the NOFIQ® system's components separately.

Chapter 17 deals with putting the NOFIQ® system into operation. Chapter 18 deals with acceptance of the NOFIQ® system.

Chapters 19 through 22 inform you on daily use of the system. These chapters offer information on the operation of keys, buttons, menus, LEDs and buzzers of the NOFIQ® system's components.

Chapter 23 handles the alarm messages and error messages generated by the NOFIQ® system, how the system deals with these messages and what the user should do.

Chapter 24 through 28 deal with periodical checks and preventive maintenance on the NOFIQ® system and its components.

Lastly we offer you an alphabetical index, lists of tables, figures and abbreviations as well as appendices with background information.

1.2 Use of icons

In this manual various icons are used to inform you about prohibitions, orders, warnings and useful tips.

You will regularly encounter the following icon: 

This icon means 'Attention' and is followed by a tip or a clue.
Within this manual you could encounter the following icons.

| | | | | | |
|--------------------|---|---|---|---|---|
| Prohibition |  |  |  |  |  |
| | Be careful! | Fire, open flame and smoking prohibited | No smoking | Switching off prohibited | Switching on prohibited |
| Order |  |  |  |  |  |
| | Attention! | Eye protection mandatory | Safety helmet mandatory | Safety gloves mandatory | Disconnect |
| Warning |  |  |  |  |  |
| | Danger | Falling due to level difference | Hot surface | Damage | High voltage |

2. An overview of the NOFIQ® system

2.1 General

The NOFIQ® fire prevention system is a complete fire prevention system. The system has been especially designed for detecting, alarming and extinguishing a fire in enclosed compartments containing electrical components (maximum 1500 Volt DC and 1000 Volt AC). The NOFIQ® system is primarily meant for objects that cannot be entered by humans. The system is pre-eminently suited for application in:

- switch cabinets
- meter boxes
- patch cabinets
- computers

The NOFIQ® system is used to detect a fire at its source in its earliest stadium and to extinguish this fire. Already in the initial phase of fire, the detection and extinguishing component will alarm the surrounding area and send a message to the alarm management station. If a fire really ignites, the extinguishing component will extinguish the fire thanks to the built-in aerosol fire-extinguishing component. In the meantime the alarm management station has notified the fire brigade or another fire-fighting service.

The NOFIQ® fire prevention system uses FirePro® aerosol fire-extinguishing components.

The FirePro® aerosol fire-extinguishing components are pre-eminently suited for extinguishing fires of the following fire classes:

- A, solids
- B, liquids
- C, gasses
- F, oils and fats

2.2 Components of the NOFIQ® system

A NOFIQ® system consists of the following components:

- NOFIQ® N20-BASE
hereafter NOFIQ® BASE
This is the alarm management station which offers information on all extinguishing and communication components within the system as well as on the status of the system as a whole.
A detailed description of the NOFIQ® N20-BASE's functionality is provided in chapter 3.
- NOFIQ® N20-BASE_HUB
hereafter NOFIQ® BASE-HUB
This is the transfer station, the antenna, of the NOFIQ® N20-BASE (the alarm management station)
A detailed description of the NOFIQ® N20-BASE-HUB's functionality is provided in chapter 4.
- NOFIQ® N20-HUB
hereafter NOFIQ® HUB
This is a signal repeater that enhances or repeats the communication signal between the components of the NOFIQ® system.
A detailed description of the NOFIQ® N20-HUB's functionality is provided in chapter 5.

- NOFIQ® N20-FE
hereafter NOFIQ® FE

This is the detection and extinguishing component (FE= Fire Extinguisher) of the system which is able to detect a fire as well as extinguish it thanks to the built-in FirePro® aerosol extinguishing component.

A detailed description of the NOFIQ® N20-FE's functionality is provided in chapter 6.

At the moment the following types of NOFIQ® N20-FE are available:

- NOFIQ® N20-FE
an FE equipped with an extinguishing component containing 20 grams of aerosol extinguishing agent
- NOFIQ® N80-FE
an FE equipped with an extinguishing component containing 80 grams of aerosol extinguishing agent

Both types make use of the same socket.



Attention!

**The NOFIQ® FE is also available in a standalone version.
(see chapter 15.5, page 80)**

The NOFIQ® system consists of a maximum of 511 detecting and extinguishing components (NOFIQ® FE), which are connected through wireless radio communication to the alarm management station, the NOFIQ® BASE. The radio connection is used to monitor the system and to send alarm and error messages to the alarm management station.

To ensure sound radio connections two or more signal repeaters (NOFIQ® HUB) are required. These will be installed at different locations inside the building to guarantee that every FE is always within radio reach of the NOFIQ® BASE. A NOFIQ® network requires at least two NOFIQ® HUBs in order to guarantee a backup communication route in case a HUB (temporarily) fails. The transmission path between an FE and the BASE may not span more than 32 signal repeaters.

Since the NOFIQ® BASE itself does not contain radio equipment, it is connected to the NOFIQ® BASE-HUB through a fire-resistant cable. The NOFIQ® BASE-HUB functions as the BASE's forwarding and receiving station.

The next figure shows an overview of the components of the NOFIQ® system and its mutual relation.

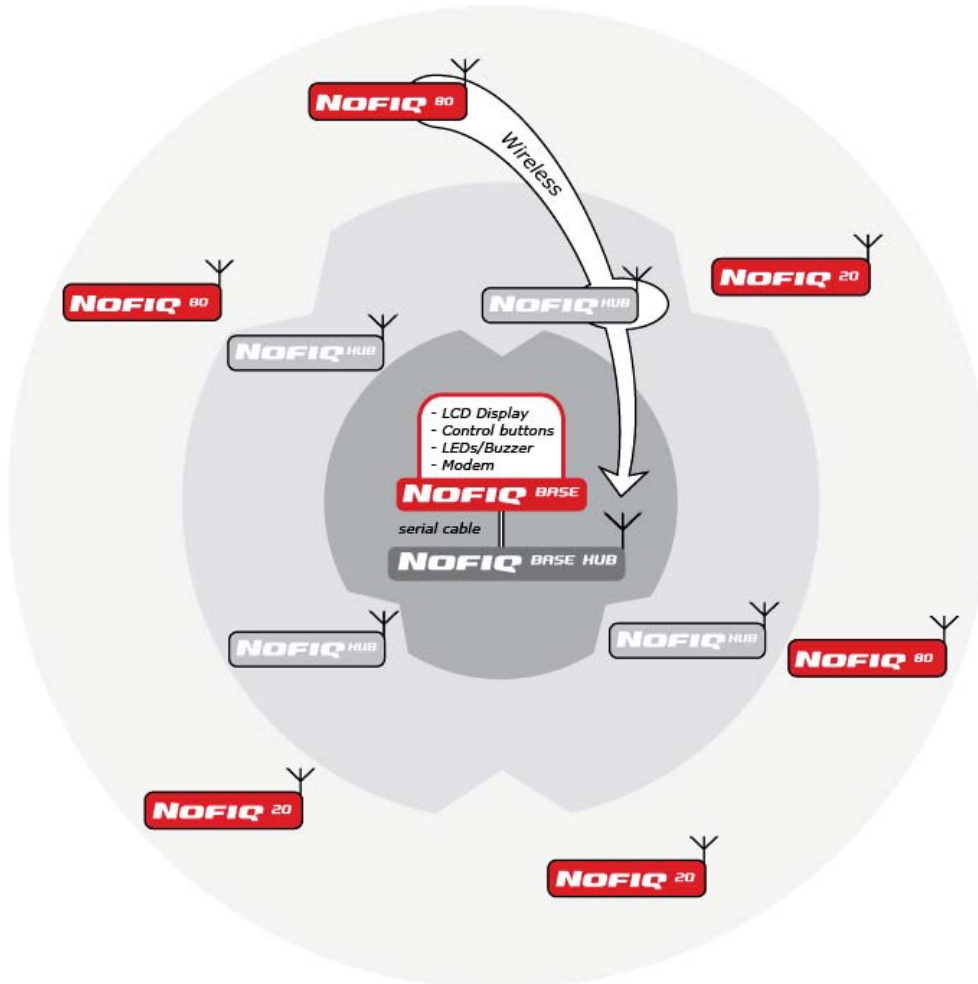

Figure 1 Overview of the NOFIQ® system

2.3 Wireless communication between the components

Transferring information between the individual components of the NOFIQ® system is done by wireless communication.

The NOFIQ® system uses the IEEE 802.15.4 standard on a 2.4 GHz frequency. This frequency is part of the ISM band (Industry, Scientific and Medical). This band is freely available in Europe for alarm purposes.

The system makes use of the ZigBee™ radio protocol. Thanks to this protocol creating networks on the spot is very easy. Therefore installation and operation of the NOFIQ® system is very user friendly, for the order of installation as well as for the expansion of the network.

Communication is encrypted by means of scrambling. This makes it very difficult for external devices to decode or overhear communication within the NOFIQ® network.

All NOFIQ® FE's and NOFIQ® HUBs regularly (at least once per 5 minutes) send a status report to the NOFIQ® BASE. This acts like a heartbeat, informing the system that the device in question is still operative and available.

A NOFIQ® FE' s heartbeat contains the following information:

- battery condition (only if batteries are its primary power supply);
- current CO increase on location;
- current temperature on location;
- current operational status of the FE.

A NOFIQ® FE sends the status report to the nearest available NOFIQ® HUB. If correctly received, this HUB will send an acknowledge signal back to the FE. If the NOFIQ® FE does not receive an acknowledge signal, it will send the status report again. After a certain number of failed attempts, the FE will automatically use a backup route via another NOFIQ® HUB.

The NOFIQ® HUB forwards messages from an FE via other HUBs to the NOFIQ® BASE. These messages are received by the NOFIQ® BASE-HUB which functions as transfer station of the NOFIQ® BASE. Communication between HUBs uses the same system of retrying and looking for a backup route.



Attention!

The NOFIQ® FE is also available in a standalone version. In that case there is no question of a NOFIQ® system/network (with BASE, BASE-HUB and HUBS) and thus no wireless communication takes place. (see chapter 15.5, page 80)

The NOFIQ® system generates different messages which can be separated into two categories:

- messages concerning fire alarms;
- messages concerning errors in the network or the system (malfunction warnings).

2.4 Alarm messages

A NOFIQ® FE, the detection and extinguishing component of the NOFIQ® system is equipped with two sensors: a carbon monoxide (CO)sensor and a temperature sensor. With these sensors an FE monitors its surroundings. If its sensors detect a significant raise in CO concentration or temperature, the FE will initiate an alarm.

The NOFIQ® system applies three different types of alarm messages:

- Alert
- Fire alarm
- Extinguishing

Alert

As soon as a NOFIQ® FE's sensors register a steep increase in temperature or CO concentration (without exceeding a critical point), the NOFIQ® FE sends an Alert to the alarm management station (the NOFIQ® BASE). With this alert the FE warns that probably something is not right at its location and that a fire may be developing. The Alert can only be shut down on the spot. This has been designed especially in this way to oblige a custodian to check whether a dangerous situation has arisen at the location in question. Thus a critical situation can be diagnosed quickly.

Fire alarm

If the temperature and the CO concentration have exceeded a critical level, the NOFIQ® FE will initiate a Fire alarm. This alarm warns that a fire has been detected and that the NOFIQ® FE will start an extinguishing sequence within 10 seconds. Within those 10 seconds the FE in question can be disabled by pressing the FE's button (Suspend). If someone would be doing maintenance work (welding, cleaning) at the location in question and forgot to Suspend the FE, the maintenance activities could be causing an alarm, although there is no question of fire. That is why there is a 10 second-countdown between the Fire alarm and the actual extinguishing routine.

Extinguishing

When the 10 second countdown expires the aerosol fire-extinguishing component will be activated and an extinguishing routine is started. The FE will now report an Extinguishing alarm.

Every alarm message will be notified to a fire alarm station (e.g. the fire brigade) or an private alarm station. Notification can be executed in several ways: through the switch contacts and/or through the telephone modem of the NOFIQ® BASE.

For every message type up to 5 telephone numbers can be programmed. Each message type has its own priority. If the system is in error and the NOFIQ® BASE is notifying this error message to a service provider by calling the programmed telephone number, the alarm management system will cancel this task immediately if an Alert or Fire Alarm is received. The NOFIQ® BASE will immediately dial the first number programmed for the alarm message in question. As soon as a connection has been established a specified sequence of DTMF-numbers (tone dialling) will be played to identify the nature of the message. For every message type a separate combination of dual-tones has been programmed.

| Message type | Priority | Telephone numbers | DTMF-sequence |
|--|----------|-------------------|-----------------------------------|
| ALARM (Fire Alarm or Extinguishing) | High | maximum 5 | programmable see also Table 19 |
| ALERT | Medium | maximum 5 | programmable see also Table 19 |
| MALFUNCTION | Low | maximum 5 | programmable see also Table 19 |

Table 1 Message priority

In chapter 23 you will find what you need to do yourself in case of an alarm message.



Attention!

The NOFIQ® FE is also available in a standalone version. In that case there is no question of a NOFIQ® system/network (with BASE, BASE-HUB and HUBS). Alarm and error messages therefore will not be notified to the BASE.

(see chapter 15.5, blz 80)

3. The NOFIQ® BASE

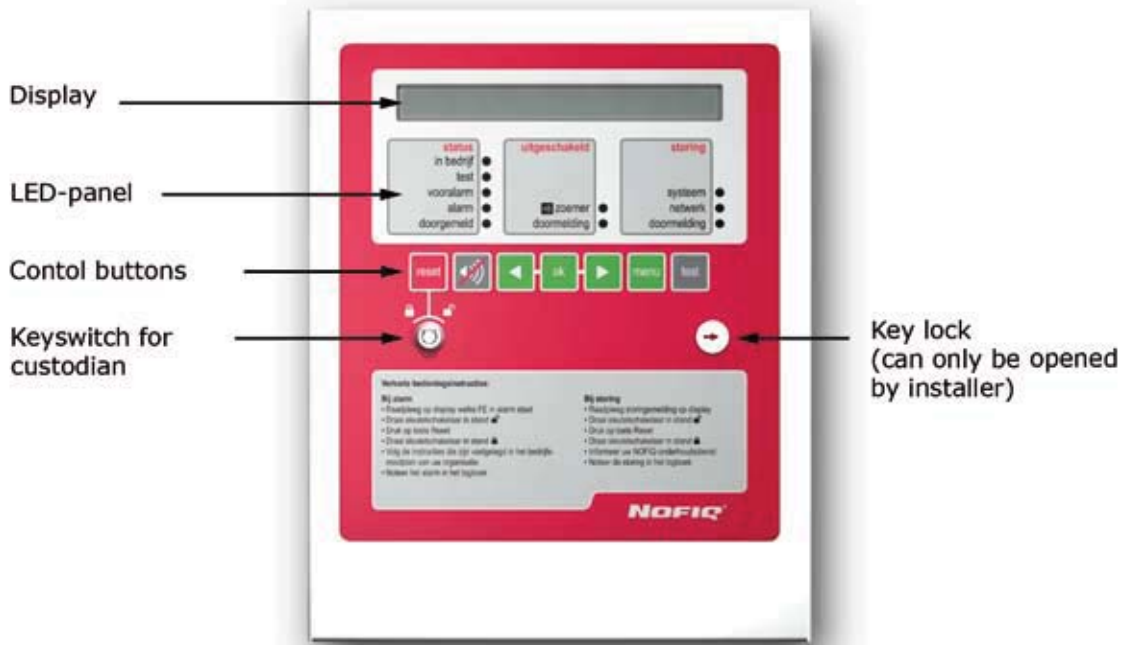

Figure 2 NOFIQ® BASE

3.1 General

The NOFIQ® BASE is the alarm management station of the NOFIQ® fire protection system. The NOFIQ® BASE is the central point of the detection and fire-extinguishing components (NOFIQ® FE's) and the signal repeaters (NOFIQ® HUBs) present at the customer's premises.

The NOFIQ® BASE registers all alarm and error messages from NOFIQ® FE's and/or NOFIQ® HUBs. The NOFIQ® BASE alarms an external fire-fighting service (e.g. a fire brigade) if one of the NOFIQ® FE's generates a fire alarm.

In order to monitor the system and its components all FE's and HUBs regularly (at least once per 5 minutes) send a status report (heartbeat) to the NOFIQ® BASE. If the NOFIQ® BASE fails to receive this signal twice in a row, the system will generate an error message.

The NOFIQ® BASE itself does not contain radio equipment. In order to receive all wireless messages from NOFIQ® FE's and HUBs, the NOFIQ® BASE is connected to the NOFIQ® BASE-HUB; the NOFIQ® BASE-HUB functions as the BASE's antenna.

3.2 Functionality of the NOFIQ® BASE

The NOFIQ® BASE has the following functionality and properties:

- Alphanumeric LCD-display with backlight. This display offers room for 2 lines of 40 characters each. The display shows all alarm and error messages. Moreover it displays all actions and options when using the maintenance and alarm menus.

- Ten LEDs (indicator lights) in the colours yellow, red and green to indicate the system's status.
- Seven control buttons for input and information queries from the NOFIQ® BASE. The buttons are used to navigate through the menus and to execute options in those menus.
- Buzzer for signalling alarms and error messages.
- RJ11 analogue telephone connector to notify a fire brigade in case of alarm or a service provider in case of an error by means of the built-in modem.
- Possibility to set 5 different telephone number for each message type (1 main number and 4 numbers as backup).
- RS232 connector to execute installation and maintenance tasks by means of a laptop.
- Adapter (AC/DC) for connection to the mains power supply (230 V, 50 Hz for Europe; 110 V 60Hz for the United States of America).
- Battery for 24 hours' secondary power supply in case of power failure. When mains power has been restored after a power failure, the battery will reload automatically.



Attention!

The batteries for the NOFIQ® system are supplied by your NOFIQ® provider. Only those batteries may be used for your NOFIQ® devices.

- Five potential-free switch contacts (24 V, 1 A). These can be used to drive other equipment or connections not part of the NOFIQ® system (for example for notification through another fire alarm system).



Attention!

At this moment there are three (3) switch contacts active in the software, as called error, alarm, fire-alarm.

- Authorisation lock.
- Interface for communication with the NOFIQ® BASE-HUB. The BASE-HUB functions as the BASE's forwarding and receiving station for all radio communication within the NOFIQ® system.

How to handle the NOFIQ® BASE in daily use is described in chapter 19.

4. The NOFIQ® BASE-HUB

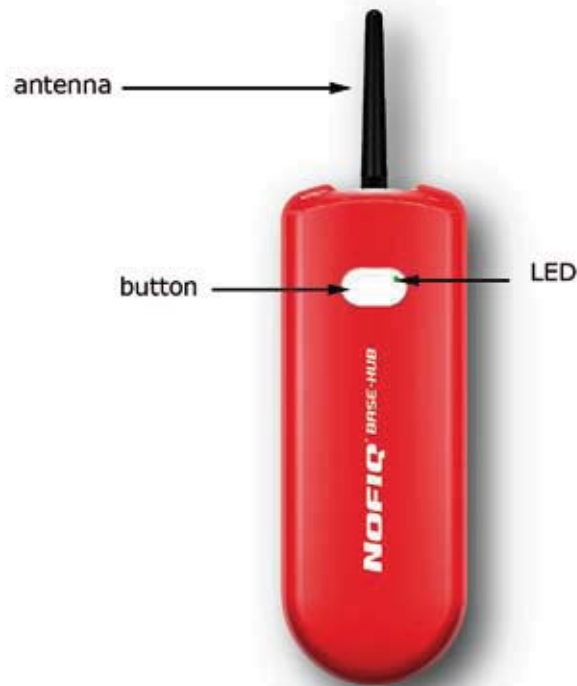

Figure 3 NOFIQ® BASE-HUB

4.1 General

From the outside the NOFIQ® BASE-HUB looks similar to the NOFIQ® HUB, except for its marking. The NOFIQ® BASE-HUB is the transfer station, the antenna, of the NOFIQ® BASE. Therefore the NOFIQ® BASE-HUB is directly connected to the NOFIQ® BASE by means of a fire-resistant cable (maximum 3 metres).

Another difference with a normal NOFIQ® HUB is that the NOFIQ® BASE-HUB has no power supply of its own, but uses the primary as well as the secondary power supply of the NOFIQ® BASE thanks to its direct connection to the NOFIQ® BASE.

Furthermore the BASE-HUB has no buzzer.

4.2 Functionality of the NOFIQ® BASE-HUB

The NOFIQ® BASE-HUB has the following functionality and properties:

- Communicate all transmissions to the NOFIQ® BASE.
The NOFIQ® BASE-HUB is the forwarding and receiving station of the NOFIQ® BASE and therefore essential for operation of the NOFIQ® BASE .
- Status indication of the device by LEDs in the colours yellow, red and green.
- Button.
- RS232 connector for communication with the NOFIQ® BASE.
- Bootstrap loader connector for maintenance.
- Power supply directly through the NOFIQ® BASE.
- No battery pack: secondary power supply through the NOFIQ® BASE.
- Antenna for radio communication (standard: 802.15.4) on a 2.4 GHz frequency.

How to handle the NOFIQ® BASE-HUB in daily use is described in chapter 20.

5. The NOFIQ® HUB

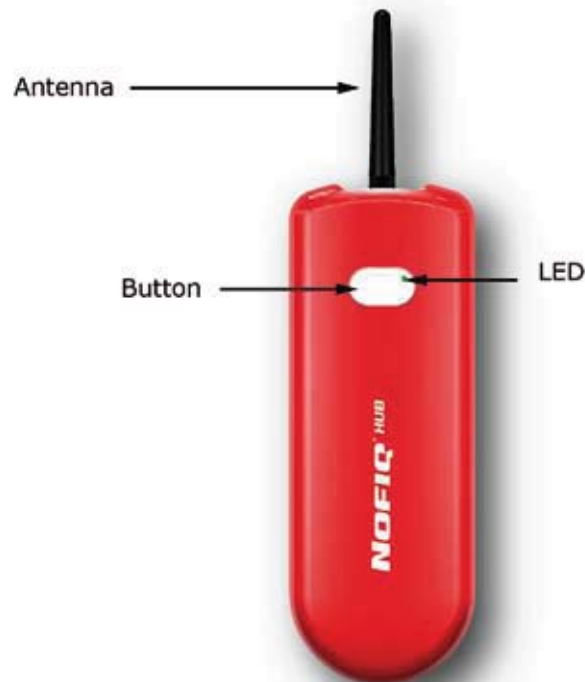

Figure 4 NOFIQ® HUB

5.1 General

The NOFIQ® HUB is a signal repeater, a radio unit supporting connections over longer distances by receiving and forwarding radio messages from NOFIQ® FE's and other NOFIQ® HUBs to the NOFIQ® BASE. The NOFIQ® HUB routes messages through the NOFIQ® network without overloading the data communication capabilities of the network. All devices in the network automatically select the best route to the NOFIQ® BASE based on connection calculations.

A NOFIQ® network needs at least two NOFIQ® HUBs, even if only one NOFIQ® FE has been installed. The presence of at least two HUBs guarantees a backup communication route from a NOFIQ® FE to the NOFIQ® BASE. Should one of the HUBs fail (temporarily), the FE will still be able to communicate with the BASE via another HUB.

A NOFIQ® HUB always looks for two so-called parents. If its primary parent does not respond to a transmission, the HUB will automatically choose its secondary parent as the (backup) route for communication.

The number of HUBs to be installed depends on the number of FE's in the system and the distance between the FE's and the BASE. A sufficient number of HUBs ensures that all FE's stay within radio reach of the NOFIQ® BASE.

5.2 Functionality of the NOFIQ® HUB

The NOFIQ® HUB has the following functionality and properties:

- Determining the best communication route to the NOFIQ® BASE.
- Communicating the quality of the connection with the NOFIQ® BASE to all other devices within the network.
- Regularly sending a status report (heartbeat) to the NOFIQ® BASE.
- Communicating status changes to the NOFIQ® BASE.
For example when the battery level is low an error message will be sent to the NOFIQ® BASE.
- Listening to and forwarding of messages from other devices within the network.
- Status indication of the device by LEDs in the colours yellow, red and green.
- Button.
- Buzzer to signal alarm and error messages.
- NOFIQ® MIC connector to execute installation and maintenance tasks by means of a laptop.
- Adapter (AC/DC) for connection to the mains power supply
(230 V, 50 Hz for Europe; 110 V 60Hz for the United States of America).
- Battery-pack for 24 hours' secondary power supply in case of power failure.



Attention!

The battery-packs for the NOFIQ® system are supplied by your NOFIQ® provider. Only those battery-packs may be used for your NOFIQ® devices.

- Antenna for radio communication (standard: 802.15.4) on a 2.4 GHz frequency.

How to handle the NOFIQ® HUB in daily use is described in chapter 21.

6. The NOFIQ® FE



Figure 5 NOFIQ® FE

6.1 General

The NOFIQ® FE (FE = Fire Extinguisher) is the detection and extinguishing unit of the NOFIQ® system. A NOFIQ® FE monitors a switch cabinet. In case of fire it initiates an alarm and extinguishes the fire thanks to the built-in FirePro® aerosol fire-extinguishing component.

In order to detect a starting fire the NOFIQ® FE is equipped with two sensors: a carbon monoxide (CO) sensor and a temperature sensor.

2 to 4 FE's can be linked into a so-called InterNOFIQBus. When one of the FE's in such a InterNOFIQBus detects a fire, all the other linked FE's will initiate an extinguishing routine.

Each NOFIQ® FE communicates its status to the NOFIQ® BASE.



Attention!

The NOFIQ® FE is also available in a standalone version. In that case there is no question of a NOFIQ® system/network (with BASE, BASE-HUB and HUBS) and thus no wireless communication takes place. (see chapter 15.5, page 80)

6.2 Functionality of the NOFIQ® FE

The NOFIQ® FE has the following functionality and properties:

- Temperature sensor for measuring the temperature.
If this sensor detects a significant raise in temperature or if the temperature exceeds a certain limit, the NOFIQ® FE will initiate an alarm.
- CO sensor for measuring the carbon monoxide concentration.
If the CO sensor detects a significant raise in CO concentration, the NOFIQ® FE will initiate an alarm.
- Potential-free switch contact.
It can be used to disable a fan inside the switch cabinet, thus preventing the fan from spreading the aerosol gas which would hinder the extinguishing routine.
- Interface for linking 2, 3 or 4 FE's in a so-called InterNOFIQBus in order to protect larger objects.
- FirePro® aerosol extinguishing component containing an aerosol gas to extinguish a fire.
- Activator for the FirePro® aerosol extinguishing component.
- Status indication of the device by LEDs in the colours yellow, red and green.
- Button.
- Buzzer to signal alarm and error messages.
- NOFIQ® MIC connector to execute installation and maintenance tasks by means of a laptop.
- Power supply: battery-pack.



Attention!

The battery-packs for the NOFIQ® system are supplied by your NOFIQ® provider. Only those battery-packs may be used for your NOFIQ® devices.

- Optional: Adapter (AC/DC) for connection to the mains power supply (230 V, 50 Hz for Europe; 110 V 60Hz for the United States of America).



Attention!

The adapters for the NOFIQ® system are supplied by your NOFIQ® provider. Only those adapters may be used for your NOFIQ® devices.

- Antenna for radio communication (standard: 802.15.4) on a 2.4 GHz frequency.

How to handle the NOFIQ® FE in daily use is described in chapter 22.

7. Safety and environment

7.1 General

In this chapter we focus on safety precautions and environmental requirements when installing, using or maintaining the NOFIQ® system.

7.2 General safety precautions

During installation and daily use of the equipment it is of the utmost importance to reduce safety risks for yourself, the environment and the equipment to a minimum.

In general the following rules apply:

- Treat the equipment carefully.
- Follow the safety regulations mentioned in the instructions for installation, use, maintenance and dismantling of the equipment.
- Always act according to the instructions of your organisation's emergency plan. This manual does not provide all safety precautions since these may differ for each organisation and location.



Warning!

The primary power supply for the NOFIQ® system is supplied by the public electricity network. A fire alarm system, including all its power supply systems, has to be connected to the electricity network by a separate end group.

The power switch of this electricity group must be indicated by the text "Do not switch off, NOFIQ® fire protection system".

7.3 Use of aerosol extinguishing components

Each NOFIQ® FE is provided with a FirePro® aerosol extinguishing component. In the designated concentrations the aerosol extinguishing agent is not harmful to man, animal or plant.

The aerosol extinguishing components are pre-eminently suited for extinguishing fires of the following fire classes:

- A, solids
- B, liquids
- C, gasses
- F, fats and oils



Warning!

Dry aerosol extinguishing components may not be used for fires concerning the following materials (unless tests by accredited test laboratories have proven otherwise):

- **core fires as stated in class A;**
- **oxygen carrying chemicals like nitrocellulose and gun powder;**
- **reactive metals like lithium, sodium, potassium, magnesium, titanium, zirconium, uranium and plutonium**
- **metal oxides**
- **organic peroxides and hydrazine**
- **fire class D, metals**

Furthermore dry aerosol extinguishing components may not be used in spaces with flammable liquids or substances that could cause an explosive vapour or air mixture and for which a zoning in compliance with NPR 7910-1 or -2 has been determined, unless adequate provisions have been made in order to comply to the European ATEX-directive.

If a FirePro® aerosol extinguishing component has been activated, it can be disposed of as normal waste after it has been dismantled.

If a FirePro® aerosol extinguishing component has not been activated with the extinguishing agent still in its container, please return it to your supplier.



Attention!

Clean the location.

When the FirePro® aerosol extinguishing component has been activated, after a certain amount of time the particles will deposit in the protected object as dry dust.

- **Remove this residue shortly after activation (within a couple of hours at the most).**
- **Sweep up the residue by means of a brush or a damp cloth.**
- **Use special sprays suited for removing the residue from electronic parts.**

7.4 Safety precautions during maintenance and installation

During installation and maintenance heed at least the following precautions:



- **Do not smoke.**



- **Fire and open flame prohibited.**



- **Switch off all equipment not needed for and during your activities. If you have to carry out maintenance on a location, where a NOFIQ® FE has been installed, you need to deactivate (Suspend) the FE to prevent it from extinguishing. You can deactivate (Suspend) the FE by pressing the FE's button for 2 seconds. After finishing the operations, reactivate the FE by pressing the button for 2 seconds.**



- **Guard against falling and slipping. See to adequate foot-gear. Use a solid ladder which is stabilized on the floor.**



- **Use eye protection during drilling.**



- **See too sufficient illumination.**



- **Prevent damage to the equipment.**



- **Never paint the equipment.**



Attention!

When there are maintenance or other activities into the cabinet, you need to put the NOFIQ FE's into SUSPEND status before starting the activities or maintenance. This is for safety reasons and to prevent NOFIQ for extinguishing during these activities.

When the activities are finished, you need to bring the cabinet back to the operational temperature before the NOFIQ FE's are reactivated to the normal status.

Due to a fast warming of the cabinet, there is a chance for alarming and extinguishing.

7.5 Safety precautions after a fire

If a fire has been detected, the NOFIQ® system will notify this to a fire alarm station. The custodian, the fire brigade or another fire protection service will take countermeasures.

If you have to enter one of the locations where there has been fire, heed the following safety precautions:



- **The extinguishing agent which pours out of the FirePro® aerosol extinguishing component is warm. Although the aerosol cools down quickly, there is a danger of burning. In the designated concentrations the aerosol extinguishing agent is not harmful to man, animal or plant.**



- **Fire and open flame prohibited.**



- **Use eye protection during drilling. Wear protective clothing.**



- **During a fire combustion products will be released. These combustion products contain toxic substances like carbon monoxide, carbon dioxide and nitrogen oxide which are health threatening.**



- **The location of the fire and any objects at that location can be very warm. Danger of burning.**

7.6 Environmental aspects

All NOFIQ® equipment meet strict environmental requirements. A few examples:

- the aerosol in the extinguishing component is not harmful to man, animal and plant;
- all products are soldered lead-free;
- the equipment's housing can be recycled (provided with recycling logo).

Within this scope we would like to focus your attention to the following:

- Never just dispose of parts and equipment; some parts may be reused or recycled.
- Never put old batteries in the normal waste; batteries belong to chemical waste and should be collected separately.

If a FirePro® aerosol extinguishing component has been activated, it can be disposed of as normal waste after it has been dismantled.

If a FirePro® aerosol extinguishing component has not been activated with the extinguishing agent still in its container, please return it to your supplier.

8. Design installation of the NOFIQ® system

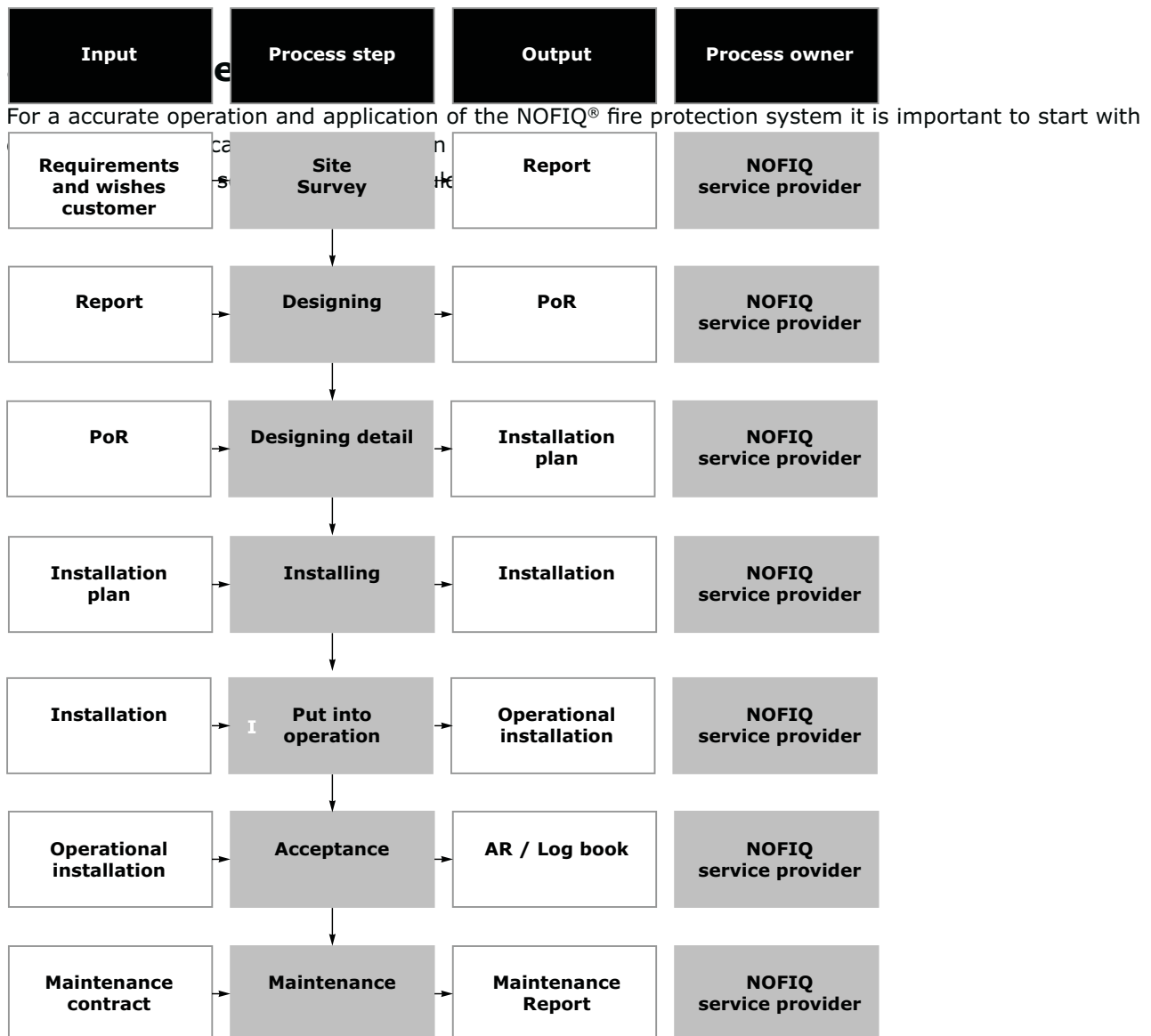

Figure 6 Design process NOFIQ® system



Attention!
Execution of these processes is restricted to qualified NOFIQ® service providers. This qualification is demonstrated through the personal certificate "NOFIQ® service provider".

Site Survey

To get a overview about the quality of the radiocommunication in a building, just carry out a site survey to get information about the radio messages in a building. The results must be recorded in an report.

Designing

During drafting of the installation design a Program of Requirements (PoR) is drawn up in close consultation with the customer and based on general fire protection regulations. The necessary data for a PoR is provided in appendix 36.1.

Designing detail

Based on this Program of Requirements a detailed design plan will be made, containing at least:

- the objects to be protected by NOFIQ® FE's,
- the number of NOFIQ® FE's needed for each object;
how to calculate this is explained in paragraph 8.2,
- the projection of the NOFIQ® FE's (position and direction);
how to project an FE is explained in paragraph 8.2,
- the NOFIQ® HUBs needed for communicating to the NOFIQ® BASE,
- the location for the NOFIQ® BASE.

These design details result into an installation plan.

Installing

Based on the installation plan the actual installation is done by qualified personnel in accordance with the operative regulations for installing in electrical installations.

An example of an installation plan is provided in the appendices.

Put into operation

The NOFIQ® system is put into operation by qualified personnel under responsibility of the NOFIQ® service provider. This comprises all necessary activities to make the installation functioning and operational in accordance with the Program of Requirements and the installation plan.

Acceptance

After the system has been installed and put into operation an 'Acceptance Report' will be drawn up. This report contains a declaration by the NOFIQ® service provider that everything has been installed in accordance with the PoR. An example of such a report is provided in appendix 36.3.

Furthermore the service provider will supply the customer with a log book and will instruct him in using and maintaining the NOFIQ® system. An example of a log book is provided in appendix 36.4.

Maintenance

The service provider and the customer must draw up a maintenance contract. This contract records all the necessary periodical checks and preventive maintenance, how often these have be executed and who will execute the maintenance activities.

Maintenance report

The actual maintenance will be recorded in a Maintenance Report which contains all checks executed and the specific activities resulting from those checks.

An example of such a report is provided in appendix 36.5.

8.2 Calculating the amount of extinguishing agent

The size of the object to be protected determines the amount of extinguishing agent needed to effectively extinguishing a fire. The amount necessary determines the number of NOFIQ® FE's to be installed at the location in question.

Depending on the object's capacity you have to calculate the amount of extinguishing agent necessary and thus the number of FE's needed. At the moment we can offer the following FE types:

- the NOFIQ® FE 20 equipped with a FirePro® extinguishing component containing 20 grams of aerosol extinguishing agent
- the NOFIQ® FE 80 equipped with a FirePro® extinguishing component containing 80 grams of aerosol extinguishing agent

Both types make use of the same socket type, so for installation purposes the chosen type makes no difference.

The next table indicates for which fire classes the NOFIQ® FE's are suited and the maximum object capacity 1 NOFIQ® FE can extinguish for the fire class in question.

| Fire class | Properties | Maximum capacity (NOFIQ® FE20) | Maximum capacity (NOFIQ® FE80) |
|------------|---------------|--------------------------------|--------------------------------|
| A | Solids | 0,24 m ³ | 0,84 m ³ |
| B | Liquids | 0,25 m ³ | 0,95 m ³ |
| C | Gasses | 0,44 m ³ | 1,64 m ³ |
| F | Fats and oils | 0,17 m ³ | 0,65 m ³ |

Table 3 Capacity extinguishing agent per fire class

The number of NOFIQ® FE's needed for an object also determines the projection, in other words the position and direction in which the NOFIQ® FE's have to be mounted.

When applying 1 NOFIQ® FE it will be placed in the middle of the object on the upper side, having the outflow openings pointing to the left and the right.

Ensure that both outflow openings have at least 15 cm of free outflow space in order to prevent damage to equipment. Since the antenna always has to point upwards, the antenna has to be placed separate from the FE and connected to the NOFIQ® FE by an antenna extension cord.

When applying 2 or more NOFIQ® FE's these are placed on the side of the object in question, having the outflow openings pointing upwards and downwards. Ensure that both outflow openings have at least 15 cm of free outflow space in order to prevent damage to equipment. When applying more than 1 FE in an object these FE's have to be linked into an InterNOFIQBus.

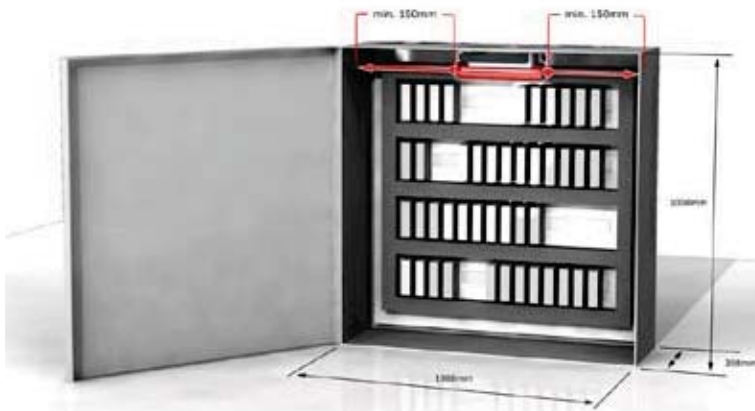

Figure 7a
Projection one NOFIQ® FE in a small cabinet

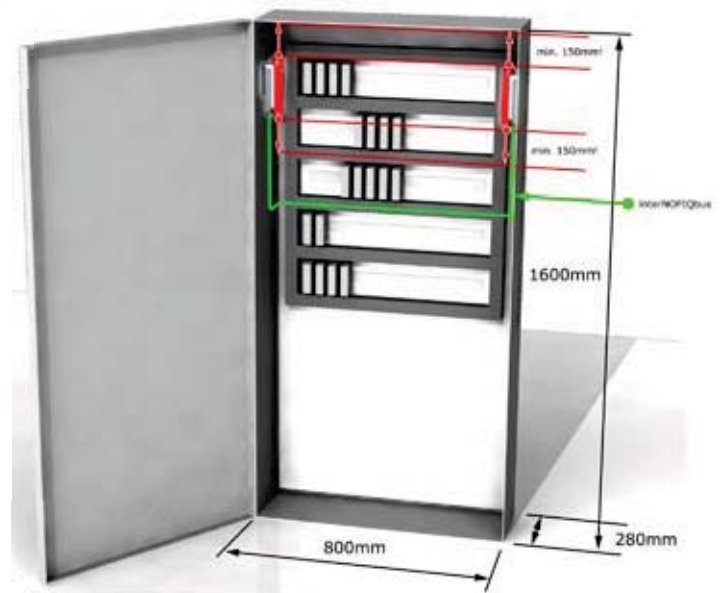

Figure 7b
Projection two NOFIQ® FE's
in a large cabinet

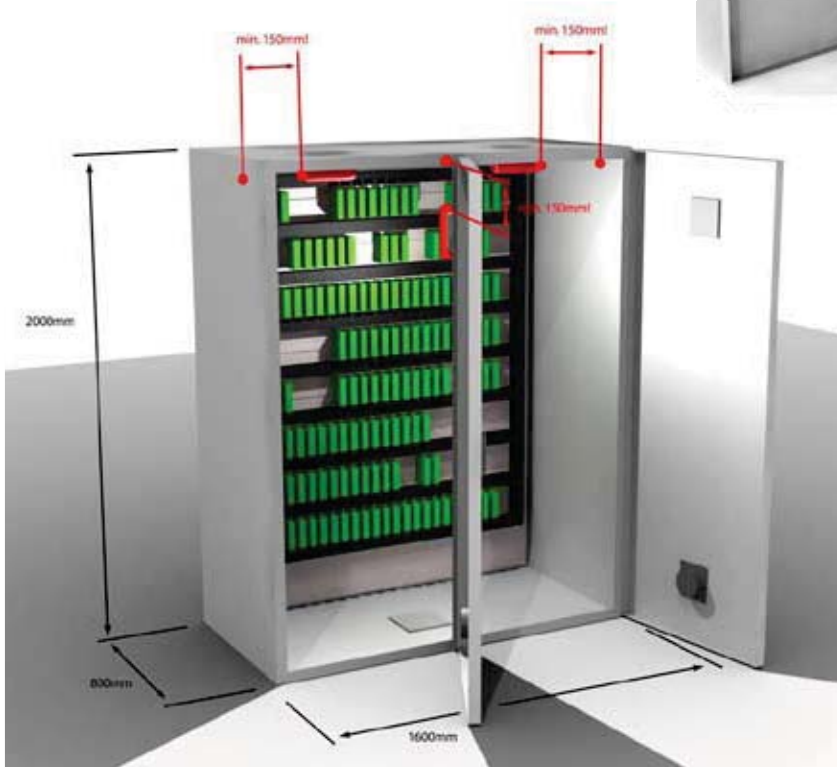

Figure 7c
Projection NOFIQ® FE80
in a large cabinet

For a complete overview of the “listing” see the productcertificate according to the BRL K21014.

9. Installation of the NOFIQ® system

9.1 General

This chapter treats the conditions and terms for installing a complete NOFIQ® system.

In paragraph 9.5 you will find a step-by-step procedure for installation and configuration of the NOFIQ® system. The next chapters will elaborate on the installation and configuration of the separate components of the NOFIQ® system, respectively:

- NOFIQ® BASE
This is the alarm management station.
- NOFIQ® BASE-HUB
This is the transfer station, the antenna, of the NOFIQ® BASE. It receives all wireless messages from the FE's and HUBs within the network.
- NOFIQ® HUB
The NOFIQ® HUB is a signal repeater, a radio unit supporting connections over longer distances by receiving and forwarding radio messages from NOFIQ® FE's and other NOFIQ® HUBs to the NOFIQ® BASE.



Attention!

In order to operate adequately the NOFIQ® system needs at least two (2) NOFIQ® HUBs.

- NOFIQ® FE
2 to 4 FE's can be linked into a so-called InterNOFIQBus. When one of the FE's in such a InterNOFIQBus detects a fire, all the other linked FE's will initiate an extinguishing routine simultaneously.



Attention!

Ensure that you have a profound knowledge of the safety precautions as stated in chapter 7.

9.2 Storage and transport

It is of the utmost importance that the components of the NOFIQ® system are treated carefully at all times. During storage as well as during transport of the equipment the following conditional requirements must be met.

| Conditions | NOFIQ® BASE | NOFIQ® BASE-HUB | NOFIQ® HUB | NOFIQ® FE |
|---------------------------------------|-------------|-----------------|------------|------------|
| Storage | | | | |
| Temperature in (°C) | -20 to +50 | -20 to +50 | -20 to +50 | -20 to +40 |
| Air humidity (%) (no condensation) | 25 to 75 | 25 to 75 | 25 to 75 | 25 to 75 |
| Air pressure (kPa) | 86 to 106 | 86 to 106 | 86 to 106 | 86 to 106 |
| | | | | |

| Conditions | NOFIQ® BASE | NOFIQ® BASE-HUB | NOFIQ® HUB | NOFIQ® FE |
|---|-------------|-----------------|------------|------------|
| Transport (during a maximum of 24 hours) | | | | |
| Temperature in (°C) | -35 to +85 | -35 to +85 | -35 to +85 | -35 to +50 |
| Air humidity (%) (no condensation) | < 95 | < 95 | < 95 | < 95 |
| Air pressure (kPa) | 86 to 106 | 86 to 106 | 86 to 106 | 86 to 106 |

Table 4 Conditional requirements storage and transport

Ensure furthermore that:

- all electronics are packaged in packaging that is guarded against the negative influence of electrostatic discharge;
- the equipment always is transported and stored in its packaging;
- after installation packaging will kept as much as possible in order to transport it safely in case of repair or moving of the system.

9.3 Conditional requirements for an operational system

For a correct and reliable operation of all components of the NOFIQ® system the following conditional requirements must be met for equipment in use (see also the conditional requirements for storage and transport in paragraph 9.2).

| Conditions | NOFIQ® BASE | NOFIQ® BASE-HUB | NOFIQ® HUB | NOFIQ® FE |
|---------------------------------------|-------------|-----------------|------------|------------|
| Operative | | | | |
| Temperature in (°C) | -10 to +60 | -10 to +60 | -10 to +60 | -10 tot 45 |
| Air humidity (%) (no condensation) | < 95 | < 95 | < 95 | < 95 |
| Air pressure (kPa) | 86 to 106 | 86 to 106 | 86 to 106 | 86 to 106 |

Table 5 Conditional requirements operational system

9.4 Preparing the installation

The design plan made according to the Program of Requirements (see chapter 8) includes an installation plan. Based on this installation plan you need to prepare the installation.

This installation plan contains at least the following:

- the objects to be protected by NOFIQ® FE's,
- the number of NOFIQ® FE's needed for each object;
- the projection of the NOFIQ® FE's (position and direction);
- the NOFIQ® HUBs needed for communicating to the NOFIQ® BASE,
- the location for the NOFIQ® BASE.

It is imperative that all NOFIQ® FE's can communicate with the NOFIQ® BASE. That means that you have to install sufficient HUBs and on the right locations to ensure that wireless communication from each FE to the NOFIQ® BASE is guaranteed.

For each NOFIQ® FE and NOFIQ® HUB you have to determine in advance an identifiable name or code. This code is used when you register each device at the NOFIQ® BASE. When the NOFIQ® BASE displays a message you will immediately know which device it concerns and where it is located.

Examples

If you are going to install 5 NOFIQ® FE's in 5 different cabinets you could give each FE the name of the cabinet in question (Cabinet 1, Cabinet 2, etc.).

If you are going to install 6 NOFIQ® FE's in 3 cabinets you could choose the codes Cabinet 1-1, Cabinet 1-2, Cabinet 2-1, Cabinet 2-2 or the codes Cabinet 1-Left, Cabinet 1-Right, etc.

The choice is all yours but we do advise to choose easily identifiable names ('Switch cabinet Building 2' is a lot clearer than '101-30-02').

Provide each FE and HUB with the chosen name or code (e.g. using a sticker) for ease of recognition during installation and in daily use.

During designing the application and installation of the NOFIQ® system you have to take the following into consideration as well:

- a NOFIQ® system consists of a maximum of 511 NOFIQ® HUBs (signal repeaters) and NOFIQ® FE's (detection and extinguishing components).
- a NOFIQ® system demands at least 2 NOFIQ® HUBs (signal repeaters).
- the transmission path from one specific NOFIQ® FE to the NOFIQ® BASE should not exceed 32 NOFIQ® HUBs.



Attention!

It is possible to determine the Short Network Addresses (SNA) for each NOFIQ® FE and NOFIQ® HUB in advance (in stead of consulting the NOFIQ® BASE for each separate SNA).

Essentially determining the SNA is free, but the following restrictions apply:

- **the SNA 0 has been reserved for the NOFIQ® BASE-HUB**
- **the SNA must not exceed 65534**
- **each SNA must be unique and may occur only once within one NOFIQ® system!**

Attention!

Suppose you have decided to number all HUBs from 101 (to 999) and all FE's from 1000. You have to realise that if you want to add a HUB or FE to the system at a later stage and you consult the NOFIQ® BASE for the first available SNA, the BASE will offer 1 as SNA. The NOFIQ® BASE does not take your way of numbering into account, but merely searches for the first available number. But by keeping up the installation plan meticulously you can always recover the first available SNA, fitting in your numbering sequence.

**Attention!**

During installation you need a computer (laptop, notebook or PC) provided with a RS232 connection (or with a USB/RS232 converter).

The following applications must have been installed on this computer:

- **HyperTerminal,
a Windows application usually already installed.**
- **NOFIQ® PC Control,
an application supplied by your NOFIQ® supplier.**

9.5 Concise installation procedure

This paragraph offers a concise step-by-step overview of the installation of an entire NOFIQ® system. This overview is based on an installation of all required components of a system, i.e. a NOFIQ® BASE, a NOFIQ® BASE-HUB, two or more NOFIQ® HUBs and one or more NOFIQ® FE's.

If you want to add a (extra) HUB or (extra/standalone) FE to a system in operation, you only have to execute the steps in question.

The installations of the specific system components will be explained in separate chapters. In the step-by-step plan below each step states in which chapter(s) the step in question will be explained in detail.

1. Check the components and accessories present.
Each chapter on the installation of the system's components contains a paragraph called 'Requirements'. This paragraph will tell you which parts, accessories and data are required for installation of the device in question.
2. Programming the Network Security Key (NSK).
Then you have to program the Network Security Key into the NOFIQ® BASE. Hereto you connect a computer with the NOFIQ® BASE by means of a null modem cable and then you start the terminal application as described in paragraph 12.3. When you have started the application, you select the menu Services and then the option Network Security Key.
3. Installation of the NOFIQ® BASE.
First of all you have to install the NOFIQ® BASE.
Chapter 10 explains in detail the installation of the NOFIQ® BASE.
4. Installation of the NOFIQ® BASE-HUB.
After you have mounted the NOFIQ® BASE you have to install the NOFIQ® BASE HUB and connect it to the NOFIQ® BASE by means of the fire-resistant cable.
Chapter 11 explains in detail the installation of the NOFIQ® BASE-HUB.
5. Configuration of the NOFIQ® BASE and the NOFIQ® BASE-HUB.
If you have installed the NOFIQ® BASE and the NOFIQ® BASE-HUB you have to prepare the NOFIQ® BASE for communication with the other components within the system. Hereto you connect a computer with the NOFIQ® BASE by means of a null modem cable and then you start the terminal application as described in paragraph 12.3. When you have started the application, you select:

- menu 3. Services
- option 3. Network Status
- option 3. BASE-HUB
- option 2. Modify BASE-HUB

You need to set the following data:

- The SNA for the NOFIQ® BASE-HUB;
this is always 0
- The network identification number
- The network channel;
this is a number in the range 11 through 26.

After setting the data, you select:

- option 3. Make operational
Executing this option makes the BASE-HUB and thus also the NOFIQ® BASE operational.

Chapter 12 explains in detail the configuration of the NOFIQ® BASE.

6. Installation of 2 or more NOFIQ® HUBs.

After installation and configuration of the NOFIQ® BASE and the NOFIQ® BASE-HUB, you have to install two (or more) NOFIQ® HUBs.



Attention!

In order to operate adequately the NOFIQ® system needs at least two (2) NOFIQ® HUBs . Thus a backup route for communication is guaranteed.

Chapter 13 explains in detail the installation of a NOFIQ® HUB.

7. Configuration of a NOFIQ® HUB.

After installation of a NOFIQ® HUB, you have to configure that HUB.
Chapter 14 explains in detail the configuration of a NOFIQ® HUB.

8. Installation of a NOFIQ® FE.

After installation and configuration of the NOFIQ® HUBs, you have to install one or more NOFIQ® FE's.
Chapter 15 explains in detail the installation of a NOFIQ® FE.

9. Configuration of a NOFIQ® FE

After installation of a NOFIQ® FE, you have to configure that FE.
Chapter 14 explains in detail the configuration of a NOFIQ® FE.

10. Installation of NOFIQ® FE's into a InterNOFIQBus. (**optional**)

If you want to protect a larger object, you can do that by linking 2, 3 or 4 NOFIQ® FE's into a so-called InterNOFIQBus.
Chapter 16 explains in detail the installation of a InterNOFIQBus.

11. Adding NOFIQ® HUBs and NOFIQ® FE's to the NOFIQ® BASE.
You can add a NOFIQ® HUB or a NOFIQ® FE to the NOFIQ® BASE as follows.
You connect a computer to the NOFIQ® BASE by means of a null modem cable and then you start the terminal application as described in paragraph 12.3.
For adding a NOFIQ® FE to the NOFIQ® BASE you then select:
 - menu 3. Services
 - option 3. Network Status
 - option 1. FE
 - option 4. Add FE to network
For adding a NOFIQ® HUB to the NOFIQ® BASE you then select:
 - menu 3. Services
 - option 3. Network Status
 - option 2. HUB
 - option 4. Add HUB to network

12. Downloading the Granted nodes database.
After installation of all components of the NOFIQ® system, you have to download the Granted nodes database from the NOFIQ® BASE and store it at a secure place. If something should go wrong with the NOFIQ® BASE, uploading the database will suffice to restore the data; adding all devices again would not be necessary.
You can download the Granted nodes database using the terminal application of the NOFIQ® BASE (see chapter 12.3).

10. Installation of the NOFIQ® BASE

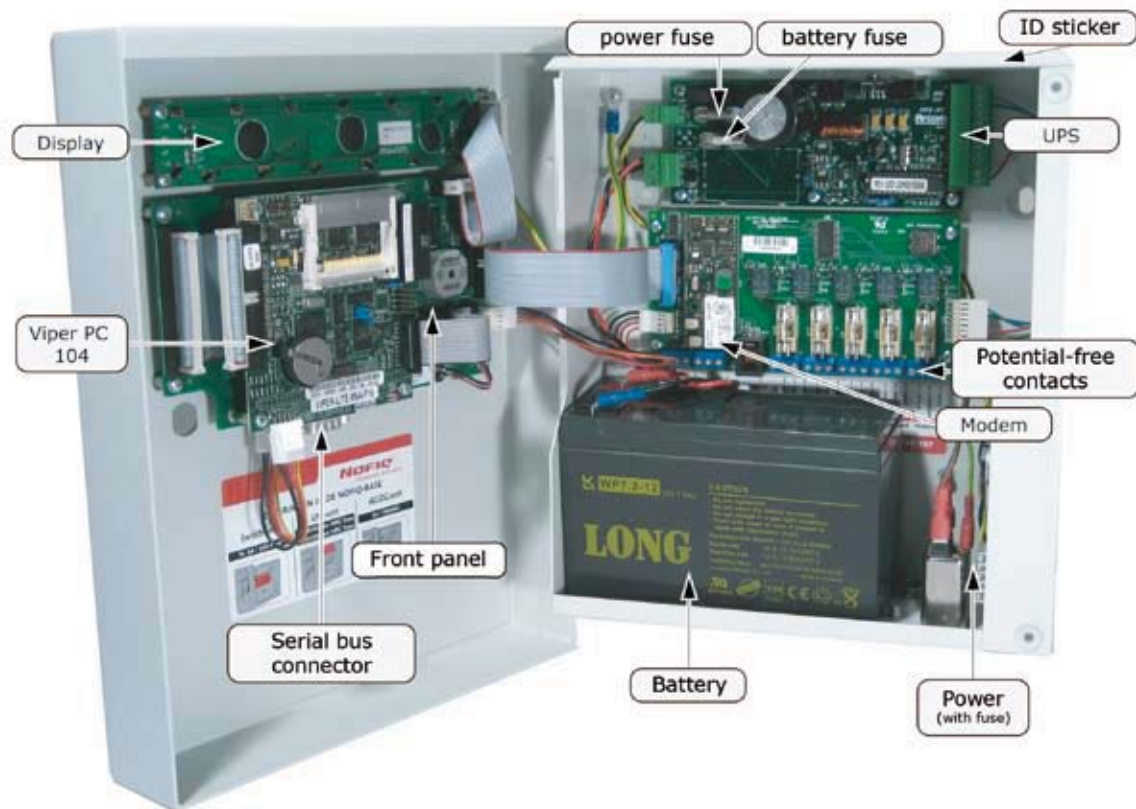

Figure 8 Interior NOFIQ® BASE

10.2 Conditional requirements for the NOFIQ® BASE

When determining the place of the NOFIQ® BASE the following conditional requirements must be taken into account:

- the location must be clean and dry;
- there must be sufficient space to use and open the NOFIQ® BASE;
- the damage risk must be minimal;
- the fire risk must be low;
- there must be sufficient illumination (minimum 100 lux, maximum 500 lux);
- the background noise should not exceed 50 dB(a) otherwise the buzzer cannot be heard properly;
- temperature, air humidity and air pressure should not exceed the limits as mentioned in paragraph 9.3.

10.3 Requirements

For installation of the NOFIQ® BASE you will need:

- NOFIQ® BASE
- Keys belonging to the NOFIQ® BASE
- Fixing material
- Right-angled euro connector
- BASE-HUB cable (4-wire fire-resistant cable)
Maximum length: 3 metres
- Battery



Attention!

**The battery for the NOFIQ® system is supplied by your NOFIQ® provider.
Only these batteries can be used for your NOFIQ® devices.**

- Null modem cable for adding HUBs and FE's by means of a computer
- Modem cable to connect the NOFIQ® BASE to a telephone line
- Network Security Key (NSK)
This is the unique encoding key for the entire NOFIQ® network. This number is identical for each device (BASE, FE, HUB, BASE-HUB) in one and the same NOFIQ® system.
- Network ID
This is the unique identification number for the entire NOFIQ® network. This number is identical for each device (BASE, FE, HUB, BASE-HUB) in one and the same NOFIQ® system.
- Network Channel
This is the radio channel for the network.

10.4 Technical specifications of the NOFIQ® BASE

| Internal power supply | |
|-----------------------------------|--|
| type: | maintenance-free lead battery |
| voltage (volt/Ah) | 12V DC / 7.2 Ah |
| External mains power adapter | |
| power supply | 100 .. 240 V AC 45 .. 60 Hz |
| power consumption | 35 W |
| voltage (volt/A.) | 12V DC / 2.1 A |
| connection | right-angled euro connector |
| Fuses | |
| Potential-free switch contacts | 5 x 2A / 24 V-fast |
| UPS-unit | F1 5A/20mm HRC fuse F2 3A/20mm HRC fuse |
| AC/DC-unit | 2A / 250 V |
| Output/input | |
| 5 potential-free switch contacts | 24V DC / 1A (driven in case of alarm or error) |
| RS232 connector | for configuration and maintenance of the NOFIQ® BASE |
| RJ11 analogue telephone connector | for notification of alarm and error messages via telephone network |
| Modem cable | shielded CAT.5 STP 24AWG 4 pairs |
| Other | |
| weight | 4 kg |
| dimensions (h x w x d) | 304 mm x 244 mm x 89 mm |
| acoustic signal | buzzer 4 - 5 kHz @ 65 dB(A) |
| optical signal | LEDs (yellow, red, green) |
| housing | metal / IP30 |

10.5 Installation and configuration instructions NOFIQ® BASE



Attention!

Heed the safety precautions as stated in chapter 7.



Attention!

It is of the utmost importance to execute the instructions consecutively in the order given.

1. Check if all necessary equipment and accessories for installation are present. See paragraph 10.3.
2. Attach the NOFIQ® BASE to the wall with the fixing material supplied. In the BASE's backside holes have been made for this purpose.



Attention!

First disconnect the battery cable (PL4 at the UPS). This creates more room and diminishes the risk of damaging the temperature sensor. Reconnect the cable when the NOFIQ® BASE has been attached.

Attach the NOFIQ® BASE at such a height that users have a good view at the display and can use the control panel buttons easily.



Make sure that the fastening is solid and safe and can bear the NOFIQ® BASE's weight (including the battery) without any problems.



Guard against falling and slipping.

Use a solid ladder which is stabilized on the floor.



Use eye protection during drilling.

3. Connect the fire-resistant cable to the NOFIQ® BASE. This cable provides the connection between the NOFIQ® BASE and the NOFIQ® BASE-HUB and is fire-resistant during at least 30 minutes. Cabling must be applied in such a way that damage risks are minimal. The construction must be placed in a closed tubular or sleeved system (according to operative regulations).

The figure below shows the correct way of connecting the fire-resistant cable to the NOFIQ® BASE:

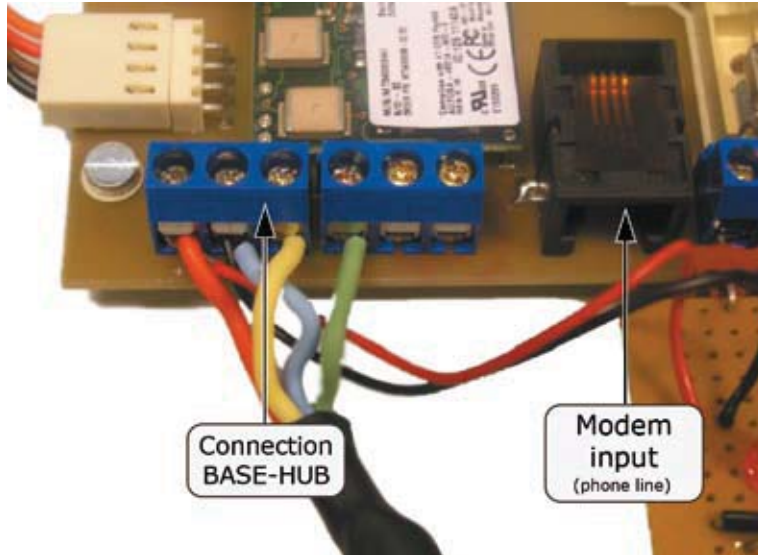

Figure 9 Connection fire-resistant NOFIQ® BASE

The right connections (from left to right):

| | |
|---------|---------------------------|
| Red: | Exit +4 Volt |
| Blue: | Minus |
| Yellow: | Serial communication (TX) |
| Green: | Serial communication (RX) |

4. Connect the modem cable to the NOFIQ® BASE.
5. Connect the potential-free switch contacts.
The NOFIQ® BASE can switch 5 potential-free contacts (max. 24 Volt and max. 1 Ampere).

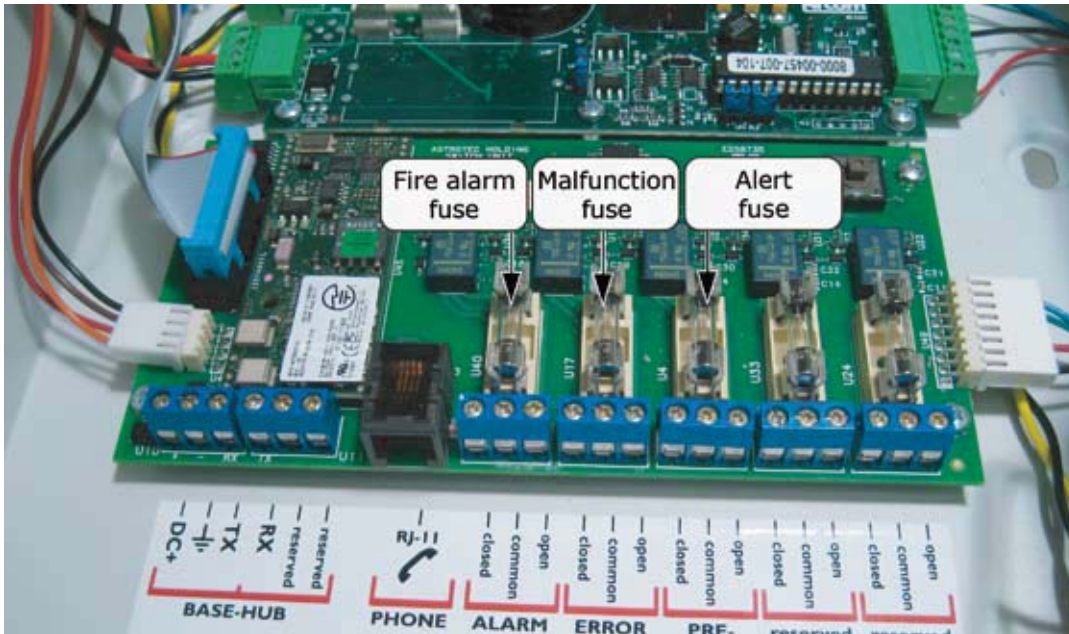

Figure 10 Connection potential-free switch contacts

Three of the switch contacts are in use for (from left to right):

- Fire alarm
- Malfunction
- Alert



Attention!

At this moment there are three (3) switch contacts in de NOFIQ BASE implemented in the software.

The connection order for each switch contact is:

- Normally closed (NC) (left)
- Common (middle, via the fuse)
- Normally open (NO) (right)



Attention!

A potential-free switch contact keeps the position in which it has been put the last time. If a power failure occurs, the position will not change.

6. Put the battery into the NOFIQ® BASE and connect it.

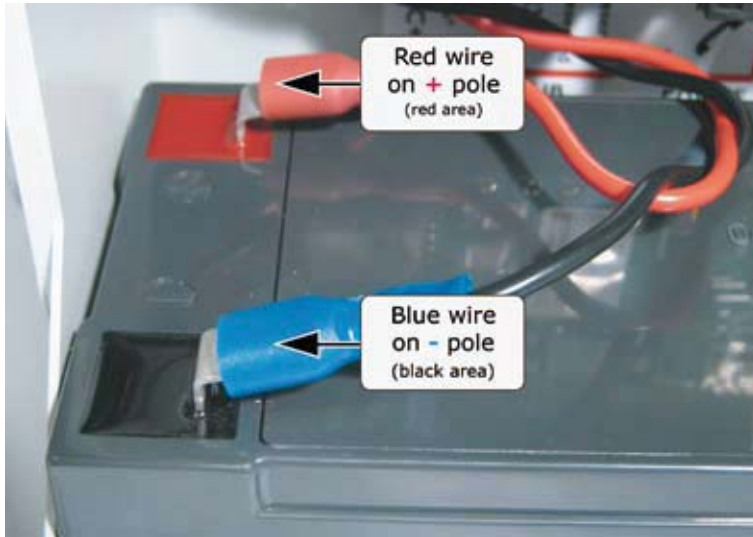

Figure 11 Connection battery NOFIQ® BASE

The red contact point must be connected to the plus side (red facet).
The blue contact point must be connected to the minus side (black facet).



Attention!

The battery for the NOFIQ® system is supplied by your NOFIQ® provider. Only these batteries can be used for your NOFIQ® devices.

7. Fastening the right-angled euro connector.
Connect the right-angled euro connector supplied to the cabling of the public electricity network.

This connector is supplied to ensure that the power supply can only be switched off if the BASE's cabinet is open. Thus unauthorised users will not be able to switch off power by pulling loose the connector.



Warning!

The primary power supply for the NOFIQ® system is supplied by the public electricity network. A fire alarm system, including all its power supply systems, has to be connected to the electricity network by a separate end group.

The power switch of this electricity group must be indicated by the text "Do not switch off, NOFIQ® fire protection system".



Warning!

Do not connect the BASE's power connector to the public electricity network before the NOFIQ® BASE-HUB has been installed and connected to the NOFIQ® BASE by means of the fire-resistant cable.

8. Programming the Network Security Key (NSK).
First of all you have to program the Network Security Key into the NOFIQ® BASE. Hereto you connect a computer with the NOFIQ® BASE by means of a null modem cable and then you start the terminal application as described in paragraph 12.3. When you have started the application, you select the menu Services and then the option Network Security Key.
9. Install the NOFIQ® BASE-HUB. See chapter 11 for a detailed description of the NOFIQ® BASE-HUB's installation.
10. Connect the NOFIQ® BASE's power connector to the public electricity network.
It may take a while (several minutes) before the NOFIQ® BASE has been started.



Warning!

Do not execute this step before the NOFIQ® BASE-HUB has been installed and connected to the NOFIQ® BASE by means of the fire-resistant cable.

11. Connect the null modem cable to the serial port of the NOFIQ® BASE.

When the NOFIQ® BASE is connected to a computer by means of a null modem cable, you can use the computer to consult the NOFIQ® BASE's data, to configure the NOFIQ® BASE and to add FE's and HUBs to the BASE.

Chapter 12 describes how to configure the NOFIQ® BASE.

11. Installation of the NOFIQ® BASE-HUB



Figure 12 The NOFIQ® BASE-HUB

11.1 General

This chapter explains the installation of the NOFIQ® BASE-HUB.

The figure below shows the NOFIQ® BASE-HUB. From the outside the NOFIQ® BASE-HUB looks similar to the NOFIQ® HUB, except for its marking. Other differences between NOFIQ® BASE-HUB and NOFIQ® HUB:

1. The NOFIQ® BASE-HUB has no batteries but uses the primary and secondary power supply of the NOFIQ® BASE.
2. The NOFIQ® BASE-HUB uses a serial communication connection to the NOFIQ® BASE; they are mutually linked by a fire-resistant cable.
3. The NOFIQ® BASE-HUB has no buzzer.

11.2 Requirements

For installation of the NOFIQ® BASE-HUB you will need:

- NOFIQ® BASE-HUB
- Socket for the NOFIQ® BASE-HUB including orange connector
- Antenna
- Torque Wrench for connecting antenna
- Fire-resistant cable (4-wire) of maximum 3 metres



Attention!

There is only one fire-resistant cable connecting the NOFIQ® BASE and the NOFIQ® BASE-HUB. If you have already fixed this cable to the NOFIQ® BASE, you only have to fasten this very cable to the connector of the NOFIQ® BASE-HUB.

11.2 Technical specifications of the NOFIQ® BASE-HUB

| Internal power supply | |
|------------------------|--|
| | internal power supply via NOFIQ® BASE |
| External power supply | |
| | external power supply via NOFIQ® BASE |
| Output/input | |
| RS232 connector | for communicating with the NOFIQ® BASE |
| Communication | |
| frequency | 2.4 GHz (ISM band) |
| radio protocol | ZigBee™ |
| antenna | see specifications in Appendices |
| Other | |
| weight | 250 grams |
| dimensions (h x w x d) | 199 mm x 74 mm x 46 mm (excluding the antenna) height including antenna: 272 mm |
| housing | polycarbonate / class V-2 / IP30 |
| optical signal | 3 LEDs (yellow, green, red) see also paragraph 20.2 |

11.3 Installation and configuration instructions NOFIQ® BASE-HUB



Attention!

Heed the safety precautions as stated in chapter 7.



Attention!

It is of the utmost importance to execute the instructions consecutively in the order given.

1. Check if all necessary equipment and accessories for installation are present. See paragraph 11.2.
2. Remove the orange connector from the socket.
3. Connect the fire-resistant cable from the NOFIQ® BASE to the connector of the NOFIQ® BASE-HUB.
The right connection (from left to right) is as follows:

| Connector port | Wire colour fire-resistant cable | Connection |
|----------------|----------------------------------|---------------------------|
| 1. | Red: | Power exit +4 Volt |
| 2. | Blue: | Minus |
| 3. | Yellow: | Serial communication (TX) |
| 4. | Green: | Serial communication (RX) |
| 5. | - | |
| 6. | - | |

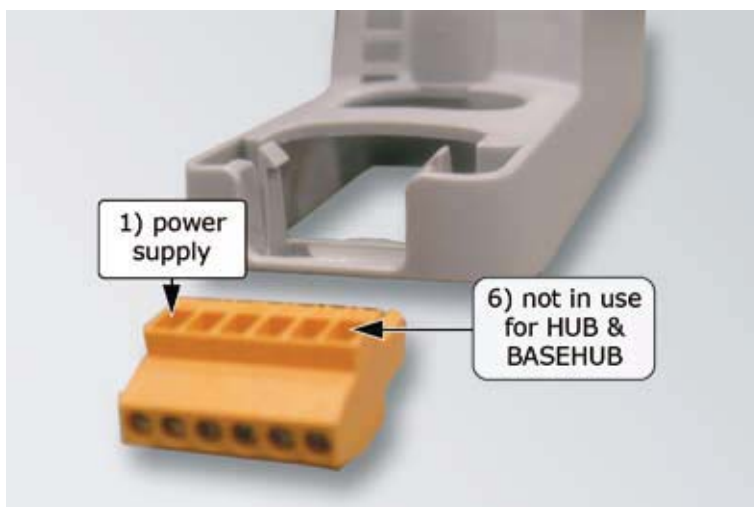

Figure 13 Connection fire-resistant cable to connector NOFIQ® BASE-HUB

4. Place the connector back into the socket.
5. Determine the place where the NOFIQ® BASE-HUB must be fixed.
6. Attach the socket to the wall.
7. Attach the antenna to the NOFIQ® BASE-HUB.



Attention!
Turn the antenna with a Torque Wrench thoroughly tight.

8. Click the NOFIQ® BASE-HUB into the socket.
9. Attach the cabling to the wall by using clamps according to the operative regulations.
10. When the NOFIQ® BASE-HUB has been attached to the wall and is ready for operation, you can plug the NOFIQ® BASE's power connector into the plug socket. It may take several minutes before the NOFIQ® BASE has been started.

11. When you have installed the NOFIQ® BASE and the NOFIQ® BASE-HUB you have to prepare the NOFIQ® BASE for communication with the other components within the system. Hereto you connect a computer with the NOFIQ® BASE by means of a null modem cable and then you start the terminal application as described in paragraph 12.3. When you have started the application, select:

- menu 3. Services
- option 3. Network Status
- option 3. BASE-HUB
- option 2. Modify BASE-HUB

You need to set the following data:

- The SNA for the NOFIQ® BASE-HUB;
this is always 0
- The network identification number
- The network channel;
this is a number in the range 11 through 26.

After setting the data, you select:

- option 3. Make operational
Executing this option makes the BASE-HUB and thus also the NOFIQ® BASE operational.

12. Configuration and data management

NOFIQ® BASE

12.1 General

This chapter explains how to configure the NOFIQ® BASE and how to change the BASE's settings. Furthermore it contains an overview of the data on the system's components the BASE offers. For setting and/or changing the data you need to connect a computer (laptop, notebook or PC) to the NOFIQ® BASE by means of a null modem cable.

12.2 Requirements

For setting or reading the data in the NOFIQ® BASE you will need:

- a computer (laptop, notebook or PC)
- a null modem cable

12.3 Configuring and managing data in the NOFIQ® BASE

In order to configure the NOFIQ® BASE do as follows:

1. Open the NOFIQ® BASE with the (mechanical) key (lock at the right).
2. Connect a computer (laptop, notebook or PC) by means of a null modem cable to the NOFIQ® BASE's serial port.
3. Start the computer.
4. When the computer has been started, select on your computer the communication application HyperTerminal.
This application is usually installed by default in each MS Windows version.
Choose in consecutive order:

| |
|----------------|
| Start |
| Programs |
| Accessories |
| Communications |
| HyperTerminal |
5. Fill in a name for the connection (e.g. NOFIQ®) and click OK.
6. Next the screen 'Connect to' appears. Select in the field at the bottom a COM port available (e.g. 'Direct to Com1').
Click OK.

7. Next the screen 'Port Settings' appears.

Select the following settings:

| | |
|------------------|--------|
| Bits per second: | 115200 |
| Data bits: | 8 |
| Parity: | None |
| Stop bits: | 1 |
| Flow control: | None |

Click OK.

8. Open the connection (Call)

Press Enter.

Next a screen appears that approximately looks as follows:

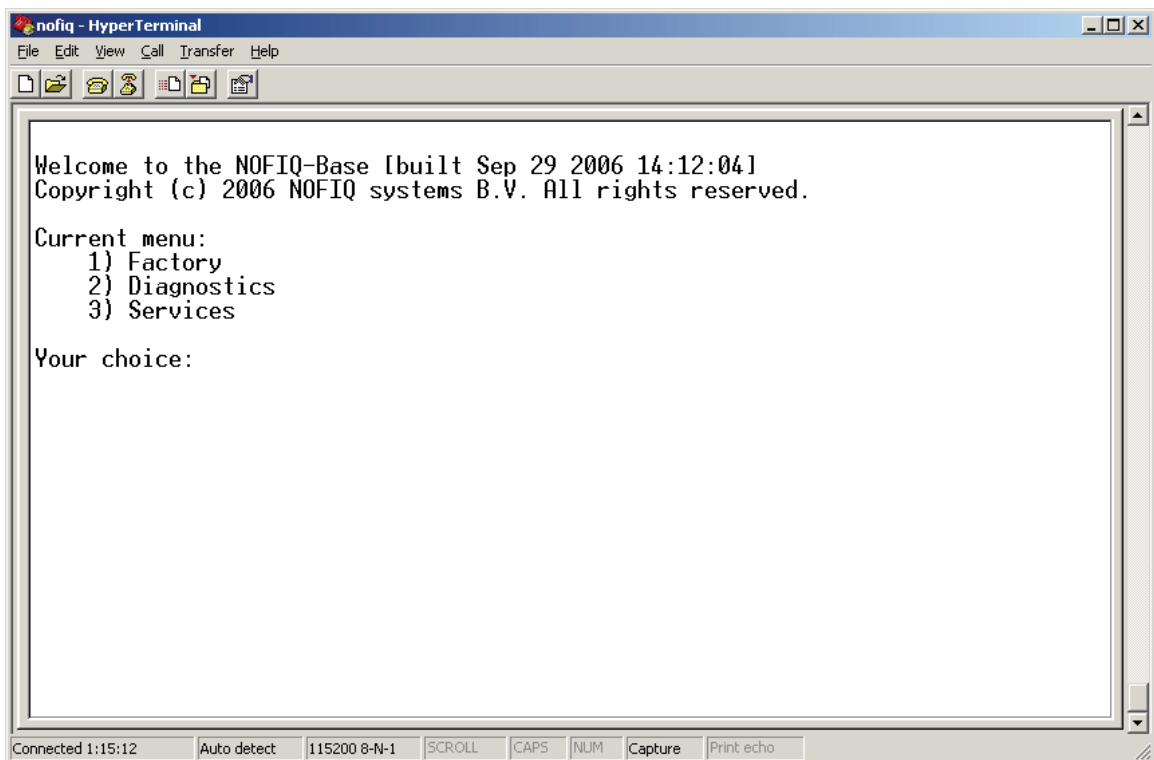

The screenshot shows a HyperTerminal window titled 'nofiq - HyperTerminal'. The window contains the following text:

```
Welcome to the NOFIQ-Base [built Sep 29 2006 14:12:04]
Copyright (c) 2006 NOFIQ systems B.V. All rights reserved.

Current menu:
  1) Factory
  2) Diagnostics
  3) Services

Your choice:
```

The status bar at the bottom of the window shows: Connected 1:15:12, Auto detect, 115200 8-N-1, SCROLL, CAPS, NUM, Capture, Print echo.

You are now in the terminal (maintenance) application for the NOFIQ® BASE. This terminal application enables you to set, change or read data .



Attention!

This application does not have the same function as the Maintenance Menu which appears in the display of the NOFIQ® BASE and which can be accessed by means of the buttons of the control panel of the BASE.

The menu structure and the options available in the terminal application are explained in paragraph 12.4.

12.4 Menu terminal application NOFIQ® BASE

The main menu of the terminal application for the NOFIQ® BASE has the following submenus:

1. Factory
The submenu will be explained in paragraph 12.4.1.
2. Diagnostics
The submenu will be explained in paragraph 12.4.2.
3. Services
The submenu will be explained in paragraph 12.4.3.
With the options of this menu you are able to (among other things):

- set and read the Network Security Key
- read out the first available Short Network Address
- set the radio channel for the NOFIQ® BASE-HUB
- make the NOFIQ® BASE-HUB operational
- add or remove a NOFIQ® HUB to the network
- add or remove a NOFIQ® FE to the network
- query for details about registered NOFIQ® HUBs or NOFIQ® FE's
- set telephone numbers for notification



Attention!

The menu interaction uses a time-out. If you are working within the menu and do not choose an option during a certain amount of time, pressing Enter will result in the text 'Time-out' on screen. Next the application will return to the main menu.



Attention!

Some data entry items have a text that looks like as follows:

"New NSK or ENTER"

If you do not want to change anything, press Enter in such a case. The data for the option in question remain unchanged.

12.4.1 The Factory menu

By using the options of the Factory menu you can query data about the NOFIQ® BASE's factory status.

The Factory menu contains the following options:

| Nr. | Menu option | Application |
|-----|--------------------|---|
| 1 | Test BASE hardware | Choose this option to test the hardware of the NOFIQ® BASE. |
| 2 | Serial number | This option shows the serial number of this device. |

| Nr. | Menu option | Application |
|-----|-------------|---|
| 3 | Console | This option has been reserved for factory use; with this option someone can login to the system to, for example, modify the software. |
| 0 | Back | Choose this option to return to the main menu. |

12.4.2 The Diagnostics menu

By using the options of the Diagnostics menu you can query data about the software and hardware of the NOFIQ® BASE.

The Diagnostics menu contains the following options:

| Nr. | Menu option | Application |
|-----|--------------------|---|
| 1 | Test BASE hardware | Choose this option to test the hardware of the NOFIQ® BASE. |
| 2 | Hardware version | This option shows the version numbers of the hardware of this device. |
| 3 | Software version | This option shows the version numbers of the software installed at this device. |
| 0 | Back | Choose this option to return to the main menu. |

12.4.3 The Services menu

With the options of this menu you are able to (among other things):

| | | |
|---|---|---|
| • | set or read the Network Security Key (NSK) | - menu option 1 |
| • | read out the first available Short Network Address for a HUB or an FE | - menu option 2 |
| • | set the radio channel of the NOFIQ® BASE-HUB | - menu option 3, then - menu option 3, then - menu option 2 |
| • | make the NOFIQ® BASE-HUB operational (and with that the NOFIQ® BASE) | - menu option 3, then - menu option 3, then - menu option 3 |
| • | add a NOFIQ® HUB to the NOFIQ® BASE | - menu option 3, then - menu option 2, then - menu option 4 |
| • | add an NOFIQ® FE to the NOFIQ® BASE | - menu option 3, then - menu option 1, then - menu option 4 |
| • | download error data | - menu option 4 |

Furthermore you can use this menu to read and set data on the elements of the entire NOFIQ® network: all FE's, all HUBs and the BASE-HUB.

12.4.4 The Network Status submenu

With the options of the Network Status you can read, change or set (status) data for each component in the NOFIQ® network.

How to access the Network Status submenu:

1. Choose in the Main menu option 3. Services
2. Choose in the Services menu option 3. Network Status.

The Network Status submenu offers the following options:

- 1 FE
- 2 HUB
- 3 BASE-HUB
- 0 Back

The options are explained below.

| Nr | Option | Nr. | Options | Application |
|----|--------|-----|------------------------|---|
| 1 | FE | 1 | Show all FE's | This option shows a list of all FE's. The information shown is explained in paragraph 12.4.5. |
| | | 2 | Show all FE's in error | This option shows a list of all FE's in error, for example after they have executed an extinguishing. |
| | | 3 | Show FE details | This option shows details of an FE. After selecting an FE's SNA the information about the FE in question will be shown. The information is explained in paragraph 12.4.5. |
| | | 4 | Add FE to network | With this option you can add an FE to the network. Consecutively record the SNA and the location of the FE. |
| | | 5 | Remove FE from network | With this option you can remove an FE from the network. Select the FE to be removed. Next type 'y' to confirm the removal. |
| | | 6 | Modify FE | Select the FE to be modified. Next you have the following choices: <ol style="list-style-type: none"> 1. Enable FE 2. Disable FE 3. Location change the location data of the FE. |
| | | 0 | Back | Choose this option to return to the Network Status submenu. |
| 2 | HUB | 1 | Show all HUBs | This option shows a list of all HUBs. The information shown is explained in paragraph 12.4.6. |
| | | 2 | Show all HUBs in error | This option shows a list of all HUBs in error. |
| | | 3 | Show HUB details | This option shows details of a HUB. After selecting an HUB's SNA the information about the HUB in question will be shown. The information is explained in paragraph 12.4.6. |

| Nr | Option | Nr. | Options | Application |
|----|----------|-----|-------------------------|--|
| | | 4 | Add HUB to network | With this option you can add an HUB to the network. Consecutively record the SNA and the location of the HUB. |
| | | 5 | Remove HUB from network | With this option you can remove an HUB from the network. Select the HUB to be removed. Next type 'y' to confirm the removal. |
| | | 6 | Modify HUB | Select the HUB to be modified. Next you have the following choices: 1. Enable FE 2. Disable FE 3. Location change the location data of the FE. |
| | | 0 | Back | Choose this option to return to the Network Status submenu. |
| 3 | BASE-HUB | | | |
| | | 1 | Show BASE-HUB details | This option shows the following details of the NOFIQ® BASE-HUB: -Network Address -Network ID -Network Channel -Mode (status) |
| | | 2 | Modify BASE-HUB | With this option you can set the NOFIQ® BASE-HUB's data, namely: • Network Address The SNA for the NOFIQ® BASE-HUB is always 0. • Network ID The network's identification number. • Network Channel The network's radio channel. This is a number in the range 11 through 26. |
| | | 3 | Make operational | With this option you make the BASE-HUB operational. Use this option if the NOFIQ® BASE-HUB is in FACTORY status. |
| | | 0 | Back | Choose this option to return to the Network Status submenu. |

12.4.5 Shown data on a NOFIQ® FE

When you query data on all FE's (Network Status menu: option 1. FE and then: option 1. Show all FE's) the terminal application shows a screen that looks like this:

| SNA | D | O | PP | SP | St | S | A | F | Errors | Pw | CO | Tmp | Last heartbeat |
|-----|---|---|-----|-----|----|---|---|---|---------|----|----|-----|----------------|
| 702 | - | - | 0 | 712 | SA | - | - | - | ----- | B | 0 | 20 | 03/09 10:23:43 |
| 703 | - | - | 711 | 713 | SA | - | - | - | ----- | B | 0 | 19 | 03/09 10:23:58 |
| 704 | - | - | 711 | 713 | SA | - | - | - | ----- | B | 0 | 20 | 03/09 10:23:59 |
| 701 | x | - | 712 | 711 | EA | - | - | - | ----- | B | 0 | 27 | 03/09 10:24:26 |
| 705 | - | - | 0 | 712 | SA | x | - | - | EI----- | B | 0 | 18 | 03/09 09:59:59 |

803 - - 0 711 SA - - - - - B 0 21 03/09 10:26:11

Explanation of the data on screen

SNA Short Network Address
The FE's Short Network Address.

D Disabled
This column is marked (x) if the FE has been disabled.

O Offline
This column is marked (x) if the FE is offline.

PP Primary Parent
This is the SNA of the HUB that functions as the FE's Primary Parent.
0 NOFIQ® BASE-HUB
n/a No primary parent available

SP Secondary Parent
This is the SNA of the HUB that functions as the FE's Secondary Parent.
0 NOFIQ® BASE-HUB
n/a No secondary parent available

St Status (see also paragraph 22.3)
The FE's status.
Options:

- SA Safe
- FA Factory – the NOFIQ® FE has not yet reported to the BASE
- AL Alert
- PE Fire alarm
- EA Extinguishing activated

S Suspend
This column is marked (x) if the FE is in Suspend status.

A Alert
This column is marked (x) if the temperature or CO concentration measured correspond with the conditions for Alert.

F Fire

This column is marked (x) if the temperature or CO concentration measured correspond with the conditions for Fire Alarm.

Errors Malfunction

If an FE has detected one or more errors, this column will state an E followed by one or more letter codes (each code has its own position)

Code Pos.

- E 1 An error has occurred; the following positions will clarify the error(s). .
- I 2 Internal error
- C 3 Error CO sensor
- T 4 Error temperature sensor
- R 5 Error relay (potential-free switch contact)
- I 6 Error igniter extinguishing component
- B 7 Error InterNOFIQBus

Pw Power

This column shows which type of power supply is used by the FE.

Options:

- B Battery
- BL Battery low
- BC Battery critical
- M Mains power

CO Carbon monoxide

This column shows the difference in CO concentration (in ppm) between the most recent reading and the reading from one minute before.

Tmp Temperature

This column shows the latest measured temperature in degrees Celsius.

Last heartbeat Status report

This column shows the date and time of the FE's most recent heartbeat (status report) received at the NOFIQ® BASE.

22.4.6 Shown data on a NOFIQ® HUB

When you query data about all HUBs (Network Status menu: option 1. HUB and then: option 1. Show all HUBs) the terminal application shows a screen that looks like this:

| SNA | D | O | PP | SP | Errors | Pw | Last heartbeat |
|-----|---|---|----|-----|--------|----|----------------|
| 711 | - | - | 0 | 712 | -- | B | 03/09 10:23:43 |

| | | | | | | | |
|-----|---|---|-----|-----|----|---|----------------|
| 712 | - | - | 711 | 713 | -- | B | 03/09 10:23:58 |
| 713 | - | - | 712 | 711 | -- | B | 03/09 10:23:59 |
| 714 | - | - | 0 | 713 | -- | B | 03/09 10:24:26 |

Explanation of the data on screen

SNA Short Network Address

The HUB's Short Network Address.

D Disabled

This column is marked (x) if the HUB has been disabled.

O Offline

This column is marked (x) if the HUB is offline.

PP Primary Parent

This is the SNA of the HUB that functions as this HUB's Primary Parent.

SP Secondary Parent

This is the SNA of the HUB that functions as this HUB's Secondary Parent.

Errors Malfunction

If an HUB has detected an error, this column will state an E (error) followed by a letter code

Options:

I Internal error

Pw Power

This column shows which type of power supply is used by the HUB.

Options:

B Battery

BL Battery low

BC Battery critical

M Mains power

Last Status report

heartbeat

This column shows the date and time of the HUB's most recent heartbeat (status report) received at the NOFIQ® BASE.

13. Installation of a NOFIQ® HUB

13.1 General

This chapter explains the installation of a NOFIQ® HUB.

From the outside the NOFIQ® HUB looks similar to the NOFIQ® BASE-HUB (except for its marking). In contrast to the NOFIQ® BASE-HUB the NOFIQ® HUB uses batteries as secondary power supply. Furthermore the NOFIQ® HUB is provided with a buzzer.



Attention!

In order to operate properly the NOFIQ® system needs at least two (2) NOFIQ® HUBs . Thus a backup route for communication between an FE and the BASE is guaranteed.

Whenever you install the very first NOFIQ® HUB in a new NOFIQ® system, the system will generate an error message (Parent missing), since there is no backup route (via a second HUB) available yet. As soon as the second HUB is correctly installed, the error message will disappear automatically.

13.2 Requirements

For installation of the NOFIQ® HUB you will need:

- NOFIQ® HUB
- Socket for the NOFIQ® HUB including orange connector
- Antenna / Torque Wrench for connecting antenna
- Mains power adapter



Attention!

The adapter for the NOFIQ® system is supplied by your NOFIQ® provider. Only these adapters can be used for your NOFIQ® devices.

- Battery-pack



Attention!

The battery-pack for the NOFIQ® system is supplied by your NOFIQ® provider. Only these battery-packs can be used for your NOFIQ® devices.

- Network Security Key (NSK)
this can be obtained from the NOFIQ® BASE or the installation plan
- Short Network Address (SNA)
this can be obtained from the NOFIQ® BASE or the installation plan
- Network ID
this can be obtained from the NOFIQ® BASE or the installation plan
- Network Channel
this can be obtained from the NOFIQ® BASE or the installation plan

13.3 Technical specifications of the NOFIQ® HUB

| Internal power supply | |
|------------------------------|--|
| type power supply | lithium battery FeS ₂ |
| voltage (volt / amp.) | 3V / 3000mA |
| lifetime | max. 2 years |
| External mains power adapter | |
| power | 230 V, 50 Hz for Europe; 110 V 60Hz for the United States of America |
| voltage (volt / amp.) | 4V DC / 1200 mA |
| Output/input | |
| RS232 connector | for configuration and maintenance of the NOFIQ® HUB |
| Communication | |
| frequency | 2.4 GHz (ISM band) |
| radio protocol | ZigBee™ |
| antenna | see specifications in Appendices |
| Other | |
| weight | 250 grams |
| dimensions (h x w x d) | 199 mm x 74 mm x 46 mm (excluding the antenna) height including antenna: 272 mm |
| housing | polycarbonate / class V-2 / IP30 |
| acoustic signal | buzzer, 4 – 5 kHz @ 55 dB(A) |
| optical signal | 3 LEDs (yellow, green, red) see also paragraph 21.2 |

13.4 Installation and configuration instructions NOFIQ® HUB



Attention!

Heed the safety precautions as stated in chapter 7.



Attention!

It is of the utmost importance to execute the instructions consecutively in the order given.

1. Retrieve the Network Security Key (NSK), the Short Network Address (SNA), the Network ID and the Network Channel from the NOFIQ® BASE or the installation plan. Hereto you connect a computer to the NOFIQ® BASE by means of a null modem cable and then you start the terminal application as described in paragraph 12.3. When you have started the application, you consecutively select:
 - menu 3. Services
 - option 1. Network Security Key
 - option 2. First available short network address

Write down all data.

2. Check if all necessary equipment and accessories for installation are present. See paragraph 13.2.
3. Remove the orange connector from the socket.
4. Connect the NOFIQ® HUB's mains power adapter to the orange connector.
The right connection (from left to right) is as follows:

| Connector port | Wire colour | Connection |
|----------------|--|----------------------|
| 1. | Black with white stripe and red sleeve | Power supply +4 Volt |
| 2. | Black (completely black) | Minus / earth |
| 3. | | |
| 4. | | |
| 5. | - | |
| 6. | - | |

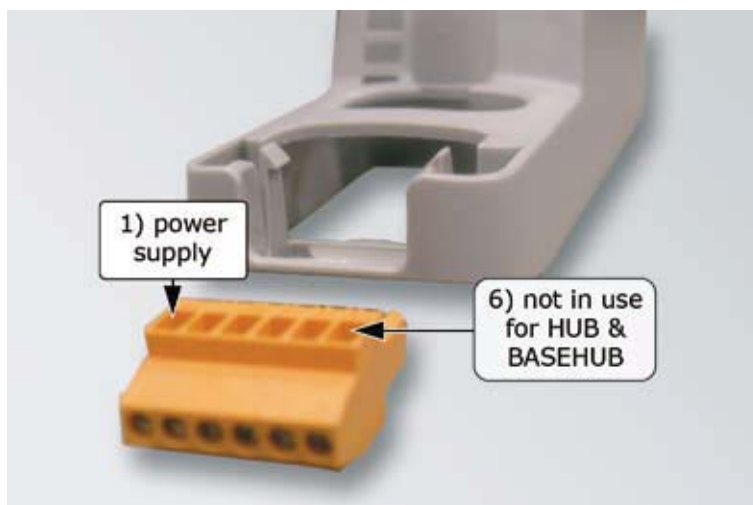
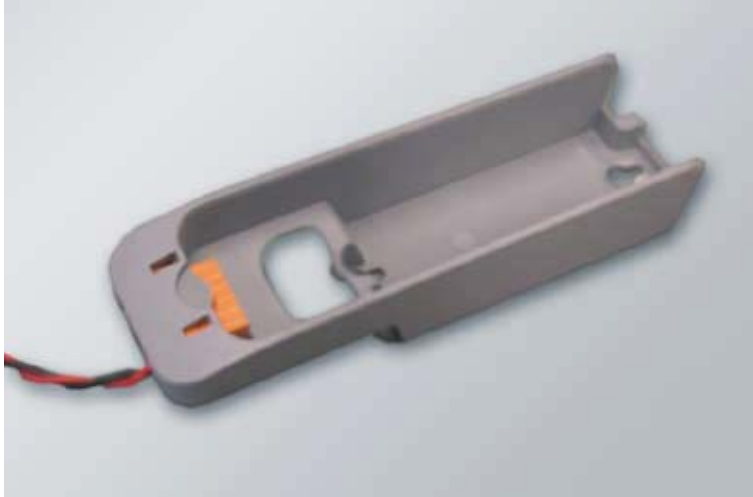

Figure 14 Connection NOFIQ® HUB connector

5. Place the connector back into the socket.



6. Take the NOFIQ® HUB out of the socket and remove the lid of the battery holder (push with your finger in the direction of the arrow).
7. Place the battery-pack and connect the battery connector (red on the outside, black on the inside). The connector has been made in such a way that there is only one possible way to connect it.



Attention!

The battery-pack for the NOFIQ® system is supplied by your NOFIQ® provider. Only these battery-packs can be used for your NOFIQ® devices.

8. Place the lid back onto the battery holder.
9. Configure the NOFIQ® HUB
Connect the NOFIQ® HUB by means of a Maintenance Interface cable (MIC) to a computer (e.g. a laptop). Start the application 'NOFIQ® PC Control'. Program the Network Security Key (NSK), the Short Network Address (SNA), the Network ID and the Network Channel, as described in chapter 14.
10. Determine the place where the NOFIQ® HUB must be fixed.
11. Fix the socket (at its destined location).



Attention!

A NOFIQ® HUB must always be fixed vertically in order that the antenna points upwards.

12. Attach the antenna to the NOFIQ® HUB.



Attention!

Turn the antenna with a Torque Wrench thoroughly tight.

13. Click the NOFIQ® HUB into the socket.
14. Plug the adapter into the plug socket.
15. Press the NOFIQ® HUB's button for two seconds. On release of the button the NOFIQ® HUB leaves factory status.
16. Add the NOFIQ® HUB to the NOFIQ® BASE.
Hereto you connect a computer to the NOFIQ® BASE by means of a null modem cable and then you start the terminal application as described in paragraph 12.3. When you have started the application, you consecutively select:
menu 3. Services
option 3. Network Status
option 2. HUB
option 4. Add HUB to network



Attention!

Downloading the Granted nodes database.

After installation of all components of the NOFIQ® system, you have to download the Granted nodes database from the NOFIQ® BASE and store it at a secure place. If something should go wrong with the NOFIQ® BASE, uploading the database will suffice to restore the data; adding all devices again would not be necessary.

You can download the Granted nodes database by means of the terminal application of the NOFIQ® BASE (see chapter 12.3)



Attention!

In order to operate adequately the NOFIQ® system needs at least two (2) NOFIQ® HUBs. Thus a backup route for communication between an FE and the BASE is guaranteed.

Whenever you install the very first NOFIQ® HUB in a new NOFIQ® system, the system will generate an error message (Parent missing), since there is no backup route (via a second HUB) available yet. As soon as the second HUB is correctly installed, the error message will disappear automatically.

14. Configuration NOFIQ® HUB or NOFIQ® FE

14.1 General

A NOFIQ® HUB as well as a NOFIQ® FE needs to be configured so that all components of the NOFIQ® network will function and communicate properly. For every NOFIQ® FE and NOFIQ® HUB its network address (SNA) must be recorded as well as the Network Security Key, the Network ID and the Network Channel.



Attention!

Configuration of a standalone FE.

A standalone FE has already been configured when it leaves factory. By default it is set that the potential-free contact switches in case of Fire alarm (Pre-extinguishing).

Only if you want to change these settings, you must configure a standalone FE. If you do not wish to change the settings, configuration is not needed.

14.2 Requirements

In order to read or set data of a NOFIQ® HUB or FE you will need:

- a computer (laptop, notebook or PC)
- a NOFIQ® Maintenance Interface cable (D-MIC-RA0100)
- the software application NOFIQ® PC Control (PC_Control.exe)
- Network Security Key (NSK)
this can be obtained from the NOFIQ® BASE or the installation plan
- Short Network Address (SNA)
this can be obtained from the NOFIQ® BASE or the installation plan
- Network ID
this can be obtained from the NOFIQ® BASE or the installation plan
- Network Channel
this can be obtained from the NOFIQ® BASE or the installation plan

14.3 Configuring a NOFIQ® HUB or NOFIQ® FE

In order to configure a HUB or FE do as follows:

1. Connect one end of the NOFIQ® Maintenance Interface cable (MIC) to the communication port (com-port) of the computer (or else through a USB/RS232 adapter).
2. Connect the other end of the MIC cable to the appropriate connector of the HUB or FE.
3. Start the computer.

- Start the application 'NOFIQ® PC Control' (PC_Control.exe)
The next screen appears:

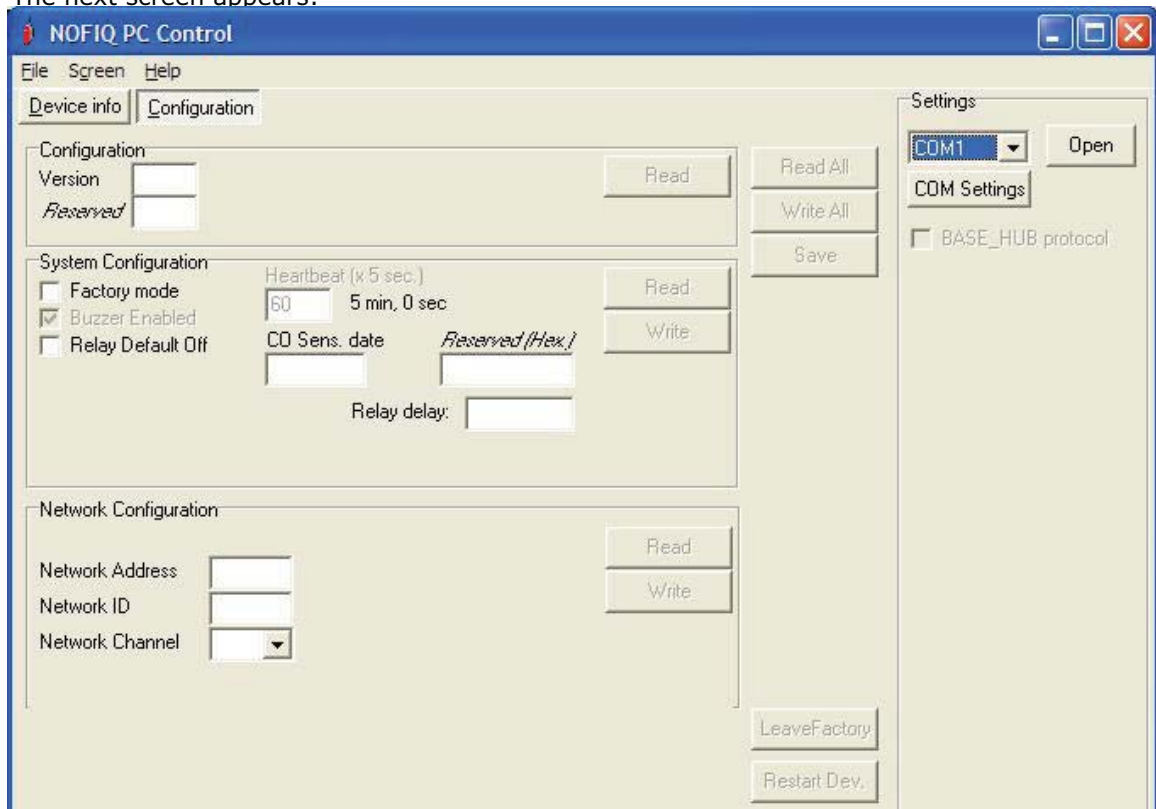

- Click the button 'Com Settings' to set the communication data.
A pop-up screen appears.
Select in this screen the following settings:

Port: COM1 (or else the first available COM port)
 Baud rate: 57600
 Data bits: 8
 Stop bits: 1
 Parity: None
 Flow control: None

- Click OK.
- Click the button 'Open' (upper right on the screen).
Then the communication with the HUB or FE is started.
- Click the button 'Read' in the section Configuration.
Click the button 'Read' in the section System Configuration.
Click the button 'Read' in the section Network Configuration.
Now all information is read and the screen will look (approximately) as follows:

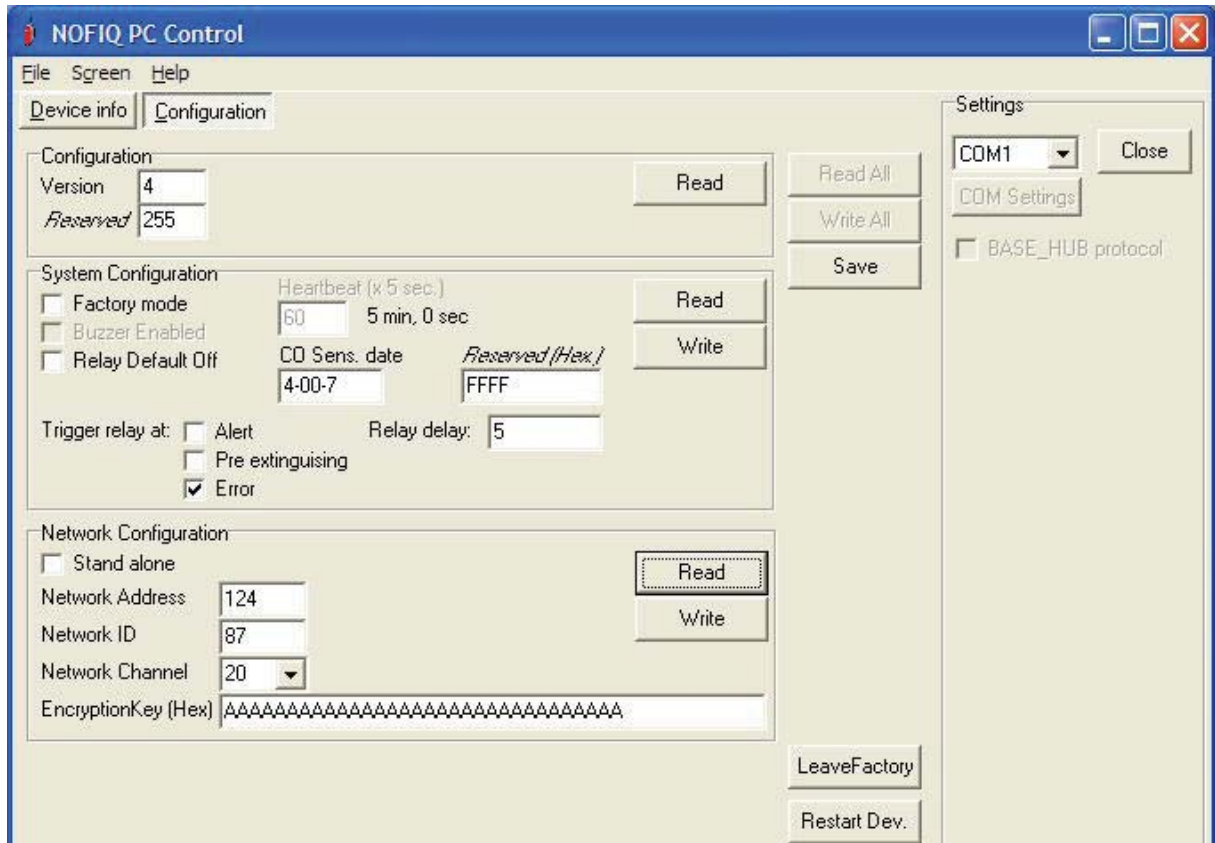

9. You are now able to configure the HUB or FE.
 For a standalone FE the field 'Standalone' is ticked by default. In this case the fields 'Network Address', Network ID, Network Channel and Encryption Key do not apply.
 If you want to configure an FE for a network, you need to fill in at least the following fields:

| | |
|------------------------|--|
| • Network Address | This is the HUB's or FE's Short Network Address (SNA); a number in the range [2..65534]. |
| • Network ID | This is the network's identification number; a number in the range [1..255]. This number must be identical for each device in the network. |
| • Network Channel | This is the network's radio channel; a number in the range [11..26]. This number must be identical for each device in the network. |
| • Encryption Key (Hex) | This the system's Network Security Key (NSK); a number of 32 digits (32*[0..9]). |



Attention!

The data mentioned above are mandatory for an FE in a NOFIQ network. Other data for a HUB or FE are set by default. If required you can change the other data in the section System Configuration. The meaning of all buttons and fields of this screen are explained in the next paragraphs.

10. If you have set all data:
Click the button 'Write' in the section System Configuration.
Click the button 'Write' in the section Network Configuration.
Click the button 'Save'.
All data have been saved.
11. Click the button 'Restart Device'.
The NOFIQ® HUB or NOFIQ® FE is now configured.

14.3.1 Fields and buttons from screen section Configuration

The screen section Configuration offers data about the software.

Version

The software version.

Reserved

Software data. These are of no concern for the user.

Read

With this button you read the software data of the HUB or FE.

14.3.2 Fields and buttons from screen section System Configuration

The screen section System Configuration offers data about the HUB or FE. These data can be modified.

Factory mode

Ticking this option will put the HUB or FE into Factory status.

Buzzer enabled

If this option is ticked, the buzzer of this device is enabled.

Relay Default Off

The default position for the FE's relay (switch contact) is closed. If you tick this option, the relay's default position will be open.

Heartbeat

This is the time interval between each heartbeat the device sends.



Attention!

If the heartbeat interval is set lower than 5 minutes (60 x 5 seconds), this will have a negative effect on the batteries' lifetime.

CO sens. date

This is the production date of the CO sensor.

Reserved

Software data. These are of no concern for the user.

Trigger relay at

Here you can choose in which situation the FE's potential-free contact must be switched. You can choose from:

- Alert
- Pre-extinguishing (Fire alarm)
- Error (Malfunction)

Relay delay

The delay time (in seconds) before the potential-free contact will be switched.

The maximum number of seconds that can be set is 120.

Read

Click this button to read the configuration data of the HUB or FE.

Write

Click this button to write the (modified) data of an HUB or FE. Click the button 'Save' to actually save the data.

14.3.3 Fields and buttons from screen section Network Configuration

The screen section Network Configuration offers information about network settings of a HUB or FE. These data can be modified.

Standalone

This field must be ticked if the FE is to function standalone. If this field is ticked, the fields like 'Network Address', 'Network ID', 'Network Channel' and 'Encryption Key' will not be available.

Network Address

This the Short Network Address, the unique network address granted to the HUB or FE.



Attention!

The network address of the BASE-HUB is 0; this number can never be granted to a HUB or FE.

Network ID

This is a unique identification number of the entire NOFIQ® network; a number in the range [1..255].

This number must be identical for each device (HUB, FE and BASE-HUB) in the network. Thanks to this ID different networks are separated from each other and FE data cannot turn up in another network (e.g. the neighbour's network) by accident.

Network Channel

This is the network's radio channel; a number in the range [11..26]. This number must be identical for all devices in the network.

Encryption Key (Hex)

This is the Network Security Key (NSK), a code that prevents interception of NOFIQ® network communication by external devices. The NSK is a number of 32 digits (32 * [0..9]).

This code must be identical for each device in the network.

Read

Click this button to read the network data of the HUB or FE.

Write

Click this button to write the (modified) network data of an HUB or FE. Click the button 'Save' to actually save the data.

14.3.4 Other buttons from screen section Configuration

Read All

Click this button to read all data of the HUB or FE.

Write All

Click this button to write all (modified) data of an HUB or FE. Click the button 'Save' to actually save the data.

Save

Click this button to save data.

Leave Factory

Click this button to have the HUB or FE leave factory status.

Restart Dev.

Click this button to restart a FE, HUB or BASE-HUB.

Device Info

Click this button to retrieve device information on the FE of HUB. Next a screen appears; this screen's data and buttons will be explained in paragraph 14.3.5.

14.3.5 Buttons and data on the screen Device info

Clicking the Device Info button gathers information about the NOFIQ® FE or NOFIQ® HUB. If you click this button, the following screen appears:

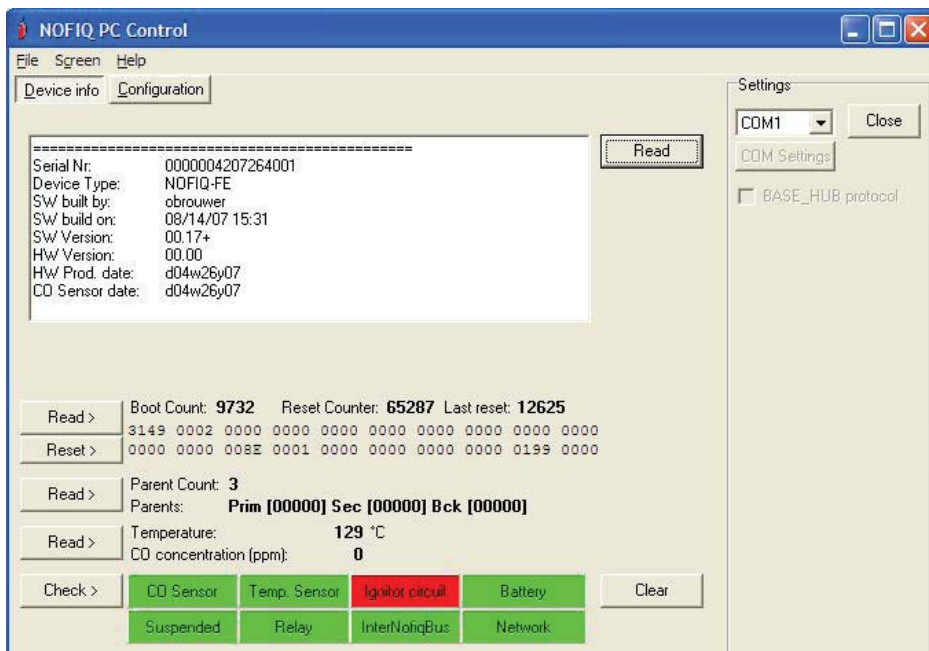

Read

Click all Read buttons to read the information.

The screen shows the following data:

- Serial number
- Device type (NOFIQ® FE or NOFIQ® HUB)
- Software data (version and production date)
- Hardware data (version and production date)
- CO sensor production date

In the lower section the following data are displayed:

- the device's parents
- the temperature and CO concentration measured

Reset

Click this button to reset the counter to 0.

Check

With this button you can check the operation of the elements of the device in question. A properly operating part is displayed in green, a malfunctioning part is displayed in red.

The following items will be checked:

- CO sensor
- Temperature sensor
- Igniter of the extinguishing component (Igniter circuit)
- Batteries (green = battery OK; yellow = battery low); red = battery critical)

This square will not be shown when the device operates on mains power.

- Suspended (red = suspended)
- Potential-free switch contact (Relay)
- InterNOFIQBus
- Network (not applicable to a standalone FE)



Attention!

Since a standalone NOFIQ® FE cannot notify an error message to a BASE, it is not possible to determine at once which type of error has occurred. When you have connected the FE in question via a MIC to a computer (laptop) and then start this program (NOFIQ PC Control) , you can determine the error(s) by using the button Check. (see chapter 15.5, page 80)

Clear

Click this button to clear the screen.

Configuration

Click this button to read or modify all configuration data as described in paragraph 14.3.

15. Installation of a NOFIQ® FE

15.1 General

This chapter explains the installation of a NOFIQ® FE.

15.2 Requirements

For installation of the NOFIQ® FE you will need:

- NOFIQ® FE
- Socket for the NOFIQ® FE including orange connector
- Antenna + antenna extension cord
- Torque Wrench for connecting antenna
- Warning stickers
"NOFIQ® fire protection system, in case of fire or alarm: do not panic, close cabinet doors and alert expert assistance"
- Mains power adapter (use is optional for an FE)



Attention!

The adapter for the NOFIQ® system is supplied by your NOFIQ® provider. Only these adapters can be used for your NOFIQ® devices.

- Battery-pack



Attention!

The battery-pack for the NOFIQ® system is supplied by your NOFIQ® provider. Only these battery-packs can be used for your NOFIQ® devices.

- Network Security Key (NSK)
this can be obtained from the NOFIQ® BASE or the installation plan
- Short Network Address (SNA)
this can be obtained from the NOFIQ® BASE or the installation plan
- Network ID
this can be obtained from the NOFIQ® BASE or the installation plan
- Network Channel
this can be obtained from the NOFIQ® BASE or the installation plan

15.3 Technical specifications of a NOFIQ® FE

| Internal power supply | |
|---|--|
| type power supply | lithium battery FeS ₂ |
| voltage (volt / amp.) | 3V / 3000mA |
| lifetime | max. 2 years |
| External mains power adapter (optional) | |
| power | 230 V, 50 Hz for Europe; 110 V 60Hz for the United States of America |
| voltage (volt / amp.) | 4V DC / 1200 mA |
| Output/input | |
| RS232 connector | for configuration and maintenance of the NOFIQ® FE |
| 1 x potential-free switch contact | 24 V / 1 A (for disabling a fan) |
| InterNOFIQBus | 0.2 A (group extinguishing) |
| Extinguishing agent | |
| FirePro® (weight) | 20 grams extinguishing agent (FP-20) 80 grams extinguishing agent (FP-80) |
| Communication | |
| frequency | 2.4 GHz (ISM band) |
| radio protocol | ZigBee™ |
| antenna | see specifications in Appendices |
| Other | |
| weight | 350 grams (NOFIQ® FE20) |
| dimensions (h x w x d) | FE 20 - 182 mm x 44 mm x 68 mm (excluding the antenna) height including antenna: 249 mm FE 80 - 204 mm x 68 mm x 98 mm (excluding the antenna) height including antenna: 271 mm |
| housing | polycarbonate / class V-2 / IP30 |
| acoustic signal | buzzer, 4 – 5 kHz @ 55 dB(A) |
| optical signal | 3 LEDs (yellow, green, red) see also paragraph 22.3 |

15.4 Installation and configuration instructions NOFIQ® FE



Attention!

Heed the safety precautions as stated in chapter 7.



Attention!

Additional instructions for installation of a standalone NOFIQ® FE you will find in paragraph 15.5.



Attention!

It is of the utmost importance to execute the instructions consecutively in the order given.

1. Retrieve the Network Security Key (NSK), the Short Network Address (SNA), the Network ID and the Network Channel from the NOFIQ® BASE or the installation plan. Hereto you connect a computer to the NOFIQ® BASE by means of a null modem cable and then you start the terminal application as described in paragraph 12.3. When you have started the application, you consecutively select:
 - menu 3. Services
 - option 1. Network Security Key
 - option 2. First available short network address

Write down all data.

2. Check if all necessary equipment and accessories for installation are present. See paragraph 15.2.
3. Remove the orange connector from the socket.
4. Connect the NOFIQ® FE's mains power adapter (optional) to the orange connector.



Attention!

**Using a mains power adapter is optional for an FE in a network modus.
The FE used as a standalone, you must use the mains power adapter.**

The right connection (from left to right) is as follows:

| Connector port | Wire colour | Connection |
|----------------|--|---|
| 1. | Black with white stripe and red sleeve | Power supply +4 Volt |
| 2. | Black (completely black) | Minus / earth |
| 3. | | InterNOFIQBus (with fire-resistant cable) see chapter 16. |
| 4. | | InterNOFIQBus (with fire-resistant cable) see chapter 16. |
| 5. | - | Common - Potential-free switch contact (max. 24V, max. 1A) |
| 6. | - | Normally closed - Potential-free switch contact (max. 24V, max. 1A) |

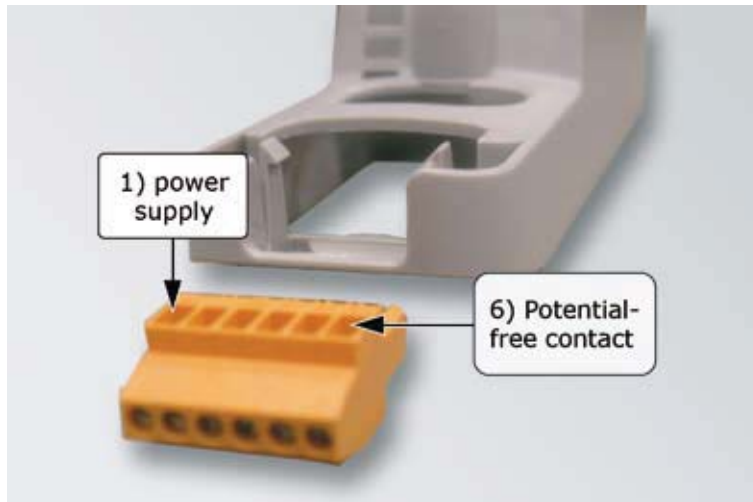

Figure 15 Connection NOFIQ® FE connector

5. Connect the potential-free switch contact. *(optional)*
Connect the potential-free switch contact with the device in question (e.g. a ventilator) via connector port 5 and 6.
By default the potential-free contact will be switched in case of Fire alarm (Pre-extinguishing).
If required you can change these settings. The potential-free contact can be switched in case of Alert, Pre-extinguishing or Error. This option can be set during configuration of the FE.
6. Place the connector back into the socket.
7. Take the NOFIQ® FE out of the socket and remove the lid of the battery holder (push with your finger in the direction of the arrow).



Figure 16 Placement batteries NOFIQ® FE

- Place the battery-pack and connect the battery connector (red on the outside, black on the inside). The connector has been made in such a way that there is only one possible way to connect it.

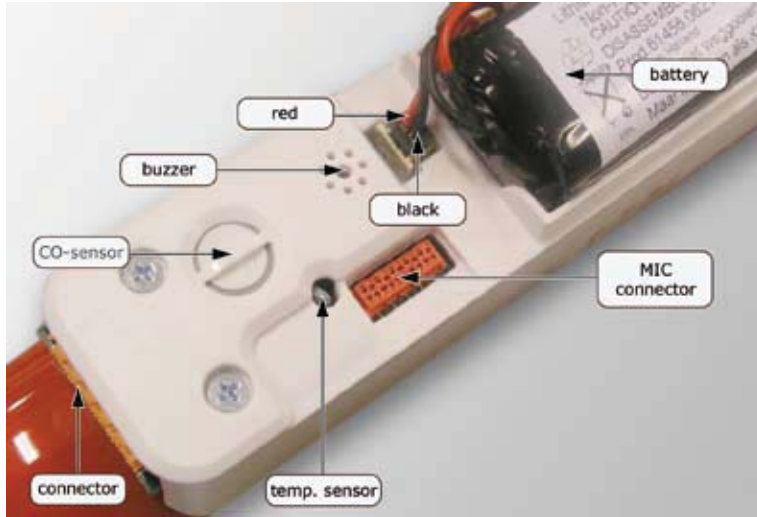

Figure 17 NOFIQ® FE Elements and battery connection



Attention!

Wrong battery placement could lead to ignition of the FirePro® aerosol extinguishing component.



Attention!

The battery-pack for the NOFIQ® system is supplied by your NOFIQ® provider. Only these battery-packs can be used for your NOFIQ® devices.

- Place the lid back onto the battery holder.
- Configure the NOFIQ® FE
Connect the NOFIQ® FE by means of a Maintenance Interface cable (MIC) to a computer (e.g. a laptop). Start the application 'NOFIQ® PC Control'. Program the Network Security Key (NSK), the Short Network Address (SNA), the Network ID and the Network Channel. In addition you can change in which situation the potential-free contact must be switched (by default this happens in case of Fire alarm (Pre-extinguishing). Configuration is described in chapter 14.
- Determine the place where the NOFIQ® FE must be fixed.



Attention!

The number of NOFIQ® FE's needed for an object also determines the projection, in other words the position and direction in which the NOFIQ® FE's have to be mounted.

When applying 1 NOFIQ® FE it will be placed in the middle of the object on the upper side, having the outflow openings pointing to the left and the right.

Ensure that both outflow openings have at least 15 cm of free outflow space in order to prevent damage to equipment. Since the antenna always has to point upwards, the antenna has to be placed separate from the FE and connected to the NOFIQ® FE by an antenna extension cord.

When applying 2 or more NOFIQ® FE's these are placed on the side of the object in question, having the outflow openings pointing upwards and downwards. Ensure that both outflow openings have at least 15 cm of free outflow space in order to prevent damage to equipment.

See also Figure 7 Projection NOFIQ® FE.

12. Fix the socket (at its destined location).
13. Attach the antenna to the NOFIQ® FE.



Attention!

If the FE is installed into a steel cabinet the antenna must be placed outside the cabinet. In that case the antenna must be linked to the NOFIQ® FE by means of a antenna extension cord (NOFIQ® accessory).

Prevent the cable from being pinched or knotted.

Turn the antenna extension cord with a Torque Wrench thoroughly tight onto the NOFIQ® FE!



Let op!

When applying 1 NOFIQ® FE it will be placed in the middle of the object on the upper side, having the outflow openings pointing to the left and the right. (see picture 7 projection NOFIQ FE)

Since the antenna always has to point upwards, you need to place the antenna separate from the NOFIQ® FE.

Make sure that the antenna points upwards.

Link the antenna to the NOFIQ® FE by means of a antenna extension cord.

Prevent the cable from being pinched or knotted.

14. Click the NOFIQ® FE into the socket.

15. Plug the adapter (*optional*) into the plug socket.
16. Press the NOFIQ® FE's button for two seconds. On release of the button the NOFIQ® FE leaves factory status.
17. Affix the warning sticker to the outside of the protected object on eye level.
18. Add the NOFIQ® FE to the NOFIQ® BASE.
Hereto you connect a computer with the NOFIQ® BASE by means of a null modem cable and then you start the terminal application as described in paragraph 12.3. When you have started the application, you consecutively select:
 - menu 3. Services
 - option 3. Network Status
 - option 1. FE
 - option 4. Add FE to network



Attention!

Downloading the Granted nodes database.

After installation of all components of the NOFIQ® system, you have to download the Granted nodes database from the NOFIQ® BASE and store it at a secure place. If something should go wrong with the NOFIQ® BASE, uploading the database will suffice to restore the data; adding all devices again would not be necessary.

You can download the Granted nodes database by means of the terminal application of the NOFIQ® BASE (see chapter 12.3).



Attention!

If an FE's primary power supply is changed from mains power to batteries (e. g. if the FE has been moved), this will lead to an error message. You can solve this error by accessing the BASE's terminal program (see chapter 12). First you remove the FE in question (Remove FE from network) and then you add it again (Add FE to network).



Attention!

If a NOFIQ® FE at one stage has been part of an InterNOFIQBus and you want this FE to function on its own (but within a network), it is imperative that after disconnecting the FE from the InterNOFIQBus the FE is restarted by pressing its button for 10 seconds. Thus you prevent an error message.

15.5 Additional special instructions for installation of a standalone NOFIQ® FE

Installation of a standalone NOFIQ® FE mainly happens as described in the previous paragraph. The following special instructions and exceptions apply when installing a standalone FE:

- An FE leaves factory in standalone configuration.
- As a precautionary measure we advise to connect the potential-free contact of the NOFIQ® FE to an external alarm or signalling device, for example a siren, a flashing light or a GSM module. In case of fire the appropriate person or organisation can then be notified in order to take repressive countermeasures.
- The potential-free contact will be switched by default in case of Fire alarm (Pre-extinguishing). We advise you to keep this setting..
- If required you can change these settings during configuration of the FE.
- Since the NOFIQ® FE is not part of a system or network, network data such as SNA, NSK, Network ID and Network Channel do not apply.
- The antenna (or antenna extension cord) do not have to be mounted on the FE (although these are supplied as a standard accessory).
- Mount the small cap in stead of the antenna.
- A standalone NOFIQ® FE is not added to a BASE.
- It is possible to link 2, 3 or 4 standalone FE into an InterNOFIQBus.
- The standalone NOFIQ® FE has to be connected with the main power adapter for a lifetime guarantee of main power.

16. Installation of a InterNOFIQBus

16.1 General

This chapter explains the installation of a InterNOFIQBus.

An InterNOFIQBus is a combination of 2, 3 or 4 mutually linked NOFIQ® FE's. Thanks to the InterNOFIQBus it is possible to protect larger objects (e.g. a larger switch cabinet). Installation of a InterNOFIQBus is optional and is not required for a proper operation of the NOFIQ® system.

Standalone NOFIQ® FE's can also be linked into an InterNOFIQBus (see also paragraph 15.5).

16.2 Requirements

For installation of the InterNOFIQBus you will need:

- 2, 3 or 4 NOFIQ® FE's
- Sockets for each NOFIQ® FE including orange connectors
- Antennas + antenna extension cords
- Warning sticker
"NOFIQ® fire protection system, in case of fire or alarm: do not panic, close cabinet doors and alert expert assistance"
- Mains power adapter for each NOFIQ® F (use is optional)



Attention!

The adapter for the NOFIQ® system is supplied by your NOFIQ® provider. Only these adapters can be used for your NOFIQ® devices.

- Battery-pack



Attention!

The battery-pack for the NOFIQ® system is supplied by your NOFIQ® provider. Only these battery-packs can be used for your NOFIQ® devices.

- Fire-resistant cables (2-wire) for connecting the FE's to be linked.
The maximum total length of the fire-resistant cables used is 6 metres.
- Network Security Key (NSK)
this can be obtained from the NOFIQ® BASE or the installation plan
- Short Network Address (SNA)
this can be obtained from the NOFIQ® BASE or the installation plan
- Network ID
this can be obtained from the NOFIQ® BASE or the installation plan
- Network Channel
this can be obtained from the NOFIQ® BASE or the installation plan

16.3 Installation and configuration instructions InterNOFIQBus



Attention!
Heed the safety precautions as stated in chapter 7.



Attention!
It is of the utmost importance to execute the instructions consecutively in the order given.

1. Retrieve the Network Security Key (NSK), the Short Network Address (SNA), the Network ID and the Network Channel from the NOFIQ® BASE or the installation plan. Hereto you connect a computer to the NOFIQ® BASE by means of a null modem cable and then you start the terminal application as described in paragraph 12.3. When you have started the application, you consecutively select:
 - menu 3. Services
 - option 1. Network Security Key
 - option 2. First available short network address

Write down all data.

2. Check if all necessary equipment and accessories for installation are present. See paragraph 16.2.
3. Remove the orange connector from the socket
4. Connect the NOFIQ® FE's mains power adapter (optional) to the orange connector.



Attention!
Using a mains power adapter is optional for an FE.

The right connection (from left to right) is as follows:

| Connector port | Wire colour | Connection |
|----------------|--|---|
| 1. | Black with white stripe and red sleeve | Power supply +4 Volt |
| 2. | Black (completely black) | Minus / earth |
| 3. | Red | InterNOFIQBus (with fire-resistant cable) see chapter 16. |
| 4. | White | InterNOFIQBus (with fire-resistant cable) see chapter 16. |
| 5. | - | Common - Potential-free switch contact (max. 24V, max. 1A) |
| 6. | - | Normally closed - Potential-free switch contact (max. 24V, max. 1A) |

5. Connect the fire-resistant cables to the FE's to be linked. Connect the cable attached to connector port 3 with connector port 3 of the second FE. Connect the cable attached to connector port 3 of the second FE with connector port 3 of the third FE, etc. In the same way you must connect the FE's of the InterNOFIQBus via connector port 4.
6. Connect the potential-free switch contact. (*optional*)
Connect the potential-free switch contact with the device in question (e.g. a ventilator) via connector port 5 and 6.
By default the potential-free contact will be switched in case of Fire alarm (Pre-extinguishing). If required you can change these settings. The potential-free contact can be switched in case of Alert, Pre-extinguishing or Error. This option can be set during configuration of the FE.
7. Place the connectors back into their sockets.
8. Take each NOFIQ® FE out of its socket and remove the lid of the battery holder (push with your finger in the direction of the arrow).
9. Place the battery-pack and connect the battery connector (red on the outside, black on the inside). The connector has been made in such a way that there is only one possible way to connect it.



Attention!
Wrong battery placement could lead to ignition of the FirePro® aerosol extinguishing component.



Attention!
The battery-pack for the NOFIQ® system is supplied by your NOFIQ® provider. Only these battery-packs can be used for your NOFIQ® devices.

10. Place the lids back onto the battery holders.

11. Configure the NOFIQ® FE's.
Connect each NOFIQ® FE by means of a Maintenance Interface cable (MIC) to a computer (e.g. a laptop). Start the application 'NOFIQ® PC Control'. Program the Network Security Key (NSK), the Short Network Address (SNA), the Network ID and the Network Channel. In addition you can change in which situation the potential-free contact must be switched (by default this happens in case of Fire alarm (Pre-extinguishing).
Configuration is described in chapter 14.

12. Determine the place where the InterNOFIQBus must be fixed.



Attention!

This distance between the outflow openings and the object to be protected must be at least 15 cm. There should not be any obstacles between the extinguishing component and the object.



Attention!

When applying 2 or more NOFIQ® FE's these are placed on the side of the object in question, having the outflow openings pointing upwards and downwards. Ensure that both outflow openings have at least 15 cm of free outflow space in order to prevent damage to equipment. See also Figure 7 Projection NOFIQ® FE.

19. Fix the sockets (at their destined locations).

20. Attach the antennas to the NOFIQ® FE's.



Attention!

If the FE is installed into a steel cabinet the antenna must be placed outside the cabinet. In that case the antenna must be linked to the NOFIQ® FE by means of a antenna extension cord (NOFIQ® accessory).

Prevent the cable from being pinched or knotted.

Turn the antenna extension cord with a Torque Wrench thoroughly tight onto the NOFIQ® FE!

13. Click the NOFIQ® FE's into their sockets.

14. Plug the adapters (*optional*) into the plug sockets.

15. Attach the cabling to the wall by using clamps according to the operative regulations.

16. To test the InterNOFIQBus press the button of one of the FE's for 1 second. On release of the button, the yellow, red and green LED of the other FE's will blink briefly. Next the green LED will blink once per 5 minutes. The InterNOFIQBus is now ready for operation.

17. Affix the warning sticker to the outside of the protected object on eye level.
18. Add the NOFIQ® FE's to the NOFIQ® BASE.
Hereto you connect a computer to the NOFIQ® BASE by means of a null modem cable and then you start the terminal application as described in paragraph 12.3. When you have started the application, you consecutively select:
 - menu 3. Services
 - option 3. Network Status
 - option 1. FE
 - option 4. Add FE to network



Attention!

Downloading the Granted nodes database.

After installation of all components of the NOFIQ® system, you have to download the Granted nodes database from the NOFIQ® BASE and store it at a secure place. If something should go wrong with the NOFIQ® BASE, uploading the database will suffice to restore the data; adding all devices again would not be necessary.

You can download the Granted nodes database by means of the terminal application of the NOFIQ® BASE (see chapter 12.3).



Attention!

If an FE's primary power supply is changed from mains power to batteries (e. g. if the FE has been moved), this will lead to an error message. You can solve this error by accessing the BASE's terminal program (see chapter 12). First you remove the FE in question (Remove FE from network) and then you add it again (Add FE to network).



Attention!

If a NOFIQ® FE at one stage has been part of an InterNOFIQBus and you want this FE to function on its own (but within a network), it is imperative that after disconnecting the FE from the InterNOFIQBus the FE is restarted by pressing its button for 10 seconds. Thus you prevent an error message.

17. Putting the NOFIQ® system into operation

17.1 General

This chapter explains which actions have to be taken to put the NOFIQ® system into operation.

17.2 Putting the system into operation

Putting the NOFIQ® system into operation must be done by qualified personnel under responsibility of the NOFIQ® service provider. Putting the NOFIQ® system into operation contains all activities necessary to make the installation functioning and operational according to the Program of Requirements and the installation plan.

When the system is put into operation checks must be made to ensure that the NOFIQ® system actually functions as it should function. The checks executed for this scope, take place in view of the Program of Requirements and the installation plan.

18. Acceptance of the NOFIQ® system

18.1 General

This chapter explains which actions have to be taken for acceptance of the NOFIQ® system.

18.2 Activities for acceptance

The NOFIQ® service provider draws up an Acceptance Report in which the service provider certifies, that the NOFIQ® system is operational and functions according to Program of Requirements and the installation plan.

By means of documentation it must be proved that all components applied in the NOFIQ® system meet the demanded requirements of quality and compatibility.

During the acceptance procedure the owner of the NOFIQ® system must be handed an Acceptance Report as well as a log book.

An example of a Acceptance Report is provided in Appendix 36.3.

An example of a log book is provided in Appendix 36.4.

The NOFIQ® service provider should instruct the user in the NOFIQ® system's functioning and in the periodic and preventive maintenance required. The name of the custodian for the NOFIQ® system in question should be recorded in the log book and in the NOFIQ® service provider's registry.

19. The NOFIQ® BASE in daily use

19.1 General

This chapter describes how to handle the NOFIQ® BASE in daily use. It gives you an overview of the NOFIQ® BASE control panel and how to use it. Furthermore it offers an overview of the structure and options of the NOFIQ® BASE's user menu. Finally this chapter throws a light upon the alarm and error messages that are shown in the control panel's display.

19.2 Control panel

The NOFIQ® BASE control panel looks as follows:

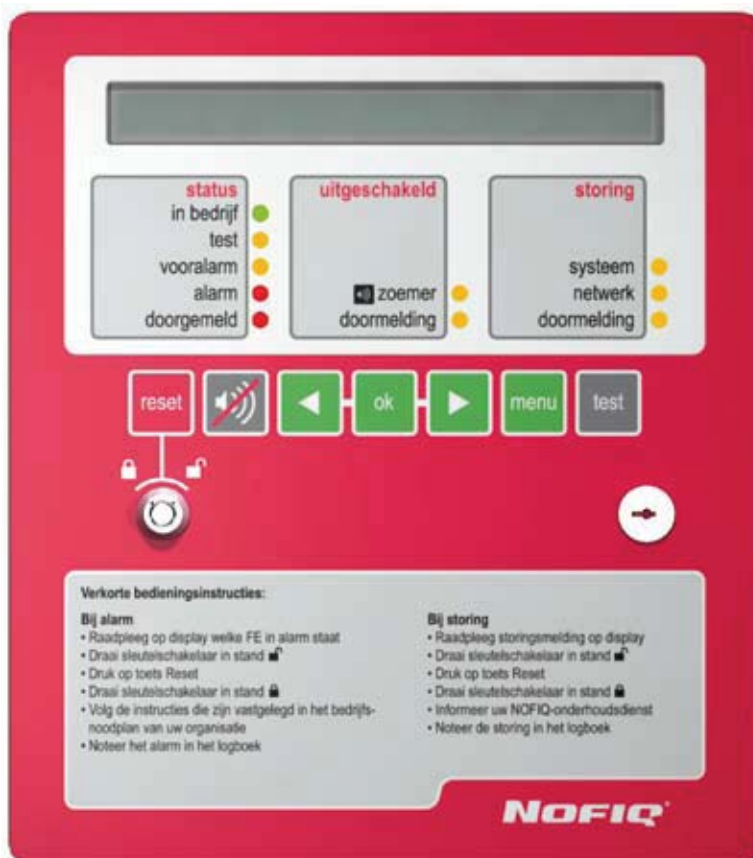

Figure 18 Control panel NOFIQ® BASE

On the control panel of the NOFIQ® BASE you will discern the following elements:

- Alphanumeric display
The display will be described in paragraph 19.3
- Indication lights
The indication lights (LEDs) will be described in paragraph 19.4
- Buttons

The buttons on the control panel will be described in paragraph 19.5

- Locks
The locks on the control panel will be described in paragraph 19.6

19.3 Alphanumeric display

On the upper side of the control panel you will identify a small screen. This is a two-line display for 40 characters on each line. The display is provided with backlight.

In this display the system's status is shown. If a NOFIQ® FE initiates an alarm or the system reports an error message, such a message will appear in the display of the control panel.

The top line of the display show the status of the system.

The bottom line of the display shows the menu option or task which can be selected. If the system's status is OPERATIONAL, the bottom line shows the current time and date.



Attention!

If you are navigating in the menu, the top line shows the position in the menu structure.

The menu structure of the NOFIQ® BASE will be described in detail in paragraph 19.10

The menu options and their application will be described in detail in paragraph 19.11.

Alarm messages that may appear in the display, are described in paragraph 19.8.

Error messages shown in the display and their meaning are described in paragraph 19.9.

19.4 Indication LEDs

The control panel of the NOFIQ® BASE is provided with 10 indication LEDs (lights). These lights are divided into 3 columns, namely Status, Disabled and Malfunction.

You will identify the following LEDs:

| Column | Text | LED colour | Meaning |
|----------|-------------|------------|--|
| Status | Operational | Green | This LED burns when the system is operational. |
| Status | Test | Yellow | This LED burns when you are testing the system (with the button Test , or through the maintenance menu) |
| Status | Alert | Yellow | This LEDs blinks when a NOFIQ® FE is in Alert. |
| Status | Alarm | Red | This LED burns when a NOFIQ® FE has reported an alarm (Fire Alarm or Extinguishing alarm). |
| Status | Notified | Red | This LED burns when an alert, alarm or error has been notified to the appropriate service. |
| Disabled | Buzzer | Yellow | This LED burns when the buzzer has been disabled. The buzzer can be disabled and enabled through the menu MAINTENANCE, option <Function Control>. For this an authorisation key is required. |

| Column | Text | LED colour | Meaning |
|-------------|--------------|------------|--|
| Disabled | Notification | Yellow | This LED burns when notification has been disabled. Notification can be disabled and enabled through the menu MAINTENANCE, option <Function Control>. For this an authorisation key is required. |
| Malfunction | System | Yellow | This LED blinks if an error has been detected within the system. It concerns errors and malfunctions in the equipment itself and in the power supply. |
| Malfunction | Network | Yellow | This LED blinks if an error has been detected within the network. It concerns errors in the communication between the devices within the network. |
| Malfunction | Notification | Yellow | This LED burns when there is an error or fault in the notification (e.g. in the relays or the modem). |

Table 6 Indication LEDs NOFIQ® BASE

Further information on the behaviour of the NOFIQ® BASE's LEDs and buzzer in case of an alarm or an error can be found in paragraph 19.7.

Alarm messages that are shown in the display, are described paragraph 19.8.





Error messages that are shown in the display, are described paragraph 19.9

19.5 Buttons (keypad)

Below the indication LEDs there are 7 buttons.

These buttons are used to execute action and navigate through the menu.

From left to right you will identify the following buttons:

| Button | Use |
|------------|--|
| Reset |  <p>With this button you can reset the alarm management station. In case of alarm the FE's in alarm will be disabled (identifiable by the #-sign in front of the FE's data in the display); the BASE will return to its operational status and LED behind Status Notification will go out.</p>  <p>You need an authorisation key (mechanical key) to use the button Reset. Use the button Reset only when the cause of the alarm or error is known and recorded into the log book.</p> |
| Buzzer Off |  <p>With this button you can switch off the buzzer. This is a temporary switching-off in case an Extinguishing has taken place. If you want to disable the buzzer completely, you need to do that by means of the menu MAINTENANCE - option <Function Control> (authorisation key required).</p> |
| < |  <p>With this button you can navigate to the left. Within the menu this button will take you an option to the left; within a message this button will take you one line back. This button is only functional when leftmost of the second line an arrow to the left (■) is shown.</p> |



| Button | | Use |
|--------|---|---|
| OK |  | With this button you can select a menu option or confirm a choice or action. |
| > |  | With this button you can navigate to the right. Within the menu this button will take you an option to the right; within a message this button will take you one line forward. This button is only functional when leftmost of the second line an arrow to the right (<) is shown. |
| Menu |  | <p>With the button Menu you can start the menu. Then you can navigate in the menu with the < and > buttons and then select menu options with the button OK.</p> <p>When working in the menu the button Menu will take you one level higher in the menu structure.</p> <p>When working in the menu MAINTENANCE you must select the option <EXIT> to leave this menu.</p> <p>The top line of the display shows the position in the menu structure.</p> <p>An example: The top line of the display shows Maintenance:FE List: Details. If you press the button Menu, you will go to Maintenance: FE List. From there on you can navigate by using the buttons <, OK and >.</p> |
| Test |  | <p>With the button Test you can execute a test. This test checks if all indicators (display, lights and buzzer) function.</p> <p>When you press this button, the LED Status – Test will burn. Next the display will show the text Test, the buzzer will sound and the LEDs will blink for a few seconds. This test stops automatically.</p> |

Table 7 Buttons control panel NOFIQ® BASE

19.6 Locks

The control panel of the NOFIQ® BASE is provided with two locks:

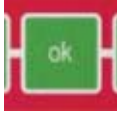
Lock for authorisation key
(mechanical key)

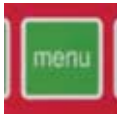
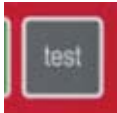

In the left lock (below the button **Reset**) fits an authorisation key. The authorisation key is required to reset the system (button **Reset**) and to perform certain options within the menu MAINTENANCE.

For using this key authorisation level 2 is required.

By turning the key to the right in the direction of the opened padlock sign, you will unlock the authorisation. By turning the key to the left in the direction of the locked padlock sign, you will lock the authorisation.

Lock for opening the station's
cabinet



In the right lock (below right of the button **Test**) fits a key to open the station's cabinet. For using this key authorisation level 3 is required.

19.7 Alarm or error messages and accompanying indicators

The table below lists the different alarm and error messages which can be identified on the NOFIQ® BASE and how to recognize these by the accompanying LED and buzzer behaviour.

| Status | LED behaviour | Buzzer behaviour |
|----------------------|---|---|
| MALFUNCTION | One or more yellow Malfunction LEDs blink twice briefly every 2 seconds | Beeps at 5 kHz, exactly corresponding with the LED pattern. |
| ALERT | Yellow led (Status - Alert) blinks twice every second. | Beeps at 5 kHz, exactly corresponding with the LED pattern. |
| FIRE ALARM | Yellow led blink thrice every seconds. | Beeps at 5 kHz, exactly corresponding with the LED pattern. |
| EXTINGUISHING | Red LED burns continuously | Continuous signal sweep between 4 and 5 KHz. |
| EXTINGUISHING-SILENT | Red LED burns continuously | Silent. |

Table 8 Indicators alarm and error messages

19.8 Overview alarm messages

An alarm message will be shown in the alphanumeric display.

The top line of the display shows the alarm message plus time and date.

The bottom line of the display shows additional information about the message, for example which device it concerns.

If the information comprises several lines or if there are several alarm messages (identifiable by the < > arrows in the left corner) you can page through these lines by using the >-button and the <-button.

The next example shows how the system displays an alarm.

```
ALERT 11:48:12 02/10/2006 #ALARMS:1
<FE:1-2>
```

The NOFIQ® system applies three different types of alarm messages:

- Alert
- Fire alarm
- Extinguishing

Alert

As soon as a NOFIQ® FE's sensors register a steep increase in temperature or CO concentration (without exceeding a critical point), the NOFIQ® FE sends an Alert to the alarm management station (the NOFIQ® BASE). With this alert the FE warns that probably something is not right at its location and that a fire may be developing. The Alert can only be shut down on the spot. This has been designed especially in this way to oblige a custodian to check whether a dangerous situation has arisen at the location in question. Thus a critical situation can be diagnosed quickly.

Fire alarm

If the temperature and the CO concentration have exceeded a critical level, the NOFIQ® FE will initiate a Fire alarm. This alarm warns that a fire has been detected and that the NOFIQ® FE will start an extinguishing sequence within 10 seconds. Within those 10 seconds the FE in question can be disabled by pressing the FE's button (Suspend). If someone would be doing maintenance work (welding, cleaning) at the location in question and forgot to Suspend the FE, the maintenance activities could be causing an alarm, although there is no question of fire. That is why there is a 10 second-countdown between the Fire alarm and the actual extinguishing routine.

Extinguishing

When the 10 second countdown expires the aerosol fire-extinguishing component will be activated and an extinguishing routine is started. The FE will now report an Extinguishing alarm.

How the system deals with an alarm and what you need to do yourself, is explained in chapter 23.

19.9 Overview error messages

An error message will be shown in the alphanumeric display.

The top line of the display shows the message 'MALFUNCTION'.

The bottom line of the display shows additional information about the message, for example which device it concerns and what kind of error is reported.

If the information comprises several lines or if there are several alarm messages (identifiable by the < > arrows in the left corner) you can page through these lines by using the >-button and the <-button.

The next example shows how the system displays an error message.

```
MALFUNCTION #ERROR:2
-> <FE:101:Offline>
```

The list below shows the different error messages that the system can initiate and how these are shown on the control panel.

| Error message | Meaning and description | Applies to: | | | Indication LED on the control panel |
|-------------------------|--|-------------|-----|----|-------------------------------------|
| | | BASE | HUB | FE | |
| Offline | A heartbeat of an HUB or FE is missing. | | X | X | Network |
| Suspend-state activated | An FE has been temporarily disabled (Suspended). | | | X | Network |
| Disabled | The FE has executed an extinguishing and has been disabled. | | | X | Network |
| Parent missing | At least one HUB or FE misses a 'parent' that guarantees a backup route. | | X | X | Network |
| BASE-HUB | An error in the BASE-HUB. | | | | Network |
| Cause unknown | Internal (unknown) error. | X | X | X | System |

| Error message | Meaning and description | Applies to: | | | Indication LED on the control panel |
|---------------------------------|--|-------------|----------------|----|-------------------------------------|
| | | BASE | HUB | FE | |
| Temperature sensor | An error in the temperature sensor. | | | X | System |
| CO sensor | An error in the CO sensor. | | | X | System |
| LCD | An error in the alphanumeric display. | X | | | System |
| LED | An error in the LEDs. | X | | | System |
| Keypad | An error in the keypad buttons. | X | | | System |
| Modem | An error in the modem. | X | | | System |
| Buzzer | An error in the buzzer. | X | | | System |
| Battery (UPS) | An error in the battery. | X | | | System |
| Igniter extinguishing component | An error in the igniter of the FirePro® extinguishing component. | | | X | System |
| Relay | A switch relay is faulty. | X | | X | System |
| InterNOFIQBus | An error in the communication within an InterNOFIQBus. | | | X | System |
| Battery failure | The level of the battery is low or missing | X | | | System |
| Battery level low | The level of the battery-pack is low | | X ¹ | X | System |
| Battery level critical | The level of the battery-pack is critical. | | X ¹ | X | System |
| Mains power loss | Mains power is down. | X | X | | System |
| Notification | An error in the notification. | X | | | Notification |
| Network | Network communication is not available. | X | | | Network |

¹ Detection of these errors is only possible if mains power is down (Mains power loss).

Table 9 Overview error messages

The indicators (LEDs and buzzer, if any) of the devices in question also show the device's status. In the next chapters for each NOFIQ® device (FE, HUB or BASE-HUB) you will find a status overview and the accompanying indicator behaviour.



Attention!

If due to an error in network communication contact with a NOFIQ® FE has (temporarily) been interrupted, nothing is changed in the functionality of the FE: it keeps on detecting and it alarms and extinguishes when circumstances require such actions.

How the system deals with an error and what you need to do yourself, is explained in chapter 23.

19.10 Menu structure

The NOFIQ® BASE is provided with a number of menu's to query or modify data and settings of the system and its individual components.



Attention!

Changing settings is only permitted to authorised users. For this an authorisation key is required. Menu options that require authorisation are identifiable by the @-sign.



Attention!

The system's status determines which menu's are available. The menu options in the menu MALFUNCTION, ALERT, FIRE ALARM and EXTINGUISHING are only available if the system is in the status in question.

When the system is in OPERATIONAL status, only the menu's MAINTENANCE and INFORMATION will be available. As soon as the system's status changes, the menu will adapt automatically.

The system is in one of the following statuses:

- OPERATIONAL
- MAINTENANCE
- ALARM (Alert, Fire alarm or Extinguishing)
- MALFUNCTION



Attention!

If you are working in the NOFIQ® BASE's menu MAINTENANCE and an FE reports an alarm, the alarm will not be shown in the display (although it is registered in the background).

As soon as you exit the menu MAINTENANCE, the system will go into alarm status.

How to use the control panel's buttons to navigate through the menu's and select menu options is explained in paragraph 19.5

Next a list is shown of the various menu's and the menu options in those menu's. In paragraph 19.11 these menu options are explained in detail.



Attention!

A @ before a menu option indicates that this option (plus sub options if any) can only be executed by an authorised user in possession of an authorisation key.

OPERATIONAL

@ <MAINTENANCE>
<INFORMATION>

MAINTENANCE

<FE List>

<FE:SNA:LOCATION>

<DETAILS>

@ <EDIT>

<ENABLE>

<DISABLE >

<REMOVE >

<HUB List>

<HUB:SNA:LOCATION>

<DETAILS>

@ <EDIT>

<ENABLE>

<DISABLE >

<REMOVE >

<MISSING DEVICES >

<FUNCTION CONTROL >

@

<BUZZER >

<ENABLE >

<DISABLE >

<NOTIFICATION >

<ENABLE>

<DIRECT>

<DELAYED>

<DISABLE>

<SETTINGS>

<SET DATE>

<SET TIME>

<SET LANGUAGE>

@ <SET MODEM>

<DTMF>
<DISABLE >

<DIAGNOSTICS>
 <SELF TEST>
 <SOFTWARE VERSION>
 <SERIAL NUMBER
 BASE>

<EXIT >

MALFUNCTION

<DETAILS>
<MAINTENANCE>

ALERT

<DETAILS>

FIRE ALARM

<DETAILS>

EXTINGUISHING

<DETAILS>
<SILENT>

19.11 Menu options and their use

This paragraph explains the menu options in the various menu's.

How to use the control panel's buttons to navigate through the menu's and select menu options is explained in paragraph 19.5.



Attention!

A @ before a menu option indicates that this option (plus sub options if any) can only be executed by an authorised user in possession of an authorisation key.

OPERATIONAL

When the system's status is OPERATIONAL, pressing the button **Menu** will offer the following options:

- @ <MAINTENANCE> Press the button **OK**. Next press the button **Menu** to enter the menu MAINTENANCE. This menu will be explained in detail below.
- <INFORMATION> This option offers general information about the NOFIQ® system.

MAINTENANCE

The MAINTENANCE menu offers the following options:

- <FE LIST> This options shows a list of all FE's in the NOFIQ® system. Next you can select an FE.
 - <DETAILS> View details of the FE selected.
 - @ <EDIT> Modify data of the FE selected. For this authorisation is required.
 - <ENABLE> enable the FE
 - <DISABLE > disable the FE
A disabled FE is identifiable in the display by #-sign in front of the FE.
 - <REMOVE > remove the FE

- <HUB LIST> This options shows a list of all HUBs in the NOFIQ® system. Next you can select an HUB.
 - <DETAILS> View details of the HUB selected.
 - @ <EDIT> Modify data of the HUB selected. For this authorisation is required.
 - <ENABLE> enable the HUB
 - <DISABLE> disable the HUB
 - <REMOVE> remove the HUB

- <MISSING DEVICES> This options shows a list of all devices that are no longer detected by the system.

- @ <FUNCTION CONTROL> With this option the buzzer and notification can be enabled or disabled. For this authorisation is required.
 - <BUZZER>
 - <ENABLE> enable the buzzer
 - <DISABLE > disable the buzzer
 - <NOTIFICATION>

- <ENABLE> enable notification, next choose between:
 - <DIRECT> direct notification
 - <DELAYED> notification with a 1 minute delay (notification via the potential-free switch contacts is always without delay)
 - <DISABLE > disable notification

- <SETTINGS > With this option time, date, language and modem properties can be set.
 - <SET DATE> Set the correct date.
 - <SET TIME> Set the correct time.
 - <SET LANGUAGE> Set the desired language.
 - @ <SET MODEM> Set the desired modem properties. Choose between:
 - <DTMF> enable modem using DTMF-tones
 - <DISABLE> disable modem

- <DIAGNOSTICS> With this option you can query system data.
 - <SELF TEST> Use this to execute a system test.
 - <SOFTWARE VER-SION> The version number of the software.
 - <SERIAL NUMBER BASE> The serial number of the NOFIQ® BASE.

- <EXIT> This option takes you back to the main menu.



When working in the menu MAINTENANCE you **must** select the option <EXIT> to leave this menu.

You **cannot** use the button **Menu** to take you from the menu MAINTENANCE to a higher menu level.

MALFUNCTION

If the system reports an error, the menu MALFUNCTION will appear. The bottom line of the display shows which device it concerns and what kind of error is reported. Pressing the button **Menu** will offer the following options:

- <DETAILS> This options offers details about the error.
- <MAINTENANCE > This options takes you to the menu MAINTENANCE.

ALERT

If an FE reports an Alert, the menu ALERT will appear. The bottom line of the display shows the FE('s) in Alert. Pressing the button **Menu** will offer the following options:

- <DETAILS> This options offers details about the Alert.



Attention!

When the system's status is Alert, Fire alarm or Extinguishing, the menu MAINTENANCE cannot be entered. First of all the system should be reset using the button Reset on the control panel.

FIRE ALARM

If an FE reports a Fire alarm, the menu FIRE ALARM will appear. The bottom line of the display shows the FE('s) in Fire alarm. Pressing the button **Menu** will offer the following options:

- <DETAILS> This options offers details about the Fire alarm.



Attention!

When the system's status is Alert, Fire alarm or Extinguishing, the menu MAINTENANCE cannot be entered. First of all the system should be reset using the button Reset on the control panel.

EXTINGUISHING

If an FE reports an Extinguishing alarm, the menu EXTINGUISHING will appear. The bottom line of the display shows the FE('s) in Extinguishing. Pressing the button **Menu** will offer the following options:

- <DETAILS> This options offers details about the Extinguishing alarm
- <SILENT> This option shows the FE's that have executed their extinguishing routine.



Attention!

When the system's status is Alert, Fire alarm or Extinguishing, the menu MAINTENANCE cannot be entered. First of all the system should be reset using the button Reset on the control panel.

20. The NOFIQ® BASE-HUB in daily use

20.1 General

This chapter describes how to handle the NOFIQ® BASE-HUB in daily use. It offers an overview of the possible statuses for the NOFIQ® BASE-HUB and how its status is identified by the indicators (LEDs). The NOFIQ® BASE-HUB is not equipped with a buzzer.

Furthermore you can learn how to use the button of the NOFIQ® BASE-HUB.

20.2 Statuses of the NOFIQ® BASE-HUB and accompanying indicators

A NOFIQ® BASE-HUB is in one of the following statuses:

| Status | Meaning |
|---------|---|
| SAFE | The NOFIQ® BASE-HUB functions properly. |
| ACTIVE | The NOFIQ® BASE-HUB is operational but has not yet received any network messages. |
| FACTORY | This status is used for testing during manufacturing and during installation. |

Table 10 Statuses NOFIQ® BASE-HUB and their meaning

The LEDs of the NOFIQ® BASE-HUB show the device's status. The table below shows the various statuses of the BASE-HUB and the accompanying LED behaviour.



Attention!
The NOFIQ® BASE-HUB is not equipped with a buzzer.

| Status | LED behaviour | Buzzer behaviour |
|---------|--|------------------|
| SAFE | Green LED blinks on every message received. | n/a |
| ACTIVE | Red LED blinks every second. | n/a |
| FACTORY | Yellow LED blinks alternately 1 second on, 1 second off. | n/a |

Table 11 Statuses NOFIQ® BASE-HUB and accompanying LED behaviour

20.3 Use of the button of the NOFIQ® BASE-HUB

You can use the button of the NOFIQ® BASE-HUB in the following situations:

- **To leave factory status of the NOFIQ® BASE-HUB.**
A NOFIQ® BASE-HUB that has just been installed is in factory status (FACTORY). To leave this status when the NOFIQ® BASE-HUB is in working order, press the button for 2 seconds. On release of the button, the NOFIQ® BASE-HUB will have the status SAFE or ACTIVE.
- **To restart the NOFIQ® BASE-HUB**
To restart the NOFIQ® BASE-HUB press the button for 10 seconds. On release of the button, the NOFIQ® BASE-HUB will have the status SAFE or ACTIVE.

21. The NOFIQ® HUB in daily use

21.1 General

This chapter explains how to handle a NOFIQ® HUB in daily use. It offers an overview of the possible statuses of the NOFIQ® HUB and how its status is identified by the indicators (LEDs and buzzer).

Furthermore you can learn how to use the button of the NOFIQ® HUB.

21.2 Statuses of a NOFIQ® HUB and accompanying indicators

A NOFIQ® HUB is in one of the following statuses:

| Status | Meaning |
|-------------|--|
| SAFE | The NOFIQ® HUB functions properly and has 2 parents within radio reach. |
| FACTORY | This status is used for testing during manufacturing and during installation. |
| MALFUNCTION | An error has been detected in the device or in the communication. If more errors will be detected the NOFIQ® HUB will send additional error messages to the NOFIQ® BASE. |
| OFFLINE | The NOFIQ® HUB has not found any parents, for example since these are out of its radio reach. |

Table 12 Statuses NOFIQ® HUB and their meaning

The indicators (LEDs and buzzer) of the NOFIQ® HUB show the device's status. The table below shows the various statuses of a HUB and the accompanying LED and buzzer behaviour.

| Status | LED behaviour | Buzzer behaviour |
|-------------|--|--|
| SAFE | Green LED blinks once every 5 seconds | Silent |
| FACTORY | Yellow LED blinks alternately 1 second on, 1 second off. | Silent |
| MALFUNCTION | Yellow LED blinks every 2 seconds 2 x briefly | Silent |
| OFFLINE | Red LED blinks every 2 seconds 2 x briefly | Buzzer beeps every time the LED blinks (4 KHz) |

Table 13 Statuses NOFIQ® HUB and accompanying indicator behaviour

21.3 Use of the button of a NOFIQ® HUB

You can use the button of the NOFIQ® HUB in the following situations:

- To leave factory status of the NOFIQ® HUB.**
 A NOFIQ® HUB that has just been installed is in factory status (FACTORY). To leave this status when the NOFIQ® HUB is in working order, press the button for 2 seconds. On release of the button, the NOFIQ® HUB will have the status SAFE.
- To restart the NOFIQ® HUB**
 To restart the NOFIQ® HUB press the button for 10 seconds. On release of the button, the NOFIQ® HUB will have the status SAFE.
- To send a heartbeat (status report)**
 To send a heartbeat (as a kind of test status report) briefly press the button.

22. The NOFIQ® FE in daily use

22.1 General

This chapter explains how to handle a NOFIQ® FE in daily use. It offers an overview of the possible statuses of the NOFIQ® FE and how its status is identified by the indicators (LEDs and buzzer).

Furthermore you can learn how to use the button of the NOFIQ® FE.

22.2 Operation of the NOFIQ® FE's sensors

Each NOFIQ® FE is provided with a temperature sensor and a carbon monoxide (CO) sensor. With these sensors the NOFIQ® FE monitors its surroundings. If the temperature or the CO concentration increase steeply or exceeds a certain limit, the FE will send an alarm to the NOFIQ® BASE.

The NOFIQ® system applies three different types of alarm messages:

- Alert
- Fire alarm
- Extinguishing

Alert

As soon as a NOFIQ® FE's sensors register a steep increase in temperature or CO concentration (without exceeding a critical point), the NOFIQ® FE sends an Alert to the alarm management station (the NOFIQ® BASE). With this alert the FE warns that probably something is not right at its location and that a fire may be developing. The Alert can only be shut down on the spot. This has been designed especially in this way to oblige a custodian to check whether a dangerous situation has arisen at the location in question. Thus a critical situation can be diagnosed quickly.

Fire alarm

If the temperature and the CO concentration have exceeded a critical level, the NOFIQ® FE will initiate a Fire alarm. This alarm warns that a fire has been detected and that the NOFIQ® FE will start an extinguishing sequence within 10 seconds. Within those 10 seconds the FE in question can be disabled by pressing the FE's button (Suspend). If someone would be doing maintenance work (welding, cleaning) at the location in question and forgot to Suspend the FE, the maintenance activities could be causing an alarm, although there is no question of fire. That is why there is a 10 second-countdown between the Fire alarm and the actual extinguishing routine.

Extinguishing

When the 10 second countdown expires the aerosol fire-extinguishing component will be activated and an extinguishing routine is started. The FE will now report an Extinguishing alarm.

If an FE reports an alarm automatically a notification will be forwarded to the fire brigade or another fire-fighting service.



Attention!

The NOFIQ® FE is also available in a standalone version. In that case there is no question of a NOFIQ® system/network (with BASE, BASE-HUB and HUBS). Alarm and error messages therefore will not be notified to the BASE. (see chapter 15.5, page 80)

22.3 Statuses of a NOFIQ® FE and accompanying indicators

A NOFIQ® FE is in one of the following statuses:

| Status | Meaning |
|---------------|--|
| SAFE | The NOFIQ® FE functions properly; no fire or error has been detected. |
| SUSPEND | <p>If an FE's location or the itself needs maintenance, you can temporarily disable the device by pressing the button for 2 seconds.</p>  <p>If an FE reports a Fire Alarm you can temporarily disable the FE in question within 10 seconds by briefly pressing its button.</p> |
| MALFUNCTION | An error has been detected in the FE. If possible the FE will still monitor its surroundings. If an alarm situation should occur the alarm status will get priority to the error status. |
| ALERT | The sensors have detected a steep increase but the situation is not yet critical and demands no extinguishing (yet). |
| FIRE ALARM | A fire has been detected; within 10 seconds the FE will start an extinguishing routine. Within those 10 seconds the device can be deactivated by briefly pressing the button (SUSPEND). |
| EXTINGUISHING | The aerosol extinguishing component has been activated to extinguish the fire. If an FE is in this status, maintenance is required, since the extinguishing agent has been spent and the FE could be damaged by the fire. |
| FACTORY | This status is used for testing during manufacturing and during installation. |

Table 14 Statuses NOFIQ® FE and their meaning

The indicators (LEDs and buzzer) of the NOFIQ® FE show the device's status. The table below shows the various statuses of a FE and the accompanying LED and buzzer behaviour.

| Status | LED behaviour | Buzzer behaviour |
|---------------|--|---|
| SAFE | Green LED blinks once every 5 seconds | Silent |
| SUSPEND | Yellow LED blinks every second 1 x briefly | Silent |
| MALFUNCTION | Yellow LED blinks every 2 seconds 2 x briefly | Beeps at 5 kHz, exactly corresponding with the LED pattern. |
| ALERT | Yellow LED blinks every second 2 x briefly | Beeps at 5 kHz, exactly corresponding with the LED pattern. |
| FIRE ALARM | Red LED blinks for 8 seconds in rapid succession, then continuously for 2 seconds. | Continuous signal sweep between 4 and 5 KHz. |
| EXTINGUISHING | Red LED blinks every 2 seconds 2 x briefly | Beeps at 4 kHz, exactly corresponding with the LED pattern. |

| | | |
|---------|--|--------|
| FACTORY | Yellow LED blinks alternately 1 second on, 1 second off. | Silent |
|---------|--|--------|

Table 15 Statuses NOFIQ® FE and accompanying indicator behaviour

22.4 Use of the button of a NOFIQ® FE

You can use the button of the NOFIQ® FE in the following situations:

- **To leave factory status of the NOFIQ® FE.**
A NOFIQ® FE that has just been installed is in factory status (FACTORY). To leave this status when the NOFIQ® FE is in working order, press the button for 2 seconds. On release of the button, the NOFIQ® FE will have the status SAFE.
- **To break off a Fire Alarm**
If a NOFIQ® FE reports a Fire Alarm, you have got ten seconds to break off this alarm and to prevent the FE from extinguishing. It could happen that for example welding activities inside the switch cabinet cause an increase in temperature which prompt the FE to report a Fire Alarm, although there is no question of fire.
By pressing the button briefly within those 10 seconds the Fire Alarm will be interrupted and the FE in question will be temporarily disabled (SUSPEND status).
- **To break off an Alert**
With an Alert the FE warns that probably something is not right at its location and that a fire may be developing. By briefly pressing the button the Alert will be stopped. The Alert can only be shut down on the spot. This has been designed especially in this way to oblige a custodian to check whether a dangerous situation has arisen at the location in question. An Alert can never be interrupted or reset from the NOFIQ® BASE.



Attention!

If the conditions causing the Alert are still present, the FE will go back into Alert after pressing the FE's button. Only if the conditions are OK (for example after a drop in temperature), pressing the button will get the FE back into SAFE status.

- **To disable a NOFIQ® FE temporarily**
If an FE's location or the FE itself needs maintenance, you can temporarily disable the FE by pressing the button for 2 seconds. The FE in question will then be in SUSPEND status. To reactivate the FE press the button for 2 seconds.
- **To restart the NOFIQ® FE**
To restart the NOFIQ® FE press the button for 10 seconds. On release of the button, the NOFIQ® FE will have the status SAFE.

23. Alarm or error, what to do?

23.1 General

This chapter explains what you need to do yourself if the NOFIQ® system reports an alarm or error.

Paragraph 23.2 explains how to recognize an alarm or error message on the NOFIQ® BASE.

Paragraph 23.3 explains how the NOFIQ® system handles an alarm message.

Paragraph 23.4 explains what you need to do yourself in case of an alarm.

Paragraph 23.5 explains how the NOFIQ® system handles an error message.

Paragraph 23.6 explains what you need to do yourself in case of an error message.

23.2 How do you recognize an alarm or error?

As soon as the NOFIQ® system detects an error within the network or receives an alarm from an FE, a message is sent to the NOFIQ® BASE. The alarm or error is shown in the NOFIQ® BASE's display.



Attention!

The NOFIQ® FE is also available in a standalone version. In that case there is no question of a NOFIQ® system/network (with BASE, BASE-HUB and HUBS). Alarm and error messages therefore will not be notified to the BASE. (see chapter 15.5, page 80)

An alarm or error message will be shown in the alphanumeric display.

The top line of the display shows the message (MALFUNCTION, ALERT, etc.).

The bottom line of the display shows additional information about the message, for example which device it concerns.

If the information comprises several lines or if there are several alarm or error messages (identifiable by the < > arrows in the left corner) you can page through these lines by using the >-button and the <-button.

The next example shows how the system displays an error message:

```
MALFUNCTION                                     #ERRORS:2
-> <FE:101:Offline>
```

The next example shows how the system displays an alarm:

```
ALERT 11:48:12 02/10/2006                       #ALARMS:1
<FE:1-2>
```

The NOFIQ® system applies three different types of alarm messages:

- Alert
- Fire alarm
- Extinguishing

Alert

As soon as a NOFIQ® FE's sensors register a steep increase in temperature or CO concentration (without exceeding a critical point), the NOFIQ® FE sends an Alert to the alarm management station (the NOFIQ® BASE). With this alert the FE warns that probably something is not right at its location and that a fire may be developing. The Alert can only be shut down on the spot. This has been designed especially in this way to oblige a custodian to check whether a dangerous situation has arisen at the location in question. Thus a critical situation can be diagnosed quickly.

Fire alarm

If the temperature and the CO concentration have exceeded a critical level, the NOFIQ® FE will initiate a Fire alarm. This alarm warns that a fire has been detected and that the NOFIQ® FE will start an extinguishing sequence within 10 seconds. Within those 10 seconds the FE in question can be disabled by pressing the FE's button (Suspend). If someone would be doing maintenance work (welding, cleaning) at the location in question and forgot to Suspend the FE, the maintenance activities could be causing an alarm, although there is no question of fire. That is why there is a 10 second-countdown between the Fire alarm and the actual extinguishing routine.

Extinguishing

When the 10 second countdown expires the aerosol fire-extinguishing component will be activated and an extinguishing routine is started. The FE will now report an Extinguishing alarm.

The next table shows the behaviour of LEDs and buzzer in case of an alarm or error message.

| Status | LED behaviour | Buzzer behaviour |
|----------------------|---|---|
| MALFUNCTION | One or more yellow Malfunction LEDs blink twice briefly every 2 seconds | Beeps at 5 kHz, exactly corresponding with the LED pattern. |
| ALERT | Yellow led (Status - Alert) blinks twice every second. | Beeps at 5 kHz, exactly corresponding with the LED pattern. |
| FIRE ALARM | Yellow led blink thrice every seconds. | Beeps at 5 kHz, exactly corresponding with the LED pattern. |
| EXTINGUISHING | Red LED burns continuously | Continuous signal sweep between 4 and 5 KHz. |
| EXTINGUISHING-SILENT | Red LED burns continuously | Silent. |

Table 16 Indicators alarm and error messages

The list below shows the different error messages that the system can initiate and how these are shown on the control panel.

| Error message | Meaning and description | Applies to: | | | Indication LED on the control panel |
|---------------------------------|--|-------------|----------------|----|-------------------------------------|
| | | BASE | HUB | FE | |
| Offline | A heartbeat of an HUB or FE is missing. | | X | X | Network |
| Suspend-state activated | An FE has been temporarily disabled (Suspended). | | | X | Network |
| Disabled | The FE has executed an extinguishing and has been disabled. | | | X | Network |
| Parent missing | At least one HUB or FE misses a 'parent' that guarantees a backup route. | | X | X | Network |
| Is using a not granted HUB | A device uses a HUB which has not yet been added to the BASE | | X | X | Network |
| BASE-HUB | An error in the BASE-HUB. | | | | Network |
| Cause unknown | Internal (unknown) error. | X | X | X | System |
| Temperature sensor | An error in the temperature sensor. | | | X | System |
| CO sensor | An error in the CO sensor. | | | X | System |
| LCD | An error in the alphanumeric display. | X | | | System |
| LED | An error in the LEDs. | X | | | System |
| Keypad | An error in the keypad buttons. | X | | | System |
| Modem | An error in the modem. | X | | | System |
| Buzzer | An error in the buzzer. | X | | | System |
| Battery (UPS) | An error in the battery. | X | | | System |
| Igniter extinguishing component | An error in the igniter of the FirePro® extinguishing component. | | | X | System |
| Relay | A switch relay is faulty. | X | | X | System |
| InterNOFIQBus | An error in the communication within an InterNOFIQBus. | | | X | System |
| Battery failure | The level of the battery is low or missing. | X | | | System |
| Battery level low | The level of the battery-pack is low | | X ¹ | X | System |
| Battery level critical | The level of the battery-pack is critical. | | X ¹ | X | System |
| Mains power loss | Mains power is down. | X | X | | System |
| Notification | An error in the notification. | X | | | Notification |
| Network | Network communication is not available. | X | | | Network |

¹ Detection of these errors is only possible if mains power is down (Mains power loss).

Table 17 Overview error messages

23.3 How does the system handle an alarm?

If an FE reports an alarm automatically a notification will be forwarded to the fire brigade or another (private) fire-fighting service.



Attention!

The NOFIQ® FE is also available in a standalone version. In that case there is no question of a NOFIQ® system/network (with BASE, BASE-HUB and HUBS). Alarm and error messages therefore will not be notified to the BASE. (see chapter 15.5, page 80)

Notification can be executed in several ways: through the switch contacts and/or through the telephone modem of the NOFIQ® BASE.

For each message type up to 5 telephone numbers can be programmed. Each message type has its own priority. If the system is in error and the NOFIQ® BASE is notifying this error message to a service provider by calling the programmed telephone number, the alarm management system will cancel this task immediately if an Alert or Fire Alarm is received. The NOFIQ® BASE will immediately dial the first number programmed for the alarm message in question. As soon as a connection has been established a specified sequence of DTMF-numbers (tone dialling) will be played to identify the nature of the message. For every message type a separate combination of dual-tones has been programmed. These tones are repeated for 20 seconds, after which the system breaks off the connection.

| Message type | Priority | Telephone numbers | DTMF-sequence |
|--|----------|-------------------|-----------------------------------|
| ALARM (Fire Alarm or Extinguishing) | High | maximum 5 | programmable see also Table 19 |
| ALERT | Medium | maximum 5 | programmable see also Table 19 |
| MALFUNCTION | Low | maximum 5 | programmable see also Table 19 |

Table 18 Message priority

Default the following DTMF-tones are programmed.

| | | | | | | | | |
|-------------|---|-----|-----|-----|----------------------------|-----|-----|-----|
| ALARM | # 1 | # 2 | # 1 | # 2 | # 1 | # 2 | # 1 | # 2 |
| | | | | | | | | |
| ALERT | # 3 | | # 3 | | # 3 | | # 3 | |
| | | | | | | | | |
| MALFUNCTION | # 4 | | | | # 4 | | | |
| | | | | | | | | |
| | time interval of 2 seconds | | | | time interval of 2 seconds | | | |
| | The DTMF tone settings will be repeated for 20 seconds. | | | | | | | |
| | # X: DTMF tone of the telephone key in question | | | | | | | |

Table 19 DTMF tones for messages

**Warning!**

It is possible to disable notification of alarms and errors via the modem, for example during tests or maintenance checks. In that case messages are not notified by means of the NOFIQ® BASE's modem. Notification (or making an alarm bell go off) will always take place by means of the NOFIQ® BASE's potential-free switch contacts.

Always make sure that notification is (re-)enabled when tests and checks have been concluded!

23.4 What to do yourself in case of an alarm?

In case of an Alert

If a NOFIQ® FE reports an Alert, the situation at the location in question is not OK. Act as follows:

1. Check the situation at the location in question and take action if necessary.
2. Press the button of the NOFIQ® FE in question shortly to cancel the Alert warning and to bring the NOFIQ® FE back into SAFE status.

**Attention!**

If the conditions that caused the Alert are still present, the FE will again cause an Alert after the button is pressed. Only if conditions are good (e.g. after temperature has dropped to normal levels), pressing the button will bring the FE into SAFE status.

3. Go to the NOFIQ® BASE.
Put the authorisation key into the authorisation lock (left lock) and turn the key to the right.
4. Press the button **Reset**. The system will be restored. This is imperative since the Alert has been forwarded and the LED in question keeps burning until the system has been restored.
5. Turn the authorisation key to the left and take it out of the lock.
6. Register all data concerning the Alert in the log book.

In case of a Fire Alarm

If a NOFIQ® FE reports a Fire Alarm, it will start extinguishing within 10 seconds. Within those 10 seconds you can interrupt extinguishing by pressing the button of the FE in question. In practice this usually means that a Fire Alarm will pass into an Extinguishing alarm.

In case of an Extinguishing-alarm

If a NOFIQ® FE reports an Extinguishing alarm and this alarm has been forwarded to a Fire Alarm Centre or a Private Alarm Centre (identifiable by the burning red LED behind the status 'Notification' on the NOFIQ® BASE), you have to act as follows:

1. Put the authorisation key into the authorisation lock (left lock) and turn the key to the right.

2. Press the button **Reset**. The system will be restored.
3. Turn the authorisation key to the left and take it out of the lock.
4. Act according to instructions as stated in the emergency plan of your organisation.
5. Register all data concerning the alarm in the log book.



Attention!

If you press the button Reset after an extinguishing, the system will initiate an error message since the FE('s) in question is/are disabled. This error message will be forwarded (if this function is enabled).

If a NOFIQ® FE has carried out an extinguishing, the entire FE must be replaced since correct operation of the FE is no longer guaranteed. Replacing an FE is explained in paragraph 28.6.

23.5 How does the system handle an error?

If the NOFIQ® BASE registers an error message, automatically a notification will be forwarded to the NOFIQ® service provider.

Notification can be executed in several ways: through the switch contacts and/or through the telephone modem of the NOFIQ® BASE.

For notification of an error up to 5 telephone numbers can be programmed. As soon as a connection has been established a specified sequence of DTMF-numbers (tone dialling) will be played to identify the nature of the message. These tones are repeated for 20 seconds, after which the system breaks off the connection.



Attention!

The NOFIQ® FE is also available in a standalone version. In that case there is no question of a NOFIQ® system/network (with BASE, BASE-HUB and HUBS). Alarm and error messages therefore will not be notified to the BASE. How to proceed in case of an error in a standalone FE, is explained in paragraph 28.5.

23.6 What to do yourself in case of an error?

If an error message has been displayed on the NOFIQ® and this error has been forwarded to a NOFIQ® service provider (identifiable by the burning red LED behind the status 'Notification' on the NOFIQ® BASE), you have to act as follows:

1. Put the authorisation key into the authorisation lock (left lock) and turn the key to the right.
2. Press the the button **Reset**. The system will be restored.
3. Turn the authorisation key to the left and take it out of the lock.

4. Register the error message and the device in question in the log book.
5. Consult the Manual or User Guide for possible follow-up measures.

Certain errors restore automatically. If a HUB or FE loses contact due to interference in radio communication (e.g. during operation of a heavy machine), this error will be reported to the NOFIQ® BASE. As soon as communication is restored (because the machine has been turned off), the error message will disappear.



Attention!

If due to an error in network communication contact with a NOFIQ® FE has (temporarily) been interrupted, nothing is changed in functionality of the FE: it keeps on detecting and it alarms and extinguishes when circumstances require such actions.

Next follows a list with error messages, their meaning plus possible causes and solutions.

| Error message | Meaning and possible cause | Solution | Action |
|----------------------------|---|--|--|
| Offline | A heartbeat (status report) of a HUB or FE is missing, for example due to interference. | Variable | If the error is not restored automatically, contact your NOFIQ® service provider |
| Suspend-state activated | An FE has been disabled temporarily, for example because of maintenance in the cabinet where the FE is installed. | Re-enable the FE as soon as the situations permits. | Press the FE's button for 2 seconds. |
| Disabled | An FE has carried out an extinguishing and has been disabled. | The FE must be replaced. | Contact your NOFIQ® service provider |
| Parent missing | At least one HUB or FE misses a 'parent' that guarantees a backup route. | Variable | If the error is not restored automatically, contact your NOFIQ® service provider |
| Is using a not granted HUB | A FE or HUB uses a HUB which has not yet been added to the BASE. | The HUB must be added to the BASE (granted nodes database) | Add the HUB in question to the BASE (see chapter 12) |
| BASE-HUB | An error has been detected in the BASE-HUB. | Variable | Contact your NOFIQ® service provider |
| Cause unknown | An internal (unknown) error has been detected. | Variable | Contact your NOFIQ® service provider |
| Temperature sensor | An error has been detected in the temperature sensor. | Perhaps the FE must be replaced. | Contact your NOFIQ® service provider |
| CO sensor | An error has been detected in the CO sensor. | Perhaps the FE must be replaced. | Contact your NOFIQ® service provider |
| LCD | An error has been detected in the alphanumeric display of the NOFIQ® BASE. | Replacement or repair | Contact your NOFIQ® service provider |

| Error message | Meaning and possible cause | Solution | Action |
|---------------------------------|--|--|---|
| LED | An error has been detected in one or more of the LEDs of the NOFIQ® BASE. | Replacement or repair | Contact your NOFIQ® service provider |
| Keypad | An error has been detected in one or more of the buttons of the NOFIQ® BASE. | Replacement or repair | Contact your NOFIQ® service provider |
| Modem | An error has been detected in the modem of the NOFIQ® BASE. | Replacement or repair | Contact your NOFIQ® service provider |
| Buzzer | An error has been detected in the buzzer of the NOFIQ® BASE. | Replacement or repair | Contact your NOFIQ® service provider |
| Battery (UPS) | An error has been detected in the battery of the NOFIQ® BASE. | Replacement or repair | Contact your NOFIQ® service provider |
| Igniter extinguishing component | An error has been detected in the igniter of the FirePro® extinguishing component. | Perhaps the FE must be replaced. | Contact your NOFIQ® service provider |
| Relay | A switch relay is faulty. | Replacement or repair | Contact your NOFIQ® service provider |
| InterNOFIQBus | An error in the communication within an InterNOFIQBus. | Variable | Contact your NOFIQ® service provider |
| Battery failure | The level of the battery is low or missing. | The battery must be replaced in due course. | Contact your NOFIQ® service provider |
| Battery level low | The level of the battery-pack is low | The battery-pack must be replaced in due course. | Contact your NOFIQ® service provider |
| Battery level critical | The level of the battery-pack is critical. | The battery-pack must be replaced as soon as possible. | Contact your NOFIQ® service provider |
| Mains power loss | Mains power is down. The battery (NOFIQ® BASE) or the battery-pack (NOFIQ® HUB or FE) provide emergency power. | Mains power must be restored. | Contact your power supplier. The error will disappear as soon as mains power is restored. |
| Notification | An error in the notification (via the relays or the modem). | Variable | Contact your NOFIQ® service provider |
| Network | Network communication is not available. | Variable | If the error is not restored automatically, contact your NOFIQ® service provider |

Table 20 Errors: cause and possible solutions



Warning!

Repairs on NOFIQ® equipment may only be executed by your NOFIQ® service provider.

24. Maintenance of the NOFIQ® system

24.1 General

This chapter explains the general terms for maintenance of a NOFIQ® system. Furthermore this chapter offers information about general maintenance activities. In the next chapters maintenance of the separate components of the NOFIQ® system is explained.

24.2 Maintenance agreement

At the start of the system's use the certified service provider and the user of the NOFIQ® system have to conclude a maintenance agreement.

The user must appoint one or two personnel who are educated and instructed to function as custodian (instructed personnel). The NOFIQ® service provider will give the custodian all necessary instructions.

The maintenance agreement contains detailed arrangements on execution of periodical inspections and preventive maintenance. The example below gives an impression of the various maintenance aspects.

| Periodical inspections and preventive maintenance | | | | |
|---|----------------|---------------------|--------------------------------|--------------|
| | Once per month | Once per year | Long-term maintenance in years | After a fire |
| NOFIQ® BASE | X | X | | X |
| Primary power supply | X | X | | X |
| Secondary power supply | X | X | | X |
| Notification equipment for fire alarms | X | X | | X |
| Notification equipment for error messages | X | X | | X |
| NOFIQ® BASE-HUB | X | X | | X |
| NOFIQ® HUB | X | X | | X |
| Mains power adapter | X | X | | X |
| NOFIQ® FE | X | X | | X |
| FirePro® aerosol extinguishing components (container and igniter) | | | 15 years | X |
| CO sensor | | | 5 years | X |
| Mains power adapter FE (optional) | X | X | | X |
| Batteries | | | 2 years | X |
| Warnings signs object(s) | X | X | | X |
| Changes in respect of Program of Requirements and installation plan | X | X | | X |
| Organisation's emergency plan | X | X | | X |
| Log book | X | X | | X |
| | Custodian | Qualified personnel | | |

Table 21 Overview periodical inspections and preventive maintenance

The experiences and results of the periodical inspections and the preventive maintenance have to be recorded in a Maintenance Report and into the log book. An example of a log book is provided in Appendix 36.4. An example of a Maintenance report is provided in Appendix 36.5.

24.3 Periodical inspections and preventive maintenance

The NOFIQ® system can only keep functioning properly when all equipment is checked and maintained regularly. This concerns visual inspections as well as functional testing. The custodian of the NOFIQ® system as well the NOFIQ® service provider have to execute inspections and tests at set times.

Based on the maintenance agreement between the user and the NOFIQ® service provider periodical inspections and preventive maintenance have to be done:

- visual inspections:
you check based on what you see.
- functional testing:
you check the functionality by carrying out certain actions.

The chapters 25 up to and including 28 explain which periodical inspections and preventive maintenance have to be done for the separate components of the NOFIQ® system. Furthermore these chapter focus on other maintenance activities like replacing batteries or replacing an entire device.

The next paragraphs deal with general inspections to be carried out.

24.3.1 General visual inspections NOFIQ® system

Regularly (at least once a month) carry out the following inspections:

- Check whether the sticker with the text "Do not switch off, NOFIQ® fire protection system" is still present at the group switch of the power distribution point.
- Check whether escape routes are free of obstacles and ready to be opened immediately.
- Check the illumination of the safety icons for the escape routes.
- Check whether the NOFIQ® BASE is sufficiently illuminated.
- Check whether within the detection zones there have been changes in ventilation or outflow space for the NOFIQ® FE's.
- Check whether the organisation's emergency plan still meets current regulations.
- Check whether the Program of Requirements and the installation plan harmonize with the actual situation.
- Check whether the log book has been kept by the custodian and add records to the log book yourself if necessary.
- Check whether the personnel in question is sufficiently educated and knowledgeable about risks, dangers and safety precautions.

24.4 Dismantling equipment

In the following situations dismantling of equipment is required:

- a device is faulty and needs to be replaced (for example an FE after an extinguishing);
- a device is faulty and needs to be repaired;
- equipment needs to be moved (for example when the system is relocated).

Heed the following safety precautions during any form of dismantling:



- **Switch off power.**



- **Prevent damage to the the equipment.**
- **Prevent damage to the surroundings.**



- **If possible use the original packaging during transport.**
- **Mind the conditional requirements (as mentioned in paragraph 9.2) when transporting equipment that needs to be repaired.**
- **Never just dispose of parts and equipment; some parts may be reused or recycled.**
- **Never put old batteries in the normal waste; batteries belong to chemical waste and should be collected separately.**
- **If a FirePro® aerosol extinguishing component has been activated, it can be disposed of as normal waste after it has been dismantled.**
- **If a FirePro® aerosol extinguishing component has not been activated with the extinguishing agent still in its container, please return it to your supplier.**

24.5 Carrying out software updates

For carrying out software updates separate instructions will be provided by your NOFIQ® service provider.

24.6 Carrying out hardware updates

For carrying out hardware updates separate instructions will be provided by your NOFIQ® service provider.

24.7 Reading out log files of the NOFIQ® BASE

All data are saved by the NOFIQ® BASE in log files, and can be downloaded to a computer and then be viewed by a spreadsheet application like Microsoft Excel.

To read out these log files do as follows:

1. Connect a computer (laptop, notebook or PC) to the NOFIQ® BASE and start the terminal application of the NOFIQ® BASE as described in paragraph 12.3.
2. Choose option 3) Services.
3. Choose option 4) Error logs.

4. Choose option 1) Download all log files.

Next all log files will be downloaded to the hard disk of the computer. The log files are downloaded as a compressed file (zip-file). This file will get the following name structure: log files_yyyy-mm-dd.tgz.

The compressed file contains the following log files:

- applic.log Log information of the fire monitor application, contains (among other things) information on which errors occurred.
- eventlog.log Log information of the log application itself.
- extcomm.log Log information of the software for serial communication, especially the communication with the BASE-HUB.
- extio.log Log information of the software driving the hardware, like the display, the LEDs and the buzzer.
- network.log Log information of the software processing the network messages, like HUB and FE status reports (heartbeats).
- swwatchdog.log Log information of the watchdog mechanism. Contains (among other things) information about the process that caused a reset of the BASE.
- unittest.log Only used for software development.

With an application like WinZip you can expand all compressed log files; with an application like Microsoft Excel you can open the log file. By applying separations between the spaces, data will be divided into columns.

By using the option Autofilter in Excel (option Data, option Filter, option Autofilter) you will be able to select data per column and then put these in a graphical display if desired. Thus a log file of a specific HUB or FE can be viewed (see the example below).

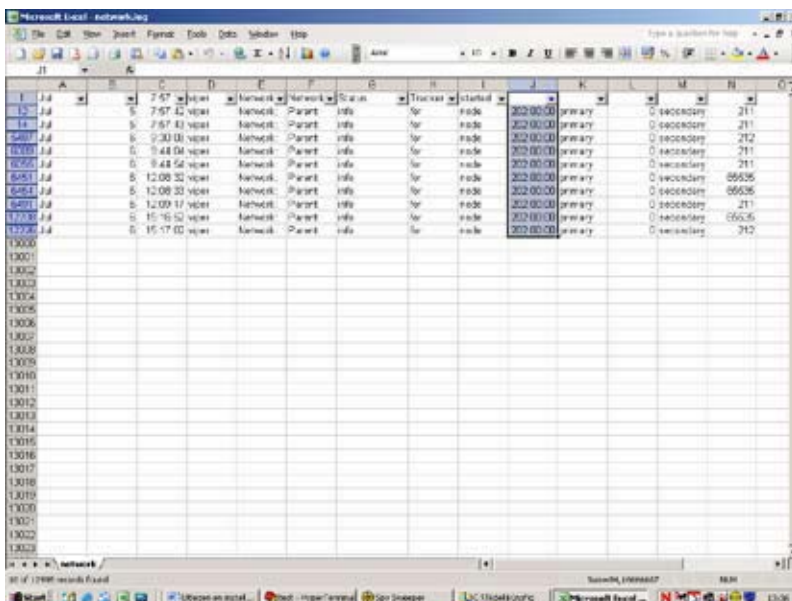

25. Maintenance of the NOFIQ® BASE

25.1 General

This chapter explains in detail maintenance of the NOFIQ® BASE. This maintenance comprises periodical inspections, functional testing as well as practical maintenance like replacing the battery or replacing the entire NOFIQ® BASE.



Attention!

Before carrying out maintenance, we advise you to activate the menu MAINTENANCE on the NOFIQ® BASE (see paragraph 19.11). Thus you will prevent reporting and notification of error messages (e.g. 'HUB: Offline') which are caused by the maintenance activities. As soon as you have concluded your activities, leave the menu MAINTENANCE by selecting and confirming the option <Exit>.

25.2 Periodical inspections and preventive maintenance NOFIQ® BASE

Based on the maintenance agreement between the user and the NOFIQ® service provider periodical inspections and preventive maintenance have to be carried out:

- visual inspections:
you check the NOFIQ® BASE based on what you see.
- functional testing:
you check operating of the NOFIQ® BASE by carrying out certain actions.

25.2.1 Visual inspections NOFIQ® BASE by the custodian

Regularly (at least once a month) carry out the following inspections:

- Check the outside of the NOFIQ® BASE.
Clean the NOFIQ® BASE on the outside if necessary.
- Check whether the optical indicators function properly by performing a test with the button **Test**.
- Check whether the original texts are still legible.
Reapply the texts if they are badly legible.
- Check whether the housing is intact and the NOFIQ® BASE is thoroughly fastened..
- Record the maintenance work into the log book.

25.2.2 Functional testing NOFIQ® BASE by the maintenance expert

Regularly (at least once a year) carry out the following inspections:

- Check the outside of the NOFIQ® BASE.
Clean the NOFIQ® BASE on the outside if necessary
- Check whether the original texts are still legible.
Reapply the texts if they are badly legible.
- Download the Granted nodes database and store it at a safe place.
Downloading the Granted nodes database is done by using the terminal application of the NOFIQ® BASE (see chapter 12.3).

- Check whether the housing is intact and the NOFIQ® BASE is thoroughly fastened.
- Check whether the cabling is well secured.
- Check the internal wiring and cabling for mechanical damage.
- Check the connecting points for corrosion.
- Check the settings of the time-clock.
- Compare the software present with the software implemented.
- Interrupt the primary power supply and check whether the error messaging, LEDs and buzzer function properly.
- Interrupt the secondary power supply and check whether the error messaging, LEDs and buzzer function properly.
- Check the battery's voltage.
- Test the notification function in case of an alarm.
Do this in consultation with the custodian and the receiver of the alarm notifications.
- Test the notification function in case of an error.
Do this in consultation with the custodian and the receiver of the error notifications.
- Check whether the buttons of the NOFIQ® BASE function properly.
- Check whether the optical indicators function properly by performing a test with the button **Test**.
- After finishing the maintenance, test the functionality of all equipment that has been disabled during maintenance.
- Record the maintenance work into the log book.

25.3 Repairs of the NOFIQ® BASE

Repairs comprise all activities necessary to return the NOFIQ® system into its nominal state. Carrying out repairs is restricted to the NOFIQ® service provider.

Repairs should be carried out immediately in such a way that stoppage is restricted to a minimum.



Attention!

After finishing the repairs you need to carry out functional tests.

Record the repairs into the log book.

25.4 Replacing the battery of the NOFIQ® BASE

To replace the battery of the NOFIQ® BASE do as follows:

1. Open the cabinet of the NOFIQ® BASE with the key.
2. Switch off mains power.
3. Disconnect the battery's connectors and remove the old battery.

**Attention!**

Never put old batteries in the normal waste; batteries belong to chemical waste and should be collected separately.

4. Position the new battery and connect it.
The red contact point must be connected to the plus side (red facet).
The blue contact point must be connected to the minus side (black facet).

**Attention!**

The battery for the NOFIQ® system is supplied by your NOFIQ® provider. Only these batteries can be used for your NOFIQ® device.

5. Switch on mains power.
6. Close the NOFIQ® BASE cabinet and lock it.

25.5 Replacing the NOFIQ® BASE

If a NOFIQ® BASE is faulty and beyond repair, it must be replaced. Do as follows:

1. Download from the faulty NOFIQ® BASE the Granted Nodes database (with all data on the system's FE's and HUBs). Hereto you connect a computer to the NOFIQ® BASE and start the terminal application (see chapter 12.3).

2. When you have started the application, you consecutively select:

- option 3. Services
- option 5. Granted nodes database
- option 1. Download granted nodes database

Download the database to the computer.

3. Remove the faulty NOFIQ® BASE from its location. Heed the instructions for dismantling as mentioned in paragraph 24.4.

4. Install and configure a new NOFIQ® BASE as described in chapter 10.

5. Upload the database to the new NOFIQ® BASE. Hereto you connect a computer to the NOFIQ® BASE and start the terminal application (see chapter 12.3).

When you have started the application, you consecutively select:

- option 3. Services
- option 5. Granted nodes database
- option 2. Upload granted nodes database

Upload the database to the NOFIQ® BASE.

26. Maintenance of the NOFIQ® BASE-HUB

26.1 General

This chapter explains in detail maintenance of the NOFIQ® BASE-HUB. This maintenance comprises periodical inspections, functional testing as well as practical maintenance like replacing the entire NOFIQ® BASE-HUB.



Attention!

Before carrying out maintenance, we advise you to activate the menu MAINTENANCE on the NOFIQ® BASE (see paragraph 19.11). Thus you will prevent reporting and notification of error messages (e.g. 'HUB: Offline') that are caused by the maintenance activities. As soon as you have concluded your activities, leave the menu MAINTENANCE by selecting and confirming the option <Exit>.

26.2 Periodical inspections and preventive maintenance BASE-HUB

Based on the maintenance agreement between the user and the NOFIQ® service provider periodical inspections and preventive maintenance have to be carried out:

- visual inspections:
you check the NOFIQ® BASE-HUB based on what you see.
- functional testing:
you check operating of the NOFIQ® BASE-HUB by carrying out certain actions.

26.2.1 Visual inspections NOFIQ® BASE-HUB by the custodian

Regularly (at least once a month) carry out the following inspections:

- Check the outside of the NOFIQ® BASE-HUB.
Clean the NOFIQ® BASE-HUB on the outside if necessary
- Check whether the original texts are still legible.
Reapply the texts if they are badly legible.
- Check whether the LEDs function properly.
- Check whether the housing is intact and the NOFIQ® BASE-HUB is thoroughly fastened.
- Record the maintenance work into the log book.

26.2.2 Functional testing NOFIQ® BASE-HUB by the maintenance expert

Regularly (at least once a year) carry out the following inspections:

- Check the outside of the NOFIQ® BASE-HUB.
Clean the NOFIQ® BASE-HUB on the outside if necessary
- Check whether the original texts are still legible.
Reapply the texts if they are badly legible.
- Check whether the cabling is well secured.
- Check the connecting points for corrosion.

- Check whether the LEDs of the NOFIQ® BASE-HUB function properly.
- After finishing the maintenance, test the functionality of all equipment that has been disabled during maintenance.
- Record the maintenance work into the log book.

26.3 Repairs of the NOFIQ® BASE-HUB

Repairs comprise all activities necessary to return the NOFIQ® system into its nominal state. Carrying out repairs is restricted to the NOFIQ® service provider.

Repairs should be carried out immediately in such a way that stoppage is restricted to a minimum.



Attention!

After finishing the repairs you need to carry out functional tests.

Record the repairs into the log book.

26.4 Replacing the NOFIQ® BASE-HUB

If a NOFIQ® BASE-HUB is faulty and beyond repair, it must be replaced. Do as follows:



Warning!

Switch off mains power and disconnect the battery (secondary power supply) of the NOFIQ® BASE.

1. Remove the faulty NOFIQ® BASE-HUB from its socket. Heed the instructions for dismantling as mentioned in paragraph 24.4. Check whether the socket must be replaced.
2. Install and configure a new NOFIQ® BASE-HUB as described in chapter 11.
3. Make the new NOFIQ® BASE-HUB operational as described in paragraph 11.4.

27. Maintenance of the NOFIQ® HUB

27.1 General

This chapter explains in detail maintenance of the NOFIQ® HUB. This maintenance comprises periodical inspections, functional testing as well as practical maintenance like replacing the entire NOFIQ® HUB.



Attention!

Before carrying out maintenance, we advise you to activate the menu MAINTENANCE on the NOFIQ® BASE (see paragraph 19.11). Thus you will prevent reporting and notification of error messages (e.g. 'HUB: Offline') that are caused by the maintenance activities. As soon as you have concluded your activities, leave the menu MAINTENANCE by selecting and confirming the option <Exit>.

27.2 Periodical inspections and preventive maintenance NOFIQ® HUB

Based on the maintenance agreement between the user and the NOFIQ® service provider periodical inspections and preventive maintenance have to be carried out:

- visual inspections:
you check each NOFIQ®-HUB based on what you see.
- functional testing:
you check operating of each NOFIQ®-HUB by carrying out certain actions.

27.2.1 Visual inspections NOFIQ® HUB by the custodian

Regularly (at least once a month) carry out the following inspections:

- Check the outside of the NOFIQ® HUB.
Clean the NOFIQ® HUB on the outside if necessary
- Check whether the original texts are still legible.
Reapply the texts if they are badly legible.
- Check whether the LEDs function properly.
- Check whether the housing is intact and the NOFIQ® HUB is thoroughly fastened.
- Check whether the numbering/address of the NOFIQ® HUB harmonizes with the data of the location in question.
- Record the maintenance work into the log book.

27.2.2 Functional testing NOFIQ® HUB by the maintenance expert

Regularly (at least once a year) carry out the following inspections:

- Check the outside of the NOFIQ® HUB.
Clean the NOFIQ® HUB on the outside if necessary
- Check whether the original texts are still legible.
Reapply the texts if they are badly legible.
- Check whether the LEDs function properly.
- Check whether the housing is intact and the NOFIQ® HUB is thoroughly fastened.

- Check whether the numbering/address of the NOFIQ® HUB harmonizes with the data of the location in question.
- Check the internal wiring and cabling for mechanical damage.
- Check the connecting points for corrosion.
- Interrupt the primary power supply and check whether the error messaging, LEDs and buzzer function properly.
- Interrupt the secondary power supply and check whether the error messaging, LEDs and buzzer function properly.
- After finishing the maintenance, test the functionality of all equipment that has been disabled during maintenance.
- Record the maintenance work into the log book.

27.3 Repairs of a NOFIQ® HUB

Repairs comprise all activities necessary to return the NOFIQ® system into its nominal state. Carrying out repairs is restricted to the NOFIQ® service provider.

Repairs should be carried out immediately in such a way that stoppage is restricted to a minimum.



Attention!

After finishing the repairs you need to carry out functional tests.

Record the repairs into the log book.

27.4 Replacing the battery-pack of a NOFIQ® HUB

The NOFIQ® battery-packs have an average lifetime of at least 2 years.

The actual lifetime depends on the environmental conditions in which the devices operate. Temperature and air humidity have a major influence on the batteries' lifetime. If a device regularly operates under high temperatures, the batteries' lifetime will be reduced. Since the NOFIQ® HUB makes use of a mains power adapter, the real lifetime of the battery-pack will prove to be longer than 2 years. A NOFIQ® device not connected to mains power will generate an error message when the energy level in the batteries is low. In that case the batteries have to be replaced within several weeks.



Attention!

The battery-pack of a NOFIQ® HUB must be replaced when the HUB has been operational on battery supply (secondary power supply) for more than 24 hours in total.

To replace the battery-pack of a NOFIQ® HUB do as follows:



Warning!

Switch off mains power.

1. Take the NOFIQ® HUB out of its socket.
2. Remove the lid of the battery holder (push with your finger in the direction of the arrow).
3. Disconnect the battery connector and remove the old battery-pack.



Attention!

Never put old batteries in the normal waste; batteries belong to chemical waste and should be collected separately.

4. Place the battery-pack and connect the battery connector (red on the outside, black on the inside). The connector has been made in such a way that there is only one possible way to connect it.



Attention!

The battery-pack for the NOFIQ® system is supplied by your NOFIQ® provider. Only these battery-packs can be used for your NOFIQ® devices.

5. Replace the lid onto the battery holder.
6. Place the lid back onto the battery holder.

27.5 Replacing a NOFIQ® HUB

If a NOFIQ® HUB is faulty and beyond repair, it must be replaced. Do as follows:

1. Remove the NOFIQ® HUB in question from the NOFIQ® BASE. Hereto you connect a computer to the NOFIQ® BASE and start the terminal application (see chapter 12.3).
2. When you have started the application, you consecutively select:
 - option 3. Services
 - option 3. Network Status
 - option 2. HUB
 - option 5. Remove HUB from network
3. Remove the faulty NOFIQ® HUB from its socket. Heed the instructions for dismantling as mentioned in paragraph 24.4. Check whether the socket must be replaced.
4. Install and configure a new NOFIQ® HUB as described in chapter 13.
5. Add the new NOFIQ® HUB to the NOFIQ® BASE as described in chapter 13.

28. Maintenance of the NOFIQ® FE

28.1 General

This chapter explains in detail maintenance of the NOFIQ® FE. This maintenance comprises periodical inspections, functional testing as well as practical maintenance like replacing the battery-pack or replacing a faulty NOFIQ® FE or an FE that has carried out an extinguishing.



Attention!

Before carrying out maintenance, we advise you to activate the menu MAINTENANCE on the NOFIQ® BASE (see paragraph 19.11). Thus you will prevent reporting and notification of error messages (e.g. 'HUB: Offline') that are caused by the maintenance activities. As soon as you have concluded your activities, leave the menu MAINTENANCE by selecting and confirming the option <Exit>.

28.2 Periodical inspections and preventive maintenance NOFIQ® FE

Based on the maintenance agreement between the user and the NOFIQ® service provider periodical inspections and preventive maintenance have to be carried out:

- visual inspections:
you check each FE based on what you see.
- functional testing:
you check operating of each FE by carrying out certain actions.

28.2.1 Visual inspections NOFIQ® FE by the custodian

Regularly (at least once a month) carry out the following inspections:

- Check the outside of the NOFIQ® FE.
Clean the NOFIQ® FE on the outside if necessary
- Check whether the original texts are still legible.
Reapply the texts if they are badly legible.
- Check whether the LEDs function properly.
- Check whether the housing is intact and the NOFIQ® FE is thoroughly fastened.
- Check whether the numbering/address of the NOFIQ® FE harmonizes with the data of the location in question.
- Check whether the housing is free of corrosion.
- Check whether the projection (position and direction of placement) of the NOFIQ® FE harmonizes with the data from the Program of Requirements and the installation plan.
- Check whether the NOFIQ® warning sticker is affixed to the outside of the protected object.
- Record the maintenance work into the log book

28.2.2 Functional testing NOFIQ® FE and InterNOFIQBus by the maintenance expert

Regularly (at least once a year) carry out the following inspections:

- Check the outside of the NOFIQ® FE.
Clean the NOFIQ® FE on the outside if necessary.
- Check whether the original texts are still legible.
Reapply the texts if they are badly legible.
- Check whether the LEDs function properly.
- Check whether the housing is intact and the NOFIQ® FE is thoroughly fastened.
- Check whether the numbering/address of the NOFIQ® FE harmonizes with the data of the location in question.
- Check whether the projection (position and direction of placement) of the NOFIQ® FE harmonizes with the data from the Program of Requirements and the installation plan.
- Check whether the NOFIQ® warning sticker is affixed to the outside of the protected object.
- Check whether the cabling is well secured.
- Check the internal wiring and cabling for mechanical damage.
- Check the connecting points for corrosion.
- Interrupt the primary power supply and check whether the error messaging, LEDs and buzzer function properly.
- Interrupt the secondary power supply and check whether the error messaging, LEDs and buzzer function properly.
- Test whether the InterNOFIQBus is operational by pressing the button of one of the linked FE's for 1 second. After releasing the button, the yellow, red and green LED of the other FE's will blink briefly.
- After finishing the maintenance, test the functionality of all equipment that has been disabled during maintenance.
- Record the maintenance work into the log book.



Attention!

The FirePro® aerosol extinguishing components' lifetime is at least 20 years. After 15 years the extinguishing components should be tested.

28.3 Repairs of a NOFIQ® FE

Repairs comprise all activities necessary to return the NOFIQ® system into its nominal state. Carrying out repairs is restricted to the NOFIQ® service provider.

Repairs should be carried out immediately in such a way that stoppage is restricted to a minimum.



Attention!

After finishing the repairs you need to carry out functional tests.

Record the repairs into the log book.

28.4 Replacing the battery-pack of a NOFIQ® FE

The NOFIQ® battery-packs have an average lifetime of at least 2 years.

The actual lifetime depends on the environmental conditions in which the devices operate. Temperature and air humidity have a major influence on the batteries' lifetime. If a device regularly operates under high temperatures, the batteries' lifetime will be reduced. A NOFIQ® FE not connected to mains power will generate an error message when the energy level in the batteries is low. In that case the batteries have to be replaced within several weeks.

To replace the battery-pack of a NOFIQ® HUB do as follows:



Warning!
Switch off mains power.

1. Take the NOFIQ® FE out of its socket.
2. Remove the lid of the battery holder (push with your finger in the direction of the arrow).
3. Disconnect the battery connector and remove the old battery-pack.



Attention!
Never put old batteries in the normal waste; batteries belong to chemical waste and should be collected separately.

4. Place the battery-pack and connect the battery connector (red on the outside, black on the inside). The connector has been made in such a way that there is only one possible way to connect it.



Attention!
The battery-pack for the NOFIQ® system is supplied by your NOFIQ® provider. Only these battery-packs can be used for your NOFIQ® devices.

5. Place the lid back onto the battery holder.
6. Place the NOFIQ® FE back into its socket.

28.5 Solving errors in a standalone NOFIQ® FE

A standalone NOFIQ FE will generate a message if an error has occurred. A standalone FE is not connected to a BASE and therefore it is not possible to determine at once which type of error has occurred. A standalone NOFIQ FE generates a message if an error has occurred in one of the following elements:

- temperature sensor
- CO sensor
- igniter of the FirePro® aerosol extinguishing component
- relay (potential-free switch contact)
- InterNOFIQBus

Furthermore the NOFIQ FE generates an error message in the following cases:

- battery level low
- battery level critical
- unknown (internal) error

In order to determine the type of error, do as follows:

1. Connect the NOFIQ FE via a MIC with a computer and start the program "NOFIQ PC Control" (see chapter 14)
2. Start the communication with the NOFIQ FE (see chapter 14).
3. Click the button Device Info
4. Click the button Check.

Next the program checks the operation of the elements of the device in question.

A properly operating part is displayed in green, a malfunctioning part is displayed in red.

The following items will be checked:

- CO sensor
- Temperature sensor
- Igniter of the extinguishing component (Igniter circuit)
- Batteries (green = battery OK; yellow = battery low); red = battery critical)
This square will not be shown when the devices operates on mains power.
- Suspended (red = suspended)
- Potential-free switch contact (Relay)
- InterNOFIQBus
- Network (not applicable to a standalone FE)

Based on these data you can determine the cause of the error and take the necessary countermeasures.

28.6 Replacing a NOFIQ® FE

After a NOFIQ® FE has carried out an extinguishing, the entire NOFIQ® FE must be replaced as soon as possible. Since there has been fire, the FE might be damaged. Even if the fire has been extinguished before actual damage has been done, the temperature increase could have deranged the FE's sensors, meaning that the reliability of the device is no longer guaranteed.

If a NOFIQ® FE is faulty it should be replaced as well.

To replace an FE do as follows:

1. Remove the NOFIQ® FE in question from the NOFIQ® BASE. Hereto you connect a computer to the NOFIQ® BASE and start the terminal application (see chapter 12.3).
2. When you have started the application, you consecutively select:
 - option 3. Services
 - option 3. Network Status
 - option 1. FE
 - option 5. Remove FE from network
3. Remove the faulty NOFIQ® FE. Dismantle the socket (it could be damaged by the heat of the fire). Heed the instructions for dismantling as mentioned in paragraph 24.4. Check whether the socket must be replaced.
4. Cleanse the location
When the FirePro® aerosol extinguishing component has been activated, after a certain amount of time the particles will deposit in the protected object as dry dust.
 - Remove this residue shortly after activation (within a couple of hours at the most).
 - Sweep up the residue by means of a brush or a damp cloth.
 - Use special sprays suited for removing the residue from electronic parts.
5. Install and configure a new NOFIQ® FE as described in chapter 15.
6. Add the new NOFIQ® FE to the NOFIQ® BASE as described in chapter 15.

If a FirePro® aerosol extinguishing component has been activated, it can be disposed of as normal waste after it has been dismantled.

If a FirePro® aerosol extinguishing component has not been activated with the extinguishing agent still in its container, please return it to your supplier.

28.7 Relocating a NOFIQ® FE

If you need to relocate an FE, heed the following:



Attention!

If an FE's primary power supply is changed from mains power to battery (e. g. if the FE has been moved), this will lead to an error message. You can solve this error by accessing the BASE's terminal program (see chapter 12). First you remove the FE in question (Remove FE from network) and then you add it again (Add FE to network).



Attention!

If a NOFIQ® FE at one stage has been part of an InterNOFIQBus and you want this FE to function on its own (but within a network), it is imperative that after disconnecting the FE from the InterNOFIQBus the FE is restarted by pressing its button for 10 seconds. Thus you prevent an error message.



Attention!

Modify the FE's location data in the NOFIQ® BASE.

Modify these data through the terminal application on the NOFIQ® BASE; consecutively choose:

- **option 3. Services**
- **option 3. Network Status**
- **option 1. FE**
- **option 5. Modify FE**

29. Service and warranty

The components of the NOFIQ® system have been manufactured with the utmost care and inspected according to current quality directives. If yet something is wrong with the equipment, please contact your NOFIQ® service provider.

Liability under this warranty is restricted to repairing or replacing those parts that prove to be flawed regarding material, completion or design. The conditions of this warranty do not apply in the following situations:

- the equipment has been damaged, disassembled or wrongly used after installation;
- the equipment has been modified after installation by unauthorised personnel;
- batteries have been used which have not been supplied and approved by your NOFIQ® service provider.

**Attention!**

**The batteries for the NOFIQ® system are supplied by your NOFIQ® provider.
Only these batteries can be used for your NOFIQ® devices.**

If you use other batteries than those supplied by your NOFIQ® service provider, the warranty for this equipment is void.

If the system reports that batteries need to be replaced ('Battery low' or 'Battery critical'), please contact your NOFIQ® service provider.

For detailed information on warranty we refer to our general business terms.

Below you can write down the address of your NOFIQ® service provider.

Name NOFIQ® service provider:

Address:

Postal code:

City:

Telephone:

Fax:

E-mail:

30. Support

Through the website of NOFIQ®, www.NOFIQ.com, we will keep you informed about among other things:

A

- the latest developments
- Acceptance 87
- answers to FAQ
- report 30, 87

Acceptance background information

Acceptance report 87

Aerosol technical specifications

- fire classes 25
- user experience

use 25

For technical questions, problems and maintenance please contact your NOFIQ® service provider.

Alarm 109

alert 15, 92, 103, 106

extinguishing 15, 93, 103, 107

fire alarm 15, 93, 103, 107

what to do? 109

Alarm message

indicators 92

types 92

Alarm messages 14

types 14, 103, 106

Alert 15, 92, 103, 106

Alphanumeric display 89

Authorisation 16

Authorisation level 16

Authorisation lock 91

B

Battery-pack

replacing 124, 128

Button

NOFIQ BASE-HUB 101

NOFIQ FE 105

NOFIQ HUB 102

Buttons

NOFIQ BASE 90

C

Components

system 11

Conditional requirements

operational system 34

storage 33

transport 33

Configuration

NOFIQ BASE 51

NOFIQ FE 65

NOFIQ HUB 65

Standalone 67

Control panel

NOFIQ BASE 88

CO sensor

NOFIQ FE 103

D

Data management

NOFIQ FE 56, 58

Dismantling 115

Display

NOFIQ BASE 89

DTMF-tones 109

E

Error 106

causes 112

solutions 112

standalone 128

what to do? 112

Error message

indicators 92

overview 93

Error messages 16

Extinguishing alarm 15, 93,

103, 107

Extinguishing compound

calculation amount 31

F

Fire alarm 15, 93, 103, 107

Fire classes 31

Functionality

NOFIQ BASE 17

NOFIQ FE 23

NOFIQ HUB 22

Functional testings

NOFIQ BASE 118

NOFIQ BASE-HUB 121

NOFIQ FE 126

NOFIQ HUB 123

H

Hardware

updates 116

I

Icons 10

Inspections

NOFIQ BASE 118

NOFIQ BASE-HUB 121

NOFIQ FE 126

NOFIQ HUB 123

NOFIQ system 115

NOFIQ service provider.

Installation

concise 36

InterNOFIQBus 81

NOFIQ BASE 39

NOFIQ BASE-HUB 47

NOFIQ FE 73

NOFIQ HUB 60

NOFIQ system 33

preparation 34

safety 26

InterNOFIQBus

installation 81

L

Log book 115

Log files 116

M

Maintenance Report 31

Maintenance

hardware 116

log files 116

NOFIQ BASE 118

NOFIQ BASE-HUB 121

NOFIQ FE 126

NOFIQ HUB 123

safety 26

software 116

system 114

Maintenance eport 115

Menu options

NOFIQ BASE 97

Menu structure

NOFIQ BASE 94

Messages

alarm 14

error messages 16

priority 15, 109

31. Index

N

NOFIQ BASE 17
 alphanumeric display 89
 authorisation lock 91
 buttons 90
 configuration 51
 control panel 88
 data management 51
 display 89
 functionality 17
 installation 39
 maintenance 118
 menu options 97
 menu structure 94
 reading log files 116
 replacing 120
 settings 51
 technical specifications 41
 terminal application 53
 test 91
 use 88
 NOFIQ BASE-HUB
 button 101
 indicators 101
 installation 47
 maintenance 121
 replacing 122
 status 101
 technical specifications 48
 use 101
 NOFIQ FE 23
 button 105
 change power supply 79,
 85, 131
 configuration 65
 CO sensor 103
 functionality 23
 indicators 104
 installation 74
 maintenance 126
 numbering 35
 relocating 131
 replacing 130
 sensors 103
 standalone 23, 103
 status 104

suspend 104
 technical specifications 74
 temperature sensor 103
 type FE20 12
 type FE80 12
 types 31
 use 103
 NOFIQ HUB 21
 button 102
 configuration 65
 functionality 22
 indicators 102
 installation 60
 maintenance 123
 numbering 35
 replacing 125
 status 102
 technical specifications 61
 use 102
 NOFIQ PC Control 66
 NOFIQ system
 acceptance 87
 components 11
 installation 33
 maintenance 114
 overview 11
 put into operation 86

P

Priority
 messages 15, 109
 Projection 31, 78
 Put into operation 86

R

Relocating
 NOFIQ FE 131
 Repairs 122, 124, 127
 Replacing
 battery 119
 battery-pack 124, 128
 NOFIQ BASE 120
 NOFIQ BASE-HUB 122
 NOFIQ FE 130
 NOFIQ HUB 125
 Report

Acceptance 30
 Maintenance 31

S

Safety
 aerosol 25
 after fire 27
 icons 10
 installation 26
 maintenance 26
 precautions 25
 Software
 updates 116
 Specifications
 NOFIQ BASE 41
 NOFIQ BASE-HUB 48
 NOFIQ FE 74
 NOFIQ HUB 61
 Standalone
 NOFIQ FE 23, 103
 Standalone FE 23, 103
 configuration 67
 errors 128
 installation 80
 Status 95
 NOFIQ BASE 95
 NOFIQ BASE-HUB 101
 NOFIQ FE 104
 NOFIQ HUB 102
 Status report 14
 Storage 33
 Suspend
 status 104
 System
 installation 33
 statuses 95

T

Temperature sensor
 NOFIQ FE 103
 Terminal application 53
 Transport 33

| | |
|--|----|
| Figure 1 Overview of the NOFIQ® system | 13 |
| Figure 2 NOFIQ® BASE | 17 |
| Figure 3 NOFIQ® BASE-HUB | 19 |
| Figure 4 NOFIQ® HUB | 21 |
| Figure 5 NOFIQ® FE | 23 |
| Figure 6 Design process NOFIQ® system | 29 |
| Figure 7 Projection NOFIQ® FE in a small and a large cabinet. | 32 |
| Figure 8 Interior NOFIQ® BASE | 39 |
| Figure 9 Connection fire-resistant NOFIQ® BASE | 43 |
| Figure 10 Connection potential-free switch contacts | 44 |
| Figure 11 Connection battery NOFIQ® BASE | 45 |
| Figure 12 The NOFIQ® BASE-HUB | 47 |
| Figure 13 Connection fire-resistant cable to connector NOFIQ® BASE-HUB | 49 |
| Figure 14 Connection NOFIQ® HUB connector | 62 |
| Figure 15 Connection NOFIQ® FE connector | 76 |
| Figure 16 Placement batteries NOFIQ® FE | 76 |
| Figure 17 NOFIQ® FE Elements and battery connection | 77 |
| Figure 18 Control panel NOFIQ® BASE | 88 |

32. List of figures and tables

32.1 List of figures

| | |
|---|-----|
| Table 1 Message priority | 15 |
| Table 2 Authorisation levels | 16 |
| Table 3 Capacity extinguishing agent per fire class | 31 |
| Table 4 Conditional requirements storage and transport | 34 |
| Table 5 Conditional requirements operational system | 34 |
| Table 6 Indication LEDs NOFIQ® BASE | 90 |
| Table 7 Buttons control panel NOFIQ® BASE | 91 |
| Table 8 Indicators alarm and error messages | 92 |
| Table 9 Overview error messages | 94 |
| Table 10 Statuses NOFIQ® BASE-HUB and their meaning | 101 |
| Table 11 Statuses NOFIQ® BASE-HUB and accompanying LED behaviour | 101 |
| Table 12 Statuses NOFIQ® HUB and their meaning | 102 |
| Table 13 Statuses NOFIQ® HUB and accompanying indicator behaviour | 102 |
| Table 14 Statuses NOFIQ® FE and their meaning | 104 |
| Table 15 Statuses NOFIQ® FE and accompanying indicator behaviour | 104 |
| Table 16 Indicators alarm and error messages | 107 |
| Table 17 Overview error messages | 108 |
| Table 19 DTMF tones for messages | 109 |
| Table 20 Errors: cause and possible solutions | 113 |
| Table 21 Overview periodical inspections and preventive maintenance | 114 |



32.2 List of tables

33. Abbreviations

| | |
|------------------|---|
| AC/DC | Alternating Current / Direct Current |
| CO | Carbon monoxide |
| DTMF | Dual Tone Multi Frequency. |
| FE | Fire Extinguisher This is the extinguishing component of the NOFIQ® system |
| Hz (GHz) | Hertz (Gigahertz) |
| ISM band | Industrial, Science and Medical band. Radio frequency band especially reserved for these purposes. |
| LED (led) | Light Emitting Diode |
| MIC | Maintenance Interface Cable This cable provides the connection between a computer and a HUB or FE. |
| MSDS | Material Safety Data Sheet This data sheet offers information on risks, dangers and safety precautions of a certain material or substance. |
| NSK | Network Security Key This is the unique code for the entire NOFIQ® network which prevents interception of NOFIQ® network communication by external devices. This key is identical for each device (BASE, FE, HUB, BASE-HUB) in one and the same NOFIQ® system. |
| SNA | Short Network Address This the unique network address granted to the HUB or FE. Each FE or HUB has its own SNA. The SNA of the BASE-HUB is 0. |

34. Glossary

| | |
|-------------------------------|--|
| Acceptance Report | Document presenting an overview of the system and declaring that the NOFIQ® system is operational and in compliance with the reference points as recorded in the Program of Requirements. Furthermore this documents declares that all components applied and all elements of the installation are in compliance with the operative requirements on quality and compatibility. |
| Aerosol | Colloid mixture of solid or liquid particles in a gaseous medium. |
| Alarm management station | Central system that gathers and processes information on all connected detection and extinguishing components. If required it initiates proceeding actions (like notifying an alarm or error). The NOFIQ® BASE is the alarm management station of the NOFIQ® system. |
| Alarm message | Message shown in the display of the NOFIQ® BASE reporting that a NOFIQ® FE has detected a (possible) fire. |
| Alert | Alarm indicating that the sensors of a NOFIQ® FE have detected a situation which could point to a starting fire. |
| Authorisation | The system acknowledges different authorisation levels to ensure that only properly qualified users are allowed to carry out certain activities. |
| Custodian (trained personnel) | Personnel, whether or not in the user's service, in possession of a compulsory certificate of qualification. He or she is instructed in the duties appointed and in risks resulting from incorrect actions. |
| Emergency plan | Description of organisational measures and precautions within a company or organisation to limit the consequences of incidents to a minimum. |
| Error message | Message shown in the NOFIQ® BASE's display reporting that an error has occurred in the equipment or in the network's communication. An error message is not identical to an alarm message; an alarm message is only generated in case of a (possible) fire. |
| Extinguishing | The extinguishing routine by a NOFIQ® FE. |
| Fire alarm | Status in which a NOFIQ® FE has detected a fire and prepares to extinguish the fire (within 10 seconds after the Fire Alarm). |

| | |
|-------------------------------|---|
| FirePro® | Aerosol extinguishing component. |
| Fire-resistant cable | Cable which in case of fire guarantees to maintain its functionality for at least 30 minutes. |
| Heartbeat | See Status report. |
| InterNOFIQBus | Linking of 2 to 4 NOFIQ® FE's. |
| Log book | Registry for recording notes on management, inspection and maintenance of the system. |
| Maintenance expert | Personnel in possession of a compulsory certificate of qualification for maintaining the NOFIQ® system and charged with and responsible for maintenance of NOFIQ® systems. |
| Maintenance Report | Document by the NOFIQ® service provider offering an overview of the system. It declares that the NOFIQ® system is maintained in compliance with current directives, that the system is operational and still in compliance with the reference points recorded in the Program of Requirements. |
| Network Security Key | This is the unique code for the entire NOFIQ® network which prevents interception of NOFIQ® network communication by external devices. This key is identical for each device (BASE, FE, HUB, BASE-HUB) in one and the same NOFIQ® system. |
| NOFIQ® BASE | Alarm management station. |
| NOFIQ® BASE-HUB | Signal repeater linked to the NOFIQ® BASE. The NOFIQ® BASE-HUB functions as receiving station of the NOFIQ® BASE. |
| NOFIQ® FE | Detection and extinguishing component. |
| NOFIQ® HUB | Signal repeater. |
| Program of Requirements (PoR) | Document in which the reference points for realising a NOFIQ® fire protection system are recorded and authorised unambiguously by expert personnel. |
| Projection | The position and direction in which a device (especially an FE) is placed. |
| Short Network Address | This the unique network address granted to a HUB or FE. Each FE or HUB has its own SNA. |



| | |
|----------------------|--|
| Standalone NOFIQ® FE | A NOFIQ® FE that is not part of a NOFIQ® network. A standalone NOFIQ® FE does not use wireless communication with (other) NOFIQ® devices. The other functionality of a standalone NOFIQ® FE is identical to that of a NOFIQ® FE in a NOFIQ® network. |
| Status report | Information sent by a NOFIQ® FE or NOFIQ® HUB reporting its status to the system. |
| Suspend | Status of a NOFIQ® FE in which its operation is temporarily disabled (for example during maintenance). |
| User | Personnel responsible for management of the NOFIQ® system, or the owner of the NOFIQ® system. |

35. Certification

For development of the NOFIQ® system the following national and international directives have been consulted:

| Directives / normative references | Document |
|---|---|
| BRL-K23001/03 | Autonomous stationary extinguishing systems based on dry aerosols |
| BRL-K21014/03 | Aerosol fire-extinguishing systems for fire protection at the source in enclosed compartments containing electrical components |
| DIN 50018 | Environmental testing Corrosion test - Alternating condensation in an atmosphere containing sulphur dioxide |
| ETSI EN 301 489 - 1 | Electromagnetic compatibility and Radio Spectrum Matters (ERM); Electromagnetic Compatibility (EMC) standard for radio and services; Part 1: Common technical requirements |
| ETSI EN 301 489 - 3 | Electromagnetic compatibility and Radio Spectrum Matters (ERM); Electromagnetic Compatibility (EMC) standard for radio and services; Part 3: Specific conditions for Short-Range Devices (SRD) operating on frequencies between 9 KHz and 40 GHz |
| ETSI EN 300 440 - 1 | Electromagnetic compatibility and Radio Spectrum Matters (ERM); Electromagnetic Compatibility (EMC) standard for radio and services; Part 1: Technical characteristics and test methods |
| ETSI EN 300 440 - 2 | Electromagnetic compatibility and Radio Spectrum Matters (ERM); Electromagnetic Compatibility (EMC) standard for radio and services; Part 2: Harmonized EN covering essential requirements under Article 3.2 of the R&TTE Directive |
| EN 50130 - 4 | Alarm systems - Part 4: Electromagnetic compatibility - Product family standard: Immunity requirements for components of fire, intruder and social alarm systems |
| NEN - EN 54 - 2 | Fire detection and fire alarm systems - Part 2: Control and indicating equipment (including correction sheet) |
| NEN - EN 54 - 4 | Fire detection and fire alarm systems - Part 4: Power supply equipment (including correction sheet) |
| NEN - EN 54 - 5 | Fire detection and fire alarm systems - Part 5: Thermal alarm devices - Point detectors |
| PrNEN - EN 54 - 13 | Fire detection and fire alarm systems - Part 13: Compatibility of system components |
| PrNEN - EN 54 - 18 | Fire detection and fire alarm systems - Part 18: Input/output devices |
| PrNEN - EN 54 - 21 | Fire detection and fire alarm systems - Part 21: Alarm transmission and fault warning routing equipment |
| NEN - EN 54 - 25 | Fire detection and fire alarm systems - Part 25: Components using radio links |
| NEN - EN 12094 - 1 | Fixed fire-fighting systems - Components for gas extinguishing systems - Part 1: Requirements and test methods for electrical automatic control and delay devices |

| Directives / normative references | Document |
|---|---|
| ISO 7240 - 6 | Fire detection and alarm systems - Part 6: Carbon monoxide fire detectors using electro-chemical cells |
| IEC 68 | Basic Environmental testing procedures - Part 1: 1998+A1: 1992 general and guidance |
| IEC EN 60068-2-1 | Environmental testing Part 2-1: Tests - Tests A: Cold |
| IEC EN 60068-2-2 | Basic environmental testing procedures Part 2-2: Tests - Tests B: Dry Heat |
| IEC EN 60068-2-6 | Environmental testing Part 2-6: Tests - Tests Fc: Vibration (sinusoidal) |
| IEC EN 60068-2-27 | Environmental testing Part 2-27: Tests - Tests Ea: Shock |
| IEC EN 60068-2-30 | Environmental testing Part 2-30: Tests - Tests Db Damp heat cyclic |
| IEC EN 60068-2-32 | Environmental testing Part 2-32: Tests - Tests Ed: Free Fall |
| IEC EN 60068-2-56 | Environmental testing Part 2-56: Tests - Tests Cb: Damp heat, steady state |
| IEC EN 60068-2-75 | Environmental testing Part 2-75: Tests - Tests Eh: Hammer Test |
| IEC EN 60068-2-78 | Environmental testing Part 2-78: Tests - Tests Cab: Damp heat, steady state |
| IEC EN 60529 | Degrees of protection provided by enclosures (IP code) |

36. Appendices

36.1 Program of Requirements (example)

| 1. General data | |
|---------------------------------------|---|
| Project number | |
| Object(s) protected | <input type="checkbox"/> Switch cabinet (s) <input type="checkbox"/> Computer(s) <input type="checkbox"/> Meter box(es) <input type="checkbox"/> Other |
| Custodian NOFIQ® system | Name company: Contact person: Address: Postal code and City: Telephone: E-mail: |
| NOFIQ® service provider | Name company: Contact person: Address: Postal code and City: Telephone: E-mail: |
| Competent authorities (if applicable) | Name company: Contact person: Address: Postal code and City: Telephone: E-mail: |
| Documents | Drawing number |

| 2. Design data | |
|------------------------|--|
| Design | <input type="checkbox"/> Object 1 m x m x m = m ³ <input type="checkbox"/> Object 2 m x m x m = m ³ <input type="checkbox"/> Object 3 m x m x m = m ³ <input type="checkbox"/> Object 4 m x m x m = m ³ |
| Projection NOFIQ® FE's | <input type="checkbox"/> BRL K21014 Explanation When applying 1 NOFIQ® FE it will be placed in the middle of the object on the upper side, having the outflow openings pointing to the left and the right. Ensure that both outflow openings have at least 15 cm of free outflow space in order to prevent damage to equipment. When applying 2 or more NOFIQ® FE's these are placed on the side of the object in question, having the outflow openings pointing upwards and downwards. Ensure that both outflow openings have at least 15 cm of free outflow space in order to prevent damage to equipment. |

| 2. Design data | |
|--|--|
| External adapter for FE's desirable | <input type="checkbox"/> Yes <input type="checkbox"/> No |
| Fire class | <input type="checkbox"/> A (solid) <input type="checkbox"/> B (liquids) <input type="checkbox"/> C (gasses) <input type="checkbox"/> D (oils and fats) |
| Antenna outside of the object to be protected (Faraday's cage) | <input type="checkbox"/> Object 1 <input type="checkbox"/> Object 2 <input type="checkbox"/> Object 3 <input type="checkbox"/> Object 4 |
| InterNOFIQBus | <input type="checkbox"/> Not applicable |
| Air changes inside object | <input type="checkbox"/> Object 1, < 1 m/s <input type="checkbox"/> Object 2, < 1 m/s <input type="checkbox"/> Object 3, < 1 m/s <input type="checkbox"/> Object 4, < 1 m/s |
| Temperature inside object | <input type="checkbox"/> Object 1, °C <input type="checkbox"/> Object 2, °C <input type="checkbox"/> Object 3, °C <input type="checkbox"/> Object 4, °C |
| Controls | <input type="checkbox"/> Object 1, ventilation provision <input type="checkbox"/> Object 2, ventilation provision <input type="checkbox"/> Object 3, ventilation provision <input type="checkbox"/> Object 4, ventilation provision |
| Identification | <input type="checkbox"/> On the outside of the protected object warning signs must be affixed with the text "AUTOMATIC FIRE PROTECTION SYSTEM, in case of fire or alarm: do not panic, close cabinet doors object and alert expert assistance" |
| NOFIQ® BASE and BASE-HUB | <input type="checkbox"/> Placement at the reception desk <input type="checkbox"/> Placement at the main entrance <input type="checkbox"/> Other Explanation The NOFIQ® BASE and the BASE-HUB should be placed at the reception, behind the desk. |
| Power supply NOFIQ® BASE | <input type="checkbox"/> Separate end group <input type="checkbox"/> Identification group switch "DO NOT SWITCH OFF, NOFIQ® SYSTEM" |
| Error messages to | <input type="checkbox"/> Name person <input type="checkbox"/> Tel nr. 1: <input type="checkbox"/> Tel nr. 2: <input type="checkbox"/> Tel nr. 3: <input type="checkbox"/> Tel nr. 4: |
| Alert message to | <input type="checkbox"/> Name person <input type="checkbox"/> Tel nr. 1: <input type="checkbox"/> Tel nr. 2: <input type="checkbox"/> Tel nr. 3: <input type="checkbox"/> Tel nr. 4: |

| 2. Design data | |
|--|---|
| Fire alarm message to | <input type="checkbox"/> Name person <input type="checkbox"/> Tel nr. 1: <input type="checkbox"/> Tel nr. 2: <input type="checkbox"/> Tel nr. 3: <input type="checkbox"/> Tel nr. 4: |
| Telephone dialler needed | <input type="checkbox"/> Yes <input type="checkbox"/> No |
| Notification through main fire alarm station | <input type="checkbox"/> Yes <input type="checkbox"/> No |
| Notification equipment for error messages | <input type="checkbox"/> Not applicable <input type="checkbox"/> PAS (Private alarm station) <input type="checkbox"/> State name and telephone number PAS <input type="checkbox"/> Alarm report code |
| Notification equipment for alarm messages | <input type="checkbox"/> Not applicable <input type="checkbox"/> FAS (Fire alarm station) <input type="checkbox"/> State name and telephone number FAS <input type="checkbox"/> Alarm report code |

| 3. Acceptance, management and maintenance | |
|---|---|
| Acceptance Report | <input type="checkbox"/> Yes <input type="checkbox"/> No |
| Log book | <input type="checkbox"/> Yes <input type="checkbox"/> No |
| Maintenance agreement | <input type="checkbox"/> Yes <input type="checkbox"/> No Explanation The NOFIQ® service provider and the customer must draw up a maintenance contract. |
| Custodian (trained personnel) | Name : Telephone number : |
| Emergency plan present | <input type="checkbox"/> Yes <input type="checkbox"/> No Explanation Presence of the NOFIQ® system must be recorded in the emergency plan. |

| 4. References | |
|-----------------------------------|---|
| Directives / normative references | <ul style="list-style-type: none"> • BRL K21014/01 |

| 5. Approval | |
|--|--|
| Custodian NOFIQ® system | Name company: Contact person: Address: Postal code and City: Telephone: E-mail: Signature: |
| PoR-drafter | Name company: Contact person: Address: Postal code and City: Telephone: E-mail: Signature: |
| Competent authorities (if applicable) | Name company: Contact person: Address: Postal code and City: Telephone: E-mail: |

36.3 Acceptance Report (example)

| | |
|-------------------------|---|
| Project number | |
| Object(s) protected | <input type="checkbox"/> Switch cabinet (s) <input type="checkbox"/> Computer(s) <input type="checkbox"/> Meter box(es) <input type="checkbox"/> Other |
| Network Configuration | <input type="checkbox"/> Network ID: <input type="checkbox"/> Network Channel: <input type="checkbox"/> Encryption Key (HEX): |
| Custodian NOFIQ® system | Name company: Contact person: Address: Postal code and City: Telephone: E-mail: |
| NOFIQ® service provider | Name company: Contact person: Address: Postal code and City: Telephone: E-mail: |

| 2. Document check | | | | |
|--|----------|----|-----|----------|
| Points of interest | Complied | | | Comments |
| | Yes | No | N/A | |
| Program of Requirements validated | | | | |
| Installation plan present | | | | |
| Signed maintenance agreement | | | | |
| Log book present | | | | |
| User Guide present | | | | |
| Acceptance NOFIQ® system recorded into log book | | | | |
| Custodian (trained personnel) NOFIQ® system appointed and recorded into log book | | | | |
| Emergency plan adjusted with presence NOFIQ® system | | | | |

| 3. Design check | | | | |
|--|----------|----|-----|----------|
| Points of interest | Complied | | | Comments |
| | Yes | No | N/A | |
| Projection NOFIQ® FE's in compliance with BRL K21014 | | | | |

| 4. Check on Components NOFIQ® system | | | | |
|--------------------------------------|----------|----|-----|----------|
| Points of interest | Complied | | | Comments |
| | Yes | No | N/A | |
| NOFIQ® BASE | | | | |
| Fire-resistant cable | | | | |
| NOFIQ® BASE-HUB | | | | |
| NOFIQ® HUB | | | | |
| Mains power adapter HUB | | | | |
| NOFIQ® FE | | | | |
| Mains power adapter FE | | | | |
| External antenna FE | | | | |
| Warning sticker for object | | | | |

| 5. Check NOFIQ® BASE | | | | |
|---|----------|----|-----|----------|
| Points of interest | Complied | | | Comments |
| | Yes | No | N/A | |
| Appropriately fastened | | | | |
| General illumination of at least 100 lux and 500 lux at the most | | | | |
| Emergency illumination at least 10 lux | | | | |
| Acoustic indicators clearly audible | | | | |
| Surroundings clean and dry | | | | |
| Low risk for mechanical damage | | | | |
| Low fire risk | | | | |
| Free space to the front side, enabling rotating parts to be opened completely. | | | | |
| Power supply via separate end group | | | | |
| Cabling in tubular system and clamped | | | | |
| Group switch identified with warning "DO NOT SWITCH OFF, NOFIQ® fire protection system" | | | | |
| Telephone numbers error messages programmed | | | | |
| Telephone numbers alert messages programmed | | | | |
| Telephone numbers fire alarm messages programmed | | | | |
| Telephone dialler | | | | |
| Notification through main fire alarm station | | | | |
| Notification of error messages | | | | |
| Notification of fire alarm messages | | | | |

| 5. Check NOFIQ® BASE | | | | |
|--|-----------------|-----------|------------|-----------------|
| Points of interest | Complied | | | Comments |
| | Yes | No | N/A | |
| Potential-free switch contacts connected and operative | | | | |

| 6. Check NOFIQ® BASE-HUB | | | | |
|---------------------------------------|-----------------|-----------|------------|-----------------|
| Points of interest | Complied | | | Comments |
| | Yes | No | N/A | |
| Appropriately fastened | | | | |
| Cabling in tubular system and clamped | | | | |

| 7. Check NOFIQ® HUB | | | | |
|-------------------------------|-----------------|-----------|------------|-----------------|
| Points of interest | Complied | | | Comments |
| | Yes | No | N/A | |
| Appropriately fastened | | | | |
| Mains power adapter connected | | | | |

| 8. Check NOFIQ® FE | | | | |
|--|-----------------|-----------|------------|-----------------|
| Points of interest | Complied | | | Comments |
| | Yes | No | N/A | |
| Appropriately fastened | | | | |
| Mains power adapter connected | | | | |
| InterNOFIQBus connected | | | | |
| Potential-free switch contact connected and operative | | | | |
| Warning sign on outside of protected object "AUTOMATIC FIRE PROTECTION SYSTEM, in case of fire or alarm: do not panic, close cabinet doors object and alert expert assistance" | | | | |
| Antenna outside of the protected object | | | | |

| 9. Comments | | |
|---|-------------|------------------|
| | | |
| Undersigned declares on behalf of the certified NOFIQ® service provider that the NOFIQ® system is designed, installed, put into operation and accepted conformably to the starting-points in the Program of Requirements, the manual of NOFIQ® systems BV and the BRL K21014. | | |
| Name | Date | Signature |
| | | |

36.4 Log book (example)

Into the log book everything in regard with the NOFIQ® system should be recorded (like alarms, errors, inspections carried out, repairs and changes).

Making entries into the log book is restricted to the representatives mentioned below: the custodian(s) (trained personnel), the NOFIQ® service provider or its maintenance expert(s).

| All errors which cannot be solved, have to be reported to the maintenance service immediately | | | |
|--|---|-----------|------|
| Name | Telephone number | Signature | Date |
| The following custodians (trained personnel) are responsible for the NOFIQ® system and its periodical inspections | | | |
| Name custodian | Attainability during office-hours out of office-hours | | |
| Name alternate during absence | Attainability during office-hours out of office-hours | | |
| Receiving centre for fire alarm messages | | | |
| Receiving centre for error messages | | | |
| Time schedule monthly periodical inspections | | | |
| Check at least once per month: | | | |
| <ul style="list-style-type: none"> • NOFIQ® BASE • NOFIQ® BASE-HUB • NOFIQ® HUB • NOFIQ® FE • Notification error • Notification alert • Notification fire alarm / extinguishing | | | |
| Each 1st / 2nd / 3rd / 4th Monday / Tuesday / Wednesday / Thursday / Friday of the month | | | |
| Time schedule yearly periodical inspections | | | |

| | | | |
|--|--------------------------------|------------------------------------|-----------------------------------|
| Check at least once per year after acceptance and maintenance has been carried out by a maintenance expert: Attainability NOFIQ® BASE, NOFIQ® BASE-HUB, NOFIQ® HUB and NOFIQ® FE Changes in comparison with reference points Program of Requirements | | | |
| Each 1st / 2nd / 3rd / 4th Monday / Tuesday / Wednesday / Thursday / Friday of the month | | | |
| <input type="checkbox"/> January | <input type="checkbox"/> April | <input type="checkbox"/> July | <input type="checkbox"/> October |
| <input type="checkbox"/> February | <input type="checkbox"/> May | <input type="checkbox"/> August | <input type="checkbox"/> November |
| <input type="checkbox"/> March | <input type="checkbox"/> June | <input type="checkbox"/> September | <input type="checkbox"/> December |

Every event (so without any exceptions) regarding the NOFIQ® system should be recorded into the log book. We advise you to record each event, the periodical inspections as well, into the log book immediately.

During the yearly maintenance the custodian (trained personnel) and the maintenance service will review the system's behaviour during the past period and will take countermeasures if necessary. The events must be specified by adding a code to the schedule, e.g. Cm1 = monthly check of the NOFIQ® BASE.

In the column "What" (see below) the following abbreviations can be applied:

- A Genuine fire alarm internal
 - B Genuine fire alarm external
 - C Spurious fire alarm internal
 - D Spurious fire alarm external
 - E False fire alarm internal
 - F False fire alarm external
 - Cm Monthly check (inspection)
 - Cy Yearly check (inspection)
 - Ac Acceptance
 - Md Modification, change, (software) modification
 - X Expansion
 - M Maintenance by maintenance service
 - S Error (each erroneous occurrence within the system not being an alarm message)
 - Sc Error solved by custodian (trained personnel)
 - Sm Error solved by door maintenance service
 - V Visit (if none of the activities above has been carried out)
-
- 1 NOFIQ® BASE
 - 2 NOFIQ® BASE-HUB
 - 3 NOFIQ® HUB
 - 4 NOFIQ® FE
 - 5 Notification alarm messages
 - 6 Notification error messages
 - 7 Control functions

| Who | When | Where | What | Why |
|------------|-------------|--------------|----------------|------------------------|
| Name | Date + time | Object | Code from list | Cause of alarm / error |
| | | | | |
| | | | | |
| | | | | |

36.5 Maintenance Report (example)

| 1. General data | |
|-------------------------|--|
| Project number | |
| Object(s) protected | Switch cabinet (s) Computer(s) Meter box(es) Other |
| Configuration network | Network ID: Network Channel: Encryption key (HEX): |
| Custodian NOFIQ® system | Name company: Contact person: Address: Postal code and City: Telephone: E-mail: |
| NOFIQ® service provider | Name company: Contact person: Address: Postal code and City: Telephone: E-mail: |

| 2. Document check | | | | |
|--|----------|----|-----|----------|
| Points of interest | Complied | | | Comments |
| | Yes | No | N/A | |
| Program of Requirements validated | | | | |
| Installation plan present | | | | |
| Acceptance Report | | | | |
| Signed maintenance agreement | | | | |
| Log book present | | | | |
| User Guide present | | | | |
| Acceptance NOFIQ® system recorded into log book | | | | |
| Custodian (trained personnel) NOFIQ® system appointed and recorded into log book | | | | |
| Emergency plan adjusted with presence NOFIQ® system | | | | |

| 3. Maintenance NOFIQ® BASE | | | | |
|---|-----------------|-----------|------------|-----------------|
| Points of interest | Complied | | | Comments |
| | Yes | No | N/A | |
| Appropriately fastened | | | | |
| Housing intact | | | | |
| General illumination of at least 100 lux and 500 lux at the must | | | | |
| Emergency illumination at least 10 lux | | | | |
| Texts on the NOFIQ® BASE are clearly legible | | | | |
| Acoustic indicators OK | | | | |
| Optical indicators (LEDs) OK | | | | |
| Surroundings clean and dry | | | | |
| Low risk for mechanical damage | | | | |
| Low fire risk | | | | |
| Free space to the front side, enabling rotating parts to be opened completely. | | | | |
| Power supply via separate end group | | | | |
| Primary power supply OK | | | | |
| Secondary power supply OK | | | | |
| Cabling in tubular system and clamped | | | | |
| Internal wiring OK | | | | |
| Connection points OK | | | | |
| Potential-free switch contacts OK | | | | |
| Notification of error messages OK | | | | |
| Notification of alarm messages OK | | | | |
| Setting time-clock OK | | | | |
| Keypad (buttons) NOFIQ® BASE functioning OK | | | | |
| Installed software up-to-date | | | | |
| Group switch identified with warning "DO NOT SWITCH OFF, NOFIQ® fire protection system" | | | | |

| 4. Maintenance NOFIQ® BASE-HUB | | | | |
|---------------------------------------|-----------------|-----------|------------|-----------------|
| Points of interest | Complied | | | Comments |
| | Yes | No | N/A | |
| Appropriately fastened | | | | |
| Housing intact | | | | |
| Cabling in tubular system and clamped | | | | |
| Optical indicators (LEDs) OK | | | | |
| Connection points OK | | | | |

| 5. Maintenance NOFIQ® HUB | | | | |
|----------------------------------|-----------------|-----------|------------|-----------------|
| Points of interest | Complied | | | Comments |
| | Yes | No | N/A | |
| Appropriately fastened | | | | |
| Housing intact | | | | |
| Numbering/address OK | | | | |
| Acoustic indicators OK | | | | |
| Optical indicators (LEDs) OK | | | | |
| Primary power supply OK | | | | |
| Secondary power supply OK | | | | |
| Connection points OK | | | | |

| 6. Maintenance NOFIQ® FE | | | | |
|--|-----------------|-----------|------------|-----------------|
| Points of interest | Complied | | | Comments |
| | Yes | No | N/A | |
| Projection NOFIQ® FE's conformably to BRL K21014 (in development) | | | | |
| Appropriately fastened | | | | |
| Housing intact | | | | |
| Numbering/address OK | | | | |
| Acoustic indicators OK | | | | |
| Optical indicators (LEDs) OK | | | | |
| Primary power supply OK | | | | |
| Secondary power supply OK | | | | |
| Connection points OK | | | | |
| Appropriately fastened | | | | |
| Potential-free switch contact OK | | | | |
| InterNOFIQBus OK | | | | |
| Cabling in tubular system and clamped | | | | |
| Warning sign on outside of protected object "AUTOMATIC FIRE PROTECTION SYSTEM, in case of fire or alarm: do not panic, close cabinet doors object and alert expert assistance" | | | | |

| 6. Maintenance NOFIQ® FE | | | | |
|--------------------------|----------|----|-----|----------|
| Points of interest | Complied | | | Comments |
| | Yes | No | N/A | |
| Antenna - connection OK | | | | |
| Antenna - placement OK | | | | |

| 7. Comments | | |
|---|------|-----------|
| | | |
| Undersigned declares on behalf of the certified NOFIQ® service provider that maintenance on the NOFIQ® system has been carried out according to the directives mentioned above. | | |
| Name | Date | Signature |
| | | |

36.6 Overview status transitions

| | | New status | | | | |
|----------------|-----------------------|--|---|---|-------------------------------------|--|
| | | Safe | Alert | Fire alarm | Extinguishing | Malfunction / Suspend |
| Current status | Safe | | CO $\Delta 20\text{ppm}/60\text{ sec}$ or T $\Delta 2\text{ }^\circ\text{C}/60\text{ sec}$ or T > 50 $^\circ\text{C}$ | T $\Delta 5\text{ }^\circ\text{C}/60\text{ sec}$ or T > 54 $^\circ\text{C}$ or : CO $\Delta 20\text{ppm}/60\text{ sec}$ and T $\Delta 2\text{ }^\circ\text{C}/60\text{ sec}$ | | User presses the FE-button for 2 seconds |
| | Alert | User presses the FE-button briefly | | T $\Delta 5\text{ }^\circ\text{C}/60\text{ sec}$ or T > 54 $^\circ\text{C}$ or : CO $\Delta 20\text{ppm}/60\text{ sec}$ and T $\Delta 2\text{ }^\circ\text{C}/60\text{ sec}$ | | User presses the FE-button for 2 seconds |
| | Fire alarm | | | | 10 seconds after message Fire alarm | User presses the FE-button briefly |
| | Extinguishing | | | | | |
| | Malfunction / Suspend | User presses the FE-button for 2 seconds | | | | |

36.7 Specifications external antenna

The external antenna used for the NOFIQ® BASE-HUB, the NOFIQ® HUB and the NOFIQ® FE has the following specifications

| General | | |
|-----------------------------------|---|--|
| Manufacturer | Hyperlink Technologies | |
| Product | 2.4 GHz 2 dBi External Antenna | |
| Product number | W036485-0001 | |
| | | |
| Electrical characteristics | | |
| Working frequency range | 2400 ~ 2483 MHz | |
| S.W.R. | <= 2,0 | |
| Antenna gain | 2 dBi | |
| Antenna radiation pattern | Omni-directional | |
| Impedance | 50 Ohm | |
| | | |
| Material | | |
| Colour of outer cover | Mat Black | |
| Material of outer cover | ABS | |
| Connector type | 50 Ohm Reverse Polarity SMA Plug Hex | |
| Tube | Copper (C3604) | |
| Total length | 77 mm | |
| | | |
| Environmental | | |
| Operation temperature | -30 °C ~ 60 °C | |
| Storage temperature | -30 °C ~ 60 °C | |

36.8 Specifications FirePro® aerosol extinguishing components

36.8.1 Spec sheet FirePro FP-20

FirePro® Condensed Aerosol generators: FP-20E



FirePro®
Fire extinguishing aerosol system
Designed for volumetric fire extinguishing function. OMT

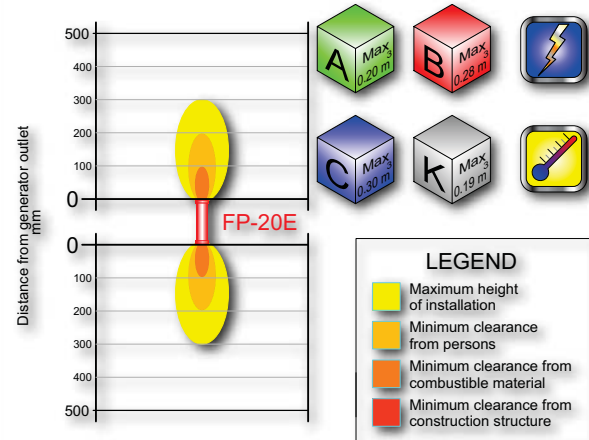

| Technical Data | | | | | | |
|---|---|----------|----------------------------------|--|---|--|
| Mass of SBK (Aerosol Generating Solid Compound) | 20 g | | | | | |
| Generators gross weight | Weight | | Tolerance | | | |
| | 105 g | | ± 5% | | | |
| Activation mode/s | Electrically | | | Thermally | | |
| Value of activation | 6/12/24/36 V D/C 0.8 A 3-4 s | | | 172° C | | |
| SBK activation device | Heating elements with 2.3 Ω Resistance | | | Termocord | | |
| Activation line supervision current (Max) | 5mA | | | | | |
| Aerosol discharge time | Min. | | Max | | | |
| | 3 seconds | | 6 seconds | | | |
| Number of discharge outlet | 2 | | | | | |
| Generator dimension | Height | | | Diameter | | |
| | 128 mm | | | 30 mm | | |
| Self activation temperature of SBK | 300° C | | | | | |
| Classes of Fire (NFPA 2010) | A | B | C | D | K | |
| | ✓ | ✓ | ✓ | NO | ✓ | |
| Usable inside potentially explosive atmosphere | YES | | | | | |
| Maximum height of installation | NA | | | | | |
| Minimum clearance (mm) | From persons | | From combustible material | | From construction structure | |
| | 200 | | 100 | | 0 | |
| Environmental parameters | ODP¹ | | GWP² | | ALT³ | |
| | Zero | | Zero | | Negligible ⁴ | |
| Technical Parameters | Electrical conductivity | | Corrosion | | Oxygen depletion After discharge | |
| | Nil up to 24KV | | Negligible ⁴ | | Negligible ⁴ | |
| Note | 1 ODP: Ozone Depletion Potential | | | 3 ALT: Atmospheric Life Time | | |
| | 2 GWP: Global Warming Potential | | | 4 Within the parameters for use | | |

| | | |
|--|-------------------------------------|-------------------|
| <i>Manufactured by</i> | <i>Master dealers / Distributor</i> | <i>Trade Mark</i> |
| Celanova Ltd. / FirePro Systems Ltd | | FirePro® |

36.8.2 Spec sheet FirePro FP-80

FirePro® Condensed Aerosolo generators: FP-80



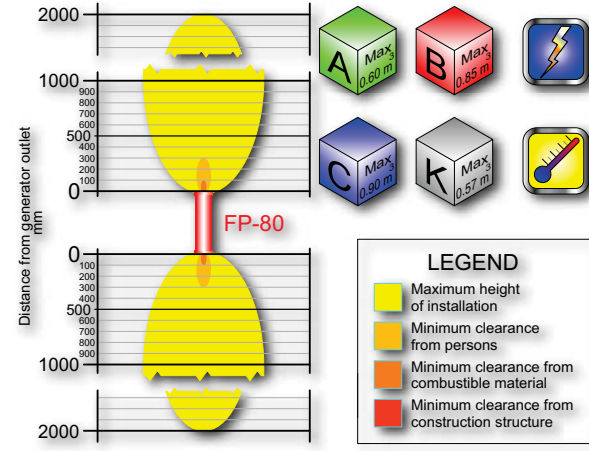

LEGEND

- Maximum height of installation
- Minimum clearance from persons
- Minimum clearance from combustible material
- Minimum clearance from construction structure

| Technical Data | | | | | | |
|---|---|----------|----------------------------------|--|---|--|
| Mass of SBK (Aerosol Generating Solid Compound) | 80 g | | | | | |
| Generators gross weight | Weight | | Tolerance | | | |
| | 800 g | | ± 5% | | | |
| Activation mode/s | Electrically | | | Thermally | | |
| Value of activation | 6/12/24/36 V D/C 0.8 A 3-4 s | | | 172° C | | |
| SBK activation device | Heating elements with 2.3 Ω Resistance | | | Termocord | | |
| Activation line supervision current (Max) | 5mA | | | NA | | |
| Aerosol discharge time | Min. | | Max | | | |
| | 4 seconds | | 8 seconds | | | |
| Number of discharge outlet | 2 | | | | | |
| Generator dimension | Height | | | Diameter | | |
| | 180 mm | | | 50 mm | | |
| Self activation temperature of SBK | 300° C | | | | | |
| Classes of Fire (NFPA 2010) | A | B | C | D | K | |
| | ✓ | ✓ | ✓ | NO | ✓ | |
| Usable inside potentially explosive atmosphere | YES | | | | | |
| Maximum height of installation | NA | | | | | |
| Minimum clearance (mm) | From persons | | From combustible material | | From construction structure | |
| | 300 | | 100 | | 0 | |
| Environmental parameters | ODP¹ | | GWP² | | ALT³ | |
| | Zero | | Zero | | Negligible ⁴ | |
| Technical Parameters | Electrical conductivity | | Corrosion | | Oxygen depletion After discharge | |
| | Nil up to 24KV | | Negligible ⁴ | | Negligible ⁴ | |
| Note | 1 ODP: Ozone Depletion Potential | | | 3 ALT: Atmospheric Life Time | | |
| | 2 GWP: Global Warming Potential | | | 4 Within the parameters for use | | |

Manufactured by

Celanova Ltd. / FirePro Systems Ltd

Master dealers / Distributor

Trade Mark

FirePro®

36.9 FirePro® Material Safety Data Sheet

FirePro Systems Ltd./ Celanova Ltd.

FirePro®



Issue date: 01.01.2007

| 1. Identification of the Substance/Company | |
|--|--|
| 1.1 | Trade name : FirePro® |
| 1.2 | Manufacturer/Supplier : FirePro Systems Ltd./Celanova Limited 6, Koumandarias & Spyrou Araouzou Str., Tonia Court II, 6ht Floor Limassol - 3076 , Cyprus Phone : 00357-25-379999 Fax : 00357-25-354432 e-mail : mail@firepro.info website : www.firepro.info |
| 1.3 | Telephone number in case of emergency: + 357-25-379999 |

| 2. Composition/Information on Ingredients | | | | | |
|---|---------------------|-------|------------|---|------------------------|
| 2.1 | Component | Wt. % | CAS No. | EINECS | Class, R and S phrases |
| | Potassium Nitrate | 77 | 7757-79-1 | 231-818-8 | See section 15 |
| | Potassium Carbonate | 4 | 584-08-7 | 209-529-3 | See section 15 |
| | Magnesium | 1 | 7439-95-4 | 231-104-6 | See section 15 |
| | Epoxy Resin Polymer | 18 | 25068-38-6 | any "polymerizate, polycondensate, or polyadduct" is exempted by 81/437/EEG | See section 15 |

| 3. Hazards Identification | |
|---|--|
| <ul style="list-style-type: none"> - Hazards for humans related to the SBK solid compound has not been found. - Hazards for humans related to the aerosol released by the solid compound have not been established because TLV's are not applicable. - Signs and symptoms related to the aerosol phase are only referred to acute exposure and/or chronic overexposures, while in real life the exposure will be very short (i.e. in the event of an accidental discharge when people were not evacuated on time). | |
| 3.1 | For humans |
| | Threshold Limit Values : None established |
| | Signs and Symptoms by acute exposure |
| | Eye Contact : At normal contact no injury Inhalation : Not a likely route of entry Skin Contact : At normal contact no injury Ingestion : At normal contact no injury Chronic Overexposure : At normal contact no injury Medical Conditions Generally Aggravated by Exposure : None known For Environment : None established |

| 4. First-Aid Measures | |
|--|--|
| First-Aid measures are referred to acute exposure and/or chronic over exposure | |
| 4.1 | Inhalation : Remove from exposure area to fresh air. Eye Contact : If necessary wash eyes. Skin Contact : Change clothing and shoes. Wash skin with soap. Ingestion : Not likely. |

FirePro Systems Ltd./ Celanova Ltd.

FirePro®



Issue date: 01.01.2007

| 5. Fire fighting Measures | | |
|---------------------------|------------------------------------|---|
| 5.1 | Extinguishing Media | : This is an Extinguishing Agent |
| 5.2 | Unusual Fire and Explosion Hazards | : The material does not present an explosion danger. It can be ignited by means of a fire. Hot aerosol is present in the close up area of the outlets |
| 5.3 | Special Procedures | : In places where there is a fire always wear personal protecting equipment and clothing |

| 6. Accidental Release Measures | | |
|--------------------------------|--------------------------|--------------------------------|
| 6.1 Personal Precautions | | |
| | Respiratory Protection | : at normal contact not needed |
| | Hand Protection | : at normal contact not needed |
| | Eye Protection | : at normal contact not needed |
| | Skin and Body Protection | : at normal contact not needed |
| 6.2 Environmental Precautions | | |
| | Waste Disposal Methods | : See section 13 |
| 6.3 | Clean up Precautions | : Sweep up |

| 7. Handling and storage | | |
|-------------------------|----------------------|---|
| 7.1 | Handling Precautions | : Avoid contact with combustible materials. |
| 7.2 | Storage Precautions | : Should be stored in original container. Keep dry. |
| | Storage Class | : 9 miscellaneous , solid |

| 8. Exposure Controls and Personal Protection | | |
|--|--------------------------|--|
| 8.1 | Exposure | : Before entering a room with the material in aerosol phase vent properly to avoid unnecessary exposure. |
| 8.2 Personal protection | | |
| | Respiratory Protection | : at normal contact not needed |
| | Hand Protection | : at normal contact not needed |
| | Eye Protection | : at normal contact not needed |
| | Skin and Body Protection | : at normal contact not needed |

| 9. Physical and Chemical Characteristics | | |
|--|--|------------------|
| 9.1 | Appearance | : Solid |
| | Colour | : Off white |
| | Odour | : None |
| | Relative Density | : Not applicable |
| | Solubility in water | : Insoluble |
| | Ph (if in water, % Conc.) | : Not determined |
| | Boiling Point | : Not applicable |
| | Vapour Pressure (mm Hg) | : Not applicable |
| | Vapour Density | : Not applicable |
| | Flash Point | : Not applicable |
| | Flammability Limits in Air (% by volume) | : Not applicable |
| | Auto Flammability | : Not applicable |
| | Explosive Properties | : Not applicable |
| | Oxidizing Properties | : Not determined |

FirePro Systems Ltd./ Celanova Ltd.

FirePro®



Issue date: 01.01.2007

| | | |
|-------------------------------------|-----------------------------------|--------------------|
| 10. Stability and Reactivity | | |
| 10.1 | Stability | : Stable |
| | Conditions to avoid | : None known |
| 10.2 | Hazardous Reactions | : Will not occur |
| | Conditions to avoid | : None known |
| 10.3 | Materials to Avoid | : None known |
| 10.4 | Hazardous Decompositions Products | : None ascertained |

| | | |
|---|---------------------|---|
| 11. Toxicological Information | | |
| The TLV's (Treshold Limit Values) of the chemicals released in the aerosol phase are applicable only in case of long, as long as a complete professional life, exposure. This is not the case of a real life situation. | | |
| 11.1 | Product | The potential damage is not caused by the product mixture composition, but by the fact that it is respirable. The TLV's apply in case of long exposure, sometimes exposure during a complete professional life, whilst in this case is once only and short (in case of accidental discharge when evacuation does not take place on time). |
| In case of fire the toxicity is caused by the fire itself and the products involved in the fire. | | |
| 11.2 Components | | |
| | Potassium Nitrate | Toxicity : Oral LD ₅₀ (rat) 3750 mg/Kg Target Organs : Blood, central nervous system |
| | Potassium Carbonate | Toxicity : Oral LD ₅₀ (rat) 1870 mg/Kg / Oral LD ₅₀ (mouse) 2570 mg/Kg Target Organs : Respiratory system |
| | Magnesium | Toxicity : Oral LD ₅₀ (dog) 230 mg/Kg Target Organs : Central nervous system, liver, kidneys |
| | Epoxy Resin Polymer | Toxicity : Oral LD ₅₀ (rat) 11.4 g/Kg Irritation Data : Skin (guinea pig) 2750 mg/55 days Inert Eye (rabbit) 100 mg Mild |

| | | |
|-----------------------------------|---|---------------------------------|
| 12. Ecological Information | | |
| 12.1 | Mobility | : with present data no problems |
| | Absorption/Desorption | : with present data no problems |
| 12.2 | Degradability | : with present data no problems |
| | Biotic and Abiotic Degradation | : with present data no problems |
| | Aerobic and Anaerobic Degradation | : with present data no problems |
| | Persistence | : with present data no problems |
| 12.3 | Accumulation | : with present data no problems |
| | Bioaccumulation Potential | : with present data no problems |
| | Biomagnification | : with present data no problems |
| 12.3 | Short and Long Term Effects on | |
| | Ecotoxicity | : with present data no problems |
| | Aquatic Organisms | : with present data no problems |
| | Soil Organisms | : with present data no problems |
| | Plants and Terrestrial animals | : with present data no problems |
| 12.4 | Other Adverse Effects | |
| | Ozone Depleting Potential (ODP) | : none |
| | Photochemical Ozone Creation Potential | : none |
| | Global Warming Potentials (GWP) | : none |
| | Effects on Waste Water Treatment Plants | : with present data no problems |

| | | |
|------------------------------------|--|--|
| 13. Disposal Considerations | | |
| 13.1 | Dispose of in Compliance with local, state and national regulations. | |

FirePro Systems Ltd./ Celanova Ltd.

FirePro®



Issue date: 01.01.2007

| 14. Transportation Information | |
|--------------------------------|---|
| 14.1 Hazard Class or Division | : 9 miscellaneous, solid : For additional transport information contact FirePro Systems Ltd / Celanova Limited |

| 15. Regulatory Information | | | | | | | | | | | | | | | | | | | | | |
|---|---|--|--|--|--|-------------------|---|-------------------------------|--|---------------------|---|---|--|-----------|---|---|---|---------------------|---|--|--|
| <p>For 15.1 Components: The EU classification and R&S phrases, referred to the components of the SBK compound are related only to the single components considered as separate chemical entities. Once mixed in the production of the SBK compound, the risk sentences of the single components are not applicable being the SBK compound a separate chemical entity.</p> | | | | | | | | | | | | | | | | | | | | | |
| 15.1 | <table border="1"> <thead> <tr> <th colspan="4">Product</th> </tr> </thead> <tbody> <tr> <td>Potassium Nitrate</td> <td> EU Classification R Phrases S Phrases </td> <td> Oxidizer 8 16 41 </td> <td> - Contact with combustible material may cause fire Keep away from sources of ignition – No smoking In case of fire and/or explosion, do not breathe fumes </td> </tr> <tr> <td>Potassium Carbonate</td> <td> EU Classification R Phrases S Phrases </td> <td> Irritant 22 36/37/38 26 37/39 </td> <td> - Harmful if swallowed Irritating to eyes, respiratory system and skin In case of contact with eyes, rinse immediately with plenty of water and seek medical advice Wear suitable gloves and eye/face protection </td> </tr> <tr> <td>Magnesium</td> <td> EU Classification R Phrases S Phrases </td> <td> Flammable 15 17 2 43 7/8 </td> <td> - Contact with water liberates highly flammable gases Spontaneously flammable in air Keep out of reach of children In case of fire never use water Keep container tightly closed and dry </td> </tr> <tr> <td>Epoxy Resin Polymer</td> <td> EU Classification R Phrases S Phrases </td> <td> Irritant 36/38 43 53 28 37/39 61 </td> <td> - Irritating to eyes and skin May cause sensitisation by skin contact May cause long-term adverse effects in the aquatic environment In case of contact with skin, rinse with water Wear suitable gloves and eye/face protection Avoid release to the environment. Refer to special instructions/ Safety Data Sheets </td> </tr> </tbody> </table> | Product | | | | Potassium Nitrate | EU Classification R Phrases S Phrases | Oxidizer 8 16 41 | - Contact with combustible material may cause fire Keep away from sources of ignition – No smoking In case of fire and/or explosion, do not breathe fumes | Potassium Carbonate | EU Classification R Phrases S Phrases | Irritant 22 36/37/38 26 37/39 | - Harmful if swallowed Irritating to eyes, respiratory system and skin In case of contact with eyes, rinse immediately with plenty of water and seek medical advice Wear suitable gloves and eye/face protection | Magnesium | EU Classification R Phrases S Phrases | Flammable 15 17 2 43 7/8 | - Contact with water liberates highly flammable gases Spontaneously flammable in air Keep out of reach of children In case of fire never use water Keep container tightly closed and dry | Epoxy Resin Polymer | EU Classification R Phrases S Phrases | Irritant 36/38 43 53 28 37/39 61 | - Irritating to eyes and skin May cause sensitisation by skin contact May cause long-term adverse effects in the aquatic environment In case of contact with skin, rinse with water Wear suitable gloves and eye/face protection Avoid release to the environment. Refer to special instructions/ Safety Data Sheets |
| Product | | | | | | | | | | | | | | | | | | | | | |
| Potassium Nitrate | EU Classification R Phrases S Phrases | Oxidizer 8 16 41 | - Contact with combustible material may cause fire Keep away from sources of ignition – No smoking In case of fire and/or explosion, do not breathe fumes | | | | | | | | | | | | | | | | | | |
| Potassium Carbonate | EU Classification R Phrases S Phrases | Irritant 22 36/37/38 26 37/39 | - Harmful if swallowed Irritating to eyes, respiratory system and skin In case of contact with eyes, rinse immediately with plenty of water and seek medical advice Wear suitable gloves and eye/face protection | | | | | | | | | | | | | | | | | | |
| Magnesium | EU Classification R Phrases S Phrases | Flammable 15 17 2 43 7/8 | - Contact with water liberates highly flammable gases Spontaneously flammable in air Keep out of reach of children In case of fire never use water Keep container tightly closed and dry | | | | | | | | | | | | | | | | | | |
| Epoxy Resin Polymer | EU Classification R Phrases S Phrases | Irritant 36/38 43 53 28 37/39 61 | - Irritating to eyes and skin May cause sensitisation by skin contact May cause long-term adverse effects in the aquatic environment In case of contact with skin, rinse with water Wear suitable gloves and eye/face protection Avoid release to the environment. Refer to special instructions/ Safety Data Sheets | | | | | | | | | | | | | | | | | | |

FirePro Systems Ltd./ Celanova Ltd.

FirePro®



Issue date: 01.01.2007

| | |
|-----------------------------------|--|
| Limit Values for Exposure | : None listed |
| EINECS Status | : All components are included in EINECS inventories |
| Restrictions on Marketing and Use | : None (Refer to any other national measures that may be relevant) |

| |
|------------------------------|
| 16. Other Information |
| 16.1 None Known |

| |
|---|
| 17. Disclaimer |
| 17.1 The data in the above material safety data sheet reflect the current state of knowledge of our product and shall be used only as a guideline. No binding statements as to the contractually agreed product characteristics may be inferred there from. |

36.10 Regulatory information radio communication

For sending information between the different elements the NOFIQ® system uses wireless radio communication.

The NOFIQ® system uses the IEEE 802.15.4 standard on a frequency of 2.4 GHz. This frequency is part of the ISM band (Industry, Scientific and Medical), which is freely available in Europe for alarm purposes.

The system is classified as a **2.4 GHz wireless fire-extinguishing system for indoor use** and is aimed for use in the following countries:

EU members Belgium, Bulgaria, Cyprus, Denmark, Germany, Estonia, Finland, France, Greece, Hungary, Ireland, Italy, Latvia, Lithuania, Luxembourg, Malta, Netherlands, Austria, Poland, Portugal, Romania, Slovenia, Slovak Republic, Spain, Czech Republic, United Kingdom, Sweden

EFTA members Liechtenstein, Norway, Iceland, Switzerland

FCC

FCC-ID and label can be found in the battery compartment of the NOFIQ N20-BASE_HUB, N20-HUB, N20-FE and N80-FE.

Compliance statement (part 15.19)

This device complies with Part 15 of the FCC Rules. Operation is subject to the following conditions:

1. this device may not cause harmful interference, and
2. this device must accept any interference received, including interference that may cause undesired operation

Warning (part 15.21)

Changes or modifications not expressly approved by the party responsible for compliance could void the user's authority to operate the equipment. This in particular is applicable for the antenna which has been delivered with this device.

RF Exposure (OET Bulletin 65)

To comply with FCC RF exposure requirements for mobile transmitting devices, this transmitter should only be used or installed at locations where there is at least 20cm separation distance between the antenna and all persons

Information to the User (part 15.105 (b))

Note: This equipment has been tested and found to comply with the limits for a Class B digital device, pursuant to part 15 of the FCC Rules. These limits are designed to provide reasonable protection against harmful interference in a residential installation. This equipment generates, uses and can radiate radio frequency energy and, if not installed and used in accordance with the instructions, may cause harmful interference to radio communications. However, there is no guarantee that interference will not occur in a particular installation. If this equipment does cause harmful interference to radio or television reception, which can be determined by turning the equipment off and on, the user is encouraged to try to correct the interference by one or more of the following measures:

- Reorient or relocate the receiving antenna.
- Increase the separation between the equipment and receiver.
- Connect the equipment into an outlet on a circuit different from that to which the receiver is connected.
- Consult the dealer or an experienced radio/TV technician for help.

Copyright ©2009 NOFIQ® Systems BV - All rights reserved.

Nothing from this publication may be duplicated and/or published by means of print, photocopy, microfilm or otherwise without prior written consent of the publisher.

Although the utmost care has been taken with this publication, errors and omissions cannot be entirely excluded. The composers and/or publishers of this publication therefore accept no liability, not even for direct or indirect damage, occurring due to or in relation with any mistake that could occur in this publication.