



COP510

**Vintage Collection™**

**Old Fashioned Movie Time Popcorn Cart™**

Instructions and Recipes

# CONTENTS

IMPORTANT PRECAUTIONS . . . . .	3
IMPORTANT SAFEGUARDS . . . . .	3
INTRODUCTION . . . . .	4
PARTS & ASSEMBLY . . . . .	5
HOW TO OPERATE . . . . .	9
HELPFUL TIPS . . . . .	10
CLEANING & MAINTENANCE . . . . .	10
RECIPES . . . . .	11
RETURNS & WARRANTY . . . . .	13

# SAFETY

Your safety and the safety of others are very important.

We have provided many important safety messages in this manual and on your appliance. Always read and obey all safety messages.



This is the safety alert symbol.

This symbol alerts you to potential hazards that can kill or hurt you and others.

All safety messages will follow the safety alert symbol.

All safety messages will tell you what the potential hazard is, tell you how to reduce the chance of injury, and tell you what can happen if the instructions are not followed.

## Appliance Specifications:

120 Volts, 60 Hz  
640 Watts, ETL Approved

## IMPORTANT PRECAUTIONS

1. NEVER immerse in water.
2. NEVER use near water.
3. NEVER use an abrasive sponge nor cloth.
4. NEVER use a scouring pad on the appliance.
5. NEVER leave appliance unattended while in use.
6. NEVER force Kettle in or out of the brackets as this may cause gears to become misaligned and appliance will not operate properly.
7. Unplug unit from outlet when not in use and during cleaning.
8. DO NOT operate this appliance with a damaged cord or plug, nor if the appliance ever malfunctions.
9. DO NOT clean any parts of this appliance in a dishwasher.
10. Keep out of reach of children.
11. This appliance is NOT A TOY.
12. Unsupervised young children and cognitively challenged individuals should never operate this appliance.
13. Young children should be supervised while in proximity of the appliance to ensure their safety.

## IMPORTANT SAFEGUARDS

Basic safety precautions should always be followed when using electrical appliances, including the following:

1. Read all instructions before operating this appliance.
2. Keep door of Main Unit closed while operating. Do not touch Kettle while operating; it gets very HOT.
3. To protect against electrical shock do not immerse cord, plug or any part of this appliance in water or other liquids.
4. Close supervision is necessary when any appliance is used near children.
5. Unplug from outlet when not in use, before removing parts and before cleaning.
6. DO NOT operate any appliance with a damaged cord or plug, nor if the appliance has been damaged in any manner. Return the appliance to the nearest repair shop for examination or repair.
7. The manufacturer does not recommend the use of accessory attachments. Use of accessory attachments may cause injuries.
8. DO NOT use outdoors.
9. Position the appliance as close to the outlet as possible to prevent injury due to tripping over cord.
10. DO NOT leave Kettle motor running once popping has ceased.

11. Extreme caution must be used when moving this appliance.
12. **DO NOT** use the appliance for other than its intended use.
13. An appliance that is plugged into an outlet should not be left unattended.
14. Check Kettle for presence of foreign objects prior to use.
15. Make sure the Kettle is properly attached to brackets before operating and that the motor plug is plugged into the Kettle.
16. A short power supply cord is provided to reduce the risk resulting from becoming entangled or tripping over a long cord.
17. Longer detachable power supply cords can be used if care is exercised in their use.
18. The marked electrical rating of an extension cord should be at least as great as the electrical rating of the appliance.
19. This appliance has a polarized plug (one blade is wider than the other). To reduce the risk of electrical shock, this plug is intended to fit into a polarized outlet only one way.

**20. Save these instructions!**

## INTRODUCTION

Thank you for purchasing the OLD FASHIONED MOVIE TIME POPCORN CART™, a product in Nostalgia Electrics' Vintage Series™. This 53" tall vendor-style popcorn cart will be the hit of every party. It pops up to 16 cups of hot, fresh, kettle cooked popcorn per batch. Providing a vintage look and feel, reminiscent of silent movie houses and carnivals circa-early 1900s, the OLD FASHIONED MOVIE TIME POPCORN CART™ is designed for both home and commercial use. It features a large, stainless steel kettle with a built-in stirring system and kernel catcher to keep unpopped kernels out of each perfect batch. There is a compartment in the base of the unit to store supplies, making it easy to keep the cart well stocked and organized. The OLD FASHIONED MOVIE TIME POPCORN CART™ has an easy-to-clean design. Its accessible height makes serving a snap.

# PARTS & ASSEMBLY

## Hardware

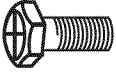

---

#1 Screw (10mm)  
Qty. 4

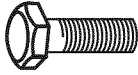

#2 Bolt (10mm)  
Qty. 6

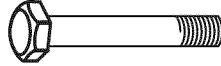

#3 Bolt (60mm)  
Qty. 4



---

#4 Flat Washer  
Qty. 14



#5 Nut Cap  
Qty. 6

**Assembly**

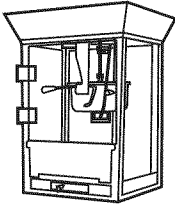

(A) Main Unit

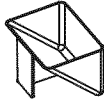

(B) Kernel Measuring Cup

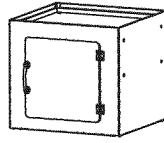

(C) Storage Compartment



(D) Oil Measuring Spoon (1 tbsp.)

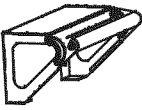

(E) Push Handle

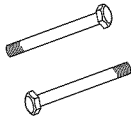

(F) Axle Bolts

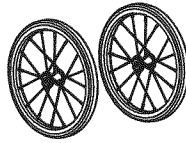

(G) Wheel

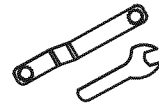

(H) Wrenches

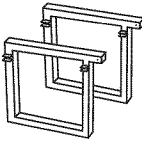

(I) Base Support



(J) Cross Bar

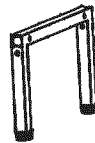

(K) Leg Assembly



(L) Popcorn Scoop

## Assembly of Base Support

1. Push Handle (E) attaches onto the Storage Compartment (C) using all of the supplied #1 Screws.

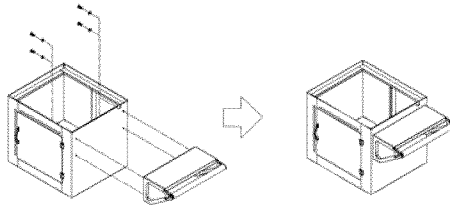

2. Insert Cross Bar (J) into the square inserts on the inside of Base Support (I) and secure from below with two #2 Bolts and two #4 Flat Washers. Insert the Leg Assembly (K) over the protruding ends of the Base Support (I) and fasten four #3 Bolts and four #4 Flat Washers and four #5 Nut Caps.

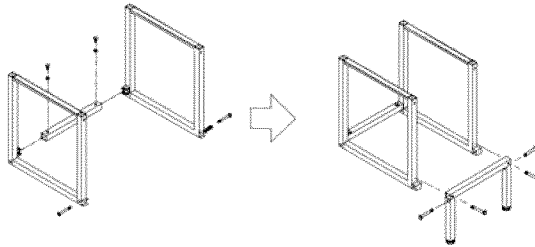

3. Assemble Base Support (I) into the bottom of the Storage Compartment (C) and secure with four #2 Bolts and four #4 Flat Washers.

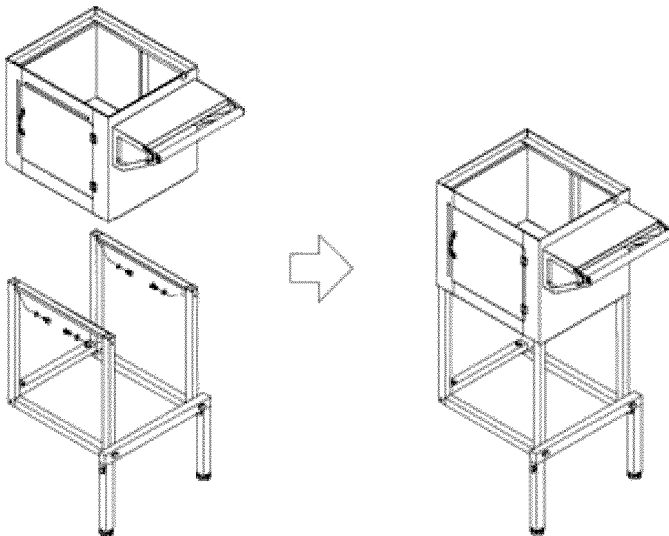

### Assembly of Wheels

1. Insert Axle Bolt (F) into Base Support (I).
2. Put on #4 Flat Washer. Slide Wheel (G) into Axle Bolt (F) and add a second #4 Flat Washer.
3. Use Wrench (H) to tighten the #6 Nut Cup.
4. Add #4 Flat Washer, second Wheel (G), another #5 Flat Washer, and #5 Nut Cap to the other side of the Axle Bolt (F), following the directions above.
5. Use Wrench (H) to tighten the #5 Nut Cap.

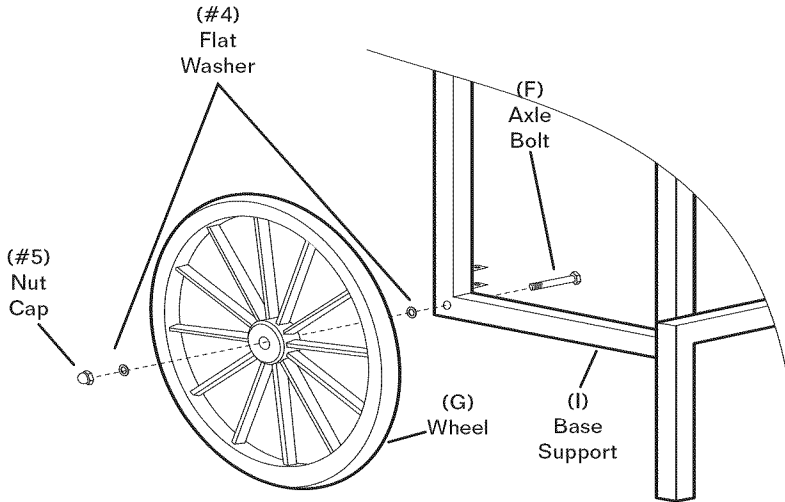

### Assembly of Main Unit

1. Place Main Unit (A) onto the top of the Storage Compartment (C).
2. Ensure that the two inserting pins at the bottom of the Main Unit (A) line up correctly so that Main Unit (A) can be locked under the beam of the Storage Compartment (C).

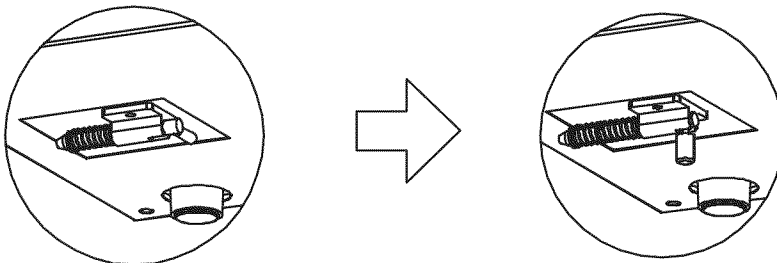



## HOW TO OPERATE

Before first use, clean the inside of the unit by wiping with a moist, non-abrasive sponge, towel or cloth and then wipe with a non-abrasive dry towel. Wipe down the inside of the Kettle and be sure it is properly placed in the brackets before starting.

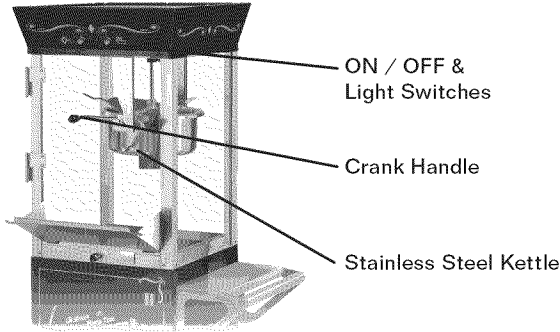

1. First, find a flat surface near an electrical outlet before starting. Make sure your cord is away from any water source. It is acceptable to use an extension cord if needed.
2. Gather your popcorn making supplies: popcorn, seasonings, bowls or bags for holding the popcorn, cooking oil, Kernel Measuring Cup and Oil Measuring Spoon. (Kernel Measuring Cup and Oil Measuring Spoon are included with your unit).
3. Make sure Kettle is properly secured in support brackets.
4. Make sure Kettle motor is plugged in.
5. Plug in the appliance while switch is flipped to OFF position.
6. Turn appliance ON by flipping the switch on the top of the machine (see illustration above for location of switches). Allow the appliance to run 3-5 minutes to heat up Kettle.
7. Once Kettle has heated, turn unit OFF before adding ingredients.
8. Use the Oil Measuring Spoon supplied with your OLD FASHIONED MOVIE TIME POPCORN CART™ to add 2 tablespoons of your favorite popcorn cooking oil to the Kettle. For every Measuring Cup full of kernels (4 oz.), add 2 spoonfuls (2 tbsp.) of oil. For best results, light vegetable oil is recommended.
9. Add 4 ounces of popcorn kernels to the Kettle using supplied Kernel Measuring Cup.
10. Close the door and turn unit ON. In no time at all, you will hear the popping begin. Fresh, hot popcorn will begin to burst out of the flip lids on the Kettle - just like at the theater!

## HELPFUL TIPS

### SMOKING

If your OLD FASHIONED MOVIE TIME POPCORN CART™ begins to smoke during cooking, it may be due to grease build up. In order to reduce smoking, make sure that you clean the inside of the Kettle between uses.

## CLEANING & MAINTENANCE

1. Make sure appliance is unplugged before cleaning. Unplug the outer plug to the outlet as well as the Kettle motor plug inside the Main Unit.
2. Use slightly damp, non-abrasive sponge, towel or cloth to wipe down the inside and outside of Main Unit, then wipe with a non-abrasive towel to dry.
3. Unplug Kettle motor and remove Kettle from support brackets.
4. Take Kettle out of the Main Unit. After removing Kettle from Main Unit, fill  $\frac{2}{3}$  of Kettle with hot, soapy water.
5. Let the Kettle sit for 15 – 20 minutes to cut the grease. (time may vary – use your own judgment depending on the amount of cleaning necessary)
6. Empty water. If necessary, use the scrubber side of a cleaning sponge to scrub inside of Kettle.
7. Rinse inside carefully and dry.
8. Wipe outside of Kettle with damp cloth and dry.

**NOTE:** To protect the motor plug from getting wet, **never immerse the Kettle in any liquid.** Never place any parts in the dishwasher. Always wash by hand.

## RECIPES

The OLD FASHIONED MOVIE TIME POPCORN CART™ makes hot, fresh, theater style popcorn anytime! Enjoy your freshly popped corn in a variety of ways:

- Regular theater style popcorn – add butter and salt.
- Add a pinch of sugar and salt to popcorn for a sweet kettle corn taste.
- Flavored popcorn – add seasoning from any gourmet popcorn seasoning kit.
- Try some of these fun recipes:

### PARMESEAN POPCORN

- 1 Gallon of Popped Corn  
Pop corn kernels using the OLD FASHIONED MOVIE TIME POPCORN CART™ as directed on page 9.
- 1 Tsp Garlic Powder  
Combine garlic powder, green onions, cracked pepper, sea salt and parmesan cheese. Set aside.
- 3 Green Onions, finely chopped  
In a large mixing bowl, drizzle hot olive oil over popcorn.
- ½ Tsp Cracked Pepper  
Toss until well coated.
- 1 Tsp Sea Salt  
Slowly add in dry ingredients while continuously stirring popcorn until well coated.
- 1 Cup Parmesean Cheese, grated (more or less to taste)  
You may also shake the dry ingredients over popcorn in a large paper or muslin bag.
- 3 Tbsps Olive Oil, heated

### TRADITIONAL POPCORN BALLS

- ½ Cup Popcorn  
Pop corn kernels using the OLD FASHIONED MOVIE TIME POPCORN CART™ as directed on page 9.
- ½ Cup Corn Syrup  
Mix corn syrup, sugar and salt together in pot and dissolve over medium heat for about 3 minutes.
- ½ Cup Granulated Sugar
- ½ Teaspoon Salt  
Add popcorn to pot, stirring and tossing consistently until popcorn is evenly coated at low heat.
- 1 Stick of Butter, softened  
Remove from heat.  
Use softened butter to form balls while popcorn mixture is still warm.  
Wrap individual balls in plastic wrap, tie and store at room temperature.

**CHUNKY MONKEY**

- 1 Gallon Popcorn  
Pop corn kernels using the OLD FASHIONED MOVIE TIME POPCORN CART™ as directed on page 9.
- 1 12-oz bag Semi-Sweet Chocolate Chips  
Melt chocolate chips and peanut butter morsels over stove, as packaging recommends.
- 1 12-oz bag Peanut Butter Morsels  
Line cookie sheet with wax paper.
- 4.2 oz bag Banana Chips, broken into small pieces  
Toss together popcorn and banana chips.
- 11-oz bag Peanuts  
Spread popcorn and banana chip mixture evenly over cookie sheet.  
Drizzle melted chocolate and peanut butter mixture over popcorn and banana chips.  
Sprinkle peanuts over chocolate and peanut butter mixture.  
Allow to cool.  
When chocolate and peanut butter has hardened, break up the Chunky Monkey into pieces.  
Can be stored in plastic freezer bags.

**POPCORN PEPPERMINT BARK**

- 1 Gallon Popped Corn  
Pop corn kernels using the OLD FASHIONED MOVIE TIME POPCORN CART™ as directed on page 9.
- 1 12-oz bag Semi-Sweet or Dark Chocolate Chips  
Melt chocolate chips over stove, as packaging recommends.
- 1¼ cup Peppermint Sticks, crushed  
Line cookie sheet with wax paper.  
Spread popcorn evenly over cookie sheet.  
Drizzle melted chocolate over popcorn.  
Sprinkle crushed peppermints over chocolate.  
Allow to cool.  
When chocolate has hardened, break up Popcorn Peppermint Bark into pieces.  
Can be stored in plastic freezer bags.

## RETURNS & WARRANTY

SHOULD YOUR UNIT NOT WORK OR IS DAMAGED WHEN YOU FIRST TAKE IT OUT OF THE BOX, PLEASE RETURN IT TO THE PLACE OF PURCHASE IMMEDIATELY.

### **OLD FASHIONED MOVIE TIME POPCORN CART™ / CCP510**

Should you have any questions, please contact us via email or at the customer service number listed below between the hours of 8:00 AM and 5:00 PM, Monday through Friday, Central Standard Time.

#### **Distributed by:**

Nostalgia Products Group LLC  
1471 Partnership Dr.  
Green Bay, WI 54304-5685  
Customer Service  
Phone: (920) 347-9122  
Web: [www.nostalgiaelectrics.com](http://www.nostalgiaelectrics.com)

#### **Customer Service Inquiry**

To submit a Customer Service inquiry, go to [www.nostalgiaelectrics.com](http://www.nostalgiaelectrics.com) and fill out the Customer Service Inquiry form and click the Submit button.

A representative will contact you as soon as possible.

This appliance is designed and built to provide many years of satisfactory performance under normal household use. The distributor pledges to the original owner that should there be any defects in material or workmanship during the first 90 days of purchase, we will repair or replace the unit at our option. Our pledge does not apply to damages caused by shipping, mishandling or unit being dropped. A product deemed defective either from manufacturing or being mishandled is up to the distributor's discretion. In order to obtain service under this warranty, please contact Nostalgia Products Group, LLC at the telephone number listed above or by filling out the Customer Service Inquiry Form located at [www.nostalgiaelectrics.com](http://www.nostalgiaelectrics.com).

#### **This warranty does not apply to re-manufactured merchandise.**

Please read these instructions carefully. Failure to comply with these instructions, damages caused by improper replacement parts, abuse or misuse will void this pledge to you and is being made in place of all other expressed warranties.



All products are trademarks of Nostalgia Products Group, LLC.  
Worldwide design & utility patented or patents pending.  
© 2009 Nostalgia Products Group, LLC.

[www.nostalgiaelectrics.com](http://www.nostalgiaelectrics.com)

(rev. 12/21/09)