

# ABOUT SHIELD PORTABLE

Thank you for choosing the NVIDIA SHIELD portable. SHIELD portable lets you:

- **Enjoy Android in high-res.** Built on Android TV, SHIELD portable delivers 4K entertainment, including video, music, apps and more on a stunning 5.66-inch 1440x810 high-definition display.
- **Play next-gen Android games.** SHIELD is powered by our new Tegra X1 chip and lets you enjoy hundreds of SHIELD-optimized games and exclusive titles like *Crysis 3*, *Doom 3: BFG*, and *Borderlands: TPS*.
- **Access a GeForce GTX supercomputer in the cloud.** SHIELD is the gateway to SHIELD X, giving access to both a subscription service loaded with favorite AAA titles and the ability to download new top titles - all at a resolution up to 1080p, at 60 frames per second, with very low latency.

# IN THE BOX

SHIELD portable comes with the following:

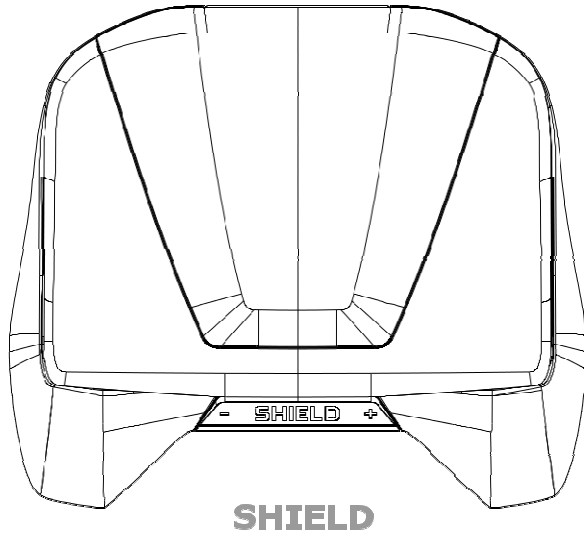

Adapter



USB Cable

A Quick Start guide and Warranty, Safety and Regulatory booklet are also included.

# CHARGING YOUR SHIELD PORTABLE

To charge your SHIELD portable, connect the included USB Cable to the micro-USB port on the back of the device. Connect the USB end to the adapter and plug the adapter into a wall outlet.

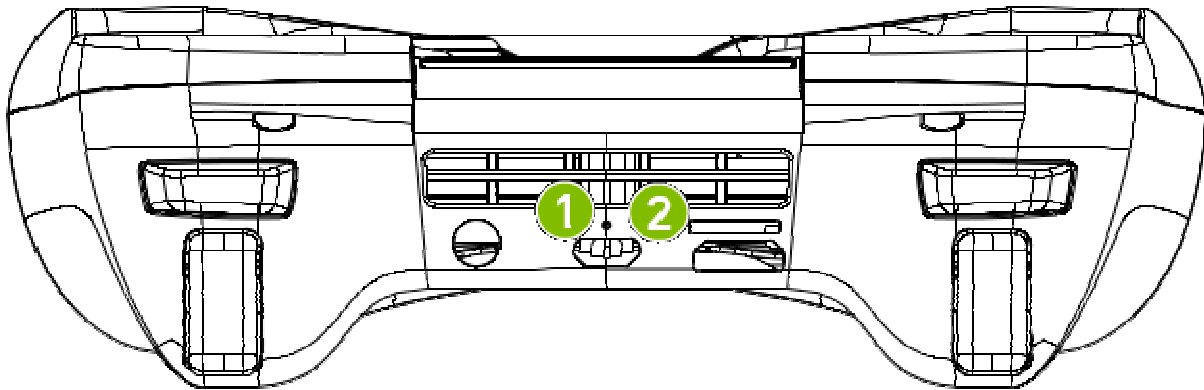

**1** Charge Indicator LED

**2** Micro-USB

- **Amber:** Charging

- **Green:** Charged





**TIP** For fastest charging time, NVIDIA recommends using the intended USB Cable and AC Adapter plugged into a wall outlet.

The SHIELD portable can also be charged by connecting the USB connector into a computer rather than into the AC adapter. However, it will charge faster connected to a wall outlet.



# GET STARTED



Press the NVIDIA Button  to power on the SHIELD portable. The SHIELD portable device tutorial walks you through a series of screens explaining basic button functions and overview functions. Use the  button to go through the SHIELD Welcome screens.

During the SHIELD welcome, you will be asked to accept NVIDIA Software License Agreement, Privacy Policy, and Tegra Experience Terms of Service legal information. To review the legal terms of service, go to: **Settings > About > Legal information > View Terms of Service**.

Once finished with the SHIELD Welcome, the Android TV Setup begins.



**NOTE:** It is a good practice to check for software updates even when you first purchase your SHIELD portable. Go to **Settings > About > System update** to download the latest software.

Upon completion of the SHIELD Welcome, you enter the standard Android TV setup process. During this process, you will configure the Android TV portion of the SHIELD portable device by setting up email account(s), configuring Wi-Fi access, and other functions.







The first screen displayed asks you to choose a language. If it is on your language, select **Start** to begin the setup. Otherwise, select your language from the list and then select **Start**. A series of screens takes you through the setup process. If you already have Gmail, use your Gmail address and password when asked. If you do not have Gmail or any other Google Account, you can create one during setup. As you go through the setup screens, you have the option to skip some steps. To set up options you skipped, or for more information, see **Settings**.

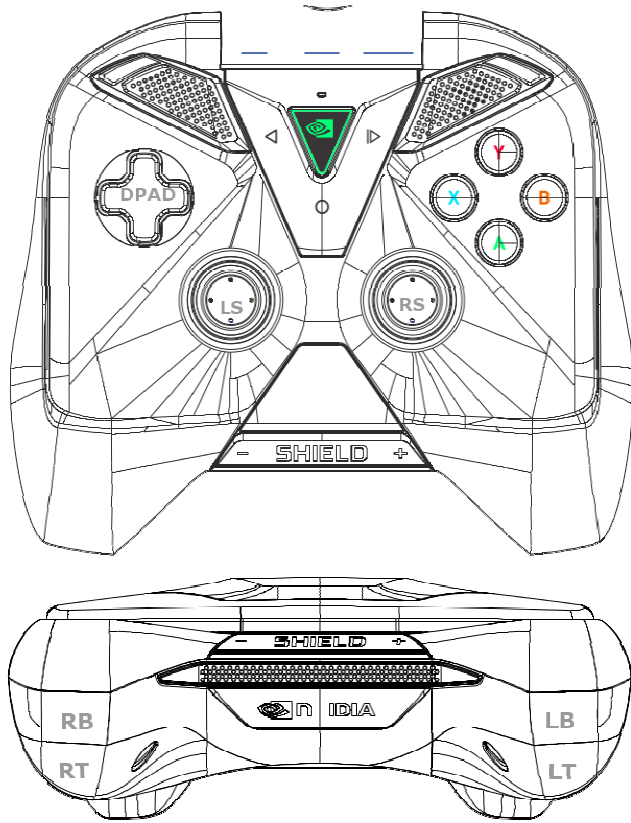









# NAVIGATING SHIELD PORTABLE

To navigate through the menus and apps use the following SHIELD portable game controls.



	<b>NVIDIA Button.</b> Turns SHIELD device ON, displays power menu to turn device OFF, put SHIELD to sleep, go to Airplane mode, or connect to a TV via Miracast.
	<b>Home Button.</b> Opens the Android Home screen. Double Press to view icons of Recent Apps. Long Press to open Google Now.
	<b>Start Button.</b>
	<b>Volume Rocker.</b> Press -/+ to decrease/increase volume. Long-press the - button to mute.
	<b>Back.</b> Jumps to the previous screen or activity.
	<b>A Button.</b> Activates the selected item in most apps.
	<b>B Button.</b> Back or cancel in most apps.

	X Button
	Y Button. Opens menu in most apps.
	Left Stick
	Right Stick
	D-Pad
	Left Bumper
	Left Trigger
	Right Bumper
	Right Trigger

## Advanced Functions

**Boot Up:** Press the NVIDIA  button when the device is powered off to boot the device.

**Boot Menu:** Hold down Volume - and , then press .

**Power Menu:** Long hold .

**Power Off:** Long hold (6 seconds)  to power off device.

**Share:** Press .

**Home:** Press  to open Android home.



# USING A HEADSET

SHIELD portable has a connection on the back of the device to plug in headphones/headset (with microphone) or speakers. The SHIELD portable also supports Bluetooth headphones/headset and speaker devices.

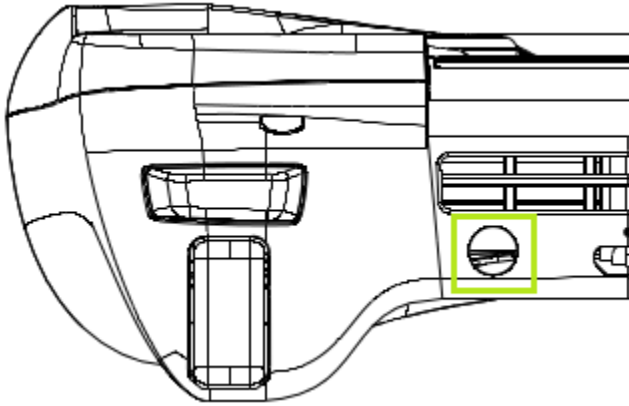

To connect Bluetooth devices, go to **Settings** ➤ **SHIELD accessories** ➤ **Connect accessory** and pair the device to the SHIELD portable.

## HOW TO USE A MICRO SD CARD

SD Cards are small memory cards that you can read, write, and delete data on. They are available in three sizes: standard SD, mini SD, and micro SD (or *microSD*). SHIELD portable has a slot on the back of the device for a *microSD* card. The card can be loaded with music, pictures, and videos as well as game and app files to free-up space on the SHIELD portable internal storage drive.

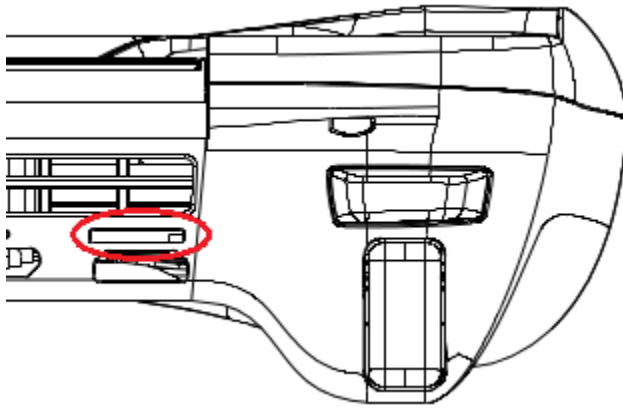

- **32GB (or less) *microSD* cards** - SHIELD portable supports FAT32 data format. Most *microSD* cards that are 32 GB or less are already formatted as FAT32. If the memory card is not formatted, format to FAT32, using your PC or Mac computer.
- **64GB (or higher) *microSD* cards** - Android does not support the exFAT file system out-of-the-box. Because the standard FAT32 file system does NOT support partitions greater than 32 GB by default, 64 GB cards come pre-formatted as exFAT. If you want to use a 64 GB *microSD* with SHIELD portable, it has to be converted to a file system format that is supported by stock Android, which in this case is NTFS. Format the 64 GB *microSD* card to NTFS using your PC or Mac computer.

## How to Move Data to SD Card

- **Games and Apps**
- Go to **Settings** ➔ **Apps**
- Select an App/Game to be moved
- Select **Move App To SDCard**
- Select **OK** to move the game/app.



The ability to move data to the SD card is dependent on the selected app or game. Only apps/games that the developers have opted in as *moveable to external storage* can be moved.

## SHIELD SETTINGS

SHIELD will automatically go to sleep after 30 minutes of inactivity. To change this default, go to Settings > Device > Display > Daydream > When to sleep.

To immediately put SHIELD to sleep, tap the NVIDIA Button on SHIELD.

To wake SHIELD, tap the NVIDIA Button on SHIELD or tap the NVIDIA Button on SHIELD controller.

In certain situations, you may need to restart SHIELD.

To restart:

1. Hold the NVIDIA Button on SHIELD for 9 seconds.
2. Tap the NVIDIA button to turn SHIELD back on.

## SAFETY INFORMATION

NVIDIA products are designed to operate safely when installed and used according to the product instructions and general safety practices. The guidelines included in this document explain the potential risks associated with equipment operation and provide important safety practices designed to minimize these risks. By carefully following the information contained in this document, you can protect yourself from hazards and create a safer environment.

This product is designed and tested to meet IEC 60950-1, the Standard for Safety of Information Technology Equipment. This also covers the national implementation of IEC 60950-1 based safety standards around the world e.g. UL 60950-1. These standards reduce the risk of injury from the following hazards:

- > Electric shock: Hazardous voltage levels contained in parts of the product
- > Fire: Overload, temperature, material flammability
- > Mechanical: Sharp edges, moving parts, instability
- > Energy: Circuits with high energy levels (240 volt amperes) or potential as burn hazards
- > Heat: Accessible parts of the product at high temperatures
- > Chemical: Chemical fumes and vapors
  
- > Radiation: Noise, ionizing, laser, ultrasonic waves

Retain and follow all product safety and operating instructions. Always refer to the documentation supplied with your equipment. Observe all warnings on the product and in the operating instructions.

**Note:** Read all safety information below and operating instructions before using NVIDIA® SHIELD™ to avoid injury.



**WARNING:** FAILURE TO FOLLOW THESE SAFETY INSTRUCTIONS COULD RESULT IN FIRE, ELECTRIC SHOCK OR OTHER INJURY OR DAMAGE. ELECTRICAL EQUIPMENT CAN BE HAZARDOUS IF MISUSED. OPERATION OF THIS PRODUCT, OR SIMILAR PRODUCTS, MUST ALWAYS BE SUPERVISED BY AN ADULT. DO NOT ALLOW CHILDREN ACCESS TO THE INTERIOR OF ANY ELECTRICAL PRODUCT AND DO NOT PERMIT THEM TO HANDLE ANY CABLES.

## SYMBOLS ON EQUIPMENT



This is a universal recycling symbol. A product marked with this symbol can be recycled if the regulations and/or ordinances of the local community provide for its collection.



This is a universal recycling symbol indicating that the battery cannot be disposed of in the trash and must be recycled according to the regulations and/or ordinances of the local

community.

To reduce the risk of electric shock, personal injury, or damage to the equipment, observe the following precautions:

- > Follow all cautions and instructions marked on the equipment.
- > Do not bend, drop, crush, puncture, incinerate, or push objects into openings of SHIELD™.
- > Do not connect or disconnect any cables or perform maintenance or reconfiguration of this product during an electrical storm.
- > Do not use SHIELD™ in rain or near sink, or other wet locations. Take care not to spill any food or liquid into the device. In case SHIELD™ gets wet, unplug all cables and turn off before cleaning, and allow it to dry thoroughly before turning it on again.
- > Do not expose SHIELD™ to any gas which is not normally contained in the atmosphere, it may cause defects.
- > Never turn on any equipment when there is evidence of fire, water, or structural damage.
- > Place the product away from radiators, heat registers, stoves, amplifiers, or other appliances that produce heat.
- > Never force a connector into a port. Check for obstructions on the port. If the connector and port don't join with reasonable ease, they probably don't match. Make sure that the connector matches the port and that you have positioned the connector correctly in relation to the port.
- > Always use an NVIDIA approved power adapter and refer to the manufacturer's instructions or equipment manual for proper instructions. Do not connect or disconnect the AC Power Adapter with wet hands. The power adapter is intended for indoor use only.
- > Operate the AC adapter in a ventilated area.
- > When you are using SHIELD™ or charging the battery, it is normal for the system and/or AC power adapter to get warm. Always unplug *SHIELD Portable* when fully charged to save unnecessary power consumption.
- > Do not use conductive tools that could bridge live parts.
- > Do not make mechanical or electrical modifications to the equipment.
- > Never attempt to repair SHIELD™ yourself. This device does not contain any user-serviceable parts. Do not attempt to open, disassemble, or remove the battery. You run the risk of electric shock.
- > *SHIELD portable*: To clean the display, use a soft, lint-free cloth. If necessary, breathe upon the display surface and wipe off immediately and softly. Avoid getting moisture in openings. Don't use window cleaners, household cleaners, aerosol sprays, solvents, alcohol, ammonia, or abrasives to clean the display.
- > Operate SHIELD™ in a place where the temperature is always between 5 and 30°C (41 to 86°F).
- > Store SHIELD™ in a place where the temperature is always between 0 and 35°C (32 to 95°F) with a relative humidity of 70% or lower. When taking the device from a low temperature condition, allow the device to reach room temperature before turning the power on.
- > Use this product only with approved equipment and/or accessories

> If the product sustains damage requiring service, disconnect the product from the AC electrical outlet and refer servicing to an NVIDIA authorized service provider.

### HEADSET/EARPHONE VOLUME LEVEL NOTICE



**WARNING:** TO PREVENT POSSIBLE HEARING DAMAGE, DO NOT LISTEN AT HIGH VOLUME LEVELS FOR LONG PERIODS.

### LITHIUM BATTERY NOTICE



**WARNING:** SHIELD portable, SHIELD remote, and SHIELD controller CONTAIN A NON-USERSERVICEABLE LITHIUM-ION BATTERY PACK. THERE IS RISK OF EXPLOSION, FIRE, BURN OR LEAKING WHICH CAN BE CAUSED BY IMPROPER CHARGING, SHORTING OF THE BATTERY PACK, CRUSH DAMAGE OR OTHER MISUSE. ALWAYS USE CHARGERS DESIGNED SPECIFICALLY FOR USE WITH THIS DEVICE. DO NOT ATTEMPT TO DISASSEMBLE, REPLACE, OR OTHERWISE ATTEMPT TO ACCESS THE BATTERY PACK. CONTACT CUSTOMER SUPPORT FOR REPAIR OR REPLACEMENT INFORMATION. RECYCLE THE DEVICE ACCORDING TO LOCAL RULES AND REGULATIONS. CONTACT YOUR LOCAL WASTE DISPOSAL/RECYCLE FACILITY.

### POWER RATING

**SHIELD portable (P2523)**

5-16 VDC, 2 A

# COMPLIANCE

The NVIDIA SHIELD Portable is compliant with the regulations listed in this section. Compliance marks, including the FCC and IC ID numbers, can be found on SHIELD Portable by go to Settings > About > Regulatory Information

## UNITED STATES

Federal Communications Commission (FCC)



**FCC ID: VOB-P2523**

This device complies with part 15 of the FCC Rules. Operation is subject to the following two conditions: (1) this device may not cause harmful interference, and (2) this device must accept any interference received, including any interference that may cause undesired operation of the device.

This equipment has been tested and found to comply with the limits for a Class B digital device, pursuant to Part 15 of the FCC Rules. These limits are designed to provide reasonable protection against harmful interference in a residential installation. This equipment generates, uses and can radiate radio frequency energy and, if not installed and used in accordance with the instructions, may cause harmful interference to radio communications. However, there is no guarantee that interference will not occur in a particular installation.

If this equipment does cause harmful interference to radio or television reception, which can be determined by turning the equipment off and on, the user is encouraged to try to correct the interference by one or more of the following measures:

- Reorient or relocate the receiving antenna.
- Increase the separation between the equipment and receiver.
- Connect the equipment into an outlet on a circuit different from that to which the receiver is connected.
- Consult the dealer or an experienced radio/TV technician for help.

**FCC Warning:** The FCC requires that you be notified that any changes or modifications to this device not expressly approved by the manufacturer could void the user's authority to operate the equipment.

**Caution:** Within the 5.15 to 5.25 GHz band (5 GHz radio channels 34 to 48) this device is restricted to indoor operations to reduce any potential for harmful interference to co-channel Mobile Satellite System (MSS) operations.

**RF Radiation Exposure Statement:**

SHIELD Portable has been tested and complies with FCC RF radiation exposure limits set forth for an uncontrolled environment when used with the NVIDIA accessories supplied or designated for this product. During testing, SHIELD Portable was placed in positions that

simulate use against the body. The use of any other accessories may not ensure compliance with FCC RF exposure guidelines.

Underwriters Laboratories (UL)



## CANADA

Industry Canada (IC)

**IC: 7361A-P2523**

**CAN ICES-3(B)/NMB-3(B)**

This device complies with RSS-210 of the Industry Canada Rules. Operation is subject to the following two conditions: (1) this device may not cause interference, and (2) this device must accept any interference, including interference that may cause undesired operation of the device.

Ce dispositif est conforme à la norme CNR-210 d'Industrie Canada applicable aux appareils radio exempts de licence. Son fonctionnement est sujet aux deux conditions suivantes: (1) le dispositif ne doit pas produire de brouillage préjudiciable, et (2) ce dispositif doit accepter tout brouillage reçu, y compris un brouillage susceptible de provoquer un fonctionnement indésirable.

### **RF Radiation Exposure Statement:**

SHIELD Portable has been tested and complies with IC RSS 102 RF radiation exposure limits set forth for an uncontrolled environment when used with the NVIDIA accessories supplied or designated for this product. During testing, SHIELD Portable was placed in positions that simulate use against the body. The use of any other accessories may not ensure compliance with IC RSS 102RF exposure guidelines.

### **Déclaration d'exposition aux radiations:**

La SHIELD Portable a été testée conformément aux normes d'exposition d'émission RF de la IC RSS 102 pour un environnement non contrôlé lors d'utilisation avec les accessoires fournis ou recommandés par NVIDIA. Pendant les tests, SHIELD Portable a été positionnée afin de simuler la présence du corps humain. L'utilisation d'accessoires autres que ceux recommandés par NVIDIA ne garantit pas la compatibilité avec les normes d'émission RF de la IC RSS 102.



# EUROPEAN UNION

European Conformity; Conformité Européenne (CE)



This device bears the CE mark and class-2 identifier in accordance with Directive 1999/5/EC

This device complies with the following Directives:

R&TTE Directive for radio equipment

Low Voltage Directive for electrical safety

RoHS Directive for hazardous substances

A copy of the Declaration of Conformity to the essential requirements may be obtained directly from NVIDIA GmbH (Floessergasse 2, 81369 Munich, Germany).

# AUSTRALIA AND NEW ZEALAND

Australian Communications and Media Authority (RCM)



This product meets the applicable EMC requirements for Class B, I.T.E equipment and applicable radio equipment requirements

# JAPAN

Voluntary Control Council for Interference (VCCI)



この装置は、クラスB情報技術装置です。この装置は、家庭環境で使用することを目的としていますが、この装置がラジオやテレビジョン受信機に近接して使用されると、受信障害を引き起こすことがあります。  
取扱説明書に従って正しい取り扱いをして下さい。

VCCI-B

Radio/ Telecommunications Certification



® 007-AD0055

W52/W53 are indoor use only

## SOUTH KOREA

Radio Research Agency (RRA)

Korean Agency for Technology and Standards (KATS)



MSIP-CMM-NVA-P2523

B급 기기  
(가정용 방송 통신기자재)

이 기기는 가정용(B급) 전자파적합기기로서 주로 가정에서 사용하는 것을 목적으로 하며, 모든 지역에서 사용할 수 있습니다.

## TAIWAN

National Communications Commission

國家通訊傳播委員會



CCAJ15LP1400T1

注意！

依據 低功率電波輻射性電機管理辦法

第十二條

經型式認證合格之低功率射頻電機，非經許可，公司、商號或使用者均不得擅自變更頻率、加大功率或變更原設計之特性及功能。

第十四條

低功率射頻電機之使用不得影響飛航安全及干擾合法通信；經發現有干擾現象時，應立即停用，並改善至無干擾時方得繼續使用。

前項合法通信，指依電信法規定作業之無線電通信。

低功率射頻電機須忍受合法通信或工業、科學及醫療用電波輻射性電機設備之干擾。

在5.250~5.350GHz頻帶內操作之無線資訊傳輸設備，限於室內使用

# RUSSIA/KAZAKHSTAN/BELARUS

EurAsian Customs Union



This device complies with the technical regulations of the Customs Union (CU TR)

This device complies with the rules set forth by Federal Agency of Communications and the Ministry of Communications and Mass Media

Federal Security Service notification has been filed.

# SINGAPORE

Complies with  
IDA Standards  
DA00006A

# BLUETOOTH



**Bluetooth v4.1 LE**

**Declaration ID: D022779**

The Bluetooth® word, mark, and logos are registered trademarks owned by Bluetooth SIG, Inc. and any use of such marks is under license.

# WI-FI ALLIANCE®

Wi-Fi CERTIFIED™



**Certification ID: WFA58412**

Wi-Fi Certified and Wi-Fi CERTIFIED Miracast are registered marks of the Wi-Fi Alliance.

© 2015 NVIDIA Corporation. All rights reserved. NVIDIA, the NVIDIA logo, and SHIELD are trademarks and/or registered trademarks of NVIDIA Corporation in the U.S. and other countries. Other company and product names may be trademarks of the respective companies with which they are associated.