

Titanis 2.4 GHz Swivel SMA Antenna

Part No. 2010B4844-01 / 2010B6090-01

Product Specification

1 Features

- Designed for 2.4 GHz applications: Bluetooth®, Wi-Fi® (802.11b/g), ZigBee®, etc.
- Antenna with a SMA male connector
- Also available as SMA reverse thread to meet FCC regulations, part 15
- High efficiency
- Supplied in bulk

2 Description

Titanis is intended for use with all 2.4 GHz applications. The antenna is fitted with a SMA male connector and a blade made of flexible material that can be rotated 360 degree.

No external matching network required.

3 Applications

- Development tools
- Test equipment
- Access points, routers, etc
- Printers



4 Part number

Titanis Standard SMA - male: 2010B4844-01

Titanis Reverse thread SMA - male: 2010B6090-01

5 General data

Product name	Titanis 2.4 GHz
Part Number	2010B4844-01 (Standard SMA – male)
	2010B6090-01 (Reverse thread SMA – male)
Frequency	2.4 – 2.5 GHz
Polarization	Linear
Operating temperature	-40 °C to +85 °C
Impedance	50 Ω
Weight	7.1 g
Antenna type	Swivel external
Dimensions	20 x 19.5 x 62.5 [mm]

6 Electrical characteristics

	Typical performance	Conditions
Peak gain	2.2 dBi	Data given for the 2.4 – 2.5 GHz frequency range
Average gain	-1.0 dBi	
Average efficiency	80%	
Maximum Return Loss	-13 dB	
Maximum VSWR	1.6:1	

7 Electrical performance

7-1 Return Loss

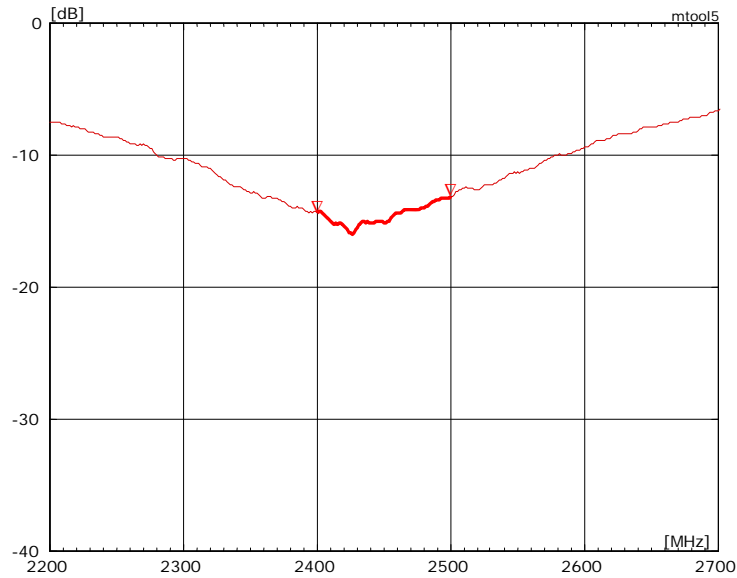

7-2 VSWR

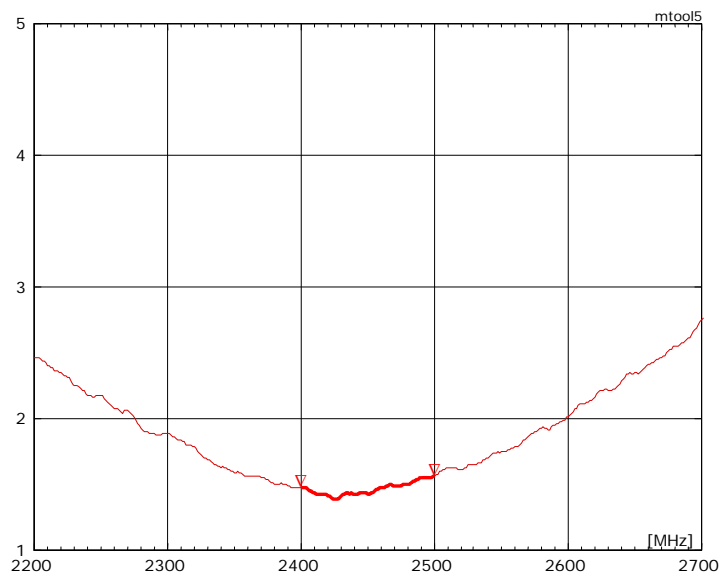

7-3 Antenna patterns

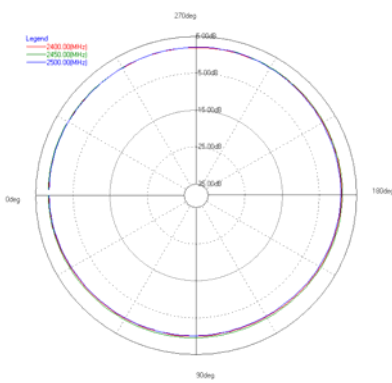
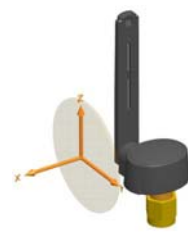
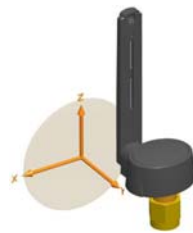
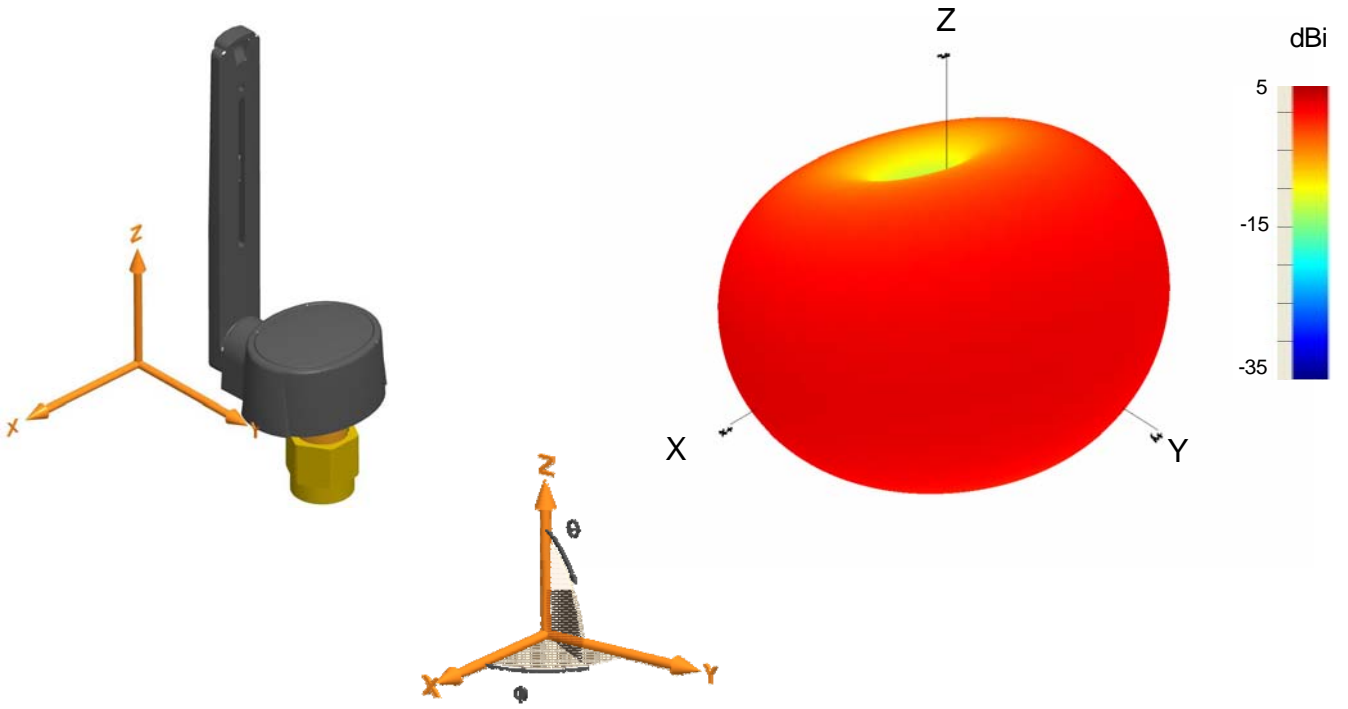

XY plane

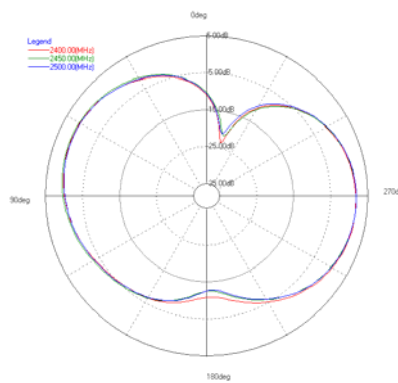

ZY plane

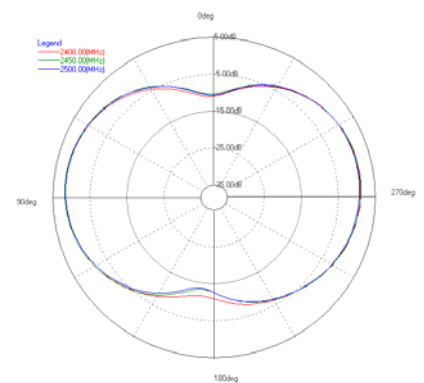

XZ plane

Patterns show combined polarisations

8 Antenna dimensions

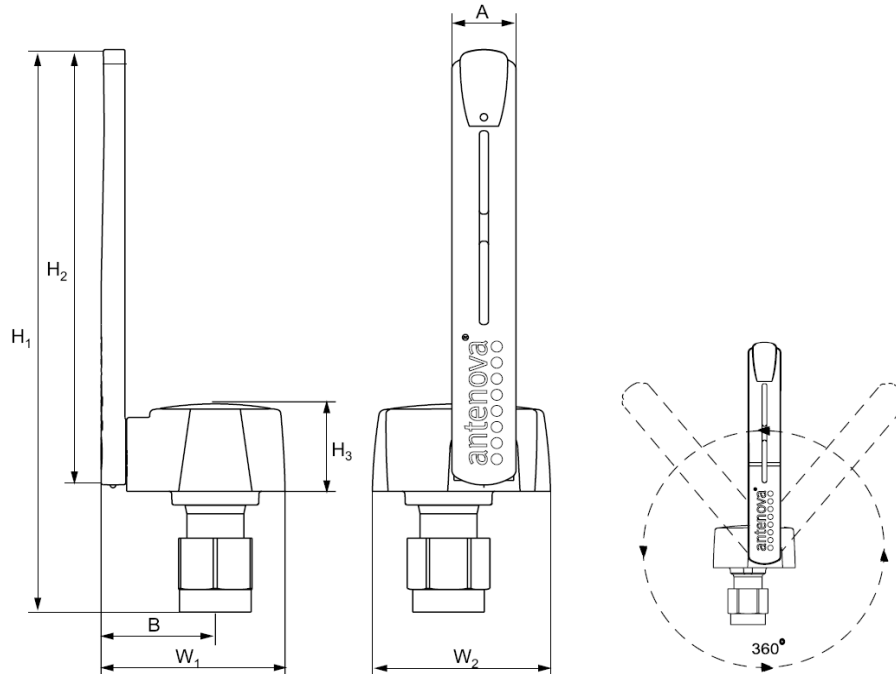

A	B	H1	H2	H3	W1	W2
		Height	Height	Height	Width	Width
7 ± 0.2	12.5 ± 0.5	62.5 ± 0.5	48.3 ± 0.5	9.5 ± 0.5	20 ± 0.3	19.5 ± 0.3

Dimensions in mm

9 Hazardous material regulation conformance

The antenna has been tested to conform to RoHS requirements. A certificate of conformance is available from Antenova's website.

10 Packaging

10-1 Optimal storage conditions

Temperature	-10°C to 40°C
Humidity	Less than 75% RH
Shelf Life	48 Months
Storage place	Away from corrosive gas and direct sunlight

10-2 Packaging information

The antennas are delivered in bulk, enclosed in plastic bags.

10-3 Bag label information

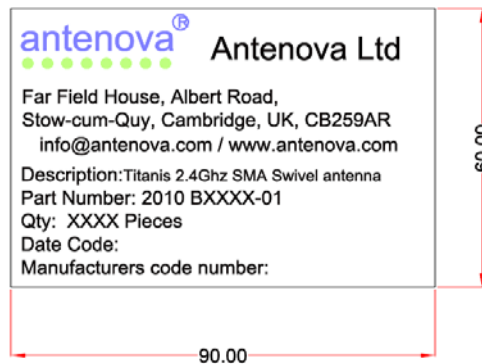

Dimensions in mm



www.antenova.com

Corporate Headquarters

Antenova Ltd.
Far Field House
Albert Road
Stow-cum-Quy
Cambridge
CB25 9AR

Tel: +44 1223810600
Fax: +44 1223 810650
Email: info@antenova.com

North America Headquarters

Antenova Ltd.
Rogers Business Park
2541 Technology Drive Suite 403
Elgin, IL 60124

Tel: +1 (847) 551 9710
Fax: +1 (847) 551 9719
Email: info@antenova.com

Asia Headquarters

Antenova Asia Ltd.
4F, No. 324, Sec. 1, Nei-Hu Road
Nei-Hu District
Taipei 11493
Taiwan, ROC

Tel: +886 (0) 2 8797 8630
Fax: +886 (0) 2 8797 6890
Email: info@antenova.com

Copyright® 2007 Antenova Ltd. All Rights Reserved. Antenova® and RADIONOVA® are trademarks of Antenova Ltd. Any other names and/or trademarks belong to their respective companies.

The materials provided herein are believed to be reliable and correct at the time of print. Antenova does not warrant the accuracy or completeness of the information, text, graphics or other items contained within these information. Antenova further assumes no responsibility for the use of this information, and all such information shall be entirely at the user's risk.



Certificate No: 4598/04

Integrated Antenna Solutions