



# T 777

AV Surround Sound Receiver

ENGLISH



Owner's Manual

# IMPORTANT SAFETY INSTRUCTIONS

1. **Read instructions** - All the safety and operating instructions should be read before the product is operated.
2. **Retain instructions** - The safety and operating instructions should be retained for future reference.
3. **Heed Warnings** - All warnings on the product and in the operating instructions should be adhered to.
4. **Follow Instructions** - All operating and use instructions should be followed.
5. **Cleaning** - Unplug this product from the wall outlet before cleaning. Do not use liquid cleaners or aerosol cleaners. Use a damp cloth for cleaning.
6. **Attachments** - Do not use attachments not recommended by the product manufacturer as they may cause hazards.
7. **Water and Moisture** - Do not use this product near water-for example, near a bath tub, wash bowl, kitchen sink, or laundry tub; in a wet basement; or near a swimming pool; and the like.
8. **Accessories** - Do not place this product on an unstable cart, stand, tripod, bracket, or table. The product may fall, causing serious injury to a child or adult and serious damage to the product. Use only with a cart, stand, tripod, bracket, or table recommended by the manufacturer, or sold with the product. Any mounting of the product should follow the manufacturer's instructions, and should use a mounting accessory recommended by the manufacturer.
9.  **Cart** - A product and cart combination should be moved with care. Quick stops, excessive force, and uneven surfaces may cause the product and cart combination to overturn.
10. **Ventilation** - Slots and openings in the cabinet are provided for ventilation to ensure reliable operation of the product and to protect it from overheating. These openings must not be blocked or covered. The openings should never be blocked by placing the product on a bed, sofa, rug, or other similar surface. This product should not be placed in a built-in installation such as a bookcase or rack unless proper ventilation is provided or the manufacturer's instructions have been adhered to.
11. **Power Sources** - This product should be operated only from the type of power source indicated on the marking label and connected to a MAINS socket outlet with a protective earthing connection. If you are not sure of the type of power supply to your home, consult your product dealer or local power company.
12. **Power-Cord Protection** - Power-supply cords should be routed so that they are not likely to be walked on or pinched by items placed upon or against them, paying particular attention to cords at plugs, convenience receptacles, and the point where they exit from the product.
13. **Mains Plug** - Where the mains plug or an appliance coupler is used as the disconnect device, the disconnect device shall remain readily operable.
14. **Outdoor Antenna Grounding** - If an outside antenna or cable system is connected to the product, be sure the antenna or cable system is grounded so as to provide some protection against voltage surges and built-up static charges. Article 810 of the National Electrical Code, ANSI/NFPA 70, provides information with regard to proper grounding of the mast and supporting structure, grounding of the lead-in wire to an antenna discharge unit, size of grounding conductors, location of antenna discharge unit, connection to grounding electrodes, and requirements for the grounding electrode.

## NOTE TO CATV SYSTEM INSTALLER

This reminder is provided to call the CATV system installer's attention to Section 820-40 of the NEC which provides guidelines for proper grounding and, in particular, specifies that the cable ground shall be connected to the grounding system of the building, as close to the point of cable entry as practical.

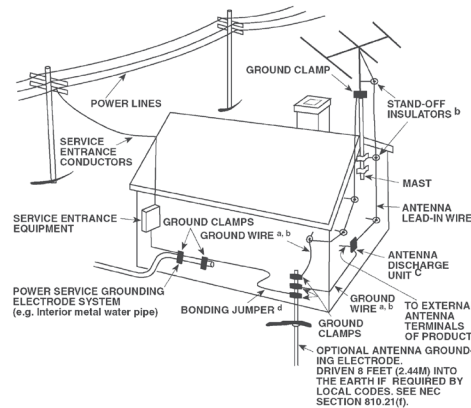

15. **Lightning** - For added protection for this product during a lightning storm, or when it is left unattended and unused for long periods of time, unplug it from the wall outlet and disconnect the antenna or cable system. This will prevent damage to the product due to lightning and power-line surges.
16. **Power Lines** - An outside antenna system should not be located in the vicinity of overhead power lines or other electric light or power circuits, or where it can fall into such power lines or circuits. When installing an outside antenna system, extreme care should be taken to keep from touching such power lines or circuits as contact with them might be fatal.
17. **Overloading** - Do not overload wall outlets, extension cords, or integral convenience receptacles as this can result in a risk of fire or electric shock.
18. **Flame Sources** - No naked flame sources, such as lighted candles, should be placed on the product.
19. **Object and Liquid Entry** - Never push objects of any kind into this product through openings as they may touch dangerous voltage points or short-out parts that could result in a fire or electric shock. Never spill liquid of any kind on the product.
20. **Headphones** - Excessive sound pressure from earphones and headphones can cause hearing loss.
21. **Damage Requiring Service** - Unplug this product from the wall outlet and refer servicing to qualified service personnel under the following conditions:
  - a. When the power-supply cord or plug is damaged.
  - b. If liquid has been spilled, or objects have fallen into the product.
  - c. If the product has been exposed to rain or water.
  - d. If the product does not operate normally by following the operating instructions. Adjust only those controls that are covered by the operating instructions as an improper adjustment of other controls may result in damage and will often require extensive work by a qualified technician to restore the product to its normal operation.
  - e. If the product has been dropped or damaged in any way.
  - f. When the product exhibits a distinct change in performance-this indicates a need for service.
22. **Replacement Parts** - When replacement parts are required, be sure the service technician has used replacement parts specified by the manufacturer or have the same characteristics as the original part. Unauthorized substitutions may result in fire, electric shock, or other hazards.

**23. Battery Disposal** - When disposing of used batteries, please comply with governmental regulations or environmental public instruction's rules that apply in your country or area.

**24. Safety Check** - Upon completion of any service or repairs to this product, ask the service technician to perform safety checks to determine that the product is in proper operating condition.

**WARNING**



The lightning flash with arrowhead symbol, within an equilateral triangle, is intended to alert the user to the presence of uninsulated "dangerous voltage" within the product's enclosure that may be of sufficient magnitude to constitute a risk of electric shock to persons



The exclamation point within an equilateral triangle is intended to alert the user to the presence of important operating and maintenance (servicing) instructions in the literature accompanying the appliance.



THE EQUIPMENT MUST BE CONNECTED TO AN EARTHED MAINS SOCKET-OUTLET.

**CAUTION REGARDING PLACEMENT**

To maintain proper ventilation, be sure to leave a space around the unit (from the largest outer dimensions including projections) than is equal to, or greater than shown below.

- Left and Right Panels: 10 cm
- Rear Panel: 10 cm
- Top Panel: 10 cm

**FCC STATEMENT**

This equipment has been tested and found to comply with the limits for Class B digital device, pursuant to Part 15 of the FCC Rules. These limits are designed to provide reasonable protection against harmful interference in a residential installation. This equipment generates, uses, and can radiate radio frequency energy and, if not installed and used in accordance with the instructions, may cause harmful interference to radio communications. However, there is no guarantee that interference will not occur in a particular installation. If this equipment does cause harmful interference to radio or television reception, which can be determined by turning the equipment off and on, the user is encouraged to try to correct the interference by one or more of the following measures:

- Reorient or relocate the receiving antenna.
- Increase the separation between the equipment and receiver.
- Connect the equipment into an outlet on a circuit different from that to which the receiver is connected.
- Consult the dealer or an experienced radio TV technician for help.

**CAUTION**

Changes or modifications to this equipment not expressly approved by NAD Electronics for compliance could void the user's authority to operate this equipment.

**CAUTION**

To prevent electric shock, match wide blade of plug to wide slot, fully insert.

**CAUTION**

Marking and rating plate can be found at the rear panel of the apparatus.

**WARNING**

To reduce the risk of fire or electric shock, do not expose this apparatus to rain or moisture.

The apparatus shall not be exposed to dripping or splashing and that no objects filled with liquids, such as vases, shall be placed on apparatus.

Mains plug is used as disconnect device and it should remain readily operable during intended use. In order to disconnect the apparatus from the mains completely, the mains plug should be disconnected from the mains socket outlet completely.

Battery shall not be exposed to excessive heat such as sunshine, fire or the like.

**CAUTION**

Danger of explosion if battery is incorrectly replaced. Replace only with the same or equivalent type.

An appliance with a protective earth terminal should be connected to a mains outlet with a protective earth connection.

**IF IN DOUBT CONSULT A COMPETENT ELECTRICIAN.**



This product is manufactured to comply with the radio interference requirements of EEC DIRECTIVE 2004/108/EC.

**NOTES ON ENVIRONMENTAL PROTECTION**



At the end of its useful life, this product must not be disposed of with regular household waste but must be returned to a collection point for the recycling of electrical and electronic equipment. The symbol on the product, user's manual and packaging point this out.

The materials can be reused in accordance with their markings. Through re-use, recycling of raw materials, or other forms of recycling of old products, you are making an important contribution to the protection of our environment.

Your local administrative office can advise you of the responsible waste disposal point.

**RECORD YOUR MODEL NUMBER (NOW, WHILE YOU CAN SEE IT)**

The model and serial number of your new T 777 are located on the back of the cabinet. For your future convenience, we suggest that you record these numbers here:

Model number : .....  
 Serial number : .....

# INTRODUCTION

## TABLE OF CONTENTS

### IMPORTANT SAFETY INSTRUCTIONS .....2

### INTRODUCTION

<b>GETTING STARTED</b> .....	<b>5</b>
WHAT'S IN THE BOX .....	5
CHOOSING A LOCATION .....	5
DEFAULT SOURCE SETTINGS .....	5

### IDENTIFICATION OF CONTROLS

<b>FRONT PANEL</b> .....	<b>6</b>
<b>REAR PANEL</b> .....	<b>8</b>

### OPERATION

<b>USING THE T 777 – MAIN MENU</b> .....	<b>12</b>
ABOUT THE ON-SCREEN DISPLAY (OSD) .....	12
MAIN MENU .....	12
LISTENING MODE .....	12
ADJUSTING LISTENING MODES .....	13
DSP OPTIONS .....	14
TONE CONTROLS .....	15
ZONE CONTROLS .....	15
<b>USING THE T 777 – SETUP MENU</b> .....	<b>16</b>
SETUP MENU .....	16
CONTROL/HDMI SETUP .....	16
SOURCE SETUP .....	17
SOURCE SETUP (NORMAL VIEW) .....	17
SOURCE SETUP (TABLE VIEW) .....	18
iPod SETUP .....	19
SPEAKER SETUP .....	19
AUDYSSEY AUTO CALIBRATION .....	19
SPEAKER CONFIGURATION .....	22
SPEAKER LEVELS .....	22
SPEAKER DISTANCE .....	23
ADJUSTING THE VOLUME .....	23
ADJUSTING CHANNEL LEVELS 'ON THE FLY' .....	24
ZONE SETUP .....	24
AMPLIFIER SETUP .....	24
TRIGGER SETUP .....	25
LISTENING MODE SETUP .....	25
DOLBY SETUP .....	27
DTS SETUP .....	27
DTS SURROUND MODES .....	27
ENHANCED STEREO .....	28
DISPLAY SETUP .....	28
A/V PRESETS .....	29
<b>LISTENING TO AM/FM RADIO</b> .....	<b>32</b>
SELECTING A TUNER BAND .....	32

STORING PRESETS (AM/FM/XM/DAB) .....	32
CHOOSING THE TUNER MODE .....	32
ABOUT USER NAMES .....	33
ABOUT RDS .....	33
<b>LISTENING TO XM RADIO</b> .....	<b>34</b>
TUNING XM CHANNELS .....	34
STORING PRESETS .....	34
<b>LISTENING TO DAB RADIO</b> .....	<b>35</b>
CONNECTING THE DAB MODULE .....	35
DAB OPERATION .....	35
SERVICE LIST .....	36
DAB TUNER MODE .....	36
STATION ORDER .....	36
DRC .....	36
MANUAL SCAN .....	36
PRUNE LIST .....	36
RESET .....	37
INFORMATION SETTINGS .....	37
<b>LISTENING TO YOUR iPod PLAYER</b> .....	<b>38</b>
CONNECTING THE OPTIONAL NAD IPD AND iPod PLAYER .....	38
TO THE T 777 .....	38
CONTROL FEATURES AND SETTINGS .....	38
NAD IPD 2 .....	39
TO VIEW VIDEOS OR PHOTOS LOADED IN YOUR iPod .....	39
<b>USING THE HTR 8 REMOTE CONTROL</b> .....	<b>40</b>
OVERVIEW OF THE HTR 8 .....	40
GETTING FAMILIAR WITH THE HTR 8 .....	40
LEARNING CODES FROM OTHER REMOTES .....	40
PUNCH THROUGH .....	41
COPY A COMMAND FROM ANOTHER KEY .....	41
MACRO COMMANDS .....	41
KEY ILLUMINATION TIMEOUT .....	42
CONFIGURING KEY ILLUMINATION .....	42
FACTORY RESET .....	42
DELETE MODE .....	42
LOADING CODE-LIBRARIES .....	43
SEARCH MODE .....	43
CHECKING CODE-LIBRARY NUMBER .....	43
SUMMARY OF THE HTR 8 MODES .....	44
USB INTERFACE .....	44
<b>USING IR CHANNEL</b> .....	<b>45</b>
IR CHANNEL ASSIGNMENT .....	45

### REFERENCE

<b>TROUBLESHOOTING</b> .....	<b>46</b>
<b>SPECIFICATIONS</b> .....	<b>47</b>

### THANK YOU FOR CHOOSING NAD.

The T 777 AV Surround Sound Receiver is a technologically advanced and highly capable product — yet we have invested great effort in making it simple and easy to use. The T 777 delivers a range of genuinely useful options for surround sound and stereo listening alike, using powerful digital signal processing and superbly accurate digital-audio circuitry. However, we have also been careful to ensure that the T 777 is as musically transparent, faithful to every video detail and spatially accurate as possible, incorporating much of what we've learned from a quarter-century's experience designing audio, video and home-theater components. As with all our products, NAD's "Music First" design philosophy guided the T 777's design, such that it can confidently promise you both state-of-the-art surround home-theater and audiophile-quality music listening for years to come.

We encourage you to take a few minutes now to read right through this manual. Investing a little time here at the outset might save you a good deal of time later, and is by far the best way to ensure that you make the most of your investment in the T 777, and get the most from this powerful and flexible home-theater component.

One more thing: We urge you to register your T 777 ownership on the NAD Worldwide Web site:

<http://NADelectronics.com/salon>

For warranty information contact your local distributor.

**NAD SHALL NOT BE HELD LIABLE FOR ANY TECHNICAL OR USER INTERFACE DISCREPANCIES IN THIS MANUAL. THE T 777 OWNER'S MANUAL MAY BE SUBJECT TO CHANGE WITHOUT PRIOR NOTICE. CHECK OUT THE NAD WEBSITE FOR THE LATEST VERSION OF THE T 777 OWNER'S MANUAL.**

### WHAT'S IN THE BOX

Packed with your T 777 you will find

- An AM loop antenna
- A FM ribbon-wire antenna with balun
- A detachable mains power cord
- Audyssey microphone
- The HTR 8 remote control with 4 AA batteries
- ZR 7 zone remote control with 3V CR2025 battery
- General Quick Start Guide for T187, T777 and T787
- Owner's manual in CD-ROM

### SAVE THE PACKAGING

Please save the box and all of the packaging in which your T 777 arrived. Should you move or otherwise need to transport your T 777, this is by far the safest container in which to do so. We've seen too many otherwise perfect components damaged in transit for lack of a proper shipping carton, so please: Save that box!

### CHOOSING A LOCATION

Choose a location that is well ventilated (with at least several inches to both sides and behind), and that will provide a clear line of sight, within 25 feet/8 meters, between the T 777's front panel and your primary listening/viewing position—this will ensure reliable infrared remote control communications. The T 777 generates a modest amount of heat, but nothing that should trouble adjacent components.

It is perfectly possible to stack the T 777 on top of other components, but the reverse usually should be avoided.

### DEFAULT SOURCE SETTINGS

The following table lists the default SOURCE settings. Note that the Audio input settings show both digital and analog audio input. Digital input will always take precedence over analog audio input even if both are present.

Source	Audio Input	Video Input
Source 1	HDMI 1/ Audio 1	HDMI 1
Source 2	HDMI 2/ Audio 2	HDMI 2
Source 3	Coaxial 1/Audio 3	Component 1
Source 4	Optical 1/Audio 4	Video 1
iPod	Audio 5	S-Video 3
Source 7	7.1 Input	Component 2
Front Input	HDMI Front/ Audio Front	HDMI Front
Media Player	Audio MP	
Tuner		

To modify the above default settings and for a better understanding of source setting and combinations, please refer to the item about "SOURCE SETUP" in the "USING THE T 777 - SETUP MENU" segment of the "OPERATION" section.

### NOTE

*Digital input will always take precedence over analog audio input even if both are present.*

# IDENTIFICATION OF CONTROLS

## FRONT PANEL

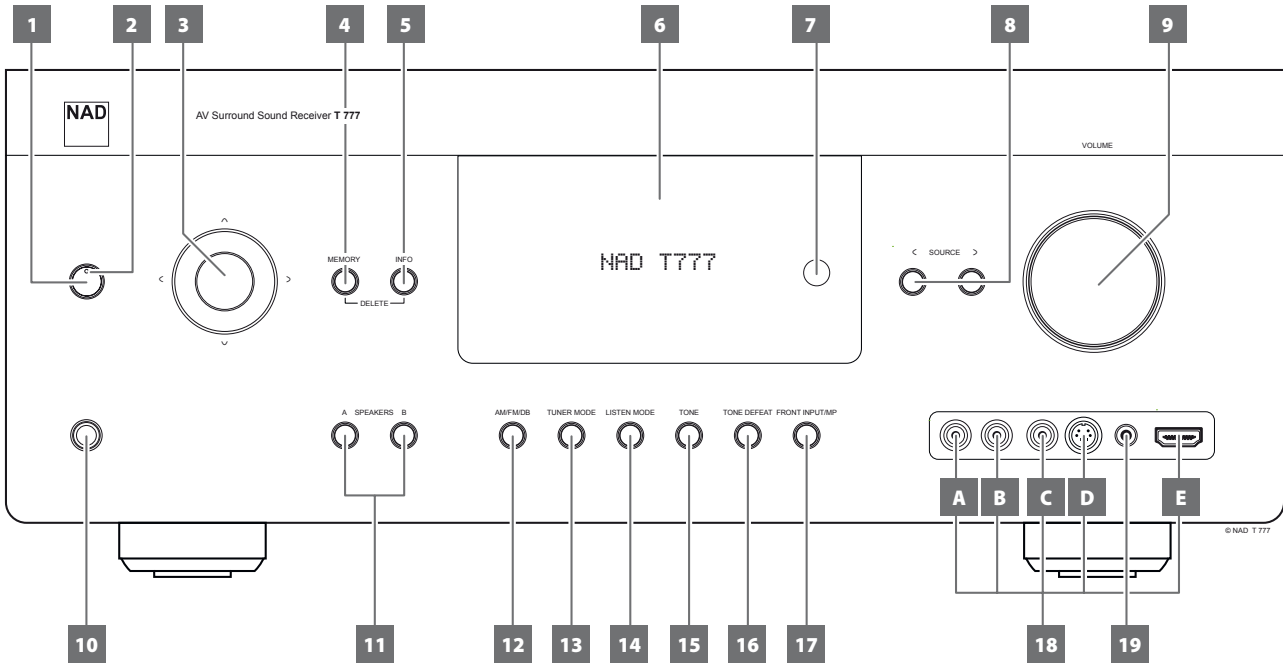

### 1 STANDBY BUTTON

- Press this button to switch ON the T 777 from standby mode. The Standby LED indicator will turn from amber to blue and illuminate the VFD. Pressing the STANDBY button again turns the unit back to standby mode.
- The T 777 can also be switched ON from standby mode by pressing any of the front panel buttons.

### NOTE

*In order to turn ON the T 777 from standby mode or back to standby mode, the rear panel POWER switch must be in the ON position.*

### 2 STANDBY LED

- This indicator will light up amber when the T 777 is at standby mode.
- When T 777 is powered up from standby mode, this indicator will illuminate blue.
- If a Zone (Zone 2, Zone 3 or Zone 4) is ON and STANDBY button is pressed to switch the T 777 to standby mode, the VFD will be extinguished but the STANDBY LED remains illuminated blue. This indicates a Zone (Zone 2, Zone 3 or Zone 4) is still active. The corresponding active Zone icon(s) will also remain displayed in the VFD.
- In order to completely shut down the T 777 with Zone 2, Zone 3 and/or Zone 4 still ON, press and hold STANDBY button until the STANDBY LED turns amber.
- When infrared command from the HTR 8 is received, this indicator will also flash momentarily.

### 3 NAVIGATION and ENTER BUTTONS

The navigation ([ $\swarrow$ ]/[ $\searrow$ ]/[ $\leftarrow$ ]/[ $\rightarrow$ ]) and [ENTER] buttons have various applications specific to given modes. The middle round button is designated as [ENTER] button; this is normally pressed to complete a selection, procedure, sequence or other applicable functions.

### AM/FM mode

Toggle [ENTER] button to switch between "Tune" and "Preset" mode. Select "Tune" mode.

- Pressing momentarily the [ $\leftarrow$ ]/[ $\rightarrow$ ] button will manually scan the AM or FM band.
- Press and hold [ $\leftarrow$ ]/[ $\rightarrow$ ] for more than 2 seconds to search up or down; the T 777's tuner will stop at the next sufficiently strong signal it encounters.
- Note that this function "wraps" - that is, it will continue to search from one end of the AM or FM band to the other until it stops at a strong signal.

Toggle [ENTER] button to switch between "Tune" and "Preset" mode. Select "Preset" mode.

- Use [ $\swarrow$ ]/[ $\searrow$ ] to step up or down AM/FM Presets. Unused presets are skipped over. Note that Presets must have been previously stored.

Refer also to the item about STORING PRESETS (AM/FM/XM/DAB) at the LISTENING TO AM/FM RADIO section of the OPERATION page.

### XM mode (120V version model only)

- Use the front panel [ $\swarrow$ ]/[ $\searrow$ ] and [ENTER] buttons in combination with the [MENU] button to select through applicable XM menu options.

### DAB mode (230V version model only)

- Use front panel [ $\leftarrow$ ]/[ $\rightarrow$ ] and [ENTER] buttons in combination with [MENU] button to select through applicable DAB menu options.

### 4 MEMORY

- Press this button to store tuned AM, FM and digital radio stations to the T 777's 40 preset-memory locations. One can store a mix of any AM, FM and digital radio stations to the 40 available presets.

### 5 INFO

- Show information as supplied by the applicable source.
- Toggle [INFO] button to display supplied information.

### 6 VACUUM FLUORESCENT DISPLAY (VFD)

- Displays visual information about the current settings like the active Source, volume level, listening mode, audio format, applicable RDS/XM/DAB as well as iPod-related display information and other related indicators.
- Refer also to the item about DISPLAY SETUP under the USING THE T 777 - SETUP MENU segment of the OPERATION section.

### 7 REMOTE SENSOR

- Point the HTR 8 remote control at the remote sensor and press the buttons.
- Do not expose the remote sensor of the T 777 to a strong light source such as direct sunlight or illumination. If you do so, you may not be able to operate the T 777 with the remote control.

**Distance:** About 23ft (7m) from the front of the remote sensor.

**Angle:** About 30° in each direction of the front of the remote sensor.

### 8 < SOURCE >

- Toggle through the input selections - Source 1, Source 2, Source 3, Source 4, iPod, Source 7, Front Input, Media Player and Tuner (AM/FM/DAB/XM as applicable). More Sources can be directly recalled upon enabling them at the Setup Menu.
- Refer also to the item about SOURCE SETUP under the USING THE T 777 - SETUP MENU segment of the OPERATION section.

### 9 VOLUME

- The VOLUME control adjusts the overall loudness of the signal being fed to the loudspeakers or headphones.
- Turn clockwise to increase the volume level; counter clockwise to lower it.

### 10 PHONES

- Accepts stereo headphone using a standard 1/4-inch stereo phone plug (use a suitable adaptor for headphones equipped with a smaller plug).
- For headphone listening, the Front speakers must be set to "Large" at the "Speaker Configuration" of the Speaker Setup item at the Setup Menu; otherwise headphone bass response will be restricted.

### 11 A SPEAKERS B

- Press either Speaker A or B or both to select the set of speakers you wish to listen.
- Speaker A is the main set of 7 multichannel and surround speakers.
- Speaker B is an auxiliary set for remote locations such as other rooms of your home. For Speaker B selection, all surround sound sources are downmixed to stereo. Combining Speaker A and Speaker B (SPEAKERS A + B) will also result to the source being downmixed to stereo.

### 12 AM/FM/DB

- Toggle this button to select AM, FM, DAB (230V version only) or XM (120V version only) tuner functions.

### 13 TUNER MODE

- In FM mode, this button will toggle between FM STEREO and FM MONO.
- Select FM MONO (FM STEREO and FM MUTE icons at VFD are extinguished) for stations that have too much interference or are too weak.
- In DAB (230V version only) or XM (120V version only) radio, this button enables the digital radio menu in conjunction with the Navigation and Enter buttons.

### 14 LISTEN MODE

- Toggle to select through the various Listening mode options. Depending on the format of the currently selected input (digital or analog, stereo or multichannel), various listening modes are available.
- Refer also to the item about LISTENING MODE under the USING THE T 777 - MAIN MENU segment of the OPERATION section.

### 15 TONE

- Press to adjust TREBLE control using the VOLUME knob over a  $\pm 10$ dB range. Press again to adjust BASS control and a third time for DIALOG control.
- Refer also to the item about TONE CONTROLS under the USING THE T 777 - MAIN MENU segment of the OPERATION section.

### 16 TONE DEFEAT

- Tone Controls are enabled or disabled by pressing this button. Tone controls are bypassed at "Tone Defeat" while at "Tone Active", the tone controls are enabled again.
- Refer also to the item about TONE CONTROLS under the USING THE T 777 - MAIN MENU segment of the OPERATION section.

### 17 FRONT INPUT/MP

- Toggle button to switch between Front Input and Media Player input.

### 18 FRONT INPUT PORTS

- Use these convenience jacks for occasional sources such as a camcorder, video game console, any analog audio or HDMI sources and composite or S-Video sources.
- If your source has a single audio out jack only or is marked "Mono output", plug this into the T 777's Front "R (MONO)" input (item B).
- On the other hand, if your source has two output jacks indicative of stereo output, insert both jacks into the T 777's corresponding Front "L" (item A) and "R (MONO)" input to achieve stereo output as well.
- Connect composite video output source to the front composite video input (item C).
- Connect S-Video output source to the front S-Video input (item D).
- Use the front HDMI input (item E) to connect directly an HDMI output source.

### 19 FRONT MP/MIC INPUT

- Connect your Media Player's standard stereo phone jack to this input.
- This is also same input where the supplied Audyssey microphone is connected for Audyssey Auto calibration.
- Refer also to the item about AUDYSSEY AUTO CALIBRATION under the USING THE T 777 - SETUP MENU segment of the OPERATION section.

# IDENTIFICATION OF CONTROLS

## REAR PANEL

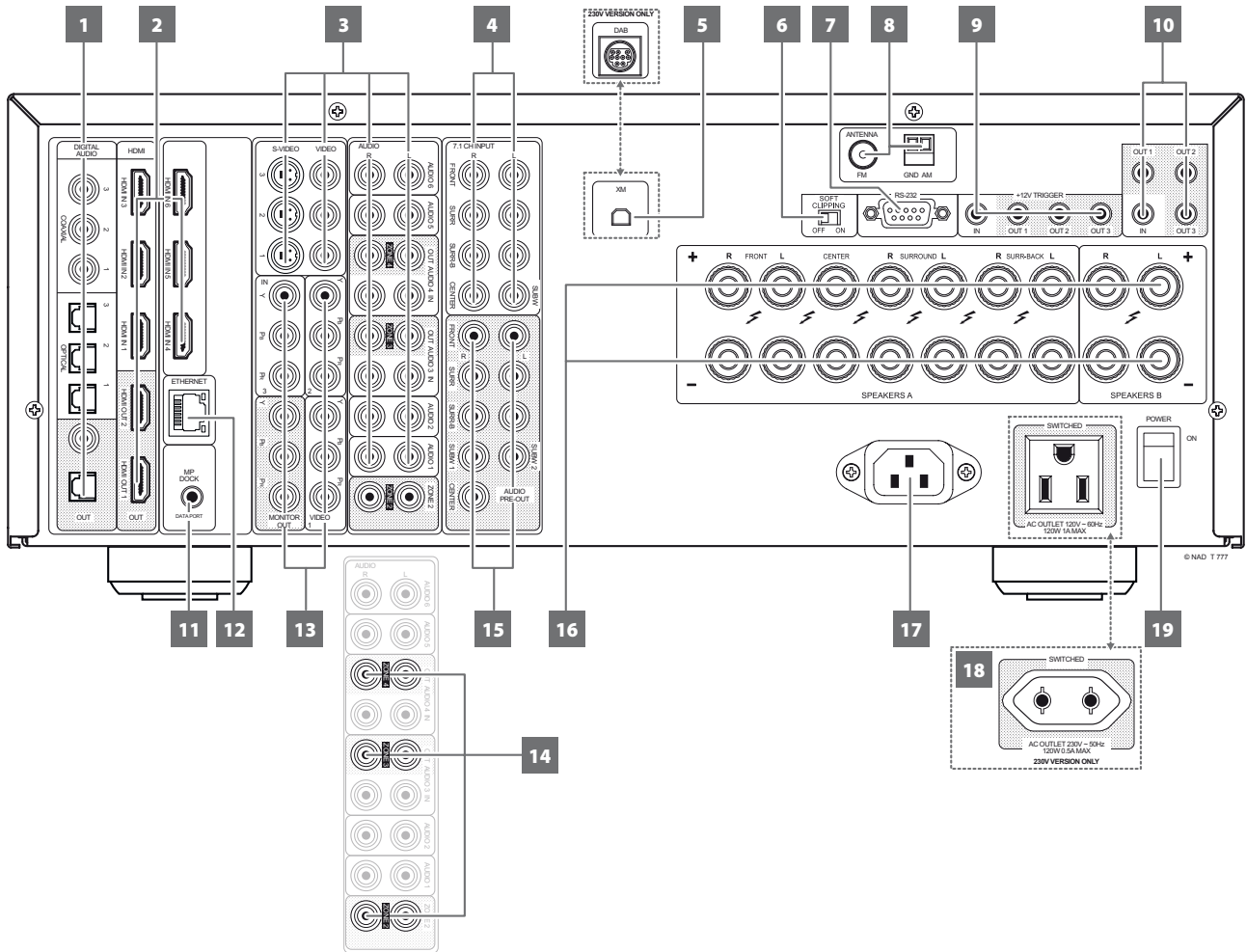

### ATTENTION!

Please make sure that the T 777 is powered off or unplugged from the mains power source before making any connections. It is also advisable to power down or unplug all associated components while making or breaking any signal or AC power connections.

#### 1 DIGITAL AUDIO IN (COAXIAL 1-3, OPTICAL 1-3)

- Connect to the corresponding optical or coaxial digital output of sources such as CD or BD/DVD players, digital cable box, digital tuners and other applicable components.
- Coaxial and Optical digital input association is configurable via the Source Setup item of the Setup Menu OSD.

#### DIGITAL AUDIO OUT (OPTICAL, COAXIAL)

- Connect the optical or coaxial DIGITAL OUT to the corresponding digital audio input of compatible devices such as receivers, computer soundcard or other digital processors.

#### 2 HDMI (HDMI IN 1-6, HDMI OUT 1-2)

- Connect the sets of HDMI input to the HDMI OUT connectors of source components such as DVD player, BD player or HDTV satellite/cable box.
- Connect the HDMI OUT 1 and/or HDMI OUT 2 to compatible HDTV or projector with HDMI input. Both HDMI output ports display simultaneously the same audio/video source.

#### 3 AUDIO 1-6/VIDEO 1-3/S-VIDEO 1-3

- These comprise the T 777's other sets of principal input. Connect these audio and video input ports to corresponding output ports of compatible source components such as DVD players, CD players or cable/satellite boxes.
- AUDIO 5 and S-VIDEO 3 are the assigned default ports for the audio/video output of the separately sold NAD IPD (NAD IPD Dock for iPod) 1, NAD IPD 2 and later variants.

#### AUDIO 3-4 OUT

- Connect AUDIO 3 OUT (and/or AUDIO 4 OUT) to corresponding recording components or audio input ports of compatible sources like cassette deck, CD/DVD recorder or outboard audio processors.
- The signal present at AUDIO 3-4 OUT is determined by the current source selected. There will be no output at AUDIO 3 OUT when AUDIO 3 is selected. Likewise, there will be no output at AUDIO 4 OUT when AUDIO 4 is the active source input. This prevents feedback through the recording component thereby preventing possible damage to your speakers.
- When configured, AUDIO 3 OUT and AUDIO 4 OUT are the same assigned ports for Zone 3 and Zone 4 respectively. See also Zone output description below.

### WARNING

Before connecting and disconnecting any HDMI cables, both the T 777 and the ancillary source must be powered OFF and unplugged from the AC outlet. Failure to observe this practice may cause permanent damage to all equipment connected via HDMI sockets.



### 4 7.1 CHANNEL INPUT

- Connect to the corresponding analog audio output of a multichannel source component such as a DVD-Audio or multichannel-SACD player or external multichannel decoder (disc copy protected formats only allow analog signal transfer). Typically, these sources will produce 5.1-channel output, in which case the Surround Back jacks are left unconnected. The signal present at these jacks can be heard by selecting Source 7 (7.1 CHANNEL INPUT is defaulted to this Source).
- There is no bass-management or other processing (other than master-volume control) available to this 7.1 channel input.
- While the multichannel audio output of a DVD/BD player can be connected to these jacks, using the T 777's own Dolby Digital and DTS decoding and digital-analog converters via a digital connection will usually produce superior results.

### 5 XM MODULE INPUT (120V version model only)

With XM radio, there are more than 100 channels of music, news, sports, comedy, talk and entertainment. You will find that the coverage is continent wide. The music quality is digital with many commercial-free music channels.

- Connect XM radio cable to this socket. Follow the instructions that came with your XM radio.
- Refer also to the "LISTENING TO XM RADIO" segment of the "OPERATION" section.

#### NOTE

*The external XM radio is not supplied with your T 777.*

### DAB MODULE INPUT (230V version model only)

The T 777 is compatible only with the NAD DAB Adaptor module models DB 1 or DB 2. With DAB, you can receive CD-like quality programs without any annoying interference and signal distortion.

- Plug-in the other end of the Mini-Din connector from the NAD DAB Adaptor module output port into this socket.
- Refer also to the item about "LISTENING TO DAB RADIO" segment of the "OPERATION" section.

#### NOTE

*The external NAD DAB Adaptor module is not supplied with your T 777.*

### 6 SOFT CLIPPING

- Enables NAD's proprietary Soft Clipping circuitry on all channels.
- At ON position, Soft Clipping gently limits the output of the T 777 to minimize audible distortion should the T 777 be over-driven.
- Soft Clipping may simply be left ON at all times to reduce the likelihood of audible distortion from excessive volume settings. However, for critical listening and to preserve optimum dynamics, you may wish to defeat it by setting this switch to OFF.

### 7 RS 232

NAD is a certified partner of AMX and Crestron and fully supports these external devices. Check out the NAD website for information about AMX and Crestron compatibility with NAD. See your NAD audio specialist for more information.

- Connect this interface using RS-232 serial cable (not supplied) to any Windows compatible PC to allow remote control of the T 777 via compatible external controllers.
- Refer to the NAD website for information about RS232 Protocol documents and PC interface program.

### 8 FM ANTENNA TERMINAL

- The supplied wire "dipole" FM antenna will connect to the FM connector using the supplied "balun" adapter. It will usually work best when mounted on a vertical surface such as a wall, with arms fully outstretched forming a horizontal "T" perpendicular to the origin point of the signal.

### AM ANTENNA TERMINAL

The AM loop antenna supplied with the T 777 (or a suitable replacement) is required for AM reception.

- Connect the supplied AM loop antenna to these terminals. If an external AM antenna is used, make connections to the AM and GND terminals in accordance with the instructions supplied with the antenna.
- Testing different positions for the antenna may improve reception; vertical orientation will usually produce the best results. Antenna proximity to large metal objects (appliances, radiators) may impair reception, as will as attempts to lengthen the wire to the loop.
- Refer also to the item about ASSEMBLING THE LOOP ANTENNA at the LISTENING TO AM/FM RADIO section of the OPERATION page.

### 9 +12V TRIGGER OUT

The T 777 has three +12V TRIGGER OUT ports (OUT 1, OUT2 and OUT3) that can be configured to supply +12V DC to a linked component or system. See discussion on "Trigger Setup" at the "Setup Menu" literature for guidelines on how to configure +12V TRIGGER IN/OUT.

- Use a 3.5mm mini-jack connector to pass +12 volts at a maximum current of 50 milliamps to an auxiliary equipment such as a multichannel amplifier or subwoofer. The center conductor (hot) of the 3.5mm jack is the control signal. The outside conductor (shield) is the ground return-path.
- This output will be 12V when the T 777 is ON and 0V when the unit is either OFF or in standby mode.

### +12V TRIGGER IN

With this input triggered by a 12V DC supply, the T 777 can be switched ON remotely from standby mode by compatible devices such as amplifiers, preamplifiers, receivers, etc. If the 12V DC supply is cut off, the T 777 will return to standby mode.

- Connect this +12V Trigger input to the remote device's corresponding +12V DC output jack using a mono cable with 3.5mm male plug. The controlling device must be equipped with a +12V trigger output to use this feature.

### 10 IR IN/IR OUT 1-3

These mini-jacks accept and output remote-controlled codes in electrical format, using industry-standard protocols, for use with "IR-repeater" and multi-room systems and related technologies.

- All NAD products with IR IN/IR OUT features are fully compatible with the T 777. For non-NAD models, please check with your other product's service specialists as to their compatibility to the T 777's IR features.

### IR IN

- This input is connected to the output of an IR (infrared) repeater (Xantech or similar) or the IR output of another compatible device to allow control of the T 777 from a remote location.

### IR OUT 1, IR OUT 2

- Connect IR OUT 1 (and/or IR OUT 2) to the IR IN jack of a compatible device.
- Command and control the linked compatible device by directing its own remote control to T 777's infrared receiver.

# IDENTIFICATION OF CONTROLS

## REAR PANEL

### IR IN and IR OUT 1, IR OUT 2, IR OUT 3

- Connect the T 777's IR IN to the IR OUT of a compatible device. Connect also the T 777's IR OUT 1 (and/or IR OUT 2, IR OUT 3) to the IR IN of a compatible device.
- With this setup, the T 777 acts as an "IR-repeater" allowing the device connected to the T 777's IR IN control or command of the other device linked to T 777's IR OUT 1 (and/or IR OUT 2, IR OUT 3).

### IR OUT 3

- IR OUT 3 can only function as an "IR-repeater" as described above.

### 11 MP DOCK

The T 777 is equipped with a data port in the rear panel where an optional NAD IPD (NAD IPD Dock for iPod) 1, NAD IPD 2 and later variants can be plugged in.

- Connect the "MP DOCK (DATA PORT)" jack of the T 777 to the corresponding "DATA PORT" socket of the optional NAD IPD model.
- AUDIO 5 and S-VIDEO 3 are the assigned default ports for the audio/video output of the separately sold NAD IPD (NAD IPD Dock for iPod) 1, NAD IPD 2 and later variants.
- Refer also to the "LISTENING TO YOUR iPod PLAYER" segment of the "OPERATION" section.

### NOTE

*The NAD IPD Dock for iPod is not supplied with your T 777.*

### 12 ETHERNET/LOCAL AREA NETWORK (LAN) PORT

LAN connection must be setup for wired connection to be established. Set up a Wired Ethernet broadband router with broadband internet connection. Your router or home network should have a built-in DHCP server to consummate the connection.

- Using a standard straight-through Ethernet cable, connect one end of the Ethernet cable to the LAN port of your wired Ethernet broadband router and the other end to T 777's LAN port.
- This Ethernet connection has similar function as that of the RS232 connection. With your PC and the T 777 on the same network, it allows remote control of the T 777 via compatible external controllers.
- With your PC and T 777 connected on the same network, the IP address of your T 777 can be obtained. Press together and then release the front panel buttons [◀ SOURCE] and [SOURCE ▶] - "System Info" is shown in the VFD and OSD. Toggle [◀ SOURCE] or [SOURCE ▶] to individually show in the VFD the "System Info" details which include the IP address.
- Refer to the NAD website for information about RS232 Protocol documents and PC interface program.

### NOTES

- *NAD is not responsible for any malfunction of the T 777 and/or the internet connection due to communication errors or malfunctions associated with your broadband internet connection or other connected equipment. Contact your Internet Service Provider (ISP) for assistance or the service bureau of your other equipment.*
- *Contact your ISP for policies, charges, content restrictions, service limitations, bandwidth, repair and other related issues pertinent to internet connectivity.*

### 13 COMPONENT VIDEO INPUT 1-3, COMPONENT VIDEO OUT

- Connect the Component Video Input to Component Video output of compatible source components, typically a DVD player, BD player, digital cable box or other applicable components. Connect Component Video Out to the Component Video input of a compatible video monitor/TV.
- Be sure to observe consistency in connecting the Y/Pb/Pr jacks to the corresponding sources/inputs. The routing of the three component video input is fully configurable via the Source Setup item of the Setup Menu OSD.
- The T 777's sets of component video input and output are fully wideband and compatible with allowable HDTV formats.

### 14 ZONE 2-3-4

- The T 777 has three configurable Zones – Zone 2, Zone 3 and Zone 4. The Zone feature allows one to simultaneously experience in a different zone or location of the house a Source assigned to a particular zone.
- Sends zone selected audio source to the corresponding audio input of another zone. Use high quality patch cables to reduce noise pickup over long distance runs.
- For a better understanding of zone settings, study below the section about "Zone Controls" of the "Main Menu" discussion as well as the item about "Zone Setup" under the "Setup Menu" literatures.

### 15 AUDIO PRE-OUT

The AUDIO PRE- OUT makes it possible to use the T 777 as a pre-amplifier to external power amplifiers for some or all channels.

- Connect FRONT L, FRONT R, CENTER, SURR R, SURR L, SURR-BL and SURR-BR to the respective channel input of a power amplifier or amplifiers driving the corresponding applicable speakers.
- Connect the SUBW1 (and/or SUBW2) output to powered ("active") subwoofers or to power amplifier channels driving a passive system.
- Unlike the full range channels, there is no power amplifier built-into the T 777 for a subwoofer.

### 16 SPEAKERS A, SPEAKERS B

- Connect the respective SPEAKER A's FRONT L, FRONT R, CENTER, SURR R, SURR L, SURR-BL and SURR-BR channels to their corresponding loudspeakers. Make sure the "+" (red) terminal and "-" (black) terminal are connected to the corresponding "+" and "-" terminals of the loudspeaker. Use extra care to ensure that no stray wires or strands cross between posts or terminals at either end.
- Connect left and right channels of SPEAKERS B to the corresponding remote loudspeakers. When SPEAKERS B is activated, the output is converted to "Stereo Downmix". Combining SPEAKER A and SPEAKER B (SPEAKERS A + B) will also result to the source being downmixed to stereo.
- The T 777 is designed to produce optimum sound quality when connected to speakers with impedances within its operating range. Please make sure that all the speakers are rated 4Ω minimum per speaker.

### NOTE

*Use stranded wire of at least 16 gauge (AWG). Connections to the T 777 can be made with banana plugs (120V version only) or by using bare wire or pins. Use the transverse hole through the post for bare-wire or pin connections. By loosening the terminal's plastic nut, make a clean, neat connection and re-tighten carefully. To minimize the danger of short-circuit, ensure that only 1/2-inch of exposed wire or pin is employed when connecting.*

### 17 AC MAINS INPUT

- The T 777 comes supplied with a separate detachable mains power cord. Before connecting the plug to the mains powers source, connect firmly first the other end to T 777's AC Mains input socket.
- Always disconnect the mains power plug from the mains power source first, before disconnecting the cable from the T 777's AC Mains input socket.
- Connect only to the prescribed AC outlet, i.e., 120V 60 Hz (for 120V version models only) or 230V 50 Hz (for 230V version models only).

### 18 SWITCHED AC OUTLET

- This convenience outlet can supply switched power to another component or accessory.
- The total draw of all devices connected to this outlet must not exceed 120 watts.
- It is powered ON and OFF by the front panel STANDBY button or by the HTR 8's ON and OFF keys.

### 19 POWER

- Supply the AC mains power to the T 777.
- When the POWER switch is set to ON position, the T 777 goes to standby mode as shown by the amber status condition of the Standby LED. Press the front panel Standby button or HTR 8 remote control's [ON] button to switch ON the T 777 from standby mode.
- If you intend not to use the T 777 for long periods of time (such as when on vacation), switch off the POWER switch.
- With POWER switched off, neither the front panel Standby button nor HTR 8 remote control's [ON] button can activate the T 777.

## OPERATION

### USING THE T 777 – MAIN MENU

#### ABOUT THE ON-SCREEN DISPLAY (OSD)

The T 777 employs a simple, self-explanatory system of on-screen display “menus” that will appear on the connected video monitor/TV. These are required during the setup process (and are useful in day-to-day operation), so be sure to connect the monitor/TV before proceeding with setup.

#### DISPLAY THE OSD

Press [D], [D] or [ENTER] buttons of the HTR 8 remote control or front panel to display the T 777's Main Menu on your video monitor/TV. If the OSD does not appear, check your MONITOR OUT connections.

#### NAVIGATING THE OSD AND MAKING CHANGES

To navigate through the OSD menu options, please do the following using the HTR 8 or corresponding front panel buttons:

- 1 Press [D] to select a menu item. Use [▲/▼] or in some cases, [ENTER], to move up or down the Menu selections. Repeatedly press [D] to advance or go further into the sub-menu of desired menu item.
- 2 Use [▲/▼] to set or change the parameter value (setting) of a menu item.
- 3 Press [D] to save the settings or changes done on the current menu or sub-menu. Pressing [D] will also return the user to the previous menu or exit from a particular menu.

#### MAIN MENU

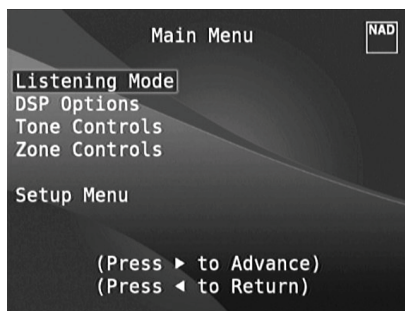

The Main Menu contains the menu options for “Listening Mode,” “DSP Options,” “Tone Controls,” “Zone Controls” and access to “Setup Menu”.

Follow the guidelines about “DISPLAY THE OSD” and “NAVIGATING THE OSD AND MAKING CHANGES” to navigate through the menu options and their sub-menu selections.

#### NOTE

*The individual configurations set forth at “Listening Mode,” “DSP Options” and “Tone Controls” are carried over whenever they are enabled at A/V Presets setting. Please see the section “A/V PRESETS” for reference.*

#### LISTENING MODE

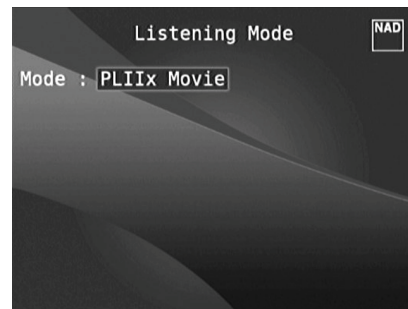

The T 777 offers distinct listening modes, tailored for different types of recording or program material. With a two-channel (Stereo) source, the following listening modes can be selected:

#### STEREO

All output is directed to the front left/right channels. Low frequencies are directed to the subwoofer if one is present in the Speaker settings. Select ‘Stereo’ when you wish to listen to a stereo (or monaural) production, such as music CD or FM broadcast, without surround enhancement. Stereo recordings whether in PCM/digital or analog form and whether surround-encoded or not encoded, are reproduced as recorded. Multi-channel digital recordings (Dolby Digital and DTS) are reproduced in “Stereo Downmix” mode via the front left/right channels only as Lt/Rt (left/right-total) signals.

#### DIRECT

Analog or digital sources are automatically played in their native formats. All the source's audio channels are reproduced directly. This mode recreates the original sound most faithfully thereby producing outstandingly high quality audio.

DIRECT listening mode is selectable only during source playback. In order to setup DIRECT as preferred listening mode, the following steps have to be undertaken.

- 1 Go to LISTENING MODE SETUP under SETUP MENU. Select LISTENING MODES. Under LISTENING MODES menu, set to “None” all the parameter settings for Dolby, DTS, PCM and Analog.
- 2 Then, go to A/V PRESETS items under SETUP MENU. Scroll to LISTENING MODE item and set to “Yes”. Store this LISTENING MODE setting to Preset 1 along with the other parameter settings by clicking “Save Current Setup to Preset”.
- 3 This saved “Preset 1” setting can now be associated to any Source. Below is a sample association.
  - a Under SOURCE SETUP (Normal View), go to SOURCE 1 and scroll down to A/V Preset and set “A/V Preset” to “Preset 1”.
  - b Now, whenever SOURCE 1 is recalled with “Preset 1” associated to it, the LISTENING MODE setting will always be DIRECT.

#### PRO LOGIC

Two-channel recordings, whether stereo or surround-encoded, are reproduced with Dolby Pro Logic surround processing, yielding output to front left/right, center and discrete left/right surround channels (assuming these are present in the current ‘Speaker Configuration’). The surround channel is monophonic, but it is reproduced in both surround speakers.

**DOLBY PRO LOGIC IIx**

Dolby Pro Logic IIx processes both stereo and 5.1 signals into a 6.1 or 7.1 channel output. At Dolby Pro Logic IIx, you can choose PLIIx Movie or PLIIx Music modes to tailor your listening experience to the source material. Dolby Pro Logic IIx surround processing yields more stable imaging and full bandwidth sound to the rear channels in Movie mode offering sound that is more similar to Dolby Digital decoding. For two channel signals, Pro Logic IIx Music mode also features three additional user controls - Dimension, Center Width, and Panorama. See also section about 'Adjusting Listening Modes' below.

The following chart shows the channels available assuming they are enabled in the 'Speaker Configuration' menu:

Listening Mode	Active Decoded Output Channels	
	6.1 Speaker System	7.1 Speaker System
Dolby Pro Logic IIx Music Dolby Pro Logic IIx Movie	Front (left & right), Center, Surround (left & right), Back Surround, Subwoofer	Front (left & right), Center, Surround (left & right) and Back Surround (left and right) and subwoofer

**DTS NEO: 6**

Two-channel recordings, whether stereo or surround-encoded, are reproduced with Neo: 6 surround with output to front left/right, center and discrete left/right surround channels plus subwoofer (assuming these are present in the current 'Speaker Configuration'). The T 777 provides two DTS Neo: 6 variations - NEO:6 Cinema and NEO:6 Music. See also section about 'Adjusting Listening Modes' below.

**EARS**

Two-channel recordings, whether stereo or surround-encoded, are reproduced with proprietary NAD surround processing with signals output to the front left/right, center and discrete left/right surround channels, plus subwoofer (assuming these are present in the current 'Speaker Configuration:'). EARS does not employ the surround back speakers (if any).

EARS extracts the natural ambience present in nearly all well-produced stereo recordings. It does not synthesize any ambience or other sonic elements and thus remains truer to the sound of the original musical performance than most other music-surround options.

Select EARS for listening to stereo music recordings and broadcasts. EARS produces a subtle but highly natural and believable ambience from nearly all "natural-acoustic" stereo recordings. Typically, these include classical, jazz, and folk genres as well as numerous examples from others. Its virtues include realistic, stable "front-stage" sonic imaging and spacious but unexaggerated ambient "virtual acoustics" that remain faithful to the original recording.

**ENHANCED STEREO**

All recordings are reproduced in stereo via the maximum speaker complement configured in the current 'Speaker Configuration.' Enhanced stereo can be useful for maximum volume from all channels or for multi-speaker background music (cocktail party) listening. For this mode, Front, Center, Surround and Back speakers can be turned ON/OFF as desired.

**ANALOG BYPASS**

All analog signals remain in the analog domain without analog-to-digital conversions. At Analog Bypass, the DSP circuitry is bypassed but full tone control functions remain. 'Bass management' or Speaker settings are also not in effect as these are DSP functions.

**ADJUSTING LISTENING MODES**

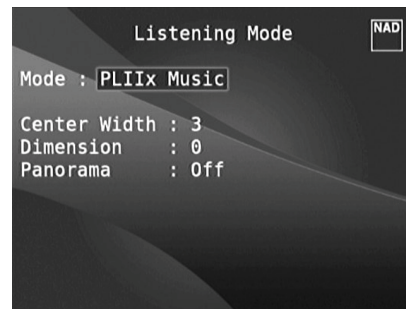

Several of the T 777's listening modes have one or more selectable variations and adjustable parameters that you can modify to suit your system or personal preferences.

**NOTE**

*Listening Mode parameter changes are maintained when you change listening modes. You may also save a modified Listening Mode for easy recall by saving it to a Preset (See 'A/V Presets' below under Setup Menu discussions).*

**PRO LOGIC IIx**

**PLIIx MOVIE** is optimized for film soundtracks.

**PLIIx MUSIC** for music recordings

**Center Width (0 to 7):** Modifies the "hard-centeredness" of the center image, by gradually mixing mono center content to the Front left/right speakers as well. A setting of 0 retains the center-channel-only default while a setting of 7 yields a fully phantom center channel.

**Dimension (-7 to +7):** Adjusts front-rear emphasis of the surround effect independently from the relative channel levels.

**Panorama (On/Off):** Adds a "wraparound" effect by extending some stereo content into the surround channels.

**NOTE**

*Pro Logic IIx mode will decode as Pro Logic II mode when the BACK surround speakers are set to "OFF" from "Speaker Configurations" menu. See also section about "Speaker Configurations" under "Speaker Setup" of the Setup Menu.*

**DTS NEO: 6**

**NEO: 6 Cinema** is optimized for film soundtracks.

**NEO: 6 Music** for music recordings

**Center Gain (0 to 0.5):** Adjust for better center image in relation to the surround sound channels.

## OPERATION

### USING THE T 777 – MAIN MENU

#### DSP OPTIONS

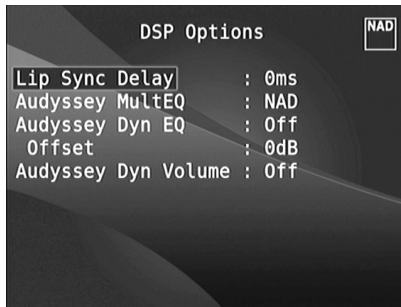

The following signal processing parameters can be setup under the DSP (Digital Signal Processing) Options menu.

#### LIP SYNC DELAY

DSP Options has the feature 'Lip Sync Delay' whose function is to match any delay that may occur in the picture relative to the audio.

By varying 'Lip Sync Delay' from 0ms to 120ms, one can delay the audio output in order to synchronize it with the video image.

#### AUDYSSEY MultEQ

Audyssey MultEQ becomes available among the DSP options only after successfully completing Audyssey Auto Calibration (accessible through the Setup Menu). Refer also to Audyssey Auto Calibration segment of the Speaker Setup under Operation – Using the T 777 – Setup Menu.

Audyssey MultEQ can be set to the following levels

**Audyssey:** Audyssey developed target curve.

**Flat:** This setting is appropriate for very small or highly treated rooms in which the listener is seated quite close to the loudspeakers. MultEQ filters are used in the same way as the Audyssey curve, but it does not apply a high frequency roll-off.

**NAD:** Ideal "in room" response developed by NAD engineers along with Audyssey Engineers.

**Off:** MultEQ filters are not used or no measurement process at all.

#### NOTES

- "AUDYSSEY" and a lit green box icon are illuminated at the VFD if NAD, Audyssey or Flat is selected. If "Off" is selected, "AUDYSSEY" and the green box icon will not be illuminated.
- If NAD, Audyssey or Flat is selected and changes are done at the "Tone Controls", "Speaker Configuration", "Speaker Levels" and "Speaker Distance" settings, "AUDYSSEY" and a lit red box icon are illuminated at the VFD. Restore the parameter to its previously calibrated Audyssey setting by adjusting back the altered configuration.
- Audyssey MultEQ options can also be directly selected or changed using HTR 8's AUDYSSEY button with DEVICE SELECTOR set to AMP mode. Toggle AUDYSSEY button to select "Audyssey MultEQ" and then use the [▲/▼] to select through the Audyssey MultEQ options. Press AUDYSSEY again to save the selected option and at the same time move on to the next menu setting or exit the menu setting altogether.

#### AUDYSSEY DYN EQ (AUDYSSEY DYNAMIC EQ)

Audyssey Dynamic EQ solves the problem of deteriorating sound quality as volume is decreased by taking into account human perception and room acoustics. By carefully combining information from incoming source levels with actual output sound levels in the room, Audyssey Dynamic EQ delivers unprecedented sound reproduction at all volume levels.

Audyssey Dynamic EQ selects the correct frequency response and surround volume levels moment-by-moment. The resulting bass response, octave-to-octave balance and surround impression remained the same despite changes in volume.

Audyssey Dynamic EQ is designed to work in conjunction with Audyssey MultEQ. Dynamic EQ determines the proper loudness compensation based on the sound pressure level measurements MultEQ provides. Audyssey Dynamic EQ working in tandem with Audyssey MultEQ provides the right listening conditions for every listener at any volume level.

**On:** Activate Audyssey Dynamic EQ function.

**Off:** Defeat Audyssey Dynamic EQ function.

**Offset:** Adding a Volume Offset will have the effect of reducing the amount of boost applied by Dynamic EQ, for any given volume setting. As a consequence, the amount of overall digital attenuation required is also reduced. For example, with the Offset set to 10dB, and a volume setting of -30dB, the loudness curve selected will be for a volume level of -20dB.

The offset level can be set from 0dB to 15dB.

#### NOTE

*Audyssey Dynamic EQ and Audyssey Dynamic Volume (see below) can be directly selected or changed using HTR 8's AUDYSSEY button with DEVICE SELECTOR set to AMP mode. Toggle AUDYSSEY button to select "Dyn EQ" or "Dyn Vol" and then use the [▲/▼] to select through their respective options. Press AUDYSSEY again to save the setting and at the same time move on to the next option or exit the menu setting altogether.*

#### AUDYSSEY DYNAMIC VOLUME

Audyssey Dynamic Volume delivers consistent volume playback levels, anticipating sudden spikes and dips in volume and compensating for them in real time. Audyssey Dynamic Volume monitors the volume of program material moment-by-moment, maintaining the desired listening level for all content while optimizing the dynamic range to preserve the impact.

Audyssey Dynamic Volume includes Audyssey Dynamic EQ, which compensates for deteriorating sound quality as volume is decreased by taking into account human perception and room acoustics. These two technologies enable the full frequency response of the source at its original level to be reproduced at any listening level. Even at lower listening volumes, Dynamic Volume ensures that the richness and dynamics of the response are maintained.

Audyssey Dynamic Volume can be set to the following levels

**Light:** Provide the least adjustment to the loudest or softest sound level.

**Medium:** Setting that prevents loud and soft sound from being much louder than their respective average sound levels.

**Heavy:** Affect volume the most by causing all sound to be of equal loudness.

#### NOTE

*Audyssey Dynamic EQ must be set to "On" to activate Audyssey Dynamic Volume. If Audyssey Dynamic EQ is set "Off", Audyssey Dynamic Volume will also remain "Off".*

#### IMPORTANT NOTICE

*If Audyssey Auto Calibration is not set up, the relative balance of your system's loudspeakers has to be manually adjusted (with the aid of a SPL meter) for Audyssey Dynamic Volume and Audyssey Dynamic EQ to be effective. If the speakers are not properly calibrated, the corresponding Audyssey Dynamic Volume and Audyssey Dynamic EQ responses could be distorted. Refer also to the item about "USING SPL METER" in the SPEAKER LEVELS section below.*

**TONE CONTROLS**

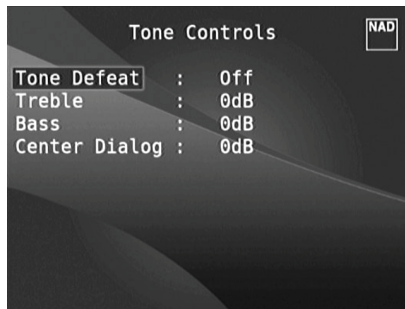

The T 777 has three Tone Control levels – Treble, Bass and Center Dialog. Bass and Treble controls only affect the low bass and high treble leaving the critical midrange frequencies free of coloration. The Center Dialog ('Dialog' in the VFD) control boosts the 'presence' of the midrange region improving intelligibility of speech.

These controls allow one to tweak on-the-fly, the frequency response of the source during playback. The control setting could be adjusted by navigating through the Tone Controls' OSD menu via a combination of [ENTER] and [▲/▼/◀/▶] keys. The same can be managed directly by pressing the front panel's TONE button and then rotating the VOLUME knob to select desired setting.

Maximum and minimum values for all three Tone Control levels are ±10 dB.

'Tone Defeat' gives one the choice of varying or completely bypassing the tone control section of the T 777. If 'Off' ('Tone Active' in the VFD) is selected, the Tone Control circuits are active.

Select 'On' ('Tone Defeat' in the VFD) to bypass the Tone Controls effectively defeating the effect of the tone control circuits.

**NOTE**

*Tone Controls options can be directly selected or changed using HTR 8's [TONE] button with DEVICE SELECTOR set to AMP mode. Toggle [TONE] button to select "Treble", "Bass" or "Dialog" and then use the [▲/▼] to adjust their respective levels. Press [TONE] again to save the settings and at the same time move on to the next parameter or exit the parameter setting altogether.*

**ZONE CONTROLS**

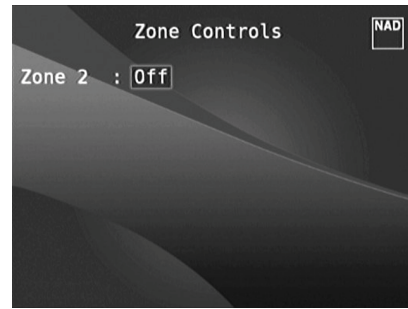

Depending on the settings made at the separate 'Zone Setup' menu under the 'Setup Menu' section discussion, the applicable Zone can be configured and managed via this 'Zone Controls' window.

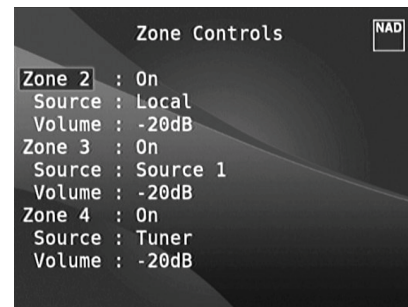

Select 'On' to activate the applicable Zone. When activated, the Source input for the particular Zone can be allocated by selecting through the following inputs – All enabled Sources, Front Input, Media Player, Tuner and Local.

Select 'Local' as your selected Zone's Source input if you wish to enjoy the same source as the main Zone and allow simultaneous listening, but with full separate volume levels.

If a Zone is set to 'Off', it is deactivated or powered off.

'Volume' refers to the adjustable secondary Zone 2 Volume level that can be increased or decreased using the ▲/▼ buttons of the HTR 8 or front panel's corresponding navigation buttons.

When a Zone is activated, a corresponding Zone number is illuminated at the VFD. Zone 2 is always available to be configured at 'Zone Controls' menu. For Zone 3 and Zone 4 to become available at the 'Zone Controls' window, their corresponding 'Mode' in the 'Zone Setup' menu under the 'Setup Menu' section should be set to 'Zone (Audio Only)'.

**NOTE**

*The ZR 7 remote control will only control Zone 2 applications. Zone 3 and Zone 4 could be configured and managed at the appropriate Zone OSD menu using the front panel navigations buttons as well as the corresponding keys on the HTR 8 remote control.*

# OPERATION

## USING THE T 777 – SETUP MENU

### SETUP MENU

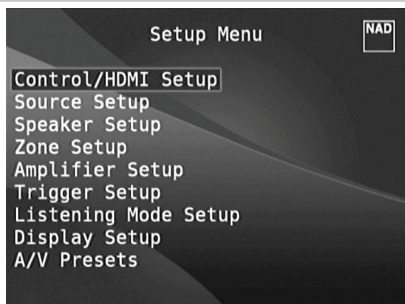

The Setup Menu allows one to customize the operation of the T 777 to the ancillary equipment used in one's specific AV system. Unless your system exactly matches the factory defaults as shown in the accompanying Quick Start Guide, you will need to use the setup menu to configure the inputs of the T 777.

At Setup Menu, the following are configurable – Control/HDMI Setup, Source Setup, Speaker Setup, Zone Setup, Amplifier Setup, Trigger Setup, Listening Mode Setup, Display Setup and A/V Presets.

To access and navigate through Setup Menu and its sub-menu selections, please refer to and follow the directions stated in the sections 'Display the OSD' and 'Navigating the OSD and Making Changes.'

### CONTROL/HDMI SETUP

The T 777 supports HDMI Control (CEC) and Audio Return Channel (ARC) functions. Both functions are possible if external devices that also support both features are interconnected to the T 777 via HDMI connection.

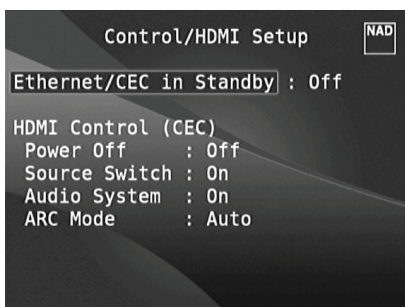

#### ETHERNET/CEC IN STANDBY

- On:** Enables HDMI Control (CEC) feature.
- Off:** T 777 stops responding and sending any CEC messages. CEC feature is effectively defeated.

#### HDMI CONTROL (CEC)

Consumer Electronics Control (CEC) is a set of commands that utilizes HDMI's two-way communication to allow for single remote control of any CEC-enabled devices connected with HDMI. A CEC command will trigger the necessary commands over HDMI for an entire system to auto-configure itself to respond to the command.

When devices that support HDMI Control (CEC) are connected, the following modes of operation can be executed via the T 777 or the external device using any of the device's remote control.

- Off:** Applies to all CEC options below. At "Off" setting, particular CEC feature is defeated.
- Power:** At "On" setting, the T 777 will automatically go to standby mode if it receives a CEC standby command. On the other hand, if the T 777 receives a CEC power up command, the T 777 will correspondingly switch ON from standby mode.

**Source Switch:** At "On" setting, the T 777 will automatically switch sources if another CEC device requests a Source change. For example, if PLAY is pressed on a BD Player with CEC, the T 777 and TV with CEC will automatically switch to their respective input connections – the T 777 switching to the HDMI input where the BD Player is connected while the TV will switch to its input where the T 777's HDMI MONITOR OUT is connected. This completes the auto-configuration – the BD Player is automatically played back using the T 777 and TV.

**Audio System:** At "On" setting, the T 777 will broadcast a CEC message indicating it is an active audio system. A CEC compatible TV will usually mute its audio output when this happens. When this option is enabled, the T 777 will also respond to CEC volume and mute commands. For example, a CEC TV may forward the volume commands from its remote to the T 777.

**ARC Mode:** Audio Return Channel (ARC) enables an ARC-enabled TV to send audio data "upstream" to T 777.

This option has three choices: Off, Auto or Source Setup.

**Auto:** When set to Auto, the T 777 will automatically attempt an ARC audio connection to the TV whenever the TV announces over CEC that it has become the active source. If an ARC connection can be established, the T 777 will output the ARC audio signal no matter what source is selected on the T 777 and will show "HDMI ARC" on the VFD. The Auto option tends to work best when all your devices support CEC and the Source Switch option is set to On.

**Source Setup:** When set to Source Setup, you can select "ARC" for the digital audio input in the source setup screen. When you select a source on the T 777 which is set for ARC, the T 777 will attempt to initiate an ARC connection with the TV. When using this option, you would probably also want to make sure Source Switch is off otherwise other CEC devices may keep changing the T 777 source when you want it to remain on the ARC source.

#### IMPORTANT NOTES

- "Audio System" must be set to "On" for "ARC mode" to manifest as an option.
- Audio and video will continuously stream from the HDMI source with CEC to the TV with CEC even if the T 777 is at standby mode.



### SOURCE SETUP

There are three sub-menu items under Source Setup. These are Source Setup (Normal View), Source Setup (Table View) and iPod Setup.

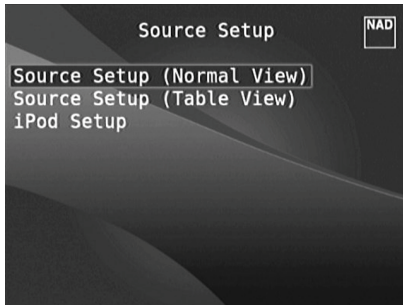

### SOURCE SETUP (NORMAL VIEW)

The Source Setup (Normal View) menu makes it possible to set, allocate or change the following settings.

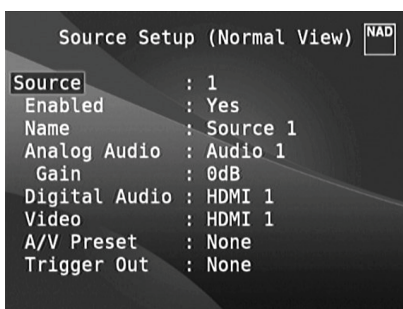

### SOURCE

The T 777 is equipped with ten configurable Sources. A particular Source can be enabled or disabled, renamed, assigned analog and digital audio sources, video sources, A/V Presets, Trigger settings among other settings.

These settings can be implemented through the following parameters.

### NOTE

*Source 5 is defaulted to iPod. Change the default setting of Source 5 to iPod via the following procedure*

- 1 Go to "iPod Setup" menu under the "Source Setup" menu. At "iPod Setup" menu, set "Enabled" to "No".
- 2 Then, go back to "Source Setup" menu and select "Source Setup (Normal View)".
- 3 Go to Source 5 and set "Enabled" to "Yes".  
*Source 5 can now be configured to any desired settings.*

### ENABLED

One can enable/disable a Source via this option. This is particularly useful if only few Sources are used and one directly selects the Source from the front panel, bypassing unused sources.

Select "Yes" to enable the particular Source or "No" to disable the Source.

### NAME

A new Name maybe assigned to a Source label. For example, if your BD player is attached to "Source 1", it is possible to rename "Source 1" to "BD".

In order to rename the Source label, scroll to the "Name" parameter. Press [D] to go to the first character. Then, press [▲/▼] to pick through the alphanumeric selections.

Press [D] to move to the next character and at the same time save the changes done on the current character. The name can be as long as twelve characters.

The new Name will be shown in the VFD as well as on the OSD.

### ANALOG AUDIO

The T 777 has nine analog audio inputs including 7.1 input. These analog inputs - Audio 1 - 6, Audio Front, Audio MP and 7.1 Input can be variably assigned to each Source.

Scroll to "Analog Audio", press [D] and then [▲/▼] to select and assign an analog audio input to the particular Source. There are three choices – Audio, 7.1 Input or Off.

When "Audio" is chosen, press [D] and then [▲/▼] to select and assign the desired audio input – 1 to 6, Front and MP.

Select "7.1 Input" to choose the audio signal fed to "7.1 Channel Input".

If "Off" is selected, no incoming analog audio signal is selected by the particular Source. Note that when "Analog Audio" is set to "Off", "Gain" will not be enabled as an option.

### NOTE

*An incoming digital signal present at the assigned digital input will always take precedence over the assigned analog audio input, even if both are present. To maintain the analog audio input for the particular Source, select "Off" at the "Digital Audio" setting of the same "Source" menu.*

### GAIN

Gain adjustment allows all sources to play back at the same volume level so you don't need to adjust the volume every time a new source is selected. It is generally preferable to reduce the level of the loudest source rather than making louder the softer sources.

Scroll to "Gain", press [D] and then [▲/▼] to step through the desired level from -12dB to 12dB.

Note that when "Analog Audio" is set to "Off", "Gain" will not be enabled as an option.

## OPERATION

### USING THE T 777 – SETUP MENU

#### DIGITAL AUDIO

To take advantage of the T 777's high performance surround and digital audio circuitry, it is advisable that its sets of Digital Audio input are selected.

There are three types of Digital Audio input for the T 777. These are HDMI, Optical and Coaxial digital input. A fourth option is "Off" whereby no incoming digital audio signal is selected by the particular Source.

The desired digital audio input for a particular Source can be selected by scrolling to "Digital Audio", press [D] and then [▲/▼] to step through the desired digital input source. After finalizing the desired type of Digital Audio input, press [D] and then [▲/▼] again to select the specific Digital Audio input.

The following are the sets of assignable Digital Audio input:

**HDMI** → HDMI 1 - 6, HDMI Front

**Optical** → Optical 1 - 3

**Coaxial** → Coaxial 1 - 3

#### NOTE

*An incoming digital signal present at the assigned digital input will always take precedence over the assigned analog audio input, even if both are present. To maintain the analog audio input for the particular Source, select "Off" at the "Digital Audio" setting of the same "Source" menu.*

#### VIDEO

There are four types of video input a particular Source could be assigned. These are HDMI, Component, S-Video and Video input. Another option is "Off". Select "Off" if it is intended not to assign any video input to a particular Source.

Navigate through the Video input selections by pressing [D] and then [▲/▼] to step through the selections. The following are the sets of assignable Video input.

**HDMI** → HDMI 1 - 6, HDMI Front

**Component Video** → Component 1 - 3

**S-Video** → S-Video 1 - 3, S-Video Front

**Video** → Video 1 - 3, Video Front

#### IMPORTANT NOTE ABOUT THE VIDEO PERFORMANCE OF T 777

*The T 777 utilizes an NAD-engineered field-programmable gate array (FPGA) that is capable of enabling the conversion of analog video to digital video. This allows a single cable connection to your TV for all sources while maintaining the source's native resolution. Interlaced video is converted to progressive scan over HDMI allowing complete compatibility with latest HD TVs.*

*The T 777 also supports HDMI features that include compatibility with a broad range of 3D and HD digital video sources and displays.*

#### A/V PRESET

A particular Source can be assigned a stored Preset. The parameters set up in the selected Preset number will be adopted into the particular Source it is assigned (Please refer to the separate section on "A/V Presets" for further understanding of Preset settings).

Scrolling to "A/V Preset" and by pressing [D] and then [▲/▼], a Source could be assigned a Preset number ranging from Preset 1 to 5.

If it is desired not to assign the particular Source a Preset setting, select "None".

#### TRIGGER OUT

Trigger Out feature for a particular Source is dependent upon the configurations done in a separate menu on Trigger Setup (See "Trigger Setup" below). If "Source Setup" is assigned to all three Trigger output (Trigger Out 1-3) in the separate "Trigger Setup" menu window, a particular Source can have the following Trigger Out combinations

**Trigger Out:** 1 → 2 → 1 + 2 → 3 → 1 + 3 → 2 + 3 → 1+2+3

These combinations are dependent upon the assignment of "Source Setup" for Trigger 1 Out, Trigger 2 Out or Trigger 3 Out at the "Trigger Setup" menu.

Another option is "None" whereby the particular Source is not assigned any Trigger Out.

For "Trigger Out" to become enabled and assignable at "Source Setup (Normal View)" menu, make sure to carry out or note the following beforehand

- In the separate "Trigger Setup" menu, assign Trigger 1 Out, Trigger 2 Out or Trigger 3 Out to "Source Setup."
- "Trigger Out" will not appear as an option at the Source Setup (Normal View) menu if at the separate "Trigger Setup" menu, Trigger 1 Out, Trigger 2 Out or Trigger 3 Out are all assigned to "Main, Zone 2, Zone 3, Zone 4, or Zone 2+3+4"; with not even one "Trigger Out" port allocated to "Source Setup."

#### SOURCE SETUP (TABLE VIEW)

The Source Setup (Table View) reflects the settings made in the Source Setup (Normal View) menu. All the Source settings are summarized and displayed in tabulated form in the Source Setup (Table View).

	Audio	Vid	P	Trg	Name
1	A1	H1	H1	- - -	Source 1
2	A2	H2	H2	- - -	Source 2
3	A3	C1	C1	- - -	Source 3
4	A4	O1	V1	- - -	Source 4
5	A5	S3		- - -	iPod
6					
7	71	--	C2	- - -	Source 7
8	AF	HF	HF	- - -	Front Input
9	AM	--	--	- - -	Media Player
T				- - -	Tuner
(Press ENTER to Disable)					

Navigating through the Source Setup (Table View) via a combination of [D] and then [▲/▼] buttons, one will have the benefit of directly changing the settings for "Audio", "Video", "Preset" and "Name" without going back to the Source Setup (Normal View) menu.

Highlight a particular Source number and then, toggle [ENTER] button to enable or disable said Source number.

### iPod SETUP



The iPod Setup menu allows you to preset the following associated settings when iPod is the selected source.

**Enabled:** Select “Yes” to enable iPod as a Source or “No” to disable it.

**Auto Connect:** Select “Yes” to automatically enable and connect the iPod player docked in the linked NAD iPod docking station when Source 5 (the default iPod source allocation in the T 777) is selected. Select “No” if you do not want a docked iPod to be automatically connected.

**Menu Timeout:** Set the time for the OSD to revert to the “Now Playing” display when the iPod menu has been left idle (no scrolling or navigation being done) for the specified time out time. For the “Now Playing” OSD to be shown, there should be a song paused or being played before going to the iPod menu. You can set the “Menu Timeout” between the range 5s to 60s at 5s increments. If you do not want for the menu to timeout, select “Off”.

### SPEAKER SETUP

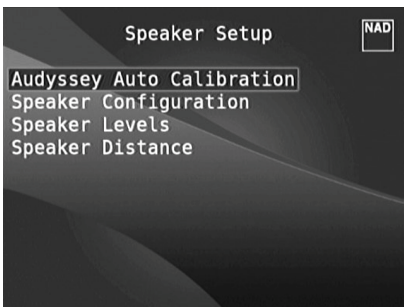

After connecting all ancillary sources and other combinations, the Speaker Setup menu will guide you on how to manage and setup your speakers in order to achieve optimum sound acoustics in your listening environment.

The following are the Speaker Setup Menu sections.

### AUDYSSEY AUTO CALIBRATION

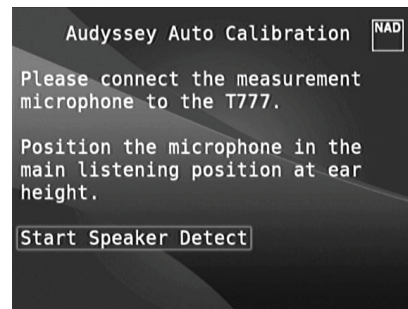

It has been shown that many, if not most, surround sound systems are not accurately setup and calibrated. To be done properly, calibration requires special knowledge and instrumentation that the average person probably doesn't possess.

The Audyssey Auto Setup and Calibration featured in T 777 uses a microphone, along with sophisticated digital electronics built into your T 777, to automatically setup and calibrate the T 777 to the exact speakers

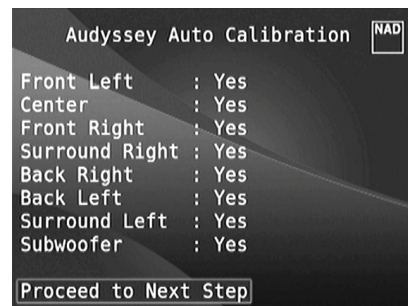

and speaker placement of your own unique Home Theatre.

The following measurements are performed:

- **Detection :** Speaker configuration is detected including number of surround speakers and whether a subwoofer and center channel is connected.
- **Size :** T 777 crossover is set based on each channel's signal handling capability and the subwoofer crossover is automatically set.
- **Level :** SPL of each speaker is matched within 1dB at the microphone position.
- **Distance :** is accurately set to within 1 foot (30 centimeters) of the microphone for each speaker position.
- **Polarity :** the setup program will detect and notify the user if any speakers are connected improperly. Incorrect polarity can ruin the illusion of realism offered by surround sound.

This is a one-time set up, unless speakers are moved or changed, in which case the calibration should be performed again.

## OPERATION

### USING THE T 777 – SETUP MENU

#### AUDYSSEY MultEQ XT ROOM ACOUSTICS CORRECTION

Sound reflecting from room boundaries can disturb the spatial illusion of surround sound, and can also distort the tonal balance of the system. Professional Acoustical Engineers often add wall treatments and even move walls and relocate speakers to improve system performance, but for the average Home Theatre, this is either too expensive or just not a practical solution.

Audyssey MultEQ XT, using multiple measurements from the actual listening positions, and processing this information using very sophisticated digital signal processing, is able to “precondition” the signal to effectively make the walls disappear. This creates a ‘family size’ sweet spot where the sound and spatial cues are very accurately reproduced.

MultEQ XT is designed to tame room acoustics without changing the sonic character of your loudspeakers. While it will make the most of whatever loudspeakers you have, it will not make poor speakers sound like good ones!

Connect the Audyssey microphone jack into the front panel's MP/MIC input and the Audyssey Auto Calibration wizard will guide you through a simple step-by-step configuration. Once setup and calibrated, the next greatest improvement in performance is obtained by eliminating the acoustic interference caused by room boundaries interacting with your speakers.

#### MEASUREMENT IS THE FIRST STEP

The sound at each listening position (up to 8 positions) is calibrated using the same microphone used during the setup phase.

A special test tone is sent to each speaker and the data is memorized by the T 777. The duration of calibration may take some time depending on the number of speakers as well as the number of measuring points. After all positions are measured, the DSP calculates the ideal system response for your particular room and speaker setup.

If some inconsistencies or discrepancies are detected during the Audyssey calibration, the process maybe interrupted or the problem is shown in the particular setup window. A notice screen is correspondingly displayed. After following and undertaking the displayed instructions, re-start the Audyssey calibration again. When the measurements are finalized, Audyssey calculates the ideal system response for your particular room and speaker setup.

#### NOTE

*The test tone emitted during measurement is loud. If you cannot withstand the test tone level, it is advisable that you stay away from the room or location where the speakers are being calibrated. Return to the room or location after each calibration to change the microphone's position or to finalize the calibration.*

#### NEXT A TARGET CURVE MUST BE CHOSEN

Because loudspeaker designers assume that their products will be used in typical domestic rooms, they are ‘voiced’ to work in this environment. It is assumed that the room will add some bass reinforcement and will absorb some treble energy. Thus if we effectively ‘remove the walls with room correction, and set the speakers for flat response, you may find this sounds too bright in the treble and too weak in the bass region.

NAD engineers have done extensive research in this area of room acoustics, and along with Audyssey engineers developed what we believe is the ideal ‘in room’ response curve. We include this NAD EQ, along with an Audyssey developed EQ as the two best choices. The response curves shown below typify NAD EQ room correction process.

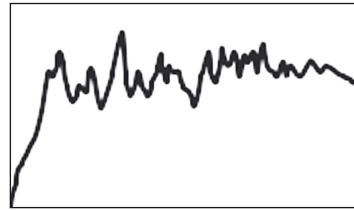

Room Response measured by Audyssey microphone

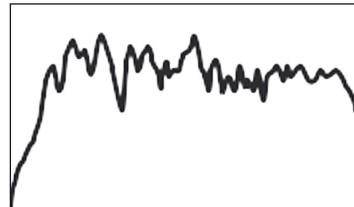

Inverse Correction Filter calculated by NAD T 777

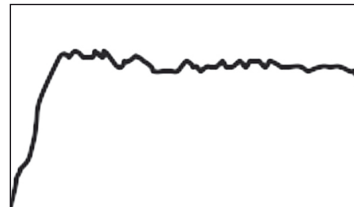

Corrected Room Response

Flat EQ is a third option, but not one that we recommend for listening (it is useful for verifying system performance when using external instrumentation).

Select the Target Curve you find to be most satisfactory by pressing the Audyssey key of the remote. The MultEQ XT corrected response can also be bypassed if you wish.

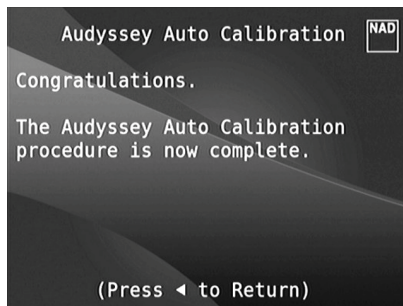
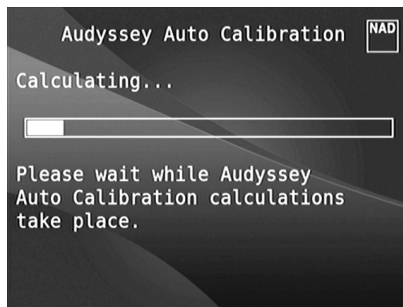

It is recommended that you take full advantage of the T 777's Audyssey Auto Calibration feature for your speaker setup. However, if you desire to setup your speakers manually or if you already had run Audyssey Auto Calibration but would like to make adjustments, the following sections on Speaker Configuration, Speaker Levels and Speaker Distance can also be followed and implemented.

#### NOTE

*During manual setting of your speakers, previously calibrated Audyssey settings could be retrieved by re-adjusting back the altered configurations as highlighted by an asterisk.*

# OPERATION

## USING THE T 777 – SETUP MENU

ENGLISH

### SPEAKER CONFIGURATION

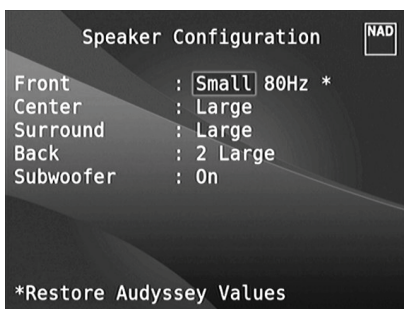

Every surround-sound system requires “bass-management” to direct low-frequency content from any or all channels to the speakers best able to reproduce it. For this function to operate correctly, it is important that you correctly identify your speakers’ capabilities. We use the terms “Small” and “Large” (and “Off”) but note that physical size may be irrelevant.

- A “Small” speaker is any model, regardless of physical size, that lacks significant deep-bass response, that is, below about 200 Hz.
- A “Large” speaker is any full-range model; that is, one with deep-bass response
- An “Off” speaker is one that is not present in your system. For example, you might not have any surround-back speakers installed; in that case, you would set the ‘Surround’ setup item to “Off”.

The Speaker Configuration is “global”; that is, it remains in force with all input and listening modes. However, speaker settings are part of the T 777’s Preset system. Consequently, multiple speaker settings can be stored for easy recall as different types of recordings or listening modes require.

Speaker Configuration can be managed and adjusted by pressing a combination of [D] and then [▲/▼] keys. Set “Front”, “Center” and “Surround” to “Large”, “Small” (40Hz to 200Hz) or “Off” as your subsystem’s speakers require.

The “Back” speakers can either be one or two speakers. Set “Back” to either 1 or 2 speakers as per availability. Set “Subwoofer” to “On” or “Off” selecting “On” only if you have a subwoofer connected to the T 777’s SUBW1 or SUBW2 output jack. If “Subwoofer” is set to “Off”, “Front” speakers will automatically be set to “Large”.

### ENHANCED BASS

When the subwoofer is set to “On” and “Front” is set to “Large”, the option “Enhanced Bass” becomes available. Normally, with speakers set to “Large” the subwoofer is not active. The Enhanced Bass option allows full range operation of the speakers with the additional bass contribution of the subwoofer. This feature is particularly useful when one wants to experience maximum bass output. Please note that due to acoustic cancellation effects, the bass response may be uneven when using this setting

You can set Subwoofer to “On” even with “Large” front speakers, in which case bass content from any channels set to “Small” will be routed to both the subwoofer and to the front speakers; LFE-channel signal will pass only to the sub. In most subwoofer-equipped systems, setting front speakers to “Small” is usually the better option.

All the speakers’ low frequency content can be directly adjusted within the range 40Hz to 200Hz.

### NOTE

*The configurations set forth at ‘Speaker Setup’ are carried over whenever it is enabled during A/V Preset setting. Please see also the section ‘AV Presets’ for reference.*

### SPEAKER LEVELS



Adjusting the relative balance of your system’s loudspeakers ensures that surround-sound recordings, whether music or film, will present the balance of effects, music, and dialog that the artists intended. Additionally, if your system incorporates a subwoofer it establishes a correct relationship between the volume of the subwoofer and the other speakers, and thus of low-frequencies (bass) to other sonic elements.

### USING AN SPL METER

It is quite practical to perform the T 777 level setup routines “by ear”, and careful work will produce acceptably accurate results. However, the use of an inexpensive sound-pressure level (SPL) meter, such as Radio Shack part number 33-2050, makes this task easier, more accurate and more repeatable. Ownership of such a meter could prove a valuable audio tool.

The SPL meter should be placed at the primary listening position, at approximately the height of the seated listener's head. A tripod is helpful but with a little duct tape almost anything — a pole lamp, music-stand, or ladder-backed chair, for example — can do as well. Just be sure that no large acoustically reflective surfaces obstruct or are near the microphone element.

Orient the meter with its microphone (usually at one end) pointing straight up toward the ceiling (not toward the speakers) and ensure that “C” weighting scale is selected. Set the meter to display 75 dB SPL. On Radio Shack meters, this necessitates either setting the meter to its 80 dB range and taking your readings at the -5 point or selecting the 70 dB range and reading at the +5 point.

### SETTING SPEAKER LEVELS AT TEST MODE

While at ‘Speaker Levels’ menu, press the HTR 8 remote’s [TEST] key activating the T 777’s Speaker Levels balancing test signal. You will hear a “surf” sound as you step through your speakers (‘test’ appears to the right side of the current speaker), beginning with the Front Left. If you do not hear the test signal, check your speaker connections or your ‘Speaker Setup’ OSD menu settings.

Use the remote’s [▲/▼] keys to adjust the loudness of the noise output from the currently playing channel to the required level (it’s usually simplest to begin with the Front Left). As you cycle the test signal around the speakers, the OSD will highlight the currently playing channel. The “level offset” reading on the right will change by 1 dB increments; ±12 dB adjustment is available. Press ‘ENTER’ to adjust the next speaker.

### NOTE

*If you are balancing levels “by ear”, choose one speaker—usually the center—as a reference and adjust each of the others in turn to “sound as loud” as the reference. Be sure that you remain in the primary listening position while balancing all channels.*

To produce the same SPL meter reading (or subjective loudness), use the remote’s [▲/▼] keys to adjust each speaker.

### NOTES

- All speakers must be in their final locations before level-setting.
- Your subwoofer (if any) should be set with its integral crossover defeated, or if undefeatable, set to its highest-possible frequency if you are using the T 777’s Subwoofer output. Final subwoofer-level adjustment “by-ear,” using music and film sound material, is frequently useful.
- Due to the effects of room acoustics, matched-pair speakers (front; surround; back) will not always calibrate to exactly the same level offset readings.

You can exit ‘Test’ mode at any time by pressing [⏏] key, bringing you back to ‘Speaker Setup’ menu. You can also press the [TEST] key to discontinue the ‘Test’ mode.

### SPEAKER DISTANCE

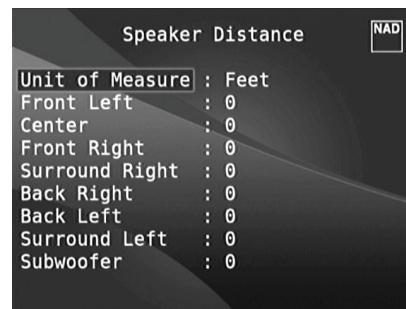

Your system’s speaker distance settings are a subtle but important refinement of your setup. Informing the T 777 of the loudspeaker-to-listener dimensions of each speaker automatically imposes the correct delays, optimizing imaging, intelligibility and surround-sound ambience. Enter your dimensions with precision within about 1 foot (30 cm).

### SETTING SPEAKER DISTANCE

While at ‘Speaker Distance’ menu, use the [▲/▼] keys to individually set Front Left, Center, Front Right, Surround Right, Back Right, Back Left, Surround Left and Subwoofer to the distance measuring from your principal listening position to the front surface of their corresponding loudspeakers. Distance can be set up to 30 feet or 9.1 meters. Distance can be displayed as feet or meters selectable at the ‘Unit of Measure’ item.

### ADJUSTING THE VOLUME

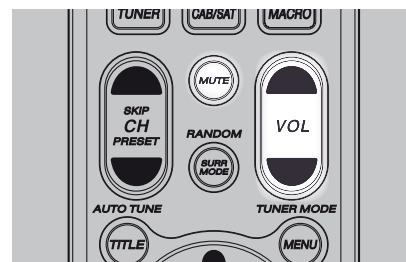

In addition to the Volume knob, use the HTR 8’s [VOL ▲/▼] to adjust the “master volume” of the T 777 raising or lowering the channels altogether. A momentary keypress will change the master volume by 1 dB increments. If you hold down [VOL ▲/▼], the master-volume change will “run-on” until the key is released.

Since recordings vary considerably in overall average level, there is no imperative to listen at any particular master-volume setting. A setting of -20 dB may sound “as loud” from one CD or DVD as -10 dB does from another.

The T 777 will power-up from Standby mode at whatever master volume setting was last used; however, if the prior setting was greater than -20 dB, the T 777 will power up at -20 dB. This prevents inadvertently beginning a session at excessive volume.

### MUTING THE SOUND

Use the HTR 8’s [MUTE] key to silence all channels completely. Muting is always available regardless of the source or listening mode selections.

### NOTES

- Changing input or listening-mode selections does not release muting.
- Adjusting the volume level via the HTR 8 or the front panel volume knob will automatically release the mute function.

## OPERATION

### USING THE T 777 – SETUP MENU

#### ADJUSTING CHANNEL LEVELS 'ON THE FLY'

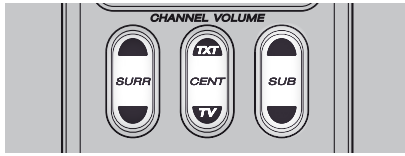

You can make changes to the relative levels of center, surround and subwoofer outputs without having to go into the 'Speaker Levels' menu. This is very convenient in circumstances like increasing (or tone down) a film's dialog level by raising (lowering) the center channel or reducing excessive deep bass (or enhance deep bass) by lowering (raising) the subwoofer level.

Use the HTR 8's 'SURR','CENT' and 'SUB' keys for direct-access level adjustment of these channels over a range of  $\pm 6$  dB.

The surround back channels (if any) adjust in lockstep with the surround channels.

#### NOTE

*Level settings adjusted 'On the Fly' are added or subtracted to the setup levels established at the T 777 level-calibration routine as invoked by the HTR 8 'Test' key. However, selecting any Preset will revert the channel levels to those stored in the preset. It will also take T 777 off the levels set via Audyssey Auto Calibration.*

#### ZONE SETUP

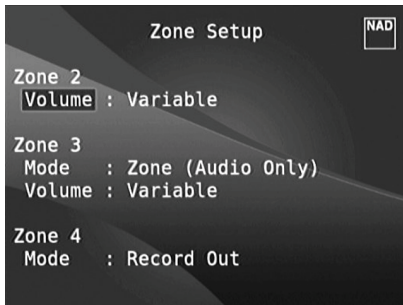

The Zone feature allows one to simultaneously experience in different zones of the house multiple sound sources from all enabled Sources as well as from Front Input, Media Player and Tuner.

The T 777 has three configurable Zones – Zone 2, Zone 3 and Zone 4. Use a combination of [▲/▼/▶/◀] and [ENTER] keys to navigate through the Zone Setup menu parameters.

#### VOLUME

Zone 2 have Fixed and Variable volume control. When set to 'Variable' and while at the 'Zone Controls' menu OSD, the Zone 2 Volume level can be adjusted using the HTR 8's [▲/▼] or the corresponding front panel navigation buttons or directly via ZR 7's [VOL ▲/▼].

On the other hand, if Volume is set to 'Fixed', the Zone 2 Volume is set to a preset dB level and thereafter the Zone's volume can be varied via the volume control of the separate amplifier it is fed into.

#### MODE

Zone 3 and Zone 4 can be configured into two modes - Record Out and Zone (Audio Only). If the selected mode is "Record out", the audio of the assigned Source is directly sent out to the applicable Audio output (See Item 3 AUDIO 1-6/VIDEO 1-3/S-VIDEO 1-3). When Zone 3 or Zone 4 is set to "Record Out" mode, they will not be available at the "Zone Controls" section of the Main Menu window.

Zone 2 and Zone 3 'Volume' will function the same way as that of Zone 2 when 'Mode' is set to 'Zone (Audio Only)'

See discussion also on 'Zone Controls' at the Main Menu.

#### NOTE

*The ZR 7 remote control will only control Zone 2 applications.*

#### AMPLIFIER SETUP



If the surround back speakers are not used in the main zone, their surround back amplifier channels could be assigned for Main back, Main Front (Bi-Amp) and multi-zone use.

The Surround Back amplifier is configurable through the following settings

- **Main Back:** Assign as surround back speakers.
- **Main Front (Bi-Amp):** Provide a bi-amp mode for the Main Front speakers (Left and Right) speakers thus reproducing the Front Left and Front Right amplifier channel outputs.
- **Zone 2:** Assign the surround back amplifier channels to supply Zone 2 speaker level outputs from the surround back speaker terminals.
- **Zone 3:** Assign the surround back amplifier channels to supply Zone 3 speaker level outputs from the surround back speaker terminals.
- **Zone 4:** Assign the surround back amplifier channels to supply Zone 4 speaker level outputs from the surround back speaker terminals.



TRIGGER SETUP

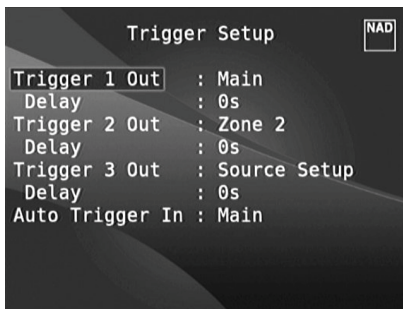

The T 777 features three configurable +12V DC Trigger Output that can be used to activate a component or system it is fed into. A Trigger Input is also available to turn on the applicable link it is associated to. Use a combination of [◀/▶/▲/▼] and [ENTER] keys to navigate through the Trigger Setup menu parameters.

TRIGGER OUT

Triggers are low voltage signals used to turn on/off other compliant devices. The T 777's three +12V DC Trigger Outputs (Trigger 1 Out, Trigger 2 Out and Trigger 3 Out) are dependent upon the mode they are associated with. There are six choices where +12V DC output can be assigned and these are – Main, Zone 2, Zone 3, Zone 4, Zone 2+3+4 and Source Setup.

**Main :** +12V DC is available at the assigned Trigger Out when the T 777 is at powered state.

**Zone 2, Zone 3, Zone 4, Zone 2+3+4 :** When the applicable Zone is at powered state, +12V DC is available at the assigned Trigger Out.

**Source Setup :** If Trigger Output is linked to 'Source Setup', +12V DC is available at Trigger Out whenever the particularly assigned Source is selected. Please see also separate discussion about 'Trigger Out' under the Source Setup (Normal View) section.

DELAY

The availability of +12V DC at Trigger Out can be regulated. If it is desired that +12V DC is available without delay the moment Trigger Out is linked to its assigned setting, set Delay to 0s. Otherwise, one can select through a delay time of 1s to 15s.

AUTO TRIGGER IN

Auto Trigger IN allows external system controllers to toggle the associated section of the T 777 from 'Standby' to 'On' and vice versa.

**Main :** From standby mode, the T 777 is powered ON when +12V DC is applied at Trigger IN.

**Zone 2, Zone 3, Zone 4 :** Applicable Zone is turned ON whenever +12V DC is present at Trigger IN.

**All :** Main, Zone 2, Zone 3 and Zone 4 as described above will all be activated given a +12V DC input at Trigger IN.

See also 'Item 9. +12V TRIGGER OUT, +12V TRIGGER IN of REAR PANEL discussion as well as the 'Trigger Out' discussion under 'Source Setup (Normal View).'

LISTENING MODE SETUP

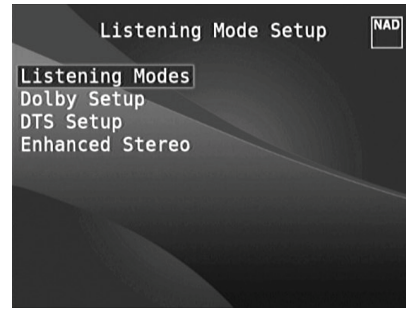

The T 777 has various listening mode options and is mostly configurable. These are provided to reproduce a variety of sound effects depending upon the content of the source to be played. Use a combination of [◀/▶/▲/▼] and [ENTER] keys to configure the following settings.

LISTENING MODES

The audio format as detected by the selected Source can be automatically configured and processed through the following options:

DOLBY

Dolby Digital is the multi-channel digital signal format developed in the Dolby laboratories. Discs bearing the Dolby Digital (double-D symbol) logo were recorded with up to 5.1 channels of digital signals, reproducing a much better sound quality, with dynamic and spatial sound sensations that are much better than in the previous Dolby Surround.

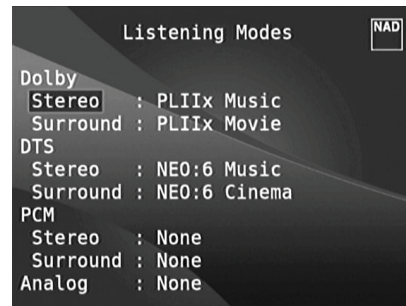

A Dolby Digital audio input can be configured relative to its format as follows

**Stereo:** If the detected audio is of Dolby stereo format, you can default it to one of the following settings – Pro Logic, PLIIx Movie, PLIIx Music or None.

**Surround:** If the detected audio is of Dolby Surround format, you can default it to one of the following settings –Surround EX, PLIIx Movie, and PLIIx Music, Stereo Downmix or None.

**None:** If 'None' is selected, the Dolby Digital signal will be defaulted to the 'Stereo' or 'Surround' settings set forth at the 'PCM' option. See discussion below about 'PCM'.

## OPERATION

### USING THE T 777 – SETUP MENU

#### DOLBY DIGITAL PLUS

Dolby Digital Plus is the next-generation audio technology for all high-definition programming and media. It combines the efficiency to meet future broadcast demands with the power and flexibility to realize the full audio potential expected in the upcoming high-definition era.

Dolby Digital Plus delivers multi-channel audio programs of up to 7.1 channels and supports multiple programs in a single encoded bitstream with the maximum bit rate potential of up to 6 Mbps and the maximum bit rate performance of up to 3 Mbps on HD DVD and 1.7 Mbps on Blu-ray Disc. It outputs Dolby Digital bitstreams for playback on existing Dolby Digital systems. Dolby Digital Plus can accurately reproduce the sound originally intended by directors and producers.

It also features multi-channel sound with discrete channel output, interactive mixing and streaming capability in advanced systems. Supported by High-Definition Media Interface (HDMI), a single-cable digital connection is possible for high-definition audio and video.

#### DOLBY TrueHD

Dolby TrueHD is a lossless encoding technology developed for high-definition optical discs in the upcoming era. Dolby TrueHD delivers tantalizing sound that is bit-for-bit identical to the studio master, unlocking the true high-definition entertainment experience on high-definition optical discs in the next generation. When coupled with high-definition video, Dolby TrueHD offers an unprecedented home theater experience with stunning sound and high-definition picture.

It supports bit rates of up to 18 Mbps and records up to 8 full-range channels individually with 24-bit/96 kHz audio. It also features extensive metadata including dialogue normalization and dynamic range control. Supported by High-Definition Media Interface (HDMI), a single-cable digital connection is possible for high-definition audio and video. HD DVD and Blu-ray Disc standards currently limit their maximum number of audio channels to eight, whereas Dolby Digital Plus and Dolby TrueHD support more than eight audio channels. Note that the T 777 only supports 7.1 channel.

#### DOLBY DIGITAL EX

Using a Matrix decoder, this method creates the back channel (sometimes also called the "surround center") by means of signals on the left and right surround channels recorded in Dolby Digital 5.1, reproduction being provided in Surround 6.1. This method should be selected with sources bearing the "Dolby Digital (double-D symbol)-EX" symbol, recorded in Dolby Digital Surround EX.

With this additional channel you will experience improved dynamics and a better sensation of movement within the sound field. If media sources recorded in Dolby Digital EX are decoded with a Digital EX decoder, the format is detected automatically, and the Dolby Digital EX mode is selected. However, some media sources recorded in Dolby Digital EX can be detected as simple Dolby Digital media sources. In this case Dolby Digital EX should be selected manually.

#### NOTE

*Please refer to the section 'Listening Mode' at the Main Menu discussions for a description of Pro Logic, PLIIx Movie, PLIIx Music and Stereo Downmix modes.*

#### DTS

The Digital Theater System Digital Surround (simply called DTS) is a multi-channel digital signal format that can process higher data rates than with Dolby Digital. Although both Dolby Digital and DTS are 5.1 channel media formats, discs bearing the "DTS" symbol are thought to provide better sound quality due to the lower audio compression required. It also offers a broader dynamic, producing magnificent sound quality.

A DTS audio input can be configured relative to its format as follows

**Stereo:** If the detected audio is of DTS format, you can default it to one of the following settings – NEO:6 Cinema, NEO:6 Music or None.

**Surround:** If the detected audio is of DTS Surround format, you can default it to one of the following settings – NEO:6 Cinema, NEO:6 Music, Stereo Downmix or None.

**None:** If 'None' is selected, the DTS signal will be defaulted to the 'Stereo' or 'Surround' settings set forth at the 'PCM' option. See discussion below about 'PCM'.

#### NOTE

*Please refer to the section 'Listening Mode' at the Main Menu discussions for a description of Stereo Downmix and DTS Neo:6 surround modes.*

#### PCM

PCM (Pulse Code Modulation) is the digital representation of a standard audio signal converted with little or no compression. If 'None' is selected for any of the Dolby or DTS settings, this 'PCM' section will default the audio signal as follows

**Stereo:** The detected stereo audio format will be configured into one of the following options – Pro Logic, PLIIx Movie, PLIIx Music, NEO:6 Cinema, NEO:6 Music, EARS, Enhanced Stereo or None.

**Surround:** The detected surround audio format will be configured into one of the following options – PLIIx Movie, PLIIx Music, NEO:6 Music, NEO:6 Cinema, Stereo Downmix or None.

#### ANALOG

If the audio input is an analog signal, the following are the surround modes the input can be defaulted – Pro Logic, PLIIx Movie, PLIIx Music, NEO:6 Cinema, NEO:6 Music, EARS, Enhanced Stereo, Analog Bypass and None.

#### NOTE

*All these Listening Modes for 'Dolby Digital,' DTS' 'PCM and 'Analog' can be directly changed by pressing the 'Listening Mode' button on the front panel or through the 'Listening Mode' option at the Main Menu window. The chosen audio format will be reflected back to the appropriate setting at the 'Listening Mode Setup.'*

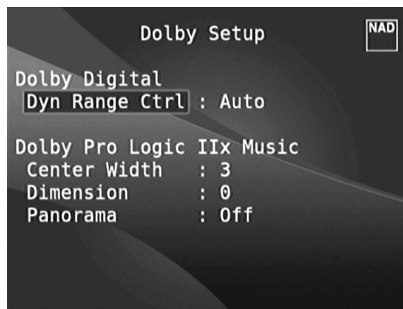
**DOLBY SETUP**

Under this menu, the Dolby Digital's Dynamic Range Control can be adjusted as well as the settings for Dolby Digital Pro Logic IIx Music.

**Dyn Range Ctrl:** You can select the effective dynamic range (subjective range from soft to loud) for playback of Dolby Digital soundtracks. For fully cinematic effect, always select 100%, the default. Settings of 75%, 50%, and 25% progressively reduce dynamic range, making soft sounds comparatively louder while limiting the peak loudness of loud ones.

The 25% setting will yield the least dynamic range and is best for late-night sessions or other times when you wish to retain maximum dialog intelligibility while minimizing overall volume levels.

For Dolby TrueHD sources, set the Dynamic Range Control to "Auto".

**Dolby Pro Logic IIx Music:** Please refer to the same description of 'PLIIx Music' under the 'ADJUSTING LISTENING MODES' segment of the 'OPERATION - USING THE T 777 - MAIN MENU'.

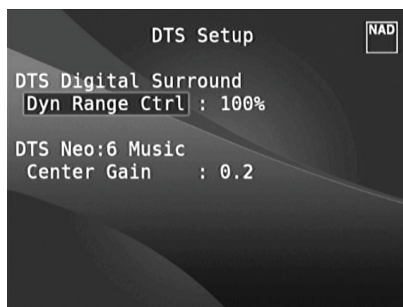
**DTS SETUP**

Under this menu, the Dynamic Range Control of DTS Digital Surround can be adjusted as well as the settings for DTS Neo: 6 Music.

**Dyn Range Ctrl:** This is the same configurable Dynamic Range Control feature as described above at Dolby Setup, the only difference being the soundtrack is now in DTS format.

**DTS Neo: 6 Music:** Please refer to the same description of 'NEO 6: Music' under the 'ADJUSTING LISTENING MODES' segment of the 'OPERATION - USING THE T 777 - MAIN MENU'.

**DTS SURROUND MODES**

The following are further descriptions about the DTS surround modes.

**DTS-HD MASTER AUDIO**

DTS-HD Master Audio is a technology that delivers master audio sources recorded in a professional studio to listeners without any loss of data, preserving audio quality. DTS-HD Master Audio adopts variable data transfer rates, facilitating data transfer to the maximum rate of 24.5 Mbps in the Blu-ray disc format, 18.0 Mbps in the HD-DVD format, which by far exceeds that of a standard DVD. These high data transfer rates enable lossless transmission of 96 kHz/24-bit 7.1-channel audio sources without deteriorating the quality of the original sound. DTS-HD Master Audio is an irreplaceable technology that can reproduce sound faithfully as intended by the creator of music or movies.

**DTS - ES EXTENDED SURROUND™ (DTS ES)**

This is a new multi-channel digital format which greatly improves the 360° spatial sensation of the Surround impression thanks to the greater space expansion of the surround signals, providing high compatibility with the conventional DTS format.

In addition to the 5.1 channels, the expanded DTS-ES Surround also offers the back surround (also sometimes called the "surround centre") in reproduction, providing a total of 6.1 channels. The expanded DTS-ES Surround includes two formats, with two different methods of surround signal recording, as follows:

**DTS-ES™ DISCRETE 6.1**

Since the signals of the 6.1 Surround channels (including the back channel) are completely independent, it is possible to achieve the sensation that the acoustic image is moving about freely among the background sounds, 360 degrees surrounding the listener.

Although maximum quality is achieved with sound tracks recorded using this system and reproduced using the DTS-ES decoder, when played with a conventional DTS decoder, the back surround channel is automatically downmixed in the surround right and surround left channels of the surround system, in such a way that none of the signal components are lost.

## OPERATION

### USING THE T 777 – SETUP MENU

#### DTS - ES™ MATRIX 6.1

In this format, the additional signals of the back channel receive a matrix encoding and are inputted into the right and left surround channels. During reproduction they are decoded to the right, left and back surround channels.

Since this bit-stream format is 100% compatible with conventional DTS signals, the DTS-ES Matrix 6.1 format effect can also be achieved from sources with DTS-ES 5.1 signals.

Naturally, it is also possible to reproduce from a DTS 5.1 channel decoder, signals recorded in DTS-ES 6.1.

When a DTS-ES decoder processes a discrete DTS-ES 6.1 or in Matrix 6.1, these formats are automatically detected and the Optimum Surround mode is selected. However, some DTS-ES Matrix 6.1 sources may be detected as DTS. In this case the DTS-ES Matrix mode should be selected manually in order to reproduce them.

#### DTS NEO: 6™ SURROUND

This mode applies the conventional 2-channel signals such as digital PCM or analog stereo signals to the high precision digital matrix decoder used for DTS-ES Matrix 6.1 to achieve 6.1-channel surround playback. DTS Neo: 6 surround includes two modes for selecting the optimum decoding of the signal sources:

**DTS NEO: 6 CINEMA :** This method is ideal for the reproduction of movies. The decoding takes place by emphasizing the separation in order to achieve the same atmosphere with 2-channel, as with 6.1-channel sources.

**DTS NEO: 6 MUSIC :** Mainly recommended for music reproduction. The right and left front channels do not pass through the decoder and are reproduced directly so there is no loss in sound quality, and the effects of the right surround, left surround, central and back surround channels add a natural sensation of expansion of the sound field.

#### ENHANCED STEREO

Please refer to the same description of 'ENHANCED STEREO' under the 'LISTENING MODES' segment of the 'OPERATION - USING THE T 777 - MAIN MENU'.

#### DISPLAY SETUP

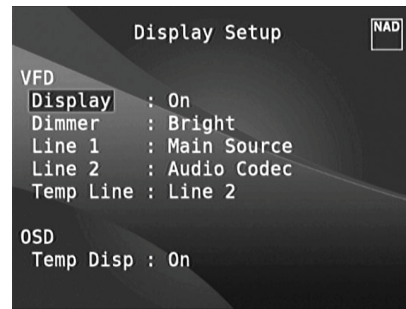

The Vacuum Fluorescent Display (VFD) and On-Screen Display (OSD) can be shown in various ways by navigating through the parameters at the 'Display Setup' menu. Use a combination of [◀/▶/▲/▼] and [ENTER] keys to step through the 'Display Setup' menu items.

#### NOTE

*The configurations set forth at 'Display Setup' are carried over whenever it is enabled during A/V Preset setting. Please see also the section below about 'AV Presets.'*

#### VACUUM FLUORESCENT DISPLAY (VFD)

**Display :** Select 'On' to display all applicable data or characters at the VFD. Nothing will be shown at VFD if 'Temp' is selected. At 'Temp' setting however, whenever any of the front panel controls or their corresponding keys in the remote control is activated, the appropriate VFD characters will be shown temporarily and then fade away. Note that if any of the Zones are at powered state, they will be continually shown at VFD even at 'Temp' setting.

**Dimmer :** If it is desired to reduce the brightness of the VFD, set Dimmer to 'Dim'. Otherwise, select 'Bright' to return to normal VFD brightness.

**Line 1, Line 2 :** The VFD shows two main lines of data or characters. Line 2 is the line of data or characters located at the lower bottom of the VFD while directly above it is Line 1. For both lines, one can select which display could be shown by choosing through the following

**Main Source :** Shows the active Source.

**Volume :** Current Volume level is shown.

**Listening Mode :** Selected Listening Mode is shown.

**Audio Src Format :** Shows the active Source's detected audio format.

**Audio Codec :** Displays the detected audio stream format like Analog, PCM Surround, Dolby TrueHD, DTS-HD Master Audio and other formats.

**Video Mode :** Show the video resolution of the active input source. Details shown include the video resolution with frame rate. For a better understanding of these video details, consult with your NAD Audio Specialist or your distributor's technical department.

**Zone 2-Zone 3-Zone 4 Source :** The assigned Source for the applicable Zone is shown.

**Off :** Select 'Off' if it is desired not to show any data at the applicable Line.

**Temp Line :** Choose between Line 1 and Line 2 as the desired line where VFD will be temporarily shown if 'Temp' is selected at 'Display' option as described above.

#### ON-SCREEN DISPLAY (OSD)

**Temp Disp :** This applies to the OSD that is temporarily shown at video on whenever any of the front panel controls or their corresponding keys in the remote control is activated. Set to 'On' if it is desired to show the applicable OSD at the monitor/TV; otherwise, select 'Off'.

**A/V PRESETS**

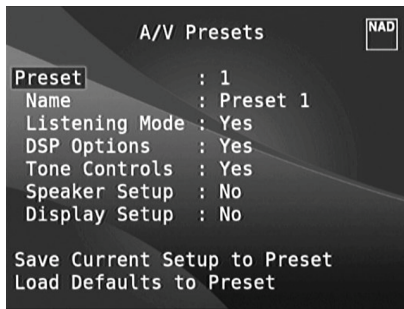

The T 777's simple but powerfully flexible system of "A/V Presets" allows you to customize virtually every aspect of your audio-video playback, and recall them with a single key-press. The parameters "Listening Mode", "DSP Options" and "Tone Controls" accessible via the "Main Menu" together with "Speaker Setup" and "Display Setup" configurable through "Setup Menu" are stored together as a single A/V Preset.

You might create one A/V Preset optimized for pop music and another for classical. One more A/V Preset can be set up to recall each family member's favorite setting or one for fully cinematic home-theater playback and yet another one for late-night movies, with each A/V Preset fine-tuned to a particular scenario or preference.

**CREATING PRESETS**

Creating an A/V Preset consists simply of storing a complete set of the parameters set forth in "Listening Mode", "DSP Options" and "Tone Controls" accessible via the "Main Menu" together with "Speaker Setup" and "Display Setup" configurable through "Setup Menu".

Scroll to "A/V Presets" using the [▲/▼] keys to save a collection of said parameter settings to a Preset. Select a Preset number and by pressing the [▲/▼] keys, you can selectively include in the particular A/V Preset any of the above-mentioned parameter settings by choosing "Yes". If you decide not to include in the particular A/V Preset a certain parameter setting, select "No".

Now in order to save the settings chosen for the particular A/V Preset number, scroll down to "Save Current Setup to Preset" and press the [D] key. If you chose to load instead the default settings, scroll down to "Load Defaults to Preset" and press the [D] key to restore the default settings.

In addition to the parameter settings, the A/V Preset label itself can be assigned a new name. This new Name will be shown in the VFD as well as on the OSD.

To rename the A/V Preset label, scroll to "Name" and press [D] to go the first character. Then, press [▲/▼] to pick and select through the alphanumeric selections. Press [◀/▶] to move to the next character or back to the previous character and at the same time save the changes done on the current character.

**NOTE**

*The selected A/V Preset remains in force until you select a different A/V Preset.*

**SAMPLE PROCEDURE FOR SETTING UP A/V PRESETS**

- 1 Setup first your preferred settings for the following options (access them through their respective menu page).

Listening Mode: Stereo

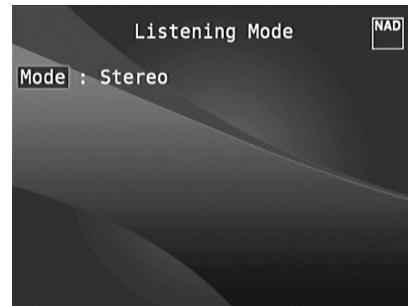

DSP Options: 5ms

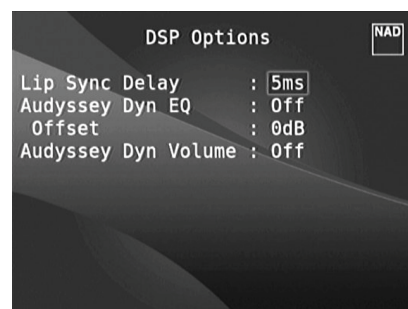

Tone Controls: Tone Defeat: On



Display Setup: Set "Line 2" to "Listening Mode"

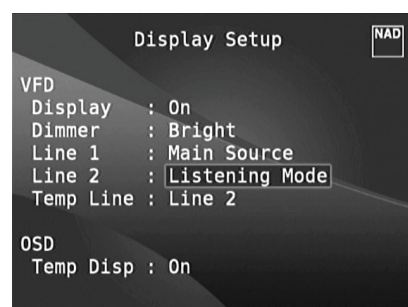

# OPERATION

## USING THE T 777 – SETUP MENU

Speaker Setup: from the Speaker Setup menu, go to "Speaker Configuration" sub-menu and change "Subwoofer" from "On" to "Off": "Front" becomes "Large"

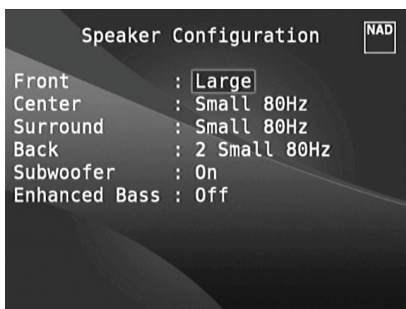
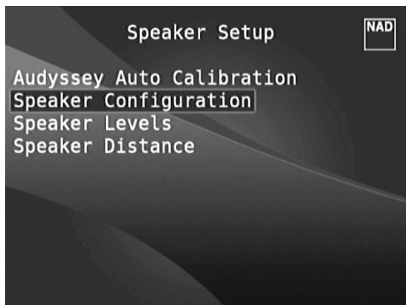

- 2 With the above settings, scroll to "A/V Presets" from the SETUP MENU page. Use [ ] to access "A/V Presets" menu.

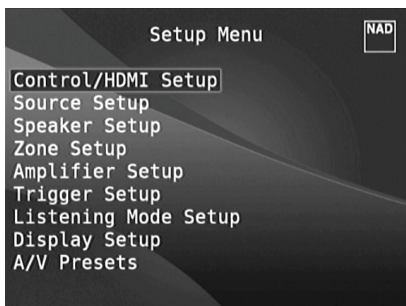

- 3 At "A/V Presets" page, set "Preset: 1" to the following conditions - use [ ] to select "Yes" or "No" and press [ENTER] to confirm selection and move on to the next setting.

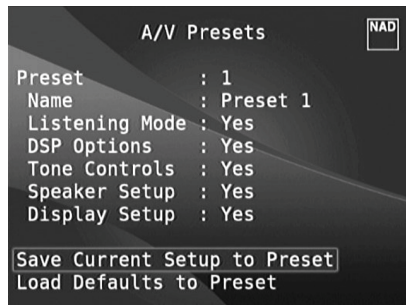

While at "Save Current Setup to Preset" menu line, use [ ] to save the above settings to Preset 1. Below OSD will be shown, affirming that the above settings are now saved to "Preset 1".

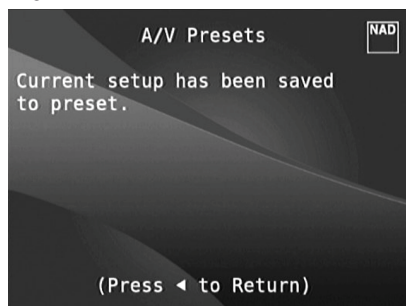

When you recall "Preset 1" using the remote control (for HTR 8, "A/V PSET" + "1"), the above preset values allocated at "Preset 1" (preset settings as shown in the OSD captures at Step 1) will be recalled and effected at the current source.

- 4 Now, repeat again Step 1 above but this time with the following settings

Listening Mode: PLIIX Music

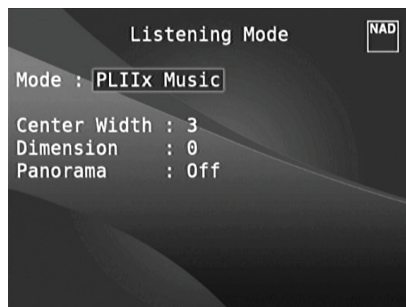

DSP Options: 0ms

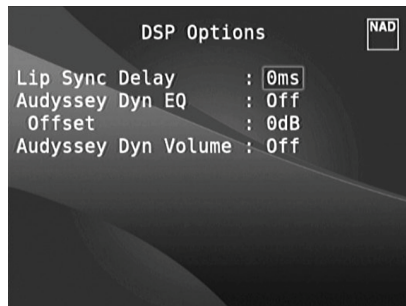

Tone Controls: Tone Defeat: Off

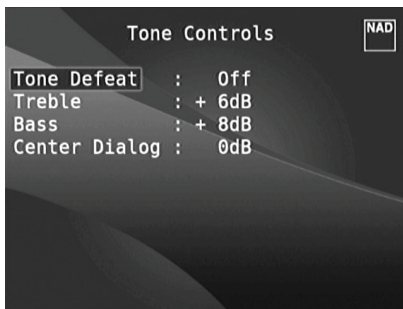

Display Setup: Set "Line 2" to "Volume"

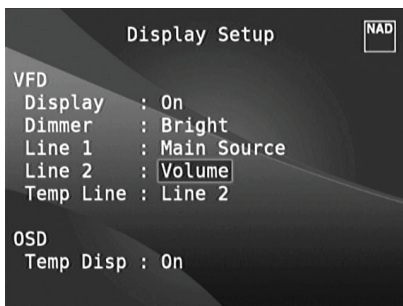

5 With the above settings, scroll to "A/V Presets" from the SETUP MENU page. Use [D] to access "A/V Presets" menu.

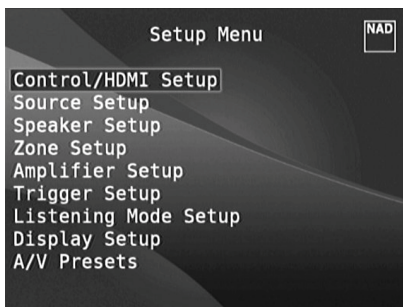

6 At "A/V Presets" page, set "Preset: 2" to the following conditions - use [▲/▼] to select "Yes" or "No" and press [ENTER] to confirm selection and move to the next setting.

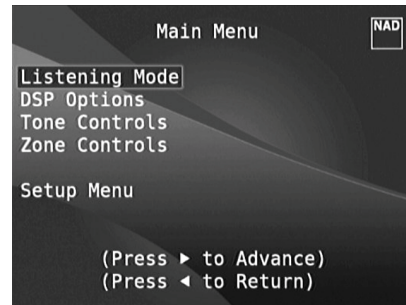

While at "Save Current Setup to Preset" menu line, use [D] to save the settings above to "Preset 2". When you recall "Preset 2" using the remote control (for HTR 8, "A/V PSET" + "2"), the above preset values allocated at "Preset 2" (preset settings as shown in the OSD captures at Step 4) will be recalled and effected at the current source.

Note that "Speaker Setup" is set to "No". At this condition, there will be no "Speaker Setup" values that will be effected at "Preset 2". The "Speaker Setup" settings that will be applied at "Preset 2" will be the last or current "Speaker Setup" settings which in this sample are the same "Speaker Setup" settings shown above in Step 1.

7 You can setup up to 5 A/V Presets. These same A/V Presets can also be associated/defaulted to each Source in the "Source Setup (Normal View)" window as below.

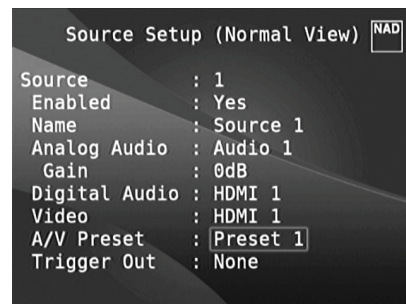

In the above example, "Preset 1" settings are allocated for Source 1. Whenever Source 1 is accessed, the "Preset 1" settings will be applied to Source 1. You can still manually override the assigned A/V Preset allocation in a specific Source with another Preset setting/number by way of pressing the appropriate remote control buttons.

**RECALLING PRESETS**

You may recall an A/V Preset number at any time using the HTR 8 remote control. Press the HTR 8's A/V PSET key and then the numeric key 1-5 corresponding to the desired A/V Preset number. The newly recalled A/V Preset will then manifest or replace the previous A/V Preset (if any).

## OPERATION

### LISTENING TO AM/FM RADIO

The T 777's internal AM/FM tuner offers very high quality sound from radio broadcasts. The reception and sound quality will always be dependent to a degree however on the type of antenna(s) used as well as proximity to the broadcast origin, geography and weather conditions.

#### ABOUT ANTENNAS

The supplied ribbon-wire FM antenna can be connected to the rear panel FM antenna input using the included "balun" adapter and should be fully extended to form a "T". This folded-dipole antenna will usually work best when oriented vertically, with the arms of its "T" fully outstretched and arranged perpendicular to the origin of the desired broadcast. There are no "rules" however, and experimenting freely with antenna placement and orientation may yield the clearest sound and lowest background noise.

In areas of poor FM reception, an exterior FM antenna can improve performance dramatically. If radio listening is important to you, consider consulting an antenna installation professional to optimize your system.

The supplied AM "loop" antenna will usually provide adequate reception. However, an exterior AM antenna can be used to improve reception. Consult an antenna professional for more information.

#### IMPORTANT NOTE

*When using the HTR 8 to carry out AM/FM commands, ensure that the DEVICE SELECTOR is set to "TUNER".*

#### ASSEMBLING THE LOOP ANTENNA

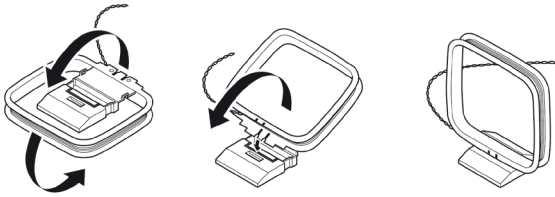

- 1 Rotate the outer frame of the antenna.
- 2 Insert the bottom edge of the outer frame into the groove on the stand.
- 3 Extend the antenna cord.

#### SELECTING A TUNER BAND

Press the [AM/FM/DB] button on the HTR 8 while at AMP or TUNER device selector page. Each subsequent press will toggle you through AM, FM, XM or DAB band. Stop (release button) at your desired tuner band.

#### TUNING AM/FM STATIONS

Upon selecting AM or FM band, use TUNE [◀/▶] on the HTR 8 to perform slow manual search; press and hold to automatically search.

The front panel [◀/▶] or HTR 8's [◀/▶] buttons can also be used to tune for stations.

- 1 Press [◀/▶] momentarily to step up or down between AM or FM frequencies.
- 2 Press and hold [◀/▶] for more than 2 seconds to search up or down - the T 777's tuner will stop at the next sufficiently strong signal it encounters.
- 3 Pressing the [◀/▶] during the search process will stop the search.

#### DIRECT TUNING

If you know your desired station's frequency allocation, you can tune directly to the station.

- 1 Toggle [ENTER] button to switch between "Preset" and "Tune" mode (see the lower line of the VFD). Select "Tune" mode.
- 2 Using the numeric keys of the remote control, key-in the frequency allocation of the station. For example, to enter 104.50MHz, press "1", "0", "4", "5" and "0".

#### STORING PRESETS (AM/FM/XM/DAB)

The T 777 can store a mix of your 40 favorite AM, FM and XM (or DAB) radio stations for immediate recall.

- 1 To store a desired AM/FM station to a preset, first tune to the desired frequency (see above), then press the front panel's [MEMORY] button. The VFD will show the next available Preset number - for example, "Preset 4 Free" in the lower line.
- 2 Press the [MEMORY] button again to store the desired frequency on the Preset number shown ("P04" is shown in the right side of the VFD). Your desired frequency is now stored in the assigned preset number.

#### NOTE

*If there is no more vacant Preset number, you can overwrite an existing Preset number by pressing the [▲/▼] buttons to select the Preset number you want to overwrite.*

#### DIRECT RECALL OF A PRESET NUMBER (AM/FM/XM/DAB)

You can directly recall a desired Preset number.

- 1 Toggle [ENTER] button to switch between "Preset" and "Tune" mode (see the lower line of the VFD). Select "Preset" mode.
- 2 Using the numeric keys of the remote control, directly key-in your desired Preset number. For example, to enter Preset 5, press "5".

#### DELETING A STORED PRESET (AM/FM/XM/DAB)

You can empty a preset by deleting the stored information.

- 1 Select the preset number to be deleted. For example, "P03".
- 2 Press and hold [MEMORY] button and then press and release [INFO] button - current stored preset setting will be erased ("P03" becomes "P--").

#### CHOOSING THE TUNER MODE

The front-panel [TUNER MODE] key is a dual-purpose control. In the normal position (FM MUTE FM STEREO icons on the VFD are illuminated), only the stations with a strong signal can be listened to, and the noise between stations is muted.

Pressing the [TUNER MODE] button again (FM MUTE FM STEREO icons on the VFD are extinguished) allows distant and potentially noisy stations to be received. Noise is reduced if the FM station signal level is less than the FM Stereo threshold (since mono FM is inherently less noise-prone) though at the sacrifice of the stereo effect.

#### NOTE

*One can store the same channel in two preset locations - one with TUNER MODE On and another with TUNER MODE Off.*



**ABOUT USER NAMES**

A Preset number can be assigned a twelve "User Name". The assigned "User Name" will be shown in the VFD and OSD whenever the associated Preset number is recalled.

**ENTERING USER NAMES**

A Preset number can be assigned the user name "NEWS" by the following procedure. The buttons mentioned below refer to HTR 8 buttons. The corresponding front panel buttons execute the same functions as described.

- 1 Recall the desired Preset number to be assigned a "User Name".
- 2 Then, press the [MEMORY] button once and within five (5) seconds, press the [INFO] button - the readout shows a blinking box.
- 3 Use the [▲/▼] buttons to select the first character of the name ("N" from the alphabetical list).
- 4 Press [▶] button to select the character and correspondingly move forward to the next position. (Press [◀] to go back to the previous character). Repeat this process for each character in sequence.
- 5 Press the [MEMORY] key again to store the User Name and exit the text-entry mode.

**ABOUT RDS**

The Radio Data System (RDS) permits sending small amounts of digital information using conventional FM radio broadcasts. The T 777 supports two RDS modes, program-service name (PS mode) and radio-text (RT mode). Not every FM station incorporates RDS in its broadcast signal. In most areas you will find from one to several RDS-enabled stations, but it is by no means impossible that your favorite stations will not be broadcasting RDS data.

**VIEW RDS TEXT**

When an RDS-enabled FM broadcast is tuned, the readout's character section will show its program-service name (PS) text.

Press the HTR 8's [INFO] button to toggle the readout between this and the station's radio-text (RT) readout, if any, which might scroll song- or artist-name, or any other text of the station's choosing.

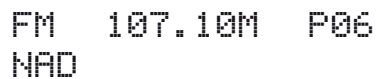

```
FM 107.10M P06
NAD
```

## OPERATION

### LISTENING TO XM RADIO

The T 777 is "XM Ready" which means that with the addition of separately sold XM Mini-Tuner (Model: CNP-2000) and XM Mini-Tuner Home Dock, it has everything you need to listen to live XM. Everything else is built right in. Just subscribe to the XM service and your T 777 will be ready to receive XM content.

#### NOTES

- *When using the HTR 8 to carry out XM commands, ensure that the DEVICE SELECTOR is set to "TUNER".*
- *Check with your NAD audio specialist for other versions of XM Mini-Tuner compatible with T 777.*

#### CONNECTING THE XM ANTENNA

- 1 Plug the end of the XM antenna into the corresponding XM antenna port on the rear panel of the T 777.
- 2 Press and hold HTR 8's [TUNER MODE] to check the current XM channel's signal strength as shown in the VFD and OSD. Press [TUNER MODE] again to exit signal strength check.

Refer also to your XM radio's guide on how to install the XM antenna for optimum signal reception.

#### TUNING XM CHANNELS

There are three ways to tune to the XM channel you wish to listen. Make sure to set your HTR 8's Device Selector to "TUN" prior to undertaking the following tuning options. The [▲/▼/◀/▶] buttons refer to the corresponding keys on the HTR 8. The same keys correspond to the front panel navigation buttons [◀/▶/▲/▼].

- 1 **Manual Tuning:** Toggle the [▲/▼] buttons to step up or down each available XM channel. Press and hold [▲/▼] for faster scanning of XM channels.
- 2 **Direct Channel Call:** Toggle [ENTER] button to switch between "Preset" and "Tune" mode (see the lower line of the VFD). Select "Tune" mode. Using the numeric keypads of the HTR 8, key-in directly the desired available channel number and it will be automatically tuned.
- 3 **Category:** Toggle [TUNER MODE] until "CAT" and a corresponding category is displayed on the VFD. "CAT" stands for the categories the channels are grouped into - i.e., Country, Rock, Jazz & Blues, etc. Toggle [▲/▼] buttons to step up or down the available categories.

After selecting the desired category, use the same steps as that of XM Manual Tuning. Tuning will only be limited to within the selected category. Toggle the [▲/▼] buttons to choose another category and then tune again.



#### VIEW XM INFORMATION

Toggle [INFO] button to display the XM information of the selected channel such as the artist name, song title, category or any other text as supplied for the channel.

#### STORING PRESETS

The procedure for storing XM channels is the same method as stated in the section "STORING PRESETS (AM/FM/XM/DAB)" under the "LISTENING TO AM/FM RADIO".

For immediate recall of stored XM presets, toggle [TUNER MODE] button until "P\_\_" (the two blank spaces corresponding to the preset number) is shown in VFD. Press PRESET [▲/▼] to step up or down the stored presets that can be a combination of AM, FM and XM channels.

Until now, analogue radio signals such as FM or AM have been subject to numerous kinds of interference on their way from the transmitter to your radio. These problems were caused by mountains, high-rise buildings and weather conditions. With Digital Audio Broadcast (DAB), you can now receive CD-like quality radio programs without any annoying interference and signal distortion. DAB broadcasts use digital signals rather than traditional analogue transmissions, thus providing clear high quality reception. You get far more robust reception and virtually hiss or crackle free sound with DAB as long as you are within a good coverage area.

With DAB, the listener can scroll through a list of available stations - then instantly tune to the station of his choice. There is no need to remember channel frequencies. All broadcasts are selected by simply selecting the service name.

The T 777 makes it possible for you to enjoy listening to DAB broadcasts. The T 777 has a Digital Audio Broadcast (DAB) module socket on the rear panel for adding a separately sold and NAD-specified outboard DAB module - the NAD DAB Adaptor DB 1 or the DAB+ NAD DAB Adaptor DB 2. All the control software for this format is included; just plug-in the module and start enjoying the CD-like quality sound and expansive content selection available with DAB.

### IMPORTANT NOTES

- *The T 777 is compatible only with the NAD DAB Adaptor module models DB 1 or DB 2.*
- *When using the HTR 8 remote control to carry out DAB commands, ensure that the DEVICE SELECTOR is set to "TUNER".*
- *In the DAB discussions below, all control buttons mentioned are with reference to the HTR 8 remote control.*

### CONNECTING THE DAB MODULE

Plug-in the other end of the DIN connector (supplied with your NAD DAB Adaptor DB) from the DAB module's output port into the corresponding DAB module input socket on the rear panel of the T 777. Select DAB mode on the T 777 by toggling HTR 8's [AM/FM/DB] button.

### NOTES

- *The NAD DAB Adaptor (DB 1 or DB 2) is not supplied with your T 777.*
- *Refer to the installation diagram printed on the carton box of the NAD DAB Adaptor for guidance on how to connect the NAD DAB Adaptor to the T 777.*
- *If there is no NAD DAB Adaptor connected, the VFD will show "Check DAB Tuner".*

### DAB OPERATION

With the separately sold NAD DAB Adaptor already connected to the T 777, you can now carry out the T 777 to receive DAB broadcasts.

- 1 Toggle [AM/FM/DB] button until DAB mode. The VFD will show "No Service List" indicating that there are no scanned DAB broadcast services yet. This is the default mode of the NAD DAB Adaptor.



- 2 To tune to DAB broadcast services, press [TUNER MODE] and then toggle [◀/▶] to select either "Full Scan" or "Local Scan".

FULL SCAN will enable the scanning of the full range of digital frequencies (Band III and L-Band).

LOCAL SCAN performs local scanning of available DAB services in your area. Check with your dealer or visit [www.WorldDAB.org](http://www.WorldDAB.org) to check the applicable digital transmission frequencies in your area.

- 3 Upon selecting either "Full Scan" or "Local Scan", automatic scanning will be performed. This sequence cannot be interrupted. During the sequence, the following message will be visible in the VFD. The bars show the progress of the sequence. When scanning is completed, the last number shown on the right side of the VFD corresponds to the total number of DAB broadcast stations found. Then, the first station is tuned in (See "ALPHANUMERIC" section below to understand the order or arrangement of stations).



## OPERATION

### LISTENING TO DAB RADIO

- Press and hold [ENTER] button to check the strength of the incoming signal. The more segments visible in the lower display line, the stronger the signal. By changing the position of the antenna, you can increase the signal strength. You can also opt for an external antenna. Consult an antenna professional for more information.



#### NOTE

*"No Service List" will also be shown in the VFD when no stations are found after the scanning process. If this occurs, check the connection and position of the DAB antenna or call your local DAB broadcast providers for coverage information.*

#### SERVICE LIST

Follow the steps below to select through the DAB service stations found.

- At DAB mode, press [◀/▶] to step through the list of available stations as shown in the lower display line of the VFD.

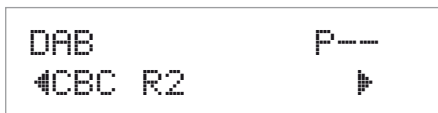

- Press [ENTER] to select the desired station.

#### DAB TUNER MODE

Aside from "Full Scan" and "Local Scan" as already described above, pressing the [TUNER MODE] button will also present you with other options namely - Station Order, DRC, Manual Scan, Prune List and Reset.

#### STATION ORDER

Use "Station Order" to sort the sequence of the listed stations. There are three orders - Alphanumeric, Ensemble and Active.

- While listening to a DAB broadcast, press [TUNER MODE] button and [◀/▶] to select "Station Order". Press [ENTER].
- Toggle [◀/▶] to select through "Alphanumeric", "Ensemble" and "Active".
- Press [ENTER] to select desired station order.

#### ALPHANUMERIC

This is the default setting. Stations are arranged by numbers first and then alphabetically by letters.

#### ENSEMBLE

Digital radio is broadcast as groups of data called ensemble. Each ensemble contains a number of stations, transmitted at a set frequency. When "Ensemble" is selected as the mode of station order, the radio broadcasts are arranged in the order of their ensemble names.

#### NOTE

*Ensemble is also interchangeably termed as "multiplex" by other broadcast providers.*

#### ACTIVE

Active stations are listed at the top of the channel list. Those channels that are in list but have no service in the area will be displayed last in the channel list.

#### DRC

The level of compression of stations can be set to eliminate the differences in dynamic range or sound level between radio stations. Popular music would normally be more compressed than classical music, resulting in possible different audio levels when changing from one station to the other. Setting the DRC to "0" means no compression, "1/2" indicates medium compression and "1" shows maximum compression. No compression is recommended, especially for classical music.

- While listening to a DAB broadcast, press [TUNER MODE] button and [◀/▶] to select "DRC". Press [ENTER].
- Toggle [◀/▶] to select through "DRC 0", "DRC 1/2" and "DRC 1".
- Press [ENTER] to select desired DRC level.

#### MANUAL SCAN

This option allows you to directly tune to a desired channel and include it in the service list (if not yet available at the time). You can also use manual scan to assist you in positioning the DAB antenna for best reception of the desired channel.

- While listening to a DAB broadcast, press [TUNER MODE] button and [◀/▶] to select "Manual Scan". Press [ENTER]. The current channel and frequency are shown in the upper line of the VFD. The "bars" at the lower line of the VFD indicate the signal strength level of the current channel.

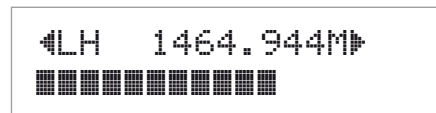

- To select other channels, toggle [◀/▶] to step through the channel list. Release [◀/▶] when you have arrived at your desired channel. Channel and frequency are shown in the upper line of the VFD. The "bars" at the lower line of the VFD indicate the signal strength level of the current channel. To improve the reception of the selected channel, adjust or reposition the DAB antenna until the best reception is indicated.
- Press [ENTER] to tune the selected channel.

#### NOTE

*The number of ensembles and stations that could be scanned will vary depending upon your location.*



#### PRUNE LIST

There may be situations wherein certain stations become inactive. The "Prune List" option enables the deletion of these inactive stations in the service list.

- While listening to a DAB broadcast, press front panel's [TUNER MODE] button and [◀/▶] to select "Prune List".
- Press [ENTER]. Any inactive stations are automatically deleted.

### RESET

The "Reset" option allows the connected (and separately sold) NAD DAB Adaptor to be reset to its factory default settings.

- 1 While listening to a DAB broadcast, press [TUNER MODE] button and [  ] to select "Reset".
- 2 Press [ENTER]. "Reset? No" will be shown in the lower line of the VFD. Press [  ] to switch to "Reset? Yes" option.

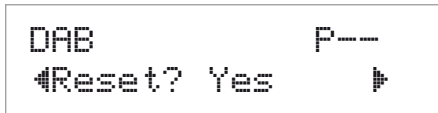

- 3 To select "Reset? No" or "Reset? Yes", press [ENTER] while at the desired option. Selecting "Reset? Yes" will cause the connected NAD DAB Adaptor module to be reset to its factory default settings.

### INFORMATION SETTINGS

While listening to a DAB broadcast, the type of information displayed in the lower line of the VFD can be varied. Toggle front panel's [INFO] button to step through the following display options:

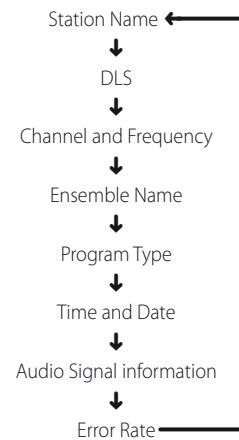

#### STATION NAME

The name or identification of the DAB broadcast station is shown. This is the default display.

#### DLS

Dynamic Label Segment (DLS) is the scrolling text supplied by the broadcasting station. It may contain information on music titles or details regarding the program or station.

#### CHANNEL AND FREQUENCY

The channel and frequency of the currently tuned DAB broadcast are displayed.

#### ENSEMBLE NAME

The name of the ensemble that is broadcasting the program is displayed.

#### PROGRAM TYPE

This is a description of the type of broadcast supplied by the station, such as Pop, Rock, Drama and the likes.

#### TIME AND DATE

The current time and date as supplied by the DAB station are displayed.

#### AUDIO SIGNAL INFORMATION

Displays the bit rate and audio type (stereo, mono or joint stereo) as transmitted by the DAB broadcast provider. These are set by the broadcaster to suit the type and quality of material being transmitted.

#### ERROR RATE

This displays the digital error rate (0 to 99) of the currently tuned channel - the lower the figure, the better the quality of the received broadcast.

## OPERATION

### LISTENING TO YOUR iPod PLAYER

The T 777 is equipped with a data port in the rear panel where an optional "NAD IPD Dock for iPod" (NAD IPD) can be plugged in. With the NAD IPD linking the T 777 with your own iPod player, you can enjoy listening to your favorite tracks and playlists as well as view applicable still image and video playback.

You can control your iPod player using the assigned buttons in the T 777 front panel. And with the corresponding HTR 8 remote control function keys, you can select the materials stored in your iPod for playback as well as access many of its functions even from across the room. The optional NAD IPD also charges your iPod player while it is connected to the T 777.

#### NOTES

- "NAD IPD Dock for iPod" (NAD IPD) currently has two versions - the NAD IPD 1 and NAD IPD 2. These two NAD IPD models and later variants are compatible with the T 777.
- NAD IPD and iPod player are not supplied with your T 777.
- iPod player functions, features and playback capabilities accessible through T 777 may vary depending on your iPod player model.
- When using the HTR 8 to control the iPod functions, make sure that the Device Selector is set to "AMP".

### CONNECTING THE OPTIONAL NAD IPD AND iPod PLAYER TO THE T 777

Make sure that all the devices are unplugged before making the connections.

- 1 Connect the NAD IPD's DATA PORT to the corresponding "MP DOCK" data port of the T 777.
- 2 Connect also the NAD IPD's S-Video out and audio out to the T 777 AUDIO 5/S-VIDEO 3 input (the default iPod source allocation in the T 777).
- 3 Dock your iPod player into the NAD IPD.

#### NAVIGATING THE IPOD PLAYER'S FUNCTIONS AND FEATURES

After linking together your iPod player, NAD IPD and the T 777, you can now plug them IN to their applicable power sources.

- 1 With your T 777, iPod player and NAD IPD all at power ON state, select SOURCE 5 (iPod) of your T 777. Your iPod player will show in its display the NAD logo and below it "OK to disconnect." On the other hand, the T 777 VFD will show in the upper line "iPod Menu" and the lower line "Playlists". The lower line will vary depending on the current menu selected. At the same time, the T 777 OSD will display the whole iPod Menu selections like Playlists, Artists, Albums, Songs, Podcasts, Genres, Composers and Audiobooks.
- 2 Navigate through the iPod menu selections using a combination of the [ / / / ] buttons.

#### NOTES

- The iPod player's click wheel and controls will not operate when it is properly connected to the T 777 via the NAD docking station.
- To exit from the iPod Menu at Source 5 (iPod), press [ ] bringing you to "Menu Select" OSD. Follow the instructions as shown.
- Source 5 is defaulted to iPod. For Source 5 (iPod) to be changed and allocated for other inputs, go to "iPod Setup" menu under the "Source Setup" menu. At "iPod Setup" menu, set "Enabled" to "No" – you can now assign Source 5 with another input or setting as desired.

### CONTROL FEATURES AND SETTINGS

The following control functions and settings are selectable or enabled using the front panel and HTR 8 remote control buttons. Since the HTR 8 will be the primary controller in most cases, we will focus on remote-controlled operations.

Note that other NAD IPD models, like the NAD IPD 2, have their own remote controls. The controls below also apply to the corresponding buttons of the remote controls of such applicable NAD IPD models.

#### ENTER

While at iPod Menu OSD, press [ENTER] to go to "iPod Settings" and setup the following options:

**Shuffle:** Select "Shuffle" to enable random playback of either "Songs" or "Albums" lists. To turn off shuffle mode, select "Off".

**Repeat:** Select "One" for repeated playback of the current song. Select "All" for repeated playback of your entire list under "Songs" selection.

**Audiobook Speed:** The playback speed of your audiobook can be varied according to your preference. During audiobook playback, adjust the reading speed to "Normal", "Fast" or "Slow".

#### DISP

- During playback, toggle [DISP] key of HTR 8 to show in the T 777 VFD upper line the Song title, Artist Name and Album title.
- If there is no information available, the display will show "No Song", "No Artist" or "No Album" as applicable. Aside from this information, the lower line will display the current title's song number allocation and time elapsed.



- During playback mode, press [ ] to skip forward to the next song or [ ] to skip back to the previous song.
- For quicker scrolling up or down the list, press and hold [ / ].
- While at menu options or selection lists, toggle [ / ] to go up or down the options or lists.



- Press HTR 8's [ SKIP ] to scroll up and down the Songs list one page or at least 8 titles at a time.
- Press and hold [ / ] to quickly scroll through the song titles.
- During fast scrolling, [ SKIP ], the first letter of the song is displayed on the bottom right corner of the OSD as the title changes. This is applicable only when there are more than 4000 song titles.

#### [ ] (PAUSE) / [ ] (PLAY)

- Press [ ] (PAUSE) during playback to stop playback temporarily.
- Resume play by pressing [ ] (PAUSE) again or [ ] (PLAY).



- During playback or pause mode, press [ / ] once for fast forward or backward scanning of current song.
- Resume play by pressing [ ] again or [ ].

**NAD IPD 2**

The NAD IPD 2 has its own remote control - the DR 1. When using the DR 1 to command your iPod player docked in the NAD IPD 2, you have to refer to your iPod player's own display screen to make full use of its feature; there is no OSD at this condition. However, any time you press HTR 8's [ D ] button or [ > ] on the front panel, the "Menu Select" OSD comes up. If you select "iPod Menu" at this "Menu Select" option, the NAD IPD 2 gets manually connected. The control of the NAD IPD 2 will then again be done through the T 777 using the applicable front panel control buttons or HTR 8 buttons while referring to the OSD; the NAD IPD 2 will not respond to any DR 1 commands at this stage.

**IMPORTANT NOTES**

- For you to control the NAD IPD 2 using the DR 1, you have to go to "iPod Setup" menu (please refer to the item about "iPod Setup" under the "USING THE T 777 - SETUP MENU" segment of OPERATION section) and then set "Auto Connect" to "No". With this setting, you can then use the DR 1 to control your iPod player docked in the NAD IPD 2.
- Note that if you set "Auto Connect" to "No" while at Source 5 (iPod), you have to change source and then return to Source 5 (iPod) for the changed setting to take effect.

**REGAIN CONTROL OF NAD IPD 2 USING DR 1 REMOTE CONTROL**

In order to switch back control of the NAD IPD 2 from the T 777/HTR 8 to the DR 1 remote control, follow these steps.

- 1 Exit from the iPod Menu by pressing repeatedly [ ◀ ] until it brings you to "Menu Select" OSD.
- 2 Highlight "iPod Menu" and press [ ◀ ] to advance to "iPod Menu".
- 3 At "iPod Menu", press [ D ] to close iPod menu. DR 1 remote control regains control of the NAD IPD 2.

In addition to the above commands common to the DR 1, below are the descriptions of the other DR 1 control buttons.

**LIGHT**

Press [LIGHT] to turn ON the backlight of your iPod player if it is at idle mode.

**MENU**

Press [MENU] to return to previous option or menu selection

**ENTER**

Press [ENTER] to select an option or start playback.

**↻ (REPEAT)**

Toggle to initiate repeat mode as follows - repeat one song, repeat all songs or cancel repeat mode

**⌘ (RANDOM)**

Toggle to initiate playback in random order. There are three random modes - Shuffle Song, Shuffle Album or Shuffle Off.

**⏮/⏭**

- During playback mode, press [⏭] to skip forward to the next song or [⏮] to skip back to the previous song.
- During playback or pause mode, press and hold [⏮/⏭] for fast forward or backward scanning of current song. Release [⏮/⏭] to resume playback.

**TO VIEW VIDEOS OR PHOTOS LOADED IN YOUR iPod**

Videos or photos uploaded in your iPod can be viewed directly via the T 777. The following are the steps

- 1 Make sure that the "TV Out" setting of your iPod's Video Settings menu is at "On" mode and appropriate "TV Signal" is chosen.
- 2 Video or photo file selections and playback procedures are managed directly from your iPod player and not through the T 777. You must exit completely from the T 777's Setup Menu or Menu Select OSD for you to be able to navigate through your iPod player's video or photo menu options. A more direct way is by going to the "iPod Setup" menu and set "Enabled" to "No".
- 3 With the NAD IPD's S-VIDEO OUT and AUDIO OUT ports connected to the T 777's AUDIO 5/S-VIDEO 3 input or to any other assignable input, you can now directly enjoy via T 777 your video or photo file selections as uploaded in your iPod. Make sure that you select the correct "Source Number" of the T 777. Note that if "Enabled" from "iPod Setup" is set to "No", ensure that Source 5 is enabled and analog audio and video settings are assigned to "A5" and "S3" respectively.

**NOTE**

*For other navigation functions, please refer to your iPod player's owner's manual. Depending on the iPod player model, some other functions maybe controlled using the applicable T 777 navigation controls.*

iPod is a trademark of Apple, Inc., registered in the U.S. and other countries.

# OPERATION

## USING THE HTR 8 REMOTE CONTROL

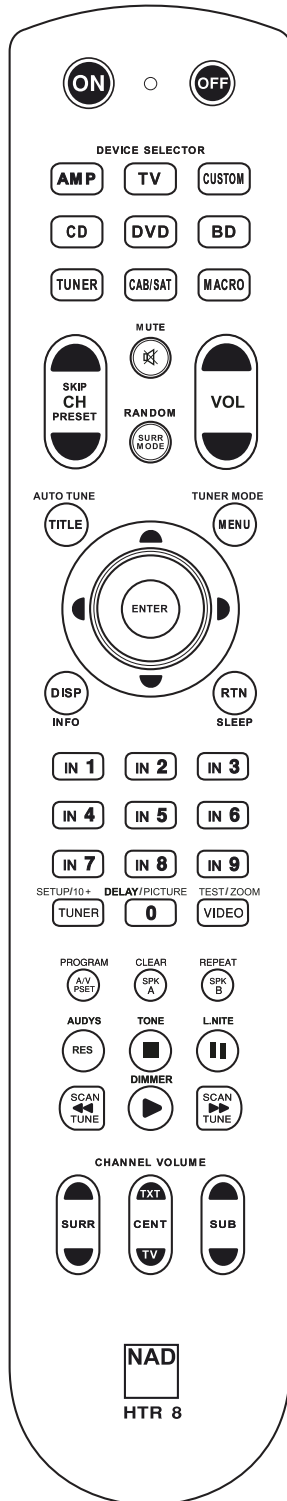

### OVERVIEW OF THE HTR 8

- Controls up to 8 devices.
- Learns up to 360 commands.
- Records up to 52 macros with a maximum of 64 commands each.
- Configurable punch-through.
- Key illumination with programmable timeout.
- Upgradable.
- Contains pre-programmed library of NAD remote codes.

The NAD HTR 8 is ready to operate the T 777 right out of the box, but it is really eight remotes in one. Each of the 8 DEVICE SELECTOR keys at the top of the handset can call up a new “page” of remote control codes to be transmitted by the remaining keys. You may “teach” codes from any infrared-remote controlled component, regardless of brand, to any or all of these.

Obviously, the most logical system is that you teach the codes from your DVD player to the [DVD] DEVICE SELECTOR “page”, your television’s codes to the [TV] “page” and so on, but there is no required scheme: You may load any commands to any key on any page (see “LEARNING CODES FROM OTHER REMOTES” below).

The HTR 8 is already pre-programmed with a full complement of T 777 commands on its [AMP] DEVICE SELECTOR page, and as well as with library commands to operate most NAD-brand DVD, BD, CD or TUNER components on the corresponding DEVICE SELECTOR “pages”. These default commands are permanent: Even if you teach the HTR 8 new commands to take their place, the underlying library commands remain in place and can easily be recalled should you add an NAD component to your system later (see “DELETE MODE” below).

### GETTING FAMILIAR WITH THE HTR 8

The HTR 8 is divided into two main sections. Eight DEVICE SELECTOR keys at the top—[AMP], [DVD], [TV] and so on - set the handset’s remaining keys to a “page” of commands to control a particular component. A DEVICE SELECTOR key determines only what component the HTR 8 will command; it does not perform any function on the component. All the remaining keys are function keys that can “learn” control codes from virtually any infrared remote controller, allowing you to teach the codes of your equipment, regardless of brand, to the HTR 8.

However, the HTR 8 is already pre-programmed to operate the T 777. All of the function keys on the [AMP] Device Selector “page” perform T 777 functions. The HTR 8 can also command many other NAD components from its [DVD], [CD], [BD] and [TUNER] pages.

It is important to note that certain HTR 8 keys perform different functions depending on the selected DEVICE SELECTOR “page”. The colour of the DEVICE SELECTOR key-labelling corresponds to the labelling of the function keys. Most centrally, the black [AMP] DEVICE SELECTOR “page” corresponds to the black keys: When the HTR 8’s [AMP] DEVICE SELECTOR page is active; these keys select the amplifier or receiver inputs. Similarly, the purple [DVD] DEVICE SELECTOR “page” corresponds to several purple labels and so on.

### LEARNING CODES FROM OTHER REMOTES

Begin by positioning the HTR 8 “nose-to-nose” with the source remote so the two devices’ infrared windows are about 2 inches apart.

- Enter Learning Mode: On the HTR 8, simultaneously press-and-hold for 3 seconds both a DEVICE SELECTOR key and the [RES] key until the Learn LED of the HTR 8 turns steady green.
- Press the HTR 8’s function key you wish to teach a command; the Learn LED will turn amber.
- Press-and-hold the function key on the source remote: The HTR 8’s Learn LED will flicker amber for a second or two, then turn solid green. The command is learned.
- Press the HTR 8’s DEVICE SELECTOR key again to exit the learning mode.

If the Learn LED does not flicker amber you may need to vary the distance between the remotes. If the Learn LED turns red rather than green, that particular command of that source remote command could not be learned. In rare instances, there may be some IR format that is not compatible with the HTR 8.



**Example:** Learning "DVD Pause"

Position the HTR 8 and your DVD player's remote as described above.

- On the HTR 8, simultaneously press-and-hold [DVD] and [RES]; the Learn LED turns steady green.
- Press the HTR 8's Pause [III] key; the Learn LED turns amber.
- Press-and-hold the corresponding Pause key of your DVD player's remote control; the HTR 8's Learn LED flickers amber and then turns solid green. The command is learned.
- Press [DVD] again to exit the learning mode.

**NOTES**

- *The HTR 8 can learn up to 360 commands making use of all the DEVICE SELECTOR and function keys.*
- *The DEVICE SELECTOR keys can themselves be configured to learn a command.*
- *Press and hold a configured DEVICE SELECTOR for at least 2 seconds to execute a function assigned to the particular DEVICE SELECTOR key.*
- *Short press of a configured DEVICE SELECTOR will just switch the active device.*

**CANCEL OPERATION**

You can cancel configuring a key, by pressing the active DEVICE SELECTOR key before the learn process is complete; the Learn LED will turn red.

**PUNCH THROUGH**

The HTR 8's "punch-through" function allows you to retain a function key from one Device Select "page" to another, so that, for example, the AMP [SURR MODE] function might still control the T 777 when the DVD DEVICE SELECTOR page is active.

**NOTE**

*The HTR 8's [VOL ▲/▼] keys are pre-programmed as "punched-through" for all Device Select pages: [VOL ▲/▼] will operate the T 777's master-volume regardless of the currently selected device. The [SURR] [CENTER] and [SUB] Channel Volume controls similarly are pre-programmed as punched-through.*

To set a punch through, after entering the Learning Mode, and pressing the desired key to be punched through, simply press the device key twice of the device to punch through to. The status LED will turn green; press the DEVICE SELECTOR key again to exit Learning Mode.

**Example:** Punch-through AMP [SURR MODE] key to the DVD "page"

- On the HTR 8, simultaneously press-and-hold [DVD] and [RES]; the Learn LED turns steady green.
- Press [SURR MODE]; the Learn LED turns amber.
- Press [AMP] twice; the Learn LED turns green.
- Press [DVD] again to exit the learning mode.

**COPY A COMMAND FROM ANOTHER KEY**

You may copy a command from any HTR 8 key to any other. To copy a key function, after entering the Learning Mode, and pressing the desired key to be copied to, simply press the device key from which you wish to copy, having first pressed its DEVICE SELECTOR key if it resides on another "page." The status LED will turn green; press the DEVICE SELECTOR key again to exit Learning Mode.

**Example:** Copy the Pause command from the CD page to the AMP [II] button

- On the HTR 8, simultaneously press-and-hold [AMP] and [RES]; the Learn LED turns steady green.
- Press Pause [II]; the Learn LED turns amber.
- Press [CD]; press Pause [II]; the Learn LED turns green.
- Press [AMP] again to exit the learning mode.

**NOTE**

*The copy and punch-through functions are similar. However, if you copy a command and then subsequently delete or overwrite the original (source-key) command, the copied-to key's command remains unchanged. If you punch-through to a command and then delete or overwrite the original key, the punched-through functions also change accordingly.*

**MACRO COMMANDS**

A "macro" command is a series of two or more remote codes issued automatically from a single keypress. You might use a macro to automate a simple command sequence, such as, "Turn on the DVD player and then press PLAY". Or you might compose an elaborate macro to power up an entire system, select a source, choose a Listening Mode, and begin playback again, all from a single keypress. The HTR 8 can store one macro on each of its DEVICE SELECTOR and function keys.

**NOTE**

*Macros are independent of the currently selected device.*

**RECORDING MACROS**

To record a macro, simultaneously press-and-hold for 3 seconds both the [MACRO] key and the HTR 8 function key to which you wish to assign the macro, until the status LED turns green. The macro button will also light up.

Press the sequence of function keys to be recorded into the macro, being sure to first press the requisite DEVICE SELECTOR key for each function (you may switch devices while recording the macro as many times as necessary), allowing you to create macro containing commands from more than one DEVICE SELECTOR "page."

When you have finished entering the desired command sequence, press [MACRO] again to store the macro; the Learn LED and [MACRO] key illumination will turn off.

**NOTE**

*Each macro can store a maximum of 64 command steps. If you exceed this number, the macro will be stored automatically after the 64th command is added.*

## OPERATION

### USING THE HTR 8 REMOTE CONTROL

**Example:** Record a Macro to the [0] key to turn ON the T 777, turn ON the DVD Player, Select Input 1 (Source 1) and commence disc playback of connected Source 1 device (as in the DVD player)

- On the HTR 8, simultaneously press-and-hold [MACRO] and [0] (numeric zero); the Learn LED turns steady green.
- Press [AMP], press [ON]; press [DVD], press [ON]; press [AMP], press [1] (Input 1); press [DVD], press [▶] (Play) – the Learn LED blinks as each step is added.
- Press [MACRO] again to exit the macro-record mode.

To clear a macro, perform the above steps without entering any functions.

#### EXECUTING MACROS

To execute a macro, press and release [MACRO]; its key illumination lights for 5 seconds. While it remains lit, press an HTR 8 key to which a macro has previously been stored.

The corresponding macro will run; as each step executes, its “parent” DEVICE SELECTOR key flashes briefly; when execution is finished, the [MACRO] key illumination goes out. Pressing any other HTR 8 key while a macro is executing will abort the macro. Remember that you must hold the HTR 8 so that its infrared emitter can activate the target components.

#### NOTE

*When a macro executes, a 1 second delay is automatically inserted between its commands. If you need more than a 1 second delay between particular commands—for example, to permit a component to power up completely—you can record “empty” steps into the macro by changing DEVICE SELECTOR “pages” without entering actual command functions.*

#### KEY ILLUMINATION TIMEOUT

The HTR 8’s key-illumination can be set to remain lit for 0-9 seconds. The default value is 2 seconds. To set the illumination timeout, simultaneously press-and-hold for 3 seconds both the HTR 8’s [DISP] and the [0-9] key, with the digit corresponding to the desired timeout duration; the Learn LED will flash twice to confirm the new setting. When set to zero, the illumination will not turn on at all.

#### NOTES

- Key illumination is activated when one presses any HTR 8 key.
- If HTR 8 senses movement, key illumination is activated without having to press a key. If HTR 8 is shaken, key illumination is also activated.
- Key illumination is the biggest drain on the HTR 8’s batteries. A short key illumination timeout will extend battery life appreciably; turning it off altogether (set it to 0 seconds) will lengthen it still further.

#### CONFIGURING KEY ILLUMINATION

Keys to Press (for 3 seconds)	Mode
DISP + Digit Key (0-9)	Set key illumination timeout to number of seconds corresponding to digit key. Zero turns off the key illumination entirely.
DISP + OFF	Disable light sensor. Key illumination will turn on with any key press.
DISP + ON	Enable light sensor.
DISP + ENTER	Set the light sensor threshold to the current light level.
DISP + RTN	Restore all key illumination settings to the defaults.

#### FACTORY RESET

The HTR 8 can be reset to its factory state, deleting all learned commands, copied and punched-through keys, macros, and other setup information; reverting all keys to their pre-programmed library commands.

To perform a factory reset simultaneously press-and-hold for 10 seconds the HTR 8’s [ON] and [RTN] keys; the Learn LED will start to flash green. Release [ON] and [RTN] before the second flash is complete; the Learn LED will turn red, indicating the remote has been reset.

#### NOTE

*You must release [ON] and [RTN] before the second flash goes out, otherwise the unit will not reset; should this occur, repeat the full procedure.*

#### DELETE MODE

The HTR 8 can store learned, copied, and “default library” commands on any single key. The default library commands are the pre-programmed NAD codes, such as the native T 777 commands on the [AMP] “page”.

You can delete commands by layers back “down” to the default library command on any key, removing learned commands, punched-through functions, and copied keys.

#### NOTE

*The default library commands cannot be deleted, so you need not worry that using Delete Mode might cause irreparable changes.*

To enter Delete Mode, simultaneously press-and-hold for 3 seconds both the desired key’s DEVICE SELECTOR key and the [RTN] key, until the Learn LED turns green. Press the function key whose command you wish to delete; the Learn LED flashes; the number of times indicates which type of function has become active - see the table below. Press the active DEVICE SELECTOR key again to exit Delete Mode.

#### NOTE

*You may delete multiple function-key commands on the same DEVICE SELECTOR “page”, but to delete from more than one DEVICE SELECTOR page you must exit Delete Mode and then re-enter it on the required page.*

Flashes	Command Type
1	Default Library Command
2	Copied Library Command
3	Learned Command

**LOADING CODE-LIBRARIES**

The HTR 8 can store a different library of default NAD codes for each of its DEVICE SELECTOR “pages”. If the original default library does not control your NAD CD player, BD player, DVD player or other component, follow the procedure below to change the code-library.

Begin by ensuring that the component you wish the HTR 8 to control is plugged in and powered-up (“ON”, not merely in standby). To enter the HTR 8’s Library Mode, simultaneously press-and-hold for 3 seconds both the desired DEVICE SELECTOR key and the [A/V PSET] key, until the Learn LED turns green.

While keeping the HTR 8 pointed toward the component, enter the first appropriate three-digit code-library number from the table below and then press [OFF]. If the component turns off, press [ENTER] to accept that code-library number and exit the Library Mode. If the component does not turn off, enter the next three-digit code-library number from the table.

When you enter the correct number the component will turn off; press [ENTER] to accept that code library number and exit the Library Mode.

LIBRARY CODE	NAD PRODUCT DESCRIPTION	LIBRARY CODE	NAD PRODUCT DESCRIPTION
100	Receiver/Processor (Discrete ON/OFF)	300	Tuner
101	Receiver/Processor (Toggle ON/OFF)	301	L75, L76 Tuner
102	S170	302	L70 Tuner
103	L75	303	L53 Tuner
104	Second Zone Commands (Zone 2)	304	L73 Tuner
3112	Zone 3	305	C425
4112	Zone 4	306	C445
105	L70	307	Txx5 Series Tuner
106	L76	400	Tape Deck B
107	118	401	TAPE Deck A
108	L53	500	TV 280
109	L73	501	MR13
110	Stereo Receiver / Amplifier	502	MR20
111	Stereo Second Zone	503	PMR45
112	Txx5 Series	600	T535, T562, T585, M55
200	CD Player	601	T550, L55
201	CD Player (old)	602	T512, T531, T532, T571, T572
202	5170, 5240, 5340	603	L70, L73 DVD
203	5325	604	L56
204	5060	605	T513, T514, T515, T517, T524, T533, T534
205	M5	606	L53 DVD

**SEARCH MODE**

If none of the codes from the table, when entered, turns on the component, and if you are quite sure you have followed the above procedure completely and carefully, you may want to try the “search” method as follows:

Enter Library Mode by simultaneously pressing-and-holding for 3 seconds both the desired DEVICE SELECTOR key and the [A/V PSET] key, until the Learn LED turns green. Now press-and-hold the HTR 8’s [▲] or [▼] key; the remote will step through all the available codes at a rate of approximately 1 per second.

When the component turns off, immediately release the cursor key; press [ENTER] to accept that code-library and exit the Library Mode. Try a few commands; should you prove to have stepped past the needed code-library, re-enter the Library Mode and use the cursor key to step back to it.

**NOTE**

*It is possible that search mode will find code-libraries that operate, at least partially, some other brand (non-NAD) components. You may certainly exploit such capabilities as you find them. However, since we can only ensure the completeness or accuracy of NAD code-libraries, we cannot support the HTR 8’s operation with other-brand components.*

**CHECKING CODE-LIBRARY NUMBER**

You can check the current code-library on any DEVICE SELECTOR key as follows. Enter Library Mode by simultaneously pressing-and-holding for 3 seconds both the desired component’s DEVICE SELECTOR key and the [A/V PSET] key, until the Learn LED turns green. Press the [DISP] key; the HTR 8 indicates the current code-library by flashing its [CUSTOM], [BD], and [MACRO] keys.

For example, to indicate code-library #501, the HTR 8 will flash [CUSTOM] 5 times, pause, and then flash [MACRO] once. You might wish to make a note of your components’ code-library numbers.

**SUMMARY OF THE HTR 8 MODES**

Mode	Keys To Press (for 3 seconds)
Learn/Copy/Punch Through	Device Key + RES Key
Delete Mode	Device Key + RTN Key
Macro Record	MACRO Key + Function Key
Library Mode	Device Key + A/V PSET Key
Back Light Timeout	DISP Key + Digit Key
Factory Reset	See “Factory Reset” above

## OPERATION

### USING THE HTR 8 REMOTE CONTROL

#### USB INTERFACE

The HTR 8 allows one to upload and download the configuration through a Windows® PC and NAD's Proprietary HTR 8 programming software. Use a USB A male to mini USB B male 5-pin cable (not supplied) between your Windows® PC and the HTR 8. See illustration below on how to connect a USB A male to mini USB B male 5-pin cable to the HTR 8.

#### NOTE

Please log onto [www.nadelectronics.com/HTR8](http://www.nadelectronics.com/HTR8) for the latest HTR 8 interface control software. Your custom installer or dealer can assist you in the proper setup and configuration of the mini USB interface and software.

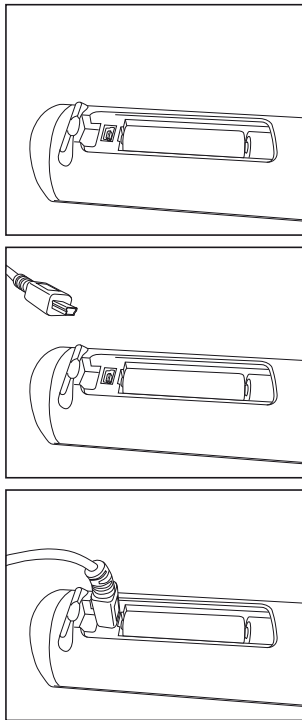

#### SLEEP MODE

The Sleep Mode timer will switch the T 777 to Standby mode automatically after a preset number of minutes. Pressing the HTR 8's SLEEP button once will display the setting of the sleep time increment. Pressing the HTR 8's SLEEP button a second time within a 3-second period will change the sleep time increment in 15-minute intervals, after which time the T 777 will automatically switch into Standby mode.

To adjust the sleep delay, press the HTR 8's SLEEP button twice; first to display the sleep time increment, and a second time to change the sleep time increment. The sleep time increment and a "SLEEP" icon will continuously display on the T 777's front panel Vacuum Fluorescent Display (VFD). Each consecutive press increases the sleep time in 15-minute increments from 15 to 90 minutes. To cancel the sleep mode, continue pressing the HTR 8's SLEEP button until "Sleep Off" displays on the VFD. Switching the T 777 to standby from either the HTR 8's OFF or the T 777's STANDBY button will also cancel the sleep mode.

#### USING THE ZR 7 REMOTE CONTROL

The ZR 7 is a discrete compact remote for controlling the Zone 2 feature of the T 777. Irrespective of the main room/zone settings, the ZR 7 allows full separate control of the Zone 2 source selection among other applicable features.

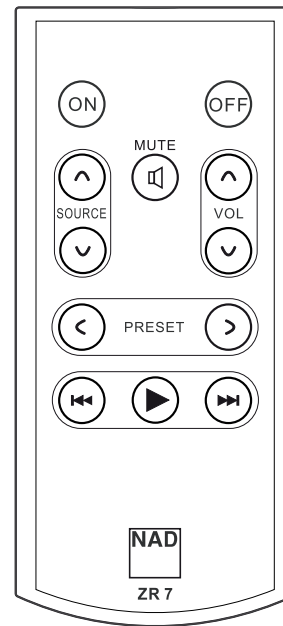

- 1 ON/OFF:** Switch ON/OFF the Zone feature.
- 2 SOURCE [ ^/∨ ]:** Select the active input of the NAD T 777 that will be sent out to the corresponding rear panel ZONE 2 output port.
- 3 MUTE:** Temporarily switch OFF or restore the Zone Volume level.
- 4 VOLUME [ ^/∨ ]:** Increase or decrease the loudness level of selected Zone source. This is possible only if the VOLUME setting of ZONE 2 CONTROLS is set to VARIABLE.
- 5 PRESET [ </> ]:** Step up or down between stored radio presets. This control button is possible if the selected Zone is "TUNER" and the active tuner section has stored presets. This control button is not applicable to T 777.
- The following CD Player Zone buttons can control a compatible CD Player. The CD Player has to be powered ON and disc loaded.
  - SKIP [ ►► ]:** Go to the beginning of a track/file or previous track/file.
  - SKIP [ ◀◀ ]:** Go to the next track/file.
  - [ ► ]:** Start playback.

#### NOTE

The ZR 7 remote control will only control Zone 2 applications. Zone 3 and Zone 4 could be configured and managed at the appropriate Zone OSD menu using the front panel navigations keys as well as the corresponding keys on the HTR 8 remote control. The HTR 8's 'CUSTOM' device is also defaulted to Zone 2 remote control codes.

The T 777 has the capability to operate via Alternate IR channel. This is practically useful if you have two NAD products that can be operated by similar remote control commands. With alternate IR Channel, two different NAD products can be controlled independently in the same zone by setting each one to a different IR channel.

### IR CHANNEL ASSIGNMENT

The T 777 and the HTR 8 remote control must be set to the same channel.

#### To change the Main Zone IR Channel on the T 777

- Press and hold [ < SOURCE ] and then toggle STANDBY button to select desired IR Channel – the VFD will show “IR Channel 1” or “IR Channel 0”. The default IR Channel is “IR Channel 0”.

#### To change the IR Channel on the HTR 8 remote control

- Include a channel number before the library code. For HTR 8, library code “100” is the default library table for “AMP” device. To select this “AMP” library table for “IR Channel 0”, retain the library code “100”.
- If you want to load the “AMP” library table on “IR Channel 1”, prefix the library code with “1” to indicate association with “IR Channel 1”. Load then the “AMP” library table using the code “1100”.

#### SAMPLE SETUP OF TWO NAD PRODUCTS ON THE SAME ZONE

NAD T 777 and NAD C 326BEE are both defaulted to IR Channel 0. If [OFF] button is pressed on the HTR 8 remote control (or SR 8 remote control for the C 326BEE), both products will go to standby mode. Press [ON] and both products will power up from standby mode.

To prevent both products from simultaneously going in and out of standby mode along with other common commands, set each one to a different IR channel. In this setup, we will keep C 326BEE and SR 8 remote control defaulted to “IR Channel 0”. As for T 777, we will assign it to “IR Channel 1”; the same applies to HTR 8.

Set T 777 and HTR 8 to “IR Channel 1” via the following procedure.

#### T 777

- Press and hold [ < SOURCE ] and then toggle STANDBY button to select “IR Channel 1”.

#### HTR 8

Begin by ensuring that the T 777 is powered-up (“on”, not merely in standby).

- To enter HTR 8’s library mode, press and hold both the [AMP] device and [A/V PSET] until the LEARN LED turns green.
- While keeping the HTR 8 pointed towards the T 777, enter the library code “1100”. Press [OFF]. If the T 777 goes to standby mode, press [ENTER] to accept the library code number and exit library mode.

With both T 777 and HTR 8 set to “IR Channel 1”, the C 326BEE can now be remotely controlled independent of the T 777.

#### NOTE

*Performing a Factory Reset for T 777 or HTR 8 will result to a return to the factory default “IR Channel 0” setting.*

CONDITION	POSSIBLE CAUSES	POSSIBLE SOLUTIONS
<b>No sound from all channels.</b>	• AC power unplugged.	• Check AC cable connection and outlet.
	• Power not switched on.	
	• Outlet has no power.	• Toggle [MUTE] button to deactivate Mute function.
	• Mute function is activated.	
<b>No sound from some channels.</b>	• Faulty/missing cables.	• Check cables.
	• "Speaker Configuration" channel (s) set to "OFF".	• Check "Speaker Configuration" menu.
<b>No sound from surround channels.</b>	• No surround listening mode is engaged.	• Select appropriate listening mode.
	• Surround channels set to "OFF" on "Speaker Configuration" menu.	• Correct "Speaker Configuration" or "Speaker Levels" settings.
	• Surround channels level set too low on "Speaker Levels" menu.	
<b>No sound from Subwoofer.</b>	• Subwoofer is off, not powered or improperly connected.	• Power up subwoofer, check subwoofer's AC outlet or check connections.
	• Subwoofer set to "OFF" on "Speaker Configuration" menu.	• Correct "Speaker Configuration" or "Speaker Levels" settings.
	• Subwoofer level set too low on "Speaker Levels" menu.	
<b>No sound from Center channel.</b>	• Source is a 2/0 (etc.) Dolby Digital or DTS recording without center channel.	• Play a known 5.1-channel recording or select Dolby Pro Logic IIx Music mode.
	• Center set to "OFF" on "Speaker Configuration" menu.	• Correct "Speaker Configuration" or "Speaker Levels" settings.
	• Center level set too low on "Speaker Levels" menu.	
<b>No Dolby Digital/DTS.</b>	• Source's digital output is not connected to a T 777 digital input.	• Check connections.
	• Source component not configured for multichannel digital output.	• Check source component setup.
<b>T 777 does not respond to remote control commands.</b>	• Batteries are flat or incorrectly inserted.	• Check batteries.
	• Infrared receiver (IR) window of T 777 or IR transmitter of the remote control is obstructed.	• Check IR windows and ensure clear line-of-sight from remote to T 777.
	• T 777 front panel is in very bright sunlight or ambient light.	• Reduce sunlight/room lighting.
<b>No RDS information.</b>	• Station signal too weak.	• Check station tuning. Adjust or replace antenna.
	• Station not transmitting RDS data.	• Tune to an RDS station that supports program-service name (PS mode) and radio-text mode (RT).
<b>Display shows "No Service List".</b>	• DAB antenna not connected properly.	• Check the connection and position of DAB antenna.
	• No DAB coverage in the area.	• Call your local DAB broadcast providers for coverage information.

**Reset T 777 to factory default settings:** Press and hold [ < SOURCE ] and [ FRONT INPUT/MP ] front panel buttons until "Factory Reset..complete:" is shown in the VFD.

**AMPLIFIER SECTION**

Power output, Stereo Mode	120W (20.8dBW) (8Ω within rated distortion)
IHF dynamic power; 8 Ω	160W (22.0BW)
IHF dynamic power; 4 Ω	260W (24.1dBW)
Power output, Surround Mode	7 x 80W (19.0dBW)
Total harmonic distortion at rated power	<0.08%
IM distortion at rated power	<0.08%
Damping factor, 8 Ω	>60
Input sensitivity and impedance	1.15V (ref. 8Ω, VOL at 0 dB)
Frequency response	±0.8dB (ref. 1 kHz, 20 Hz-20 kHz)
Signal/noise ratio	>92dB (ref. rated power at 8Ω, A-WTD)
Signal/noise ratio	>82dB (ref. 1W at 8Ω, A-WTD)

**PREAMPLIFIER SECTION**

Frequency response	±0.5 dB (ref. 20 Hz – 20 kHz)
Signal-to-noise ratio	>88 dB (ref. 2V, A-WTD)
Total harmonic distortion	<0.01%
Input sensitivity	330 mV (ref. 2V)
Maximum output level	>4V

**TUNER SECTION**

**AM Section**

Tuning range	530 kHz -1710 kHz (120V version only, 10 kHz steps) 531 kHz -1602 kHz (230V version only, 9 kHz steps)
Usable sensitivity	55 dBu
Signal-to-noise ratio	38 dB
Total Harmonic Distortion	<3 %
Loop sensitivity 20dB S/N	66 dBu

**FM Section**

Tuning range	87.50 MHz – 108.50 MHz
Usable sensitivity, MONO	<9 dBμV
Signal-to-noise ratio, MONO	60 dB
Signal-to-noise ratio, STEREO	55 dB
Total Harmonic Distortion, MONO	0.7 %
Total Harmonic Distortion, STEREO	1.0 %
Channel Separation	30 dBμV
RDS decode sensitivity	28 dBμV

**POWER CONSUMPTION**

Standby power	<0.5W
Idle Power	>70W (120V version only) >63W (230V version only)

**DIMENSION AND WEIGHT**

Unit Dimensions (W x H x D)	435 x 172 x 425 mm (Gross)* 17 1/8 x 6 13/16 x 16 3/4 inches
Net Weight	20.5 kg (45.2 lbs)
Shipping Weight	24.2 kg (53.4 lbs)

\* Gross dimension includes feet, volume knob and extended rear panel terminals.

Specifications are subject to change without notice.  
For updated documentation and features, please log onto [www.NADelectronics.com](http://www.NADelectronics.com) for the latest information about T 777.

Manufactured under license under U.S. Patent #'s: 5,451,942; 5,956,674; 5,974,380; 5,978,762; 6,226,616; 6,487,535; 7,212,872; 7,333,929; 7,392,195; 7,272,567 & other U.S. and worldwide patents issued & pending. DTS is a registered trademark and the DTS logos, Symbol, DTS-HD and DTS-HD Master Audio are trademarks of DTS, Inc. © 1996-2009 DTS, Inc. All Rights Reserved.

Manufactured under license from Dolby Laboratories.  
"Dolby", "Pro Logic", and the double-D symbol are registered trademarks of Dolby Laboratories.

HDMI, the HDMI logo and High-Definition Multimedia Interface are trademarks or registered trademarks of HDMI Licensing LLC.

The XM name, XM Ready and related logos are registered trademarks of XM Satellite Radio Inc.

Manufactured under license from Audyssey Laboratories. U.S. and foreign patents pending. Audyssey MultEQ XT is a trade-mark of Audyssey Laboratories.

This product incorporates copyright protection technology that is protected by method claims of certain U.S. patents and other intellectual property rights owned by Macrovision Corporation and other rights owners. Use of this copyright protection technology must be authorized by Macrovision Corporation, and is intended for home and other limited viewing uses only unless otherwise authorized by Macrovision Corporation. Reverse engineering or disassembly is prohibited. Chapter



[www.NADelectronics.com](http://www.NADelectronics.com)

**©2012 NAD ELECTRONICS INTERNATIONAL  
A DIVISION OF LENBROOK INDUSTRIES LIMITED**

All rights reserved. NAD and the NAD logo are trademarks of NAD Electronics International, a division of Lenbrook Industries Limited.  
No part of this publication may be reproduced, stored or transmitted in any form without the written permission of NAD Electronics International.  
While every effort has been made to ensure the contents are accurate at the time of publication, features and specifications may be subject to change without prior notice.

T777\_ENG\_OM\_V05 - FEB 2012