



N8800-057F/058F
NEC Express5800/320Lb/320Lb-R
User's Guide

1st Edition
4-2005
856-125249-901-A

PROPRIETARY NOTICE AND LIABILITY DISCLAIMER

The information disclosed in this document, including all designs and related materials, is the valuable property of NEC Corporation (NEC) and /or its licensors. NEC and/or its licensors, as appropriate, reserve all patent, copyright and other proprietary rights to this document, including all design, manufacturing, reproduction, use, and sales rights thereto, except to the extent said rights are expressly granted to others.

The NEC product(s) discussed in this document are warranted in accordance with the terms of the Warranty Statement accompanying each product. However, actual performance of each such product is dependent upon factors such as system configuration, customer data, and operator control. Since implementation by customers of each product may vary, the suitability of specific product configurations and applications must be determined by the customer and is not warranted by NEC.

To allow for design and specification improvements, the information in this document is subject to change at any time, without notice. Reproduction of this document or portions thereof without prior written approval of NEC is prohibited.

First Printing, April 2005
Copyright 2005
NEC Corporation
7-1 Shiba 5-Chome, Minato-Ku
Tokyo 108-8001, Japan
All Rights Reserved
Printed in Japan



Keep this User's Guide handy for quick reference when necessary.

SAFETY INDICATIONS



To use NEC Express5800 Series safely, follow the instructions in this User's Guide.

This guide explains components that pose a danger, types of dangers, and actions taken to prevent them; such components are labeled warning.

This guide and warning labels use "WARNING" and "CAUTION" to indicate a danger depending on the degree. These terms are defined as follows:

 WARNING	Indicates a danger that could lead to a death or serious injury.
 CAUTION	Indicates a danger that could lead to a burn, other injuries or damage to physical assets.

This guide uses the following three types of symbols to give indications and precautions against a danger. They are defined as follows:





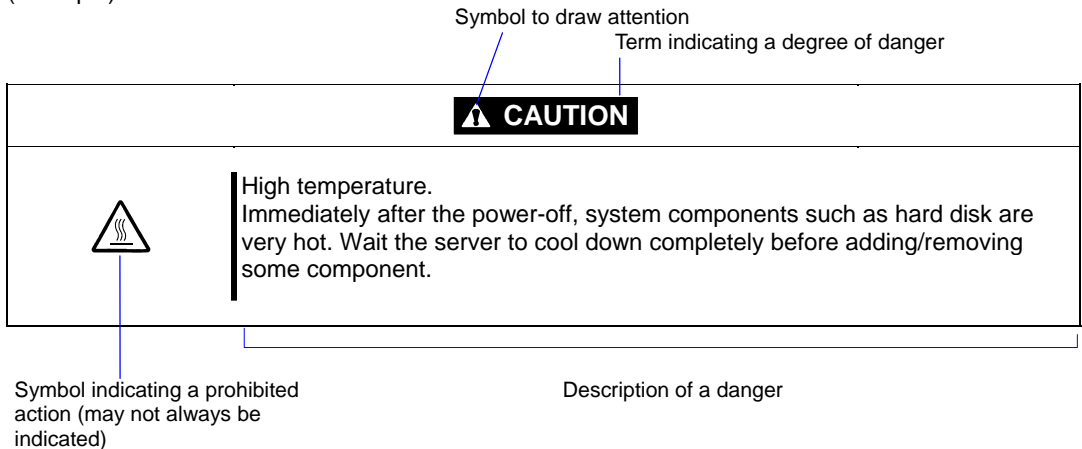

	Indicates that there are risks of a danger. Each image symbolizes a particular type of danger. (Attention)
	Indicates what you must not do. Each image symbolizes a particular type of prohibition. (Prohibited actions)
	Indicates what you must do. Each image symbolizes a particular type of action necessary to avoid a danger. (Mandatory actions)

(Example)





SYMBOLS USED IN THIS USER'S GUIDE AND WARNING LABELS



Attention

	Indicates a risk of an electric shock.
	Indicates a risk of an injury due to heat.
	Indicates a risk of catching your fingers.
	Indicates a risk of a fire or smoke.
	Indicates a general precaution or warning that is not defined herein.
	Indicates a risk of losing eyesight due to laser beam.
	Indicates a risk of an injury or damage to physical assets due to a hazardous material.

Prohibited actions

	Indicates a general prohibition that is not defined herein.
	Do not disassemble, repair, or modify the equipment. Otherwise, there is a risk of an electric shock or fire.

Mandatory actions

	Unplug the server. Otherwise, there is a risk of an electric shock or fire.
	Indicates a general action to take that is not defined herein. Make sure to follow the instructions.

NOTE: This equipment has been tested and found to comply with the limits for a Class A digital device, pursuant to Part 15 of the FCC Rules. These limits are designed to provide reasonable protection against harmful interference when the equipment is operated in a commercial environment. This equipment generates, uses, and can radiate radio frequency energy and, if not installed and used in accordance with the instruction manual, may cause harmful interference to radio communications. Operation of this equipment in a residential area is likely to cause harmful interference in which case the user will be required to correct the interference at his own expense.

警告使用者：

這是甲類的資訊產品，在居住的環境中使用時，可能會造成射頻干擾，
在這種情況下，使用者會被要求採取某些適當的對策。

이 기기는 업무용으로 전자파적합등록을
한 기기이오니 판매자 또는 사용자는
이 점을 주의하시기 바라며 만약 잘못
판매 또는 구입하였을 때에는 가정용으
로 교환하시기 바랍니다.

This class A digital apparatus meets all requirements of the Canadian Interference-Causing Equipment Regulations.

Cet appareil numérique de la classe A respecte toutes les exigences du Règlement sur le matériel brouilleur du Canada.

CE Statement

Warning: This is a Class A product. In residential environment, this product may cause radio interference, in which case the user may be required to take adequate measures (EN55022).

NOTE: This product provides resistance against hardware faults with its redundant hardware modules. However, this does not mean complete fault-tolerance is assured. For example, there is a risk of system down when:

- A fatal fault occurs in software.
- Both modules within a redundant hardware pair break down.
- A fatal fault occurs in a non-redundant component, such as the clock generator circuitry or the interconnect backplane.
- The entire system is cut off from AC power.

Trademarks

NEC ESMPRO, NEC EXPRESSBUILDER, and NEC Express5800/ft series are trademarks of NEC Corporation. Microsoft, Windows, Windows NT, and MS-DOS are registered trademarks of Microsoft Corporation in the United States and other countries.

Intel and Pentium are registered trademarks of Intel Corporation. Xeon is a trademark of Intel Corporation in the United States. Adobe, the Adobe logo, Acrobat, and the Acrobat logo are trademarks of Adobe Systems Incorporated. AT is a registered trademark of International Business Machines Corporation in the United States and other countries. Stratus is a registered trademark of Stratus Technologies Bermuda Ltd. Datalight is a registered trademark of Datalight, Inc. Linux is a registered trademark of Linus Torvalds. Red Hat and RPM are trademarks or registered trademarks of Red Hat, Inc. in the United States and other countries.

All other product, brand, or trade names used in this publication are the trademarks or registered trademarks of their respective trademark owners.

Microsoft Windows Server 2003 Standard Edition operating system and Microsoft Windows Server 2003 Enterprise Edition operating system are called Windows Server for short. Microsoft Windows 2000 Server operating system, Microsoft Windows 2000 Advanced Server operating system and Microsoft Windows 2000 Professional operating system are called Windows 2000 for short. Microsoft Windows NT Server network operating system version 3.51/4.0 and Microsoft Windows NT Workstation operating system version 3.51/4.0 are called Windows NT for short. Microsoft Windows Millennium Edition Operating System is called Windows Me for short. Microsoft Windows 98 operating system is called Windows 98 for short. Microsoft Windows 95 operating system is called Windows 95 for short.

Names used with sample applications are all fictitious. They are unrelated to any existing product names, names of organizations, or individual names.

DLT and DLTtape are trademarks of Quantum Corporation in the United States. QLogic and its logo are trademarks of QLogic Corporation in the United States. Fast!UTIL is a trademark of QLogic Corporation in the United States. ROM-DOS is a trademark of Datalight, Inc.

Most of the software used for this server can be redistributed freely under the terms of the BSD Copyright and the GNU Public License. However, some software requires permissions for redistribution as the owners have ownership. For details, see "Introduction" in the attachment.

To prevent voltage sag:

This product may be affected by voltage sag caused due to lightning. To prevent voltage sag, you are recommended to use an AC uninterruptible power supply (UPS) unit.

Notes:

- (1) No part of this manual may be reproduced in any form without prior written permission of NEC Corporation.
- (2) The contents of this manual are subject to change without prior notice.
- (3) The contents of this manual shall not be copied or altered without prior written permission of NEC Corporation.
- (4) All efforts have been made to ensure the accuracy of all information in this manual. If you find any part unclear, incorrect, or omitted in this manual, contact the sales agent where you purchased this product.
- (5) NEC assumes no liability arising from the use of this product, nor any liability for incidental or consequential damage arising from the use of this manual regardless of (4) above.

PREFACE

Welcome to the NEC Express5800/ft series.

NEC Express5800/ft series is a “fault-tolerant (ft)” server focusing on “high reliability” in terms of fault-tolerance, in addition to “high performance,” “scalability,” and “general versatility” provided by NEC Express5800 series. In the event of trouble, its dual configuration will allow the system to instantaneously isolate the failed parts to assure non-stop running; operation will be moved smoothly from one module to the other, minimizing damage to it. You can use this NEC Express5800/ft series in a mission-critical system where high availability is required. By the use of Linux operating system, it also provides outstanding openness for general-purpose applications, etc.

To make the best use of these features, read this User's Guide thoroughly to understand how to operate NEC Express5800/ft series.

ABOUT THIS USER'S GUIDE

This User's Guide helps a user to properly setup and use the product.

Consult this guide to ensure safety as well as to cope with trouble during a system setup and daily operation.

Keep this manual handy.

This User's Guide is intended for users who have a good knowledge on the basic use of Linux operating systems and general I/O devices such as a keyboard and mouse.

How to Use This User's Guide

This guide consists of eight chapters and appendices. To help you find a solution quickly, the guide contains the following information:

For descriptions on setting up this product, see the separate volume "User's Guide (Setup)".

Read "Precautions for Use" first.

Before going on to main chapters, be sure to read "Precautions for Use." These precautions are very important for using the product safely.

Chapter 1 Precautions for Use

This chapter describes precautions necessary to use the product safely and properly. Be sure to read this chapter before using the product. It also provides information on user support. It will be helpful when you need maintenance service, support, etc.

Chapter 2 General Description

This chapter describes what you should know about the product: its component names, functions, operating procedures as well as handling of devices and other parts.

Chapter 3 Linux Setup and Operation

This chapter describes setup and operation specific to the product when it is on Linux.

Chapter 4 System Configuration

This chapter describes how to make settings of built-in basic input/output system. It also describes factory-shipped parameters.

Chapter 5 Installing and Using Utilities

This chapter describes features and operating procedures of a standard utility "NEC EXPRESSBUILDER." It also describes procedures to install and operate various software programs contained in its CD-ROM.

Chapter 6 Maintenance

This chapter describes maintenance procedures and use of maintenance tools. If you need to move the product for maintenance purposes, follow the steps provided in this chapter.

Chapter 7 Troubleshooting

If the product does not work properly, see this chapter before deciding that it is a breakdown.

Chapter 8 System Upgrade

This chapter describes procedures to add options and precautions. See also this chapter when you replace failed components.

Appendix A Specifications

This appendix lists specifications of the product.

Appendix B I/O Port Addresses

This appendix lists factory-assigned I/O port addresses.

Additional symbols

The following symbols are used throughout this User's Guide in addition to the caution symbols describe at the beginning.

IMPORTANT:	Important points or instructions to keep in mind when using the server or software
CHECK:	Something you need to make sure when using the server of software
TIPS:	Helpful information, something useful to know

Accessories

This product is shipped with various accessories. See the attached list to make sure everything is included and check the individual items. If some component is missing or damaged, contact your sales agent.

- Keep the accessories in a safe place. You will need them when you perform setup, addition of options, or replacement of failed components.
- To check NEC EXPRESSBUILDER components, see the attached list.
- Be sure to fill out and mail the software registration card that is attached to your operating system.
- Make backup copies of included floppy disks, if any. Keep the original disks as the master disks; use these copies in operation.
- Improper use of an included floppy disk or CD-ROM may alter your system environment. If you find something unclear, stop using them and contact your sales agent.

(This page is intentionally left blank.)

CONTENTS

PREFACE.....	i
ABOUT THIS USER'S GUIDE	ii
Chapter 1 Precautions for Use.....	1-1
WARNING LABELS	1-2
Tower Model	1-2
Rack-mount Model.....	1-4
PCI/CPU Modules.....	1-6
PRECAUTIONS FOR SAFETY	1-8
General	1-8
Use of Power Supply and Power Cord	1-9
Installation, Relocation, Storage and Connection.....	1-10
Cleaning and Handling of Internal Devices	1-12
During Operation	1-13
Rack-mount Model.....	1-14
For Proper Operation.....	1-15
TRANSFER TO THIRD PARTY	1-17
DISPOSAL OF EQUIPMENT AND CONSUMABLES	1-18
IF SYSTEM TROUBLE IS SUSPECTED.....	1-19
ABOUT REPAIR PARTS.....	1-19
Chapter 2 General Description	2-1
STANDARD FEATURES	2-2
NAMES AND FUNCTIONS OF COMPONENTS.....	2-6
Front View.....	2-6
Front View (inside).....	2-8
CD- ROM Drive.....	2-9
Rear View.....	2-10
CPU Module.....	2-12
PCI Module	2-14
Chassis Board Layout.....	2-15
LEDs	2-16
BASIC OPERATION	2-28
Locking and Unlocking the Front Bezel	2-28
Power ON.....	2-30
Power OFF	2-31
POST Check	2-32
Floppy Disk Drive.....	2-35
CD-ROM Drive.....	2-37
Chapter 3 Linux Setup and Operation	3-1
HARD DISK CONFIGURATIONS THAT CAN BE BUILT ON THE NEC Express5800/ft series.....	3-2
REPLACING 3.5-INCH HARD DISK DRIVE	3-4
How to Locate Failed Disks	3-4
Restoring Redundant Configuration Manually.....	3-6

Chapter 4 System Configuration	4-1
SYSTEM BIOS ~ SETUP ~	4-2
Starting SETUP Utility	4-3
Description of On-Screen Items and Key Usage	4-4
Configuration Examples	4-5
Menu and Parameter Descriptions.....	4-8
SCSI BIOS ~ <i>Fast!/UTIL</i> ~	4-29
Start	4-29
Configuration Settings.....	4-32
Scan SCSI Bus.....	4-36
SCSI Disk Utility.....	4-36
Select Host Adapter	4-36
Exit <i>Fast!/UTIL</i> ~ Termination and Storage of <i>Fast!/UTIL</i> ~	4-37
Setting List for Optional SCSI Device	4-37
FORCED SHUTDOWN AND CLEAR.....	4-38
Forced Shutdown.....	4-38
Clear CMOS / Password (Configuring Motherboard Jumpers).....	4-39
Chapter 5 Installing and Using Utilities.....	5-1
NEC EXPRESSBUILDER	5-2
Start Menu	5-2
NEC EXPRESSBUILDER Top Menu	5-4
Consoleless Menu.....	5-7
Master Control Menu	5-9
NEC ESMPRO Agent and Manager	5-10
Overview	5-10
NEC ESMPRO Agent.....	5-18
NEC ESMPRO Manager.....	5-23
Maintenance of NEC Express5800/ft series	5-36
NEC MWA ~ MANAGEMENT WORKSTATION APPLICATION ~	5-56
Servers to be remotely managed by MWA.....	5-56
Remote Management Configuration for the Server without Console.....	5-57
Chapter 6 Maintenance	6-1
DAILY MAINTENANCE	6-2
Checking Alert.....	6-2
Checking STATUS LEDs and LCD Display	6-2
Making Backup Copies	6-3
Cleaning.....	6-3
SYSTEM DIAGNOSTICS	6-7
Test Items.....	6-7
Startup and Exit of System Diagnosis	6-7
OFF-LINE MAINTENANCE UTILITY	6-9
Starting the Off-line Maintenance Utility	6-9
Features of Off-line Maintenance Utility.....	6-9
RELOCATING/STORING THE NEC Express5800/ft series.....	6-11

Chapter 7 Troubleshooting	7-1
TO LOCATE THE ERRORS.....	7-2
ERROR MESSAGES	7-3
Error Messages by LED Indication	7-3
Error Messages on the Liquid Crystal Display (LCD)	7-3
POST Error Messages	7-14
Error Notification by BEEP	7-20
Linux Error Messages	7-21
Server Management Application Error Message.....	7-23
SOLVING PROBLEMS	7-24
Problems with NEC Express5800/ft series.....	7-24
Event Log	7-31
Problems with NEC EXPRESSBUILDER	7-33
Problems with Master Control Menu	7-34
Problems with NEC ESMPRO.....	7-35
COLLECTION OF TROUBLE LOGS	7-36
Collection of syslog.....	7-36
Collection of System Information	7-36
Collection of the Memory Dump	7-37
Backup of IPMI Information	7-38
 Chapter 8 System Upgrade	 8-1
SAFETY PRECAUTIONS.....	8-2
ANTI-STATIC MEASURES	8-3
PREPARING YOUR SYSTEM FOR UPGRADE	8-4
3.5-INCH HARD DISK DRIVE	8-5
Installing 3.5-inch Hard Disk Drive	8-7
Removing 3.5-inch Hard Disk Drive.....	8-9
Replacing 3.5-inch Hard Disk Drive	8-10
RAID CONFIGURATION WHEN DISKS ARE ADDED	8-11
CPU MODULE	8-13
Removing CPU Module	8-14
Installing CPU Module.....	8-16
DIMM.....	8-18
Installing DIMM	8-20
Removing DIMM.....	8-21
Replacing DIMM	8-22
PROCESSOR (CPU).....	8-23
Installation.....	8-24
Removing CPU	8-27
Replacing CPU	8-28
PCI MODULE.....	8-29
Precautions	8-30
Removing PCI Module.....	8-31
Installing PCI Module	8-33
PCI BOARD.....	8-35
Installing PCI Board.....	8-36
Removing PCI Board	8-41
Replacing PCI Board.....	8-42

Setup of Optional PCI Board.....	8-43
Appendix A Specifications	A-1
Appendix B I/O Port Address	B-1

Chapter 1

Precautions for Use

This chapter includes information necessary for proper and safe operation of the server.

WARNING LABELS

Warning labels are placed in certain parts of the system so that the user stays alert to possible risks (Do not remove or damage these labels).



If some label is missing, about to peel off, or illegible, contact your sales agent.

The figures below show locations of the labels on tower model and rack-mount model servers.

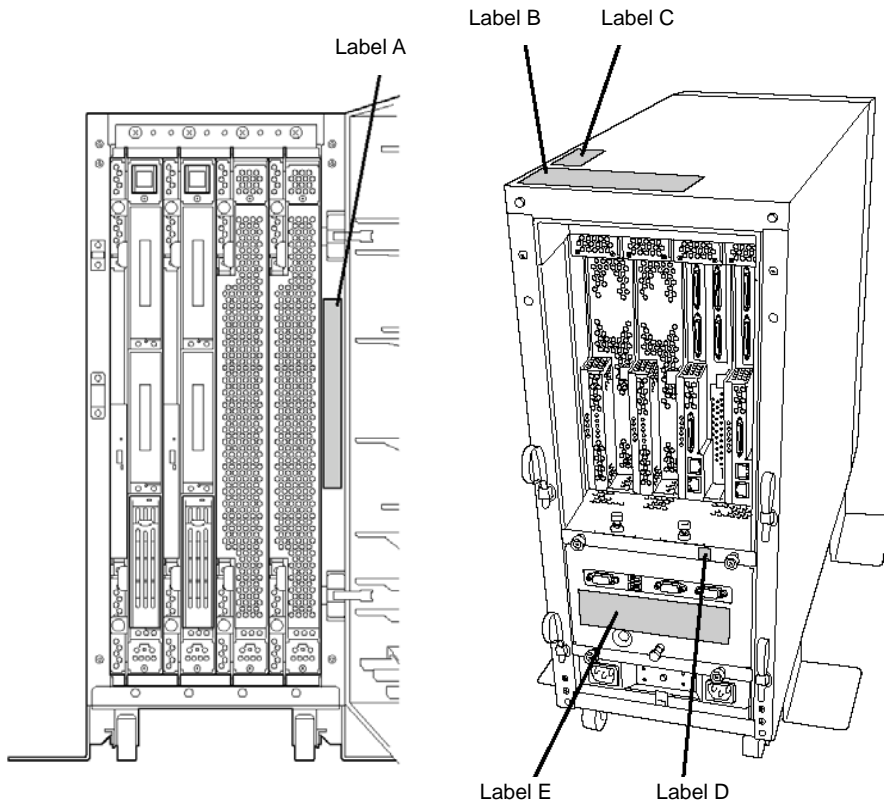
Tower Model



Label A

 注意 CAUTION 	<p>为防止触电及火灾，关于模块/线缆的安装/拆卸，请参考操作说明书。</p> <p>In order to prevent electrical shock or fire hazards, disconnect all cables connected with the module to be serviced.</p>
---	--

Label B

 注意 CAUTION  
<p>请小心不要夹住或碰伤手指。 Exercise caution when handling the system to avoid personal injuries.</p>
<p>设备运行时以及刚切断电源后，硬盘表面温度会很高，请一定要注意。 As the hard disk drives may retain heat after powering down, allow ample time for cooling prior to handling.</p>
<p>对 CPU 模块、PCI 模块、电源模块以外的部件进行维护时，为防止触电，请拔下所有电源线和外接线缆。 In order to prevent accidents such as electrical shock, disconnect all cables and external connections when servicing non-hotswappable modules.</p>
<p>有的部件可能会达到高温，请注意待其冷却之后再接触。 As some components may become very hot during system operation, give ample time to allow cooling as well as use preceation when handling internal components immediately after powering down.</p>
<p>请一定要注意不要把螺丝掉落在主机内部，否则可能会引起火灾。 In order to prevent short circuits and fire hazards, exercise caution and avoid dropping screws inside the system.</p>

Label C

 警告 WARNING
<p> 只有维护员方可对本设备进行拆卸，否则可能会引起触电等事故。 Risk of electric shock - do not open.</p> <p> Qualified service personnel only. No user servicable components inside.</p>

Label D





Label E

 注意 CAUTION	
<p>本设备连接有多个电源线。在进行维护时为防止触电，请务必拔掉所有电源线。</p> <p>This unit uses multiple power supply cords. Disconnect all power supply cords prior to Servicing this system</p>	

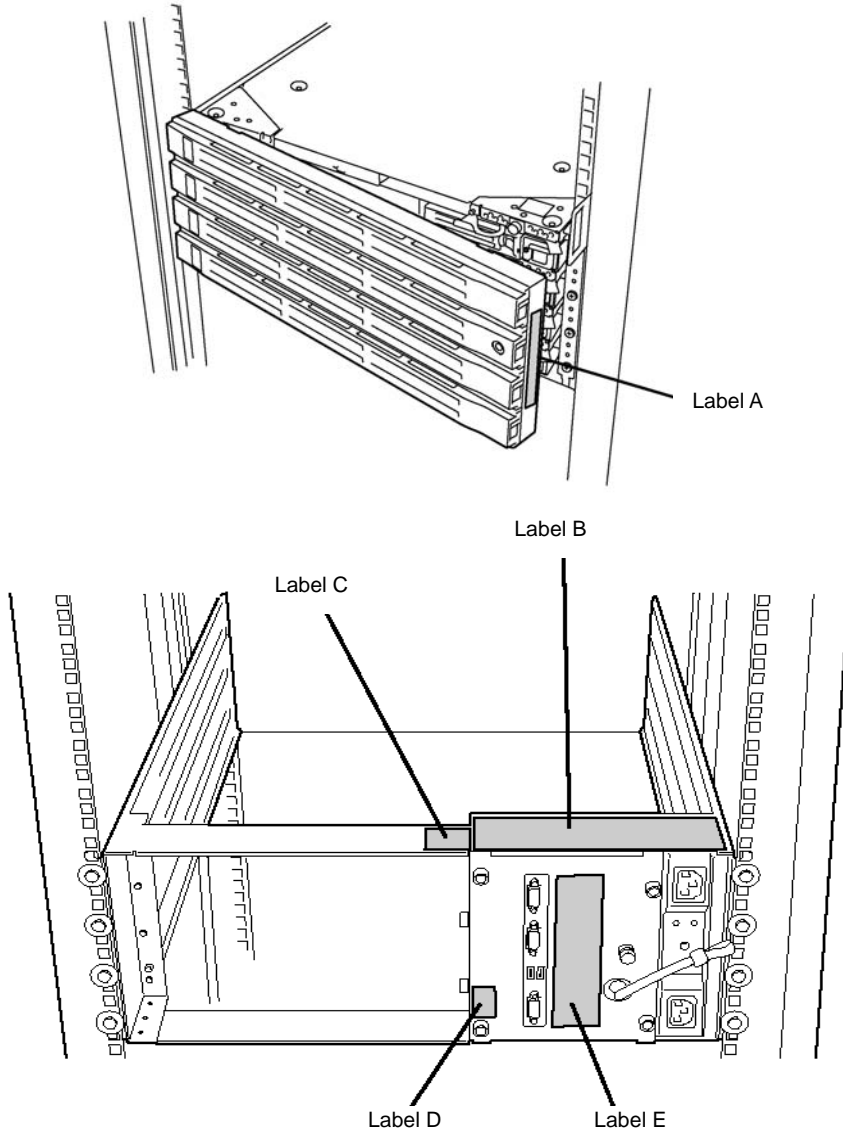
Rack-mount Model



Label A

 注意 CAUTION 	<p>为防止触电及火灾，关于模块/线缆的安装/拆卸，请参考操作说明书。</p> <p>In order to prevent electrical shock or fire hazards, disconnect all cables connected with the module to be serviced.</p>
---	--

Label B

 注意 CAUTION 	
<p>请小心不要夹住或碰伤手指。 Exercise caution when handling the system to avoid personal injuries.</p>	
<p>设备运行时以及刚切断电源后，硬盘表面温度会很高，请一定注意。 As the hard disk drives may retain heat after powering down, allow ample time for cooling prior to handling.</p>	
<p>对 CPU 模块、PCI 模块、电源模块以外的部件进行维护时，为防止触电，请拔下所有电源线和外接线缆。 In order to prevent accidents such as electrical shock, disconnect all cables and external connections when servicing non-hotswappable modules.</p>	
<p>有的部件可能会达到高温，请注意待其冷却之后再接触。 As some components may become very hot during system operation, give ample time to allow cooling as well as use precaution when handling internal components immediately after powering down.</p>	
<p>请一定注意不要把螺丝掉落在主机内部，否则可能会引起火灾。 In order to prevent short circuits and fire hazards, exercise caution and avoid dropping screws inside the system.</p>	

Label C

 警告 WARNING
<p> 只有维护员方可对本设备进行拆卸，否则可能会引起触电等事故。 Risk of electric shock - do not open.</p>
<p> Qualified service personnel only. No user serviceable components inside.</p>

Label D



Label E

 注意 CAUTION
<p>本设备连接有多个电源线。在进行维护时为防止触电，请务必拔掉所有电源线。</p> <p>This unit uses multiple power supply cords. Disconnect all power supply cords prior to Servicing this system</p>

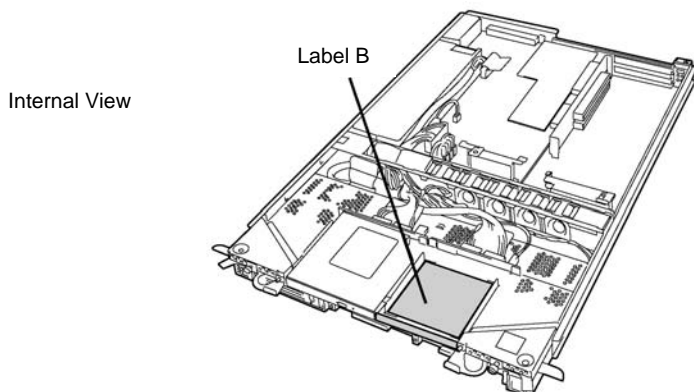
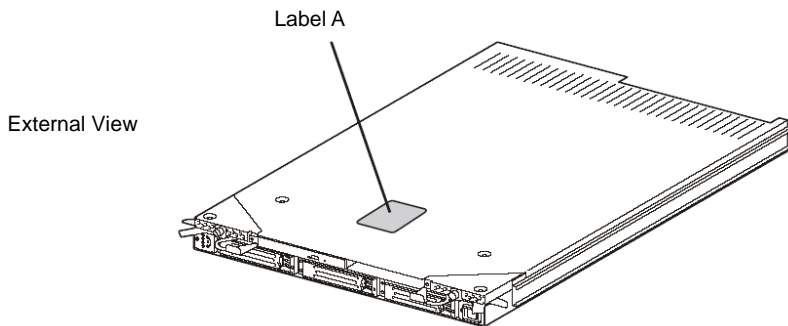

PCI/CPU Modules

PCI Module

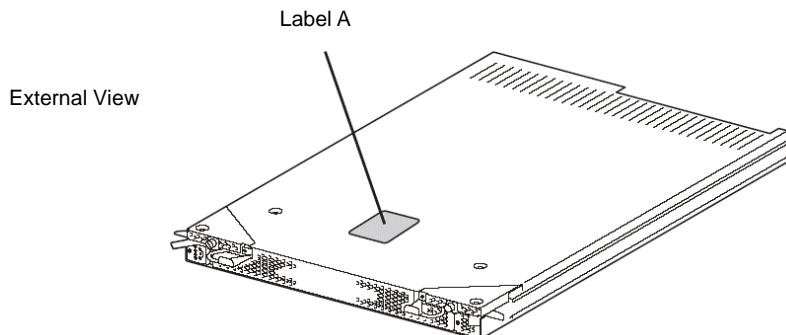

CPU Module

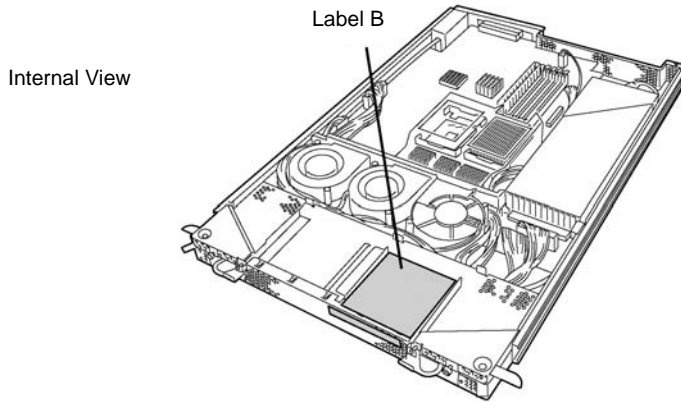



Label A



Label B



PRECAUTIONS FOR SAFETY

This section provides precautions for using the server safely. Read this section carefully to ensure proper and safe use of the server. For symbol meanings, see "SAFETY INDICATIONS" described in the previous section.

General

WARNING



Do not use the equipment in an operation where human lives are involved or high reliability is required.

This equipment is not intended for use in controlling or use with facilities or systems where human lives are involved or high reliability is required, including medical devices or nuclear, aerospace, transportation, and traffic control facilities. NEC assumes no liability for any accidents or damage to physical assets resulting from the use of this equipment in such systems or facilities.



Do not continue to use the equipment if you detect smoke, odor, or noise.

If the equipment emits smoke, odor, or noise, immediately flip off the POWER switch, unplug the cord, and contact your sales agent. There is a risk of a fire.



Do not insert a wire or metal object

Do not insert a wire or metal objects into a vent or disk drive slot. There is a risk of an electric shock.



Do not use the equipment in an unsuitable place.

Do not install a server rack in an unsuitable environment.

Other systems also may be affected, and the rack may fall over to cause a fire or injuries. For details about installation environment and quake-resistant engineering, see the attached manual or contact your sales agent.

CAUTION



Prevent water or foreign objects from getting into the equipment.

Do not let water or foreign objects (e.g., pins or paper clips) enter the equipment. There is a risk of a fire, electric shock, and breakdown. When such things accidentally enter the equipment, immediately turn off the power and unplug the cord. Contact your sales agent instead of trying to disassemble it yourself.

Use of Power Supply and Power Cord

⚠ WARNING



Do not handle a power plug with a wet hand.

Do not plug/unplug a power cord with a wet hand. There is a risk of an electric shock.



Do not connect the ground wire to a gas pipe.

Never connect the ground wire to a gas pipe. There is a risk of a gas explosion.

⚠ CAUTION



Do not plug the cord in a nonconforming outlet.



Use a wall outlet with specified voltage and power type. There is a risk of a fire or current leakage.

Avoid installing the equipment where you may need an extension cord. If the cord that does not meet the power specifications, there is a risk of overheating that could lead to a fire.



Do not plug too many cords in a single outlet.

If the rated current is exceeded, there is a risk of overheating that could lead to a fire.



Do not plug the cord insecurely.

Insert the plug firmly into an outlet. There is a risk of heat or fire due to poor contact. If dust settles on the slots and it absorbs moisture, there is also a risk of heat or fire.



Do not use nonconforming power cords.



Use the power cords specified by NEC. If the rated current is exceeded, there is a risk of a fire.

You also have to observe the following prohibitions to prevent an electric shock and a fire caused by damages of the cords.

- Do not pull on the cord.
- Do not pinch the cord.
- Do not bend the cord.
- Keep chemicals away from the cord.
- Do not twist the cord.
- Do not tread on the cord.
- Do not place any object on the cord.
- Do not use cords as bundled.
- Do not alter, modify, or repair the cord.
- Do not staple the cord.
- Do not use any damaged cord. (Replace it with a new one of the same specifications. For replacement procedures, contact your sales agent.)

Installation, Relocation, Storage and Connection

WARNING



Disconnect the power cord(s) before installing or removing the equipment.
Be sure to power off the equipment and unplug its power cords from the wall outlet before installation/relocation. All voltage is removed only when the power cords are unplugged.

CAUTION



Do not hold the front bezel to lift the equipment.
The equipment weighs around 70 kg (depending on its hardware configuration). Do not hold the front bezel, or it may become detached, causing an injury. For lifting and moving the equipment, remove the mounted modules from the main unit and carry them separately. It takes at least two people to carry it; hold the equipment firmly by its bottom.



Do not install or store the equipment in an unsuitable place.
Install or store the equipment in such a place as specified in this User's Guide. Avoid the following, or there is a risk of a fire.

- a dusty place
- a humid place located near a boiler, etc
- a place exposed to direct sunlight
- an unstable place



Be careful not to hurt your fingers.
Exercise great care not to hurt your fingers on the rail when you mount/dismount the equipment into/from the rack.



Do not connect any interface cable with the power cord of the server plugged to a power source.
Make sure to power off the server and unplug the power cord from a power outlet before installing/removing any optional internal device or connecting/disconnecting any interface cable to/from the server. If the server is off-powered but its power cord is plugged to a power source, touching an internal device, cable, or connector may cause an electric shock or a fire resulted from a short circuit.

⚠ CAUTION

Do not use any non-designated interface cable.

Use only interface cables designated by NEC; identify which component or connector to attach beforehand. If you use a wrong cable or make a wrong connection, there is a risk of short-circuit that could lead to a fire.

You also have to observe the following prohibitions about handling and connecting interface cables:

- Do not use any damaged cable connector.
- Do not step on the cable.
- Do not place any object on the cable.
- Do not use the equipment with loose cable connections.



Do not use or store this product in corrosive environment.

Avoid the usage or storage of this product in an environment which may be exposed to corrosive gases, such as those including but not limited to : sulfur dioxide, hydrogen sulfide, nitrogen dioxide, chlorine, ammonia and/or ozone.

Avoid installing this product in a dusty environment or one that may be exposed to corrosive materials such as sodium chloride and/or sulfur.

Avoid installing this product in an environment which may have excessive metal flakes or conductive particles in the air.

Such environments may cause corrosion or short circuits within this product, resulting in not only damage to this product, but may even lead to be a fire hazard.

If there are any concerns regarding the environment at the planned site of installation or storage, please contact your sales agent

Cleaning and Handling of Internal Devices

WARNING



Do not disassemble, repair, or alter the server.



Unless described herein, never attempt to disassemble, repair, or alter the equipment. There is a risk of an electric shock or fire as well as malfunction.



Do not look into the CD-ROM drive



The CD-ROM drive uses a laser beam. Do not look or insert a mirror inside while the system is on. A laser beam is invisible; if your eyes get exposed to it, there is a risk of losing eyesight.



Do not detach a lithium battery yourself.

This equipment has a lithium battery. Do not detach it yourself. If the battery is exposed to fire or water, it could explode.

When the lithium battery is running down and the equipment doesn't work correctly, contact your sales agent instead of disassembling, replacing or recharging it yourself.



Disconnect the power plug before cleaning the server.

Make sure to power off the server and disconnect the power plug from a power outlet before cleaning or installing/removing internal optional devices. Touching any internal device of the server with its power cord connected to a power source may cause an electric shock even if the server is off-powered.

Disconnect the power plug from the outlet occasionally and clean the plug with a dry cloth. Heat will be generated if condensation is formed on a dusty plug, which may cause a fire.

CAUTION



High temperature

Immediately after powering off the system, system components such as hard disk may be very hot. Wait for the server to cool down completely before adding/removing components.



Make sure to complete installation.

Firmly install all power cords, interface cables and/or boards. An incompletely installed component may cause a contact failure, resulting in fire and/or smoke.

During Operation

⚠ CAUTION

Do not pull out a device during operation.

Do not pull out or remove a device while it works. There is a risk of malfunction and injuries.



Do not touch the equipment when it thunders.

Unplug the equipment when it threatens to thunder. If it starts to thunder before you unplug the equipment, do not touch the equipment and cables. There is a risk of a fire or electric shock.



Keep animals away.



Animal's waste or hair may get inside the equipment to cause a fire or electric shock.



Do not place any object on top of the server.

The object may fall off to cause injuries, damage to hardware and/or a fire.



Do not leave the CD tray ejected.

Dust may get in the equipment to cause malfunction. The ejected tray may also become a cause of injuries.



Do not use a cellular phone or pager around the equipment.

Turn off your cellular phone or pager when you use the equipment. Their radio waves may cause the equipment to malfunction.

Rack-mount Model

CAUTION



Do not install the equipment on a nonconforming rack.

Install the equipment on a 19-inch rack confirming to the EIA standard. Do not use the equipment without a rack or install it on a nonconforming rack. The equipment may not function properly, and there is a risk of damage to physical assets or injuries. For suitable racks, contact your sales agent.



Do not attempt to install the server yourself.

To avoid a risk of injuries, users should not attempt to install the equipment into a rack. Installation should be performed by trained maintenance personnel.

< For Maintenance Personnel Only >



Do not remove and carry the equipment with modules mounted.

When you remove this product from the rack and carry it, remove all modules that are mounted first.



Do not install the equipment in such a manner that its weight is imposed on a single place.

To distribute the weight, attach stabilizers or install two or more racks. It may fall down to cause injuries.



Do not assemble parts alone.

It takes at least two people to mount doors and trays to a rack. You may drop some parts to cause a breakage or injuries.



Do not pull a device out of the rack if it is unstable.

Before pulling out a device, make sure that the rack is fixed (by stabilizers or quake-resistant engineering).



Do not leave two or more devices pulled out from the rack.

If you pull out two or more devices the rack may fall down. You can only pull out one device at a time.



Do not install excessive wiring.



To prevent burns, fires, and damage to the equipment, make sure that the rated load of the power branch circuit is not exceeded. For more information on installation and wiring of power-related facilities, contact your electrician or local power company.



For Proper Operation

Observe the following instructions for successful operation of the server. Failure to observe them could lead to malfunction or breakdown.

- Perform installation in a place where the system can operate correctly. For details, see the separate volume "User's Guide (Setup)".
- Before turning off the power or ejecting a disk, make sure that the access LED is off.
- When you have just turned off the power, wait at least 30 seconds before turning it on again.
- Once you have turned on the server, do not turn it off until the "NEC" logo appears on the screen.
- Before you move the equipment, turn off the power and unplug the cord.
- This server shall not assure reproduction of copy-protect CDs using reproduction equipment if such disks do not comply with CD standards.
- Clean the equipment regularly. (For procedures, see Chapter 6.) Regular cleaning is effective in preventing various types of trouble.
- Lightning may cause voltage sag. As a preventive measure, it is recommended to use UPS (uninterruptible power supply).

This equipment does not support the connection through an UPS serial port (RS-232C) or the control using PowerChutePlus.

- Check and adjust the system clock before operation in the following conditions:
 - After transporting the equipment
 - After storing the equipment
 - After the equipment halt under the conditions which is out of the guaranteed environment conditions (Temperature: 10 to 35°C, Humidity: 20 to 80%).

Check the system clock once in a month. It is recommended to operate the system clock using a time server (NTP server) if it is installed on the system which requires high level of time accuracy. If the system clock goes out of alignment remarkably as time goes by, though the system clock adjustment is performed, contact your sales agent.

- When you store the equipment, keep it under storage environment conditions (Temperature: -10 to 55°C, Humidity: 20 to 80%, non-condensing).
- If NEC Express5800/ft series, the built-in optional devices, and the media set for the backup devices (tape cartridges) are moved from a cold place to a warm place in a short time, condensation will occur and cause malfunctions and breakdown when these are used in such state. In order to protect important stored data and assets, make sure to wait for a sufficient period of time to use the server or components in the operating environment.

Reference: Length of the time effective at avoiding condensation in winter (more than 10°C differences between room temperature and atmospheric temperature)

Disk devices: Approximately 2-3 hours

Tape media: Approximately 1 day

- Make sure that the optional devices are attachable and connectable to the equipment. There is a risk of malfunctions that could lead to a breakdown of the equipment even if you could attach and connect.

- Make sure that your options are compatible with the system. If you attach any incompatible option, there is a risk of malfunction that could lead to a breakdown.
- It is recommended to use NEC's genuine option products. Some competitors' products are compatible with this server. However, servicing for trouble or damage resulting from such a product will be charged even within the warranty period.

TRANSFER TO THIRD PARTY

When you transfer (or sell) the product or its included items, you must observe the following:

Server

Attach this User's Guide to the server you are transferring (or selling) to a third party.

IMPORTANT: Data remaining on hard disk:

When you transfer your server, you are responsible for erasing important data stored on its hard disk (e.g., customer information, accounting information); you must be careful to prevent such data from leaking out to outsiders.

Even if you execute a "format" command to erase data superficially, the data actually remains on the hard disk. If data is not erased completely, it could be restored by certain software and be used for unexpected purposes.

You are strongly recommended to buy a special type of software or service to avoid such trouble. For details, contact your sales agent.

NEC shall not be accountable for such data leakage caused by your failure to take necessary measures.

Included Software

When you transfer or sell the included software to a third party, you must meet the following conditions:

- Transfer all of the software included with the system. Do not retain any copies.
- Meet the conditions of transfer described in each software license agreement.
- Uninstall untransferable programs, if any, from the server before the transfer.

DISPOSAL OF EQUIPMENT AND CONSUMABLES

- When you dispose of the main unit, hard disk drive, floppy disks, CD-ROMs, optional boards, etc., you need to observe your local disposal rules. For details, ask your municipal office.

IMPORTANT: For disposal (or replacement) of batteries on the motherboard, consult with your sales agent.

If data remains on the hard disk, backup data cartridges, floppy disks, or other writable media (such as CD-R and CD-RW), it could be restored and reused by outsiders. The customer is responsible for wiping out such data before disposal. You need to exercise sufficient care to protect privacy and confidential information.

- Some of the system components have limited lifetime (e.g., cooling fans, built-in batteries, built-in CD-ROM drive, floppy disk drive, mouse). For stable operation, it is recommended to replace them regularly. For lifetime of individual components and replacing procedures, ask your sales agent.

⚠ WARNING



Do not detach a lithium battery yourself.

This equipment has a lithium battery. Do not detach it yourself. If the battery is exposed to fire or water, it could explode.
RISK OF EXPLOSION IF BATTERY IS REPLACED WITH INCORRECT TYPE.
DISPOSE OF USED BATTERIES ACCORDING TO THE INSTRUCTIONS.

When the lithium battery is running down and the equipment doesn't work correctly, contact your sales agent instead of disassembling, replacing or recharging it yourself.

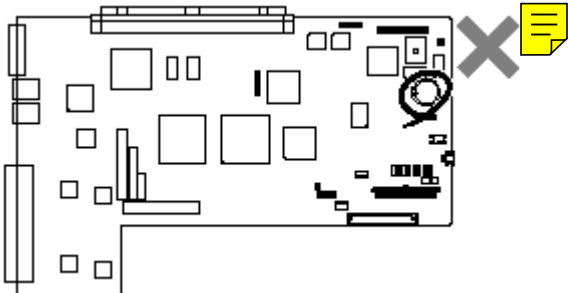

PCI module board

IF SYSTEM TROUBLE IS SUSPECTED

Before sending the equipment for repair, try the following:

1. Check if its power cord and connection cables are attached correctly.
2. See “Error Messages” in Chapter 7 to check if there is a relevant symptom. If yes, take measures as instructed.
3. Certain software programs are required for operation of NEC Express5800/ft series. Check if these programs are properly installed.
4. Use a commercially available anti-virus program to check the server.

If the problem isn't solved by the above actions, stop using the server and consult with your sales agent. In this case, check LED indications of the server and alarm indications on the display, which will serve as helpful information at the time of repair.

ABOUT REPAIR PARTS

The minimum duration of holding repair parts of this equipment may be different for each country, so contact the NEC sales representatives.

If the period is not specified, the repair parts are kept for 5 years after discontinuance of the product.

Advice for Your Health

Prolonged use of a computer may affect your health. Keep in mind the following to reduce stresses on your body:

Sit in a good posture

Sit on your chair with your back straight. If the desk height is appropriate, you will slightly look down at the screen and your forearms will be parallel to the floor. This “good” work posture can minimize muscle tension caused by sedentary work.

If you sit in a “bad” posture—for example, sit round-shouldered or with your face too close to the display—you may easily suffer fatigue or have your eyesight affected.



Adjust the installation angle of Display

Most types of displays allow you to adjust the angle vertically and horizontally. This adjustment is very important to prevent the reflection of light as well as to make the screen more comfortable to see. Without this adjustment, it is difficult to maintain a “good” work posture and may get tired soon. Be sure to adjust the angle before using the display.



Adjust Brightness and Contrast

Displays allow you to adjust brightness and contrast. Optimum brightness and contrast vary depending on the individual, age, brightness of the room, etc; you need to make an adjustment accordingly. If the screen is too bright or too dark, it is bad for your eyes.

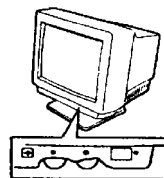

Adjust the installation angle of Keyboard

Some types of keyboards allow you to adjust the angle. If you adjust the angle to make the keyboard more comfortable to use, you can greatly reduce stresses on your shoulders, arms, and fingers.

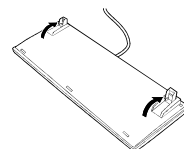

Clean the Equipment

Cleanliness of the equipment is very important not only for reasons of appearance but also from the viewpoints of function and safety. Especially, you need to regularly clean the display, which gets unclear due to the accumulation of dirt.

Take a break when you get tired

If you feel tired, you are recommended to refresh yourself by taking a short break or doing a light exercise.



Chapter 2

General Description

This chapter describes what you need to know to use the NEC Express5800/ft series. Refer to this chapter when you want to know about certain components and how to operate them.

STANDARD FEATURES

High performance

- Intel® Xeon™ Processor (2.4 GHz)
- High-speed Ethernet interface (1000Mbps/100Mbps/10Mbps supported)
- High-speed disk access (Ultra160 SCSI Wide)

Expandability

- Wide variety of optional I/O slots
Four 64-bit/33 MHz, two 32-bit/33 MHz PCI slots
- Large memory of up to 6 GB
- USB interface

High-reliability

- Memory monitoring feature (1-bit error correction/ 2-bit error detection)
- Bus parity error detection
- Temperature monitoring
- Error notification
- Built-in fan monitoring feature
- Internal voltage monitoring feature
- BIOS password feature
- Security feature (security lock for front bezel)

Management Utilities

- NEC ESMPRO
- NEC Management Workstation Application (NEC MWA)

Ready-to-use

- Preinstalled Kernel 2.4-based Linux OS
- Quick cableless connection: hard disk, CPU module, and PCI module (hot-swap supported)

Fault-tolerant Feature

- Redundant modules achieved within a system
- Higher hardware availability by isolation of failed module

Various Features

- Graphic accelerator "CT69000" supported
- El Torito Bootable CD-ROM (no emulation mode) format supported
- POWER switch mask
- AC-LINK feature
- Consoleless feature

Self-diagnosis

- Power On Self-Test (POST)
- Test and Diagnosis (T&D) Utility

Maintainability

- Off-line Maintenance Utility

Easy and Fine Setup

- NEC EXPRESSBUILDER (system setup utility)
- SETUP (BIOS setup utility)
- *Fast*UTIL (SCSI device utility)

The NEC Express5800/ft series achieves fault-tolerant high-availability in a space-saving form factor by incorporating redundant hardware module pairs in a single chassis. These modules work in synchronous tight lockstep while constantly making comparisons with each other and detecting anomalous diversions in operation.

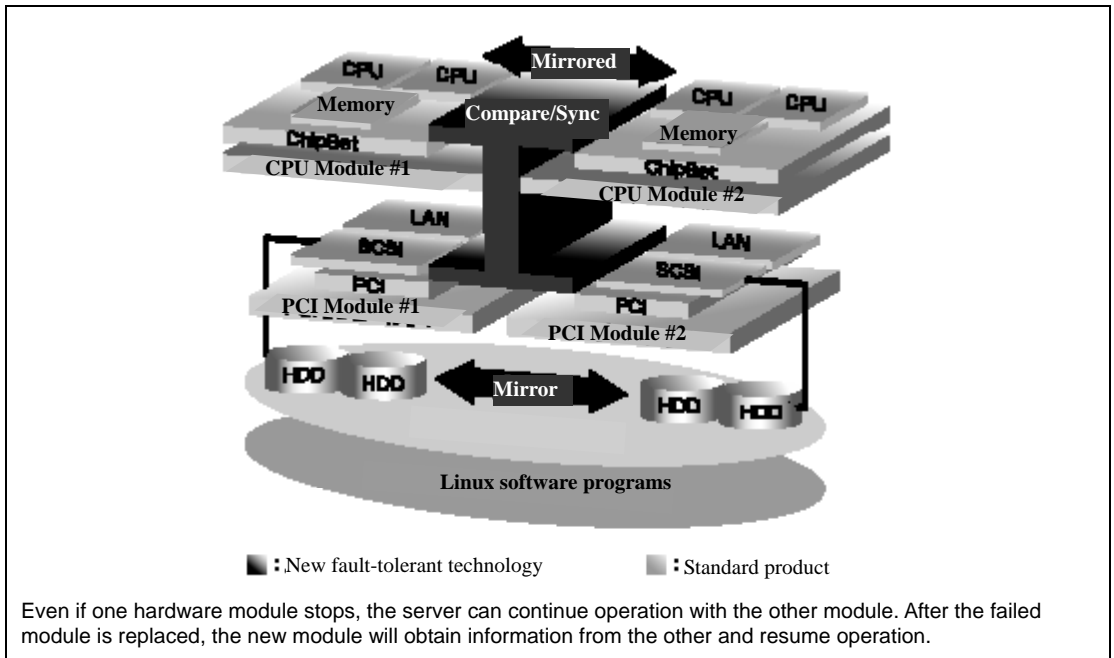

NEC Express5800/ft series is a highly fault-tolerant server that achieves continuous computing operations, data storage mirror, and continuous network connection. It allows you to run Linux-based applications.

NEC Express5800/ft series achieves continuous computing operations for the Linux operating system and server-based applications with its redundant CPU processing and redundant memory. It assures data redundancy through duplication of server data on an independent storage system. These features eliminate server downtime that is usually caused by network disconnection or trouble with the I/O controller, Ethernet adapter or disk drive, and support operation of the network and server applications continuously. While being transparent to application software, NEC Express5800/ft series achieves high fault-tolerance.

NEC Express5800/ft series detects status changes, errors and other events and notifies the user of these events. If you use an alarm notification tool, you can configure NEC Express5800/ft series to notify you when certain events occur.

NEC ESMPRO is installed on the system as a server management solution. NEC ESMPRO, a GUI-based management tool, allows you to monitor, view, and configure NEC Express5800/ft series. This tool also supports both local and remote management of NEC Express5800/ft series.

NEC Express5800/ft series mainly provides the following advantages:

- **Highly fault-tolerant processing and I/O subsystems**

NEC Express5800/ft series use redundant hardware and software to assure server operation even if one module suffers trouble with its processor, memory, I/O (including trouble related to the I/O controller), disk drive, or Ethernet adapter.
- **Continuous network connection**

NEC Express5800/ft series maintains continuous network connection by detecting any trouble with the network adapter, connection, etc. If trouble occurs, the standby network connection will take over all network traffic processing and thus securely maintain the network system connection of NEC Express5800/ft series without losing network traffic or client connection.
- **Support of multiple network connections**

Since NEC Express5800/ft series can support multiple Ethernet connections, you can add network redundant control or network traffic control.
- **Industry standard hardware platform**

NEC Express5800/ft series uses IA (Intel Architecture)-based system hardware.
- **No need to modify applications**

You can run Linux-compliant applications on NEC Express5800/ft series. Thus, unlike other highly fault-tolerant products, special API or scripts are not necessary.
- **Automatic mirroring**

NEC Express5800/ft series automatically maintains data as the current data.
- **Automatic detection and notification of faults**

NEC Express5800/ft series detects and sorts out all events such as general status changes and faults, and notifies Syslog of these events.
- **Transparent migration**

NEC Express5800/ft series constantly monitors events. If trouble occurs on NEC Express5800/ft series' server module, it will transparently use a redundant module of the failed module. This feature maintains data and user access without losing application service.
- **Automatic reconfiguration**

When the failed module restarts after the trouble is corrected, NEC Express5800/ft series will perform reconfiguration automatically, and if necessary, resynchronize the affected modules. Reconfiguration can include CPU processing (e.g., CPU memory), server's operating system (and related applications), and system data stored on the hard disks. In most cases, NEC Express5800/ft series automatically restores redundancy of the server modules after recovery.

- Local and remote management

NEC Express5800/ft series uses NEC ESMPRO as a server management tool. This tool uses a GUI that enables monitoring and setting of NEC Express5800/ft series. NEC ESMPRO can be used both locally and remotely on work station PCs or server PCs.

- syslog function

When troubles etc., are detected on NEC Express5800/ft series, they will be recorded in syslog.

- In-service repairing

You can repair or replace a failed module even if NEC Express5800/ft series is operating.

NAMES AND FUNCTIONS OF COMPONENTS

Names and functions of components are shown below:

Front View

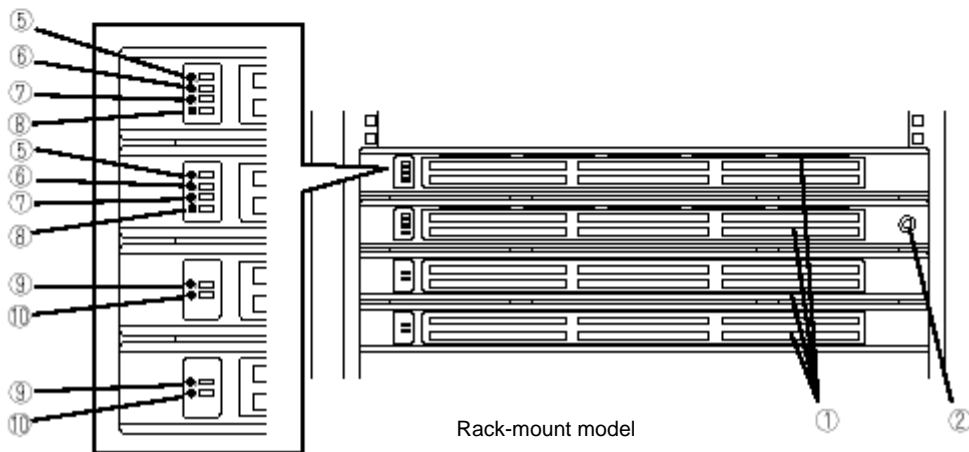
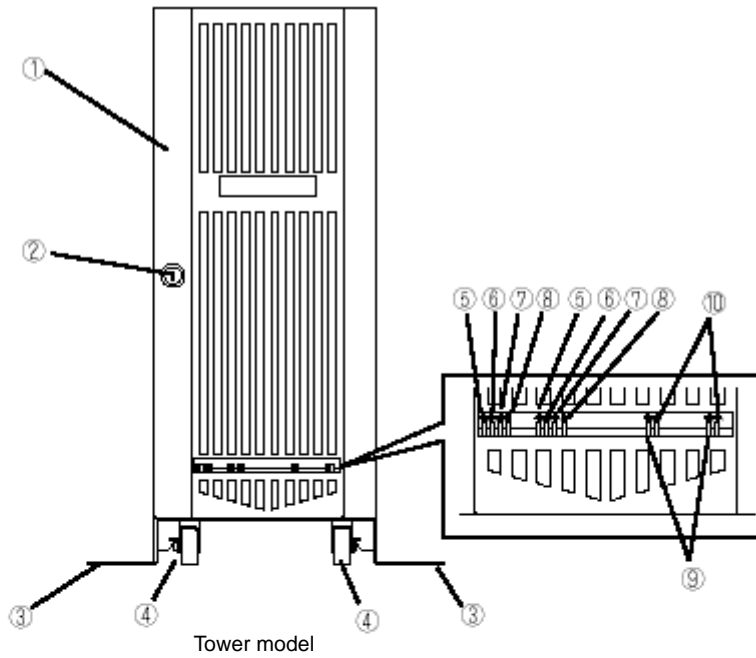

- 1 Front bezel**
A door that covers internal components. You can lock it with the included security key.
- 2 Key slot**
Insert the security key in this slot to unlock the front bezel.
- 3 Stabilizers**
Parts for stabilizing a tower-model unit.
- 4 Casters**
Wheels for moving a tower-model unit.
- 5 BMC status LED**
See “LEDs” in this chapter for details.
- 6 PCI module status LED 1**
See “LEDs” in this chapter for details.
- 7 PCI module status LED 2**
See “LEDs” in this chapter for details.
- 8 DISK ACCESS LED**
See “LEDs” in this chapter for details.
- 9 CPU module status LED 1**
See “LEDs” in this chapter for details.
- 10 CPU module status LED 2**
See “LEDs” in this chapter for details.

Front View (inside)

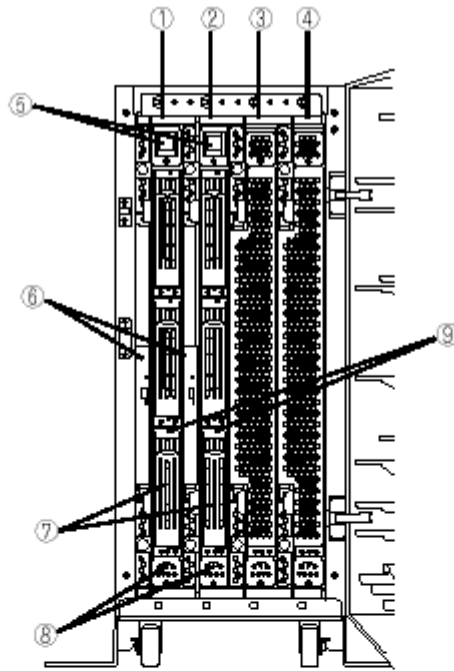

Tower model

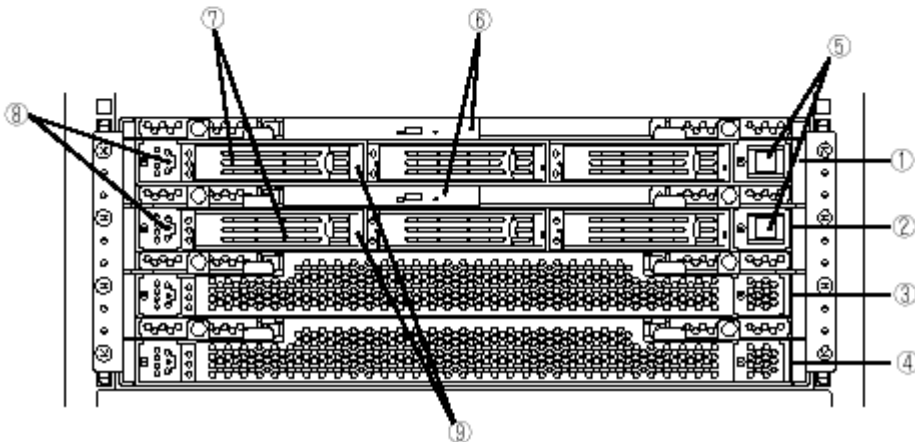

Rack-mount model

- 1 **PCI module (for group 1)**
A module that includes a PCI board and LAN controller.
- 2 **PCI module (for group 2)**
A module that includes a PCI board and LAN controller.
- 3 **CPU module (for group 1)**
A module that includes a CPU (processor) and memory (DIMM).
- 4 **CPU module (for group 2)**
A module that includes a CPU (processor) and memory (DIMM).
- 5 **POWER switch**
A switch for turning on/off power to the system. The POWER switch on the primary PCI module will be lit. Press it once to turn on power. Press it again to turn off power. Depress the switch for more than four seconds to force the system to power down. The POWER switch on the secondary PCI module will be unlit and will not respond until a failure in the primary PCI module causes the secondary PCI module to assume primary functionality.
- 6 **CD-ROM drive**
Used for reading data from CD-ROMs.
Although there are two CD-ROM drives, only the one on the active primary PCI module can be used (the module with the lit POWER Switch LED).
- 7 **3.5-inch hard disk drive bay**
Slots for adding hard disks. On a tower model, they are called Slots 1, 2, and 3 from the bottom. On a rack-mount model, they are called Slots 1, 2, and 3 from the left. Slots of the same number are mirrored between the groups 1 and 2.
- 8 **DUMP switch**
A switch for outputting a memory image from the kernel to a file.
- 9 **DISK LED (green/amber)**
An LED on the hard disk. Blinks in green while the hard disk is accessed and turns amber when operating in simplex mode. If one of the mirrored hard disks fails, the failed disk's LED turns green and the other disk's LED turns amber.

CD- ROM Drive

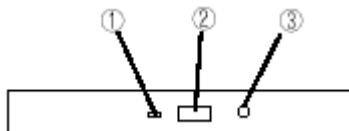

- 1 **Status LED**
An LED that stays on while the loaded CD-ROM is accessed.
- 2 **CD tray eject button**
A button for ejecting the CD tray.
- 3 **Manual release hole**
When the eject button does not work, insert a metal pin into this hole to forcefully eject the CD tray.

Rear View

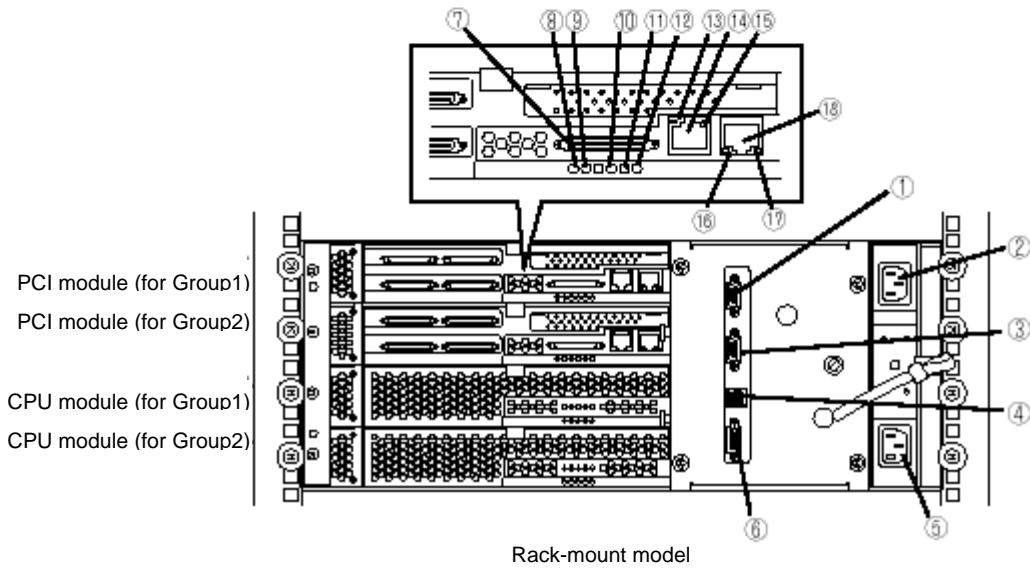
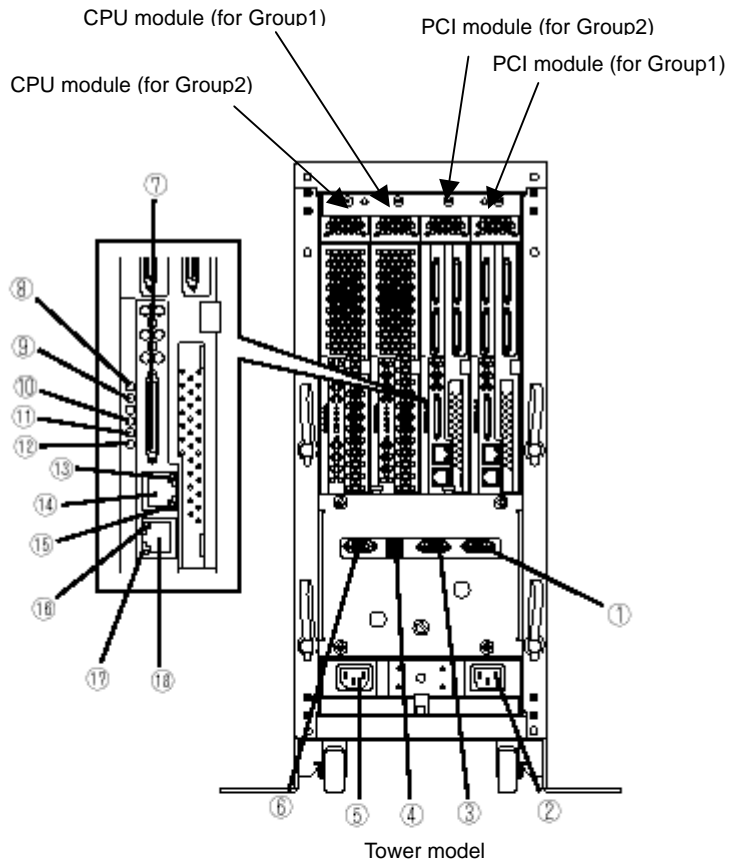

- 1 Serial port A connector**
Connected to a device that has a serial interface. For maintenance use only.
- 2 AC inlet B (for Group1)**
PC socket for plugging a power cord (for Group1). If you desire to make the PCI module for Group1 primary, use this inlet to connect the power cord first.
- 3 Serial port B connector**
Connected to a device that has a serial interface. For maintenance use only.
- 4 USB connectors**
Tower model: from top: USB1, USB2
Rack-mount model: from left: USB1, USB2
Connected to devices that support the USB interface.
Connect the keyboard (with mouse) to USB 1; connect the USB floppy disk drive to USB 2.
- 5 AC inlet A (for Group2)**
PC socket for plugging a power cord (for Group2). If you desire to make the PCI module for Group2 primary, use this inlet to connect the power cord first.
- 6 Monitor connector**
Connected to the display unit.
- 7 SCSI connector**
Used for connecting external SCSI devices.
- 8 PCI module status LED 1**
See "LEDs" in this chapter for details.
- 9 PCI module status LED 2**
See "LEDs" in this chapter for details.
- 10 PCI board slot status LED (Slot1)**
See "LEDs" in this chapter for details.
- 11 PCI board slot status LED (Slot2)**
See "LEDs" in this chapter for details.
- 12 PCI board slot status LED (Slot3)**
See "LEDs" in this chapter for details.
- 13 LINK/ACT LED**
See "LEDs" in this chapter for details.
- 14 LAN connector 1**
A connector for 1000BASE-T, 100BASE-TX, and 10BASE-T. Connected to the network system on LAN.
- 15 1000/100/10 LED**
See "LEDs" in this chapter for details.
- 16 LINK/ACT LED**
See "LEDs" in this chapter for details.
- 17 100/10 LED**
See "LEDs" in this chapter for details.
- 18 LAN connector 2**
A connector for 100BASE-TX and 10BASE-T. Connected to the network system on LAN.

CPU Module

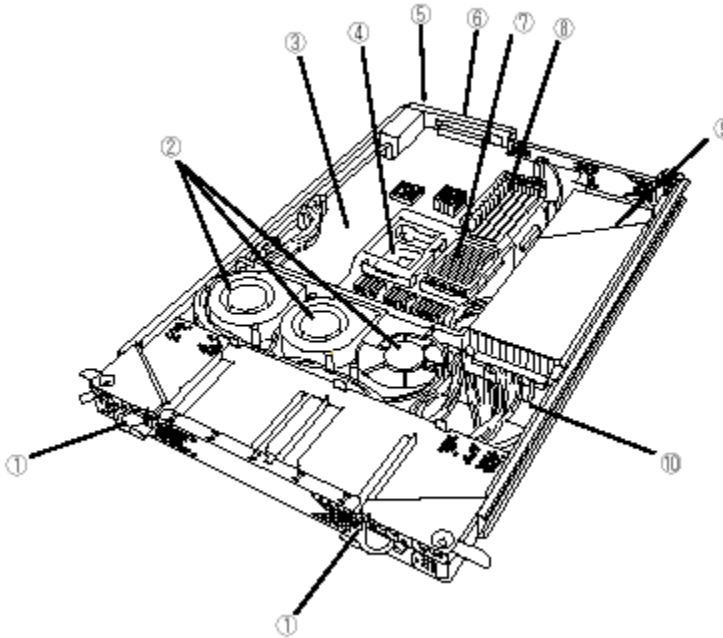

Group 1 and group 2 have the same configuration.

- 1 Module handle
- 2 Cooling fan
- 3 CPU module board
- 4 CPU socket #2 (additional)
- 5 AC inlet (in the back)
- 6 Backpanel connector (in the back)
- 7 CPU socket #1 (standard)
- 8 DIMM
- 9 Power unit
- 10 Power backboard

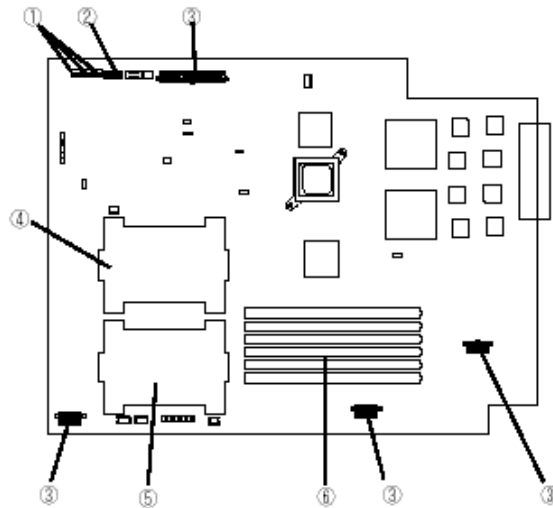

CPU module board

Group 1 and group 2 have the same configuration.

- 1 Cooling fan connector
- 2 LED connector
- 3 Power connector
- 4 CPU socket #2
- 5 CPU socket #1
- 6 DIMM sockets (Slots #1 to #6 from left. Add memory modules in pairs: #1 and #2, #3 and #4, #5 and #6.)

*This section only describes connectors that are used for replacing parts or upgrading. Other connectors have been setup before shipment.

PCI Module

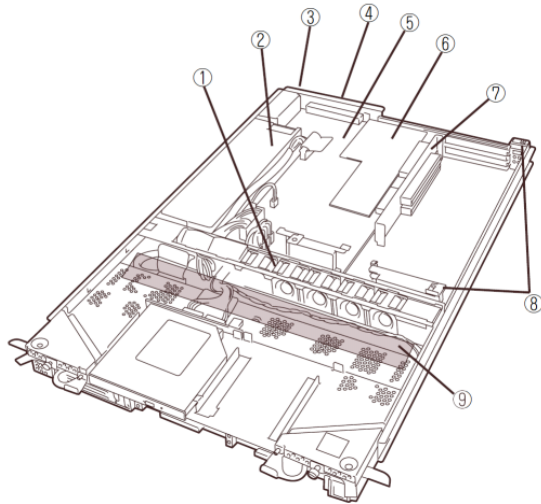

Group 1 and group 2 have the same configuration.

- 1 Cooling fan
- 2 Power unit
- 3 AC inlet (in the back)
The AC cable in the module which is connected to the AC inlet cannot be used for other purposes.
- 4 Backpanel connector (in the back)
- 5 PCI module board
- 6 Video board
- 7 PCI riser card
- 8 PCI board retention bracket
- 9 SCSI backboard

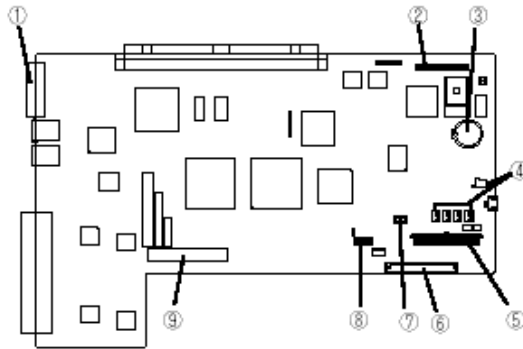

PCI module board
Group 1 and group 2 have the same configuration.

- 1 SCSI connector (external)
- 2 Configuration jumper pin
- 3 Battery (lithium battery)
- 4 Cooling fan connector
- 5 Power connector
- 6 IDE connector
- 7 Power switch connector
- 8 LED connector
- 9 SCSI connector (internal)

Chassis Board Layout

Rack-mount model

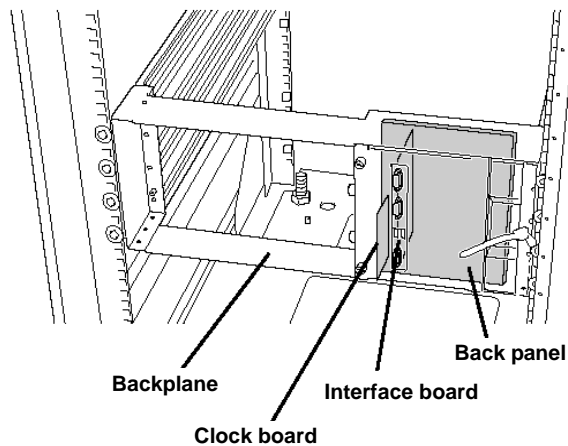

LEDs

This section describes indications and meanings of the LEDs on NEC Express5800/ft series.

Refer to pages 2-6 through 2-11 for the locations of each LED.

POWER LED

The POWER switch of the PCI module also functions as a POWER LED. When power is supplied to the modules, POWER LED on the primary side will illuminate (the switch also works on the primary side alone).

BMC Status LED

The BMC Status LED indicates the status of the Baseboard Management Controller (BMC) installed on NEC Express5800/ft series.

The LED stays green while the server is running normally. If the LED is not green, there is something wrong with the server.

The table below shows indications of the BMC Status LED and their meanings.

TIPS:

- If the server has the NEC ESMPRO or Off-line Maintenance Utility installed, you can view the error log to identify the cause of a trouble.
 - When you want to restart the server, perform a shutdown if the OS allows you to shut down the system. If not, perform a reset or forced shutdown, or you can restart the server by unplug and plugging the power cord.
-

LED indications		Description	Action
Primary	Secondary		
Green	Off	BMC operates normally and CPU and PCI modules are in duplex mode.	—
Green (blinking every 1 second)	Off	CPU or PCI modules are not in duplex mode during operation.	Remount components whose Status LED is red. If the problem persists, replace that module.
Off	Off	AC power is all off.	Turn on the AC power.
		Performing POST.	Wait for a while; it will illuminate in green shortly after POST.
		CPU module error occurred.	After turning off the power, turn it on to restart the system. If some error message appears on the POST screen, write it down and contact your sales agent.
PCI module error occurred.			

LED indications		Description	Action
Primary	Secondary		
Amber	Off	Detected a fatal temperature error.	If LCD displays some error message, refer to the error message list (see Chapter 7). Check if dust is accumulated on internal fans and confirm that the fan cables are connected firmly. If the message does not disappear, contact your sales agent.
		Detected a fatal voltage error.	Contact your sales agent.
Amber (blinking every 1 second)	Off	Detected a temperature error to be warned.	If LCD displays some error message, refer to the error message list (see Chapter 7). Check if dust is accumulated on internal fans and confirm that the fan cables are connected firmly. If the message does not disappear, contact your sales agent.
		Detected a voltage error to be warned.	Contact your sales agent.
		Detected a device defect.	
		Detected a fan alarm.	If LCD displays some error message, refer to the error message list (see Chapter 7). Check if dust is accumulated on internal fans, and confirm that the fan cables are connected firmly. If the message does not disappear, contact your sales agent.
Red	Off	BMC is being dumped.	Wait for a while; it will go off soon.
		PCI module may be connected incorrectly.	Check if PCI module is connected correctly. Look for loose screws.
		BMC may be out of order.	BMC firmware may need reprogramming. Contact your sales agent.
ANY* ¹	Red	BMC is being dumped.	Wait for a while. After a while, the BMC status LED on the secondary will blink.
		PCI module may be connected incorrectly.	Check if PCI module is connected correctly. Look for loose screws.
		BMC may be out of order.	BMC firmware may need to be rewritten. Contact your sales agent.
ANY* ¹	Red (blinking every 0.5 second)	Transfers data being synchronized after a PCI module is replaced (this is not an error).	Do not remove either of the PCI modules or control the AC/DC power until the LED stops blinking.
ANY* ¹	Red (blinking every 1 second)	The revision of BMC firmware does not match.	Contact your sales agent.

LED indications		Description	Action
Primary	Secondary		
Red	Red	BMC is being dumped.	Wait for a while. After a while, the BMC status LED on the primary will go off.
		Both BMCs are out of order.	Check if both PCI modules are connected correctly. Confirm that screws are fixed firmly. If the indication does not change, contact your sales agent.

*1 The status of green, green (blinking every second), amber, amber (blinking every second), or off.

PCI Module Status LEDs 1/2 (↔1/↔2)

Disk Access LED

The PCI module has three LEDs.

Combined, the three LEDs show the status of the PCI modules and hard disks.

See “NAMES AND FUNCTIONS OF COMPONENTS” (page 2-6) for the locations of LEDs.

(1) Status LED 1 of both PCI modules are off

PCI#1		PCI#2		Description	Action
Status LED 2	DISK Access LED	Status LED 2	DISK Access LED		
Green	Green/ Off *	Green	Green/ Off *	Both PCI modules operate normally in duplex mode.	-
Green	Off	Amber	Amber	Some trouble occurred on a hard disk of the PCI module 1.	Reconfigure RAID of the hard disks (See Chapter 3, Linux Setup and Operation). Remount the hard disk.
Amber	Amber	Green	Off	Some trouble occurred on a hard disk of the PCI module 2.	If the problem persists, contact your sales agent.
Off	Off	Amber	Amber	AC power is not supplied to the PCI module 1. The PCI module 2 operates in simplex mode.	Check if the power cord is connected correctly. Check the condition of breaker and UPS. Check if the power unit of the PCI module 1 is connected correctly. Remount the PCI module 1. If the problem persists, contact your sales agent.
Amber	Amber	Off	Off	AC power is not supplied to the PCI module 2. The PCI module 1 operates in simplex mode.	Check if the power cord is connected correctly. Check the condition of breaker and UPS. Check if the power unit of the PCI module 2 is connected correctly. Remount the PCI module 2. If the problem persists, contact your sales agent.

PCI#1		PCI#2		Description	Action
Status LED 2	DISK Access LED	Status LED 2	DISK Access LED		
Green	Green/Off *	Amber	Green/Off *	i) There is an error in the option PCI board or the PCI module board connected or mounted on PCI module 1. ii) There is an error in the devices connected to the option PCI board connected or mounted on PCI module 1. (including the cable disconnection) iii) The LAN cable connected or mounted on PCI module 1 is disconnected.	Make sure that the option PCI board is properly mounted and cables are properly connected to the connectors of the PCI module or the option PCI board. Remount the PCI module 1. If the problem persists, contact your sales agent.
Amber	Green/Off *	Green	Green/Off *	i) There is an error in the option PCI board or the PCI module board connected or mounted on PCI module 2. ii) There is an error in the devices connected to the option PCI board connected or mounted on PCI module 2 (including the cable disconnection) iii) The LAN cable connected or mounted on PCI module 2 is disconnected.	Make sure that the option PCI board is properly mounted and cables are properly connected to the connectors of the PCI module or the option PCI board. Remount the PCI module 2. If the problem persists, contact your sales agent.
Amber	Amber	Green	Green/Off*	DISK is performing mirroring.	Wait for the mirroring to be completed.
Green	Green/Off*	Amber	Amber		

* DISK ACCESS LED illuminates green when hard disk is accessed.

Tips: When the Status LED 1 is off, the colors of the Status LED 2 indicate the following.

You must be careful especially when detaching modules.

- Green: Unmounting the module has no effect on the system operation.
- Amber: Unmounting the module causes a system down.

(2) Status LED 1 of both PCI modules are red

PCI#1		PCI#2		Description	Action
Status LED 2	DISK Access LED	Status LED 2	DISK Access LED		
Off	Off	Off	Off	On standby (AC power is supplied through the cord, but the system has not been powered on yet.)	After turning on the power, wait for the OS to start. When the OS starts and duplex mode is established, the indications will return to normal. If they do not get back to normal, remount the PCI module. If the problem persists, contact your sales agent.
Green	Off	Off	Off	The PCI module 1 is performing diagnosis (Diag).	Wait for the OS to start. When the OS starts and duplex mode is established, the indications will return to normal.
Off	Off	Green	Off	The PCI module 2 is performing diagnosis (Diag).	Wait for the OS to start. When the OS starts and duplex mode is established, the indications will return to normal.

(3) Status LED 1 of only PCI module 1 is red

PCI#1		PCI#2		Description	Action
Status LED 2	DISK Access LED	Status LED 2	DISK Access LED		
Off	Off	Amber	Amber	The PCI module 1 is on standby (The PCI module 1 has not been powered on yet.) The PCI module 2 operates in simplex mode.	Start the PCI module 1 from ft server utility (See Chapter 5). Remount the PCI module 1. If the problem persists, contact your sales agent.
Green	Off	Amber	Amber	The PCI module 1 is performing diagnosis (Diag). The PCI module 2 operates in simplex mode.	Wait for the PCI module 1 to start. When the PCI module 1 starts and duplex mode is established, the indications will return to normal.
Off	Off	Off	Off	Only the PCI module 1 is on standby (AC power is supplied through the cord, but the system has not been powered on yet.) AC power is not supplied to the PCI module 2.	Check if the power cord is connected correctly. Check the condition of breaker and UPS. Check if the power unit is connected correctly. Remount the PCI module 2. If the problem persists, contact your sales agent.

PCI#1		PCI#2		Description	Action
Status LED 2	DISK Access LED	Status LED 2	DISK Access LED		
Green	Off	Off	Off	The PCI module 1 is performing diagnosis (Diag). AC power is not supplied to the PCI module 2.	Wait for the OS to start. After the OS starts, check the Status LEDs and then take the appropriate actions. If the problem persists, contact your sales agent.

(4) Status LED 1 of only PCI module 2 is red

PCI#1		PCI#2		Description	Action
Status LED 2	DISK Access LED	Status LED 2	DISK Access LED		
Amber	Amber	Off	Off	The PCI module 2 is on standby (The PCI module 2 has not been powered on yet.) The PCI module 1 operates in simplex mode.	Start the PCI module 2 from ft server utility (See Chapter 5). Remount the PCI module 2. If the problem persists, contact your sales agent.
Amber	Amber	Green	Off	The PCI module 2 is performing diagnosis (Diag). The PCI module 1 operates in simplex mode.	Wait for the PCI module 2 to start. When the PCI module 2 starts and duplex mode is established, the indications will return to normal.
Off	Off	Off	Off	Only the PCI module 2 is on standby (AC power is supplied through the cord, but the system has not been powered on yet.) AC power is not supplied to the PCI module 1.	Check if the power cord is connected correctly. Check the condition of breaker and UPS. Check if the power unit is connected correctly. Remount the PCI module 1. If the problem persists, contact your sales agent.
Off	Off	Green	Off	The PCI module 2 is performing diagnosis (Diag). AC power is not supplied to the PCI module 1.	Wait for the OS to start. After the OS starts, check the Status LEDs and then take the appropriate actions. If the problem persists, contact your sales agent.

CPU Module Status LEDs 1/2

The CPU module has two LEDs.

Combined, the two LEDs show the status of CPU modules:

See “NAMES AND FUNCTIONS OF COMPONENTS” (page 2-6) for the locations of LEDs.

CPU#1		CPU#2		Description	Action
Status LED1	Status LED2	Status LED1	Status LED2		
Off	Green	Off	Green	The CPU module operates normally in duplex mode.	-
Off	Amber	Red	Off	The CPU module 2 is on standby (The CPU module 2 has not been powered on yet.) The CPU module 1 operates in simplex mode.	Start the CPU module 2 from ft server utility (See Chapter 5). Remount the CPU module 2. If the problem persists, contact your sales agent.
Red	Off	Off	Amber	The CPU module 1 is on standby (The CPU module 1 has not been powered on yet.) The CPU module 2 operates in simplex mode.	Start the CPU module 1 from ft server utility (See Chapter 5). Remount the CPU module 1. If the problem persists, contact your sales agent.
Off	Amber	Red	Green	The CPU module 2 is performing diagnosis (Diag). The CPU module 1 operates in simplex mode.	Wait for the CPU module 2 to start. When the CPU module 2 starts and duplex mode is established, the indications will return to normal.
Red	Green	Off	Amber	The CPU module 1 is performing diagnosis (Diag). The CPU module 2 operates in simplex mode.	Wait for the CPU module 1 to start. When the CPU module 1 starts and duplex mode is established, the indications will return to normal.
Off	Off	Off	Amber	AC power is not supplied to the CPU module 1. The CPU module 2 operates in simplex mode.	Check if the power cord is connected correctly. Check the condition of breaker and UPS. Check if the power unit is connected correctly. Remount the CPU module 1. If the problem persists, contact your sales agent.

CPU#1		CPU#2		Description	Action
Status LED1	Status LED2	Status LED1	Status LED2		
Off	Amber	Off	Off	AC power is not supplied to the CPU module 2. The CPU module 1 operates in simplex mode.	Check if the power cord is connected correctly. Check the condition of breaker and UPS. Check if the power unit is connected correctly. Remount the CPU module 2. If the problem persists, contact your sales agent.
Off	Off	Red	Green	AC power is not supplied to the CPU module 1. The CPU module 2 is performing diagnosis (Diag).	Wait for the OS to start. After the OS starts, check the Status LEDs and then take the appropriate actions. If the problem persists, contact your sales agent.
Red	Green	Off	Off	AC power is not supplied to the CPU module 2. The CPU module 1 is performing diagnosis (Diag).	
Red	Off	Red	Off	On standby (AC power is supplied through the cord, but the system has not been powered on yet.)	After turning on the power, wait for the OS to start. When the OS starts and duplex mode is established, the indications will return to normal. If not, check the Status LEDs and then take the appropriate actions. If the problem persists, contact your sales agent.
Red	Green	Red	Off	The CPU module 1 is performing diagnosis (Diag).	
Red	Off	Red	Green	The CPU module 2 is performing diagnosis (Diag).	
Red	Amber	Off	Amber	The CPU module 1 memory is being dumped. (This occurs only when maintenance is being performed.)	-
Red	Amber	Off	Off		
Off	Amber	Red	Amber	The CPU module 2 memory is being dumped. (This occurs only when maintenance is being performed.)	-
Off	Off	Red	Amber		

Tips: When the Status LED 1 is off, the colors of the Status LED 2 indicate the following.

You must be careful especially when detaching modules.

- Green: Unmounting the module has no effect on the system operation.
- Amber: Unmounting the module cause a system down.

PCI Board Slot Status LEDs (P1, P2, P3)

To show the status of PCI board slots, each PCI module has three status LEDs.

LED indications	Description	Action
Off	PCI board is mounted correctly and operates in duplex mode.	The system operates normally.
	The PCI board is not mounted; is mounted incorrectly; or power is not supplied.	If the PCI board is not mounted or is mounted incorrectly, just mount it correctly; there is no problem. Check the condition of power unit. If the problem persists, contact your sales agent.
Amber	The PCI board is mounted correctly and operates in simplex mode.	Simplex mode is not a problem. To make the server fault-tolerant, attach a PCI board to a slot of the same on the other PCI module.
Red	Although the PCI board is mounted, it may be offline or not be working.	Remount the PCI board correctly. Remount the PCI module correctly. If the problem persists, contact your sales agent.

For LED indications when option boards are attached, see “PCI Module” in Chapter 8.

DISK LED

A DISK LED shows the status of the hard disk mounted in a slot of the 3.5-inch hard disk drive bay.

Combined, the two DISK LEDs on PCI modules 1 and 2 show the status of the hard disks.

PCI module 1	PCI module 2	Description	Action
Green/ Off*	Green/ Off*	Hard disks are now in RAID configuration and running normally.	—
Green/ Off*	Amber	Hard disks are being configured to establish RAID.	Wait until RAID configuration is established.
Green	Amber	A trouble occurred on the hard disk of the PCI module 1. The hard disk on the PCI module 2 is operating in non-RAID status.	Check RAID status of hard disks. If the problem persists, contact your sales agent.
Amber	Green/ Off*	Hard disks are being configured to establish RAID.	Wait until RAID configuration is established.
Amber	Green	A trouble occurred on the hard disk of the PCI module 2. The hard disk on the PCI module 1 is operating in non- RAID status.	Check RAID status of hard disks. If the problem persists, contact your sales agent.

*A DISK LED goes off (blinks) when a hard disk is accessed.

TIPS:

- When there are many accesses, the access LED will blink frequently. Check if the LED blinks in green when the number of accesses decreases, or if it is green when there are no accesses anymore.
 - When you power on NEC Express5800/ft series and the access LEDs do not illuminate green, remount the hard disks.
-

LAN Connector LEDs

Two LAN ports (connectors) located in the back have two LEDs each.

- 100/10 LED (LAN connector 2), 1000/100/10 LED (LAN connector 1)

These LEDs show the transfer rate of the network that is being connected.

LED indications	LAN connector 1 1000/100/10	LAN connector 2 100/10
Amber	Operating as 1000BASE-T.	Operating as 100BASE-TX.
Off	Operating as 100BASE-TX or 10BASE-T.	Operating as 10BASE-T.

- LINK/ACT LED

The LINK/ACT LED shows the status of a standard network port. It is green if power is supplied to the main unit and hub, and they are connected correctly (“LINK”). It blinks green while the network port sends or receives data (ACT).

When the LED does not illuminate during “LINK,” check the condition and connection of network cables. If there is nothing wrong with the cables, a defect is suspected in the network (LAN) controller. In this case, contact your sales agent.

BASIC OPERATION

This section describes basic operation procedures of NEC Express5800/ft series.

Locking and Unlocking the Front Bezel

The front bezel covers built-in components of the server such as the POWER switch, CD-ROM drive, and hard disks.

The tower model server has a door-type bezel (it can also be detached). The rack-mount model server has a cover-like detachable bezel.

You need to open the front bezel when you access the POWER switch, CD-ROM drive or hard disk.

IMPORTANT:

- Without using the security key, you cannot open or detach the front bezel.
 - It is not recommended to use the server with its bezel detached.
-

Tower Model

Insert the security key into the slot and turn it to release the lock. Hold the handle on the left side of the bezel and pull it. After closing the front bezel, lock it with the key for security.

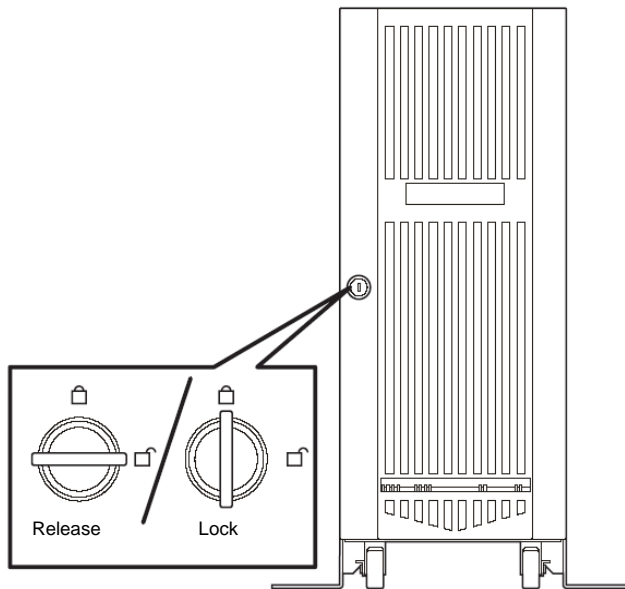

Rack-mount Model

The rack-mount model server is equipped with a detachable front bezel.

Detach

Follow the steps below to detach the front bezel:

1. Insert the security key into the slot and turn it with a little pressure to release the lock.

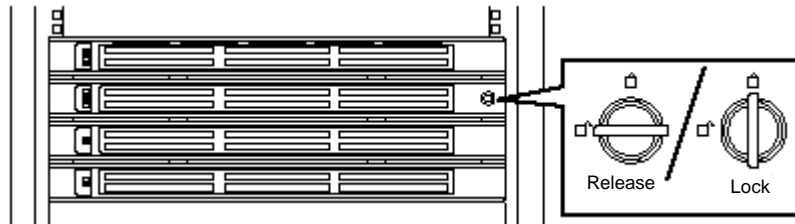

2. Hold the right side of the front bezel lightly and pull it open.
3. Detach the bezel from the main unit by sliding it to the left a little to disengage the tabs from the frame.

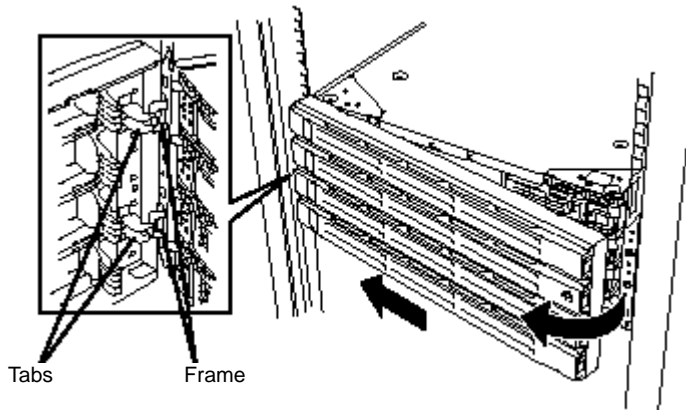

Attach

To attach the front bezel, engage the tabs on the frame on the left side of the main unit. After attaching and closing the front bezel, lock it with the key for security.

Power ON

To power on NEC Express5800/ft series, press the POWER switch located on the front panel.

Follow the steps below to turn on the power. (A rack-mount model is shown here for convenience of explanation. However, the steps are the same for a tower model except that the modules are mounted vertically.)

1. Power on the display unit and other peripheral devices connected to the server.

TIPS:

- If the power cord is connected to a power controller like a UPS, make sure that it is powered on.
 - When NEC Express5800/ft series is powered on, BMCs between the two PCI modules are synchronized. (The BMC Status LED on secondary module blinks.) See Chapter 2 "LEDs" for details of the BMC Status LED.
-

2. Detach the front bezel (or open it in the case of a tower model).
3. Confirm that the BMC Status LED on both PCI modules are off and press the POWER switch which illuminates green and located on the front panel.

After a while, the "NEC" logo will appear on the screen.

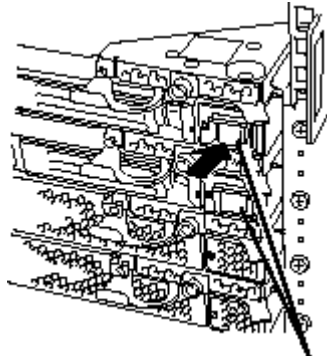

POWER switches* (LEDs)
*You can only use a power switch whose LED is on.

IMPORTANT:

- Do not turn off the power before the "NEC" logo appears.
 - When powering on, make sure that the BMC Status LED on the both PCI modules are off and then press the power switch.
-

While the "NEC" logo is displayed on the screen, NEC Express5800/ft series is performing a power-on self test (POST) to check itself. For details, see "POST Check" described later in this chapter. Upon the completion of POST, the OS will start.

TIPS: If the server finds errors during POST, it will interrupt POST and display the error message. See Chapter 7.

Power OFF

Follow the steps below to turn off the power. If NEC Express5800/ft series is plugged to a UPS, see manuals included with the UPS or the application that controls the UPS.

- 1.** Perform a proper shutdown process from Linux for NEC Express5800/ft series.
Press the POWER switch to turn off the power.
- 2.** Power off all peripheral devices.

POST Check

POST (power-on self test) is a self-test function stored on the motherboard of NEC Express5800/ft series.

When you power on the server, POST will start automatically to check the motherboard, ECC memory modules, CPU modules, keyboard, mouse, etc. It also shows startup messages for various BIOS setup utilities.



According to the factory default settings, the “NEC” logo appears on the display while POST is being performed. (To view POST’s details, press **Esc**.)

TIPS:

- You can view POST details from the beginning without the need to press **Esc** when the BIOS menu is displayed: select [System Configuration] - [Advanced], and set [Boot-time Diagnostic Screen] to "Enabled" (see Chapter 4).
 - You can view the test items and details from a management PC where NEC ESMPRO Manager or NEC MWA is installed.
-

You don't always need to check POST details. You will need to check messages when:

- You install a new NEC Express5800/ft series.
- A failure is suspected.
- You hear several beeps between the time of the power-on and OS start-up.
- The display unit or the LCD* shows an error message.

*For details, see “Error Messages on the Liquid Crystal Display (LCD)” in Chapter 7.

TIPS: Although there is no LCD on the front of NEC Express5800/ft series, you can check error messages using NEC MWA or NEC ESMPRO Manager. For details, see Chapter 7.

Flow of POST

This section walks you through how POST is performed.

1. When you power on the system, one selected CPU/PCI module will start up.

POST will be performed on this selected CPU/PCI module.

2. Memory check starts.

A message appears at the upper left of the screen to show that the basic and expanded memories are being counted. The memory check may take a few minutes to complete depending on the server's memory size. Likewise, it may take about one minute for the screen to appear when the server is rebooted.

Note that if you have replaced the PCI module, the server will perform a reset of the MAC address, then reboot itself before the memory check.

3. The server starts processor check, IO check, and initialization.

Several messages appear: they show the ID of the selected CPU/PCI modules, information on the processor, detection of the keyboard and mouse, etc.

4. A message appears at the lower left of the screen, prompting for startup of the BIOS setup utility "SETUP."

Press <F2> to enter SETUP

You will need to start it when you want modify the configuration for using the server. Unless this message appears together with an error message, you don't need to start the utility to modify the configuration. (If you wait for a few seconds, POST will go on automatically.)

To start the SETUP utility, press **F2** while the above message is displayed. For setting and parameter functions, see the section of BIOS setup.

When SETUP is completed, the server will reboot itself automatically and perform POST.

5. A message appears prompting for startup of SCSI BIOS setup utility.

When a built-in SCSI controller is detected, a message will appear prompting for startup of SCSI BIOS setup utility. (If you wait for a few seconds, POST will go on automatically.)

If you press **Ctrl + Q**, the SCSI BIOS setup utility will start. For setting and parameter functions, see the section on SCSI setup.

You will need to use this utility, for example, when you have changed the server's internal SCSI device connections. However, you usually don't need to use it.

When SETUP is complete, the server will reboot automatically and perform POST again.

If multiple SCSI controller boards are mounted on the PCI bus, the SCSI BIOS startup message will appear for these boards in numerical order (PCI #1, PCI #2, PCI #3...).

6. The screen shows SCSI ID numbers used by the connected SCSI devices.

7. Upon completion of POST, the password entry screen appears prior to OS startup.

The password entry screen will appear after the normal termination of POST only if you have set a password in the BIOS setup utility “SETUP.”

You can enter a password up to three times. If you enter an incorrect password three times, the startup will be unsuccessful. In this case, turn off the power and then turn it on again after waiting 30 seconds to boot the server.

IMPORTANT: Do not set a password before installing the OS.

8. Upon completion of POST, the OS will start up.

Behavior at Occurrence of Error

If POST or OS startup does not finish normally, the server will reboot itself automatically.

At the time of reboot, it will select the other CPU/PCI module and run POST or OS startup.

In this manner, the server retries POST or OS startup with different combinations of CPU/PCI modules. If POST does not finish normally with any combinations, the server will stop with the state of DC OFF.

While performing retries, the server displays or registers the error types.

For details of error messages, see Chapter 7 “Troubleshooting.”

POST Error Messages

When the server detects an error during POST, it will notify you of the occurrence in the following manners:

- Displays an error message on the display unit.
- Displays an error message on the LCD*.
- Makes a beeping sound.

*For details, see “Error Messages on the Liquid Crystal Display (LCD)” in Chapter 7.

These notification methods are described in “POST Error Messages” in Chapter 7.

IMPORTANT: Before you contact your sales agent, write down the error messages and patterns of the beeping sound. They will serve as helpful information at the time of maintenance.

Floppy Disk Drive

A USB floppy disk drive is attached to the main unit. It allows you to read and write (save) data using floppy disks.

The USB floppy disk drive accepts the following types of floppy disks:

- 2HD floppy disk (1.44MB)
- 2DD floppy disk (720KB)

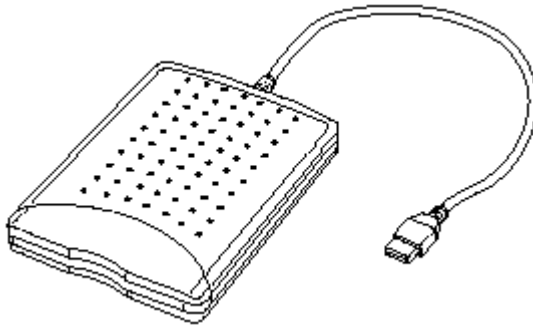

Insert/Remove Floppy Disk

Before inserting a floppy disk into the drive, make sure that NEC Express5800/ft series is on and that the drive's USB cable is connected to the USB connector at the back of the server.

Insert a floppy disk into the drive firmly with the label side up and its protective shutter facing the drive.

TIPS:

- You cannot physical format floppy disks on the USB floppy disk drive. Use formatted floppy disks.
 - If you power on or restart NEC Express5800/ft series with a floppy disk left in the drive, the server will access the floppy disk to start the system. Unless a system exists on the FD, the server will be unable to start.
-

To remove a floppy disk from the drive, press the eject button.

TIPS: Before removing a floppy disk, make sure that the access LED is off. If you eject a floppy disk while the LED is on, the stored data could be damaged.



Use of Floppy Disk

You may need to store important data on floppy disks. Since the floppy disk is a very delicate medium, you must handle it with extra care:

- Push the floppy disk gently into place.
- Attach the label on a proper position.
- Do not use a pencil or ballpoint pen to write on the disk.
- Do not open the protective shutter.
- Do not use the floppy disk in a dusty place.
- Do not place anything on the floppy disk.
- Do not leave the floppy disk in a place that is subject to direct sunlight or high temperatures (e.g., near a heater).
- Keep away from cigarette smoke.
- Do not leave the floppy disk near water or chemicals.
- Keep away from magnetic objects.
- Do not clip disks. Be careful not to drop.
- Store floppy disks in a protective case where they are kept away from magnetic waves or dust.
- To prevent data from being erased accidentally, the floppy disk has a write-protect notch. When the disk is write-protected, you can read data, but you cannot write the data or format the disk. It is recommendable to write-protect floppy disks that contain important data. To write-protect a floppy disk, slide the write-protect notch located on its back.
- The floppy disk is a very delicate storage medium. Dust or changes in temperature could cause data to be lost. Data loss could also be caused by faulty operation and computer trouble. To avoid such possible data loss, it is recommendable to back up important data regularly. (Be sure to make back-up copies of the disks that are included with NEC Express5800/ft series.)

CD-ROM Drive

NEC Express5800/ft series has a CD-ROM drive on the front panel. It is a device used to read data from a CD-ROM (compact disc read-only memory). Compared to a floppy disk, a CD-ROM allows for larger volume and fast data readout.

 CAUTION	
	<p>Observe the following instructions to use the server safely. There are risks of a burn, injury, or damage to physical assets. For details, see PRECAUTIONS FOR SAFETY in Chapter 1.</p> <ul style="list-style-type: none"> ■ Do not leave the CD tray ejected.

About the CD-ROM Drive of NEC Express5800/ft series

Two CD-ROM drives (one on each PCI module) are mounted on NEC Express5800/ft series. Both CD-ROM drives are available after the OS startup. When installing from the Back Up CD-ROM, only the CD-ROM drive mounted to the primary PCI module can be used for installation.

When you cannot eject a CD-ROM

When you cannot eject the CD-ROM by pressing the eject button, follow the steps below to eject it:

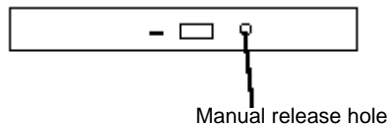

1. Perform the shutdown process of the Linux for Express5800/ft series. Then press the POWER switch to turn off the power of the NEC Express5800/ft series.
2. Use a metal pin of about 1.2 mm in diameter and 100 mm long (alternatively, you can use a fairly large paper clip after straightening). Insert it gently into the manual release hole located to the right of the eject button until the tray is ejected.

IMPORTANT:

- Do not use a toothpick, plastic pin, or other breakable objects.
 - If you cannot eject the CD-ROM by following the steps above, contact your sales agent.
-

3. Hold the tray and pull it out.
4. Take out the CD-ROM.
5. Push the tray back.

Use of CD-ROM

Observe the following when you use a CD-ROM on NEC Express5800/ft series:

- As for a disk such as a noncompliant “copy-protected CD,” we shall not guarantee that you can use a CD player to play it with this server.
- Be careful not to drop the CD-ROM.
- Do not bend or place anything on the CD-ROM.
- Do not attach labels on the CD-ROM.
- Do not touch the signal side (blank side).
- Place the CD-ROM gently on the tray with the printed side up.
- Do not scratch, or use a pencil or ballpoint pen to write on the CD-ROM.
- Keep away from cigarette smoke.
- Do not leave the CD-ROM in a place that is subject to direct sunlight or high temperatures (e.g., due to a heater).
- If the CD-ROM gets dirty with dust or fingerprints, wipe it gently from its center to edge with a dry soft cloth.
- When you clean the CD-ROM, use a CD cleaner. Do not use a record cleaner (spray), benzine, or thinner.
- Store the CD-ROM in a protective case when not in use.

Chapter 3

Linux Setup and Operation

This chapter describes setup procedures to make NEC Express5800/ft series ready for use.

HARD DISK CONFIGURATIONS THAT CAN BE BUILT ON THE NEC Express5800/ft series

In the NEC Express5800/ft series, all built-in disks need RAID configuration. Configure RAID 1 using software for the NEC Express5800/ft series.

The hard disks on the same slot location of the PCI module configure RAID. In the following figure, disks in Slot 1, Slot 2 and Slot 3 of Group 1 are paired with disks in Slot 1, Slot 2 and Slot 3 of Group 2 respectively to configure RAID.

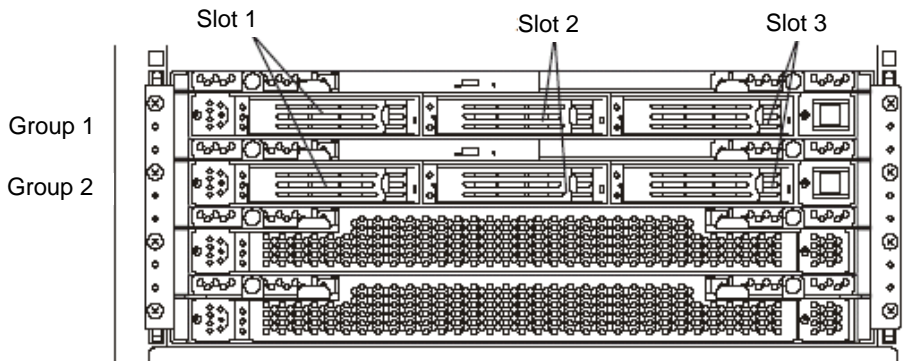

Slots used for mirroring process

The following indicates the device names of built-in SCSI disks for each SCSI disk slot. Use these device names for all operations of each built-in SCSI disk.

Slot No of PCI module	Device name
Slot 1 for Group 1	sda
Slot 2 for Group 1	sdb
Slot 3 for Group 1	sdc
Slot 1 for Group 2	sdd
Slot 2 for Group 2	sde
Slot 3 for Group 2	sdf

IMPORTANT:

When adding disks or reconfiguring RAID, the status of each disk becomes “RESYNCING” or “RECOVERY”. Do not insert/remove disks, turn off the power, or restart the system during this status. Wait until the status of “RESYNCING” or “RECOVERY” is finished. You can check the status of RAID using `ftdiskadm` described later. For details, see the separate volume of User’s Guide (Setup).

The SD device, described previously is used to configure RAID 1.

IMPORTANT: Two hard disk drives which configure RAID 1 must have the same disk capacity. Also, two hard disk drives must have the same logical structure.

Perform operations for built-in SCSI disks, such as mounting a disk, to devices (md) for RAID by software.

With the standard configuration at the time of shipment, the SCSI disks are inserted to the slot 1 of the PCI modules for Group 1 and Group 2.

REPLACING 3.5-INCH HARD DISK DRIVE

Follow the procedure below to remove the failed hard disk. If the hard disk fails, it should be replaced with new device with the server powered-on.

How to Locate Failed Disks

This section describes a procedure to locate failed disks.

1. Open [Data Viewer] from ESMPRO Manager.

If trouble occurs, the color changes from green to red.

In this case, you will notice that there is trouble with both the SCSI Enclosures (ID: 41) and (ID: 42).

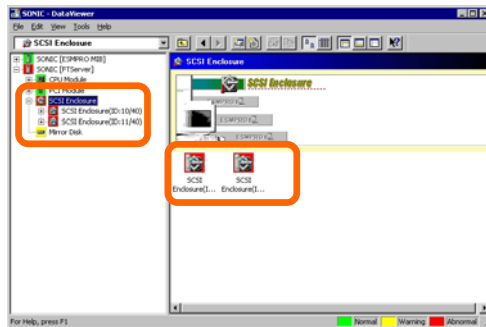

2. Check the SCSI Enclosures (ID: 41) and (ID: 42) on the tree.

See the path information in [General Information] of [SCSI Slot] to locate a group of 3.5-inch hard disk drive bays that corresponds to each enclosure.

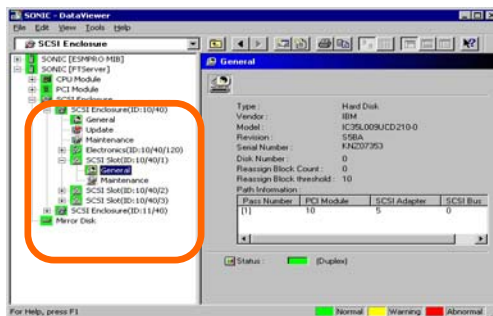

The table below shows the path information on Groups 1 and 2:

Slot	PCI module	SCSI adapter	SCSI bus
Group1	10	5	0
Group2	11	5	0

3. See the path information in [General Information] of [SCSI Slot (ID: 41/1)].

It shows that PCI module, SCSI adapter, and SCSI bus are 10, 5, and 0, respectively.

Pass Number	PCI Module	SCSI Adapter	SCSI Bus
[1]	10	5	0

This allows you to find that SCSI Slot (ID: 41/1) belongs to Group 1. SCSI slots under SCSI Enclosure (ID: 41) correspond to Group 1. Therefore, Group 2 corresponds to SCSI slots under SCSI Enclosure (ID: 42).

You will find that the failed disk located in the SCSI slot (ID: 41/2) is the second disk of Group 1.

Restoring Redundant Configuration Manually

This section describes procedure to change the built-in disk on which failures occurred and re-establish the dual configuration of hard disks.

IMPORTANT:

- You need to log in the system as a root user to perform this operation.
 - While recovery operation of RAID, the status of two disks configuring RAID become “RESYNCING” or “RECOVERY” to build RAID for a while. Do not stop or restart the system until that status is finished.
-

1. Select “RAID” – “Remove Half Disk” or “Remove Full Disks” of `ftdiskadm` to separate the disk specified by the slot number from the RAID, and from the system.
2. Remove the disk from the system and then insert a new disk.
3. Use “Repair Disk” of `ftdiskadm` to perform RAID recovery.

The following is an example from the separation of the built-in disk inserted to the slot 1 of the PCI module for Group 2, to the recovery. SCSI SLOT numbers on Remove correspond to the slot numbers of the PCI modules as:

Slot 1 to 3 of the PCI module for Group 1 : SCSI SLOT number 1 to 3

Slot 1 to 3 of the PCI module for Group 2 : SCSI SLOT number 4 to 6

```
# ftdiskadm
Command action
 1 => SCSI
 2 => RAID
 3 => Environment
 9 Quit

Command: 2

Command action
 1 Status(Raid)
 2 Status(All Disks)
 3 Repair Disk
 4 New Disks
 5 Remove Half Disk
 6 Remove Full Disks
 9 <= RETURN

Command: 5

[Remove Half Disk]
* Which SCSI SLOT? [1-6] 4
mdct: hot removed /dev/sdd1
mdct: hot removed /dev/sdd3
mdct: hot removed /dev/sdd5
mdct: hot removed /dev/sdd6
mdct: hot removed /dev/sdd7
mdct: hot removed /dev/sdd8
mdct: hot removed /dev/sdd2
scsi remove-path 11 1000
```

```

Command action
 1 Status(Raid)
 2 Status(All Disks)
 3 Repair Disk
 4 New Disks
 5 Remove Half Disk
 6 Remove Full Disks
 9 <= RETURN

Command: 1          <<Confirm that the disk is disconnected>>
[Status(Raid)]
-----
name  partition  label      status      member
md0   /usr         /usr       SIMPLEX     (1)sda2
md1   /boot        /boot      SIMPLEX     (1)sda1
md2   /home        /home      SIMPLEX     (1)sda3
md3   /var         /var       SIMPLEX     (1)sda5
md4   swap         /          SIMPLEX     (1)sda6
md5   /            /          SIMPLEX     (1)sda7
md6   /tmp         /tmp       SIMPLEX     (1)sda8
-----

<<Confirm that the above status is SIMPLEX before
exchanging the disk>>
<<The following is an example of a RAID recovery
procedure>>

Command action
 1 Status(Raid)
 2 Status(All Disks)
 3 Repair Disk
 4 New Disks
 5 Remove Half Disk
 6 Remove Full Disks
 9 <= RETURN

Command: 3
[Repair Disk]
* Which SCSI SLOT? [1-6] 4
scsi add-single-device 11 1000
mdctl: hot added /dev/sdd1
mdctl: hot added /dev/sdd3
mdctl: hot added /dev/sdd5
mdctl: hot added /dev/sdd6
mdctl: hot added /dev/sdd7
mdctl: hot added /dev/sdd8
mdctl: hot added /dev/sdd2

Command action
 1 Status(Raid)
 2 Status(All Disks)
 3 Repair Disk
 4 New Disks
 5 Remove Half Disk
 6 Remove Full Disks
 9 <= RETURN

```

Command: 1 <<Confirm that the duplication process is started >>

[Status(Raid)]

name	partition	label	status	member
md0	/usr	/usr	RESYNC	(1)sda2 -(4)sdd2
md1	/boot	/boot	DUPLEX	(1)sda1 (4)sdd1
md2	/home	/home	RESYNC	(1)sda3 -(4)sdd3
md3	/var	/var	RESYNC	(1)sda5 -(4)sdd5
md4	swap		RESYNC	(1)sda6 -(4)sdd6
md5	/	/	RESYNC	(1)sda7 -(4)sdd7
md6	/tmp	/tmp	RESYNC(20.9%)	(1)sda8 -(4)sdd8

<<Perform RESYNC to each md device. After a while, use the following command and check the status again.>>

Command action

- 1 Status(Raid)
- 2 Status(All Disks)
- 3 Repair Disk
- 4 New Disks
- 5 Remove Half Disk
- 6 Remove Full Disks
- 9 <= RETURN

Command: 1

[Status(Raid)]

name	partition	label	status	member
md0	/usr	/usr	DUPLEX	(1)sda2 (4)sdd2
md1	/boot	/boot	DUPLEX	(1)sda1 (4)sdd1
md2	/home	/home	DUPLEX	(1)sda3 (4)sdd3
md3	/var	/var	DUPLEX	(1)sda5 (4)sdd5
md4	swap		DUPLEX	(1)sda6 (4)sdd6
md5	/	/	DUPLEX	(1)sda7 (4)sdd7
md6	/tmp	/tmp	DUPLEX	(1)sda8 (4)sdd8

<<If each md device's status is DUPLEX, disk duplication is completed.>>

(This page is intentionally left blank.)

Chapter 4

System Configuration

This chapter describes Basic Input Output System (BIOS) configuration.

When you install the server for the first time or install/remove optional devices, thoroughly read this chapter for better understanding and correct setups.

SYSTEM BIOS ~ SETUP ~

The SETUP utility is provided to make basic hardware configuration for the server. This utility is pre-installed in the flash memory of the server and ready to run.

The server is configured with the correct parameters using the SETUP utility and shipped in the best conditions. Thus, you don't need to use the SETUP utility in most cases. However, you might wish to use the SETUP utility in the cases described below.

IMPORTANT:

- The SETUP utility is intended for system Administrator use only.
 - The SETUP utility allows you to set a password. The server is provided with two levels of password: Supervisor and User. With the Supervisor password, you can view and change all system parameters of the SETUP utility. With the User password, system parameters available for viewing and changing are limited.
 - Do not set any password before installing the OS.
 - The server contains the latest version of the SETUP utility. Dialog boxes appearing on your SETUP utility, thus, may differ from descriptions in this User's Guide. If you find anything unclear, see the online help or ask your sales agent.
-

Starting SETUP Utility

Powering on the server starts POST (Power On Self-Test) and displays its check results. If the NEC logo is displayed, press **Esc**.

After a few seconds, either of the following messages appears at bottom left on the screen depending on your system configuration.

Press <F2> to enter SETUP

Press <F2> to enter SETUP, Press <F12> to Network

You may see either of the following messages at bottom left on the screen when POST terminates.

Press <F1> to resume, <F2> to SETUP

Press <F1> to resume, <F2> SETUP, <F12> Network

Press **F2** to start the SETUP utility and display its Main menu.

If you have previously set a password with the SETUP utility, the password entry screen appears. Enter the password.

Enter password:[]

Up to three password entries will be accepted. If you fail to enter the password correctly for three consecutive times, the server halts. (You can no longer proceed.) Power off the server.

TIPS: The server is provided with two levels of password: Supervisor and User. With the Supervisor password, you can view and change all system configurations. With the User password, the system configurations you can view or change are limited.

Description of On-Screen Items and Key Usage

Use the following keyboard keys to work with the SETUP utility. (Key functions are also listed at the bottom of the screen.)

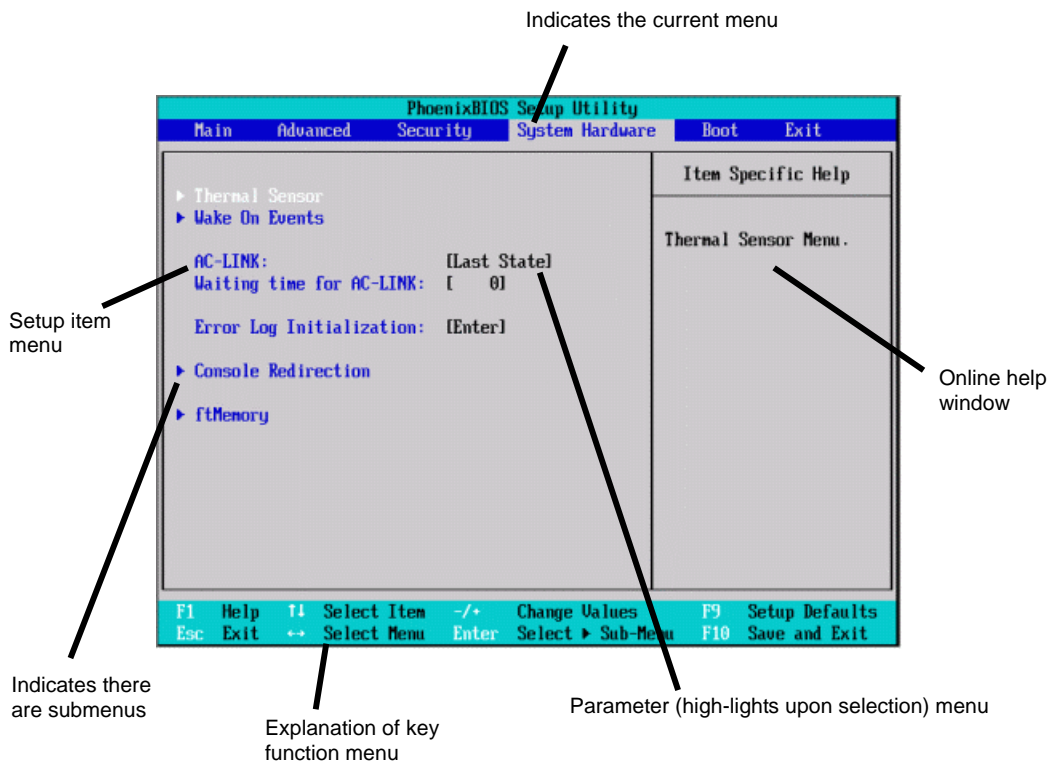

- Cursor (↑, ↓):** Selects an item on the screen. The highlighted item is currently selected.
- Cursor (←, →):** Selects the Main, Advanced, Security, System Hardware, Boot, or Exit menu.
- and +:** Changes the value (parameter) of the selected item. When a submenu option (an option preceded by "▶") is selected, these keys are disabled.
- Enter** Press **Enter** to choose the selected parameter.
- Esc** Displays the previous screen.
- F1:** Press **F1** when you need help on SETUP operations. The help screen for SETUP operations appears. Press **Esc** to return to the previous screen.
- F9:** Sets the default parameter to the parameter of the currently displayed item. (The default parameter may differ from the factory setting.)
- F10:** Save configuration values and exit.

Configuration Examples

The following describes examples of configuration required to use software-link features or for system operations.

Link with Management Software

To use the management PC with "NEC MWA" installed for remote operations

- Remote operation via LAN
Select [Advanced] → [Advanced] → [RomPilot Support] → [Enabled].
- Remote operation via direct connection using cross cable
Select [System Hardware] → [Console Redirection] → [Console Connection] → [Direct].
- Remote operation via WAN
Select [System Hardware] → [Console Redirection] → [Console Connection] → [Via Modem].

UPS

To link power supply with the UPS

- To power on the server when power is supplied from the UPS
Select [System Hardware] → [AC-LINK] → [Power On].
- To keep the server off-powered even when power is supplied from the UPS if the POWER switch was used to power off
Select [System Hardware] → [AC-LINK] → [Last State].
- To keep the server off-powered even when power is supplied from the UPS
Select [System Hardware] → [AC-LINK] → [StayOff].

Keyboard

To set NumLock and key repeat

Select [Advanced] → [Keyboard Features] and set each item.

Security

To set passwords on the BIOS level

Select [Security] → [Set Supervisor Password] and enter a password.

Set Supervisor password first, then User password.

To enable/disable the POWER switch

Select [Security] → [Power Switch Mask] → [Unmasked].

Select [Security] → [Power Switch Mask] → [Masked].

IMPORTANT: Masking the POWER switch disables forced shutdown (see Chapter 4) as well as power on/off using the POWER switch.

Serial Devices

To setup serial devices

Select [Advanced] → [Peripheral Configuration] and setup each device.

Optional PCI-related devices

To install optional PCI board, etc.,

Select [Advanced] → [Option ROM] → [PCI Slot n] → [Enabled]

n: Slot number to install the board

Boot

To change the boot order of devices connected to the server

Select [Boot] and specify the boot order.

To display POST check results

Select [Advanced] → [Advanced] → [Boot-time Diagnostic Screen] → [Enabled].

You can also press **Esc** while the NEC log is on the screen to display POST check results.

To control from the HW console

- Remote operation via LAN

Select [Advanced] → [Advanced] → [RomPilot Support] → [Enabled].

- Remote operation via WAN

Select [System Hardware] → [Console Redirection] and set each item.

Memory

To check the installed memory (DIMM) status

Select [Advanced] → [Memory Information] and check the status indications.

Saving the Configuration Data

To save the BIOS configuration data

Select [Exit] → [Save Changes & Exit] or [Save Changes].

To discard changes to the BIOS configuration data

Select [Exit] → [Exit Without Saving Changes] or [Load Previous Value].

To restore the default BIOS configuration (it may be different from the configuration at shipment)

Select [Exit] → [Get Default Values].

Menu and Parameter Descriptions

The SETUP utility has the following six major menus:

- Main
- Advanced
- Security
- System Hardware
- Boot
- Exit

To configure detailed settings of functions, select a submenu from the above menus. Below describes configurable functions and parameters and the factory settings displayed in the screen for each menu.

Main

Start the SETUP utility to display the Main menu.

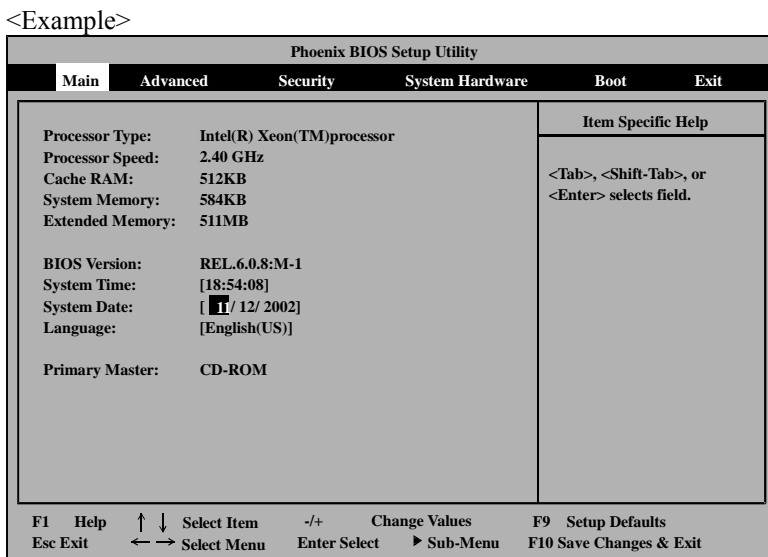

Available options in the Main and descriptions are listed below.

Option	Parameter	Description	Your Setting
Processor Type	Intel® Xeon™ Processor	Indicates the type of the installed CPU (view only).	
Processor Speed	2.40GHz	Indicates the clock speed of the installed CPU (view only).	
Cache RAM	512KB	Indicates the cache RAM size (view only).	
System Memory	584KB	Indicates the total size of the basic memory (view only).	
Extended Memory	(Extended memory size)	Indicates the total size of the extended memory (view only).	
BIOS Version	(Version of BIOS)	Indicates the version of the system BIOS (view only).	
System Time	HH:MM:SS	Specify the current time.	
System Date	MM/DD/YYYY	Specify the current date.	
Language	[English (US)] Français Deutsch Italiano Español	Select a language in which the SETUP is displayed. Only English (US) is supported currently.	
Primary Master	CD-ROM	Indicates device type connected to IDE (Primary master). (View only)	

[]: Factory-set

IMPORTANT: Check and adjust the system clock before operation in the following conditions.

- After transporting the equipment
- After storing the equipment
- After the equipment halt under the conditions which is out of the guaranteed environment conditions (temperature: 10 to 35°C, humidity: 20 to 80%).

Check the system clock once in a month. It is recommended to operate the system clock using a time server (NTP server) if it is installed on the system which requires high level of time accuracy. If the system clock becomes delayed or advanced remarkably as time passes even after system clock adjustment, contact your sales agent.

Advanced

Move the cursor onto "Advanced" to display the Advanced menu.

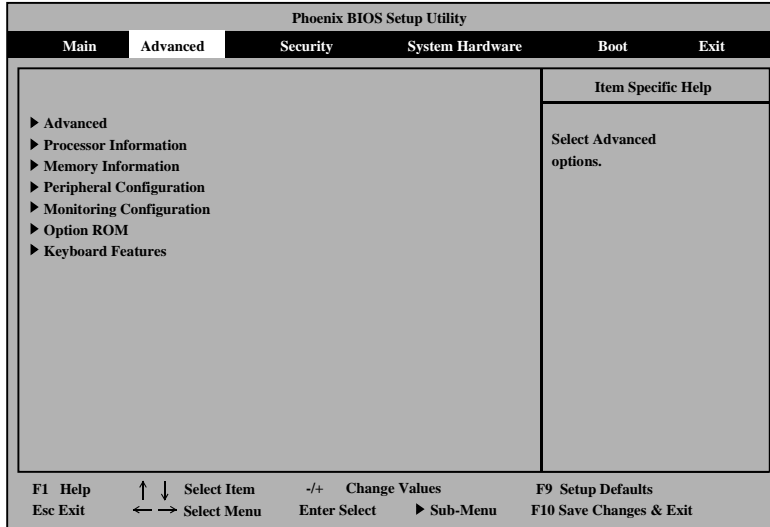

There is no configurable items on the above Advanced menu screen. Display each sub menu and make settings on the sub menu screen. Select an option with the "▶" mark and press **Enter** to display its submenu.

Advanced

Select "Advanced" on the Advanced menu to display the following screen.

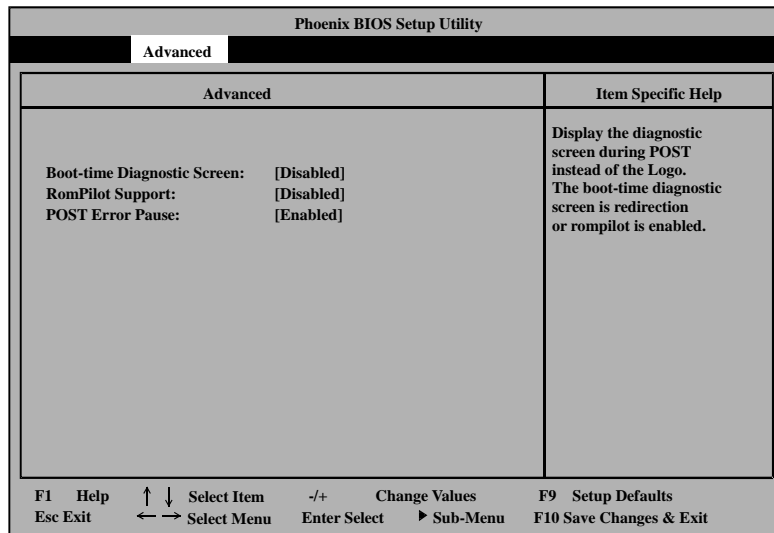

See the table below for setup options on the screen.

Option	Parameter	Description	Your Setting
Boot-time Diagnostic Screen	[Disabled] Enabled	Specify whether to display the Power On Self-Test (POST) screen at start-up. If "Disabled" is selected, the NEC logo appears while POST is in progress. (To display POST check results, press Esc .) If "RomPilot Support" is set to "Enabled" or "Console Redirection" is set, this option is unconditionally set to "Enabled".	
RomPilot Support	[Disabled] Enabled	Enable or disable the RomPilot (the remote console and remote drive features during OS start-up). If this option is set to "Enabled", "Boot-time Diagnostic Screen" is unconditionally set to "Enabled".	
Post Error Pause	[Enabled] Disabled	Specify whether to stop POST at the end of POST when an error occurs during POST.	

[]: Factory-set

TIPS: "RomPilot" is a BIOS feature for communications with the NEC Management Workstation Application (NEC MWA). To use the NEC MWA for management of the server, select "Enabled" for "RomPilot Support." Use of the RomPilot features requires setups for the NEC MWA.

Processor Information

Select "Processor Information" on the Advanced menu to display the following screen.

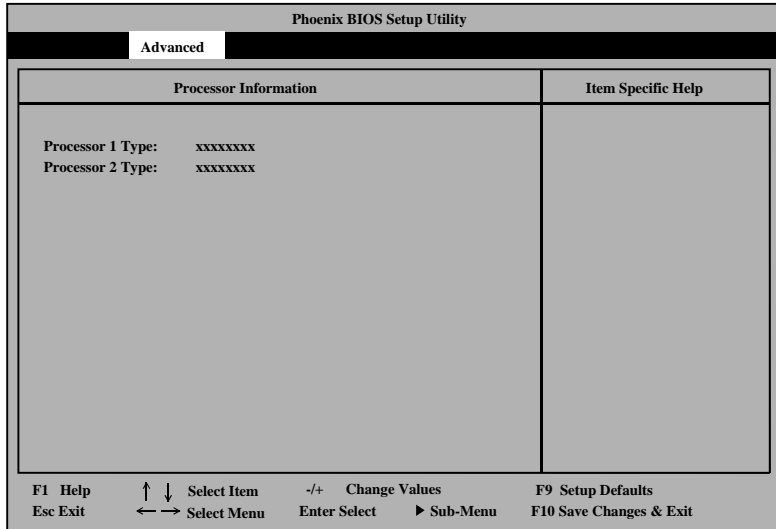

See the table below for setup options on the screen.

Option	Parameter	Description	Your Setting
Processor 1 Type Processor 2 Type	—	Indicates processor type installed on Processor 1 or Processor 2 (view only).	

[]: Factory-set

Memory Information

Select "Memory Information" on the Advanced menu to display the following screen.

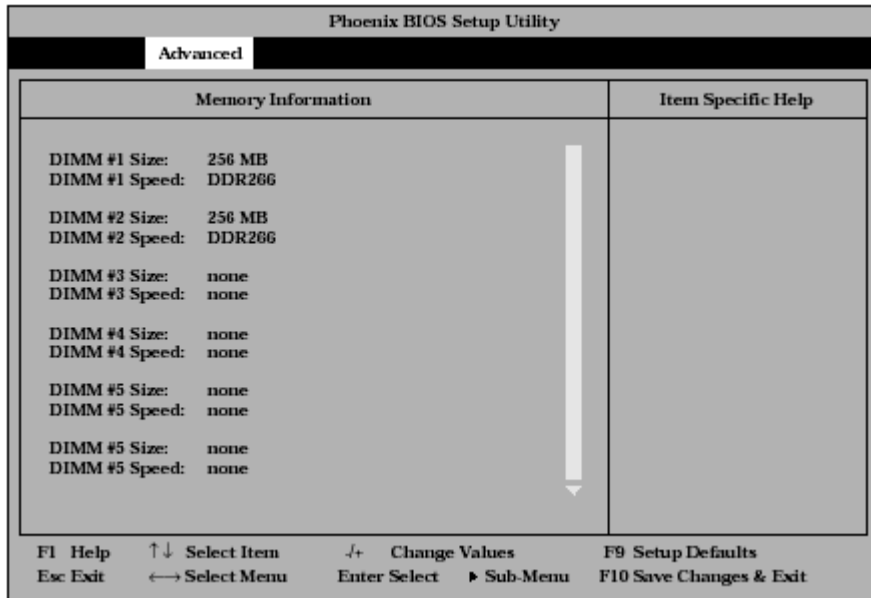

See the table below for setup options on the screen.

Option	Parameter	Description	Your Setting
DIMM #1- #6 Size	–	Indicates the size of memory installed on DIMMs 1 (#1) to 6 (#6). "None" indicates no DIMM installed (view only).	
DIMM #1- #6 Speed	–	Indicates the type of DIMM (DDR200/DDR266) installed on DIMMs 1 (#1) to 6 (#6). "None" indicates no DIMM installed (view only).	

[]: Factory-set

Peripheral Configuration

Select "Peripheral Configuration" on the Advanced menu to display the following screen.

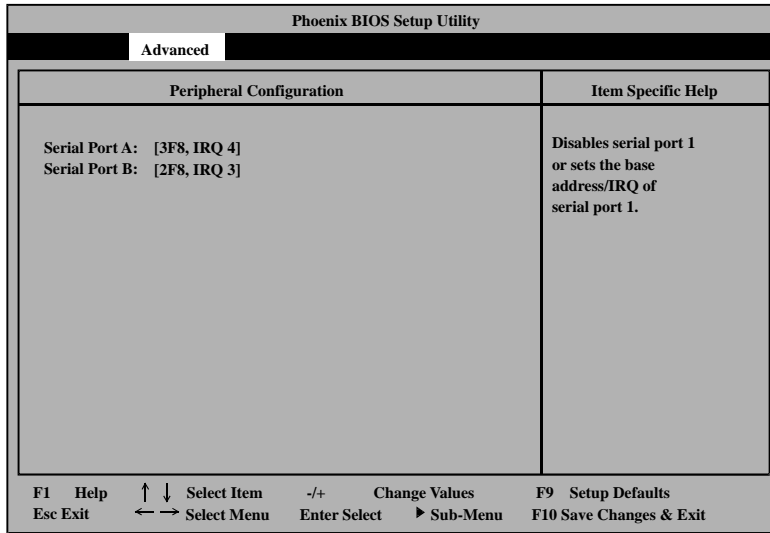

See the table below for setup options on the screen.

IMPORTANT: Make sure to avoid any conflict in the interrupt requests or the base I/O addresses.

Option	Parameter	Description	Your Setting
Serial Port A Serial Port B	Disabled 3F8, IRQ 3 [3F8, IRQ 4] ^{*1} [2F8, IRQ 3] ^{*2} 2F8, IRQ 4 3E8, IRQ 3 3E8, IRQ 4 2E8, IRQ 3 2E8, IRQ4 Auto	Enable or disable the serial port A and B, or specify a base address and interrupt. *1 Factory setting for the serial port A *2 Factory setting for the serial port B	

[]: Factory-set

Monitoring Configuration

Select "Monitoring Configuration" on the Advanced menu to display the following screen.

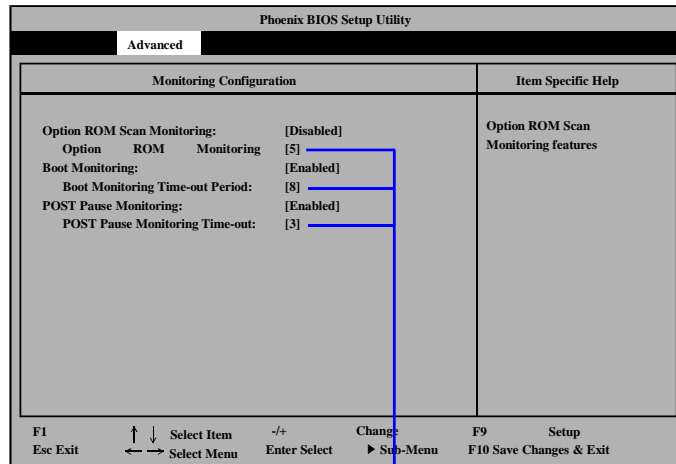

Displayed only when "Enabled" is selected for "Option ROM Scan Monitoring", "Boot Monitoring" or "POST Pause Monitoring".

See the table below for setup options on the screen.

Option	Parameter	Description	Your Setting
Option ROM Scan Monitoring	Disabled [Enabled]	Enable or disable the Option ROM scan monitoring feature.	
Option ROM Monitoring Time-out	1 - [5] - 20	Specify the Option ROM monitoring time-out period. This option is displayed only when "Enabled" is selected for "Option ROM Scan Monitoring".	
Boot Monitoring	Disabled [Enabled]	Enable or disable the boot monitoring feature. This function is unique to the NEC Express5800/ft series: detects errors until the OS boots up, and immediately reboots the OS upon detection of an error. (For details, see "Behavior at Occurrence of Error" in Chapter 2.) Enable this function if NEC ESMPRO Agent is installed on the OS. Disable this function if NEC ESMPRO Agent is not installed or when you install the OS. Otherwise, the OS will boot up after "Specified boot timeout."	
Boot Monitoring Time-out Period	1 - [10] - 20	Specify the boot monitoring time-out period. This option is displayed only when "Enabled" is selected for "Boot Monitoring". If you specify a shorter period of time to "Boot Monitoring Time-out Period", the time until rebooting can be reduced. When there is no external device connected, it is possible to set a shorter period of time, but 3 minutes or longer is recommended. Appropriate value for the setting varies depending on your environment. Therefore, when changing this setting, evaluate it thoroughly after constructing the environment.	
POST Pause Monitoring	Disabled [Enabled]	Enable or disable the POST monitoring feature during boot-up restriction.	

Option	Parameter	Description	Your Setting
POST Pause Monitoring Time-out	1 - [3] - 20	Specify the POST monitoring time period during boot-up restriction.	

[]: Factory-set

IMPORTANT:

- When connecting a Fibre Channel disk array device, change the set value of "Boot Monitoring Time-out Period" depending on the wait time for the completion of the Fibre Channel disk array device initialization.

Ex.: If the wait time for the completion of the Fibre Channel disk array device initialization is 4 minutes, change the value of "Boot Monitoring Time-out Period" from 10 (default) to 14 minutes.

- If you set a small value for "Boot Monitoring Time-out Period", you can shorten the waiting time to the rebooting. It is recommended to set a value of more than 3 minutes though smaller value setting is available when external devices are not used. As it depends on the user's setting environment, make sure to execute enough evaluation after the configuration of the environment.

Option ROM

Select "Option ROM" on the Advanced menu to display the following screen and enable/disable expansion of Option Rom BIOS on the PCI bus.

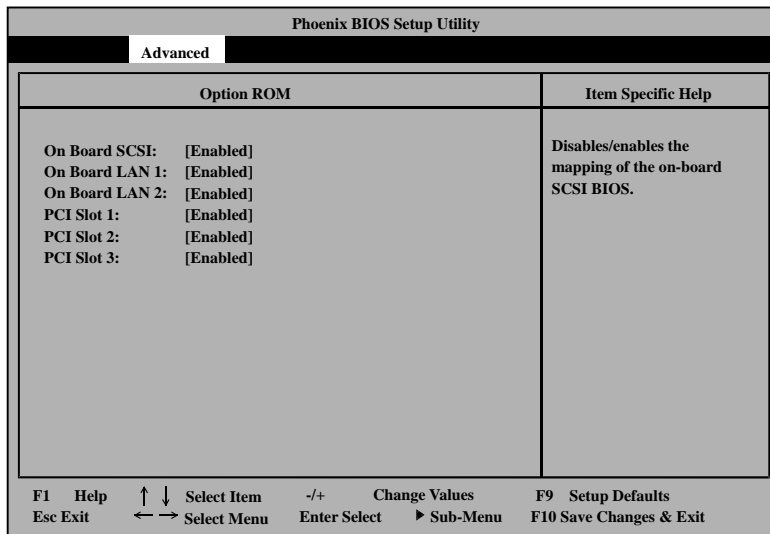

See the table below for setup options on the screen.

Option	Parameter	Description	Your Setting
On Board SCSI	Disabled [Enabled]	Enable or disable expansion of SCSI BIOS on the motherboard.	
On Board LAN 1, 2	Disabled [Enabled]	LAN1: Enable or disable 10/100BASE LAN controller on the motherboard. LAN2: Enable or disable 1000BASE LAN controller on the motherboard.	
PCI Slot 1 - PCI Slot 3	Disabled [Enabled]	Enable or disable BIOS on a device (board) connected to the PCI bus. Select "Enabled" for the graphic accelerator board. Select "Disabled" for Option ROM of PCI LAN device when the network boot feature is not used.	#1: #2: #3:

[]: Factory-set

IMPORTANT: For the slot which a graphical accelerator board is installed, do not specify "Disabled".

Keyboard Features

Select "Keyboard Features" on the Advanced menu to display the following screen. The NumLock submenu allows you to make keyboard settings.

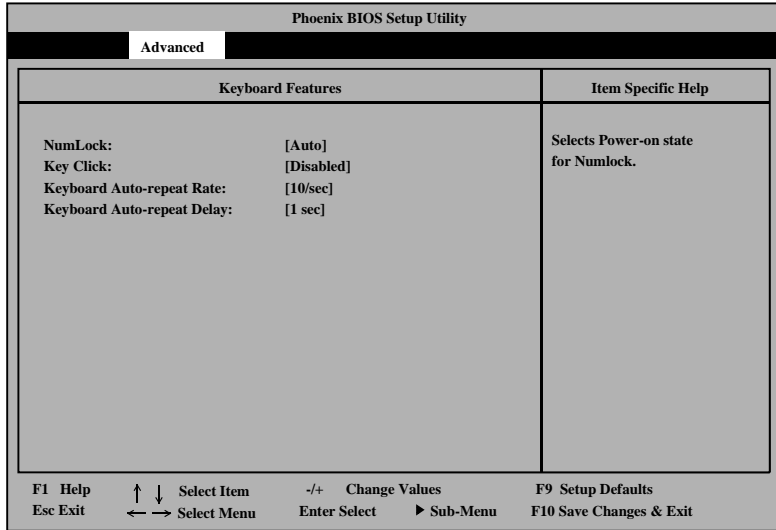

See the table below for setup options on the screen.

Option	Parameter	Description	Your Setting
NumLock	[Auto] On Off	Enable or disable the NumLock feature at system start-up. If "Auto" is selected, the NumLock feature will be enabled when an entry with the keypad is detected.	
Key Click	[Disabled] Enabled	Enable or disable the key click sound.	
Keyboard Auto-repeat Rate	2/sec 6/sec [10/sec]	Select the number of characters repeatedly output in one second when a key is pressed.	
Keyboard Auto-repeat Delay	0.25 sec 0.5 sec 0.75 sec [1 sec]	Select a period before a key character starts repeated.	

[]: Factory-set

Security

Move the cursor onto "Security" to display the Security menu.

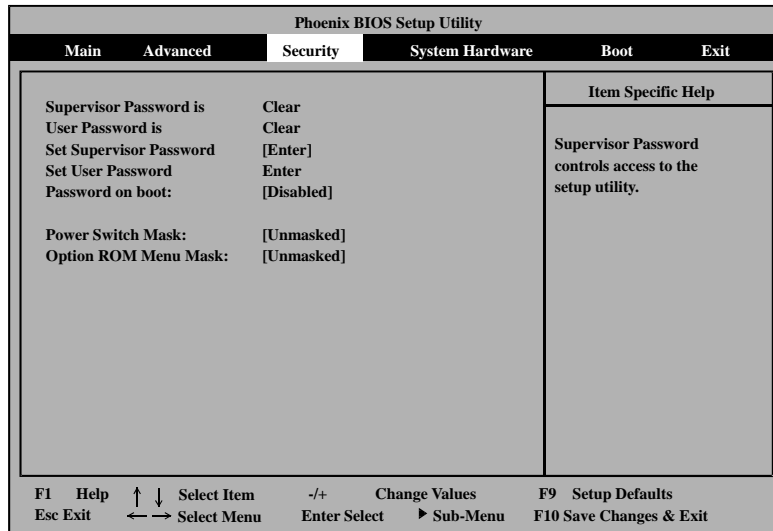

Select "Set Supervisor Password" or "Set User Password" and press **Enter** to display the following pop-up screen.

The screen below shows when "Set Supervisor Password" is selected.

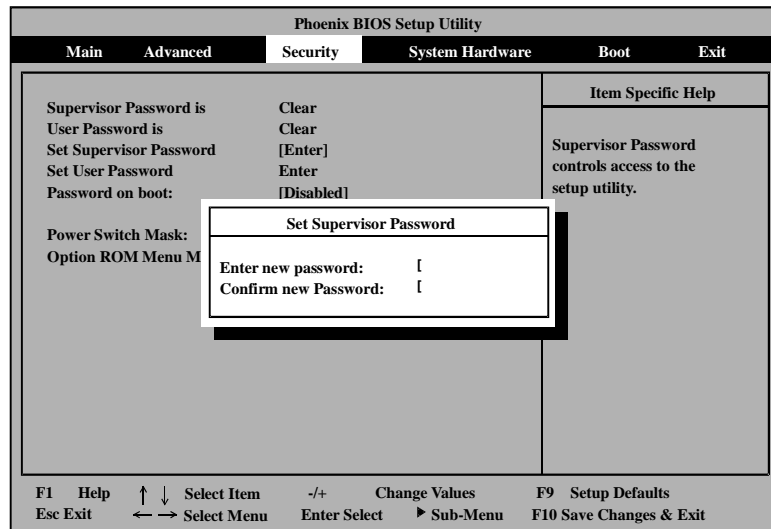

Set a password on this pop-up screen. Enter a password of up to seven alphanumeric characters and symbols from the keyboard.

IMPORTANT:

- User password setup is not available before Supervisor password setup.
- Do not set any password before installing the OS.

See the table below for setup options on the screen.

Option	Parameter	Description	Your Setting
Supervisor Password is	[Clear] Set	Indicates Supervisor password setup status (view only).	
User Password is	[Clear] Set	Indicates User password setup status (view only).	
Set Supervisor Password	Up to 7 alphanumeric characters	Press Enter to display the supervisor password entry screen. With the supervisor password, all SETUP menus are available for access. This option is available only when you log into the SETUP utility with the supervisor password.	
Set User Password	Up to 7 alphanumeric characters	Press Enter to display the user password entry screen. With a user password, accessing the SETUP menus is restricted. This option is available only if the Supervisor Password is specified.	
Password on boot	Enabled [Disabled]	Specify whether to request a password entry at boot-up. Supervisor password setup is required beforehand. When the supervisor password is specified and this option is disabled, the BIOS assumes that a system boot attempt is made by a user.	
Power Switch Mask	[Unmasked] Masked	Enable or disable the POWER switch on the server. If "Masked" is selected, power-off with the POWER switch becomes unavailable after OS boot-up. (Forced shut down also becomes unavailable. Forced shut down is a feature to shut down by pressing the POWER switch for over four seconds.)	
Option ROM Menu Mask	[Unmasked] Masked	Enable or disable key entries during optional ROM expansion.	

[]: Factory-set

System Hardware

Move the cursor onto "System Hardware" to display the System Hardware menu.

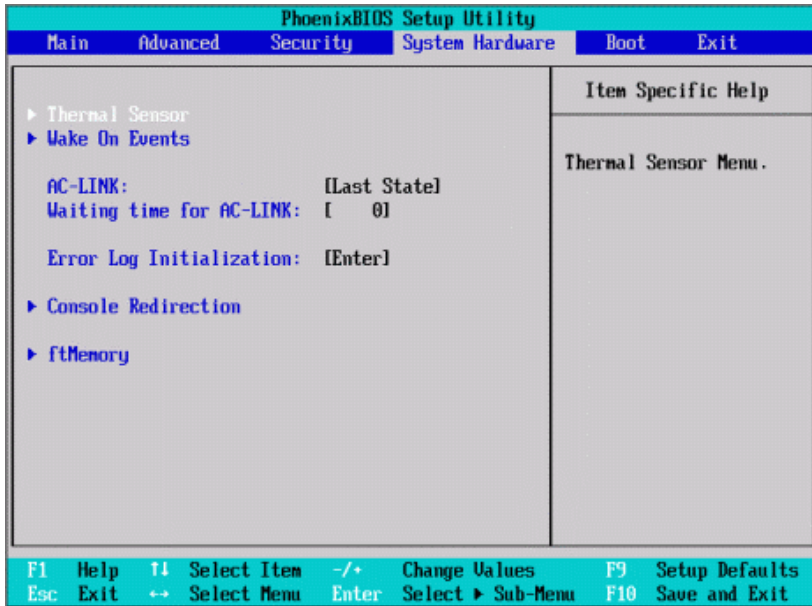

To make a selection for "Thermal Sensor", "Wake On Event", "Console Redirection" and "ftMemory", first select a desired option and press **Enter** to display its submenu.

See the table below for setup options on the screen.

Option	Parameter	Description	Your Setting
AC LINK	Stay Off [Last State] Power On	Specify the AC LINK feature by selecting the status of the power supply unit of the server when the AC power supply restarts. (See the table on the next page for details.)	
Waiting time for AC-LINK	[0], 10 - 3600	Set maximum waiting time in second for AC-LINK. If either of ACs is not supplied in time, the system will be turned on as simplex config. Value 0 means the system waits eternally. Range [0 or 10-3600sec.]	
Error Log Initialization	Enter	Press Enter to initialize the error log. The message "Error Log Cleared" appears upon successful completion. If failed, the message "Error Log Not Cleared!" appears.	

[]: Factory-set

The table below lists how selections for "AC LINK" determine the power status of the server when the power supply to the server restarts.

State before powered off	Parameter		
	Stay Off	Last State	Power On
In service	Off	On	On
Out of service (DC power: Off)	Off	Off	On
Forced shutdown *	Off	Off	On

* Pressing the POWER switch for over four seconds shuts down the power to the server.

Thermal Sensor

Select "Thermal Sensor" on the System Hardware menu and press **Enter** to display the following screen.

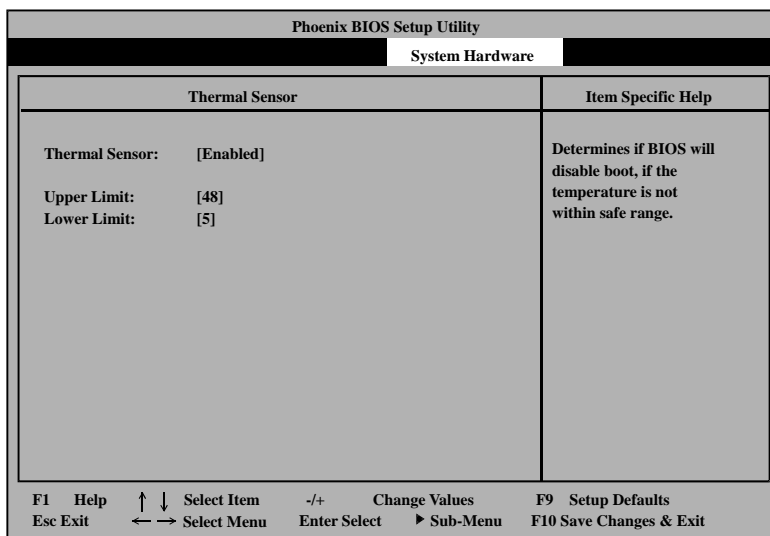

See the table below for setup options on the screen.

Option	Parameter	Description	Your Setting
Thermal Sensor	[Enabled] Disabled	Enable or disable the thermal sensor monitoring feature.	
Upper Limit	7 - [48] - 80	Specify the upper limit temperature for boot-up restriction in Celsius. Use + and/or - keys to specify a value by adding a number greater than 7 to the value specified for Lower Limit.	
Lower Limit	0 - [5] - 73	Specify the lower limit temperature for boot-up restriction in Celsius. Do not specify 4 degrees or lower. Use + and/or - keys to specify a value by deducting a number greater than 7 to the value specified for Upper Limit.	

[]: Factory-set

Wake On Events

Select "Wake On Events" on the System Hardware menu and press **Enter** to display the following screen.

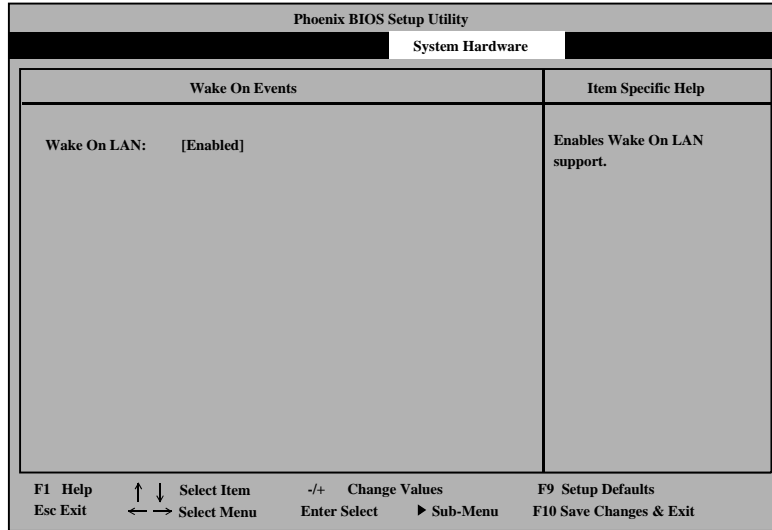

See the table below for setup options on the screen.

Option	Parameter	Description	Your Setting
Wake On LAN	Disabled [Enabled]	Enable or disable the remote power-on feature via the network.	

[]: Factory-set

IMPORTANT: You cannot use this feature on NEC Express5800/ft series (Linux model). Use the server without changing the factory settings.

Console Redirection

Select "Console Redirection" on the System Hardware menu and press **Enter** to display the following screen.

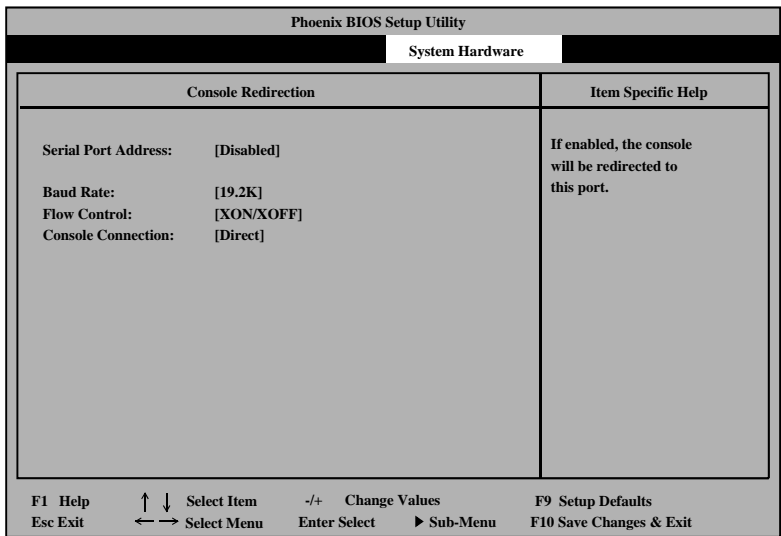

See the table below for setup options on the screen.

Option	Parameter	Description	Your Setting
Serial Port Address	[Disabled] On-board COM B	Select a serial port to connect the HW console. Selecting "On-board COM B" changes "Boot-time Diagnostic Screen" to "Enabled".	
Baud Rate	[19.2K] 57.6K	Select a baud rate for communications with the connected HW console.	
Flow Control	[None] XON/XOFF	Select a flow control method.	
Console Connection	[Direct] Via modem	Select a connection with the HW console.	

[]: Factory-set

ft Memory

Select "ft Memory" on the System Hardware menu and press **Enter** to display the following screen.

Phoenix BIOS Setup Utility		System Hardware
ft Memory		Item Specific Help
Size:	[0]	Select Size in MB for ft Memory.
Start Address:	11C0000h	
F1 Help ↑↓ Select Item ./+ Change Values F9 Setup Defaults Esc Exit ←→ Select Menu Enter Select ► Sub-Menu F10 Save Changes & Exit		

See the table below for setup options on the screen.

Option	Parameter	Description	Your Setting
Size	[0]	Size of ft Memory is specified (MB)	
Start Address	-	Shows the start address of ft Memory (view only)	

[]: Factory-set

IMPORTANT: You cannot use this feature on NEC Express5800/ft series (Linux model).
Use the server without changing the factory settings.

Boot

Move the cursor onto "Boot" to display the Boot menu.

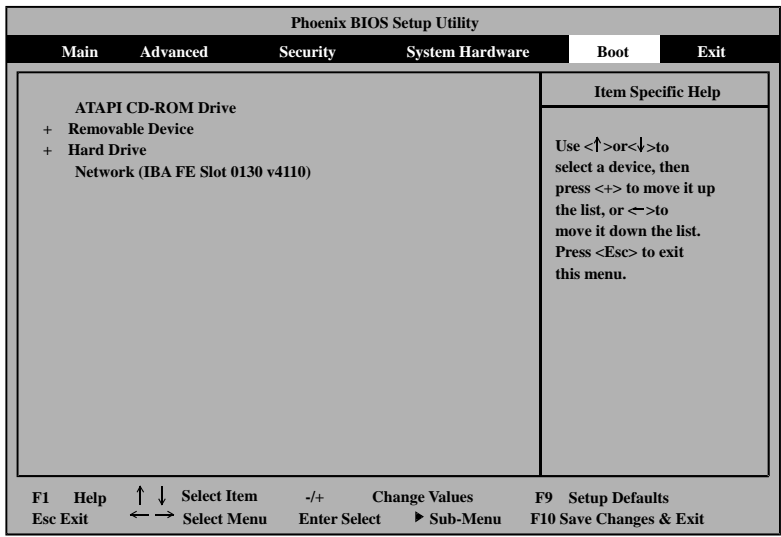

The server searches for the boot device according to the order specified in this menu and use the software to boot the system if found.

You can change the boot device order using ↑ or ↓ and + or -. Move the cursor to select the device by ↑ or ↓, and then change the priority using + or -.

IMPORTANT: Specify the device boot order as shown above to start the NEC EXPRESSBUILDER.

Exit

Move the cursor onto "Exit" to display the Exit menu.

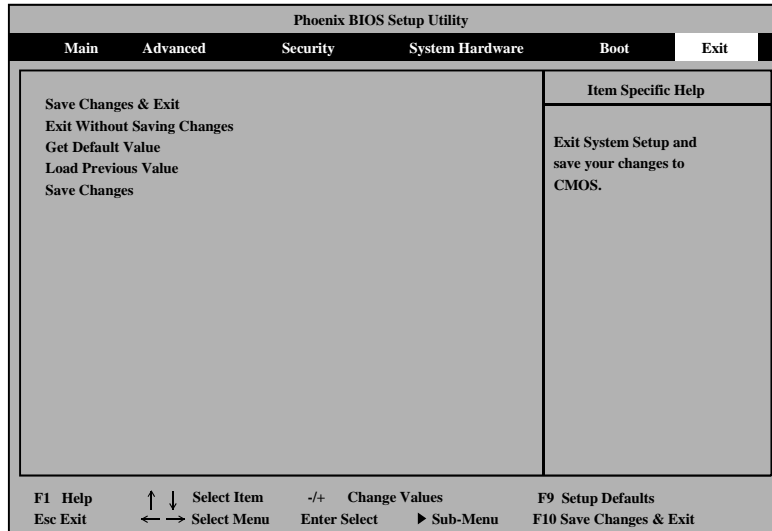

The following describes each option on the Exit menu:

- **Save Changes & Exit**

Select this option to save the current configuration data into the CMOS (non-volatile memory) and exit the SETUP utility.

The following screen appears:

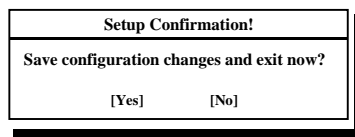

Select "Yes" to save the current configuration data into the CMOS (non-volatile memory) and exit the SETUP utility. The server will automatically restart the system.

- **Exit Without Saving Changes**

Select this option to discard the current configuration data and exit the SETUP utility.

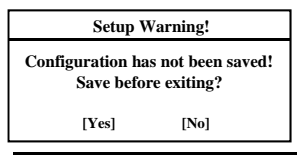

Select "No" to discard the current configuration data and exit the SETUP utility. Select "Yes" to save the current configuration data into the CMOS, to exit the SETUP utility, and to restart the server automatically.

- Get Default Value

Select this option to restore all default values (factory-set values) of the SETUP utility.

The following screen appears:

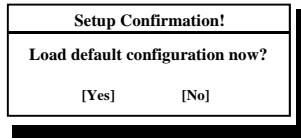

Select "Yes" to restore default values. Select "No" to return to the Exit menu screen.

IMPORTANT: The default value slightly differs from the factory-set value. Check all setting values before restoring the default value.

- Load Previous Values

Select this option to discard the current configuration data and restore the previous configuration data.

The following screen appears:

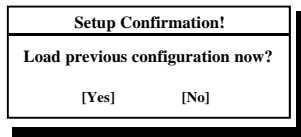

Select "Yes" to discard the current configuration data and restore the previous one.

- Save Changes

Select this option to save the current configuration data into the CMOS (non-volatile memory) and stay on the SETUP utility.

The following screen appears:

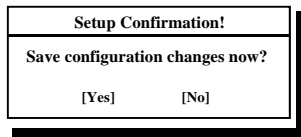

Select "Yes" to save the current configuration data into the CMOS (non-volatile memory).

SCSI BIOS ~ *FAST!UTIL* ~

For several settings of the SCSI controller on the motherboard, the SCSI BIOS utility "*Fast!UTIL*" is used.

The SCSI BIOS utility can be started by simple keystrokes during execution of POST without use of a special start disk.

The SCSI BIOS built in the server is set to the optimum at the shipment. Accordingly, the SCSI BIOS may not be changed by using this utility.

IMPORTANT:

- Leave the settings for the SCSI controller to which built-in hard disks are connected as they are at shipment. If any of the settings are changed, see the description in this document to return to the settings at shipment. The controllers installed in each module must be configured individually.
 - *Fast!UTIL* of the latest version is installed in the NEC Express5800/ft series. Accordingly, the setting screen may be different from that described in this document. See the online help or contact your sales agent for the setting items different from those in this document.
-

Start

The procedure of starting *Fast!UTIL* is described below.

Notes

Note the following before starting *Fast!UTIL*.

- Settings for built-in hard disk
 - Leave the settings for the built-in hard disk as they are at shipment. The built-in host adapter is specified as QLA12160 Ultra3 2000 in the Select Host Adapter dialog box.
- Settings of built-in SCSI controller installed in each group
 - Mount only the PCI module which has the built-in SCSI controller that you want to check the settings and start *Fast!UTIL*. Remove the other PCI module from the system.
 - Do not change the factory settings of the built-in SCSI controller.
 - Although there may be descriptions that the SCSI BIOS of the host adapter needs to be configured in manuals for tape devices, etc., this server does not require modifications to the settings. Do not change the settings.

Start Procedure

Start *Fast!UTIL* in the procedure below:

1. Turn on the power of the server.

The start message appears on a screen in the middle of POST.

2. Press **Q** and **Ctrl** together.

Fast!UTIL is started.

IMPORTANT: Press these keys before message "QLogic Adapter using IRQ number x" or later appears.

<Example>

```
QLogic Corporation
QLA 1216x PCI SCSI ROM BIOS Version X.XX
Copyright (C) QLogic Corporation 1993-2001 All rights reserved.
www.qlogic.com
Press <CTRL-Q> for Fast!UTIL
ISP12160 Firmware Version xx.xx.xx
QLogic Adapter using IRQ number X
```

Device Number	Device Type	Adapter Number	SCSI ID	SCSI LUN	Vendor ID	Product ID	Product Revision
81	Disk	0	0	0	SEAGATE	ST32550	7394

3. Highlight "Select Host Adapter" using the cursor keys and press **Enter**.

```
Fast!UTIL Options
Configuration Settings
Scan SCSI Bus
SCSI Disk Utility
Select Host Adapter
Exit Fast!UTIL
```

4. Select the proper adapter.

IMPORTANT: The adapter "QLA12160 Ultra3 2000" is used for built-in hard disk.
Do not select it.

Highlight the displayed item with the cursor keys and press **Enter**.

Adapter Type	I/O Address
QLA12160 Ultra3	2000
XXXXXXXXXXXXXXXXXXXXXXXXXXXX	XXXX
XXXXXXXXXXXXXXXXXXXXXXXXXXXX	XXXX

The display returns to "Fast!UTIL Options." The name of the selected host adapter appears at the upper left corner of the screen.

Configuration Settings
Scan SCSI Bus
SCSI Disk Utility
Select Host Adapter
Exit Fast!UTIL

Configuration Settings

If you select "Configuration Settings" from the "Fast!UTIL Options" menu, the screen for setting the configuration appears.

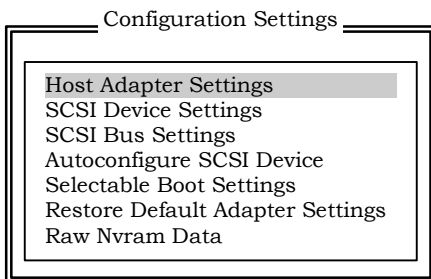

Host Adapter Settings

If you put the cursor on "Host Adapter Settings" with keyboard cursors (↓ and ↑) in the "Configuration Settings" menu and press **Enter**, the screen for setting the information on the host adapter appears.

The table below shows the parameters of the setting items and their factory settings.

Submenu item	Parameter	Description
BIOS Address	-	View only
BIOS Revision	-	View only
Adapter Serial Number	-	View only
Interrupt level	-	View only
Host Adapter BIOS	[Enabled] Disabled	Specify whether the BIOS extension of the host adapter is enabled or disabled.
PCI Bus DMA Burst	[Enabled] Disabled	Specify whether the DMA burst transfer on the PCI bus is enabled or disabled.
CDROM Boot	Enabled [Disabled]	Specify whether the start from CD-ROM is enabled or disabled.
Adapter Configuration	[Auto] Manual Safe	Specify whether the adapter configuration is set automatically by BIOS, manually, or safely.
Drivers Load RISC	[Enabled] Disabled	Specify whether the load of RISC codes is enabled or disabled.
>4GByte Addressing	Enabled [Disabled]	Specify whether hard disks of 4 GB or larger is used or not.
Fast Command Porting	[Enabled] Disabled	Do not change the factory setting.

[]: Factory-set

SCSI Device Settings

If you put the cursor on "SCSI Device Settings" with keyboard cursors (↓ and ↑) in the "Configuration Settings" menu and press **Enter**, the screen for setting the information on the device connected to the host adapter appears.

The table below shows the parameters of the setting items and their factory settings.

IMPORTANT: The settings can be made for each SCSI bus.

Submenu item	Parameter				Description
	SCSI Bus0		SCSI Bus1		
Disconnects OK	[Yes] No*	[Yes] No	[Yes] No	[Yes] No	Specify whether the disconnection of SCSI devices from the SCSI bus is enabled or disabled. * On Bus0, select "No" for ID8.
Check Parity	[Yes] No	[Yes] No	[Yes] No	[Yes] No	Specify whether the parity check is provided or not.
Enable LUNs	[Yes] No	[Yes] No	[Yes] No	[Yes] No	Specify whether more than one LUN numbers are given to SCSI ID.
Enable PPR	[Yes] No	[Yes] No	[Yes] No	[Yes] No	Do not change the factory setting.
Enable Device	[Yes] No	[Yes] No	[Yes] No	[Yes] No	Do not change the factory setting.
Negotiate Wide	[Yes] No	[Yes] No	[Yes] No	[Yes] No	Specify whether the wide (32 bits) transfer is enabled or disabled.
Negotiate Synchronous	[Yes] No	[Yes] No	[Yes] No	[Yes] No	Specify whether the synchronous transfer is enabled or disabled.
Tagged Queuing	[Yes] No	[Yes] No	[Yes] No	[Yes] No	Do not change the factory setting.
Sync Offset	00, 02, 04, 06, 08, 10, 12, 14, 16, 18, 20, 22, [24]	00, 02, 04, 06, [08], 10, 12, 14, 16, 18, 20, 22, 24	00, 02, 04, 06, [08], 10, 12, 14, 16, 18, 20, 22, 24	00, 02, 04, 06, [08], 10, 12, 14, 16, 18, 20, 22, 24	Select the proper offset value in synchronous transfer.
Sync Period		Transfer Rate (Mbytes/sec)		Transfer Rate (Mbytes/sec)	Select the proper speed in synchronous transfer.
	[9]	160 (Ultra3 SCSI)	9	160 (Ultra3 SCSI)	
	10	80 (Ultra2 SCSI)	[10]	80 (Ultra2 SCSI)	
	12	40 (Ultra SCSI)	12	40 (Ultra SCSI)	
	25	20 (Fast SCSI)	25	20 (Fast SCSI)	
	40	12.5	40	12.5	
Exec Throttle	1, 4, 8, [16], 32, 64, 128, 255	1, 4, 8, [16], 32, 64, 128, 255	1, 4, 8, [16], 32, 64, 128, 255	1, 4, 8, [16], 32, 64, 128, 255	Do not change the factory setting.

[]: Factory-set

SCSI Bus Settings

If you put the cursor on "SCSI Bus Settings" with keyboard cursors (↓ and ↑) in the "Configuration Settings" menu and press **Enter**, the screen for setting the information on the SCSI bus of the host adapter appears.

The table below shows the parameters of the setting items and their factory settings.

IMPORTANT: The settings can be made for each SCSI bus.

Submenu item	Parameter		Description
	SCSI Bus0	SCSI Bus1	
SCSI Bus SCSI ID	0, 1, 2, 3, 4, 5, 6, [7], 8, 9, 10, 11, 12, 13, 14, 15	0, 1, 2, 3, 4, 5, 6, [7], 8, 9, 10, 11, 12, 13, 14, 15	Select the SCSI ID given to SCSI bus.
SCSI Bus Reset	[Enabled] Disabled	[Enabled] Disabled	Make the reset valid or invalid in SCSI buses.
SCSI Bus Reset Delay	0, 1, 2, 3, 4, [5], 6, 7, 8, 9, 10, 11, 12, 13, 14, 15	0, 1, 2, 3, 4, [5], 6, 7, 8, 9, 10, 11, 12, 13, 14, 15	Leave this item as factory-set.
SCSI Bus Termination	Auto High only Disabled [Enabled]	[Auto] High only Disabled Enabled	Set the termination resistance of SCSI bus.

[]: Factory-set

Autoconfigure SCSI Device

If you put the cursor on "Autoconfigure SCSI Device" with keyboard cursors (↓ and ↑) in the "Configuration Settings" menu and press **Enter**, the screen for setting the information on the device connected to the host adapter appears.

The parameters of the setting items and their factory settings are the same as those shown in the table for "SCSI Device Settings."

IMPORTANT:

- The settings can be made for each SCSI bus and SCSI ID. Check the SCSI ID of the target device before changing the settings.
- The factory settings are the same for both SCSI bus 0 and SCSI bus 1.
- The following items can be changed by setting "Adapter Configuration" in "Host Adapter Settings" to "Manual."
 - Enable Device
 - Enable LUNs
 - Negotiate Wide
 - Negotiate Sync
 - Tagged Queuing
 - Sync Offset
 - Sync Period
 - Exec Throttle

Selectable Boot Settings

If you put the cursor on "Selectable Boot Settings" with keyboard cursors (↓ and ↑) in the "Configuration Settings" menu and press **Enter**, the screen for setting the information on the start from the device connected to the host adapter appears.

Submenu item	Parameter	Description
Selectable SCSI Boot	Enabled [Disabled]	Specify whether the boot from SCSI device can be selected or not.
SCSI Bus	[0] 1	Select the bus to which the started SCSI device is connected.
SCSI Boot ID	[0], 1, 2, 3, 4, 5, 6, 7, 8, 9, 10, 11, 12, 13, 14, 15	Set the SCSI ID of the started SCSI device.
SCSI Boot Lun	[0], 1, 2, 3, 4, 5, 6, 7, 8, 9, 10, 11, 12, 13, 14, 15	Select the number of the LUN to which the started SCSI device is bound.

[]: Factory-set

Restore Default Settings

If you put the cursor on "Restore Default Settings" with keyboard cursors (↓ and ↑) in the "Configuration Settings" menu and press **Enter**, the display changes to the screen for returning the setting values to the default values.

IMPORTANT: The default values can be restored for each SCSI bus.

Raw Nvram Data

If you put the cursor on "Raw Nvram Data" with keyboard cursors (↓ and ↑) in the "Configuration Settings" menu and press **Enter**, the information on NvRAM installed in the host adapter is displayed in the hexadecimal format.

This function is provided to solve problems. The information cannot be edited.

Scan SCSI Bus

If you select "Scan SCSI Bus" from the "Fast!UTIL Options" menu, the list of devices connected to each SCSI bus is displayed in the order of SCSI IDs. The information to be displayed includes the device manufacturer, product name and firmware revision.

SCSI Disk Utility

If you select "SCSI Disk Utility" from the "Fast!UTIL Options" menu, the utility menu which is used to format or verify the connected SCSI devices appears.

IMPORTANT:

- Devices can be processed in each SCSI bus and SCSI ID. Be careful not to forget the selected bus and ID.
 - When performing low-level format, select [Advanced]-[Monitoring Configuration]-[Option ROM Scan Monitoring] and choose "Disabled" in BIOS setup utility. See "SYSTEM BIOS ~ SETUP ~" (page 4-2) for details of the setting.
 - The selection of "Continue With Format" in "Low- Level Format" causes all data in disks to be lost.
-

- Low-Level Format

Formats the device selected in "Continue With Format" physically. If you select "Do Not Format Disk," the previous menu appears again.

- Verify Disk Media

Verifies the device selected in "Continue With Verify." If you select "Do Not Verify Media," the previous menu appears again.

- Select Different Disk

Selects another SCSI device on the same SCSI bus.

Select Host Adapter

If you select "Select Host Adapter" from the "Fast!UTIL Options" menu, the list of the host adapters installed in the main system is displayed. Select an adapter to change its settings.

IMPORTANT: The adapter "QLA12160 Ultra3 2000" is used for built-in hard disk. Do not select it.

The utility menu, which is used to format or verify the connected SCSI devices, appears.

Exit *Fast!UTIL* ~ Termination and Storage of *Fast!UTIL* ~

After changing the settings, press **Esc** several times to display the "Fast!UTIL Options" menu. If you select "Exit Fast!UTIL" from the menu, the screen for terminating *Fast!UTIL* appears.

However, if the settings are different from those before the start, the screen prompting you to save the settings appears before the display of the termination screen.

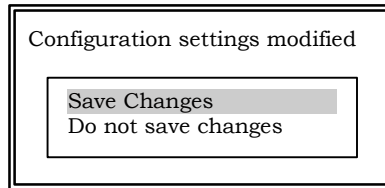

Select either "Save changes" or "Do not save changes" by using keyboard cursors (↓ and ↑) and press **Enter**.

Pressing **Enter** causes the screen for terminating *Fast!UTIL* to appear.

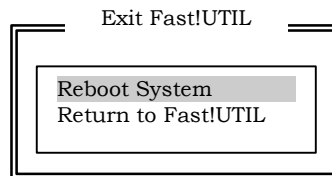

Select either "Reboot System" or "Return to Fast!UTIL" and press **Enter**.

Setting List for Optional SCSI Device

If you add an optional SCSI device, do not change the factory settings of built-in SCSI controller.

For information on optimal SCSI devices for NEC Express5800/ft series, contact your sales agent.

FORCED SHUTDOWN AND CLEAR

Read this section if your server does not operate as expected, or if you want to return all setup values to those made at shipment.

Forced Shutdown

Use this function when an OS command does not shut down the server, the POWER switch does not turn off the server, or resetting does not work.

Press and hold the POWER switch on the server for over four seconds. The power is forcibly turned off. To turn on the power back again, wait approximately 30 seconds after turning off the power (forced shutdown).

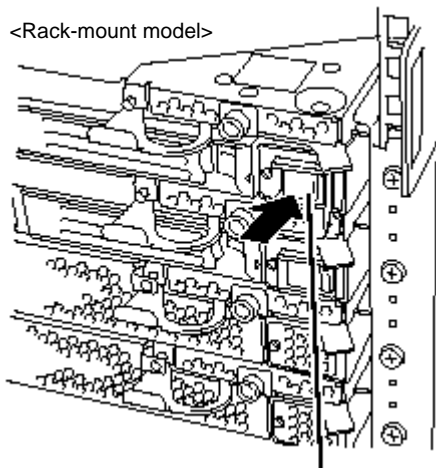

Press it for over 4 seconds.

Clear CMOS / Password (Configuring Motherboard Jumpers)

With the pre-installed SETUP utility, you can set desired passwords to protect data stored on the server from unauthorized user access. If you forget the passwords, you can clear them by following the procedure described in this section.

You can also use the same procedure to clear the CMOS data in the server.

IMPORTANT:

- Clearing the CMOS data restores the factory settings.
 - To clear passwords or CMOS data, power off the server.
-

To clear passwords or the CMOS data, use the jumper switch on the PCI module board of the server. The following figure illustrates the jumper switch location.

IMPORTANT: Do not change any other jumper switch settings. Any improper change may cause the server to fail or malfunction.

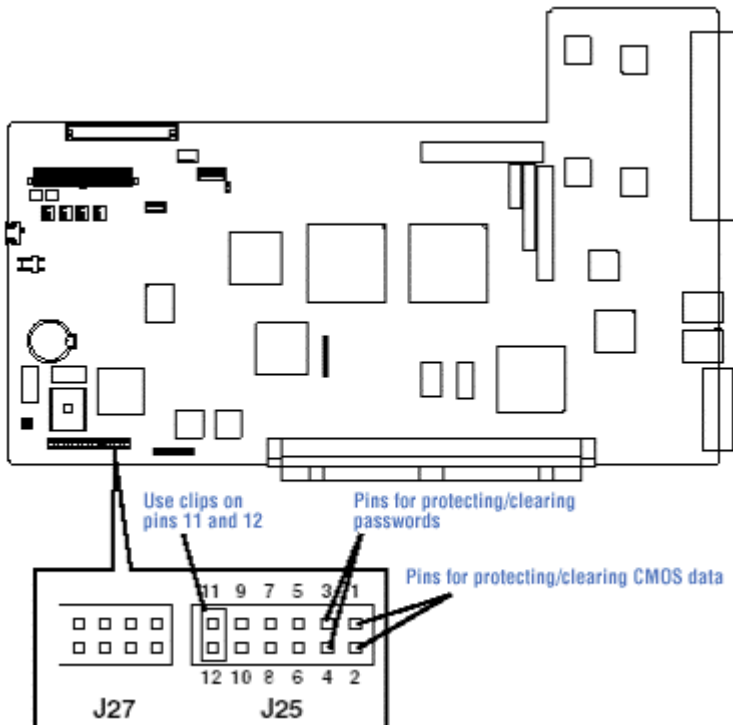

- Pins for protecting/clearing the passwords
Place the clip on the two pins to clear the passwords.
Remove the clip from these pins to protect the passwords (factory-set).
- Pins for protecting/clearing the CMOS data
Place the clip on the two pins to clear the CMOS data.
Remove the clip from these pins to protect the CMOS data (factory-set).

The following describe the clearing procedure.

⚠ WARNING	
	<p>Observe the following instructions to use the server safely. There are risks of death or serious personal injury. See PRECAUTIONS FOR SAFETY in Chapter 1.</p> <ul style="list-style-type: none">■ Do not disassemble, repair, or alter the server.

How to Clear CMOS

1. Power off the NEC Express5800/ft series and unplug the both power cords.
2. Remove the both PCI modules (#1 and #2) from the NEC Express5800/ft series (see page 8-31 “Removing PCI Module”).
3. Open the top cover of the PCI Module #1.
4. Make setting of jumper switch for clearing CMOS.
Remove the clips from the jumper pins 11-12 and place them on the jumper pins 1-2 on the PCI Module #1.
5. Mount only the PCI Module #1 to the NEC Express5800/ft series (see page 8-33 “Installing PCI Module”).
6. Plug the both power cords and when the POWER Switch LED turns on, press it to power on the server.
7. When the following message appears after startup, press [CONTINUE].



TIPS:

A message informing you of the completion of CMOS clear and prompting you to clear CMOS will appear for 10 seconds. Note that even if you do not do anything, the process goes on and the server will be rebooted automatically.

8. If the message [Non volatile memory cleared] appears after rebooting and during POST, turn off the power by pressing the POWER switch and unplug the both power cords.

```
Phoenix ServerBIOS Version 2.00 (PB 4:0, rel 6:20).
Copyright 1985-2001 Phoenix Technologies Ltd., All Rights Reserved.
NEC BIOS Version 1.0:0. (Express 5800/320Lb)
Copyright (c) 2000-2002 NEC Corporation, All Rights Reserved.

CPU2 PCI1 Module Present
CPU = 2 Intel(R) Xeon(TM) CPU 2.40GHz
Non volatile memory cleared
583K System RAM Passed
511M Extended RAM Passed
512K Cache SRAM Passed
System BIOS shadowed
Video BIOS shadowed
ATAPI CD-ROM: SR243T

Press <F2> to enter SETUP
```

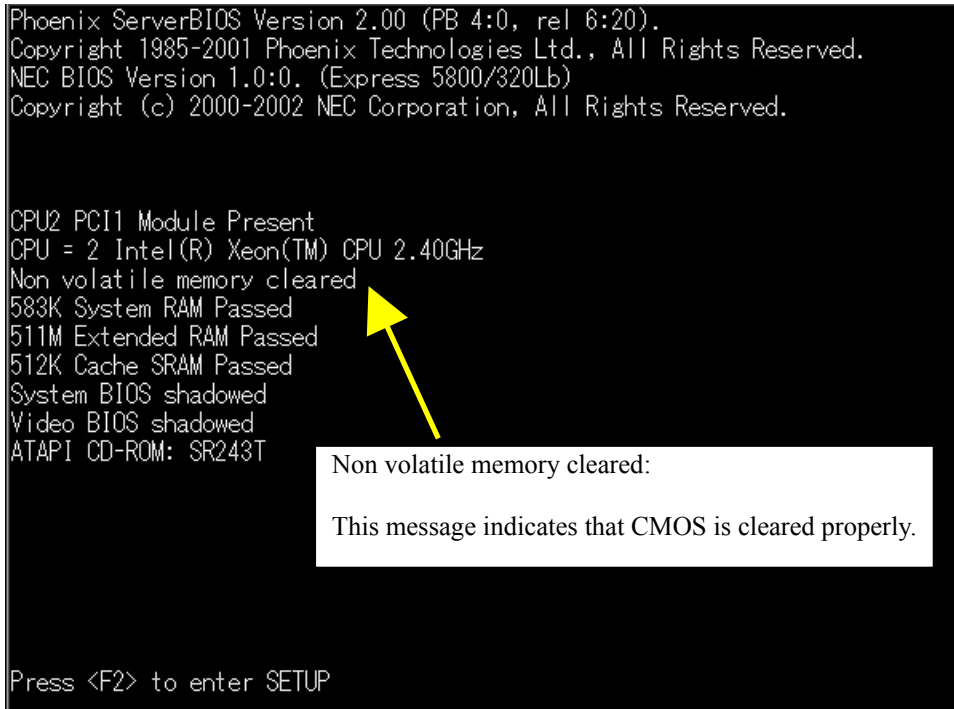
IMPORTANT:

If the message [Non volatile memory cleared] appears at normal startup, the jumper switch is set for clearing CMOS. Change back the jumper switch setting.

9. Remove the PCI Module #1 from NEC Express5800/ft series (see page 8-31 “Removing PCI Module”).
10. Reset the jumper switch setting.
Remove the clips from the jumper pins 1-2 and place them on the jumper pins 11-12 on the PCI Module #1.

TIPS: If you place clips on other pins, the server may malfunction.

11. Mount the PCI Module #1 again to NEC Express5800/ft series (see page 8-33 “Installing PCI Module”) and plug the power cord to the AC inlet B (for Group1).
12. Likewise, mount the PCI Module #2 to NEC Express5800/ft series and plug the power cord to the AC inlet A (for Group2).

- 13.** Shortly after you connect the both power cords, the BMC status LED of PCI Module #2 will start to blink.

When the BMC status LED goes off, the clear information of the PCI Module #1 is reflected to the PCI Module #2.

CHECK:

The BMC status LED blinks to show that synchronous processing is being performed between the two modules. When this process is complete, CMOS has also been cleared on PCI Module #2

TIPS:

- For the location of the AC inlet A, the AC inlet B, see “NAMES AND FUNCTIONS OF COMPONENTS” in Chapter 2.
 - For the location of the BMC status LED, see “NAMES AND FUNCTIONS OF COMPONENTS” in Chapter 2.
 - For description of the BMC status LED, see “LEDs” in Chapter 2.
-

How to Clear Passwords

1. Power off NEC Express5800/ft series and unplug the both power cords.
2. Remove the both PCI modules (#1 and #2) from the NEC Express5800/ft series (see page 8-31 “Removing PCI Module”).
3. Open the top cover of the PCI Module #1.
4. Make setting of jumper switch for clearing the password.
Remove the clips from the jumper pins 11-12 and place them on the jumper pins 3-4 on the PCI Module #1.
5. Mount the PCI Module #1 to NEC Express5800/ft series (see page 8-33 “Installing PCI Module”).
6. Plug the both power cords and when the POWER Switch LED turns on, press it to power on NEC Express5800/ft series.
7. When the following POST screen appears after the startup, press the POWER Switch to turn off the power.

```
QLogic Corporation
QLA1216x PCI SCSI ROM BIOS Version 7.32      SVID 159C
Copyright (C) QLogic Corporation 1993-2001. All rights reserved.
www.qlogic.com

Press <CTRL-Q> for Fast!UTIL      _

ISP12160 Firmware Version 10.04.31
QLogic adapter using IRQ number 5

Checking Adapter 0 SCSI Bus 0 SCSI ID 0
```

8. Unplug the both power cords.
9. Remove PCI Module #1 from NEC Express5800/ft series (see page 8-31 “Removing PCI Module”).
10. Reset the jumper switch setting.

Remove the clips from the jumper pins 3-4 and place them on the jumper pins 11-12 on the PCI Module #1.

TIPS: If you place it on other pins, the server may malfunction.

11. Mount the PCI Module #1 again to the NEC Express5800/ft series (see page 8-33 “Installing PCI Module”) and plug the power cord to the AC inlet B (for Group1). (The POWER Switch LED will be turned on.)
12. Likewise, mount the PCI Module #2 to the NEC Express5800/ft series and plug the power cord to the AC inlet A (for Group2).
13. Confirm that the BMC status LED on PCI Module #2 will start to blink shortly after you connect the both power cords.

When Password clear is completed, the BMC status LED will go off.

CHECK:

The BMC status LED blinks to show that synchronous processing is being performed between the two modules. When this process is complete, Password has also been cleared on PCI Module #2.

TIPS:

- For the location of the AC inlet A, the AC inlet B, see “NAMES AND FUNCTIONS OF COMPONENTS” in Chapter 2.
 - For the location of the BMC status LED, see “NAMES AND FUNCTIONS OF COMPONENTS” in Chapter 2.
 - For description of the BMC status LED, see “LEDs” in Chapter 2.
-

Chapter 5

Installing and Using Utilities

This section describes how to use the NEC EXPRESSBUILDER CD-ROM that comes with your server and to install the utilities stored on the NEC EXPRESSBUILDER.

NEC EXPRESSBUILDER

The NEC EXPRESSBUILDER, integrated setup software, can automatically detect the hardware connected to an NEC Express5800/ft series machine to advance the processing. The hardware subject to setup with the NEC EXPRESSBUILDER should have the same configuration as that for operation.

Start Menu

The NEC EXPRESSBUILDER provides three procedures to start the server as described below. The menus and items appearing on the screen vary depending on the procedures.

- Booting (starting) the server from NEC EXPRESSBUILDER CD-ROM

For the procedure, insert the NEC EXPRESSBUILDER CD-ROM into the CD-ROM drive of the NEC Express5800/ft series and start the NEC Express5800/ft series from the system in the NEC EXPRESSBUILDER. When the NEC Express5800/ft series is started by using this procedure, the NEC EXPRESSBUILDER top menu shown on the right appears.

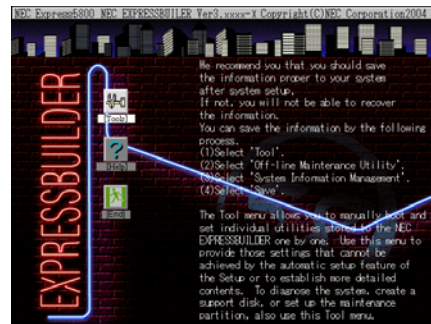

Perform the NEC Express5800/ft series setup from this menu.

IMPORTANT: Don't use this CD-ROM on computers other than NEC Express5800/ft series with which it is packaged (including other NEC Express5800 models). Otherwise, a breakdown may result.

See "NEC EXPRESSBUILDER Top Menu" for details.

- Booting (starting) the server from NEC EXPRESSBUILDER CD-ROM in the consoleless state

If the NEC EXPRESSBUILDER is started from the CD-ROM drive in the server with the keyboard, mouse, and/or display unit not connected to the server, the NEC EXPRESSBUILDER Tools Menu shown on the right appears on the screen of the management computer (PC) connected to the server through LAN or COM (serial port).

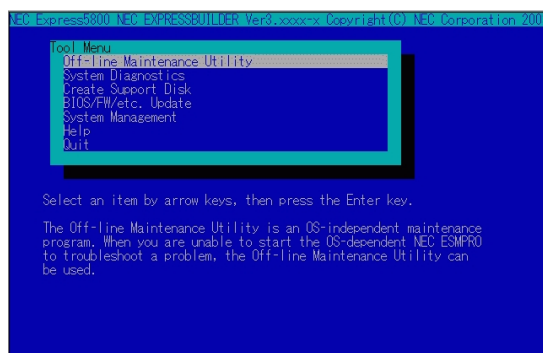

Then operate the server remotely from the management PC by using the items in the menu.

IMPORTANT:

- Don't use this CD-ROM on computers other than NEC Express5800/ft series with which it is packaged (including other NEC Express5800 models). Otherwise, a breakdown may result.
 - To use the consoleless feature, make sure that keyboard is not connected to the server. When a keyboard is connected, the consoleless feature is disabled because the NEC EXPRESSBUILDER determines that the server has a console. (The menu will not be displayed on the management PC.)
-

See "Consoleless Menu" described later for details.

- Inserting NEC EXPRESSBUILDER CD-ROM after Windows startup

The "Master Control Menu" (see figure below) starts automatically after you place the "NEC EXPRESSBUILDER" in the CD-ROM drive. A dialog box called "Master Control Menu" will appear.

For this dialog, see "Master Control Menu" described later.

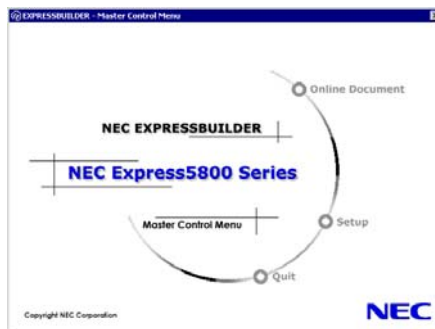

NEC EXPRESSBUILDER Top Menu

The NEC EXPRESSBUILDER top menu is used for the setup of hardware and the setup and installation of OS.

Start

Start the NEC EXPRESSBUILDER top menu following the procedure below:

1. Turn on the powers of peripherals and the power of the server in this order.
2. Insert the NEC EXPRESSBUILDER CD-ROM into the CD-ROM drive of the server.
3. After the CD-ROM is inserted, reset the system (by pressing **Ctrl + Alt + Delete**) or turn off the power and then on again to restart the server.

The system is activated from the CD-ROM to start the NEC EXPRESSBUILDER.

After the NEC EXPRESSBUILDER is started, the NEC EXPRESSBUILDER top menu shown below appears.

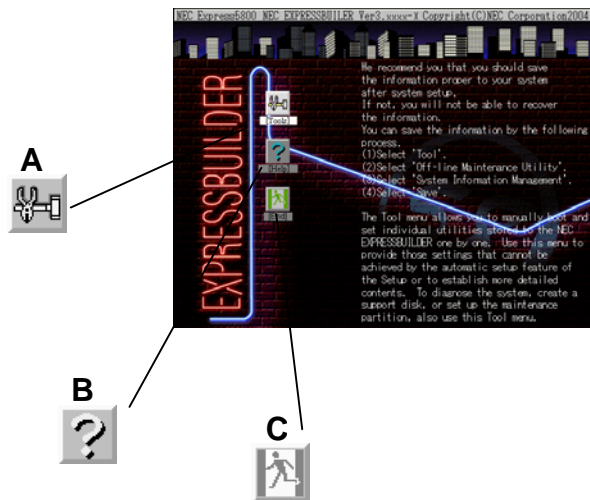

- A Tools**
Starts each of the utilities stored in the NEC EXPRESSBUILDER individually to allow the operator to provide setup. Enables the setup without influence of installed OS.
- B Help**
Describes the NEC EXPRESSBUILDER. We recommend you to read through the help before the setup.
- C Exit**
The NEC EXPRESSBUILDER termination screen appears.

Tools

The Tools Menu is used to start each of the several utilities stored in the NEC EXPRESSBUILDER CD-ROM individually for manual setup by operator. Use the Tools Menu to provide settings that the setup program cannot do automatically or detailed settings. Also use the Tools Menu when system diagnosis is performed or a support disk is created. The items in the Tools Menu are described below.

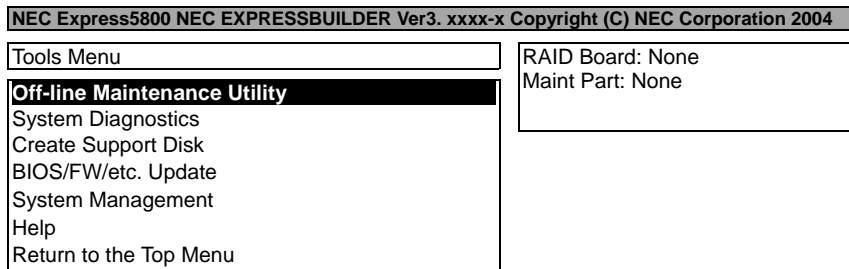

- Off-line Maintenance Utility

Off-line Maintenance Utility is an OS-dependent maintenance program that performs preventive maintenance and error analysis for your server. See Chapter 6 or the online help for details.

- System Diagnostics

Executes several tests on the main system to examine the features of the system and the connections between the system and extension boards. If the system diagnosis is executed, the system check program is started depending on the system status. See the description in Chapter 6 to manipulate the system check program

- Create Support Disk

In the support disk creation procedure, the starting support disk for starting a utility within the NEC EXPRESSBUILDER from a floppy disk and the support disk required in the installation of the operating system can be created. If you write down the titles appearing on the screen on the floppy disk labels, they can be easily managed later.

The customer should prepare the floppy disks for creating the support disks.

- ROM-DOS Startup FD
The support disk for starting the ROM-DOS system is created.
- Off-line Maintenance Utility FD
Creates a support disk for activating the Off-line Maintenance Utility.
- System Diagnostics Utility FD
The support disk for starting the system check program is created.
- System Management Function FD
The support disk for system management functions is created.

- BIOS/FW/etc. Update

The program which is necessary for the update work is transferred to the floppy disk which the various update modules of BIOS/FW were stored in. After the reboot, an update program is started automatically from the floppy disk, and various BIOS/FW's are updated.

IMPORTANT: During the execution of the update program, do not turn off the power of the system. If the update is interrupted halfway, the system will not be able to be started.

- System Management functions

Allow you to make settings of BMC (Baseboard Management Controller) to use its report functions and remote control from the management PC.

- Help

Indicates the descriptions on several features of the NEC EXPRESSBUILDER.

- Return to the Top Menu

Indicates the NEC EXPRESSBUILDER top menu.

Consoleless Menu

The NEC EXPRESSBUILDER contains the "consoleless" feature that enables configuration of the server by remote operation from the management PC, even if a console device such as keyboard is not connected to the server.

IMPORTANT:

- Don't use this CD-ROM on computers other than NEC Express5800/ft series with which it is packaged (including other NEC Express5800 models). Otherwise, a breakdown may result.
 - To use the consoleless feature, make sure that keyboard is not connected to the server. When a keyboard is connected, the consoleless feature is disabled because the NEC EXPRESSBUILDER determines that the server has a console. (The menu will not be displayed on the management PC.)
-

Starting

Depending on the connection between the management PC and the main unit, there are two ways for startup:

- Startup from the management PC connected to LAN
- Startup from the management PC directly connected (serial port B)

For startup procedures, see "Remote Management Configuration for the Server without Console" described later in this chapter.

IMPORTANT:

- Do not change the boot device order in the BOOT menu of BIOS SETUP. The consoleless feature cannot be used if the CD-ROM drive is not the first device to launch the system.
 - For LAN connection, you can only use LAN port 1.
 - For direct connection, you can only use Serial port B.
 - For consoleless remote operation of the NEC Express5800/ft series, you need to save configuration information to a floppy disk. Prepare a formatted floppy disk.
-

TIPS: BIOS will be set as follows:

- | | |
|------------------------|------------------|
| ■ RomPilot Support: | [Enabled] |
| ■ Serial Port B: | [2F8, IRQ3] |
| ■ Serial Port Address: | [On-board COM B] |
| ■ Baud Rate: | [19.2K] |
| ■ Flow Control: | [None] |
| ■ Console Connection: | [Direct] |
-

Menu Items

Only the menu items available in consoleless operation are extracted from the NEC EXPRESSBUILDER Top Menu. See the NEC EXPRESSBUILDER Top Menu described earlier for each function.

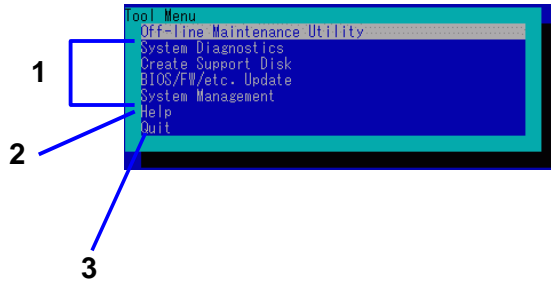

- 1 See the "NEC EXPRESSBUILDER Top Menu".
- 2 Shows detailed explanation of each function.
- 3 Terminate the NEC EXPRESSBUILDER.

IMPORTANT:

- The following functions differ from the Tools Menu in the NEC EXPRESSBUILDER Top Menu.
 - Contents and operations of System Diagnostics (see "System Diagnostics" in Chapter 6 for details.)
 - Disk type created in "Created Support Disk".
 - System Diagnostics Utility
When no keyboard is connected to the server, the System Diagnostic window is not displayed on the local console. Make sure to connect the keyboard to the server if you work on this utility from the local console.
-

Master Control Menu

Load the attached “NEC EXPRESSBUILDER” CD-ROM in the CD-ROM drive of the computer that runs Windows (Windows 95 or later, or Windows NT 4.0 or later). The Master Control Menu starts automatically.

TIPS: The Master Control Menu may not start automatically depending on the system status. In such case, execute the following file on the CD-ROM from the explorer, etc.

`\\MC\\1ST.EXE`

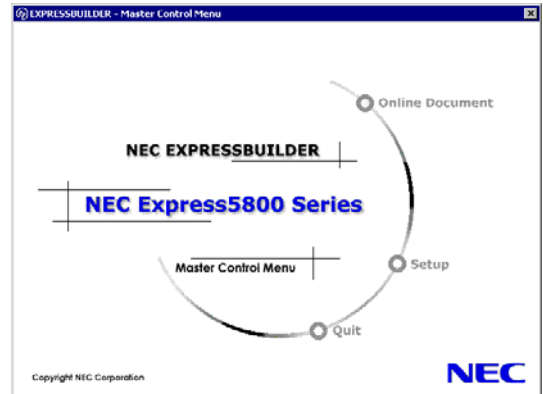

From the Master Control Menu, you can install various kinds of attached software that runs on Windows and view online documents.

TIPS: Some online documents are provided in the PDF format. To view these files, you need to install Acrobat Reader or Adobe Reader of Adobe Systems Incorporated in advance. If either is not installed, click [Setup] – [Acrobat Reader] first to install Acrobat Reader.

For the Master Control Menu operations, click each item displayed on the window, or use the shortcut menu displayed by right-clicking the screen.

IMPORTANT: Make sure to exit online documents and tools started from the Master Control Menu or menu before removing the CD-ROM from the CD-ROM drive.

NEC ESMPRO Agent and Manager

NEC Express5800/ft series system management applications "NEC ESMPRO Manager" is bundled to accessory CD-ROM "NEC EXPRESSBUILDER" and "NEC ESMPRO Agent" is bundled to Linux for NEC Express5800/ft series Back Up CD-ROM.

This manual describes the functions and features provided by NEC ESMPRO Manager and NEC ESMPRO Agent and the notes on their operations.

These applications are necessary for continuous operation of NEC Express5800/ft series.

Overview

NEC ESMPRO Manager and NEC ESMPRO Agent are the server management software provided for the stable operation of a server system and effective system operations. They can manage the configuration information and operating status of server resources to prevent server faults from occurring. If a server fault occurs, they detect the fault to notify the system Administrator of the occurrence. This enables the system Administrator to take appropriate action against faults.

■ Importance of server management

“Constantly stable operation” and “less management workload” are keywords in server management.

– Stable operation of server

Shutdown of a server immediately leads the customer to lose business opportunities and profits. This requires servers to always operate in their perfect state. If a fault occurs in a server, it is necessary to detect the occurrence as soon as possible, make clear the cause, and take appropriate action. The shorter the time taken from the occurrence of a fault to the recovery from the fault is, the smaller the loss of profits (and/or costs) is.

– Load reduction of server management

The server management requires many jobs. In particular, if the system becomes large or remote servers are used, required jobs increase further. The reduction of the load of the server management brings the decrease in costs (and thus customer's benefit).

■ What are NEC ESMPRO Manager and NEC ESMPRO Agent?

NEC ESMPRO Manager and NEC ESMPRO Agent are server management software used to manage and monitor NEC Express5800 series systems on the network. The installation of NEC ESMPRO Manager and NEC ESMPRO Agent enables the server configuration, performance, and fault information to be acquired, managed, and monitored realtime and also the occurrence of a fault to be detected immediately by the alert report function.

- Effects of using NEC ESMPRO Manager and Agent

NEC ESMPRO Manager and NEC ESMPRO Agent have sufficient effects on a variety of needs in versatile and complicated system environments.

- Detection of server fault

- NEC ESMPRO Agent collects a variety of fault information on NEC Express5800 series systems to identify the states of the systems. If a server detects a fault, the server provides NEC ESMPRO Manager with the proper alert report.

- Prevention of server fault

- NEC ESMPRO Agent includes the preventive maintenance function predicting the occurrence of a fault in advance as countermeasures for preventing faults from occurring. It can previously detect the increase in the cabinet temperature and the empty capacity in a file system.

- Management of server operation status

- NEC ESMPRO Agent can acquire the detailed hardware configuration and performance information on NEC Express5800 series systems. The acquired information can be viewed at any point through NEC ESMPRO Manager.

- Collective management of distributed servers

- NEC ESMPRO Manager provides the GUI interface that allows servers distributed on the network to be managed efficiently.

Detection of Server Fault

NEC ESMPRO Manager and NEC ESMPRO Agent detect errors causing faults to occur at an early stage and notify Administrators of fault information real-time.

- Early detection of error

If a fault occurs, NEC ESMPRO Agent detects the fault and reports the occurrence of the fault to NEC ESMPRO Manager (alert report). NEC ESMPRO Manager displays the received alert in the alert viewer and also changes the status colors of the server and server component in which the fault occurs. This allows you to identify the fault at a glance. Further, checking the content of the fault and the countermeasures, you can take appropriate action for the fault as soon as possible.

- Types of reported faults

The table below lists the typical faults reported by NEC ESMPRO Agent.

Component	Reported information
CPU	<ul style="list-style-type: none"> • CPU load is over the threshold • CPU degrading, etc.
Memory	ECC 1-bit error detection, etc.
Power supply	<ul style="list-style-type: none"> • Voltage lowering • Power failure, etc.
Temperature	Temperature increase in cabinet, etc.
Fan	Fan failure (decrease in the number of revolutions), etc.
Storage	File system usage rate, etc.
LAN	<ul style="list-style-type: none"> • Line fault threshold over • Send retry or send abort threshold over, etc.

Prevention of Server Fault

NEC ESMPRO Agent includes the preventive maintenance function forecasting the occurrence of a fault as countermeasures for preventing faults from occurring.

NEC ESMPRO Manager and NEC ESMPRO Agent can set the threshold for each source in the server. If the value of a source exceeds the threshold, NEC ESMPRO Agent reports the alert to NEC ESMPRO Manager.

The preventive maintenance function can be set for a variety of monitoring items including cabinet temperature, and CPU usage rate.

Management of Server Operation Status

NEC ESMPRO Agent manages and monitors a variety of components installed in the server. You can view the information managed and monitored by NEC ESMPRO Agent on the data viewer of NEC ESMPRO Manager.

NEC ESMPRO Agent also manages and monitors all the components and conditions required to keep the server reliability at a high level such as hard disks, CPU, memory, fans, power supply, and temperature.

Below is a list of functions of data viewer's items and their availability if NEC ESMPRO Agent is installed.

Function name	Supported	Function description
Hardware	○	Function to display physical information of hardware
Memory bank	○	Function to display physical information of memory
Device Information	○	Function to display device-specific information
CPU	○	Function to display physical information of CPU
System	○	Function to view logical information or monitor load rate of CPU Function to view logical information or monitor status of memory
I/O device	○	Function to view information of I/O devices (floppy disk drive, serial port, parallel port, keyboard, mouse and video)
System environment	△	Function to monitor temperature, fan, voltage, power, door, etc.
Temperature	○	Function to monitor the temperature inside the cabinet
Fan	○	Function to monitor fan
Voltage	○	Function to monitor the voltage inside the cabinet
Power	×	Function to monitor power unit
Door	×	Function to monitor the Chassis Intrusion (open/close of the cover/door on the cabinet)
Software	○	Function to view information of service, driver, OS
Network	○	Function to view information about network (LAN) and monitor packets
Extension device	○	Function to view information of extension bus device
BIOS	○	Function to view BIOS information
Local polling	○	Function to monitor any MIB item value which the agents get

Function name	Supported	Function description
Storage	×	Function to monitor storage devices (e.g., hard disk drive) and controller
File system	○	Function to view file system configuration and monitor usage rate
Disk array	×	Function to monitor disk array system of LSI Logic Corporation
Other	○	Supports OS stall monitoring by Watch Dog Timer

○: Supported △: Partly supported ×: Not supported

Monitoring of NEC Express5800/ft series

NEC Express5800/ft series is a fault tolerant system. It can continue the operation even if a major component fails. NEC Express5800/ft series improves the system availability with the hardware, NEC ESMPRO, and system software functions.

If a major component fails, the NEC ESMPRO fault report function can notify the system Administrator of the occurrence of the fault. In addition, the data viewer of NEC ESMPRO Manager can monitor the system status and also identify the failed component.

NEC ESMPRO provides several maintenance functions such as the update of F/W and BIOS in the NEC Express5800/ft series in the online state (in which the system continues the operation but the components used to update F/W or BIOS is suspended) and the suspension of a specific component.

The table below lists the NEC Express5800/ft series management tasks using NEC ESMPRO and system functions.

NEC Express5800/ft series management task	NEC ESMPRO function or tool (on managed NEC Express5800/ft series)	NEC ESMPRO function or tool (on management manager)
Monitoring of major component states	–	NEC ESMPRO Manager data viewer
Diagnosis and start/stop of major components and F/W update	NEC ESMPRO Agent ft server utility	NEC ESMPRO Manager data viewer
BMC F/W update	NEC ESMPRO Agent BMC F/W update utility	–
Confirmation of alert or confirmation of fault occurrence event information	syslog	NEC ESMPRO Manager Alert Viewer
Confirmation of H/W error log	NEC ESMPRO Agent	–

The report of a fault occurrence in the NEC Express5800/ft series (alert) is immediately sent to the NEC ESMPRO Manager. When the NEC ESMPRO Manager receives the alert, a popup message appears.

The alert contains the detailed information of the fault and the proper countermeasures. You can take the appropriate action for the alert.

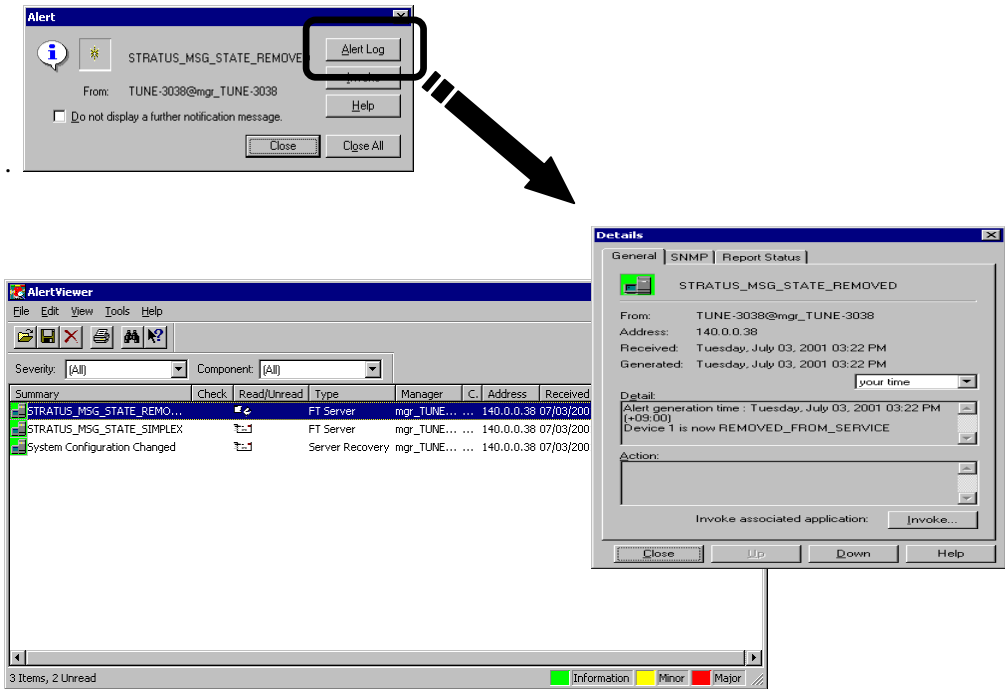

Collective Management of Distributed Servers

The excellent GUI provided by NEC ESMPRO Manager allows servers on a network to be managed collectively. The management screen is designed in the Explorer format to indicate the components in a server hierarchically for effective server management.

NEC ESMPRO Manager manages servers by using the following three types of GUIs.

- Operation Window

The operation window is used to create the map of servers connected to network to manage them. The map can be multi-layered depending on the installation areas, organizations, and objects.

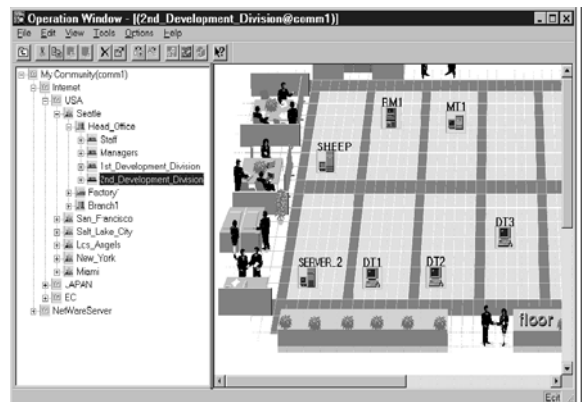

- Data Viewer

The data viewer indicates the server source configuration information in the Explorer format. In addition, it changes the status color of the failed server component. This enables you to identify the failed portion.

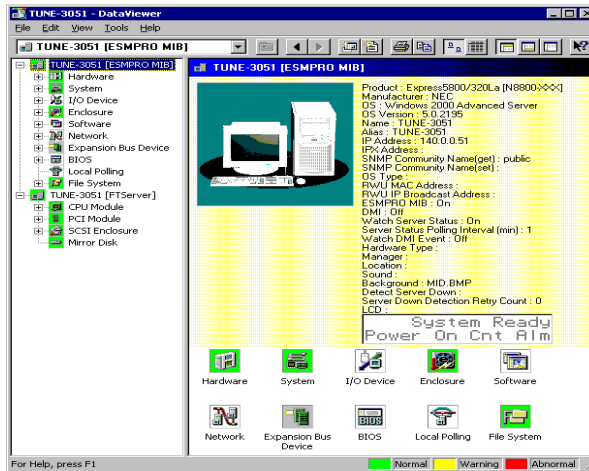

- Alert Viewer

The Alert Viewer manages fault reports sent from servers together. A fault occurred in a server is immediately reported to the Alert Viewer.

The Administrator can recognize all faults on the network instantly.

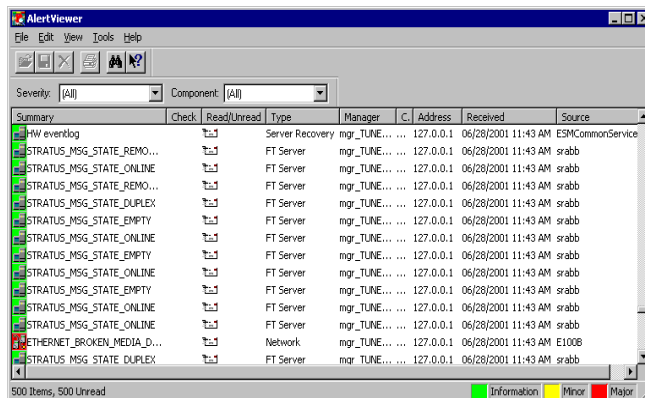

NEC ESM PRO Agent

Device ID in Alert Report

Some NEC Express5800/ft series reports use unique device IDs which correspond to the devices listed in the table below as the device identification information.

Device name	Device ID
CPU module 1	0
DIMM1 on CPU module 1	0/0
DIMM2 on CPU module 1	0/1
DIMM3 on CPU module 1	0/2
DIMM4 on CPU module 1	0/3
DIMM5 on CPU module 1	0/4
DIMM6 on CPU module 1	0/5
CPU1 on CPU module 1	0/20
CPU2 on CPU module 1	0/21
Power supply unit on CPU module 1	0/100
CPU module 3	2
DIMM1 on CPU module 3	2/0
DIMM2 on CPU module 3	2/1
DIMM3 on CPU module 3	2/2
DIMM4 on CPU module 3	2/3
DIMM5 on CPU module 3	2/4
DIMM6 on CPU module 3	2/5
CPU1 on CPU module 3	2/20
CPU2 on CPU module 3	2/21
Power supply unit on CPU module 3	2/100
PCI module 1	10
PCI slot 1 on PCI module 1	10/0
PCI slot 2 on PCI module 1	10/1
PCI slot 3 on PCI module 1	10/2
PCI slot 4 on PCI module 1	10/3
PCI slot 5 on PCI module 1	10/4
PCI slot 6 on PCI module 1	10/5
PCI slot 7 on PCI module 1	10/6
SCSI adapter 1 on PCI module 1	10/5
Ethernet Board 1 on PCI module 1	10/3
Ethernet Board 2 on PCI module 1	10/6
Power supply unit on PCI module 1	10/100
PCI module 2	11
PCI slot 1 on PCI module 2	11/0
PCI slot 2 on PCI module 2	11/1
PCI slot 3 on PCI module 2	11/2
PCI slot 4 on PCI module 2	11/3
PCI slot 5 on PCI module 2	11/4
PCI slot 6 on PCI module 2	11/5
PCI slot 7 on PCI module 2	11/6
SCSI adapter 1 on PCI module 2	11/5
SCSI bus 1 of SCSI adapter 1 on PCI module 2	11/5/0
Ethernet Board 1 on PCI module 2	11/3
Ethernet Board 2 on PCI module 2	11/6
Power supply unit on PCI module 2	11/100
SCSI enclosure 1	41
SCSI slot 1 on SCSI enclosure 1	41/1
SCSI slot 2 on SCSI enclosure 1	41/2
SCSI slot 3 on SCSI enclosure 1	41/3
Electronics 1 on SCSI enclosure 1	41/120
Power supply unit on SCSI enclosure 1	41/100

Device name	Device ID
SCSI enclosure 2	42
SCSI slot 1 on SCSI enclosure 2	42/1
SCSI slot 2 on SCSI enclosure 2	42/2
SCSI slot 3 on SCSI enclosure 2	42/3
Electronics 1 on SCSI enclosure 2	42/120
Power supply unit on SCSI enclosure 2	42/100

The figure below shows the actual locations of the device names displayed on the NEC ESMPRO screen. In the case of the tower model, modules are mounted vertically instead of horizontally.

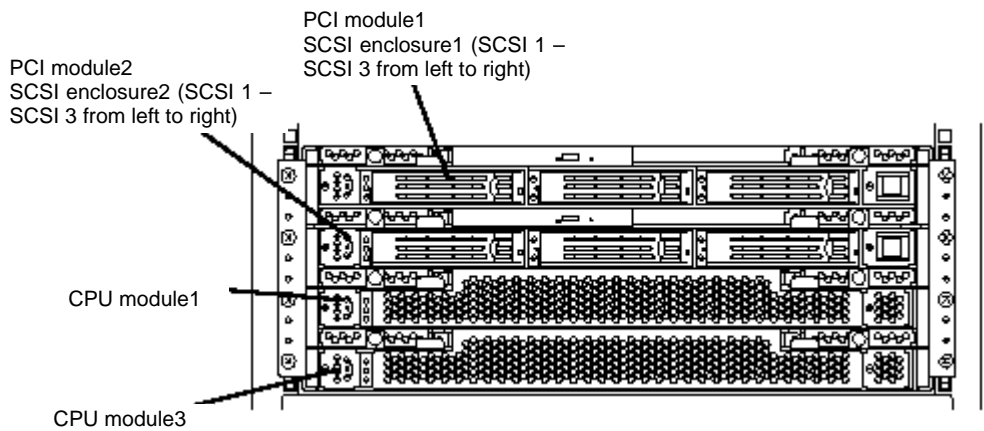

Supplement

Note the following when using NEC ESMPRO Agent.

Maintenance-related Functions

When you want to use maintenance-related functions of the NEC Express5800/ft series, contact your maintenance personnel.

Change of Installation States of CPU and PCI Modules

If you dynamically change the configuration of the CPU or PCI module in the relevant system during review of the server information by using the data viewer, the message prompting you to reconstruct the tree of the data viewer will appear. If you click the [Yes] button, the tree is reconstructed in the data viewer to reflect the change of the system configuration on the data viewer. Clicking the [No] button does not cause the tree to be reconstructed in the data viewer. If so, the information in the data viewer may be different from the current system information because the change of the system configuration is not reflected on the data viewer.

Impact When Module Status Changes

PCI modules, SCSI adapters, SCSI buses, and modules under the SCSI enclosure have impact on each other. For example, when the “Status” item of a module changes to “fault,” it may be caused by another module’s error. Therefore, you need to check the status of the other modules based on alert information.

Status Color after Mounting a Hard Disk

When creating a new mirror, the status of the hard disk and its upper component, SCSI enclosure, will continue to change frequently after you mount a hard disk until the mirror is completed. During this process, the status color may turn to abnormal, but when the mirror is created successfully, it will return normal.

LAN Monitoring Report

The LAN monitoring function defines the line status depending on the number of transmission packets and the number of packet errors within a certain period. Thus, the LAN monitoring function may report a line fault or high line load only in a temporary high line impedance state. If a normal state recovery is reported immediately, temporal high line impedance may have occurred thus there is not any problem.

Community Authority

Depending on your OS type or its version, settings for community, SNMP service’s security function, are not made, or default settings of authority are different

To enable the remote shutdown and threshold change functions via NEC ESMPRO Manager, make settings of community and set its authority to "READ CREATE" or "READ WRITE."

Temperature/Voltage/Fan Sensors Thresholds

The thresholds of temperature/voltage/fan sensors cannot be displayed or modified. However, depending on the model, only the thresholds can be displayed in the data viewer of NEC ESMPRO Manager. NEC ESMPRO Manager performs monitoring by using the optimum thresholds specified to each model.

Alert

Some detail information of alerts displayed on the alert viewer appears as "Unknown" depending on alerts.

Change Settings of File System Monitoring Function

New settings in thresholds of monitoring interval and free space monitoring are not reflected immediately after they are changed. They are reflected at the next monitoring interval of monitoring service.

Actions to Take When Temperature/Voltage Error Occurs on CPU/PCI Modules

At the time when a temperature or voltage error occurs on CPU/PCI module, necessary actions will differ depending on their status as shown below. You can check the status of each module from the data viewer of NEC ESMPRO Manager or ft server utility.

Status	Actions
Duplex	Stop the failed CPU/PCI module.
Simplex	Shut down the system.
Other than duplex or simplex	No action is required.

TIPS:

- If the status is "Empty," the module is not mounted. Sensor monitoring is not conducted.
 - If disks are mounted on PCI modules, the status of both modules is "Simplex" while the disks are mirrored. Temperature or voltage error occurring during disk mirroring will result in the system to shut down.
-

Shutdown Monitoring

When performing shutdown monitoring, all shutdown processes are to be monitored. If there are any applications which use shutdown process that does not require restarting the OS or turning off the power, specify a longer timeout period, or turn off the monitoring.

When [ft Server] Tree Appears on a Data Viewer in an Incorrect Manner

If you perform a Data Viewer startup or tree rebuilding just after the system starts up or after the PCI module starts up/shuts down, the [Ft Server] tree side may not appear normally on the Data Viewer. In this case, wait for 5 minutes before retrying a Data Viewer startup.

Information Displayed on a Data Viewer

Some information of the devices cannot be acquired due to the OS specifications. These devices are displayed as “Unknown” on the Data Viewer of the NEC ESMPRO Manager. Also, accurate information may not be acquired due to the OS specifications. In such case, accurate information may not be displayed.

Mirror Information of the SCSI Disk

The “Mirror disk” displayed on the [Ft Server] tree of the Data Viewer is always in gray. Also, “Unknown” is always displayed on the “Status” field.

Stopping the PCI Module by the ft server utility

When you stop the PCI module on the primary side by the ft server utility, the ft server utility screen may become blur temporarily. However, it returns to a normal status after a few seconds when the pop-up screen is displayed on the ft server utility. This will not cause a problem for the ft server utility functions.

About the display of a floppy disk drive

When a USB floppy disk drive is connected, the information on a floppy disk drive is not displayed on a data viewer.

NEC ESMPRO Manager

To monitor and manage a computer, on which NEC ESMPRO Agent is installed, with a management PC online, use NEC ESMPRO Manager that is bundled with the product.

For detailed procedures of installation and setting, see online documents or NEC ESMPRO Online Help.

TIPS: Online documents provide cautions and information for using NEC ESMPRO Manager. See *NEC ESMPRO Manager User's Guide* in the NEC EXPRESSBUILDER CD-ROM.

Monitoring by Use of Data Viewer

To monitor the state of the NEC Express5800/ft series on a management computer with installation of NEC ESMPRO Manager, the data viewer is used. If you click each of the modules and items to be checked sequentially on the tree view in the Windows Explorer format, the data viewer indicates their states on the right side of the screen.

You can manage the status on a Web browser using Web component functions of NEC ESMPRO Manager. For details, see Help on Web Component.

This section describes the tree structure and displayed screens in the data viewer.

To make the data viewer indicate the state of each module and those of the components on it, select the server to be monitored from NEC ESMPRO Manager to start the data viewer (in the following description, the start procedure of the data viewer is omitted).

Monitoring CPU Module

To monitor the CPU modules and the components on the CPU module, see the [CPU Module] tree. To see the information on the [CPU Module] tree, select the target CPU module from [CPU Module] in the [FTServer] tree.

You can see the following information on the modules and the components on the CPU modules in the [CPU Module] tree.

- General

Allows the configuration and other information on the CPU modules to be viewed.

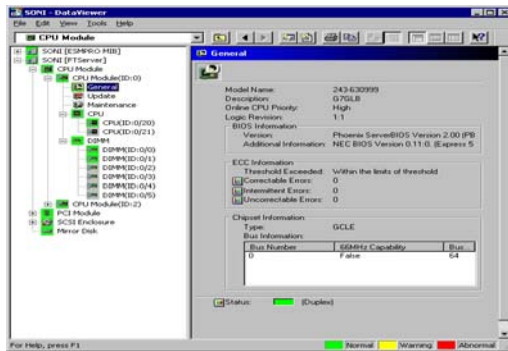

- Maintenance

Allows the start/stop, MTBF information clear, dump acquisition, and diagnosis of the CPU modules to be provided. See "Maintenance of NEC Express5800/ft series" described later for the start/stop and MTBF information clear of the CPU modules.

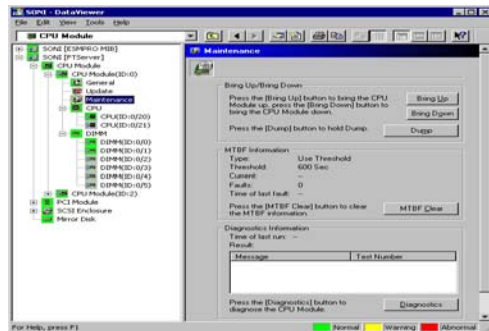

- Update

Allows the device identification information of the CPU modules to be viewed and BIOS of the CPU modules to be updated. See "Maintenance of NEC Express5800/ft series" described later for the update of BIOS of the CPU modules. The detailed device identification information can be checked by selecting [ESMPRO] tree→[Hardware] tree→[Field Replaceable Unit] tree.

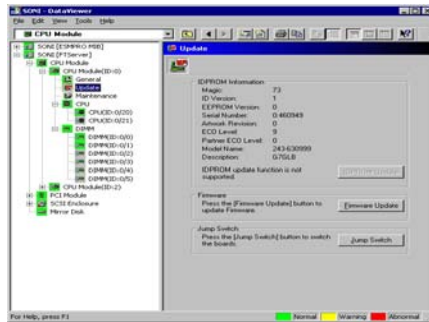

- CPU

Allows the information of the CPU on the CPU modules to be viewed.

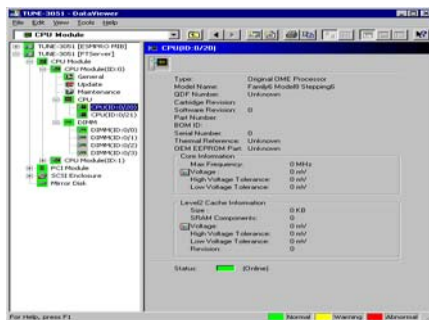

- DIMM

Allows the information of DIMM on the CPU modules to be viewed.

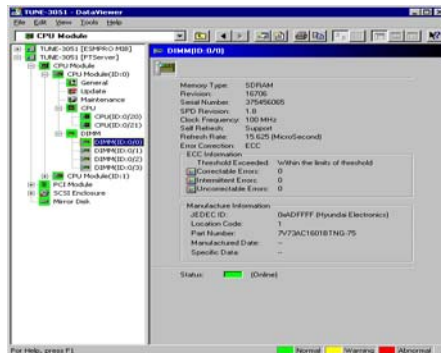

Monitoring PCI Module

To monitor the PCI modules and the components on the PCI modules, refer to the [PCI Module] tree. To see the information on the [PCI Module] tree, select the target PCI module from [PCI Module] in the [FTServer] tree.

You can see the following information on the PCI modules and the components on the PCI modules of the [PCI Module] tree.

(This section describes the general information screens of the PCI modules. The components on the PCI modules are described later.)

- General

Allows the configuration and other information of the PCI modules to be viewed.



- Maintenance

Allows the start/stop, MTBF information clear, and diagnosis of the PCI modules to be provided. See "Maintenance of NEC Express5800/ft series" described later for the start/stop and MTBF information clear of the CPU modules.



- Update

Allows the device identification information of the PCI modules to be viewed. The detailed device identification information can be checked by selecting [ESMPRO] tree→[Hardware] tree→[Field Replaceable Unit] tree.



Monitoring PCI Slots and Devices on PCI Module

To monitor the PCI slots and devices on the PCI modules, see the [PCI slot] tree. To see the information on the [PCI slot] tree, select [PCI Module]→[PCI module (containing PCI slot to be seen)]→[PCI slot] of the [FTServer] tree.

You can see the following information on the PCI slot and the devices on the PCI slot in the [PCI slot] tree.

- General

Allows the PCI slot configuration information to be viewed.

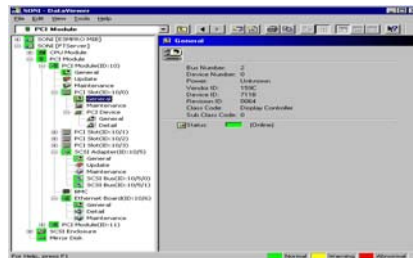

- Maintenance

Allows a device on the PCI slot to be started. This function is not supported in the current version.

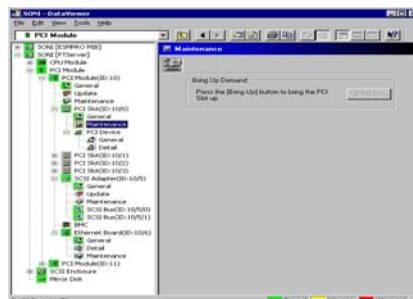

- PCI Device – General

Allows the information of devices on the PCI slot to be viewed.



- PCI Device – Detailed information

Allows the detailed information of a device on the PCI slot to be viewed.

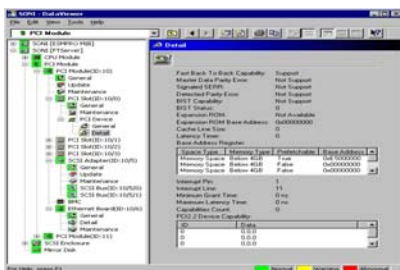

Monitoring SCSI Adapter on PCI Module

To monitor the SCSI adapter on the PCI modules, see the [SCSI adapter] tree. To see the information on the [SCSI adapter] tree, select [PCI Module]→[PCI module (to which the SCSI adapter to be viewed is connected)]→[SCSI adapter] of the [FTServer] tree.

You can see the following information of the SCSI adapter in the [SCSI adapter] tree.

- General

Allows the configuration and other information of the SCSI adapter to be viewed.

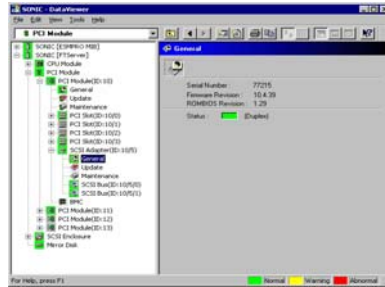

- Maintenance

Allows the MTBF information of the SCSI adapter to be viewed or cleared.

See "Maintenance of NEC Express5800/ft series" described later for clearing the MTBF information of the SCSI adapter.

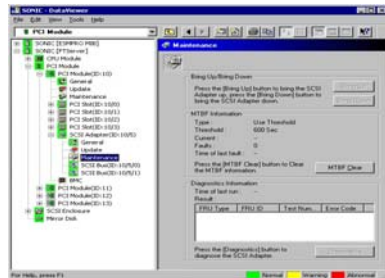

- Update

Allows the firmware of the SCSI adapter to be updated.

However, this function is not supported in the current version.

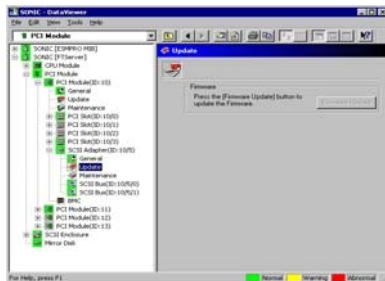

Monitoring BMC on PCI Module

To monitor the base management controller (BMC), controller for system management, on the PCI modules, see the [BMC] tree. To see the information on the [BMC] tree, select [PCI Module]→[PCI module (containing BMC to be seen)]→[BMC] of the [FTServer] tree.

You can see the BMC F/W version and other information in the [BMC] tree.



Monitoring Ethernet Adapter on PCI Module

To monitor the Ethernet adapter on the PCI modules, see the [Ethernet adapter] tree. To see the information on the [Ethernet adapter] tree, select [PCI Module]→[PCI module (connected with Ethernet adapter to be seen)]→[Ethernet adapter] of the [FTServer] tree. You can see the following information of the Ethernet adapter from the [Ethernet adapter] tree.

- General

Allows the configuration and other information of the Ethernet adapter to be viewed.



- Detailed

Allows the detailed statistic and other information of the Ethernet adapter to be viewed.

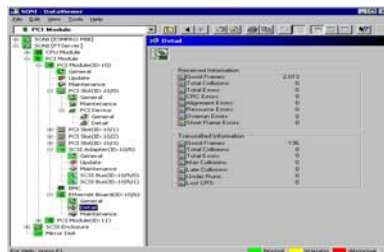

■ Maintenance

Allows the MTBF information of the Ethernet adapter to be viewed or cleared. See "Maintenance of NEC Express5800/ft series" described later for clearing the MTBF information on the Ethernet adapter.

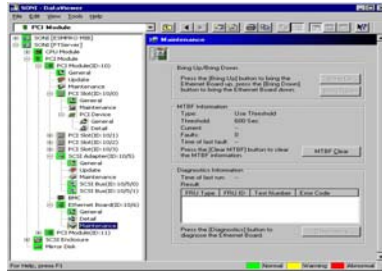

Monitoring SCSI Enclosure

To monitor the SCSI enclosure, see the [SCSI enclosure] tree. To see the information on the [SCSI enclosure] tree, select [SCSI enclosure] of the [FTServer] tree.

You can see the following information of the SCSI enclosure from the [SCSI enclosure] tree.

- General

Allows the configuration and other information of the SCSI enclosure to be viewed.

IMPORTANT: You need to be aware that PCI modules, SCSI adapters, SCSI buses, and modules under the SCSI enclosure have impact on each other. For details, see “Impact When Module Status Changes” in “supplement”.

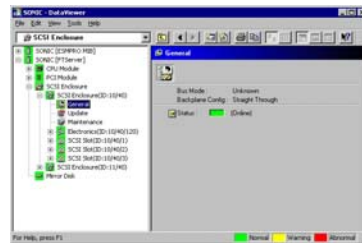

- Maintenance

Allows the MTBF information of the SCSI adapter to be viewed or cleared.

See "Maintenance of NEC Express5800/ft series" described later for clearing the MTBF information on the SCSI enclosure.



- Update

Allows the firmware of the SCSI enclosure to be updated.

However, this function is not supported in the current version.

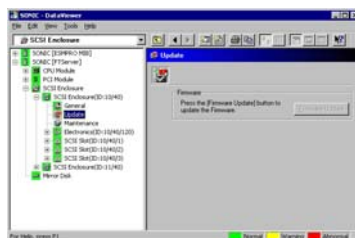

■ Electronics – General

Allows the configuration and other information of the SCSI enclosure electronics to be viewed.

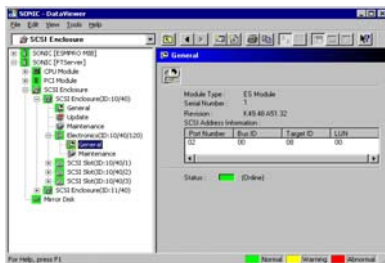

■ Electronics – Maintenance

Allows the MTBF information of the SCSI enclosure electronics to be viewed or cleared.

See "Maintenance of NEC Express5800/ft series" described later for clearing the MTBF information on the SCSI electronics enclosure.

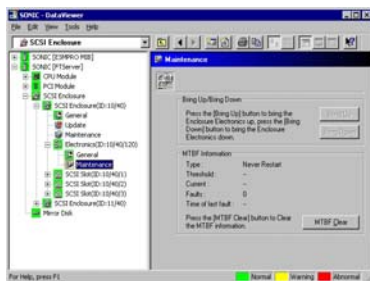

■ SCSI Slot – General

Allows the configuration and other information of the SCSI slot to be viewed.

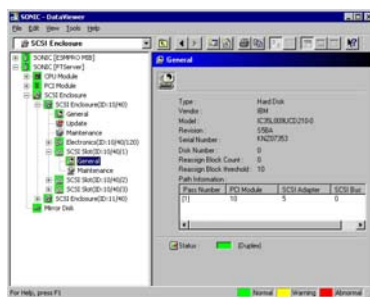

IMPORTANT: You need to be aware of the status of hard disk during the mirror creation. For details, see “Status Color after Mounting a Hard Disk” in “Supplement”.

- **SCSI Slot – Maintenance**

Allows the MTBF information of the SCSI slot to be viewed or cleared.

See "Maintenance of NEC Express5800/ft series" described later for clearing the MTBF information on the SCSI slot.

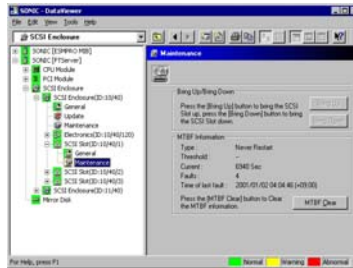

Monitoring Mirror Disk

To monitor the mirror disk components, see the [Mirror Disk] tree. To view information on [Mirror Disk] tree, select [Mirror Disk] under [FTServer] tree.

You can see the redundancy status of the mirrors and the device IDs of the SCSI slots into which these hard disk components are connected.

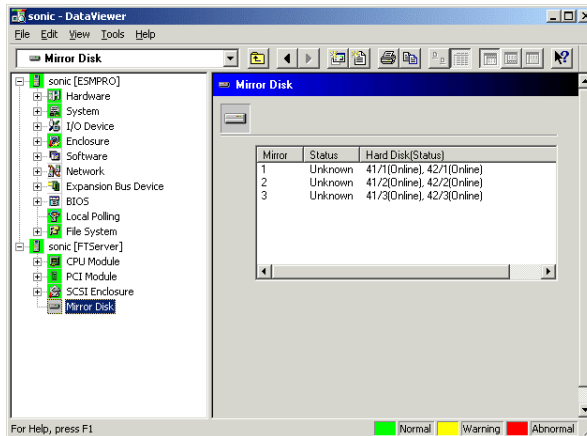

[Mirror Disk]

Maintenance of NEC Express5800/ft series

NEC Express5800/ft series maintenance can be done in two ways; one is to use NEC ESMPRO Manager for remote maintenance and the other is to use the NEC ESMPRO Agent ft server utility on the NEC Express5800/ft series for local maintenance.

TIPS: The following explains how to start NEC ESMPRO Agent ft server utility installed on NEC Express5800/ft series.

1. Move to the location where NEC ESMPRO Agent is installed.
 If the installation destination is not specified, /opt/nec/esmpro_sa is the destination.
 In this description, /opt/nec/esmpro_sa is assumed as the installation destination.
2. Move to the location where ft server utility is stored.

```
cd bin
```
3. Start the tool.

```
./ESMftutil
```

The maintenance functions that can be executed from NEC ESMPRO include three types, those common to all components, those specific to particular components, and general system settings.

The maintenance functions common to all components are operated in the same way basically (the operation procedure and typical examples of screen images are described below).

The table below lists the maintenance functions common to all components.

Component	Start		Stop		MTBF clear		Diagnosis		F/W update	
	R	L	R	L	R	L	R	L	R	L
CPU module	√	√	√	√	√	√	-	-	-	√
PCI module	√	√	√	√	√	√	-	-	-	-
PCI slot	-	-	-	-	-	-	-	-	-	-
Ethernet adapter	-	-	-	-	√	√	-	-	-	-
SCSI adapter	-	-	-	-	√	√	-	-	-	-
SCSI enclosure	-	-	-	-	√	√	-	-	-	-
SCSI electronics	-	-	-	-	√	√	-	-	-	-
SCSI slot	-	-	-	-	√	√	-	-	-	-

- R: Remote. Executable from remote management PC by using NEC ESMPRO Manager
- L: Local. Executable on local server by using ft server utility
- √: Support
- : Not support

The table below shows the component-specific maintenance functions executable from NEC ESMPRO.

Component	Dump acquisition		Dump acquisition during system operation		Board switch	
	R	L	R	L	R	L
CPU module	–	–	√	√	–	–

R: Remote. Executable from remote management PC by using NEC ESMPRO Manager

L: Local. Executable on local server by using ft server utility

√: Support

–: Not support

Component	BMC firmware update	
	R	L
BMC	–	√

R: Remote. Executable from remote management PC by using NEC ESMPRO Manager

L: Local. Executable on local server by using ft server utility

√: Support

–: Not support

The table below shows the support of the whole system setup functions.

Component	Quick dump		Auto firmware update		Auto module start	
	R	L	R	L	R	L
Whole system	–	√	–	√	–	√

R: Remote. Executable from remote management PC by using NEC ESMPRO Manager

L: Local. Executable on local server by using ft server utility

√: Support

–: Not support

Start and Stop of Components

To start or stop a component with NEC ESMPRO Manager, use the [Maintenance] tree of the component in the [FTServer] tree of the data viewer. Open the tree of the component to be started or stopped and select the [Maintenance] tree.

To start or stop a component with the ft server utility, use the utility screen of the component.

The table below shows the potential cases in which a component is to be started or stopped.

Component	Start		Stop	
	Remote	Local	Remote	Local
CPU Module	<p>When the cause of down is reviewed and the system is restarted in module down state.</p> <p>Executable in any of the following module states (this can be viewed on manager screen):</p> <ul style="list-style-type: none"> • Removed • Broken • Shot • Firmware Update Complete • Diagnostics Passed 	<p>When the cause of down is reviewed and the system is restarted in module down state.</p> <p>Executable in the following module state:</p> <ul style="list-style-type: none"> • When the status LED 1 is red and the status LED 2 is off <p>Only the status LED 1 illuminates red when the module is in one of the following states:</p> <ul style="list-style-type: none"> • Removed • Broken • Shot • Firmware Update Complete • Diagnostics Passed 	<p>When system is stopped forcibly due to replacement or malfunction of module.</p> <p>Executable in the following module state (this can be viewed on manager screen):</p> <ul style="list-style-type: none"> • Duplex 	<p>When system is stopped forcibly due to replacement or malfunction of module.</p> <p>Executable in the following module state:</p> <ul style="list-style-type: none"> • Only the green LED is on and in redundant configuration state <p>The both green LEDs are on when the module is in the following state:</p> <ul style="list-style-type: none"> • Duplex
PCI Module	Same as above	Same as above	Same as above	Same as above

Remote: Executable from remote management PC by using NEC ESMPRO Manager

Local: Executable on local server by using ft server utility

–: Not support

IMPORTANT: PCI modules, SCSI adapters, SCSI buses, and modules under the SCSI enclosure have impact on each other. You need to be aware of this, for example, when you replace a PCI module. For details, see “Impact When Module Status Changes” in “supplement”.

Procedure in NEC ESM PRO Manager

Start

1. Select the target component in the [FTServer] tree.
2. Check the current state with the "Status" display on the target component screen.
3. Click the [Bring Up] button in the [Maintenance] screen for the target component.

A certain time is required for the start.

The start result can be confirmed by "State" on the target component screen. The result of the start operation is reported by the NEC Express5800/ft series as an alert.

Stop

Perform the procedure below before replacing a component.

1. Select the target component in the [FTServer] tree.
2. Check the current state with the "State" display on the target component screen.
3. Click the [Bring Down] button in the [Maintenance] screen for the target component.

A certain time is required for the stop.

The stop result can be confirmed by "State" on the target component screen. The result of the stop operation is reported by the NEC Express5800/ft series as an alert.

Sample screen of NEC ESM PRO Manager 1

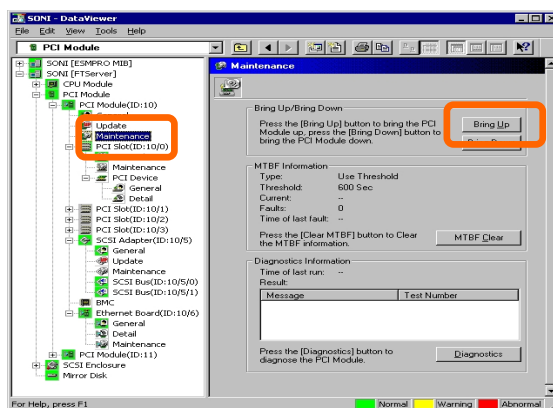

[Maintenance] screen of PCI module
[PCI Module] – [PCI Module] – [Maintenance]

Sample screen of NEC ESPRO Manager 2

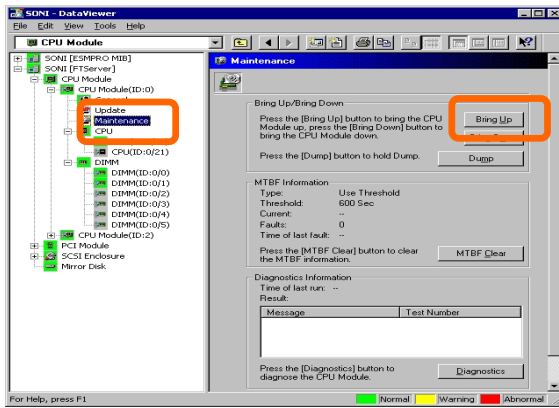

[Maintenance] screen of CPU module
[CPU Module] – [CPU Module] – [Maintenance]

Procedure in the ft server utility

Start

1. Select the target component from the main window of the ft server utility.
The screen of the target component appears.
2. Check the current state of the target component with the LEDs.
3. Click the [Up] button of the target component.

A certain time is required for the start.

The start result can be confirmed by the LEDs on the target component. The result of the start operation is registered in the syslog.

Stop

Stop before replacing components.

1. Select the target component from the main window of the ft server utility.
The screen of the target component appears.
2. Check the current state of the target component with the LEDs.
3. Click the [Down] button of the target component.

A certain time is required for the start.

The start result can be confirmed by the LEDs on the target component. The result of the start operation is registered in the syslog.

Sample screen of ft server utility

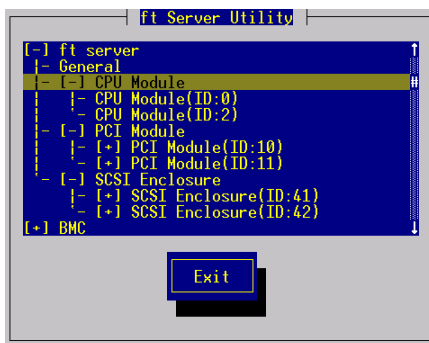

Main window



[CPU] module screen

Check and Clear of MTBF Information

The MTBF information of a component can be viewed or cleared (initialized).

NEC Express5800/ft series manages the MTBF (mean time between failure) of each component. If a fault occurs in a component, the NEC Express5800/ft series calculates the MTBF of the component again. If the calculated value is lower than the pre-defined threshold, the NEC Express5800/ft series disables the component to be used.

Contact your maintenance personnel if such a symptom as above occurs.

IMPORTANT: A disabled component with the MTBF lower than the threshold can be forcibly enabled by clearing the MTBF. However, contact your maintenance personnel for the forced use of such a component.

To clear the MTBF information of a component with NEC ESMPRO Manager, use the [Maintenance] tree of the component of the [FTServer] tree of the data viewer. Open the tree of the component whose MTBF information is to be cleared and select the [Maintenance] tree.

To clear the MTBF information of a component with the ft server utility, use the utility screen of the component. The table below shows the potential cases in which the MTBF information of a component is to be cleared. Contact your maintenance personnel for clearing MTBF information.

Component	MTBF clear	
	Remote	Local
CPU Module	<p>To start the module forcibly after replacing a module or if MTBF became lower than the threshold due to malfunction and disabled the module.</p> <p>Executable in the following module state (this can be viewed on manager screen):</p> <ul style="list-style-type: none"> Broken MTBF is lower than the threshold. 	<p>To start the module forcibly after replacing a module or if MTBF became lower than the threshold due to malfunction and disabled the module.</p> <p>Executable in the following module state:</p> <ul style="list-style-type: none"> Only the red LED is on and the event indicating that MTBF is lower than the threshold is registered in the event log.
PCI Module	Same as above	Same as above
Ethernet Adapter	<p>To start the module/component forcibly after replacing a module or if MTBF became lower than the threshold due to malfunction and disabled the module/component.</p> <p>Executable in the following module state (this can be viewed on manager screen):</p> <p>Broken MTBF is lower than the threshold.</p> <p>You can clear MTBF information by unplugging and plugging the live wire of the PCI module.</p>	<p>To start the module/component forcibly after replacing a module or if MTBF became lower than the threshold due to malfunction and disabled the module/component.</p> <p>Executable in the following module state (this can be viewed on manager screen):</p> <ul style="list-style-type: none"> Only the red LED is on and the event indicating that MTBF is lower than the threshold is registered in the event log. <p>You can clear MTBF information by unplugging and plugging the live wire of the PCI module.</p>
SCSI Adapter	Same as above	Same as above

Component	MTBF clear	
	Remote	Local
SCSI Enclosure	To start the module/component forcibly after replacing a module or if MTBF became lower than the threshold due to malfunction and disabled the module/component. Executable in the following module state (this can be viewed on manager screen): Broken MTBF is lower than the threshold.	To start the module/component forcibly after replacing a module or if MTBF became lower than the threshold due to malfunction and disabled the module/component. Executable in the following module state (this can be viewed on manager screen): Only the red LED is on and the event indicating that MTBF is lower than the threshold is registered in the event log.
SCSI Electronics	Same as above	Same as above
SCSI Slot	Same as above	Same as above

Remote: Executable from remote management PC by using NEC ESMPRO Manager
 Local: Executable on local server by using ft server utility
 -: Not support

Procedure in NEC ESMPRO Manager

Perform the procedure below before replacement of a component.

1. Select the target component in the [FTServer] tree.
2. Check the current state with the "State" display on the target component screen.
3. Click the [Clear] button in the [MTBF Clear] of the target component.

The MTBF clearing result can be confirmed by "State" on the target component screen. The result of the MTBF clearing operation is reported by the NEC Express5800/ft series as an alert.

4. Start the component.

Sample screen of NEC ESMPRO Manager

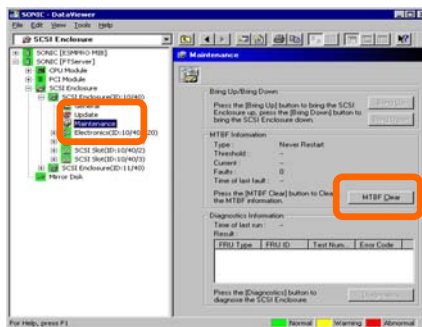

[Maintenance] screen of SCSI enclosure
 [SCSI Enclosure] – [Maintenance]

Procedure in the ft server utility

Perform the procedure below before replacement of a component.

1. Select the target component from the main window of the ft server utility.
The screen of the target component appears.
2. Check the current state of the target component with the LEDs.
3. Click the [Clear] button in [MTBF Clear] of the target component.
The MTBF clearing result can be confirmed by the LEDs on the target component. The result of the MTBF clearing operation is registered in the syslog.
4. Start the component.

Sample screen of ft server utility

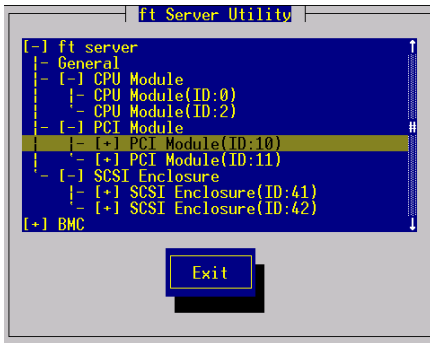

Main window

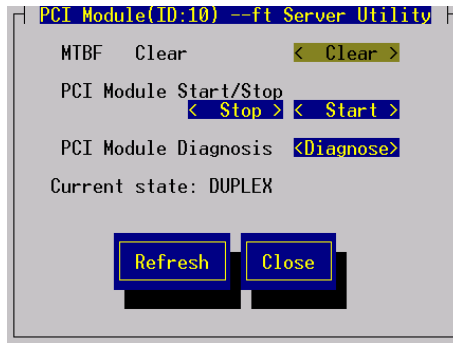

[PCI module] screen

Firmware Update

NEC Express5800/ft series can update firmware (including BIOS) if some hardware components operate in the online state (in which the system continues the operation but the component trying to update firmware or BIOS is stopped).

Updating firmware can be performed from the ft server utility.

To update the firmware of a component, the firmware image file of the firmware for update must previously be stored in the managed server. On the firmware update screen, specify the path to the firmware image file for update.

The table below shows the potential cases in which the firmware of a component is to be updated.

Component	Firmware update	
	Remote	Local
CPU Module	-	<p>When BIOS must be updated to new one. Executable in the following module state:</p> <ul style="list-style-type: none"> • When the status LED 1 is red and the status LED 2 is off <p>Only the status LED 1 illuminates red when the module is in one of the following states:</p> <ul style="list-style-type: none"> • Removed • Broken or forced stop • No fault found by diagnosis (Firmware Update Complete) <p>To update the module under operation, bring down the module before the update.</p>

Remote: Executable from remote management PC by using NEC ESMPRO Manager

Local: Executable on local server by using ft server utility

-: Not support

Procedure in the ft server utility

1. Enable “Auto module start” and “Auto firmware update”.
See “Setup of System Operation” in this chapter for the procedure to enable.
2. Store the image data of the firmware for update in the NEC Express5800/ft series.
Save it in the /etc directory under the name “BIOS.ROM”.
3. On the main window of the ft server utility, select the target component.
The screen of the target component appears.
4. Check the current state of the target component with the LEDs. If the component is running, stop the component.
5. Click [Update] on [Firmware].
The [Firmware Update] screen appears.
6. Select [File Path Update] and then click [Execute].
The firmware update will be performed. After the firmware update has completed, the target component automatically starts and the other stops.

IMPORTANT:

If “Auto firmware update” is disabled, the target component will not start and the firmware update will not complete. In such case, perform the firmware update again after enabling “Auto firmware update”.

7. The other component will start automatically and the firmware will be updated automatically.

IMPORTANT:

If “Auto module start” is disabled, the target component will not start automatically. In such case, start the component manually. The firmware will be updated automatically.

Sample screen of ft server utility

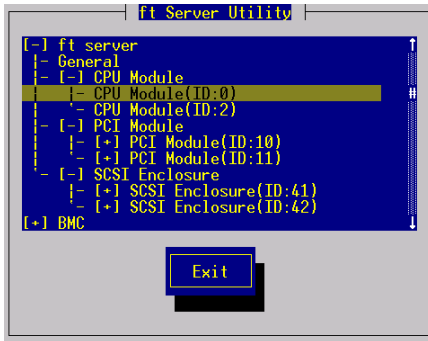

Main window



[CPU module] screen

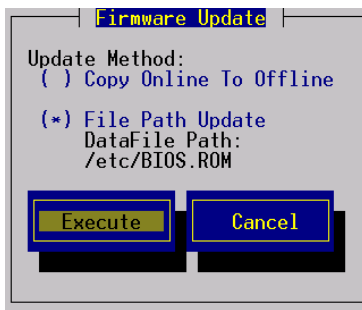

[Firmware Update] screen

Even if you do not have the image data of firmware for update, the firmware can be copied from the other module.

By starting the module, the firmware will be updated automatically. However, when the [Auto firmware update] property is disabled, follow the steps below to update the firmware:

1. Start the system using the module of the firmware copy source.
Check the status LEDs of the copy destination component for its current status. If it is running, stop it.
2. On the [Update] screen of the target component, click [Firmware update].
3. When a firmware updating dialog appears, check [Copy firmware from Online module to Offline one.] and execute it.
Firmware is updated by copying the firmware on the online side to the offline side.
4. Start the stopped module.

Dump Collection

To collect the dump file with NEC ESMPRO Manager, use [CPU Module] →[Maintenance] tree in the data viewer.

To collect the dump with the ft server utility, use the utility screen of the component.

IMPORTANT: Acquire the dump only for the examination of a fault.

The dump can be collected in two ways. In each way, the dump file is collected in “/var/log/dump”.

■ Collecting dump of inactive module

The dump is acquired from the inactive CPU module (due to the occurrence of a fault or forced stop).

IMPORTANT: The dump cannot be acquired from the inactive CPU module (due to the occurrence of a fault or forced stop) by using ft server utility. The dump is output automatically from the CPU module when a fault or forced stop occurs.

■ Collecting dump under system operation

Either of the CPU modules is entered into the offline state and the dump is collected during system operation. After the acquisition, the CPU module is returned to the online state again. This can be done only in the duplex system.

The table below shows the potential cases in which the dump is acquired.

Component	Saving dump of stopped module		Saving dump of component under system operation	
	Remote	Local	Remote	Local
CPU Module	-	-	When a fault or malfunction occurs in the system. Save the dump if requested by maintenance personnel. Executable in the following module state (this can be viewed on manager screen): <ul style="list-style-type: none"> • Duplex 	When a fault or malfunction occurs in the system. Save the dump if requested by maintenance personnel Executable in the following module state: <ul style="list-style-type: none"> • When only the green LED is on and the module is in redundant configuration state Only the green LED is on when the module is in the following state: <ul style="list-style-type: none"> • Duplex

Remote: Executable from remote management PC by using NEC ESMPRO Manager

Local: Executable on local server by using ft server utility

–: Not support

Procedure in NEC ESMPRO Manager

The [Dump] button of NEC ESMPRO Manager performs the function of "saving dump during system operation."

1. Select [CPU Module] in the [FTServer] tree.
2. Check the current state with the "State" display on the target component screen.
3. Click the [Dump] button in the [Maintenance] screen for the target component.

A certain time is required for the dump saving.

The result of the dump saving is reported by the NEC Express5800/ft series as an alert.

Sample screen of NEC ESMPRO Manager

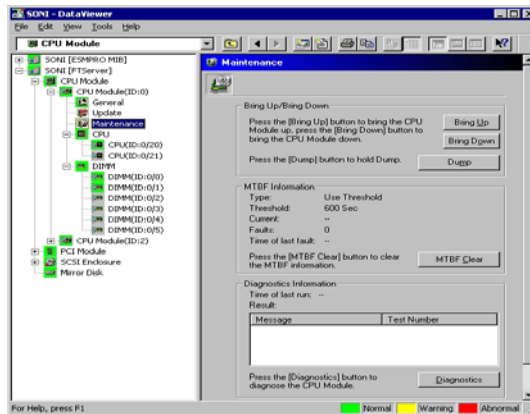

[Maintenance] screen of CPU module
[CPU Module] – [Maintenance]

Procedure in the ft server utility

1. On the main window of the ft server utility, select the target component.
The screen of the target component appears.
2. Check the current status of the target CPU module with the LEDs.
3. Select the dump acquisition method on [Dump] of the CPU module screen, and click [Execute].

A certain time is required for the dump acquisition. The dump is stored to the system defined location on the server.

The result of the dump acquisition can be registered in the syslog.

4. Start the component.

Sample screen of ft server utility

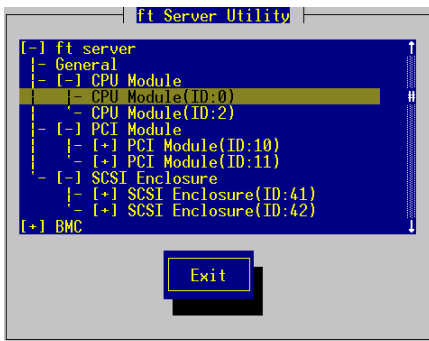

Main window



[CPU] module screen

Setup of System Operation

The following properties can be set as the operation setup of the whole system.

- Quick dump

If this property is enabled (by checking "Enable" on the setup screen), the dump is acquired in parallel with the system startup if a fault occurs in the system. If this property is disabled, the dump is acquired by the dump function normally provided by OS.

The initial setup value is "Enable." This value cannot be changed.

- Auto firmware update

If a new CPU module containing BIOS different from that of the existing CPU module in version with this property being enabled (by checking "Enable" on the setup screen), the BIOS of the new CPU module is updated to the BIOS of the existing CPU module to match with each other. If this property is disabled, the BIOS of the new CPU module is not update automatically.

The initial setup value is "Enable."

- Auto module start

If this property is enabled (by checking "Enable" on the setup screen), the CPU or PCI module newly inserted is automatically started to be operable. If this property is disabled, the module is not started automatically.

The initial setup value is "Enable."

The system operation can be set on [FTServer] tree→[General] screen of the ft server utility.

The table below shows the potential cases in which the system operation setup is changed. Contact your maintenance personnel for the change of the system operation setup. Setting change will take effect after system reboot. However, the utility does not indicate that reboot is required.

Component	Quick dump		Auto firmware update		Auto module start	
	Remote	Local	Remote	Local	Remote	Local
Whole system	-	Executable if the system is operating.	-	Executable if the system is operating.	-	Executable if the system is operating.
		When dump is acquired by using the dump function normally installed in OS at occurrence of system fault.		When firmware is updated manually at insertion of new CPU module		When firmware is updated manually at insertion of new CPU/PCI module

Remote: Executable from remote management PC by using NEC ESMPRO Manager

Local: Executable on local server by using ft server utility

-: Not support

Configure the system settings using the ft server utility in the following procedure. The system cannot be configured using the NEC ESMPRO Manager.

1. Select [General] on the main window of the ft server utility.
The [General] window appears.
2. Check the property to modify on the [General] window (or cancel the check).
3. Click [Execute].

Sample screen of ft server utility

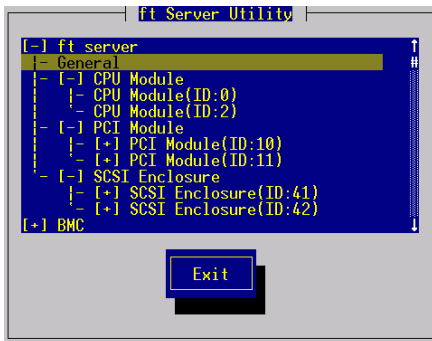

Main window

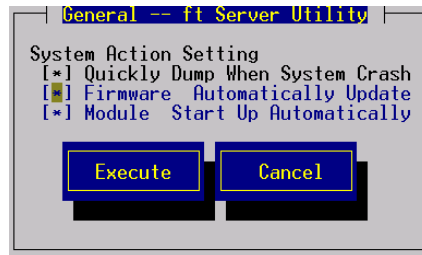

[CPU] module screen

BMC Firmware Update

The firmware of the BMC on the PCI module can be updated.

The base management controller (BMC) is the processor exclusively used for monitoring the system's operating environment faults and controlling of the system.

The BMC firmware can be updated by using the BMC firmware update utility.

Both NEC ESMPRO Manager and the ft server utility can start the BMC firmware update utility.

To update the BMC firmware, the firmware image file must be updated on the managed server in advance. On the BMC firmware update screen, specify the path of the image file of the firmware to be updated.

IMPORTANT:

By default, the BMC firmware update utility refers the following path. It is recommended to create a data directory under /usr/bmcfwupd in advance, and store the firmware image file in this directory when updating the firmware.

`/usr/bmcfwupd/data`

The table below shows the potential cases in which the BMC firmware is to be updated.

IMPORTANT: Contact your maintenance personnel for the update of the BMC firmware.

Component	BMC firmware update	
	Remote	Local
BMC	-	When an update to new firmware is required. Executable in the following module state <ul style="list-style-type: none"> • Only the green LEDs on all PCI modules are on Executable in the following state when only the green LEDs on all PCI modules are on: <ul style="list-style-type: none"> • Duplex

Remote: Executable from remote management PC by using NEC ESMPRO Manager

Local: Executable on local server by using ft server utility

–: Not support

Procedure of Update from the ft server utility

Update the firmware in the procedure as follows.

1. Select [Firmware] on the main window of the ft server utility.

The [Firmware] dialog box appears.

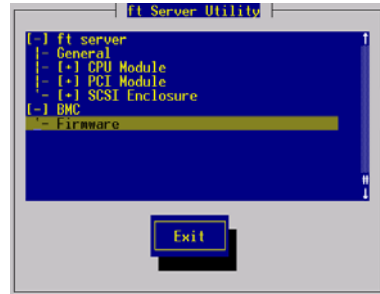

2. Click [Update].

The [BMC FW update Tool] screen appears.

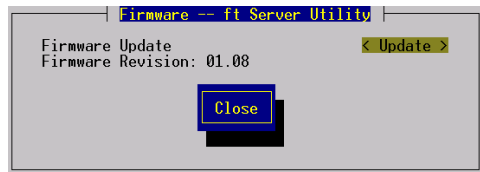

3. Select [BMC FW update Command] menu, and press **Enter**.

The firmware will be updated.

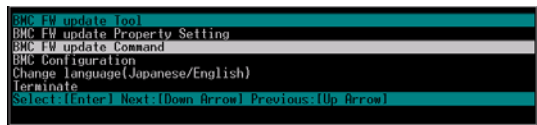

Changing Update Data Storage Destination

Change the storage destination by using the ft server utility in the procedure below.

1. Select [Firmware] on the main window of the ft server utility.

The [Firmware] dialog box appears.

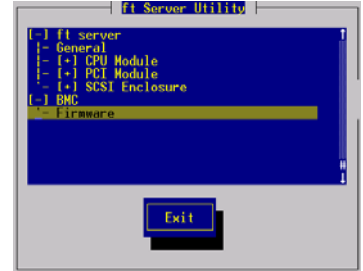

2. Click [Update].

The [BMC FW update Tool] screen appears.

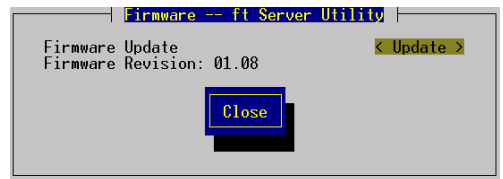

3. Select [BMC FW update Property Setting] menu, and then press **enter**.

The [BMC FW update Daemon Property Setting] screen appears.

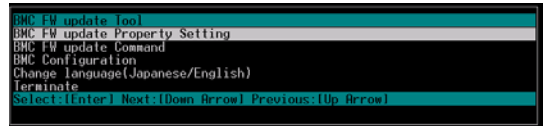

4. Enter the storage destination in [Data File Path], and then click [Data save and Exit].

If you click [Cancel and Exit], the property setting will be finished with the updated data canceled.

The confirmation message for the storage is displayed.

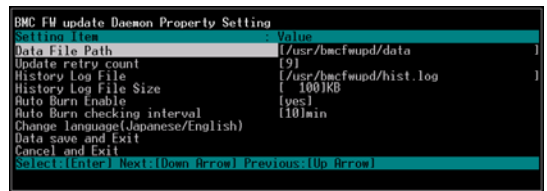

5. Press **Y** to store. Press **N** not to store.

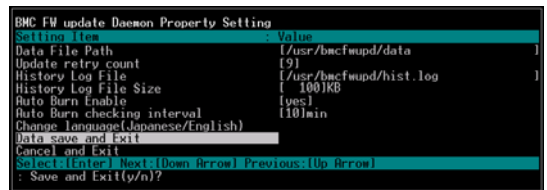

NEC MWA ~ MANAGEMENT WORKSTATION APPLICATION ~

NEC MWA is an application that enables the remote management of the server through a management PC over the network. (A management PC is a computer running NEC ESMPRO Manager.)

Refer to “MWA First Step Guide” in the following directory of NEC EXPRESSBUILDER CD-ROM for details of its functions and operation.

CD-ROM drive: \mwa\doc\mwa_fsg.pdf

TIPS: How to install MWA is described in online documents. See “MWA Installation Guide” for details.

IMPORTANT: If you set up NEC MWA using Console Redirection (via WAN or direct), select [System Hardware] → [Console Redirection] → [Serial Port Address] and set [Onboard COM B] on the BIOS setup utility. For details, see Chapter 4 “SYSTEM BIOS ~ SETUP ~”.

Servers to be remotely managed by MWA

The server with RomPilot or BMC can be managed by MWA.

This product has both RomPilot and BMC (IPMI1.0).

PRECAUTIONS:

“MWA First Step Guide” is common to all the managed servers. The followings are notes and restrictions for this product.

- The Console Redirection feature with WAN or direct connection cannot be used when the server is operated remotely from the other management PC by using the RomPilot feature via LAN. To use Console Redirection with WAN or direct connection, set “RomPilot Support” in “Advanced” menu of BIOS setup utility to “Disabled”. See Chapter 4 “SYSTEM BIOS ~SETUP~” for details.
 - ESCD information is not collected by MWA. If you attempt to collect it from MWA, “ESCD data read error server report: Plug and Play call error” is generated.
 - NO MWA Agent is available on this product.
-

Remote Management Configuration for the Server without Console

If the main unit does not have a console such as keyboard, you can operate tools on the server remotely using NEC MWA's remote console functions and NEC EXPRESSBUILDER's consoleless functions.

There are two ways of remote console connection depending on the condition of connection between the management PC and the main unit:

- Connect from the management PC linked to the main unit through LAN.
- Connect from the management PC directly linked (through Serial port B) to the main unit.

Connect from the Management PC Linked through LAN

On the management PC that is linked through LAN, perform the steps below:

1. Start the management PC where MWA is installed. From the Start menu, select [Program] → [NEC MWA] → [MWA].

When MWA starts, the initial screen "Remote Control Manager" will appear.

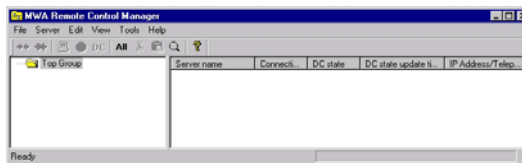

2. Insert a formatted 1.44MB floppy disk into the drive.
3. From MWA's [File] menu, select [Configuration] command to open [Configuration] dialog box.
4. Select [New] to display the [Select a model] dialog box.
5. Check [Write to FD] and select an applicable model to open [Configuration for ft Series] dialog box.

Ex) The model name is printed on the front cover like "NEC Express5800/320Lb," or "NEC Express5800/320Lb-R."

6. [Configuration for ft Series] dialog box, specify/register configuration information including the names of computers to be managed, and then write the information to FD as the following filename:

<Filename>
 CSL_LESS.CFG

The setting items of the server are as follows:

- Computer Name (The managed server name. Arbitrary)
- IP address
- Subnet mask
- Default gateway
- Primary contact (Management PC's IP address)

7. Right-clicking the server name to open the pop-up menu, from which select [Property] command to open [Property] dialog box.
8. When the [Property] dialog box appears: specify the items as follows:

<[ID] page>
 Connection mode: LAN
 <[Alert notification] page>
 Uncheck [Use Default Settings] and check [Reset] of [Activate].

9. Right-clicking the server name to open the pop-up menu and select [Open Remote Console] to open [MWA Remote Console].

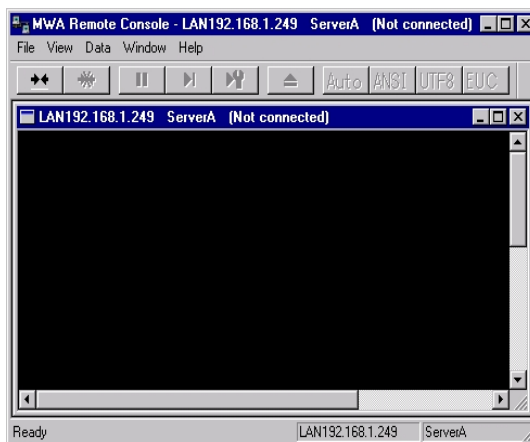

10. Select the [Action at Remote Console Connect] command from the popup menu displayed by right-clicking the server window to display the [Action at Remote Console Connect] dialog box. Then select [Go MWA mode].
11. Insert NEC EXPRESSBUILDER CD-ROM into the drive of the computer to be managed and insert floppy disk storing the configuration information (CSL_LESS.CFG) into the FDD drive.
12. Hook up the management PC to LAN.

- 13.** Power off and on the main unit to reboot the system.

After one reboot, the main menu will appear on the management PC's screen, on which you can perform hardware setup and run utilities.

TIPS: If the configuration information (CSL_LESS.CFG) in the FD has already been loaded, the main menu will appear without a reboot.

- 14.** When the main menu appears on the management PC's screen, eject the floppy disk.

- 15.** If you use other tools, exit NEC EXPRESSBUILDER and power off/on the main unit.

IMPORTANT: After completing the procedure for remote console connection, uncheck [Reset] of [Activate] in [Property] dialog box.

Connect from the Management PC Directly Linked (through Serial port B)

On the management PC that is linked directly to Serial port B of the main unit, perform the steps below:

1. Start the management PC where MWA is installed. From the Start menu, select [Program] → [NEC MWA] → [MWA].

When MWA starts, the initial screen “Remote Control Manager” will appear.

2. Select [Environment] – [Direct Connection Setting] from the [File] menu of NEC MWA to display the [Direct Connection] dialog box. Configure the following settings:

<Direct Connection>

Port No.: COM port on the management PC to be connected

Baud Rate: 19200

Flow Control: None

3. From MWA’s [File] menu, select [Configuration] command to open [Configuration] dialog box.
4. Select [New] to display [Select a model] dialog box.
5. Check [Write to FD] and select an applicable model to open [Configuration for ft Series] dialog box.

Ex) The model name is printed on the front cover like “NEC Express5800/320Lb,” or “NEC Express5800/320Lb-R.”

6. [Configuration for ft Server] dialog box, specify/register configuration information including the names of computers to be managed, and then write the information to FD as the following filename:

<Filename>

CSL_LESS.CFG

7. Right-clicking the server name to open the pop-up menu and select [Property] command to open [Property] dialog box.
8. When [Property] dialog box appears: specify the items as follows:

<[ID] page>

Connection mode: COM

COM: Direct (cross cable)

9. Right-clicking the server name to open the pop-up menu and select [Open Remote Console] to open [MWA Remote Console].

After checking to see if the server window is open on [MWA Remote Console], click the [Connect] button.

10. Hook up the management PC directly to Serial port B of the computer to be managed.
11. Insert NEC EXPRESSBUILDER CD-ROM into the drive of the managed computer and insert the floppy disk storing the configuration information (CSL_LESS.CFG) into the FDD drive.

- 12.** Power off and on the main unit to reboot the system.

After one reboot, the main menu will appear on the management PC's screen, on which you can perform hardware setup and run utilities.

TIPS: If the configuration information (CSL_LESS.CFG) in the FD has already been loaded, the main menu will appear without a reboot.

- 13.** If you use other tools, exit NEC EXPRESSBUILDER and power off/on the main unit.

IMPORTANT: After completing the procedure for remote console connection, click [Disconnect] on the [MWA Remote Console] window.

(This page is intentionally left blank.)

Chapter 6

Maintenance

This chapter describes the daily maintenance of NEC Express5800/ft series and precautions when relocating or storing the server.

DAILY MAINTENANCE

To use your NEC Express5800/ft series in best condition, check and maintain regularly as described below. If an error is found on your NEC Express5800/ft series, consult your sales agent.

Checking Alert

Monitor the failure occurrence by NEC ESMPRO during the system operation.

Always check whether any alert is reported to NEC ESMPRO Manager on the management PC. Check whether any alert is reported on the Operation Window, Data Viewer, or Alert Viewer of NEC ESMPRO Manager.

Viewers of NEC ESMPRO



Operation Window

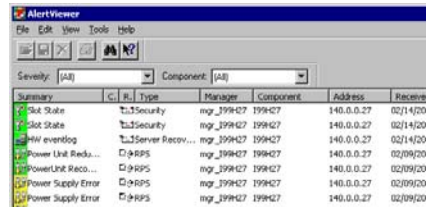

Alert Viewer



Data Viewer

Checking STATUS LEDs and LCD Display

Check the LED indication on the front of the NEC Express5800/ft series, on hard disks installed in 3.5-inch hard disk drive bay, or on LCD display when the server is powered on or powered off by the shut down operation. The functions and indications of LEDs are described in Chapter 2. If any indication that shows an error, contact your sales agent.



Making Backup Copies

NEC recommends you make backup copies of your valuable data stored in hard disks of the server on a regular basis. For backup storage devices suitable for the server and backup tools, consult with your sales agent.

When you have changed the hardware configuration or BIOS configuration, select "System Information Management" and then "Save" of the Off-line Maintenance Utility to make a backup copy of the system information (See the separate volume of User's Guide (Setup)).

Cleaning

Clean the server on a regular basis to keep the server in a good shape.

 WARNING	
	<p>Observe the following instructions to use the server safely. Failure to follow these instructions may result in death or serious personal injury. See PRECAUTIONS FOR SAFETY in Chapter 1.</p> <ul style="list-style-type: none"> • Do not disassemble, repair, or alter the server. • Do not look into the CD-ROM drive. • Disconnect the power plug before cleaning the server.

Cleaning the NEC Express5800/ft series

For daily cleaning, wipe the external surfaces of the server with a dry soft cloth. Follow the procedure below if stains remain on the surfaces:

IMPORTANT:

- To avoid altering the material and color of the server, do not use volatile solvents such as thinner or benzene to clean the server.
 - The power receptacle, the cables, the connectors on the rear panel of server, and the inside of the server must be kept dry. Do not moisten them with water.
-

1. Make sure that the server is powered off.
2. Unplug the power cord of the server from a power outlet.
3. Wipe off dust from the power cord plug with a dry cloth.
4. Soak a soft cloth in neutral detergent that is diluted with cold or warm water, and squeeze it firmly.
5. Rub off stains on the server with the cloth prepared in Step 4.
6. Soak a soft cloth in water, squeeze it firmly and wipe the server with it once again.

7. Wipe the server with a dry cloth.
8. Wipe off dust from the fan exhaust opening on the rear of the server with a dry cloth.

Cleaning the Keyboard and Mouse

IMPORTANT: A keyboard and a mouse use USB interface. You do not need to power off the server when connecting or disconnecting them.

Disconnect the keyboard from the server while the devices in the system (the server and the peripheral devices) remain turned on. Wipe the keyboard surface with a dry cloth. Then connect the keyboard to the server.

The mouse operation depends on the degree of smoothness of the internal ball rotation. To keep the mouse ball clean, use the mouse in a place with little dust. Follow the steps below to clean the mouse regularly:

1. Disconnect the mouse from the USB hub of the keyboard while the server remains powered on.
2. Turn the mouse upside down, and rotate the mouse ball cover counterclockwise to remove it. Take out the ball from the mouse.

3. Wipe the mouse ball with a dry soft cloth.

If stains remain, use a soft cloth to wipe them off. Soak the soft cloth in neutral detergent that is diluted with water or warm water, and squeeze it firmly,

4. Wipe three small rollers inside the mouse with cotton swab.

Use the cotton swab soaked with alcohol if stains remain.

5. Put the mouse ball back into the mouse.

If the mouse or rollers are wet in steps 3 and 4, put it back after fully dried.

6. Place the mouse ball cover, and rotate it clockwise until it is locked.

7. Connect the mouse to the server (to the USB hub of the keyboard).

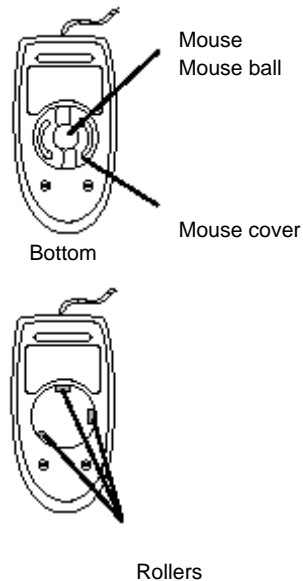

Cleaning the Floppy Disk Drive

A read/write error may occur due to stains on the read/write head of the floppy disk drive.

Use the cleaner dedicated for floppy disk drive to clean the read/write head. It is recommended to clean the head on regular basis.

Cleaning CD-ROM

A dusty CD-ROM or dust-accumulated tray causes the device to fail to read data correctly.

Follow the procedure below to clean the tray and CD-ROM regularly:

1. Make sure that the server is powered (the POWER LED is lit).
2. Press the Eject button on the front of the CD-ROM drive.
The tray comes out.
3. Hold the CD-ROM lightly and take it out from the tray.

IMPORTANT: Do not touch the signal side of the CD-ROM with your hand.

4. Wipe the tray with a dry soft cloth.

IMPORTANT: Do not wipe the lens of the CD-ROM drive. Doing so may damage the lens and may cause a malfunction of the drive.

5. Gently push on the tray front to close the tray.
6. Wipe the signal side of the CD-ROM with a dry soft cloth.

IMPORTANT: Wipe CD-ROMs from the center to the outside. Use only CD-ROM cleaner if necessary. Cleaning a CD-ROM with record spray/cleaner, benzene, or thinner causes damage to the CD-ROM contents. At worst, inserting the CD-ROM into the server may cause failure.

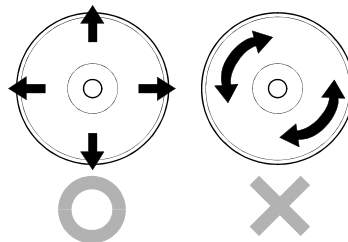

Cleaning Tape Drive

Dirt on the tape head may be a cause of unsuccessful backup and damage to tape cartridge. Clean the tape head regularly using a cleaning tape. For procedure and interval of cleaning as well as lifetime of a tape cartridge to use, see instructions included with the tape drive.

SYSTEM DIAGNOSTICS

The System Diagnostics runs several tests on the server.

Select [Tools] → [System Diagnostics] in the NEC EXPRESSBUILDER to diagnose the server.

Test Items

The following items are tested in system diagnostics.

- Memory
- CPU cache memory
- Hard disk used as a system

IMPORTANT: When executing the system diagnostics, make sure to remove the LAN cable. Executing the system diagnostics with the LAN cable connected, the network may be influenced.

TIPS: On checking the hard disk, no data is written into the disk.

Startup and Exit of System Diagnosis

Procedures to start the diagnostic program are as follows:

1. Shutdown the OS, and power off the server. Then, unplug the power cord.
2. Disconnect all the LAN cables from the server.
3. Plug the power cord and power on the server.
4. Use the NEC EXPRESSBUILDER CD-ROM to reboot the server.

The following menu appears when the server is started using the NEC EXPRESSBUILDER.

5. Select [Tools].

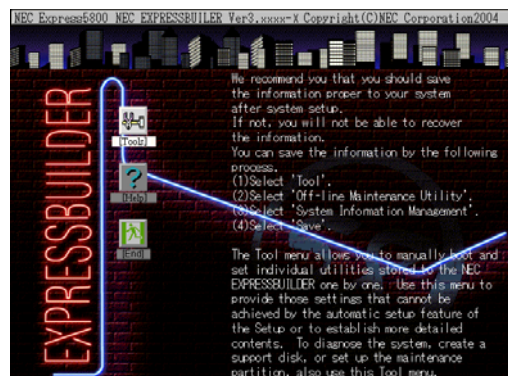

6. Select [System Diagnostics].

The system diagnosis starts and will be completed in approximately three minutes.

When the diagnosis is completed, the following appears on the screen of the display unit.

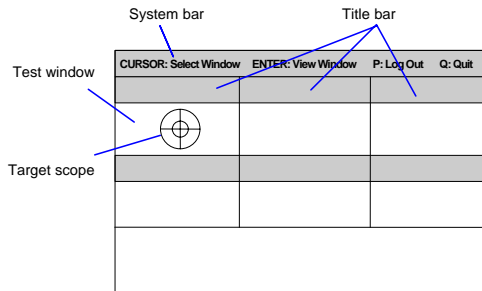

System bar: Shows information including time of progress during the diagnostics. Upon completion of the diagnostics, descriptions on key operations to navigate the window are shown.

Title bar: Shows items for diagnosis. If an error is detected, the bar is indicated in red.

Test window: Shows the progress or result of diagnostics.

Target scope: A cursor to select the test window. Use the cursor keys on the keyboard to move it to another test window. (Move the target scope to a desired window and press **Enter**. Now you can view detailed information on the selected window. To return to the previous window, press **Enter** once again.) Some system configurations do not display the target scope but change the color of test window's frame.

If an error is detected during the system diagnostics, the title bar turns in red, and error information is displayed in red characters. Note down the error message and contact your sales agent.

7. Press **Q** and select [Reboot] from the menu.

The server restarts and the system is started from the NEC EXPRESSBUILDER.

8. Exit the NEC EXPRESSBUILDER, and remove the CD-ROM from the CD-ROM drive.

9. Power off the server and unplug the power cord from the receptacle.

10. Reconnect all the LAN cables to the server.

11. Plug the power cord.

This completes the system diagnostics.

OFF-LINE MAINTENANCE UTILITY

The Off-line Maintenance Utility is an OS-independent maintenance program. When you are unable to start the OS-dependent NEC ESMPRO to troubleshoot a problem, the Off-line Maintenance Utility can be used.

IMPORTANT:

- The Off-line Maintenance Utility is intended for use of your sales agent. The NEC EXPRESSBUILDER CD-ROM and the Off-line Maintenance Utility Bootable FD you have created contain a file that describes operation of the utility, but do not attempt to use the utility by yourself. Contact your sales agent and follow instructions.
 - Starting the Off-line Maintenance Utility disables any access from a client to the server.
-

Starting the Off-line Maintenance Utility

The Off-line Maintenance Utility may be started in the following ways.

NEC Express5800/ft series does not support the feature to start the Off-line Maintenance Utility from the maintenance partition.

- From the NEC EXPRESSBUILDER CD-ROM

Set the NEC EXPRESSBUILDER CD-ROM in the CD-ROM drive and reboot the system. After the menu is displayed on the screen, select [Tools] → [Off-line Maintenance Utility]. The Off-line Maintenance Utility program starts from the CD-ROM.

- From the floppy disk

Set the Off-line Maintenance Utility Bootable FD in the floppy disk drive and reboot the system. The Off-line Maintenance Utility program starts from the boot disk. The Off-line Maintenance Utility Bootable FD is created by selecting [Tools] → [Create Support FD] on the NEC EXPRESSBUILDER.

Features of Off-line Maintenance Utility

The Off-line Maintenance Utility provides the following features.

- IPMI Information Viewer

Provides the functions to view the system event log (SEL), sensor data record (SDR), and field replaceable unit (FRU) in IPMI (Intelligent Platform Management Interface) and to make a backup copy of them.

Using this feature, you can find system errors and events to determine a maintenance part.

- BIOS Setup Viewer

Provides the functions to export the current configuration data defined with the SETUP utility to a text file.

- System Information Viewer

Provides the functions to view information on the processor (CPU) and the BIOS and export it to a text file.





- System Information Management

Provides the function to make a back-up copy of your data. Without the backup data, the system-specific information and/or configuration may not be restored.

TIPS: For information on making backup copy of system information, see the separate volume “User’s Guide (Setup)”. Only the authorized personnel are allowed to restore the backup data.

RELOCATING/STORING THE NEC Express5800/ft series

Follow the procedure below to relocate or store the server. (Users should not attempt to remove the rack-mountable server from the rack assembly.)

 WARNING	
	<p>Do not attempt to remove the server.</p> <p>To avoid the risk of personal injury, users should not attempt to remove the server from the rack assembly. Removal of the server from the rack assembly should be performed by suitably trained maintenance personnel.</p>
 CAUTION	
	<p>Observe the following instructions to use the server safely. There are risks of a fire, personal injury, or property damage. See PRECAUTIONS FOR SAFETY in Chapter 1 for details.</p> <ul style="list-style-type: none">• Never attempt to lift the server only by yourself.• Do not install the server in any place other than specified.• Do not connect/disconnect any interface cable with the power cord of the server plugged to a power source.

IMPORTANT:

- If the server needs to be relocated/stored due to a change in the floor layout to a great extent, contact the sales agent.
 - Make sure to make a backup copy of your valuable data in the hard disk, if any.
 - When moving the server with hard disks, make sure not to give a shock to the hard disks.
 - When storing the server, keep it under storing environment conditions (temperature: -10 to 55°C, humidity: 20 to 80%, non-condensing).
-

1. Detach the front bezel (or open it in the case of a tower model).
2. Take a floppy disk and a CD-ROM out of the server, if any.
3. Power off the server.
4. Unplug the power cord of the server from a power outlet.
5. Remove all the cables from the server.
6. Remove all the mounted modules.
7. If the server is a rack-mount model, remove the backplane and the rails from the rack cabinet.

8. Carry the backplane, rails and modules separately.

IMPORTANT: If the server is a tower model, do not hold the front bezel to lift it. The front bezel may get detached and fall off from the server, causing damage to the server.

9. Protect the server with the shock-absorbing materials, and pack it securely.

IMPORTANT:

Check and adjust the system clock before operating the server again after relocating or storing it.

If the server and the built-in optional devices are moved from a cold place to a warm place in a short time, condensation will occur and cause malfunctions and breakdown when these are used in such state. When you start operating these equipments again after the transportation or the storage, make sure to wait for a sufficient period of time to use them in the operating environment.

If the system clock goes out of alignment remarkably as time goes by, though the system clock adjustment is performed, contact your sales agent.

Chapter 7

Troubleshooting

If the product does not work properly, see this chapter before deciding that it is a breakdown.

TO LOCATE THE ERRORS

Use NEC ESMPRO to monitor the occurrence of fault during the system operation.

Especially take note on whether any alert is reported to NEC ESMPRO Manager on the management PC. Check whether any alert is reported on the Operation Window, Data Viewer, or Alert Viewer of NEC ESMPRO Manager.

[Example]

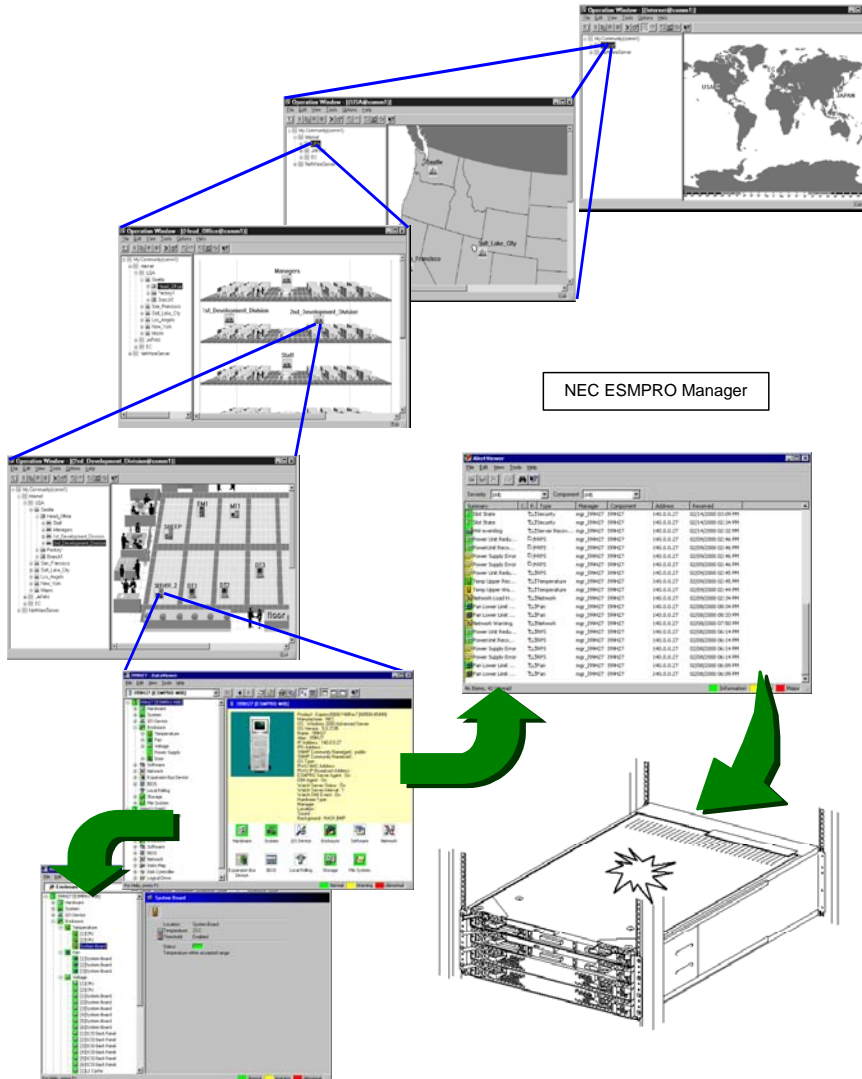

Determine type and location of server/workstation trouble.

ERROR MESSAGES

If the NEC Express5800/ft series enters the abnormal state, the error is posted by various means. This section explains the types of error messages.

Error Messages by LED Indication

The LEDs on the front and rear panels of the NEC Express5800/ft series and near the handles of hard disks inform the user of the various server statuses by the colors and the patterns of going on, going off, and flashing. If trouble seems to have occurred, check the LED indication. For the LED indication and meanings, see Chapter 2.

Error Messages on the Liquid Crystal Display (LCD)

The LCD on the front panel of the NEC Express5800/ft series displays the NEC Express5800/ft series status all the time. If an error occurs, the LCD displays the error message.

The following tables show the messages that are to be displayed on the LCD, and explain the meanings and procedures:

IMPORTANT: Although NEC Express5800/320Lb(-R) does not have an LCD on its front, you can check error messages from NEC MWA or NEC ESMPRO Manager as follows:

- NEC MWA: On a desired server, select [Start BMC dialog] from the Server menu. BMC dialog box will show the LCD status as well as server power status and LED status.
 - NEC ESMPRO Manager: On Operation Window, select a desired server and start Data Viewer. You can check the messages on Data Viewer.
-

7-4 Troubleshooting

Indication	STATUS LED		Suspected module	Explanation	Procedure
	Color	State			
= A =					
AmbientTempAlm00	Amber	Blink	CPU module	Temperature alarm (lower limit)	Contact your sales agent.
AmbientTempAlm02	Amber	Lit	CPU module	Fatal temperature alarm (lower limit)	
AmbientTempAlm07	Amber	Blink	CPU module	Temperature alarm (upper limit)	
AmbientTempAlm09	Amber	Lit	CPU module	Fatal temperature alarm (upper limit)	
= B =					
BMC Unsync	-	-	PCI module #1	The BMC cannot be synchronized.	Contact your sales agent.
BMC0 Not Ready	Green	Blink	PCI module #1	PCI module's BMC is disconnected	If disconnection continues for a while, contact your sales agent.
BMC1 Not Ready	Green	Blink	PCI module #2		
= C =					
Cor0 +12vAlm00	Amber	Blink	PCI module #1	12-V power voltage alarm (lower limit)	Contact your sales agent.
Cor0 +12vAlm02	Amber	Lit	PCI module #1	Fatal 12-V power voltage alarm (lower limit)	
Cor0 +12vAlm07	Amber	Blink	PCI module #1	12-V power voltage alarm (upper limit)	
Cor0 +12vAlm09	Amber	Lit	PCI module #1	Fatal 12-V power voltage alarm (upper limit)	
Cor0 +2.5vAlm00	Amber	Blink	PCI module #1	2.5-V power voltage alarm (lower limit)	
Cor0 +2.5vAlm02	Amber	Lit	PCI module #1	Fatal 2.5-V power voltage alarm (lower limit)	
Cor0 +2.5vAlm07	Amber	Blink	PCI module #1	2.5-V power voltage alarm (upper limit)	
Cor0 +2.5vAlm09	Amber	Lit	PCI module #1	Fatal 2.5-V power voltage alarm (upper limit)	
Cor0 +3.3vAlm00	Amber	Blink	PCI module #1	3.3-V power voltage alarm (lower limit)	
Cor0 +3.3vAlm02	Amber	Lit	PCI module #1	Fatal 3.3-V power voltage alarm (lower limit)	
Cor0 +3.3vAlm07	Amber	Blink	PCI module #1	3.3-V power voltage alarm (upper limit)	
Cor0 +3.3vAlm09	Amber	Lit	PCI module #1	Fatal 3.3-V power voltage alarm (upper limit)	
Cor0 +3.3vsAlm00	Amber	Blink	PCI module #1	3.3-V power voltage alarm (lower limit)	
Cor0 +3.3vsAlm02	Amber	Lit	PCI module #1	Fatal 3.3-V power voltage alarm (lower limit)	
Cor0 +3.3vsAlm07	Amber	Blink	PCI module #1	3.3-V power voltage alarm (upper limit)	
Cor0 +3.3vsAlm09	Amber	Lit	PCI module #1	Fatal 3.3-V power voltage alarm (upper limit)	
Cor0 +5.0vAlm00	Amber	Blink	PCI module #1	5-V power voltage alarm (lower limit)	
Cor0 +5.0vAlm02	Amber	Lit	PCI module #1	Fatal 5-V power voltage alarm (lower limit)	
Cor0 +5.0vAlm07	Amber	Blink	PCI module #1	5-V power voltage alarm (upper limit)	

Indication	STATUS LED		Suspected module	Explanation	Procedure	
	Color	State				
Cor0 +5.0vAl m 09	Amber	Lit	PCI module #1	Fatal 5-V power voltage alarm (upper limit)	Contact your sales agent.	
Cor0 +5.0vSAI m 00	Amber	Blink	PCI module #1	5-V power voltage alarm (lower limit)		
Cor0 +5.0vSAI m 02	Amber	Lit	PCI module #1	Fatal 5-V power voltage alarm (lower limit)		
Cor0 +5.0vSAI m 07	Amber	Blink	PCI module #1	5-V power voltage alarm (upper limit)		
Cor0 +5.0vSAI m 09	Amber	Lit	PCI module #1	Fatal 5-V power voltage alarm (upper limit)		
Cor0 -12vAl m 00	Amber	Blink	PCI module #1	-12-V power voltage alarm (lower limit)		
Cor0 -12vAl m 02	Amber	Lit	PCI module #1	Fatal -12-V power voltage alarm (lower limit)		
Cor0 -12vAl m 07	Amber	Blink	PCI module #1	-12-V power voltage alarm (upper limit)		
Cor0 -12vAl m 09	Amber	Lit	PCI module #1	Fatal -12-V power voltage alarm (upper limit)		Contact your sales agent.
Cor0 Bus PERR 01	Green	Blink	PCI module #1	PCI bus parity error		
Cor0 Bus SERR 01	Green	Blink	PCI module #1	Fatal PCI bus error		
Cor0 CLK Al m 00	Amber	Blink	CLOCK board	Cl ock alarm (lower limit)		
Cor0 CLK Al m 02	Amber	Lit	CLOCK board	Fatal Cl ock alarm (lower limit)		
Cor0 CLK Al m 07	Amber	Blink	CLOCK board	Cl ock alarm (upper limit)		
Cor0 CLK Al m 09	Amber	Lit	CLOCK board	Fatal Cl ock alarm (upper limit)		
Cor0 FAN Al m 01	Amber	Blink	PCI module #1	Cooling fan1 alarm	Check to see if dust is accumulated on the internal fans. Check also if the fan cables are connected securely. If not solved by the above, contact your sales agent.	
Cor0 FAN Al m 02	Amber	Blink	PCI module #1	Cooling fan2 alarm		
Cor0 FAN Al m 03	Amber	Blink	PCI module #1	Cooling fan3 alarm		
Cor0 FAN Al m 04	Amber	Blink	PCI module #1	Cooling fan4 alarm		
Cor0 FAN Al m 05	Amber	Blink	PCI module #1	Cooling fan5 alarm		
Cor0 offli ne	Green	Blink	PCI module #1	PCI module logically isolated	Start the PCI module by ft sever utility or dismount and remount that module. If not solved by the above, contact your sales agent.	
Cor0 removed	Green	Blink	PCI module #1	PCI module detached	Dismount and remount the PCI module. If not solved by the above, contact your sales agent.	
Cor0 Temp Al m 00	Amber	Blink	PCI module #1	Temperature alarm (lower limit)	Check to see if dust is accumulated on the internal fans. Check also if the fan cables are connected securely. If not solved by the above, contact your sales agent.	
Cor0 Temp Al m 02	Amber	Lit	PCI module #1	Fatal temperature alarm (lower limit)		
Cor0 Temp Al m 07	Amber	Blink	PCI module #1	Temperature alarm (upper limit)		
Cor0 Temp Al m 09	Amber	Lit	PCI module #1	Fatal temperature alarm (upper limit)		

7-6 Troubleshooting

Indication	STATUS LED		Suspected module	Explanation	Procedure
	Color	State			
Cor1 +12vAl m 00	Amber	Blink	PCI module #2	12-V power voltage alarm (lower limit)	Contact your sales agent.
Cor1 +12vAl m 02	Amber	Lit	PCI module #2	Fatal 12-V power voltage alarm (lower limit)	
Cor1 +12vAl m 07	Amber	Blink	PCI module #2	12-V power voltage alarm (upper limit)	
Cor1 +12vAl m 09	Amber	Lit	PCI module #2	Fatal 12-V power voltage alarm (upper limit)	
Cor1 +2. 5vAl m 00	Amber	Blink	PCI module #2	2. 5-V power voltage alarm (lower limit)	
Cor1 +2. 5vAl m 02	Amber	Lit	PCI module #2	Fatal 2. 5-V power voltage alarm (lower limit)	
Cor1 +2. 5vAl m 07	Amber	Blink	PCI module #2	2. 5-V power voltage alarm (upper limit)	
Cor1 +2. 5vAl m 09	Amber	Lit	PCI module #2	Fatal 2. 5-V power voltage alarm (upper limit)	
Cor1 +3. 3vAl m 00	Amber	Blink	PCI module #2	3. 3-V power voltage alarm (lower limit)	
Cor1 +3. 3vAl m 02	Amber	Lit	PCI module #2	Fatal 3. 3-V power voltage alarm (lower limit)	
Cor1 +3. 3vAl m 07	Amber	Blink	PCI module #2	3. 3-V power voltage alarm (upper limit)	
Cor1 +3. 3vAl m 09	Amber	Lit	PCI module #2	Fatal 3. 3-V power voltage alarm (upper limit)	
Cor1 +3. 3vsAl m 00	Amber	Blink	PCI module #2	3. 3-V power voltage alarm (lower limit)	
Cor1 +3. 3vsAl m 02	Amber	Lit	PCI module #2	Fatal 3. 3-V power voltage alarm (lower limit)	
Cor1 +3. 3vsAl m 07	Amber	Blink	PCI module #2	3. 3-V power voltage alarm (upper limit)	
Cor1 +3. 3vsAl m 09	Amber	Lit	PCI module #2	Fatal 3. 3-V power voltage alarm (upper limit)	
Cor1 +5. 0vAl m 00	Amber	Blink	PCI module #2	5-V power voltage alarm (lower limit)	
Cor1 +5. 0vAl m 02	Amber	Lit	PCI module #2	Fatal 5-V power voltage alarm (lower limit)	
Cor1 +5. 0vAl m 07	Amber	Blink	PCI module #2	5-V power voltage alarm (upper limit)	
Cor1 +5. 0vAl m 09	Amber	Lit	PCI module #2	Fatal 5-V power voltage alarm (upper limit)	
Cor1 +5. 0vsAl m 00	Amber	Blink	PCI module #2	5-V power voltage alarm (lower limit)	
Cor1 +5. 0vsAl m 02	Amber	Lit	PCI module #2	Fatal 5-V power voltage alarm (lower limit)	
Cor1 +5. 0vsAl m 07	Amber	Blink	PCI module #2	5-V power voltage alarm (upper limit)	
Cor1 +5. 0vsAl m 09	Amber	Lit	PCI module #2	Fatal 5-V power voltage alarm (upper limit)	
Cor1 -12vAl m 00	Amber	Blink	PCI module #2	-12-V power voltage alarm (lower limit)	
Cor1 -12vAl m 02	Amber	Lit	PCI module #2	Fatal -12-V power voltage alarm (lower limit)	

Indication	STATUS LED		Suspected module	Explanation	Procedure
	Color	State			
Cor1 -12vAl m 07	Amber	Blink	PCI module #2	-12-V power voltage alarm (upper limit)	Contact your sales agent.
Cor1 -12vAl m 09	Amber	Lit	PCI module #2	Fatal -12-V power voltage alarm (upper limit)	
Cor1 Bus PERR 01	Green	Blink	PCI module #2	PCI bus parity error	
Cor1 Bus SERR 01	Green	Blink	PCI module #2	Fatal PCI bus error	
Cor1 CLK Al m 00	Amber	Blink	CLOCK board	Cl ock alarm (lower limit)	
Cor1 CLK Al m 02	Amber	Lit	CLOCK board	Fatal Cl ock alarm (lower limit)	
Cor1 CLK Al m 07	Amber	Blink	CLOCK board	Cl ock alarm (upper limit)	
Cor1 CLK Al m 09	Amber	Lit	CLOCK board	Fatal Cl ock alarm (upper limit)	
Cor1 FAN Al m 01	Amber	Blink	PCI module #2	Cooling fan1 alarm	
Cor1 FAN Al m 02	Amber	Blink	PCI module #2	Cooling fan2 alarm	
Cor1 FAN Al m 03	Amber	Blink	PCI module #2	Cooling fan3 alarm	
Cor1 FAN Al m 04	Amber	Blink	PCI module #2	Cooling fan4 alarm	
Cor1 FAN Al m 05	Amber	Blink	PCI module #2	Cooling fan5 alarm	
Cor1 offl ine	Green	Blink	PCI module #2	PCI module logically isolated	Start the PCI module by ft sever utility or dismount and remount that module. If not solved by the above, contact your sales agent.
Cor1 removed	Green	Blink	PCI module #2	PCI module detached	Dismount and remount the PCI module. If not solved by the above, contact your sales agent.
Cor1 Temp Al m 00	Amber	Blink	PCI module #2	Temperature alarm (lower limit)	Check to see if dust is accumulated on the internal fans. Check also if the fan cables are connected securely. If not solved by the above, contact your sales agent.
Cor1 Temp Al m 02	Amber	Lit	PCI module #2	Fatal temperature alarm (lower limit)	
Cor1 Temp Al m 07	Amber	Blink	PCI module #2	Temperature alarm (upper limit)	
Cor1 Temp Al m 09	Amber	Lit	PCI module #2	Fatal temperature alarm (upper limit)	
CPU IERR 00	Green	Blink	CPU module #1	CPU#1 internal error	Contact your sales agent.
CPU IERR 01	Green	Blink	CPU module #1	CPU#2 internal error	
CPU IERR 20	Green	Blink	CPU module #2	CPU#1 internal error	
CPU IERR 21	Green	Blink	CPU module #2	CPU#2 internal error	
CPU T-Tri p 00	Green	Blink	CPU module #1	CPU#1 thermal change error (upper limit)	
CPU T-Tri p 01	Green	Blink	CPU module #1	CPU#2 thermal change error (upper limit)	
CPU T-Tri p 20	Green	Blink	CPU module #2	CPU#1 thermal change error (upper limit)	
CPU T-Tri p 21	Green	Blink	CPU module #2	CPU#2 thermal change error (upper limit)	
CPU0 +12ss Al m 00	Amber	Blink	CPU module #1	+12-V power voltage alarm (lower limit)	
CPU0 +12ss Al m 02	Amber	Lit	CPU module #1	Fatal +12-V power voltage alarm (lower limit)	

7-8 Troubleshooting

Indication	STATUS LED		Suspected module	Explanation	Procedure
	Color	State			
CPU0 +12ss AI m 07	Amber	Blink	CPU module #1	+12-V power voltage alarm (upper limit)	Contact your sales agent.
CPU0 +12ss AI m 09	Amber	Lit	CPU module #1	Fatal +12-V power voltage alarm (upper limit)	
CPU0 +12v AI m 00	Amber	Blink	CPU module #1	12-V power voltage alarm (lower limit)	
CPU0 +12v AI m 02	Amber	Lit	CPU module #1	Fatal 12-V power voltage alarm (lower limit)	
CPU0 +12v AI m 07	Amber	Blink	CPU module #1	12-V power voltage alarm (upper limit)	
CPU0 +12v AI m 09	Amber	Lit	CPU module #1	Fatal 12-V power voltage alarm (upper limit)	
CPU0 +1.5v AI m 00	Amber	Blink	CPU module #1	1.5-V power voltage alarm (lower limit)	
CPU0 +1.5v AI m 02	Amber	Lit	CPU module #1	Fatal 1.5-V power voltage alarm (lower limit)	
CPU0 +1.5v AI m 07	Amber	Blink	CPU module #1	1.5-V power voltage alarm (upper limit)	Contact your sales agent.
CPU0 +1.5v AI m 09	Amber	Lit	CPU module #1	Fatal 1.5-V power voltage alarm (upper limit)	
CPU0 +2.5v AI m 00	Amber	Blink	CPU module #1	2.5-V power voltage alarm (lower limit)	
CPU0 +2.5v AI m 02	Amber	Lit	CPU module #1	Fatal 2.5-V power voltage alarm (lower limit)	
CPU0 +2.5v AI m 07	Amber	Blink	CPU module #1	2.5-V power voltage alarm (upper limit)	
CPU0 +2.5v AI m 09	Amber	Lit	CPU module #1	Fatal 2.5-V power voltage alarm (upper limit)	
CPU0 +2.5Vc AI m 00	Amber	Blink	CPU module #1	2.5-V power voltage alarm (lower limit)	
CPU0 +2.5Vc AI m 02	Amber	Lit	CPU module #1	Fatal 2.5-V power voltage alarm (lower limit)	
CPU0 +2.5Vc AI m 07	Amber	Blink	CPU module #1	2.5-V power voltage alarm (upper limit)	
CPU0 +2.5Vc AI m 09	Amber	Lit	CPU module #1	Fatal 2.5-V power voltage alarm (upper limit)	
CPU0 +3.3v AI m 00	Amber	Blink	CPU module #1	3.3-V power voltage alarm (lower limit)	
CPU0 +3.3v AI m 02	Amber	Lit	CPU module #1	Fatal 3.3-V power voltage alarm (lower limit)	
CPU0 +3.3v AI m 07	Amber	Blink	CPU module #1	3.3-V power voltage alarm (upper limit)	
CPU0 +3.3v AI m 09	Amber	Lit	CPU module #1	Fatal 3.3-V power voltage alarm (upper limit)	
CPU0 +3.3vs AI m 00	Amber	Blink	CPU module #1	3.3-V power voltage alarm (lower limit)	
CPU0 +3.3vs AI m 02	Amber	Lit	CPU module #1	Fatal 3.3-V power voltage alarm (lower limit)	
CPU0 +3.3vs AI m 07	Amber	Blink	CPU module #1	3.3-V power voltage alarm (upper limit)	
CPU0 +3.3vs AI m 09	Amber	Lit	CPU module #1	Fatal 3.3-V power voltage alarm (upper limit)	
CPU0 +5.0v AI m 00	Amber	Blink	CPU module #1	5-V power voltage alarm (lower limit)	
CPU0 +5.0v AI m 02	Amber	Lit	CPU module #1	Fatal 5-V power voltage alarm (lower limit)	

Indication	STATUS LED		Suspected module	Explanation	Procedure
	Color	State			
CPU0 +5.0vAlm 07	Amber	Blink	CPU module #1	5-V power voltage alarm (upper limit)	Contact your sales agent.
CPU0 +5.0vAlm 09	Amber	Lit	CPU module #1	Fatal 5-V power voltage alarm (upper limit)	
CPU0 +5.0vSAIm 00	Amber	Blink	CPU module #1	5-V power voltage alarm (lower limit)	
CPU0 +5.0vSAIm 02	Amber	Lit	CPU module #1	Fatal 5-V power voltage alarm (lower limit)	
CPU0 +5.0vSAIm 07	Amber	Blink	CPU module #1	5-V power voltage alarm (upper limit)	
CPU0 +5.0vSAIm 09	Amber	Lit	CPU module #1	Fatal 5-V power voltage alarm (upper limit)	
CPU0 broken	Green	Blink	CPU module #1	CPU module breakdown	
CPU0 FAN Alm 01	Amber	Blink	CPU module #1	Cooling fan1 alarm	Check to see if dust is accumulated on the internal fans. Check also if the fan cables are connected securely. If not solved by the above, contact your sales agent.
CPU0 FAN Alm 03	Amber	Blink	CPU module #1	Cooling fan2 alarm	
CPU0 FAN Alm 04	Amber	Blink	CPU module #1	Cooling fan3 alarm	
CPU0 offline	Green	Blink	CPU module #1	PCI module logically isolated	Start the PCI module by ft sever utility or dismount and remount that module. If not solved by the above, contact your sales agent.
CPU0 removed	Green	Blink	CPU module #1	PCI module detached	Dismount and remount the PCI module. If not solved by the above, contact your sales agent.
CPU0 Temp Alm 00	Amber	Blink	CPU module #1	Temperature alarm (lower limit)	Check to see if dust is accumulated on the internal fans. Check also if the fan cables are connected securely. If not solved by the above, contact your sales agent.
CPU0 Temp Alm 02	Amber	Lit	CPU module #1	Fatal temperature alarm (lower limit)	
CPU0 Temp Alm 07	Amber	Blink	CPU module #1	Temperature alarm (upper limit)	
CPU0 Temp Alm 09	Amber	Lit	CPU module #1	Fatal temperature alarm (upper limit)	
CPU0 VccpAlm 00	Amber	Blink	CPU module #1	CPU operating voltage alarm (lower limit) (VCCP)	Contact your sales agent.
CPU0 VccpAlm 02	Amber	Lit	CPU module #1	Fatal CPU operating voltage alarm (lower limit) (VCCP)	
CPU0 VccpAlm 07	Amber	Blink	CPU module #1	CPU operating voltage alarm (upper limit) (VCCP)	
CPU0 VccpAlm 09	Amber	Lit	CPU module #1	Fatal CPU operating voltage alarm (upper limit) (VCCP)	
CPU0 Vtt Alm 00	Amber	Blink	CPU module #1	1.25-V power voltage alarm (lower limit)	
CPU0 Vtt Alm 02	Amber	Lit	CPU module #1	Fatal 1.25-V power voltage alarm (lower limit)	
CPU0 Vtt Alm 07	Amber	Blink	CPU module #1	1.25-V power voltage alarm (upper limit)	
CPU0 Vtt Alm 09	Amber	Lit	CPU module #1	Fatal 1.25-V power voltage alarm (upper limit)	

7-10 Troubleshooting

Indication	STATUS LED		Suspected module	Explanation	Procedure	
	Color	State				
CPU00 Temp Al m 00	Amber	Blink	CPU module #1	CPU#1 temperature alarm (lower limit)	Check to see if dust is accumulated on the internal fans. Check also if the fan cables are connected securely. If not solved by the above, contact your sales agent.	
CPU00 Temp Al m 02	Amber	Lit	CPU module #1	CPU#1 fatal temperature alarm (lower limit)		
CPU00 Temp Al m 07	Amber	Blink	CPU module #1	CPU#1 temperature alarm (upper limit)		
CPU00 Temp Al m 09	Amber	Lit	CPU module #1	CPU#1 fatal temperature alarm (upper limit)		
CPU01 Temp Al m 00	Amber	Blink	CPU module #2	CPU#2 temperature alarm (lower limit)		
CPU01 Temp Al m 02	Amber	Lit	CPU module #2	CPU#2 fatal temperature alarm (lower limit)		
CPU01 Temp Al m 07	Amber	Blink	CPU module #2	CPU#2 temperature alarm (upper limit)		
CPU01 Temp Al m 09	Amber	Lit	CPU module #2	CPU#2 fatal temperature alarm (upper limit)		
CPU2 +12ss Al m 00	Amber	Blink	CPU module #2	12-V power voltage alarm (lower limit)		Contact your sales agent.
CPU2 +12ss Al m 02	Amber	Lit	CPU module #2	Fatal 12-V power voltage alarm (lower limit)		
CPU2 +12ss Al m 07	Amber	Blink	CPU module #2	12-V power voltage alarm (upper limit)		
CPU2 +12ss Al m 09	Amber	Lit	CPU module #2	Fatal 12-V power voltage alarm (upper limit)		
CPU2 +12v Al m 00	Amber	Blink	CPU module #2	12-V power voltage alarm (lower limit)		
CPU2 +12v Al m 02	Amber	Lit	CPU module #2	Fatal 12-V power voltage alarm (lower limit)		
CPU2 +12v Al m 07	Amber	Blink	CPU module #2	12-V power voltage alarm (upper limit)		
CPU2 +12v Al m 09	Amber	Lit	CPU module #2	Fatal 12-V power voltage alarm (upper limit)		
CPU2 +1.5vAl m 00	Amber	Blink	CPU module #2	1.5-V power voltage alarm (lower limit)		
CPU2 +1.5vAl m 02	Amber	Lit	CPU module #2	Fatal 1.5-V power voltage alarm (lower limit)		
CPU2 +1.5vAl m 07	Amber	Blink	CPU module #2	1.5-V power voltage alarm (upper limit)		
CPU2 +1.5vAl m 09	Amber	Lit	CPU module #2	Fatal 1.5-V power voltage alarm (upper limit)		
CPU2 +2.5vAl m 00	Amber	Blink	CPU module #2	2.5-V power voltage alarm (lower limit)	Contact your sales agent.	
CPU2 +2.5vAl m 02	Amber	Lit	CPU module #2	Fatal 2.5-V power voltage alarm (lower limit)		
CPU2 +2.5vAl m 07	Amber	Blink	CPU module #2	2.5-V power voltage alarm (upper limit)		
CPU2 +2.5vAl m 09	Amber	Lit	CPU module #2	Fatal 2.5-V power voltage alarm (upper limit)		

Indication	STATUS LED		Suspected module	Explanation	Procedure
	Color	State			
CPU2 +2. 5VcAI m00	Amber	Blink	CPU module #2	2.5-V power voltage alarm (lower limit)	Contact your sales agent.
CPU2 +2. 5VcAI m02	Amber	Lit	CPU module #2	Fatal 2.5-V power voltage alarm (lower limit)	
CPU2 +2. 5VcAI m07	Amber	Blink	CPU module #2	2.5-V power voltage alarm (upper limit)	
CPU2 +2. 5VcAI m09	Amber	Lit	CPU module #2	Fatal 2.5-V power voltage alarm (upper limit)	
CPU2 +3. 3vAI m00	Amber	Blink	CPU module #2	3. 3-V power voltage alarm (lower limit)	
CPU2 +3. 3vAI m02	Amber	Lit	CPU module #2	Fatal 3. 3-V power voltage alarm (lower limit)	
CPU2 +3. 3vAI m07	Amber	Blink	CPU module #2	3. 3-V power voltage alarm (upper limit)	
CPU2 +3. 3vAI m09	Amber	Lit	CPU module #2	Fatal 3. 3-V power voltage alarm (upper limit)	
CPU2 +3. 3vsAI m00	Amber	Blink	CPU module #2	3. 3-V power voltage alarm (lower limit)	
CPU2 +3. 3vsAI m02	Amber	Lit	CPU module #2	Fatal 3. 3-V power voltage alarm (lower limit)	
CPU2 +3. 3vsAI m07	Amber	Blink	CPU module #2	3. 3-V power voltage alarm (upper limit)	
CPU2 +3. 3vsAI m09	Amber	Lit	CPU module #2	Fatal 3. 3-V power voltage alarm (upper limit)	
CPU2 +5. 0vAI m00	Amber	Blink	CPU module #2	5-V power voltage alarm (lower limit)	
CPU2 +5. 0vAI m02	Amber	Lit	CPU module #2	Fatal 5-V power voltage alarm (lower limit)	
CPU2 +5. 0vAI m07	Amber	Blink	CPU module #2	5-V power voltage alarm (upper limit)	
CPU2 +5. 0vAI m09	Amber	Lit	CPU module #2	Fatal 5-V power voltage alarm (upper limit)	
CPU2 +5. 0vsAI m00	Amber	Blink	CPU module #2	5-V power voltage alarm (lower limit)	
CPU2 +5. 0vsAI m02	Amber	Lit	CPU module #2	Fatal 5-V power voltage alarm (lower limit)	
CPU2 +5. 0vsAI m07	Amber	Blink	CPU module #2	5-V power voltage alarm (upper limit)	
CPU2 +5. 0vsAI m09	Amber	Lit	CPU module #2	Fatal 5-V power voltage alarm (upper limit)	
CPU2 broken	Green	Blink	CPU module #2	CPU module breakdown	Check to see if dust is accumulated on the internal fans. Check also if the fan cables are connected securely. If not solved by the above, contact your sales agent.
CPU2 FAN AI m 01	Amber	Blink	CPU module #2	Cooling fan 1 alarm	
CPU2 FAN AI m 03	Amber	Blink	CPU module #2	Cooling fan 2 alarm	
CPU2 FAN AI m 04	Amber	Blink	CPU module #2	Cooling fan 3 alarm	Start the PCI module by ft sever utility or dismount and remount that module. If not solved by the above, contact your sales agent.
CPU2 offl ine	Green	Blink	CPU module #2	The CPU module has been logically disconnected.	

7-12 Troubleshooting

Indication	STATUS LED		Suspected module	Explanation	Procedure	
	Color	State				
CPU2 removed	Green	Blink	CPU module #2	The CPU module has come off.	Dismount and remount the PCI module. If not solved by the above, contact your sales agent.	
CPU2 Temp Al m 00	Amber	Blink	CPU module #2	Temperature alarm (lower limit)	Check to see if dust is accumulated on the internal fans. Check also if the fan cables are connected securely. If not solved by the above, contact your sales agent.	
CPU2 Temp Al m 02	Amber	Lit	CPU module #2	Fatal temperature alarm (lower limit)		
CPU2 Temp Al m 07	Amber	Blink	CPU module #2	Temperature alarm (upper limit)		
CPU2 Temp Al m 09	Amber	Lit	CPU module #2	Fatal temperature alarm (upper limit)		
CPU2 VccpAl m 00	Amber	Blink	CPU module #2	CPU operating voltage alarm (lower limit) (VCCP)	Contact your sales agent.	
CPU2 VccpAl m 02	Amber	Lit	CPU module #2	Fatal CPU operating voltage alarm (lower limit) (VCCP)		
CPU2 VccpAl m 07	Amber	Blink	CPU module #2	CPU operating voltage alarm (upper limit) (VCCP)		
CPU2 VccpAl m 09	Amber	Lit	CPU module #2	Fatal CPU operating voltage alarm (upper limit) (VCCP)		
CPU2 VttAl m 00	Amber	Blink	CPU module #2	1.25-V power voltage alarm (lower limit)		
CPU2 VttAl m 02	Amber	Lit	CPU module #2	Fatal 1.25-V power voltage alarm (lower limit)		
CPU2 VttAl m 07	Amber	Blink	CPU module #2	1.25-V power voltage alarm (upper limit)		
CPU2 VttAl m 09	Amber	Lit	CPU module #2	Fatal 1.25-V power voltage alarm (upper limit)		
CPU20 TempAl m 00	Amber	Blink	CPU module #1	CPU#1 temperature alarm (lower limit)		Check to see if dust is accumulated on the internal fans. Check also if the fan cables are connected securely. If not solved by the above, contact your sales agent.
CPU20 TempAl m 02	Amber	Lit	CPU module #1	Fatal CPU#1 temperature alarm (lower limit)		
CPU20 TempAl m 07	Amber	Blink	CPU module #1	CPU#1 temperature alarm (upper limit)		
CPU20 TempAl m 09	Amber	Lit	CPU module #1	Fatal CPU#1 temperature alarm (upper limit)		
CPU21 TempAl m 00	Amber	Blink	CPU module #2	CPU#2 temperature alarm (lower limit)		
CPU21 TempAl m 02	Amber	Lit	CPU module #2	Fatal CPU#2 temperature alarm (lower limit)		
CPU21 TempAl m 07	Amber	Blink	CPU module #2	CPU#2 temperature alarm (upper limit)		
CPU21 TempAl m 09	Amber	Lit	CPU module #2	Fatal CPU#2 temperature alarm (upper limit)		
= D =						
DUMP Request!	Off		-	DUMP switch request	Contact your sales agent.	
= F =						
FRB Processi ng	Off		-	During POST execution or OS start processing	The server is operating normally.	

Indication	STATUS LED		Suspected module	Explanation	Procedure
	Color	State			
= M =					
Memory U-Err 01	Green	Blink	CPU module #1	DIMM#1 2-bit error	The DIMM must be replaced. Contact a maintenance service company.
Memory U-Err 02	Green	Blink	CPU module #1	DIMM#2 2-bit error	
Memory U-Err 03	Green	Blink	CPU module #1	DIMM#3 2-bit error	
Memory U-Err 04	Green	Blink	CPU module #1	DIMM#4 2-bit error	
Memory U-Err 05	Green	Blink	CPU module #1	DIMM#5 2-bit error	
Memory U-Err 06	Green	Blink	CPU module #1	DIMM#6 2-bit error	
Memory U-Err 21	Green	Blink	CPU module #2	DIMM#1 2-bit error	
Memory U-Err 22	Green	Blink	CPU module #2	DIMM#2 2-bit error	
Memory U-Err 23	Green	Blink	CPU module #2	DIMM#3 2-bit error	
Memory U-Err 24	Green	Blink	CPU module #2	DIMM#4 2-bit error	
Memory U-Err 25	Green	Blink	CPU module #2	DIMM#5 2-bit error	
Memory U-Err 26	Green	Blink	CPU module #2	DIMM#6 2-bit error	
= 0 =					
OS shutdown Al m	Off		-	Shutdown due to a timeout error of the watch dog timer (fatal error)	Contact your sales agent.
= P =					
Power-off	Off		-	The DC power is turned off.	-
= S =					
SSR Processi ng	Off		-	Reboot processing for recovery	DUMP is being collected.
= W =					
WDT ti meout	Off		-	Timeout error of the watch dog timer (fatal error)	Contact your sales agent.

POST Error Messages

Powering on the server automatically starts the self-diagnostic program, POST (Power On Self-Test). When POST detects any error, it displays an error message and its measure on the display unit. Follow the table below to troubleshoot such errors.

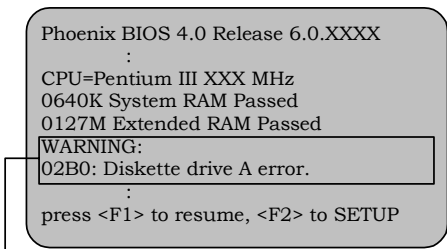

Message indicating a floppy disk drive error

TIPS: For error messages on optional PCI board, refer to the manual provided with those options.

On-screen error message	Cause	Action
0200 Failure Fixed Disk	<ul style="list-style-type: none"> • Configuration error in Setup menu. • Hard disk is faulty. • CPU module board is faulty. • PCI module board is faulty. 	<ul style="list-style-type: none"> • Check configuration in Setup menu. • Replace the hard disk. • Replace the CPU module board. • Replace the PCI module board.
0210 Stuck Key	Keyboard connection error	<ul style="list-style-type: none"> • Disconnect the keyboard and connect it back again. • Replace the keyboard. • Replace the PCI module board.
0211 Keyboard error	Keyboard is faulty.	<ul style="list-style-type: none"> • Check the keyboard connection. • Restart the server. • Replace the PCI module board.
0212 Keyboard Controller Failed	Keyboard controller is faulty.	
0213 Keyboard locked - Unlock key switch	Keyboard is locked.	Unlock the key switch.
0220 Monitor type does not match CMOS - Run SETUP	Illegal monitor type is specified.	<ul style="list-style-type: none"> • Select "Get Default Value" from the Setup menu. • Clear the CMOS data.
0230 System RAM Failed at offset	DIMM is faulty.	<ul style="list-style-type: none"> • Replace DIMM. • Replace the CPU module board.
0231 Shadow RAM Failed at offset	DIMM is faulty.	<ul style="list-style-type: none"> • Replace DIMM. • Replace the CPU module board.

On-screen error message	Cause	Action
0232 Extend RAM Failed at address line	DIMM is faulty.	<ul style="list-style-type: none"> • Replace DIMM. • Replace the CPU module board.
0233 Memory type mixing detected	DIMMs of the different types are installed.	Replace DIMM with appropriate one.
0234 Single - bit ECC error	DIMM is faulty.	<ul style="list-style-type: none"> • Replace DIMM. • Replace the CPU module board.
0235 Multiple - bit ECC error	DIMM is faulty.	<ul style="list-style-type: none"> • Replace DIMM. • Replace the CPU module board.
0250 System battery is dead -Replace and run SETUP	NvRAM battery is dead.	Replace the PCI module board.
0251 System CMOS checksum bad-Default configuration used	NvRAM is faulty.	<ul style="list-style-type: none"> • Re-configure using the Setup menu. • Replace the PCI module board.
0252 Password checksum bad -Password cleared	NvRAM is faulty.	<ul style="list-style-type: none"> • Re-set the password in the Setup menu. • Replace the PCI module board.
0260 System timer error	PCI module board is faulty.	Replace the PCI module board.
0270 Real time clock error	RTC is faulty.	Replace the PCI module board.
0271 Check date and time setting	Date and time of RTC are incorrectly set.	<ul style="list-style-type: none"> • Set the correct date and time in Setup menu. • Replace the PCI module board.
0280 Previous boot incomplete -Default configuration used	Configuration error in Setup menu.	Check configuration in Setup menu.
02B0 Diskette drive A error	Floppy drive A is faulty.	Replace the floppy disk drive A.
02B2 Incorrect Drive A type - run SETUP	Configuration error in Setup menu.	Specify the correct drive type in Setup menu.
02D0 System cache error - Cache disabled	<ul style="list-style-type: none"> • CPU is faulty. • CPU module board is faulty. 	<ul style="list-style-type: none"> • Replace the CPU. • Replace the CPU module board.
0B1B PCI System Error on Bus/Device/Function	PCI device is faulty.	<ul style="list-style-type: none"> • Replace the PCI board. • Re-install the PCI board.
0B1C PCI Parity Error on Bus/Device/Function	PCI device is faulty.	<ul style="list-style-type: none"> • Re-configure the PCI board. • Replace the PCI module board.
0B22 CPUs are installed out of order	CPU is faulty.	Replace the CPU.
0B28 Unsupported Processor detected on Processor 1	The processor (CPU) not supported by this server is installed in Processor 1.	Install the CPU appropriate to the server.

On-screen error message	Cause	Action
0B29 Unsupported Processor detected on Processor 2	The processor (CPU) not supported by this server is installed in Processor 2.	Install the CPU appropriate to the server.
0B30 CPU FAN #1 Alarm occurred	<ul style="list-style-type: none"> • Dusts are clogged in fan. • Fan is faulty. • CPU module board is faulty. 	<ul style="list-style-type: none"> • Replace the fan. • Replace the CPU module board. • Connect fan cable properly.
0B31 CPU FAN #2 Alarm occurred		
0B32 CPU FAN #3 Alarm occurred	<ul style="list-style-type: none"> • Dusts are clogged in fan. • Fan is faulty. • CPU module board is faulty. 	<ul style="list-style-type: none"> • Replace the fan. • Replace the CPU module board. • Connect fan cable properly.
0B40 Invalid System Configuration Data	<ul style="list-style-type: none"> • Configuration error in SETUP. • CPU/PCI module board is faulty. 	<ul style="list-style-type: none"> • Reset the setting by selecting [Yes] at [Reset Configuration Data] • Replace the CPU/PCI module board.
0B41 System Configuration Data Read error	<ul style="list-style-type: none"> • Configuration error in SETUP. • CPU/PCI module board is faulty. 	<ul style="list-style-type: none"> • Reset the setting by selecting [Yes] at [Reset Configuration Data] • Replace the CPU/PCI module board.
0B42 Resource Conflict	Configuration error in SETUP.	Correct device configuration in SETUP
0B43 Warning: IRQ not configured	Configuration error in SETUP.	Correct settings in SETUP
0B44 Expansion Rom not initialized	Configuration error in SETUP.	In SETUP, disable decompression of expansion ROM on unnecessary optional PCI cards.
0B45 System Configuration Data Write error	<ul style="list-style-type: none"> • Configuration error in SETUP. • CPU/PCI module board is faulty. 	<ul style="list-style-type: none"> • Reset the setting by selecting [Yes] at [Reset Configuration Data] • Replace the CPU/PCI module board.
0B47 Missing date and time synchronization	The date and time are incorrect due to a communication error between BMCs.	<ul style="list-style-type: none"> • Restart the system. • Re-set the date and time in SETUP. If the error persists, replace the PCI module board.
0B49 BMC Issued Reset Command, but failed System Reset	<ul style="list-style-type: none"> • System cannot be reset by BMC's reset command. 	Replace PCI module board.
0B6E DIMMs are installed out of order	<ul style="list-style-type: none"> • DIMM is faulty. 	Replace DIMM.
0B70 The error occurred during temperature sensor reading	<ul style="list-style-type: none"> • SMBus device is faulty. • SMBus is faulty. 	Replace the CPU/PCI module or back panel board.

On-screen error message	Cause	Action
0B71 System temperature out of Range	<ul style="list-style-type: none"> Ambient temperature is out of range. Fan is faulty. CPU/PCI module board is faulty. 	<ul style="list-style-type: none"> Check the setting in SETUP Clean the fan. Replace the fan. Replace the CPU/PCI module board.
0B80 BMC Memory Test Failed	BMC is faulty.	Replace the PCI module board.
0B81 BMC Firmware Code Area CRC check failed		
0B82 BMC core Hardware failure		
0B83 BMC IBF or OBF check failed		
0B90 BMC Platform Information Area corrupted	BMC is faulty.	Replace the PCI module board.
0B91 BMC update firmware corrupted		
0B92 Internal Use Area of BMC FRU corrupted	<ul style="list-style-type: none"> SROM is faulty. BMC is faulty. 	<ul style="list-style-type: none"> Replace the back panel board. Replace the PCI module board.
0B93 BMC SDR Repository empty	BMC is faulty.	Replace the PCI module board.
0B94 IPMB signal lines do not respond		
0B95 BMC FRU device failure		
0B96 BMC SDR Repository failure		
0B97 BMC SEL device failure		
0B98 BMC SEL Overflow		
0BB0 SMBIOS - SROM data read error	<ul style="list-style-type: none"> SROM is faulty. Back panel board is faulty. 	Replace the back panel board.
0BB1 SMBIOS - SROM data checksum bad		
0BD0 1st SMBus device address not acknowledged	PCI module board #1 is faulty.	<ul style="list-style-type: none"> Check cable connection. Replace the board.
0BD1 1st SMBus device Error detected		
0BD2 1st SMBus timeout		
0BD3 2nd SMBus device address not acknowledged	CPU module board #1 is faulty.	
0BD4 2nd SMBus device Error detected		
0BD5 2nd SMBus timeout		

On-screen error message	Cause	Action	
0BD6 3rd SMBus device address not acknowledged	-	<ul style="list-style-type: none"> • Check cable connection. • Replace the board. 	
0BD7 3rd SMBus device Error detected			(3rd SMBus does not exist)
0BD8 3rd SMBus timeout			
0BD9 4th SMBus device address not acknowledged	CPU module board #2 is faulty.		
0BDA 4th SMBus device Error Detected			
0BDB 4th SMBus device timeout			
0BDC 5th SMBus device address not acknowledged	-		
0BDD 5th SMBus device Error detected			(5th SMBus does not exist)
0BDE 5th SMBus timeout			
0BDF 6th SMBus device address not acknowledged	-		
0BE0 6th SMBus device Error detected			(6th SMBus does not exist)
0BE1 6th SMBus timeout			
0BE2 7th SMBus device address not acknowledged	Back panel board is faulty.		
0BE3 7th SMBus device Error detected			
0BE4 7th SMBus timeout			
0BE5 8th SMBus device address not acknowledged	PCI module board #2 is faulty.		
0BE6 8th SMBus device Error detected			
0BE7 8th SMBus timeout			
0BF0 Vendor ID cannot be retrieved from BP IDPROM	Back panel board is faulty.	Replace the back panel board.	
0BF1 System Structure cannot be retrieved from BP IDPROM			
0C00 Rompiilot reports error number xx	<ul style="list-style-type: none"> • Configuration error in SETUP. • CPU/PCI module board is faulty. 	<ul style="list-style-type: none"> • Re-configure Rompiilot. • Replace the CPU/PCI module board. 	
8600 No working DQS value found	<ul style="list-style-type: none"> • DIMM is faulty • DIMM is not supported 	<ul style="list-style-type: none"> • Replace DIMM • Replace DIMM with appropriate one. 	

On-screen error message	Cause	Action
8610 MAC Address update failed – Corel/O#0 10/100Mbit Ethernet Controller	FRB2 timeout occurred when setting MAC address, and rewrite was unsuccessful.	<ul style="list-style-type: none"> • Replace the back panel board. • Replace the PCI module board 1.
8611 MAC Address update failed – Corel/O#0 Gbit Ethernet Controller	FRB2 timeout occurred when setting MAC address, and rewrite was unsuccessful.	<ul style="list-style-type: none"> • Replace the back panel board. • Replace the PCI module board 1.
8612 MAC Address update failed – Corel/O#1 10/100 Mbit Ethernet Controller	FRB2 timeout occurred when setting MAC address, and rewrite was unsuccessful.	<ul style="list-style-type: none"> • Replace the back panel board. • Replace the PCI module board 2.
8613 MAC Address update failed – Corel/O#1 Gbit Ethernet Controller	FRB2 timeout occurred when setting MAC address, and rewrite was unsuccessful.	<ul style="list-style-type: none"> • Replace the back panel board. • Replace the PCI module board 2.

Error Notification by BEEP

An error message may not be displayed on the display unit even though the POST detected an error. In such a case, the beep sounds notifies you an error. The error contents are indicated by the combination of beep sound patterns. For example, beep sounds once, consecutively three times, once, and then once (beep code: 1-3-1-1) indicates DRAM refresh test error.

The following table lists the meaning of beep codes and measures against them.

Beep code	Meaning	Action
1-2-2-3	ROM checksum error	Contact your sales agent to replace the CPU module board.
1-1-2-4	ROMEXEC code error	Check the installation of DIMM board. If the error persists, contact your sales agent to replace the DIMM or CPU module board.
1-3-1-1	DRAM refresh test error	
1-3-1-3	Keyboard controller error	Disconnect the keyboard and connect it back on. If the error persists, request your sales agent to replace the CPU module board.
1-3-3-1	Failed to detect memory. Or, DIMM board type is incorrect.	Check the installation of DIMM board. If the error persists, contact your sales agent to replace the DIMM or CPU module board.
1-3-3-2	Initial setting error of the POST memory manager	
1-3-4-1	RAM address error	
1-3-4-3	RAM low byte data error	
1-4-1-1	RAM high byte data error	
2-2-3-1	Illegal interrupt test error	Contact your sales agent.
2-1-2-3	Copyright check error	
1-2	Failed to initialize the video BIOS	Check the motherboard installation if nothing is displayed on the display unit. If the error persists, contact your sales agent to replace the CPU module board.
	Failed to initialize the option ROM	Check the PCI board installation if the Option ROM of the added PCI board is not displayed. If the error persists, contact your sales agent to replace the CPU module board, PCI module board or added PCI board with new one.
	Failed to expand the option ROM	

Linux Error Messages

NEC Express5800/ft series displays messages on the console window when failures occur. Also, the same information is recorded as system logs.

The following indicates the syslog messages, messages on the console, their meanings and actions:

Message	Meaning	Action
FT[dev.no] opstate SIMPLEX to DUPLEX	The status changed from SIMPLEX to DUPLEX	The server is operating normally.
FT[dev.no] opstate ONLINE to DUPLEX	The status changed from ONLINE to DUPLEX	
FT[dev.no] opstate INITIALIZING to DUPLEX	The status changed from INITIALIZING to DUPLEX	
FT[dev.no] opstate BROKEN to DUPLEX	The status changed from BROKEN to DUPLEX	
FT[dev.no] opstate INITIALIZING to DIAGNOSTICS	The status changed from INITIALIZING to DIAGNOSTICS	
FT[dev.no] opstate INITIALIZING to ONLINE	The status changed from INITIALIZING to ONLINE	
FT[dev.no] opstate ONLINE to INITIALIZING	The status changed from ONLINE to INITIALIZING	
FT[dev.no] opstate DIAGNOSTICS to DIAGNOSTICS_PASSED	Diagnostics have completed	
FT[dev.no] opstate UNKNOWN to INITIALIZING	The status changed from UNKNOWN to INITIALIZING	
FT[dev.no] opstate SIMPLEX to BROKEN	The status changed from SIMPLEX to BROKEN	Contact your sales agent.
FT[dev.no] opstate UNKNOWN to EMPTY	The status changed from UNKNOWN to EMPTY	
FT[dev.no] opstate INITIALIZING to BROKEN	Failed to start the device	Start the server again. If the problem persists, contact your sales agent.
FT[dev.no] operation BRINGUP failed	Failed to start the device.	Start the server again. If the problem persists, contact your sales agent.

Message	Meaning	Action
FT[dev.no] info error initializing PCI slots	Failed to initialize the PCI slot.	There is no problem if any devices are not connected to the PCI slot. In other cases, a board may be faulty. Contact your sales agent.
FT[dev.no] info unable to access all offline memory	HW status is invalid.	Contact your sales agent.
FT[dev.no] info unable to clear hardware reset		
FT[dev.no] info unable to collect inventory		
FT[dev.no] info unable to configure chipset		
FT[dev.no] info unable to copy shadow memory		
FT[dev.no] info unable to map BIOS		
FT[dev.no] info unable to map firmware		
FT[dev.no] info unable to power on CRU		
FT[dev.no] info unable to read gpr0		
FT[dev.no] info unable to set DIMM SPD		
FT[dev.no] info unable to read system MAC address	Unable to read MAC address from the device's NIC.	Contact your sales agent.
FT[dev.no] info BIOS incompatible	BIOS status is invalid.	Contact your sales agent.
FT[dev.no] info BIOS mismatch		
FT[dev.no] info multiple BIOS miscompare		
FT[dev.no] info failed to update firmware	The device's firmware is invalid.	Contact your sales agent.
FT[dev.no] info firmware does not match		
FT[dev.no] info firmware file error		
FT[dev.no] info firmware image invalid		

SOLVING PROBLEMS

When the server fails to operate as expected, see the following to find out your problem and follow the given instruction before asking for repair.

If the server still fails to operate successfully after solving your problem, take a note on the on-screen message and contact your sales agent.

Problems with NEC Express5800/ft series

Fail to power on the server:

- Is the server properly supplied with power?
 - Check if the power cord is connected to a power outlet (or UPS) that meets the power specifications for the server.
 - Check if the two pieces of the provided power cord are connected to the main unit properly.
 - Make sure to use the power cord provided with the server. Check the power cord for broken shield or bent plugs.
 - Make sure the power breaker for the connected power outlet is on.
 - If the power cord is plugged to a UPS, make sure the UPS is powered and it supplies power. See the manual that comes with the UPS for details.

Power supply to the server may be linked with the connected UPS using the BIOS setup utility of the server.

<Menu to check: [System Hardware] → [AC-LINK] → [Power On]>
 - Make sure the POWER switch on the power unit is on.
- Did you press the POWER switch?
 - Press the POWER switch on the front of the NEC Express5800/ft series to turn on the power (the POWER LED lights).
- Did you install the CPU/PCI module properly?
 - Check if the CPU/PCI module is properly installed in the server. Secure the module with screw located on the module handle.

Fail to power off the server:

- Is the POWER switch enabled?
 - Restart the server and start the BIOS setup utility.
 - <Menu to check: [Security] → [Power Switch Mask] → [Unmasked]>
- Are you trying to turn off the power other than by pressing the POWER switch?
 - You cannot turn off the power of the server using the software command (e.g., Shutdown command). Press the POWER switch to turn off.

POST fails to complete:

- Is the DIMM installed?
 - At least a pair of DIMMs is required for operation.
- Is the memory size large?
 - The memory check may take a time if the memory size is large. Wait for a while.
- Did you perform any keyboard or mouse operation immediately after you started the server?
 - If you perform any keyboard or mouse operation immediately after start-up, POST may accidentally detect a keyboard controller error and stops proceeding. In such a case, restart the server once again. Do not perform any keyboard or mouse operation until the BIOS start-up message appears when you restart the server.
- Does the server have appropriate memory boards or PCI card?
 - Operation of the server with unauthorized devices is not guaranteed.

Fail to access to internal or external devices:

- Are cables properly connected?
 - Make sure that the interface cables and power cord are properly connected. Also make sure that the cables are connected in the correct order.
- Is that device compliant with NEC Express5800/ft series?
 - Operation of the server with unauthorized devices is not guaranteed.
- Is the power-on order correct?
 - When the server has any external devices connected, power on the external devices first, then the server.
- Did you install drivers for connected optional devices?
 - Some optional devices require specific device drivers. Refer to the manual that comes with the device to install its driver.

- Some optional devices connected to the serial port require settings for I/O port address and operation mode. Refer to the manual that comes with the device to configure the device.

<Menu to check: [Advanced] → [Peripheral Configuration]>

- Is SCSI controller configuration correct?
 - If the SCSI devices are connected to the built-in SCSI controller, check the setting from the BIOS setup utility.
- Is SCSI device configuration correct?
 - If external SCSI devices are connected to the server, you need to make settings of SCSI ID and terminal resistance. For details, see manuals included with the SCSI device.
- Does the SCSI driver recognize the target devices?
 - Execute the following command to check if the SCSI driver recognizes the target devices.

```
>cat /proc/scsi/scsi
```
- Is a driver which supports the SCSI device loaded to kernel?
 - Execute the following command to check if a driver which supports the SCSI device is loaded to kernel.

```
>lsmod
```

CPU not in Dual mode:

- Check if the memory configuration is correct.
- Check if third-party CPUs or memory (DIMM) are used.

Disk not in Dual mode:

- Unless you perform mirroring (including reconfiguration after failed disks are replaced) in correct order, the mirror may not be [re]configured. Check if the steps were correct.

The keyboard or mouse fails to operate:

- Is the cable properly connected?
 - Make sure that the cable is connected to the correct connector on the rear of the server.
- Are the keyboard and mouse are compliant with NEC Express5800/ft series?
 - Operation of the server with unauthorized devices is not guaranteed.
- Is BIOS configuration correct?
 - The keyboard and mouse may be disabled with the BIOS setup utility of the server. Check the settings with the BIOS setup utility.
 <Menu to check: [Advanced] → [Keyboard Features]>
- Does the server have drivers installed?
 - Refer to the manual that comes with your OS to check that the keyboard and mouse drivers are installed. (These drivers are installed along with the OS.) Some OS's allow you to change the keyboard and mouse settings. Refer to manual that comes with your OS to check that the keyboard and mouse settings are correct.
- Are you using a PS2-USB conversion connector?
 - The PS2-USB conversion connector is not supported. Use the keyboard and mouse that are specified by NEC.
- Is the server switch unit connected at the time of system installation?
 - If the server switch unit s has been connected when reinstalling the system, gpm service starts on startup but a mouse is not available. Select the USB 3-button mouse using mouseconfig command and then restart gpm using the following command. The mouse becomes available after restart.
 >service gpm restart

Screen freezes, keyboard and mouse don't work:

- If the amount of memory is large, it takes time to copy the memory in dual mode and the system stops working during the copying. It's not system trouble.

Fail to access (read or write) to the floppy disk:

- Does the floppy disk drive contain a floppy disk?
 - Insert a floppy disk into the floppy disk drive until it clicks.
- Is the floppy disk write-protected?
 - Place the write-protect switch on the floppy disk to the "Write-enabled" position.
- Is the floppy disk formatted?
 - Use a formatted floppy disk or format the floppy disk in the floppy disk drive. Refer to the manual that comes with the OS for formatting a floppy disk.

If you still cannot access to the floppy disk using the methods above, perform the following operation and check if the floppy disk becomes accessible:

1. Login to the system as a user with a root authority.

2. Create a directory using the following command.

```
# mkdir /mnt/floppy
```

There is no problem if the message, indicating that the directory has already been created, is displayed after executing the command.

3. Execute the following command.

```
# modprobe usb-storage
```

4. Execute the following command to check that you can access to the floppy disk.

```
# mount /dev/sdg /mnt/floppy
```

This is an example when sdg recognizes the USB floppy device and the floppy disk is formatted in MS-DOS.

If the floppy disk becomes accessible by the procedure above, add the following to `/etc/rc.d/rc.modules` in order to make `usb-storage` be loaded automatically. By adding the following line, the floppy disk drive can be mounted by performing step 4 above.

```
modprobe usb-storage
```

Fail to access to the CD-ROM:

- Is the CD-ROM properly set in the CD-ROM drive tray?

→ The tray is provided with a holder to secure the CD-ROM. Make sure that the CD-ROM is placed properly in the holder.

- Is the CD-ROM applicable to the server?

→ The CD-ROM for Macintosh is not available for use.

- Is the PCI module disconnected (offline)?

→ You cannot use the CD-ROM drive on the disconnected PCI module. Also, if you try to mount the CD-ROM drive on the disconnected PCI module, the OS displays the following error and continues to try installing the CD-ROM drive based on the information of the status of the PCI module not duplicated. As a result, you will not be able to access to the CD-ROM drive even after the PCI module is duplicated. (System restart is required for recovery.)

```
status timeout: status=0xff {Busy}
```

```
drive not ready for command
```

```
ATAPI reset timed-out, status=0xff
```

```
reset timed-out, status=0xff
```

- Is the CD-ROM device mounted?
 - Perform the following procedure and check if you can access to the CD-ROM again.
 1. Login to the system as a user with a root authority.
 2. Set a CD-ROM to the CD-ROM drive on the PCI module (Group 1), and then execute the following command:

```
#mount /mnt/cdrom
```

If you use the CD-ROM drive on the PCI module (Group 2), execute the following command:

```
#mount /mnt/cdrom1
```
- Is proper device mounted?
 - Mount /mnt/cdrom to use the PCI module (Group 1), or /mnt/cdrom1 to use the PCI module (Group 2).

Fail to access the hard disk:

- Is the hard disk applicable to the server?
 - Operation of any device that is not authorized by NEC is not guaranteed.
- Is the hard disk properly installed?
 - Make sure to lock the hard disk with the lever on its handle. The hard disk is not connected to the internal connector when it is not completely installed (see Chapter 8). When the hard disk is properly installed, the drive power LED for the hard disk is lit while the server is powered.

Fail to start the OS:

- Is a floppy disk in the floppy disk drive?
 - Take out the floppy disk and restart the server.
- Is the NEC EXPRESSBUILDER CD-ROM in the CD-ROM drive?
 - Take out the NEC EXPRESSBUILDER CD-ROM and restart the server.
- Is the OS damaged?
 - Try to recover the system by executing fsck, referring to “System Repair” in the separate volume of User’s Guide (Setup).
- Is grub used?
 - Check that /etc/grub.conf is configured properly.

OS behavior is unstable:

- Have you changed kernel?
 - Make sure that you have not applied patches for general kernel or you have not changed the kernel installed for the device.

- Are you accessing to the directories or files under /dev or /proc?
 - NEC Express5800/ft series frequently saves and updates the information on the system operation and management at the following directories. Thus, if you access the directories or files under the following directories, for example, by using command, it may affect the fault-tolerant feature and cause the system to become unstable. Make sure not to access to the directories or files.

```
/dev/mem  
/proc/kcore  
/proc/bus  
/proc/ft/bb/cpu[0,1]/dump  
/proc/ide
```

Cannot install Linux properly:

- Did you follow the precautions for installation?
 - Read the precautions for installation again.

- Did you install Linux with the proper procedure?
 - Check the installation procedure again. Make sure to install Linux with the proper procedure.

Cannot read the character on the console after the PCI failover caused by the PCI module failure:

- Infrequently, the character on the console screen may be distorted at the time of PCI module failover. It does not affect any operations of the device. Execute the following command:

```
>/sbin/setsysfont
```

The server repeats rebooting at system startup:

- Is the value of [Boot Monitoring Time-out Period] in the BIOS setting appropriate?
 - Change the value of [Boot Monitoring Time-out Period] to suit your environment.
For details, see Chapter 4 “SYSTEM BIOS - SETUP ~”.)

Disk access LEDs on the disks are off:

- The LEDs may seem to be off when an excessive amount of access causes the frequent blinking. Check if the LEDs are blinking green when the access is reduced, or the LEDs are green when the access is stopped.

LAN cards which are not used (LAN cables are not connected) appears to be in error status:

- The system judges that ports are out of order when LAN cards in the ports are connected to the server but are not used (or their cables are not connected). Therefore, Ethernet board status on the NEC ESMPRO Manager's Data Viewer ([FTServer] – [PCI Module] – [Ethernet adapter]) is red (error) and the server status on the Operation Window of NEC ESMPRO Manager is also red (error). To prevent such misjudgment, connect unused LAN cards to each other by cross LAN cables and run "vndctl add 4", and "vndctl up 4".

Event Log

“I/O error” is recorded in the log at OS startup

The following message may be displayed on the screen or recorded in the log if a USB floppy disk drive is connected at OS startup. However, this will not impact operations (in the description below, * represents an alphanumeric character).

Partition Check:

```
sdg:<6> I/O error: dev **:**, Command *****, sector 0
I/O error : dev **:**, Command *****, sector 0
unable to read partition table
```

ESMCpuPerf-related logs are recorded in the system event log:

- If NEC ESMPRO Agent cannot get performance information from the OS due to a temporary resource shortage or high load ratio on the system, it will record the following event log. However, the operations are not affected (in the description, Y and X represent alphanumeric characters. YYYY may not be obtained).

```
Source:      ESMCpuPerf
Event ID:    9005
Description: Cannot get system performance information now (YYYY
              Code=xxxx).
```

If NEC ESMPRO Agent cannot get information, it will treat the load ratio as 0%. So, if NEC ESMPRO Agent cannot get information continuously, the CPU load ratio may appear lower than the actual value.

EvtAgnt log is recorded in the application event log:

- This event does not have any influence on the system, not on SNMP services. Thus no measurement is required.

```
Source:      EvtAgnt
ID:          1003
Description: TraceFileName parameter not located in registry; Default trace file
              used is .
```

```
Source:      EvtAgnt
ID:          1015
Description: TraceLevel parameter not located in registry; Default trace level
```

used is 32.

“APIC error” is recorded in the syslog by the operations such as inserting/removing disks:

- A message “APIC error” may be recorded to the log or displayed on the screen when you perform operations such as inserting/removing disks with the server powered on, because the internal status managed by the OS and the actual status on the server side are different. The operations are not affected.

“info synchronization error” is recorded while the CPU modules are being synchronized:

- A message “info synchronization error” may be recorded in the log when the CPU modules are performing duplication because the internal status managed by the OS and the actual status on the server side are different. The operations are not affected.

“card reports no resources” log is recorded when using the built-in LAN board:

- A message “card reports no resources” may be output to the log when the system cannot allocate the resource for the LAN driver due to high load ratio on the network access. The operations are not affected. LAN driver performs retry automatically thus the system continues communication without disconnecting the network connection.

“I/O error” is recorded in the syslog by the cable disconnection during the access to the Fibre Channel disk:

- When the Fibre Channel connected to the primary PCI module Cable is disconnected during the access to the Fibre Channel disk, logs may be recorded, which seem that “SCSI disk (/dev/sdd**)I/O error”(**) represent numbers) occurred on the devices which are not running because the internal status managed by the OS and the actual status on the server side are different. The operations are not affected.

Problems with NEC EXPRESSBUILDER

When the server is not booted from the NEC EXPRESSBUILDER CD-ROM, check the following:

- Did you set the NEC EXPRESSBUILDER CD-ROM during POST and restart the server?
 - If you do not set the NEC EXPRESSBUILDER CD-ROM during POST and restart the server, an error message will appear or the OS will boot.
- Is BIOS configuration correct?
 - The boot device order may be specified with the BIOS setup utility of the server. Use the BIOS setup utility to change the boot device order to boot the system from the CD-ROM drive first.
 - <Menu to check: [Boot]>

When an error occurs while the NEC EXPRESSBUILDER is in progress, the following message appears. After this message appears, check the error and take the appropriate corrective action according to the error codes listed in the table below.

Message	Cause and Remedy
This machine is not supported.	This NEC EXPRESSBUILDER version is not designed for this server. Execute the NEC EXPRESSBUILDER on the compliant server.
NvRAM access error	An access to the nonvolatile memory (NvRAM) is not acceptable.
Hard disk access error	The hard disk is not connected or it is failed. Check whether the hard disk is correctly connected.

An error message will also be displayed when an error was detected during system diagnosis. Take a note or print the error message displayed, and contact your sales agent.

Problems with Master Control Menu

Failed to read online documentation

- Is HTML browser installed properly?
 - Online documentation is an HTML-format file. Install the HTML browser (Internet Explorer 5.x or later) in your operating system.
- Is Adobe Acrobat Reader installed properly?
 - A part of online documentation is supplied in PDF file format. Install the Adobe Acrobat Reader (Version 4.05 or later) in your operating system. You can also install the Adobe Acrobat Reader using the NEC EXPRESSBUILDER. Launch the Master Control Menu and select [Setup] → [Adobe Acrobat Reader].

Image of online documentation is not clear

- Is your display unit set to display 256 colors or more?
 - Set the display unit to display 256 colors or more.

The master control menu fails to appear:

- Is your system Windows NT 4.0 or later, or Windows 95 or later?
 - The CD-ROM Autorun feature is supported by Windows NT 4.0 and Windows 95. The older versions do not automatically start from the CD-ROM.
- Is **Shift** pressed?
 - Setting the CD-ROM with **Shift** pressed down cancels the Autorun feature.
- Is the system in the proper state?
 - The menu may not appear depending on the system registry setting or the timing to set the CD-ROM. In such a case, start the Internet Explorer and run \MC\1ST.EXE in the CD-ROM.

Problems with NEC ESMPRO

NEC ESMPRO Agent

→ See Chapter 5.

NEC ESMPRO Manager

→ See Chapter 5. See also online document in NEC EXPRESSBUILDER CD-ROM for troubleshooting and other supplementary information.

COLLECTION OF TROUBLE LOGS

In the event of trouble, you can get information in the procedures described below:

IMPORTANT:

- You can perform the procedures described below only when you are asked by your maintenance personnel to get trouble logs.
 - When the system restarts after the trouble, it may show a message that there is a shortage of virtual memory. However, continue the system startup. If you reset and restart the system, you cannot get correct information.
-

Collection of syslog

The log file of Linux is created under the following directory in text format:

`/var/log/`

The log file of NEC Express5800/ft series is also created in this directory, as with general log file of Linux.

Collection of System Information

The system information of Linux is recorded in syslog, etc. To collect the system information on the NEC Express5800/ft series, login to the system as a user with a root authority and then execute the following command:

```
# logcollector
```

Collection of the Memory Dump

If a failure occurs, the memory data should be dumped to acquire the required information.

IMPORTANT:

- Consult with your sales agent before dumping the memory. Executing memory dumping while the server is in the normal operation may affect the system operation.
- Restarting the system due to an error may display a message indicating insufficient virtual memory. Ignore this message and proceed. Restarting the system again may result in dumping improper data.

Preparing for Memory Dump

Memory dumping with the DUMP switch may disable the server to restart. In such a case, it is required to force the server to shut down. This forced shutdown, however, is not available if "Masked" is selected for "Power Switch Mask" on the Security menu of the BIOS setup utility, SETUP, because this setting disables POWER switch operation.

Follow the procedure below to change the setting to enable the forced shutdown and restart of the server.

1. Power on the server and start the BIOS setup utility, SETUP.
2. Select "Unmasked" for "Power Switch Mask" in the Security menu.
3. Save the configuration data and exit the SETUP.

Saving Dump Files

Press the DUMP switch to save the dump file when an error occurs. Insert a metal pin (a straightened large paper clip will make a substitute) into the switch hole to press the DUMP switch.

Pressing the DUMP switch saves the dump file in the specified directory. (Memory dumping may not be available when the CPU stalls.)

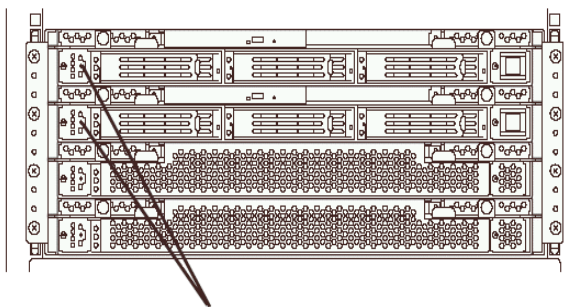

Dump switches

IMPORTANT: Do not use a toothpick or plastic stick that is easy to break.

When the DUMP switch is pressed, the system restarts and collects the memory dump.

Backup of IPMI Information

Collect the IPMI information. NEC ESMPRO Agent must be installed to collect the information.

1. Login to the system as a user with a root authority.
2. Move to the directory where the NEC ESMPRO Agent is installed.

Unless you have specified the installation destination, it is installed in “/opt/nec/esmpro_sa”. In this description, it is assumed to be installed in “/opt/nec/esmpro_sa”.

```
cd /opt/nec/esmpro_sa
```

3. Move to the directory where tools are stored.

```
cd bin
```

4. Execute the following command:

```
./xrasutil
```

ESRAS Utility will start.

5. Select <Backup the current IPMI Information...>.

The IPMI Information Backup screen will appear.

6. Enter an output destination and a comment, and then click [OK].

The information will be output to the specified location.

<Backup File Name>: Specify the path to the file on which you want to save the information. By default, the information is output to log/ipmi.dat which is under the directory where NEC ESMPRO Agent is installed.

<Comment>: Describe the information which you want to output with. (Optional)

Chapter 8

System Upgrade

This chapter describes procedures to add options and replace failed components.

IMPORTANT:

- Optional devices described in this chapter may be installed or removed by the user. However, NEC does not assume any liability for damage to optional devices or the server or malfunctions of the server resulted from installation by the user. NEC recommends you ask your sales agent to install or remove any optional devices.
 - Be sure to use only optional devices and cables designated by NEC. Repair of the server due to malfunctions, failures, or damage resulted from installing such devices or cables will be charged.
-

SAFETY PRECAUTIONS

Observe the following notes to install or remove optional devices safely and properly.

⚠ WARNING	
	<p>Observe the following instructions to use the server safely. There are risks of death or serious personal injury. See PRECAUTIONS FOR SAFETY in Chapter 1 for details.</p> <ul style="list-style-type: none">• Do not disassemble, repair, or alter the server.• Do not look into the CD-ROM drive.• Do not remove the lithium battery.• Disconnect the power plug before working with the server.

⚠ CAUTION	
	<p>Observe the following instructions to use the server safely. There are risks of fire, personal injury, or property damage. See PRECAUTIONS FOR SAFETY in Chapter 1 for details.</p> <ul style="list-style-type: none">• Do not install or remove components by a single person.• Do not install the server leaving the cover removed.• Make sure to complete component installation.• Do not pinch your finger(s).• High temperature

ANTI-STATIC MEASURES

The server contains electronic components sensitive to static electricity. Avoid failures caused by static electricity when installing or removing any optional devices.

- Wear wrist straps (arm belts or anti-static gloves).

Wear wrist straps on your wrists. If no wrist strap is available, touch an unpainted metal part of the cabinet before touching a component to discharge static electricity from your body.

Touch the metal part regularly when working with components to discharge static electricity.

- Select a suitable workspace.

- Work with the server on the anti-static or concrete floor.
- When you work with the server on a carpet where static electricity is likely to be generated, make sure take anti-static measures beforehand.

- Use a worktable.

Place the server on an anti-static mat to work with it.

- Clothes

- Do not wear a wool or synthetic cloth to work with the server.
- Wear anti-static shoes to work with the server.
- Take off any metal accessories you wear (ring, bracelet, or wristwatch) before working with the server.

- Handling of components

- Keep any component in an anti-static bag until you actually install it to the server.
- Hold a component by its edge to avoid touching any terminals or parts.
- To store or carry any component, place it in an anti-static bag.

PREPARING YOUR SYSTEM FOR UPGRADE

Note the followings, when installing or replacing devices, to improve the performance of NEC Express5800/ft series.

- With the NEC Express5800/ft series server, devices can be replaced during the continuous operation. Take extreme care for electric shock and damage to the component due to short-circuit.
- Optional devices cannot be installed or removed during continuous operation. Normally, shutdown the OS, check that the server is powered off, disconnect all power cords and interface cables from the server before installing or removing the optional devices.
- To remove the CPU or PCI module during the continuous operation, disable the intended module (place the module off-line) by using the ft server utility of the NEC ESMPRO Agent or the NEC ESMPRO Manager from the management PC on the network. After a new module is installed to the server, enable the module using the ft server utility or the NEC ESMPRO Manager.

TIPS: The system is defaulted to automatically boot the module, once installed. This setting can be changed with the ft server utility or the NEC ESMPRO Manager. For more information, see Chapter 5.

- Make sure to provide the same hardware configuration on both groups.
- Use the same slots and sockets on both groups.
- Do not install those devices having different specifications, performance, or features.
- Before removing the setscrews from the CPU and PCI modules, place the desired module off-line using the ft server utility or the NEC ESMPRO Manager.
- When replacing the CPU or PCI module, wait more than 5 minutes after removing it to mount a new module.
- When connecting a SCSI device such as a tape drive to the SCSI connector at the back of a PCI module, the server needs to be powered off.

3.5-INCH HARD DISK DRIVE

The 3.5-inch hard disk drive bay in front of the server contains six slots in which hard disks with the SCA2 interface are installed.

The figures used in this section show the rack-mount model. The orientation is the only difference from the tower model.

IMPORTANT:

- Do not use any hard disks that are not authorized by NEC. Installing a third-party hard disk may cause a failure of the server as well as the hard disk. Purchase hard disks of the same model in pair. Contact your sales agent for hard disk drives optimum for your server.
 - The OS starts from the hard disk that is mounted in Slot 1 of the primary module (whose POWER LED is on).
 - If you shut down the OS with the PCI module not duplicated, RAID of the hard disk drives may be disconnected. When starting the OS after this happened, start from the hard disk drive mounted on the PCI module which was online when the OS was shut down. (See Chapter 7 “Troubleshooting” for details).
 - When expanding hard disk drives to the 3.5-inch device bays, make sure to perform the operation of “RAID CONFIGURATION WHEN DISKS ARE ADDED” described later.
-

TIPS:

- POWER LED is on to indicate that it is the primary module.
 - The module that you plug in first will be the primary module.
-

You can install hard disks, each of which is about 25.4 mm (1 inch) in thickness, to the three slots of each PCI module. Each slot has a label describing the slot number.

Disks of the same slot number are mirrored between the groups. The figure below shows the groups and mirroring slots.

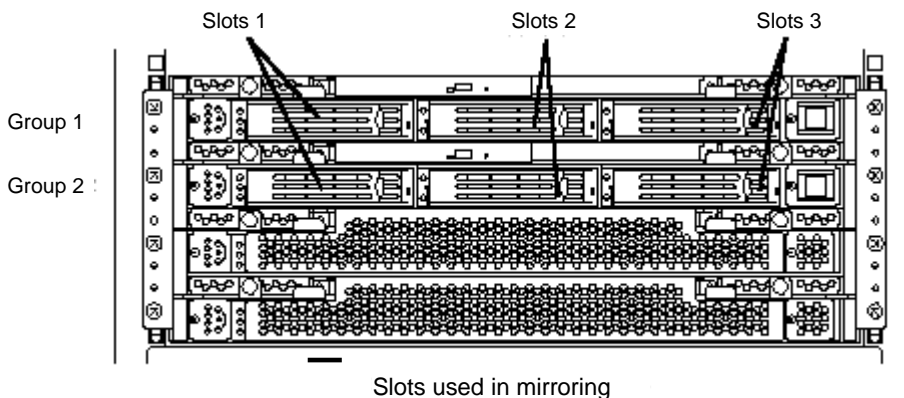

Empty slots in the 3.5-inch hard disk drive bay contain dummy trays. The dummy trays are inserted to improve the cooling effect within the device. Always insert the dummy trays in the slots in which hard disks are not installed.

Attach an HDD ID label indicating the slot number of installed hard disk to the handle of the hard disk.

Installing 3.5-inch Hard Disk Drive

Follow the procedure below to install the hard disk. A hard disk may be installed in another slot in the same procedure.

IMPORTANT:

- Make sure to read "Anti-static Measures" and "Preparing Your System for Upgrade" before starting installing or removing options.
- Install two hard disks for dual disk configuration before starting the OS. Make sure to configure the hard disks as dual disk.

1. <Tower model>

Unlock the front bezel with the security key and open it.

<Rack-mount model >

Unlock the front bezel with the security key and detach it.

2. Perform the shutdown process from the OS properly.

Execute the shutdown process using shutdown command, and then press the POWER switch to turn off the server.

3. Disconnect all the power cords from the power outlet.

4. Identify the slot to which you want to install the hard disk.

Install a hard disk in an empty slot in the group, starting from the left slot.

5. Press the lever of a dummy tray to unlock the handle. Then bring out the handle and remove the tray by pulling the handle.

All the slots except Slot 1 have a dummy tray.

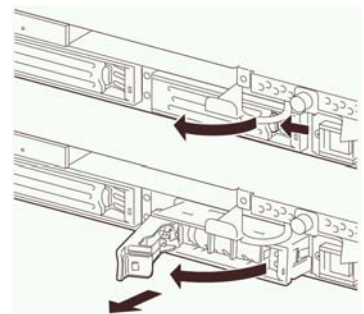

IMPORTANT: Carefully keep the removed dummy tray.

6. Unlock the hard disk to be added.

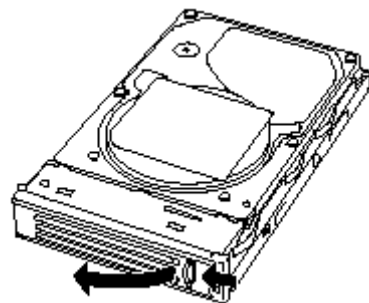

7. Firmly hold the handle of the hard disk to install and insert the hard disk into the slot.

TIPS:

- Insert the disk until the lever hook touches the server frame.
 - Check the orientation of lever. Insert the hard disk with the lever unlocked.
-

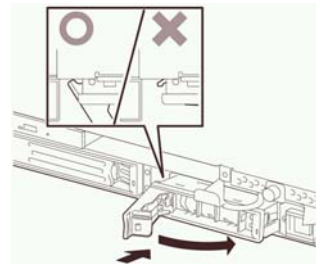

8. Slowly close the lever.

When the lever is locked, you will hear a click sound.

IMPORTANT: Be careful not to pinch your finger(s) between the lever and handle.

TIPS: Check the hook of the lever is engaged with the frame.

9. Connect all the power cords.
10. Press the POWER switch to turn on the system power.
11. <Tower model>
Close the front bezel and lock it with the security key.
<Rack-mount model>
Install the front bezel and lock it with the security key.
12. Set the dual disk configuration (see the separate volume of User's Guide).

Removing 3.5-inch Hard Disk Drive

Follow the procedure below to remove the hard disk.

IMPORTANT: Make sure to read "Anti-static Measures" and "Preparing Your System for Upgrade" before starting installing or removing options.

1. Disconnect the hard disk from RAID, referring to step 1 in "Restoring Redundant Configuration Manually" (page 3-6).
2. <Tower model>
Unlock the front bezel with the security key and open it.
<Rack-mount model>
Unlock the front bezel with the security key and detach it.
3. Perform the shutdown process from the OS properly.
Execute the shutdown process using shutdown command, and then press the POWER switch to turn off the server.
4. Push the lever of the hard disk to unlock the handle.
5. Hold the handle and hard disk to pull them off.
6. Install the dummy tray in an empty slot according to procedures described in "Installation".
Make sure to install the dummy tray in the empty slot to improve the cooling effect within the device.

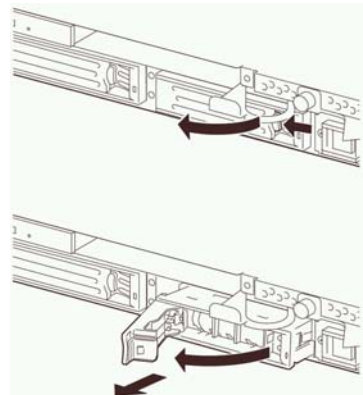

Replacing 3.5-inch Hard Disk Drive

Follow the procedure below to remove the failed hard disk. If the hard disk fails, it should be replaced with new device with the server powered-on.

IMPORTANT: Make sure to read "Anti-static Measures" and "Preparing Your System for Upgrade" before starting installing or removing options. You can replace disks during continuous operation.

Replacing the Hard Disk Drive

1. Locate the failed hard disk.

When a hard disk fails, the DISK LED on the hard disk drive's handle illuminates green, while the DISK LED of the other mirrored disk illuminates amber.

The DISK Access LED of the disk whose DISK LED is amber also illuminates amber.

TIPS: Even if a hard disk fails, the DISK LEDs may not illuminate as described above. See "How to Locate Failed Disks" in Chapter 3 to identify failed disks.

2. Referring to steps 1 and 2 in "Restoring Redundant Configuration Manually" (page 3-6), disconnect the failed hard disk from RAID and then remove it.

No need to shutdown the OS.

3. Refer to the steps in "Installing the hard disk" to install a new hard disk.

TIPS: The hard disk to be installed for replacement must have the same specifications as its mirroring hard disk.

4. Restore the redundant configuration (see Chapter 3).

RAID CONFIGURATION WHEN DISKS ARE ADDED

When disks are added, `ftdiskadm` is used for RAID configuration. The following is an example of adding disks to Slot3 of Group1 and Group2 by using `ftdiskadm`:

(Example)

```
# ftdiskadm
Command action
  1 => SCSI
  2 => RAID
  3 => Environment
  9 Quit

Command: 2

Command action
  1 Status(Raid)
  2 Status(All Disks)
  3 Repair Disk
  4 New Disks
  5 Remove Half Disk
  6 Remove Full Disks
  9 <= RETURN

Command: 4

[New Disks]
* Which scsi SLOT? [1-6] 3(*1)
scsi add-single-device 10 0020
* Input the LABEL [1-12 character(s)] extra(*2)

Making the disk partiton table: SLOT=3 SIZE=17343(MB)
  Reserved for the last partition: SIZE=1024(MB)
* How many partitions? [1-14] 3(*3)
  * Input the SIZE of partition 1 [1- 16319(MB)] 1024
  * Input the SIZE of partition 2 [1- 15296(MB)] 2048
      partition 3          14272
* Are you sure to create it? [y/n] y
```

After selecting “y”, RAID configuration starts, and unless there is any problem, the process completes. The status of RAID can be viewed by the above “Raid Status”.

- *1 Before entering the slot number, make sure the disk and the other disk of the pair are inserted to the SCSI slots.
- *2 When necessary, enter a disk label. When the disk is to be used as a single partition, the disk label will be used as entered here. If the disk is to be divided to multiple partitions, “*entered value_s<partition number>*” will be used. However, disk labels may be changed by using commands including `e2label`.
- *3 Enter a number of partitions to divide the disk. Then enter the size in MB for each partition. For the last partition, the remaining value will be assigned automatically. The partition number begins with 1 and the next number will be 5 and the rest will be in ascending order. A certain size of partition is reserved for the last partition. Thus the range of specifiabile value is smaller than the actual disk capacity. In addition, the actual partition size changes little depending on the disk structure.

Check the disk status to confirm that the disk is added successfully.

```
Command action
 1 Status(Raid)
 2 Status(All Disks)
 3 Repair Disk
 4 New Disks
 5 Remove Half Disk
 6 Remove Full Disks
 9 <= RETURN

Command: 1

[Status(Raid)]
-----
name  partition  label      status      member
md0   /boot      /boot      DUPLEX      (1)sda1 (4)sdd1
md1   /usr       /usr       DUPLEX      (1)sda5 (4)sdd5
md2   /home     /home     DUPLEX      (1)sda10 (4)sdd10
md3   /var      /var      DUPLEX      (1)sda6 (4)sdd6
md4   /         /         DUPLEX      (1)sda8 (4)sdd8
md5   /tmp      /tmp      DUPLEX      (1)sda9 (4)sdd9
md6   /swap     /swap     DUPLEX      (1)sda7 (4)sdd7
md7           extra_s1  RESYNC(9.3%) (3)sdc1 (6)sdf1
md8           extra_s5  RESYNC      (3)sdc5 (6)sdf5
md9           extra_s6  RESYNC      (3)sdc6 (6)sdf6
-----

Command action
 1 Status(Raid)
 2 Status(All Disks)
 3 Repair Disk
 4 New Disks
 5 Remove Half Disk
 6 Remove Full Disks
 9 <= RETURN

Command:
```

CPU MODULE

Concerning the CPU module, you can add or replace the following components, or CRU (customer-replaceable units):

- CPU (processor)
- DIMM (memory)

Remove the CPU module to install or remove these devices. The figures used in this section show the rack-mount model. The orientation is the only difference from the tower model.

IMPORTANT:

- Ask your sales agent to replace the CPU module and components of the CPU module.
 - Make sure to read "Anti-static Measures" and "Preparing Your System for Upgrade" before installing or removing options.
 - To install or remove CPU or DIMM, first power off the server before removing the CPU module. The procedures described below are for replacement of DIMMs.
 - Removing the module being operating may cause unexpected trouble. Use the management software (e.g., ft server utility or NEC ESMPRO Manager) to identify the module to be removed so that the module is removed when it is stopped, without fail
Then remove the relevant module after verifying the status LED on the CPU module.
 - Handle the module fixing screw with your hand, not by using any tool.
 - If you have replaced the module, attach an HDD ID label indicating the replaced module number to the upper part of the fixing screw of the module.
-

PRECAUTIONS:

When replacing a PCI module and a CPU module, replace one module and wait until dual configuration is established to replace the other module. If you replace the both modules simultaneously, dual configuration of either CPU modules or PCI modules may fail. (See Chapter 7 "Troubleshooting".)

Removing CPU Module

Follow the procedure below to remove the CPU module.

1. Stop the CPU module you want to remove.

To this end, use the ft server utility of the NEC ESMPRO Agent installed to your server or the Data Viewer of the NEC ESMPRO Manager.

For the detailed procedure, see "NEC ESMPRO Agent and Manager" - "Maintenance of NEC Express5800/ft series" in Chapter 5.

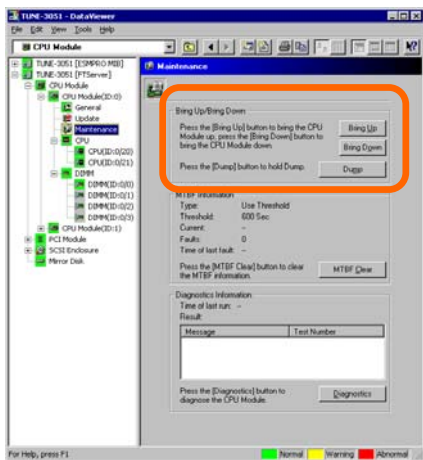

NEC ESMPRO Manager

Select [FTServer] → [CPU Module] → [CPU Module (to be removed)] → [Maintenance] → [Bring Up/Bring Down] → [Bring Down].

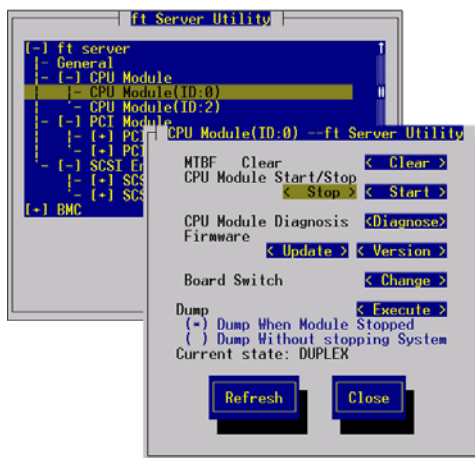

ft server utility

Select [ft server] → [CPU Module] → [CPU Module (to be removed)] → [CPU Module Start/Stop] → [Stop].

After the CPU module enters into off-line status, the status LED will change as follows.

Fail LED: Red

State LED: Off

2. <Tower model>

Unlock the front bezel with the security key and open it.

<Rack-mount model>

Unlock the front bezel with the security key and detach it.

3. Loosen the setscrews that secured the CPU module's release levers.

4. Hold the release levers of the CPU module and pull them.

The CPU module is slightly pulled out toward you.

IMPORTANT: Do not hold other parts than the release levers to pull the module.

5. Pull off the module halfway slowly. Pushing down the latch lever on the side to unlock it, pull the module off the rack.

IMPORTANT: Carefully handle the CPU module so that you will not drop it or strike it against other server internal devices.

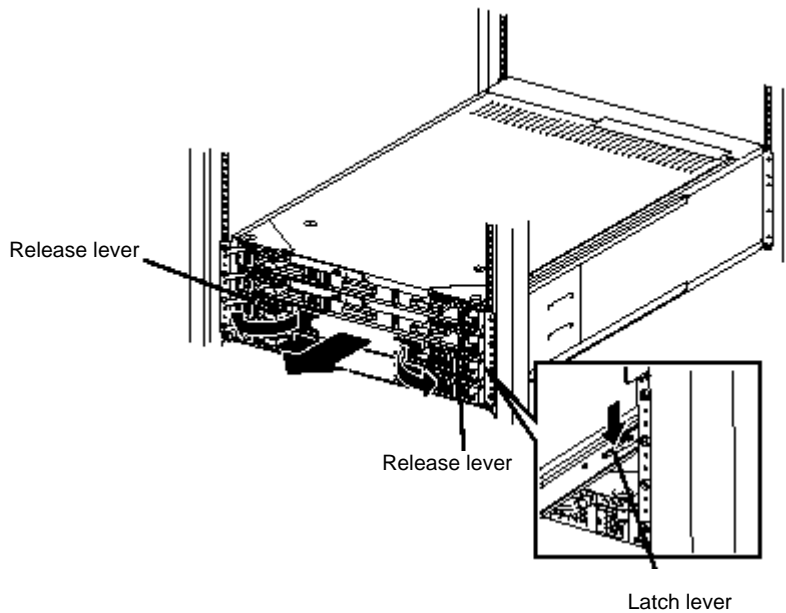

6. Carefully place the CPU module on the flat and sturdy table.
Avoid the dusty or humid place.
7. Remove the two setscrews on the front of the CPU module and one setscrew on the back.

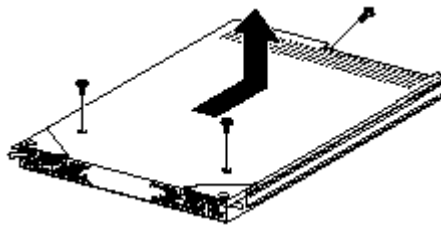

8. Slide the top cover a little to remove it.

This allows you to access the devices in the CPU module. For more information on how to handle these devices, see the associated sections.

Installing CPU Module

Follow the procedure below to install the CPU module:

IMPORTANT: Make sure to read "Anti-static Measures" and "Preparing Your System for Upgrade" before starting installing or removing options.

1. Install the top cover to the CPU module.

TIPS: Check the left, right, and upper tabs on the top cover are certainly engaged with the CPU module.

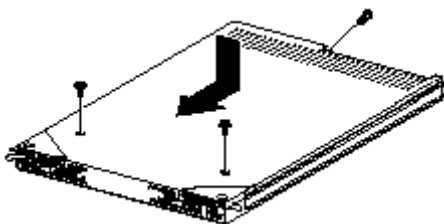

2. Secure the top cover to the CPU module with the three setscrews.
3. Firmly hold the CPU module with both hands and insert it into the server.

Hold the module in such a way that its back panel connector faces the back of the rack and engage the guides of the module and chassis to insert it slowly.

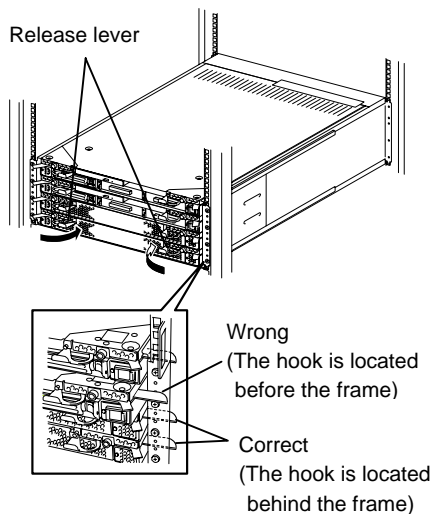

4. Hold the release lever to push the module as far as it goes.

- Close the release levers.

IMPORTANT: Unless the release levers are located inside the rack frame, the module won't be mounted correctly.

- Screw the release levers.
- Boot the installed CPU module.

The system is defaulted to automatically boot the CPU module, once installed.

If the automatic feature is disabled, boot the CPU module using the ft server utility of the NEC ESMPRO Agent installed to the server or the Data Viewer of the NEC ESMPRO Manager.

For the detailed procedure, see "NEC ESMPRO Agent and Manager" - "Maintenance of NEC Express5800/ft series" in Chapter 5.

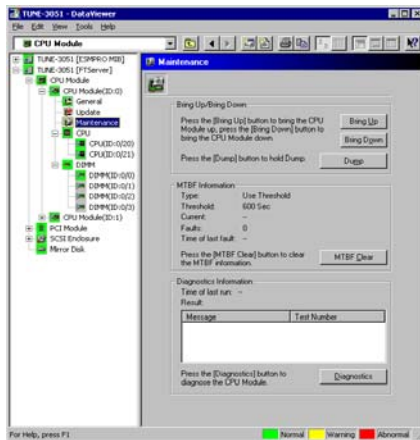

NEC ESMPRO Manager

Select [FTServer] → [CPU Module] → [(installed) CPU Module] → [Maintenance] → [Bring Up/Bring Down] → [Bring Up].

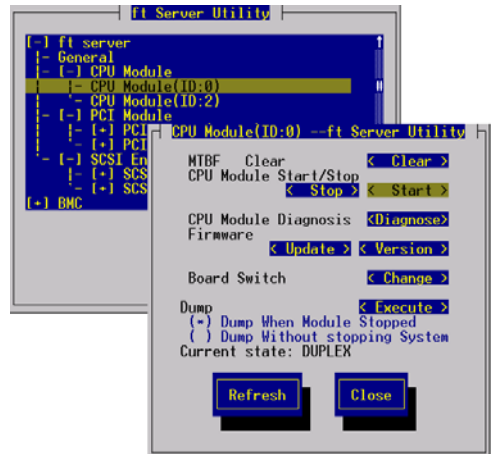

ft server utility

Select [ft server] → [CPU Module] → [(installed) CPU Module] → [CPU Module Start/Stop] → [Start].

DIMM

The DIMM (dual inline memory module) is installed to the DIMM socket in the CPU module on the NEC Express5800/ft series.

The CPU module board is equipped with six sockets. Two standard 256MB DIMMs are mounted in DIMM#1 and #2 each. (The standard DIMM can be replaced with another DIMM.)

DIMMs should be installed to these sockets, starting from the lowest socket number.

TIPS:

- The memory capacity can be increased up to 6 GB (six 1 GB DIMMs).
 - In the error messages and logs in POST, NEC ESMPRO, or Off-line Maintenance Utility, the DIMM connector may be described as “group”. The number next to “group” corresponds to the connector numbers shown in the figure below.
-

IMPORTANT:

- The DIMM is extremely sensitive to static electricity. Make sure to touch the metal frame of the server to discharge static electricity from your body before handling the DIMM. Do not touch the DIMM terminals or on-board parts with a bare hand or place the DIMM directly on the desk. For static notes, see the section "Anti-static Measures" described earlier.
 - Make sure to use the DIMM authorized by NEC. Installing a third-party DIMM may cause a failure of the DIMM as well as the server. Repair of the server due to failures or damage resulted from installing such a board will be charged.
 - Before adding or removing DIMMs, power off the server and detach the CPU module.
 - Make sure to read "Anti-static Measures" and "Preparing Your System for Upgrade" before installing or removing options.
-

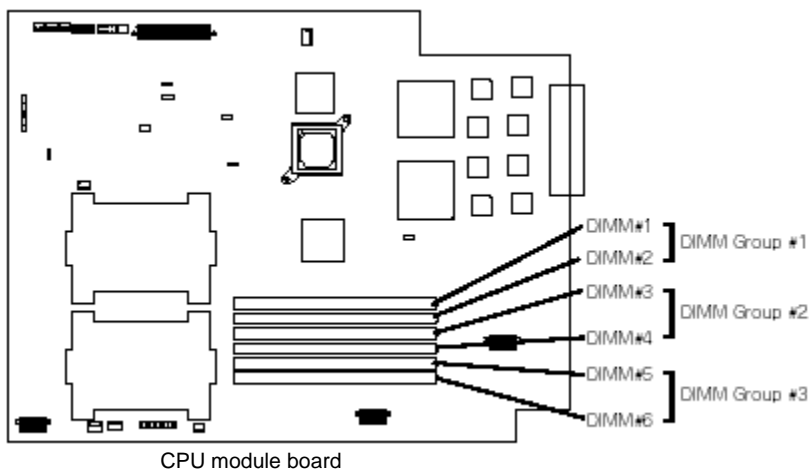

Note the followings to install or replace DIMM.

- The DIMMs with the same number are linked among the groups. When a DIMM is added to one group, another identical DIMM should be installed to the socket with the same number in another group. This rule is applied to the case of removal.
- The linked DIMMs should be of the same product with same performance.
- DIMMs should be installed in sockets, starting from the lowest socket number.

Installing DIMM

Follow the procedure below to install the DIMM. Make sure to power off the server before starting installation except when replacing DIMM.

1. Shutdown OS.
Press the POWER switch to turn off the server.
2. Disconnect power cord from outlet.
3. Remove the CPU module.
4. Check to be sure in which socket you are mounting the DIMM.
5. Remove the connector cover from the socket.

A DIMM connector cover is installed to the open socket. When the levers on both ends of the connector are opened, the DIMM connector cover is unlocked and you can remove the cover.

IMPORTANT: Carefully keep the removed DIMM connector cover.

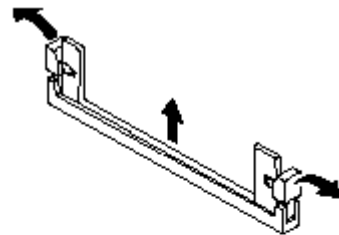

6. Insert a DIMM into the DIMM socket straight.

TIPS: Pay attention to the orientation of the DIMM. The terminal of the DIMM has a cutout to prevent misinsertion.

After the DIMM is completely inserted into the socket, the levers are automatically closed.

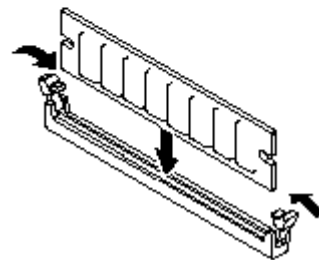

7. Mount the CPU module.
8. Connect the power cords.
9. Press POWER switch to power on the module.
10. Verify that POST displays no error messages.

If POST displays an error message, take a note on the message and see the POST error messages listed in Chapter 7.

Removing DIMM

Follow the procedure below to remove the DIMM. Make sure to power off the server before installation except when replacing DIMM.

TIPS: Unless at least two DIMMs are installed, the server does not work.

1. Shutdown OS.
Press the POWER switch to turn off the server.
2. Disconnect power cord from outlet.
3. Remove the CPU module.
4. Open the levers on the target DIMM socket. The DIMM is unlocked and you can remove it.

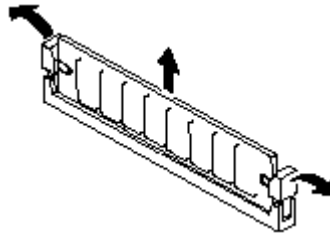

5. Mount the CPU module.
6. Connect the power cord.
7. Press the POWER switch to power on the module.
8. Verify that POST displays no error messages.

If POST displays an error message, take a note on the message and see the POST error messages listed in Chapter 7.

Replacing DIMM

Follow the procedure below to replace the failed DIMM.

1. Identify the failed DIMM using the Data Viewer of the NEC ESMPRO Manager.

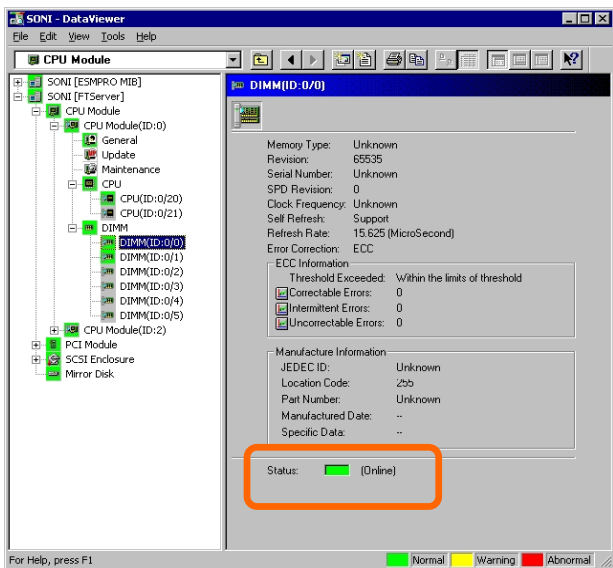

2. Remove the CPU module.
3. Replace a DIMM
4. Install the CPU module.
5. Boot the CPU module using the NEC ESMPRO Manager or ft server utility.

PROCESSOR (CPU)

In addition to the standard CPU (Intel® Xeon™ Processor), you can add one CPU to make a multi-processor system.

IMPORTANT:

- The CPU is extremely sensitive to static electricity. Make sure to touch the metal frame of the server to discharge static electricity from your body before handling the CPU. Do not touch the CPU terminals or on-board parts with a bare hand or place the CPU directly on the desk. For static notes, see the section "Anti-static Measures" described earlier.
 - Do not use the system before checking to see it works correctly.
 - Make sure to use the CPU authorized by NEC. Installing a third-party CPU may cause a failure of the CPU as well as the server. Repair of the server due to failures or damage resulted from installing such a board will be charged.
 - Before adding or removing CPU, power off the server and detach the CPU module.
 - Make sure to read "Anti-static Measures" and "Preparing Your System for Upgrade" before starting installing or removing options.
-

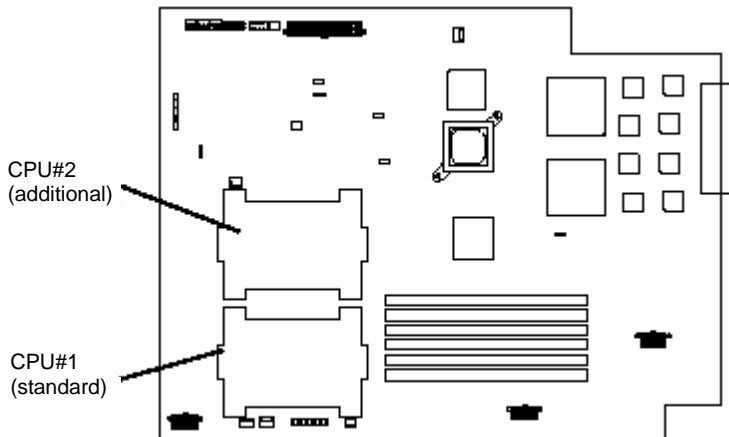

Installation

Follow the steps below to mount a CPU:

1. Shut down OS.
Press the POWER switch to turn off the server.
2. Unplug the power cord.
3. Remove the CPU module.
4. Detach the CPU air duct.

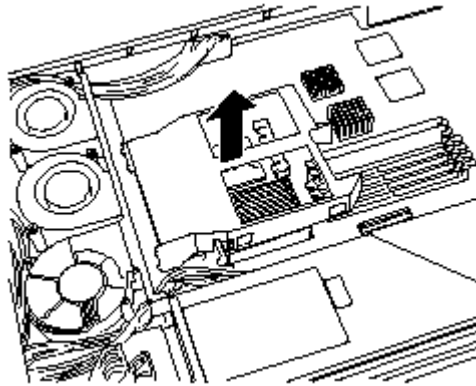

5. Check to be sure of the location of the CPU socket.
6. Remove the anti-dust sheet from the socket.

IMPORTANT: Carefully keep the removed sheet.

7. Lift the socket lever.

IMPORTANT: Open the lever fully. It can be opened 120° or more.

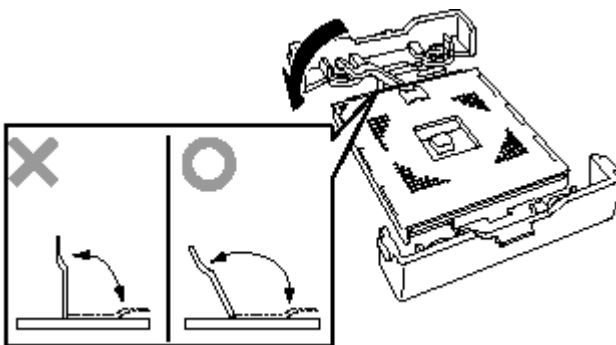

- Place the CPU carefully on the socket.

TIPS: Pay attention to the orientation of the CPU.

The CPU and socket have pin marks to prevent misinsertion.

Pin marks

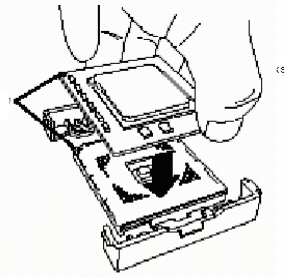

- After pressing the CPU softly against the socket, close the lever to fasten it.

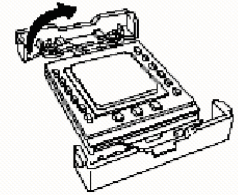

- Remove the film of the cool sheet that is affixed on the heat sink.

- Place the heat sink on top of the CPU.

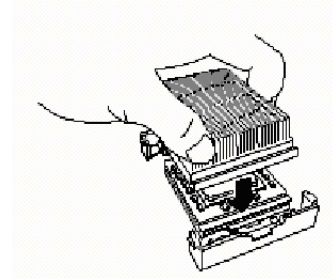

- Fasten the heat sink with its clip.

Engage the clip holes with tabs on the sides of the retention: engage one hole first and engage the other holding the first hole.

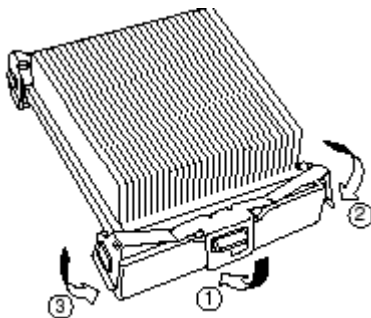

13. Check to see if the heat sink is mounted parallel with the motherboard.

IMPORTANT:

- If the heat sink is not parallel to the motherboard, dismount and remount it. You cannot mount the heat sink correctly due to the following:
 - CPU is not mounted correctly
 - The heat sink clip is not engaged correctly.
 - Do not hold the fastened heat sink to move the CPU.
-

14. Attach the CPU air duct.

TIPS: Check to see if the air duct is attached securely with its projected parts inserted into the chassis.

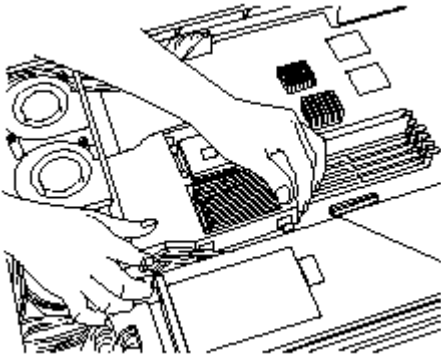

15. Install the CPU module.
16. Connect the power cord.
17. Press the POWER switch to power on the module.
18. Verify that POST displays no error messages.

If POST displays an error message, take a note on the message and see the POST error messages listed in Chapter 7.

Removing CPU

Follow the steps below to remove the CPU. Except when you replace the CPU with a new one, power off the server.

IMPORTANT:

- Do not remove the CPU unless it is faulty.
 - If a CPU is not mounted on CPU#2, cover it with an anti-dust sheet.
 - After operation, the cool sheet at the bottom of the heat sink may stick to the CPU because of heat. When you dismount the heat sink, turn it lightly to make sure that the heat sink is not sticking to the CPU. Otherwise, the CPU or socket may be damaged.
-

1. Shut down the OS.

Press the POWER switch to turn off the server.

2. Unplug the power cord.
3. Remove the CPU module.
4. Detach the CPU air duct.
5. Dismount the heat sink using the dismount tool included with the additional CPU.

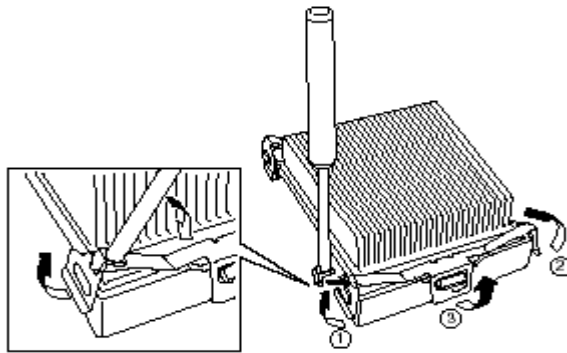

6. Remove the CPU.
7. Affix an anti-dust sheet on the CPU socket.
Place the adhesive part on the opposite side of the lever. Any part of the sheet place off the socket.
8. Install the CPU module.
9. Connect the power cord.
10. Press the POWER switch to power on the module.
11. Verify that POST displays no error messages.
If POST displays an error message, take a note on the message and see the POST error messages listed in Chapter 7.

Replacing CPU

Follow the steps below to replace a failed CPU:

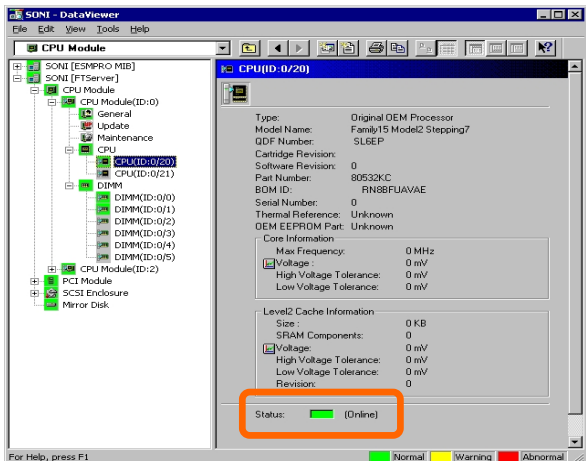

1. Use Data Viewer of NEC ESMPRO Manager to check the failed CPU.
2. Remove the CPU module.
3. Replace the CPU.
4. Install the CPU module.
5. Start the CPU module from ft server utility or NEC ESMPRO Manager.

In the initial setting, the server will start up automatically upon mounting the CPU module. If it is set not to start up automatically, use Data Viewer of NEC ESMPRO Manager or ft server utility to start it.

PCI MODULE

Three PCI boards can be installed to the PCI module.

Up to two PCI boards can be added to each PCI module, therefore, the server can accommodate four additional PCI boards at a maximum (one video board has already been installed to each PCI module in standard configuration).

Remove the PCI module when adding or replacing the PCI board. The figures used in this section show the rack-mount model. The orientation is the only difference from the tower model.

IMPORTANT:

- Ask your sales agent to replace the PCI module and its components.
 - Make sure to read "Anti-static Measures" and "Preparing Your System for Upgrade" before starting installing or removing options.
 - Handle the module fixing screw with your hand, not by using any tool.
 - If you have replaced the module, attach an HDD ID label indicating the module number to the upper part of the screw fixing the module.
-

TIPS: The primary PCI module is the one whose POWER LED is on.

Precautions

- If you remove a PCI module during operation, dual configuration of its internal hard disks will be cancelled. If you mount the module again, the dual configuration will be restored automatically. However, do not perform a system shutdown or remove any of the PCI modules before the dual configuration is completed. Otherwise, hard disk data could be corrupted.
- Removing the primary (active) module will cause unexpected trouble. Be sure to remove the secondary (inactive) module.
- When the secondary BMC is not in synchronous condition, removing the PCI module on the primary BMC will lose the SG data (system data). If one of the STATUS LEDs is blinking in red, do not remove the PCI module associated with another STATUS LED.

When DC power is off:

BMC#1	BMC#2	Status
Off (Primary)	Blinking in red (Secondary) (At 1-second intervals)	Do not remove the PCI module on Primary BMC side. BMC Sync disabled.
Off (Primary)	Illuminates red (Secondary)	Do not remove either PCI modules. During BMC Sync.
Off (Primary)	Blinking in red (Secondary) (At 0.5-second intervals)	Do not remove either of the PCI modules or control the AC/DC power before the LED stops blinking.

When DC power is on:

BMC#1	BMC#2	Status
Blinking in green (Primary) (At 1-second intervals)	Blinking in red (Secondary) (At 1-second intervals)	Do not remove the PCI module on Primary BMC side. BMC Sync disabled.
Blinking in green (Primary) (At 1-second intervals)	Illuminates red (Secondary)	Do not remove either PCI modules. During BMC Sync.
Blinking in green (Primary) (At 1-second intervals)	Blinking in red (Secondary) (At 0.5-second intervals)	Do not remove either of the PCI modules or control the AC/DC power before the LED stops blinking.

- When you remove a PCI module, the system will be powered off automatically. If there is a CD-ROM in the drive, eject it before removing the module.
- When you insert a PCI module while the system is off, make sure that the newly inserted PCI module's BMC status lamp is off and then press the power switch.
- When replacing a PCI module and a CPU module, replace one module and wait until dual configuration is established to replace the other module. If you replace the both modules simultaneously, dual configuration of either CPU modules or PCI modules may fail. (See Chapter 7 "Troubleshooting".)

Removing PCI Module

Follow the procedure below to remove the PCI module.

1. Stop the PCI module you want to remove.

To this end, use the ft server utility of the NEC ESMPRO Agent installed to your server or the Data Viewer of the NEC ESMPRO Manager.

For more information, see "NEC ESMPRO Agent and Manager" - "Maintenance of NEC Express5800/ft series" in Chapter 5.

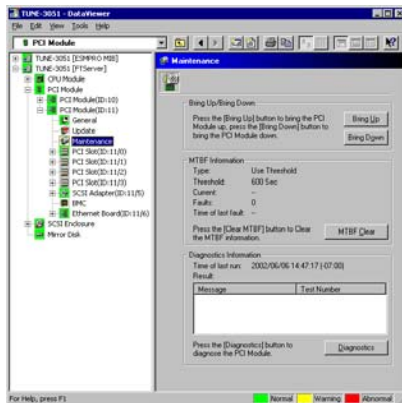

NEC ESMPRO Manager

Select [FTServer] → [PCI Module] → [PCI Module (to be removed)] → [Maintenance] → [Bring Up/Bring Down] → [Bring Down].

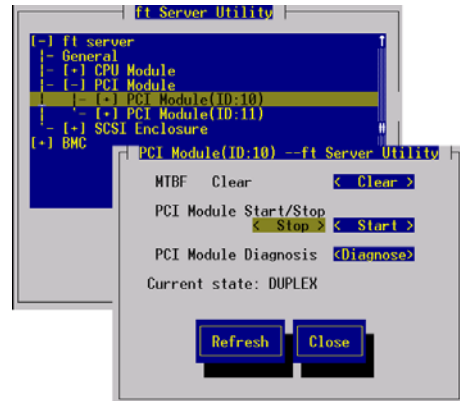

ft server utility

Select [ft server] → [PCI Module] → [PCI Module (to be removed)] → [PCI Module Start/Stop] → [Stop].

After the CPU enters into off-line status, the status LEDs of the PCI board and PCI module will change as follows.

PCI board slot status LEDs (all of them): Off

PCI module

Status LED 1: Red

Status LED 2: Off

2. <Tower model>

Unlock the front bezel with the security key and open it.

<Rack-mount model>

Unlock the front bezel with the security key and detach it.

3. Disconnect the PCI module's network cable and cables connected to the options.
4. Loosen the setscrew securing the PCI module's release lever.

5. Hold the release lever of the PCI module and pull it off.

The PCI module is slightly pulled out toward you.

IMPORTANT: Do not hold the other parts than the release lever to pull the module.

6. Pull off the module halfway slowly. Pushing down the latch lever on the side to unlock it, pull the module off the rack.

IMPORTANT: Carefully handle the PCI module so that you will not drop it or strike it against other server internal devices.

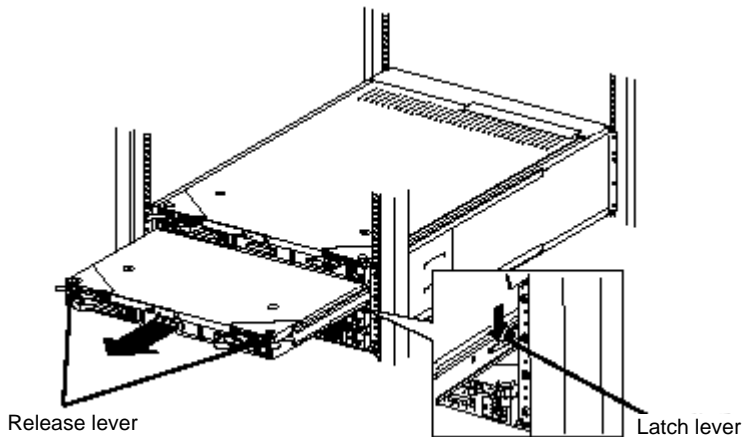

7. Carefully place the PCI module on the flat and sturdy table.

Avoid the dusty or humid place.

8. Remove the two setscrews on the front of the PCI module and one setscrew on the back.

9. Slide the top cover a little to remove it.

This allows you to access the devices in the PCI module. For more information on how to handle these devices, see the associated sections.

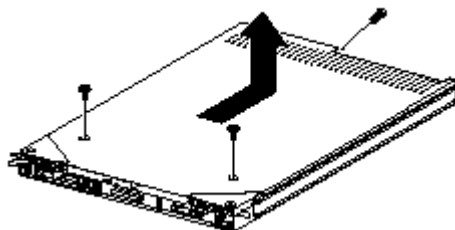

Installing PCI Module

Follow the procedure below to install the PCI module:

IMPORTANT: Make sure to read "Anti-static Measures" and "Preparing Your System for Upgrade" before starting installing or removing options.

1. Install the top cover to the PCI module.

TIPS: Check the left, right, and upper tabs on the top cover are certainly engaged with the PCI module.

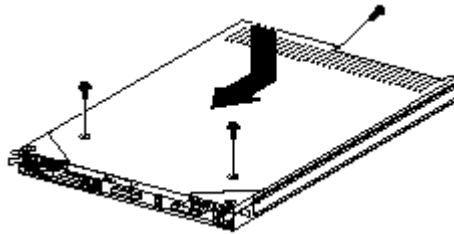

2. Secure the top cover to the PCI module with the three setscrews.
3. Firmly hold the PCI module with both hands and insert it into the server.
4. Hold the module in such a way that its back panel connector faces the back of the rack and engage the guides of the module and chassis to insert it slowly.
5. Hold the release lever to push the module as far as it goes.

Do not close the release lever yet.

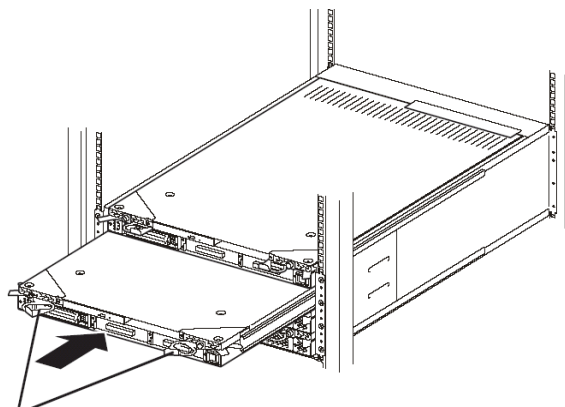

Release lever

6. Connect the network cable and option cables.

- Close the release lever.

IMPORTANT: Unless the release levers are located inside the rack frame, the module won't be mounted correctly.

- Screw the release levers.

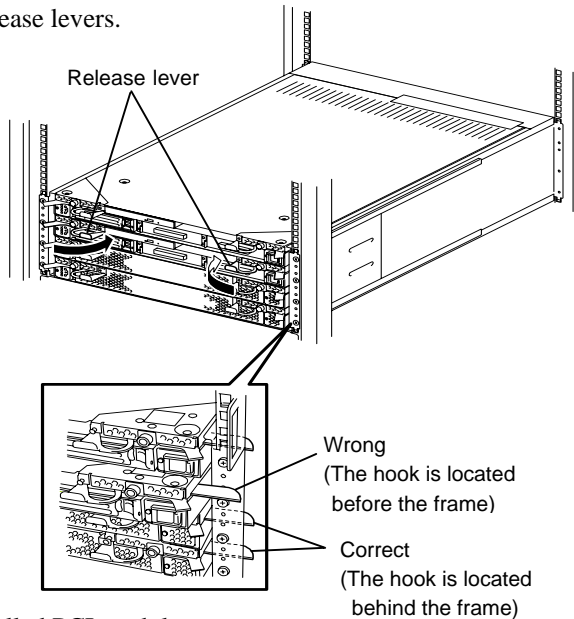

- Boot the installed PCI module.

The system is defaulted to automatically boot the PCI module, once installed. If this feature is disabled, boot the PCI module using the ft server utility of the NEC ESMPRO Agent installed to the server or the Data Viewer of the NEC ESMPRO Manager.

For more information, see "NEC ESMPRO Agent and Manager" - "Maintenance of NEC Express5800/ft series" in Chapter 5.

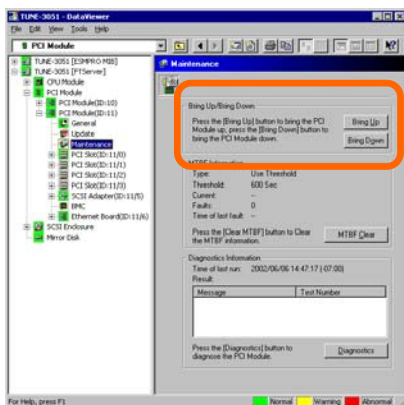

NEC ESMPRO Manager
 Select [FTServer] → [PCI Module] → [(installed) PCI Module] → [Maintenance] → [Bring Up/Bring Down] → [Bring Up].

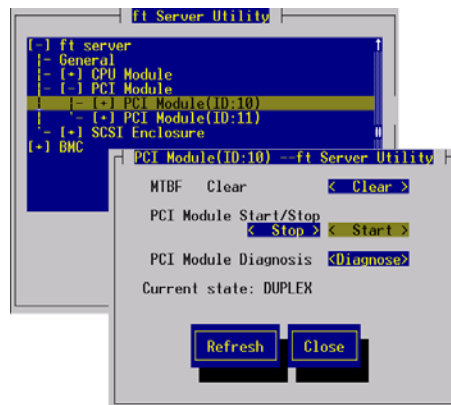

ft server utility
 Select [ft server] → [PCI Module] → [(installed) PCI Module] → [PCI Module Start/Stop] → [Start].

PCI BOARD

Up to three PCI boards can be installed to the PCI module (however, one video board is already installed in each module in standard configuration).

IMPORTANT:

- The PCI board is extremely sensitive to static electricity. Make sure to touch the metal frame of the server to discharge static electricity from your body before handling the PCI board. Do not touch the PCI board terminals or on-board parts by a bare hand or place the PCI board directly on the desk. For static notes, see the section "Anti-static Measures" described earlier.
 - Make sure to read "Anti-static Measures" and "Preparing Your System for Upgrade" before starting installing or removing options.
 - PCI#1 is a slot dedicated for video board, which is standard equipment. Do not replace this board with any other board.
-

TIPS: When a PCI board is installed or removed, or the slot is changed, use the BIOS setup utility "SETUP" to change the detailed settings such as interrupt line (IRQ), when necessary. See Appendix B for details.

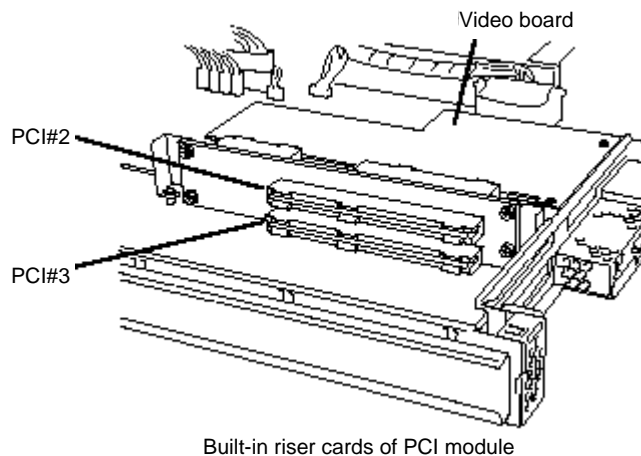

Note the following to install or replace PCI board.

- To add a PCI board, the system must be shut down.
 - To make a dual PCI board configuration, install the same type of board (i.e., having the same specifications and performance) to the same slot in another group.
- When a PCI board is installed to one group, another identical PCI board should be installed to the same slot in another group. This rule is applied to the case of removal.
- Install the PCI boards, starting from the one with the smallest number.

Installing PCI Board

Follow the procedure below to install the board to be connected to the PCI board slot.

TIPS: To install the PCI board, make sure the shape of the board connector matches with the shape of the PCI board slot connector.

1. Remove the PCI module.
2. Remove the PCI module's top cover.
3. Identify the slot to which you want to install a PCI board and remove the connector cap.

IMPORTANT: Carefully keep the removed connector cap.

4. To install a long card, loosen the setscrew, slide the bracket, and secure it with the setscrew.

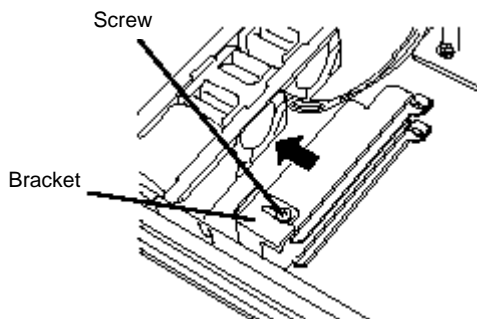

5. Pull the PCI board retainer bracket from the inside.
6. Unscrew the setscrew of the additional slot cover at the same position (level) as the target slot, and remove the slot cover.

IMPORTANT: Carefully keep the removed additional slot cover.

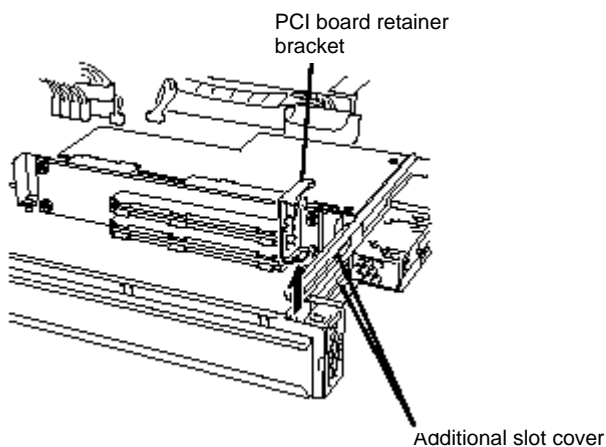

7. Align the terminal segment of the board with the connection of the slot and insert the board slowly into the slot.

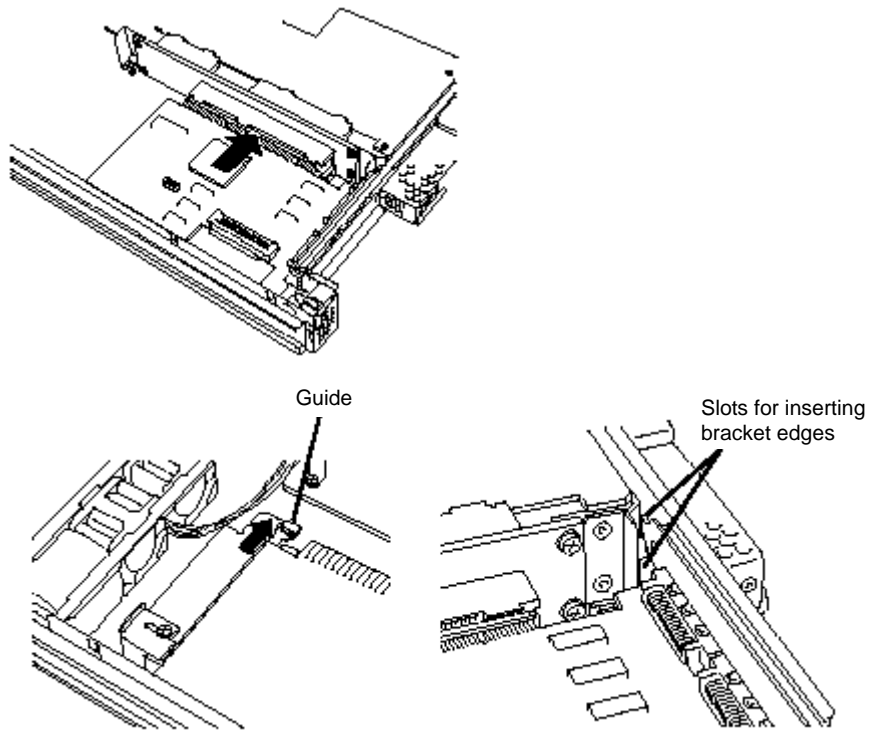

TIPS: Check to see if the edge of the bracket (taper) is inserted into a slot of the chassis. In the case of a long board, check also to see if its other edge is inserted into the bracket guide.

8. Align the PCI board with the guide rail groove and insert the board slowly.

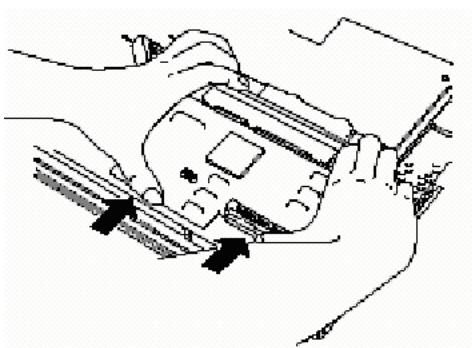

IMPORTANT: If the insertion is unsuccessful, remove the board once and retry installation. Note that if excessive force is applied to the board, it may be damaged.

9. Attach the retainer bracket to fasten the PCI board.

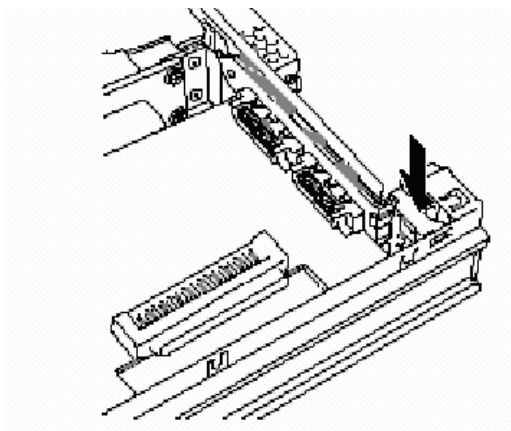

10. In the case of a long board, slide the bracket to fasten the other edge of the board.

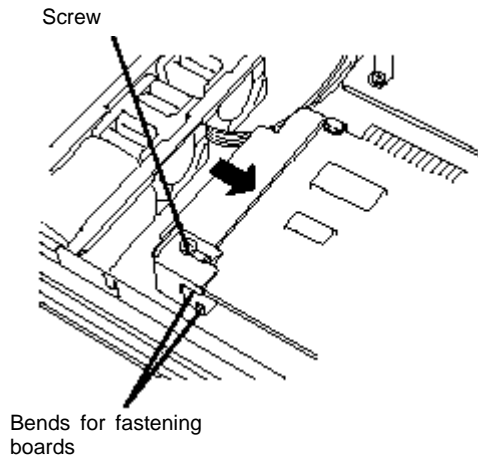

11. Install the top cover to the PCI module.
12. Install the PCI module.
Do not close the release lever yet.
13. Connect the network cable and option cables.
14. Close the release lever.
15. Secure the release lever with the setscrew.
16. Boot the PCI module using the NEC ESMPRO Manager or ft server utility to establish a dual configuration.

In the initial setting, the server will start up automatically upon mounting the PCI module. If it is set not to start up automatically, use Data Viewer of NEC ESMPRO Manager or ft server utility to start it.

For more information, refer to "NEC ESMPRO Agent and Manager" - "Maintenance of NEC Express5800/ft series" in Chapter 5.
17. Check the PCI module status LED and PCI board status LED.

For description of LED indications, see "LEDs" in Chapter 2 and "Setup of Optional PCI Board" later in this chapter.

18. Use cable ties to fasten the extra length of cables.

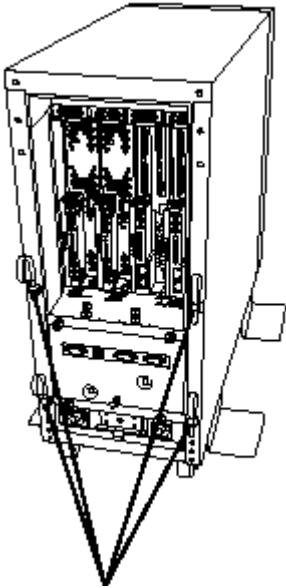

Cable ties (included with cabinet)

Removing PCI Board

Follow the procedure below to remove the PCI board.

1. Remove the PCI module.
2. Remove the PCI module's top cover.
3. Remove the PCI board retainer bracket to dismount the PCI board.

In the case of a long board, unscrew the guide at the other edge and slide it to the front of the board.

4. Install the additional slot cover to the open slot.
5. Install the connector cover to the relevant slot.
6. Attach the PCI board retainer bracket.
7. Install the PCI module's top cover.
8. Install the PCI module.
Do not close the release lever at this time.
9. Connect the network cable and option cables.
10. Close the release lever.
11. Secure the release lever with the setscrew.
12. Boot the PCI module using the NEC ESMPRO Manager or ft server utility to establish a dual configuration.

In the initial setting, the server will start up automatically upon mounting the PCI module. If it is set not to start up automatically, use Data Viewer of NEC ESMPRO Manager or ft server utility to start it.

For more information, refer to "NEC ESMPRO Agent and Manager" - "Maintenance of NEC Express5800/ft series" in Chapter 5.

13. Check the PCI module status LED and PCI board status LED.

For description of LED indications, see "LEDs" in Chapter 2 and "Setup of Optional PCI Board" later in this chapter.

Replacing PCI Board

Follow the procedure below to replace the failed PCI board.

1. Check the PCI board LED and identify the failed PCI board.

When the PCI board is failed or incorrectly installed, the two LEDs associated with the PCI board slot are being turned off.

2. Remove the PCI module.
3. Remove the PCI module's top cover.
4. Remove the PCI board retainer bracket to dismount the PCI board.

In the case of a long board, unscrew the guide at the other edge and slide it to the front of the board.

5. Replace the board and fasten it.
6. Install the PCI module's top cover.
7. Install the PCI module.
Do not close the release lever at this time.
8. Connect the network cable and option cables.
9. Close the release lever.
10. Secure the release lever with the setscrew.
11. Boot the PCI module using the NEC ESMPRO Manager or ft server utility to establish a dual configuration.

In the initial setting, the server will start up automatically upon mounting the PCI module. If it is set not to start up automatically, use Data Viewer of NEC ESMPRO Manager or ft server utility to start it.

For more information, refer to "NEC ESMPRO Agent and Manager" - "Maintenance of NEC Express5800/ft series" in Chapter 5.

12. Check the PCI module status LED and PCI board status LED.

For description of LED indications, see "LEDs" in Chapter 2 and "Setup of Optional PCI Board" later in this chapter.

Setup of Optional PCI Board

IMPORTANT:

- To enable the fault-tolerant feature of the optional device, the identical devices must be installed to the same slots in groups 1 and 2, respectively.
 - A video board is already installed to slot #1 as standard configuration. This board may not be removed or replaced with any other board.
 - Change the BIOS settings. For some optional PCI boards you may need to start up the BIOS setup utility to change the [Boot Monitoring Time-out Period] configuration in [Advanced] – [Monitoring Configuration]. For more details, see page 4-15.
 - For supported connection devices, contact your sales agent.
-

N8804-001P1 100BASE-TX Adapter Set

IMPORTANT:

 Note the following about this product:

For LAN cable's connector, use the RJ-45 connector which is compliant with IEC8877 standard. Using a different connector may make it difficult to remove the connector.

- Slots to install the board

N code	Name	PCI slot						Remarks
		Group 1			Group 2			
		#1	#2	#3	#1	#2	#3	
N8804-001P1	100BASE-TX Adapter Set	–	√	√	–	√	√	

√: Can be installed. –: Cannot be installed.

- Installation of driver

The NEC Express5800/ft series duplicates one or two pairs of 100BASE-TX adapter sets (N8804-001P1) before using.

After installing Operating System, install the drivers in the following procedure and make dual settings of the PCI board.

TIPS: To perform this procedure, you have to log on the system as an Administrator or a member of the Administrators group.

After installing the OS, follow the steps below to install a driver and establish a dual configuration:

1. Mount the N8804-001P1 100BASE-TX adapter to the slot with the same number in PCI module #1 and #2, and then start the OS.
2. Build a dual LAN configuration.

For the setting procedure, see “Configure expanded LAN board” described later, or “Set Dual LAN Card Configuration” in the separate volume of User’s Guide (Setup).

■ PCI Board Status LED Indications

LED indications	Description	Action
Green	Duplex is specified, however, the server works in simplex mode.	Configure duplex. Reapply the driver.
Off	The PCI board is properly installed and operating in non-duplex mode. (Does not depend on simplex or duplex mode.)	In non-duplex mode, no specific problem occurs.
	The PCI board is properly installed and duplex is configured.	The system is operating normally in duplex mode.
	The PCI board is not installed yet, the PCI board is installed incorrectly, or the power is not supplied.	Mount the PCI board correctly. If the PCI board was not mounted, there is no problem. Check the condition of power unit. Remount the PCI module.
Red	In the process of configuring or canceling the duplex mode.	Wait for a while until the indication changes. If the indication does not change, check the status of the installed PCI board slot using NEC ESMPRO Manager.
	Although the PCI board is mounted, it is offline or not functioning.	Make the installed PCI board slot online from NEC ESMPRO Manager. Mount the PCI board correctly.

N8104-84 1000BASE-SX Adapter

Consult your sales personnel for details when purchasing this hardware.

IMPORTANT: Note the following about this product:

- It is advisable to add this product to such environment that each system is used for a different purpose (ex. system line, maintenance, monitoring) and multiple accesses do not occur simultaneously.
 - If there are multiple accesses, the processing power and transmission speed may be somewhat affected.
 - This product may require the revision of software and hardware in some cases. Ask your sales agent.
-

- Slots to install the board

N code	Name	PCI slot						Remarks
		Group 1			Group 2			
		#1	#2	#3	#1	#2	#3	
N8104-84	1000BASE-SX Adapter	-	√	√	-	√	√	Each PCI module can contain one board only.

√: Can be installed. -: Cannot be installed.

- About network setting

Make settings of the network after installing the N8104-84 1000BASE-SX connection board and starting the system. For the setting procedure, see “Configure expanded LAN board” described later, or “Set Dual LAN Card Configuration” in the separate volume of User’s Guide (Setup).

IMPORTANT:

- Insert the N8104-84 1000BASE-SX connection board after the installation of the OS is completed. Use the N8104-84 1000BASE-SX connection board in pairs. Insert one into a slot in a PCI module and the other into the slot at the same location in the other PCI module.
 - The 1000BASE-SX (N8104-84) and the 1000BASE-T (N8104-103) cannot coexist.
-

■ PCI Board Status LED Indications

LED indications	Description	Action
Green	Duplex is specified, however, the server works in simplex mode.	Configure duplex. Reapply the driver.
Off	The PCI board is properly installed and operating in non-duplex mode. (Does not depend on simplex or duplex mode.)	In non-duplex mode, no specific problem occurs.
	The PCI board is properly installed and duplex is configured.	The system is operating normally in duplex mode.
	The PCI board is not installed yet, the PCI board is installed incorrectly, or the power is not supplied.	Mount the PCI board correctly. If the PCI board was not mounted, there is no problem. Check the condition of power unit. Remount the PCI module.
Red	In the process of configuring or canceling the duplex mode.	Wait for a while until the indication changes. If the indication does not change, check the status of the installed PCI board slot using NEC ESMPRO Manager.
	Although the PCI board is mounted, it is offline or not functioning.	Make the installed PCI board slot online from NEC ESMPRO Manager. Mount the PCI board correctly.

N8104-103 1000BASE-T Adapter

Consult your sales personnel for details when purchasing this hardware.

IMPORTANT: Note the following about this product:

- It is advisable to add this product to such environment that each system is used for a different purpose (ex. system line, maintenance, monitoring) and multiple accesses do not occur simultaneously.
 - If there are multiple accesses, the processing power and transmission speed may be somewhat affected.
 - For LAN cable's connector, use the RJ-45 connector which is compliant with IEC8877 standard. Using a different connector may make it difficult to remove the connector.
-
- This product may require the revision of software and hardware in some cases. Ask your sales agent.
-

- Slots to install the board

N code	Name	PCI slot						Remarks
		Group 1			Group 2			
		#1	#2	#3	#1	#2	#3	
N8104-103	1000BASE-T Adapter	-	√	√	-	√	√	Each PCI module can contain one board only.

√: Can be installed. -: Cannot be installed.

- About network setting

Make settings of the network after installing the N8104-103 1000BASE-T connection board and starting the system. For the setting procedure, see “Configure expanded LAN board” described later, or “Set Dual LAN Card Configuration” in the separate volume of User's Guide (Setup).

IMPORTANT:

- Insert the N8104-103 1000BASE-T connection board after the installation of OS is completed. Use the N8104-103 1000BASE-T connection board in pairs. Insert one into a slot in a PCI module and the other into the slot at the same location in the other PCI module.
 - The 1000BASE-T (N8104-103) and the 1000BASE-SX (N8104-84) cannot coexist.
-

■ PCI Board Status LED Indications

LED indications	Description	Action
Green	Duplex is specified, however, the server works in simplex mode.	Configure duplex. Reapply the driver.
Off	The PCI board is properly installed and operating in non-duplex mode. (Does not depend on simplex or duplex mode.)	In non-duplex mode, no specific problem occurs.
	The PCI board is properly installed and duplex is configured.	The system is operating normally in duplex mode.
	The PCI board is not installed yet, the PCI board is installed incorrectly, or the power is not supplied.	Mount the PCI board correctly. If the PCI board was not mounted, there is no problem. Check the condition of power unit. Remount the PCI module.
Red	In the process of configuring or canceling the duplex mode.	Wait for a while until the indication changes. If the indication does not change, check the status of the installed PCI board slot using NEC ESM PRO Manager.
	Although the PCI board is mounted, it is offline or not functioning.	Make the installed PCI board slot online from NEC ESM PRO Manager. Mount the PCI board correctly.

N8803-031F Fibre Channel Controller

- Slots to install the board

N code	Name	PCI slot						Remarks
		Group 1			Group 2			
		#1	#2	#3	#1	#2	#3	
N8803-031F	Fibre Channel Controller	-	√	√	-	√	√	Each PCI module can contain one board only. Only one of them can be mounted. (cannot be mounted together)

√: Can be installed. -: Cannot be installed.

- Installation of driver

When you start the system with the N8803-031F Fibre Channel Controller installed, it automatically becomes available.

IMPORTANT:

- Insert the N8803-031F after the installation of OS is completed. Use the N8803-031F in pairs. Insert one into a slot in a PCI module and the other one into the slot at the same location in the other PCI module.
- After starting the system with the N8803-031F installed, make settings of the SCSI topology.

- PCI Board Status LED Indications

LED indications		Description	Action
Fail LED	State LED		
Off	Amber	The Fibre Channel disk array device is not connected yet, or not connected correctly (not duplicated)	Check the connection to the Fibre Channel disk array device. (For details, see the instruction manual of the Fibre Channel disk array device.)
Off	Green	The PCI board is operating normally in duplex mode.	-
Off	Off	The PCI board is not installed yet, the PCI board is installed incorrectly, or the power is not supplied.	Mount the PCI board correctly. If the PCI board was not mounted, there is no problem. Check the condition of power unit. Remount the PCI module.
Red	Amber	The PCI board is on a software control test, or is preparing for the operation.	Wait for a while until the indication changes. If the indication does not change, check the status of the installed PCI board slot using NEC ESMPRO Manager.
Red	Off	Although the PCI board is mounted, it may be offline or not be working.	Make the installed PCI board slot online from NEC ESMPRO Manager. Mount the PCI board correctly.

Configure SCSI topology

If you expanded the Fibre Channel Controller to the PCI slot, configuration of the topology is needed. Follow the procedure below to set the SCSI topology:

1. Decide the domain number on which the setting is performed from the `/proc/scsi/scsi` file and the `/proc/scsi/topo` file. Execute the following command from the shell:

```
echo setdomain number > /proc/scsi/topo
```

2. Decide any SCSI bus number which is not used, and then execute the following command from the shell:

```
echo bus number_type PCI_BUS_NO:PCI_SLOT_NO.CHANNEL_NO > /proc/scsi/topo
```

number is a SCSI bus number. *type* is a device type (e.g., qla2x00). PCI_BUS_NO is '01' for the Fibre Channel controller of the PCI module 1, '40' for the Fibre Channel controller of the PCI module 2. PCI_SLOT_NO is a number of PCI slots (in ascending order (0, 1, 2...) from the left). CHANNEL_NO is a channel number (the first channel is '00'). For the set of "type" and "PCI_BUS_NO:PCI_SLOT_NO.CHANNEL_NO", if there are more than one paths to a single SCSI bus, specify all of them

3. Repeat step 2 if there is another SCSI bus on the same domain.
4. Confirm the setting on `/proc/scsi/topo`, and then execute the following command to save the topology:

```
ftdisk topology-save
```

The topology setting will be restored at restart.

CHECK:

When deleting setting items of the topology, delete the saved topology file from "`rm /opt/nec/fras/etc/scsi-topology.save`". Restart the system and then perform the setting from step 1 again.

Configure expanded LAN board

Follow the procedure below to set the dual configuration of the 100BASE-TX, 1000BASE-T, 1000BASE-SX.

Make the following settings after mounting the LAN board according to the description of the “Installing PCI Board” in “PCI BOARD”.

IMPORTANT: You need to login to the system as a user with a root authority to perform this operation.

1. Execute the following command to check if the expanded LAN board is displayed properly at the number of the slot to which the LAN board was added.

```
>vndctl status
```

In the following description, “*” (a number between 1 and 7) indicates the number of the PCI slot to which the LAN board was added.

2. Use the following command to add and register the LAN board expanded to the PCI slot *.

```
>vndctl add *
```

3. Execute the following command to set the dual LAN board configuration on the PCI slot *.

```
>vndctl config *
```

4. Use the following command to start the dual LAN board on the PCI slot *.

```
>vndctl up *
```

Setting dual configuration of the expanded LAN board is now completed. Note that the network setting above is effective to a virtual device ha* (“*” is a number), however, it is not reflected to physical devices (e.g., epro* or gb*, * is a number).

Delete LAN board setting

Follow the procedure below to delete the LAN board setting.

IMPORTANT: You need to login to the system as a user with a root authority to perform this operation.

1. If the LAN board whose setting is to be deleted is operating, use the following command to stop it.

In the following description, “*” (a number between 1 and 7) indicates the number of the PCI slot to which the LAN board to stop is connected.

```
>vndctl down *
```

TIPS: You can check the number * of the PCI slot to which the LAN board to stop is connected by using the following command:

```
>vndctl status
```

2. Execute the following command to delete the setting of the LAN board which is connected to the PCI slot whose number is *.

Deleting the setting of the LAN board is now completed.

Check the status of the LAN board

Execute the following command to check the status of the LAN board:

```
>vndctl status
```

Example

```
--Virtual Network Status--
virtual status ipconf slot real(s)
ha0 OKAY yes 7 *epro01.06 epro40.06
ha1 OKAY yes 4 *gb01.03.0 gb40.03.0

slot real status link
1 left -
right -
2 left -
right -
3 left -
right -
4 left gb01.03.0 UP LINK
right gb40.03.0 UP LINK
5 left -
right -
6 left -
right -
7 left epro01.06 UP LINK
right epro40.06 UP LINK
```

Check the setting information (e.g., IP addresses)

Execute the following command to check the configuration information (e.g., IP addresses):

```
>vndctl status slot_number
```

Example

```
--Virtual Network Status--
virtual status ipconf slot real(s)
ha0 OKAY yes 7 *epro01.06 epro40.06
  Link encap:Ethernet HWaddr 00:30:13:F1:E9:7D
  inet addr:192.168.99.31 Bcast:192.168.99.255 Mask:255.255.255.0
  UP BROADCAST RUNNING MASTER MULTICAST MTU:1500 Metric:1
  RX packets:11647 errors:0 dropped:0 overruns:0 frame:0
  TX packets:126 errors:0 dropped:0 overruns:0 carrier:0
  collisions:0 txqueuelen:0
  RX bytes:737781(720.4Kb) TX bytes:6750(6.5Kb)

slot real status link
7 left epro01.06 UP LINK
  Link encap:Ethernet HWaddr 00:30:13:F1:E9:7D
  UP BROADCAST RUNNING SLAVE MULTICAST MTU:1500 Metric:1
  RX packets:11647 errors:0 dropped:0 overruns:0 frame:0
  TX packets:126 errors:0 dropped:0 overruns:0 carrier:0
  collisions:0 txqueuelen:100
  RX bytes:900839(879.7Kb) TX bytes:6750(6.5Kb)
  Interrupt:47 Base address:0xb000

right epro40.06 UP LINK
  Link encap:Ethernet HWaddr 00:30:13:F1:E9:7D
  UP BROADCAST RUNNING SLAVE MULTICAST MTU:1500 Metric:1
  RX packets:95 errors:0 dropped:0 overruns:0 frame:0
  TX packets:0 errors:0 dropped:0 overruns:0 carrier:0
  collisions:0 txqueuelen:100
  RX bytes:6664(6.5Kb) TX bytes:0(0.0 b)
  Interrupt:19 Base address:0xd000
```

Appendix A

Specifications

Item		NEC Express5800/320Lb	NEC Express5800/320Lb-R
		N8800-057F	N8800-058F
CPU	Type	Intel® Xeon™ Processor × 1	
	Clock/second cache	2.4GHz/512KB	
	Number of processors	1	
Chipset		Server Works Server Set III GC-LE	
Memory	Standard	512MB (256MB × 2*) *Each module has two DIMMs in standard configuration.	
	Maximum	6GB (The standard DIMM must be replaced.)	
	Expansion unit	2 DIMMs (256MB × 2/ 512 MB × 2/ 1GB × 2)	
	Memory module	DDR200 SDRAM DIMM (Registered Type)	
	Error check	ECC	
Graphics (VRAM)		CT69000 (VRAM 2MB)	
Auxiliary input device	Floppy disk (standard)	3.5-inch drive × 1 (USB)	
	Hard disk (standard)	None	
	Hard disk (maximum)	879.0GB* (146.5GB × 6) * The user area is reduced to a half of the physical capacity due to software mirroring.	
	CD-ROM (standard)	ATAPI interface × 2 (Load on tray type, x24 speed)	
File bay	5.25 inch	None	
	3.5 inch	6 slots	
Additional slot	PCI	6 slots (2 slots are used for graphics board.)	
LAN interface		1000BASE-T/100BASE-TX/10BASE-T (2 ports); 100BASE-TX/10BASE-T (2 ports)	
External interface	USB	4-pin (2 ports) 2 ports are used by keyboard and external USB FDD.	
	Serial	D-sub 9-pin (2 ports)	
	SCSI	VHDCI 68-pin connector (2 ports)	
	Network	RJ-45 (4 ports)	
	Display	MINI D-sub 15-pin (1 port)	
Cabinet design		Deskside and mini-tower	Rack-mount type
External dimensions		222 (width)* × 560 (height) × 795 (depth) mm *370mm if stabilizers included	480 (width) × 177 (height) × 790 (depth) mm
Weight		68 kg (Max. 73kg)	56 kg (Max. 61kg)
Power supply		100 to 120 VAC ±10%, 200 to 240 VAC ±10%, 50/60 Hz ±1 Hz	
Power consumption		880 VA, 870 W	
Environmental requirements	In operation	Temperature 10 to 35°C Humidity 20 to 80% RH (non-condensing)	
	In storage	Temperature -10 to 55°C Humidity 20 to 80% RH (non-condensing)	

(This page is intentionally left blank.)

Appendix B

I/O Port Address

The factory-set I/O port addresses for the server are assigned as follows:

Address	Chip in Use
00-1F	8-bit DMA control register
20-21	Master 8259 programming interface
2E-2F	Configuration
40-43	8254 programming interface
60	Keyboard & mouse
61	NMI status register
64	Keyboard & mouse
70-71	NMI enable register/real-time clock
80-8F	16-bit DMA control register
A0-A1	Slave 8259 programming interface
C0-DF	DMA controller page register
E0-E9	Base address register
F0	Register IRQ13
F1-FF	Logical device configuration
170-177 or BAR2	EDMA2-compatible mode primary command block register
1F0-1F7 or BAR0	EDMA2-compatible mode secondary command block register
278-27F	(Parallel port 3)
2F8-2FF	Serial port B
BAR or 376	EDMA2-compatible mode secondary command block register
370-377	(Floppy disk drive 2), IDE 2
378-37F	(Parallel port 2)
3B0-3BB	VGA
3BC-3BE	Parallel port 1
3C0-3DF	VGA
3F6 or BAR1	EDMA2-compatible mode primary command block register
3F0-3F7	(Floppy disk drive 1), IDE 1
3F8-3FF	Serial port A
40B	DMA1 expansion write mode register
4D0	Master 8259 ELCR programming
4D1	Slave 8259 ELCR programming
4D6	DMA2 expansion write mode register
580-58F	SMBus control
C00	PCI IRQ mapping index register
C01	PCI IRQ mapping data register
C14	PCI error status register
C49	Address & status control
C4A	Rise time counter control
C52	General register (GPMs)
C6C	ISA wait register
C6F	Other control registers
CA2-CA3	IPMI (IMPI KCS interface)

Address	Chip in Use
CA4-CA5	IPMI (SMI interface)
CA6-CA-7	IPMI (SCI/SW1 interface)
CD6	Power management index register
CD7	Power management data register
CF8, CFC	PCI configuration space
CF9	Reset control
F50-F58h	General chipset
BAR4+00-0F	EDMA2 PCI base address register 4

* Expressed in hexadecimal digits.

* I/O port addresses of PCI devices are specified based on the type and number of PCI devices.