

NEC



USER'S MANUAL

LCD2335WXM™

To learn about other special offers, register online at www.necmitsubishi.com/productregistration

Index

Important Information	1
Safety Precautions, Maintenance, & Recommended Use	2
Contents	3
Component Names and Functions	
Main Unit	4
Remote Control	5
Installation Instructions	
Viewing Angle Adjustment	7
Detaching Main Body From Stand	7
Interface For Arm Applications	7
Connecting to a Antenna/Cable	8
Connecting to a Video Components	9
Connecting to a PC	10
Operating Instructions	
Turning Power On and Off	11
Volume Adjustment	12
Picture Parameters	13
PC Parameters	14
Channel Setting	15
Aspect	17
Picture-in-Picture	18
Other Functions	22
Parental Controls	23
General Settings	26
Captions Menu	27
Features	28
Troubleshooting	29
References	33
Specifications	34
Limited Warranty	35
TCO'99	36
Information importante	39
Consignes de sécurité, entretien et utilisation recommandée	40
Contenu	41
Noms et fonctions des composants	
Appareil principal	42
Télécommande	43
Instructions d'Installation	
Ajustement de l'angle de visionnement	45
Dégager le corps principal du support	45
Interface pour des applications des bra	45
Brancher le câble/antenne	46
Brancher le composantes vidéo	47
Brancher à un PC	48
Instructions de fonctionnement	
Mettre sous tension et hors tension	49
Réglage du volume	50
Paramètres de d' image	51
Paramètres de PC	52
Réglage des canaux	53
Aspect	54
Image dans image	55
Autres Fonctions	59
Contrô les parentaux	60
Paramètres généraux	63
Menu des sous-titres	64
Caractéristiques	65
Dépannage	66
Références	70
Caracteristiques	71
Garantie Limitée	72
TCO'99	73

Important Information



WARNING



TO PREVENT FIRE OR SHOCK HAZARDS, DO NOT EXPOSE THIS UNIT TO RAIN OR MOISTURE. ALSO, DO NOT USE THIS UNIT'S POLARIZED PLUG WITH AN EXTENSION CORD RECEPTACLE OR OTHER OUTLETS UNLESS THE PRONGS CAN BE FULLY INSERTED. REFRAIN FROM OPENING THE CABINET AS THERE ARE HIGH VOLTAGE COMPONENTS INSIDE. REFER SERVICING TO QUALIFIED SERVICE PERSONNEL.



CAUTION



CAUTION: TO REDUCE THE RISK OF ELECTRIC SHOCK, MAKE SURE POWER CORD IS UNPLUGGED FROM WALL SOCKET. TO FULLY DISENGAGE THE POWER TO THE UNIT, PLEASE DISCONNECT THE POWER CORD FROM THE AC OUTLET. DO NOT REMOVE COVER (OR BACK). NO USER SERVICEABLE PARTS INSIDE. REFER SERVICING TO QUALIFIED SERVICE PERSONNEL.



This symbol warns user that uninsulated voltage within the unit may have sufficient magnitude to cause electric shock. Therefore, it is dangerous to make any kind of contact with any part inside this unit.



This symbol alerts the user that important literature concerning the operation and maintenance of this unit has been included. Therefore, it should be read carefully in order to avoid any problems.

Canadian Department of Communications Compliance Statement

DOC: This Class B digital apparatus meets all requirements of the Canadian Interference-Causing Equipment Regulations.

C-UL: Bears the C-UL Mark and is in compliance with Canadian Safety Regulations according to CAN/CSA C22.2 No. 60950-1.

FCC Information

1. Use the attached specified cables with the MultiSync® LCD2335WXM™(L234GC) color monitor so as not to interfere with radio and television reception.
 - (1) Please use the supplied power cord or equivalent to ensure FCC compliance.
 - (2) Please use the supplied shielded video signal cable, 15-pin mini D-SUB to 15-pin mini D-SUB.
 - (3) Please use the supplied AC adapter.Use of other cables and adapters may cause interference with radio and television reception.
2. This equipment has been tested and found to comply with the limits for a Class B digital device, pursuant to part 15 of the FCC Rules. These limits are designed to provide reasonable protection against harmful interference in a residential installation. This equipment generates, uses, and can radiate radio frequency energy, and, if not installed and used in accordance with the instructions, may cause harmful interference to radio communications. However, there is no guarantee that interference will not occur in a particular installation. If this equipment does cause harmful interference to radio or television reception, which can be determined by turning the equipment off and on, the user is encouraged to try to correct the interference by one or more of the following measures:
 - Reorient or relocate the receiving antenna.
 - Increase the separation between the equipment and receiver.
 - Connect the equipment into an outlet on a circuit different from that to which the receiver is connected.
 - Consult your dealer or an experienced radio/TV technician for help.

If necessary, the user should contact the dealer or an experienced radio/television technician for additional suggestions. The user may find the following booklet, prepared by the Federal Communications Commission, helpful: "How to Identify and Resolve Radio-TV Interference Problems." This booklet is available from the U.S. Government Printing Office, Washington, D.C., 20402, Stock No. 004-000-00345-4.

Safety Precautions, Maintenance & Recommended Use

Safety Precautions and Maintenance

FOR OPTIMUM PERFORMANCE, PLEASE NOTE THE FOLLOWING WHEN SETTING UP AND USING THE LCD2335WXM COLOR MONITOR:

- DO NOT OPEN THE MONITOR. There are no user serviceable parts inside and opening or removing covers may expose you to dangerous shock hazards or other risks. Refer all servicing to qualified service personnel.
- Do not spill any liquids into the cabinet or use your monitor near water.
- Do not insert objects of any kind into the cabinet slots, as they may touch dangerous voltage points, which can be harmful or fatal or may cause electric shock, fire or equipment failure.
- Do not place any heavy objects on the power cord. Damage to the cord may cause shock or fire.
- Use the supplied AC adapter. Do not place any objects onto the AC adapter and do not use the AC adapter outdoors.
- Do not place this product on a sloping or unstable cart, stand or table, as the monitor may fall, causing serious damage to the monitor.
- When operating the LCD2335WXM monitor with its AC 220-240V power supply, use a power supply cord that matches the power supply voltage of the AC power outlet being used. The power supply cord you use must have been approved by and comply with the safety standards of your country. (Type H05VV-F 3G 1mm² should be used in Europe)
- In UK, use a BS-approved power cord with molded plug having a black (13A) fuse installed for use with this monitor. If a power cord is not supplied with this monitor, please contact your supplier.
- Do not place any objects onto the monitor and do not use the monitor outdoors.
- The inside of the fluorescent tube located within the LCD monitor contains mercury.
- Do not bend the power cord.
- Do not use monitor in high temperature, humid, dusty, or oily areas.
- If the glass is broken, handle with care.
- Do not cover the vents on monitor.
- If monitor or glass is broken, do not come in contact with the liquid crystal and handle with care.
- Allow adequate ventilation around the monitor so that heat can properly dissipate. Do not block ventilated openings or place the monitor near a radiator or other heat sources. Do not put anything on top of monitor.
- The power cable connector is the primary means of detaching the system from the power supply. The monitor should be installed close to a power outlet which is easily accessible.
- Handle with care when transporting. Save the packaging for transporting.
- Please follow the bylaws or rules of your municipality to dispose of the tube properly.
- Keep the holes on the back of the LCD clean of dirt and dust. It is recommended to wipe holes with a soft cloth a minimum of once per year.

CAUTION

Immediately unplug your monitor from the wall outlet and refer servicing to qualified service personnel under the following conditions:

- When the power supply cord or plug is damaged.
- If liquid has been spilled, or objects have fallen into the monitor.

- If the monitor has been exposed to rain or water.
- If the monitor has been dropped or the cabinet damaged.
- If the monitor does not operate normally by following operating instructions.

Recommended Use

CAUTION



CORRECT PLACEMENT AND ADJUSTMENT OF THE MONITOR CAN REDUCE EYE, SHOULDER AND NECK FATIGUE. CHECK THE FOLLOWING WHEN YOU POSITION THE MONITOR:

- For optimum performance, allow 20 minutes for warm-up.
- Rest your eyes periodically by focusing on an object at least 20 feet away. Blink often.
- Position the monitor at a 90½ angle to windows and other light sources to minimize glare and reflections.
- Clean the LCD monitor surface with a lint-free, nonabrasive cloth. Avoid using any cleaning solution or glass cleaner.
- Adjust the monitor's brightness and contrast controls to enhance readability.
- Avoid displaying fixed patterns on the monitor for long periods of time to avoid image persistence (afterimage effects).
- Get regular eye checkups.
- The lamp of backlight contains mercury. Please handle it appropriately in case of disposal.

Ergonomics

To realize the maximum ergonomics benefits, we recommend the following:

- Use the preset Size and Position controls with standard signals
- Use the preset Color Setting
- Use non-interlaced signals with a vertical refresh rate between 58-62Hz
- Do not use primary color blue on a dark background, as it is difficult to see and may produce eye fatigue to insufficient contrast

For more detailed information on setting up a healthy work environment, write the American National Standard for Human Factors Engineering of Visual Display Terminal Workstations – ANSI-HFS Standard No. 100-1988 – The Human Factors Society, Inc. P.O. Box 1369, Santa Monica, California 90406.

Cleaning the LCD Panel

- When the liquid crystal panel is stained with dust or dirt, please wipe with soft cloth gently.
- Please do not rub the LCD panel with hard material.
- Please do not apply pressure to the LCD surface.
- Please do not use OA cleaner it will cause deterioration or discolor on the LCD surface.

Cleaning the Cabinet

- Unplug the power supply
- Gently wipe the cabinet with a soft cloth
- To clean the cabinet, dampen the cloth with a neutral detergent and water, wipe the cabinet and follow with a dry cloth.

NOTE: Many plastics are used on the surface of the cabinet. DO NOT clean with benzene, thinner, alkaline detergent, alcoholic system detergent, glass cleaner, wax, polish cleaner, soap powder, or insecticide. Do not touch rubber or vinyl to the cabinet for a long time. These types of fluids and fabrics can cause the paint to deteriorate, crack or peel.

Contents

Your new NEC MultiSync® LCD2335WXM™ monitor box* contains the following items:

- LCD monitor
- Power Cord
- AC Adapter
- Audio Cable
- Video Signal Cable – VGA to VGA
- User's Manual
- Wireless Remote Control and AA Batteries
- RF Cable
- Relay Connector

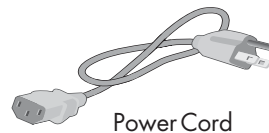

Power Cord

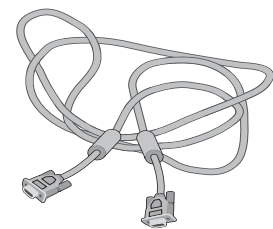

Video Signal Cable
(D-SUB to D-SUB Cable)



User's Manual



Wireless Remote Control
and AA Batteries

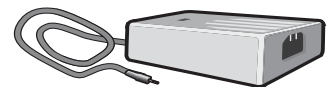

AC Adapter



Audio Cable

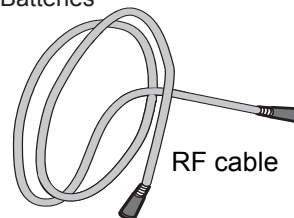

RF cable



Relay connector

*Remember to save your original box and packing material to transport or ship the monitor.

The following optional components are available to use with the LCD2335WXM. To obtain the optional components and additional information, contact Customer Service at (800) 632-4662.

- Macintosh Cable Adapter

Component Names and Functions

Main Unit

Front view of main body

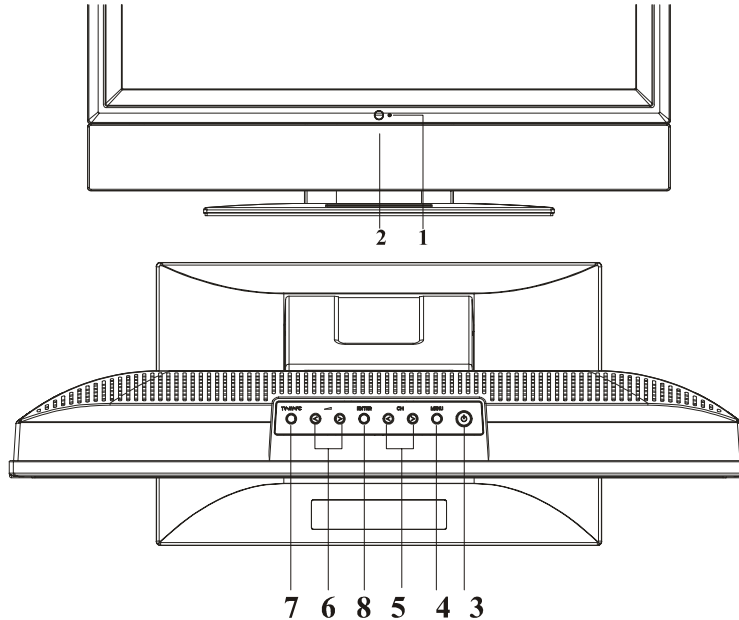

1		Indicator for Power	LED lights Green color --- Power is ON. LED lights Orange --- Monitor is in "Power Saving Mode". LED is off --- Power is OFF.
2		IR receiver	IR receiver.
3		Power	Turn on or off the main body.
4		Menu	Open or Close the OSD menu.
5		Channel	Select the next lower channel / higher channel (TV/AV mode) ; OSD function for selecting (PC mode).
6		Volume	Lower / Raise the sound volume (TV/AV mode) ; OSD function for adjusting (PC mode).
7		Source	Selection TV, AV-1(COMPOSITE), AV-2(S-VIDEO), AV3(YCbCr / YPbPr), AV4(YCbCr / YPbPr) , RGB1 PC or RGB2 DVI.
8		Enter	Enter for adjusting or next page.

Rear view of main body

1	RF in	Please connect to antenna or cable TV signal.
2	VGA input	Please use the 15-pin VGA cable in the package contents.
3	AV3-in	For component Video input and audio.
4	AV1/2-in	For composite video or S-video input and audio.
5	AV4-in	For component Video input and audio.
6	PC Audio in	Please connect the audio from sound card to PC Audio in.
7	DC in	Please connect to your 19V power supply.
8	DVI in	Please use the DVI cable for signal input
9	Kensington Lock hole	It can be locked with Kensington lock.
10	Speaker -R	Connect to Right-speaker
11	Speaker -L	Connect to Left-speaker
12	Audio out	For Audio R/L output & Subwoofer.

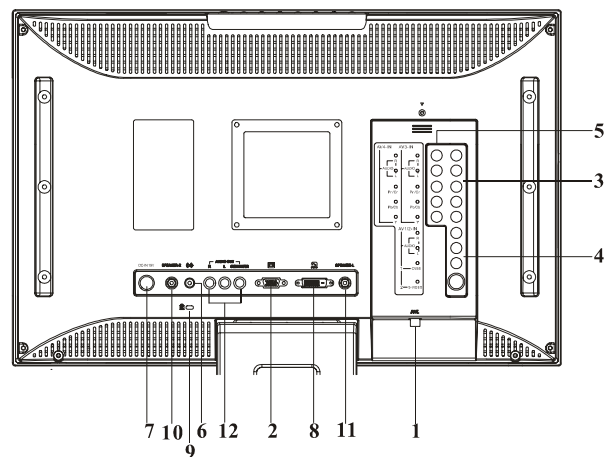

Component Names and Functions continued

Remote Control

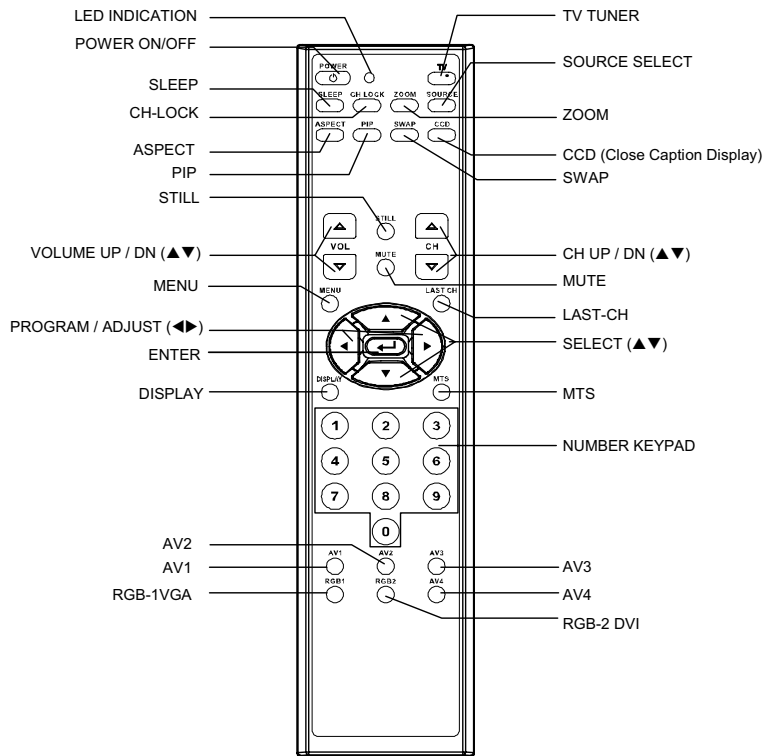

Installing the Batteries

1. Open the battery cover.

- Slide back and remove the battery cover in the direction of the arrow.

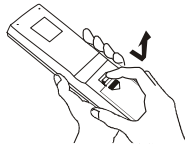

2. Installing the batteries.

- Install two included Size AA batteries observing the correct polarities(+,-).

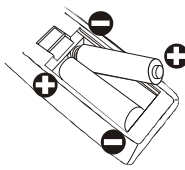

3. Close the battery cover.

- Replace the battery cover in the direction of the arrow and snap it back into place.

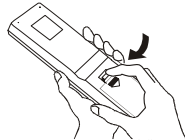

CAUTION

- Do not mix new and old batteries together. The batteries could explode or leak, resulting in fires, physical injury, or stains.
- When inserting batteries, observe their correct polarities as marked on the product. If inserted in the wrong direction, the batteries could explode or leak, resulting in fires, physical injury, or stains.

Handling the Remote Control

Use the remote control within about 16 feet from front of the unit's remote-control sensor and within 30 degrees on both sides.

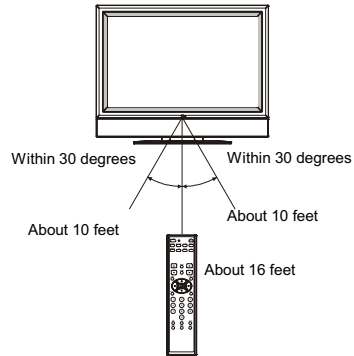

ATTENTION

- Do not drop the remote control.
- To avoid possible failures, do not splash the remote control with water or put it on a wet object.
- If leaving the remote control out of use for an extended period of time, remove the batteries from it.
- If the remote control does not respond properly, replace the batteries.
- Strong light such as direct sunlight exposed on the photoreceptor of the remote control can cause operational failure. Position this unit to avoid direct contact with such light.

Component Names and Functions continued

Remote Control (continued)

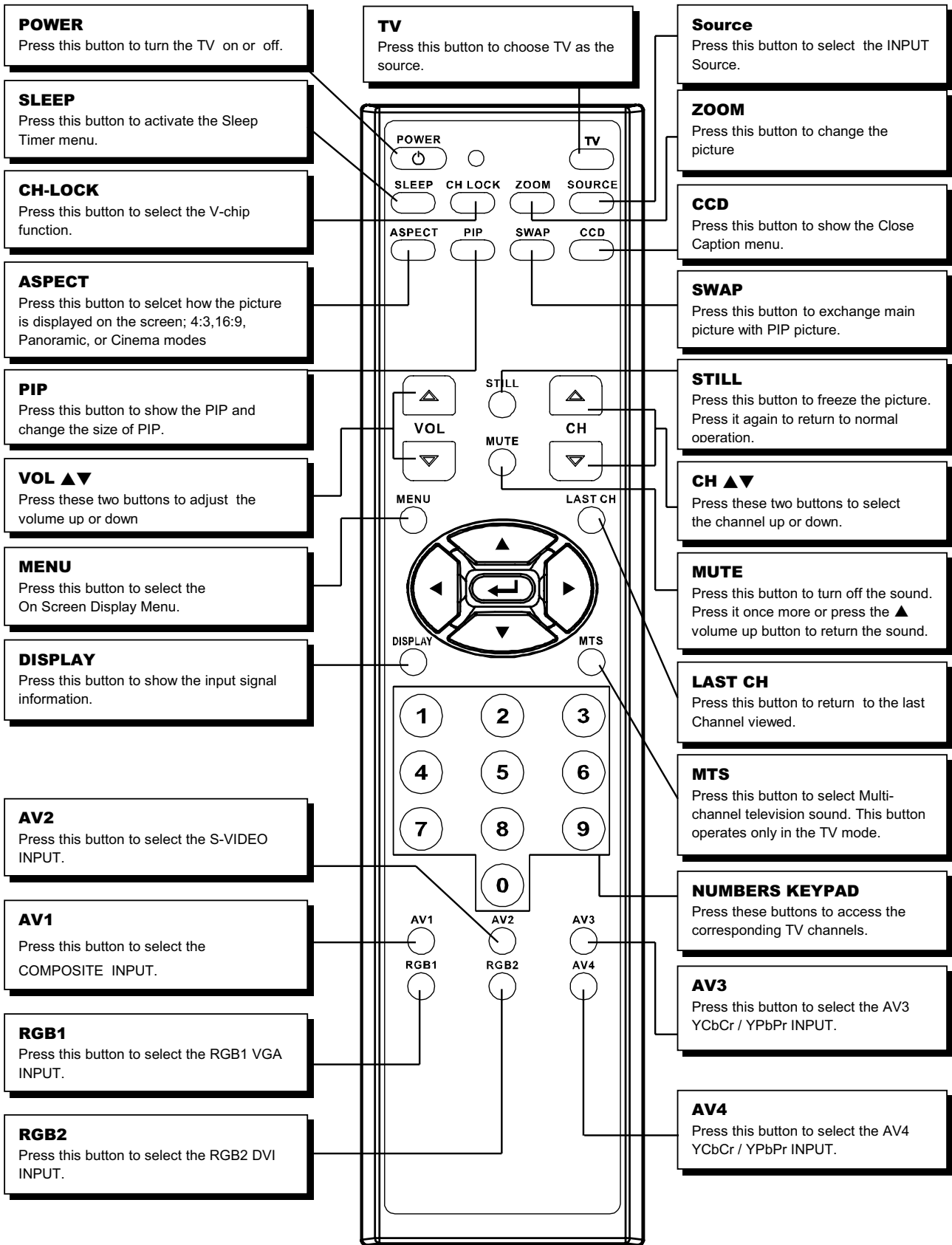

Installation Instructions

Viewing Angle Adjustment

This product is designed to allow users to have a comfortable viewing angle. The viewing angle can be adjusted from -5° to $+20^{\circ}$.

Warning: Do not force the LCD Monitor over its maximum viewing angle as stated above. Attempting this will result in damaging the Monitor and Monitor stand.

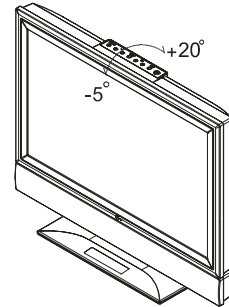

Detaching Main Body From Its Stand

Important: Place the monitor on a clean, flat surface that will not scratch the front or glass surfaces of the display unit.

1. Remove the rear cover from rear stand assembly
2. Remove the 5 screws from the hinge bracket
3. Remove the stand from main body

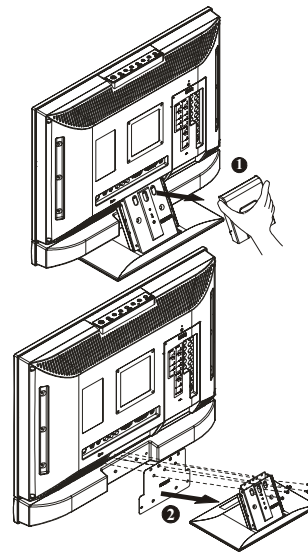

Interface for Arm Applications

Before installing to mounting device, please refer to Fig.1-5.

The rear of this LCD display has four integrated 4 mm, 0.7 pitches threaded nuts, as well as four 5 mm access holes in the plastic covering as illustrated in Figure 1-8. These specifications meet the VESA Flat Panel Monitor Physical Mounting Interface Standard (paragraphs 2.1 and 2.1.3, version 1, dated 13 November 1997).

Note 1: Please using $\varnothing 4\text{mm} \times 8\text{mm}$ (L) screw for this application.

Note 2: The LCD monitor should only be used with an approved arm (e.g. GS mark). To meet the safety requirements, the monitor must be mounted to an arm which guaranties the necessary stability under consideration of the weight of the monitor.

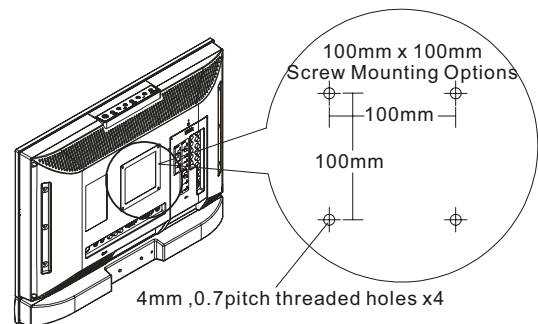

Installation Instructions continued

Connecting to a Antenna / Cable

Make sure that the power switch of the LCD MONITOR is turned off and that the unit is disconnected from the AC power source.

Monitor rear panel

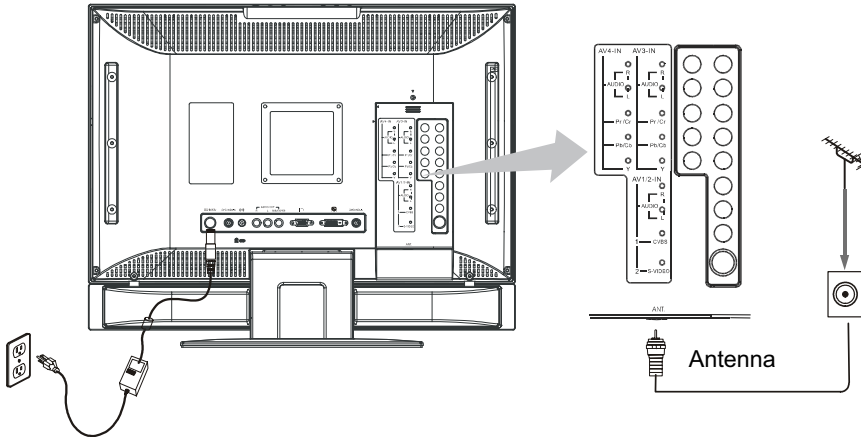

Precautions when connecting the antenna

- Use a coaxial cable which is free from interference. Avoid using a parallel flat wire as interference may occur, causing the reception to become unstable and noise to appear on the screen.
- Avoid using an indoor antenna as this may be affected by interference and poor reception.
- Keep the power cord as far away from the antenna wire as possible.
- Auto Tuning please refer to page 24

VHF(300-Ohm) antenna / UHF antenna

When using a 300-ohm twin lead from an outdoor antenna, connect the VHF or UHF antenna leads to the screws of the VHF or UHF adapter. Plug the 300-ohm to 75-ohm adapter into the antenna on the LCD MONITOR.

When both VHF and UHF antennas are combined

Attach an optional antenna cable signal combiner to the LCD MONITOR antenna terminal, and connect the cables to the antenna mixer. Consult your local electronics retailer about available signal combiners.

Reconnect the unit to the AX power source and turn on the power.

Using the Remote Control or User Controls, select the "CHANNEL SETTING MENU". Select the appropriate menu based upon which source (cable or antenna) is being used.

Refer to pages 15 and 16 for further information on the "CHANNEL SETTING MENU" as well as for information on how to use the "AUTO PROGRAM" function to program available channels.

Installation Instructions continued

Connecting to a Video Components

1. Make sure that the power switch of the LCD MONITOR is turned off.
2. Make sure that the power switch of the Video component is turned off.

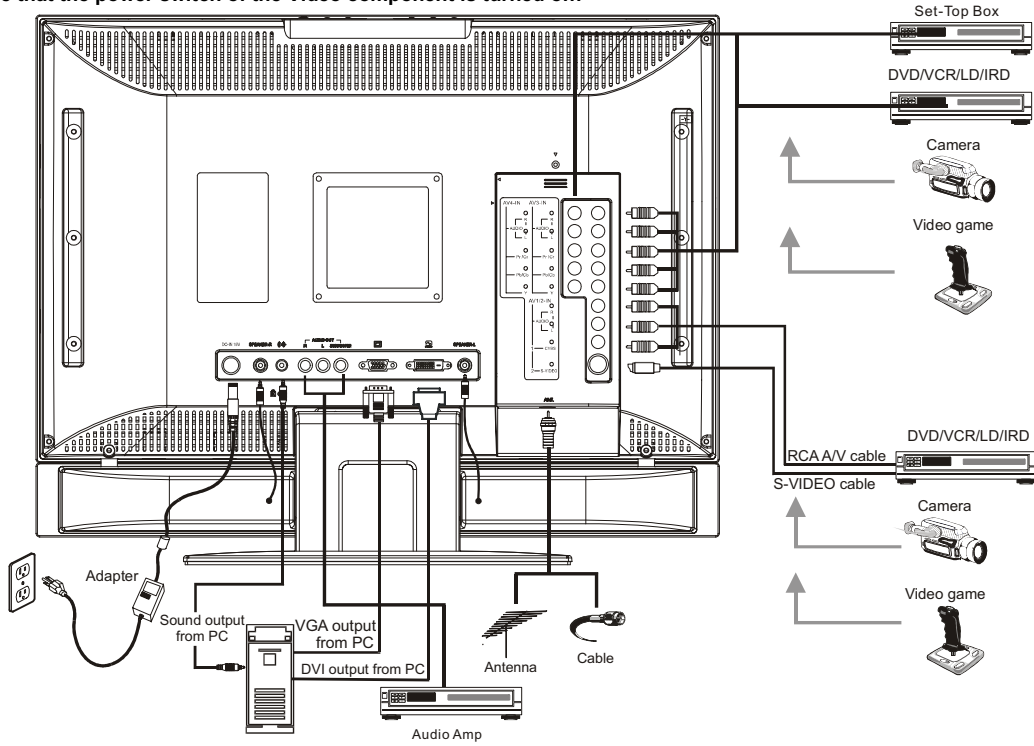

Applicable video signals for each input terminal

(See page 12 for details)

Terminal	RCA			DVI	D-sub	Remarks
	Video (Composite)	S-Video	Component			
Type	Video (Composite)	S-Video	Component	PC/STB	RGB	
AV1	○					Refer to page 12
AV2		○				Refer to page 12
AV3			○			1080i/720P/480P/480i inputs. Refer to page 12
AV4			○			1080i/720P/480P/480i inputs. Refer to page 12
RGB1					○	Refer to page 12
RGB2				○		Refer to page 12

(○: Available)

Installation Instructions continued

Connecting to a PC

Choose an appropriate site and install the product on a level table where the stand is secure. Ensure that a power socket is readily accessible near the place where you install the LCD MONITOR. Make sure that the power switch of this device is turned off.

1. Make sure that the display signal of the personal computer to be used is compatible with the specifications of this device.

See "Product Specifications" concerning the specifications of this device.

2. Make sure that the power switch of the personal computer is turned off.

3. Connect the signal input terminal (RGB 1 or RGB 2) on the rear panel of this device to the display signal output terminal of the personal computer.

- Use a cable that fits the input terminal of this device and the output terminal of the personal computer.
- Depending on the type of personal computer being connected, the use of an optional conversion adapter or the adapter provided with the personal computer may be necessary in some cases. For details, refer to the instruction manual of the personal computer or ask the personal computer manufacturer or your local retail.

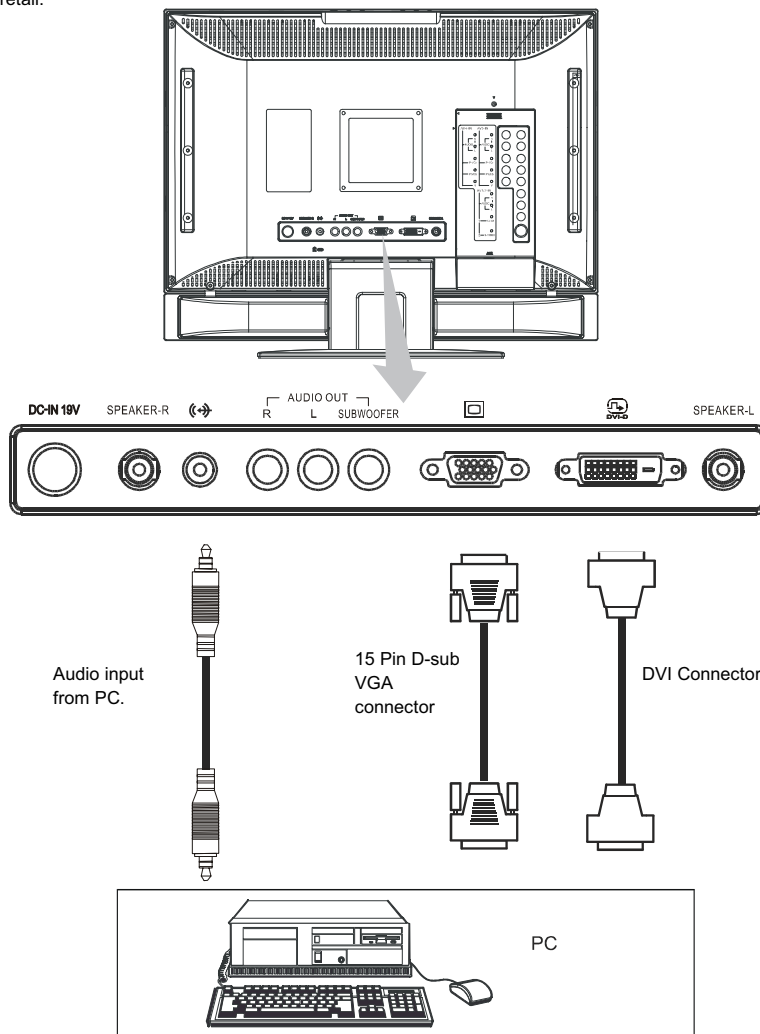

Note

PREVENTION OF SCREEN BURN

Continuous on-screen display of fixed (non-moving) images, such as video games, stock market quotations, computer generated graphics and other patterns can cause permanent damage to the LCD MONITOR. Such "SCREEN BURN-IN" constitutes misuse and IS NOT COVERED by our Factory Warranty.

Subwoofer Output provides a single un-amplified audio output that passes along the audio signal from the LCD MONITOR.

Note: When using a Home Theater audio system with this LCD MONITOR, please connect the sub woofer (if originally supplied with the audio system) directly to the Home Theater components subwoofer terminal.

Operating Instructions

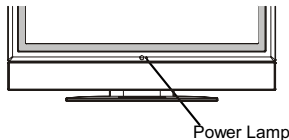

1

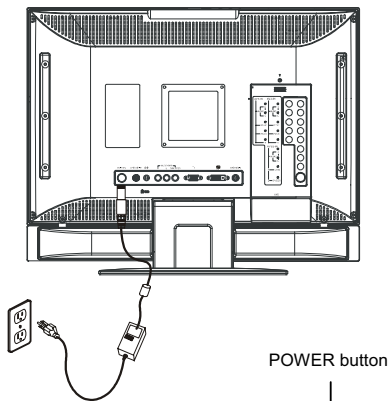

2



POWER ON/OFF button

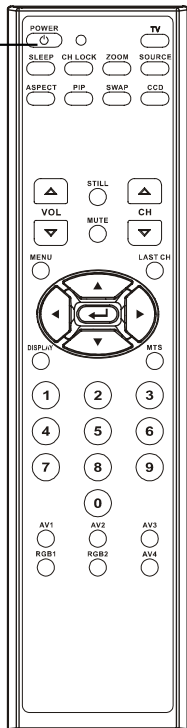

Turning Power On and Off

To turn the LCD MONITOR power ON/OFF, press the POWER button or the ON/OFF button on the remote control.

The power lamp will light and turn to green, the LCD MONITOR will turn on.

- Note: During normal use, the main power switch is set in the ON position.

Power lamp

Power lamp	Power lamp	Operation
Off	Off	The OFF button on the remote control or the POWER button is OFF.
Lights green	On	When the power switch is ON, and the ON button on the remote control or the POWER button is ON.
Lights orange	On	When the power switch is ON, and the PC is in power save mode.

When the indicator lamp lights orange or the message "No cable connected" or "Going to sleep" appears on the screen, there is something abnormal about the status of the reception. See Trouble Shooting.

CAUTION

- Avoid repeatedly turning the LCD MONITOR on and off at short time intervals. Failures might result from doing so.
- If a power failure occurs while the main unit is running, it will be powered on upon recovery from the failure. To prevent the power from returning unexpectedly, possibly causing damage, turn off the main power switch when after power failure occurs. Unplug the AC power source to the AC adapter for 30 seconds to reset the unit.

Operating Instructions continued

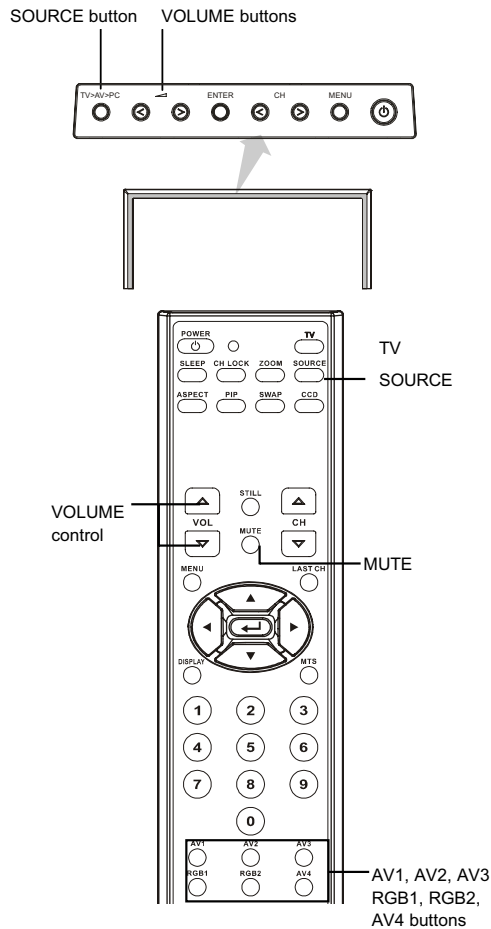

Volume Adjustment

The volume can be adjusted by pressing the ▲ and ▼ buttons of the remote control.

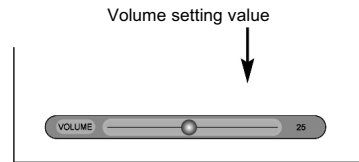

Adjustment status guide

●When the volume buttons are pressed, the volume adjustment status guide will be displayed.

- The volume will increase when the VOL+ (or ▲) button is pressed while the guide is being displayed.
- The volume will decrease when the VOL- (or ▼) button is pressed while the guide is being displayed.

Audio Mute

The audio volume can be temporarily muted by pressing the MUTE button of the remote control.

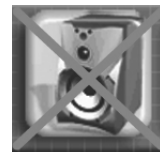

When the MUTE button is pressed, the above icon will appear.

- The volume setting can be lowered by pressing the VOL- button while the audio is muted.
- Muting can be cancelled by pressing the VOL+ button or the MUTE button while the audio is muted.

Selecting AV Inputs

- Input can be switched by pressing the AV1, AV2, AV3, AV4, RGB1, or RGB2 buttons
- Input can be switched in the sequence TV→AV1 →AV2→ AV3 →AV4 → RGB1 VGA → RGB2 DVI by pressing the SOURCE button and then select the Input with the select keys ▲ ▼ and then press the ENTER button. To select a TV station, press the TV button.

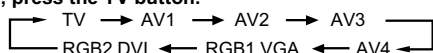

Operating Instructions continued

PC Parameters

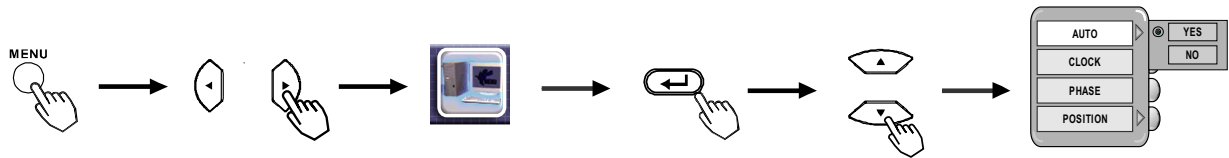

Selected characters			Setup hint
	◀	▶	
AUTO	Press the ENTER button to make the word "YES" light on.		Normally set to NO mode. Adjust automatically for clock, phase, and position.
CLOCK	Reduces the dot clock.	Increases the dot clock.	Adjust for maximum character clarity.
PHASE	Slows the dot clock Phase	Advances the dot clock Phase	Adjust for clear character visibility.
POSITION	Press the PROGRAM button to adjust the display position		Adjust the horizontal and vertical display positions.

Audio Setting

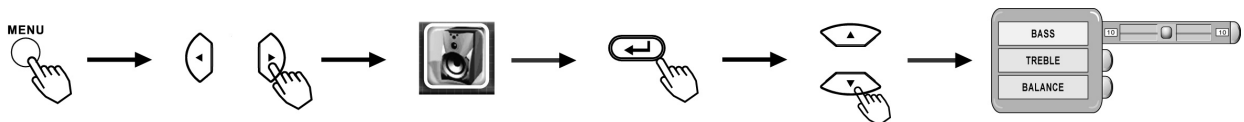

Selected characters			Setup hint
	◀	▶	
BASS	Decreases bass.	Increases bass.	Adjust as desired.
TREBLE	Decreases treble.	Increases treble.	Adjust as desired.
BALANCE	Decreases right volume level.	Increases left volume level.	Adjust as desired.

Note: Not all menus are available for every input source.

Operating Instructions continued

Channel Setting

*Note: The TV must be in TV mode for access to this Menu.

When operating the TV at first time, its TV system is at "default factory mode" and this mode cannot display the image normally on the screen. In order to watch the TV program without problem, please refer to the follow steps to setup the TV system accordingly for normally display

1.SYSTEM setting: Select between antenna or cable (STD / HRC / IRC) TV system

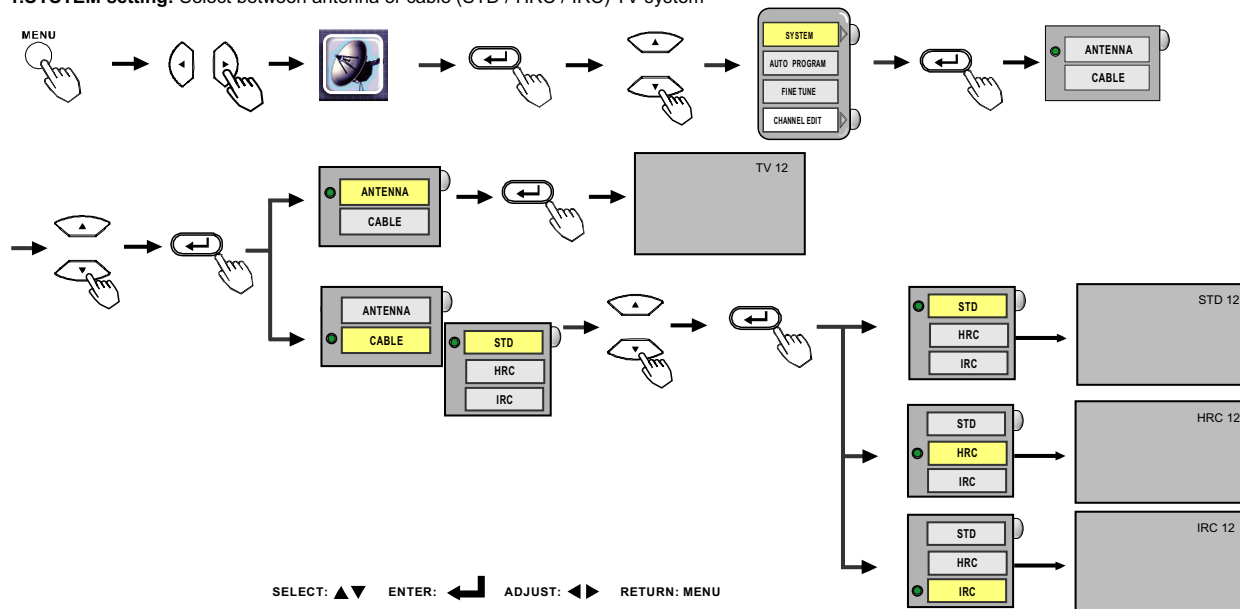

2. Auto Program setting

AUTO PROGRAM: Auto search channels

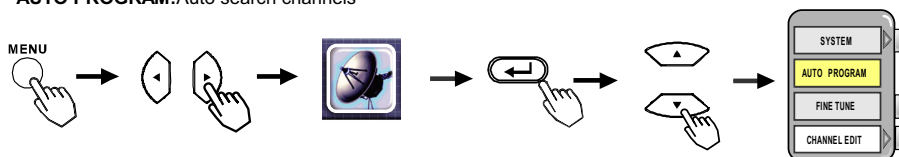

SELECT: ▲▼ ENTER: ◀ ADJUST: ◀▶ RETURN: MENU

3.FINE TUNE setting

AUTO: Use AUTO function to fine tune screen

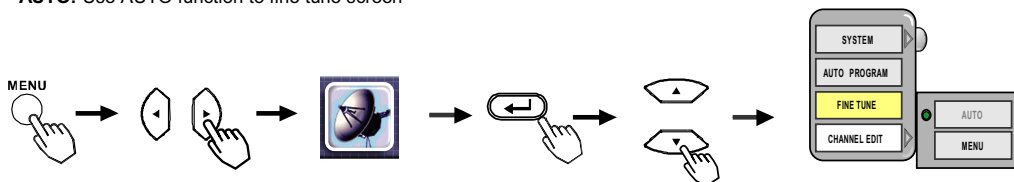

MANUAL: Use MANUAL function to fine tune screen

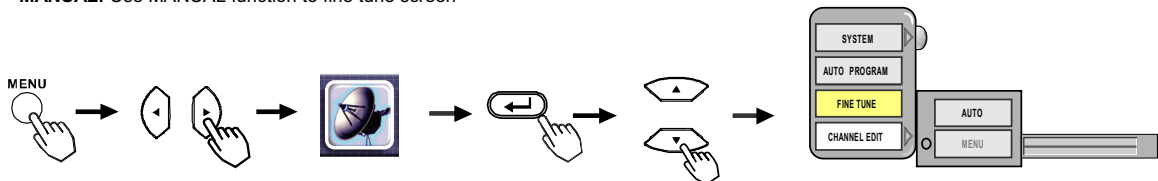

Note: Not all menus are available for every input source.

Operating Instructions continued

Channel Setting (Continued)

4.Channel Edit setting

CHANNEL ADD: Change the OSD channel number from Red to Green

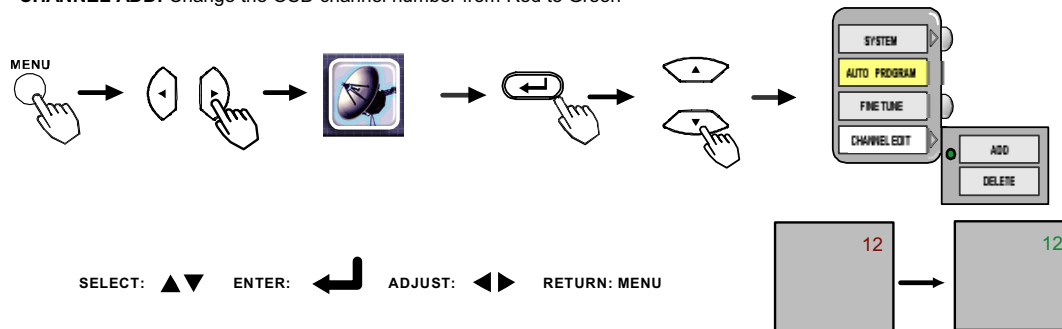

CHANNEL DELETE: Change the OSD channel number from Green to Red

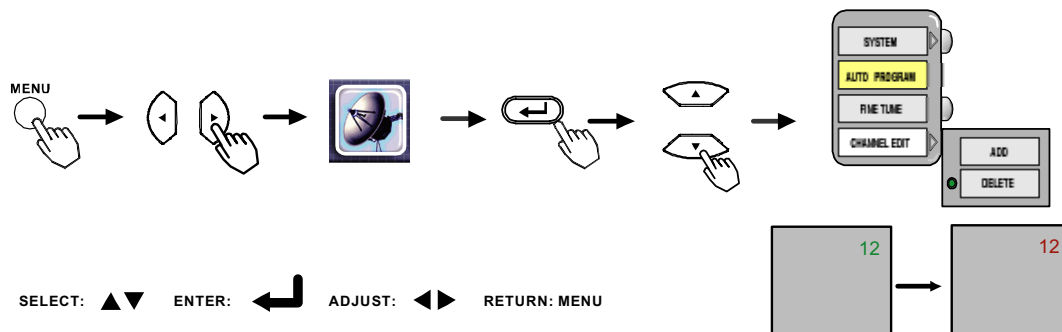

Selected characters	◀ ▶	Setup hint
SYSTEM	1. → ANTENNA ↔ CABLE ← 2. CABLE → STD ↔ HRC ↔ IRC ←	1. Antenna or cable TV system selection. 2. If certain CABLE TV channels are poor or not possible in [STD] mode, select[HRC] or [IRC].
AUTO PROGRAM	Press Enter button to excute.	Auto program is Auto search channel with TV
FINE TUNE	→ AUTO ↔ MANUAL ←	1. Use AUTO function to fine tune screen. 2. Use MANUAL function to fine tune screen.
CHANNEL EDIT	→ ADD ↔ DELETE ←	1. Add function is add new channel with TV 2. Delete function is delete commercial channel for TV

Note: Not all menus are available for every input source.

Operating Instructions continued

ASPECT

The ASPECT button will select how the video image appears on the TV's screen.

There are 4 selections.

16:9	Display a wide screen image.
4:3	Displays a 4:3 square picture with letterbox bands
PANORAMIC	Stretches the picture to increase the size of Images in the center of the picture.
CINEMA	Magnifies the image to fill the screen with a picture.

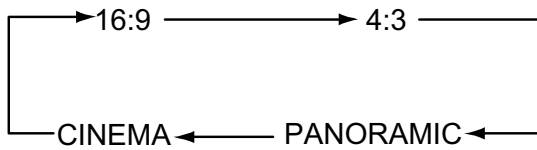

Note : For RGB1 VGA and RGB 2 DVI, you can select 4:3 and 16:9 aspect mode.

Note : For HDTV 1080i, 720p and 480p inputs (AV3 / AV4) ,you can select 4:3 and 16:9 aspect mode.

ZOOM

Each time the ZOOM button of the remote control is

Pressed, the image on the screen will be enlarged.

There are 10 selections, Zoom 0 (=Normal size) to Zoom 9.

Note:ZOOM is available in 4:3 and 16:9 aspect mode.

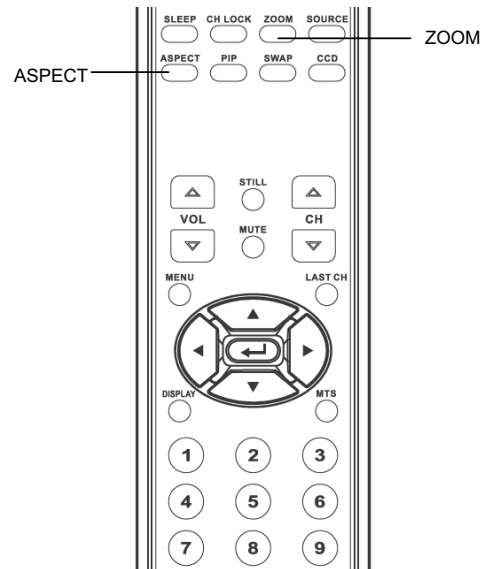

Note: Not all menus are available for every input source.

Operating Instructions continued

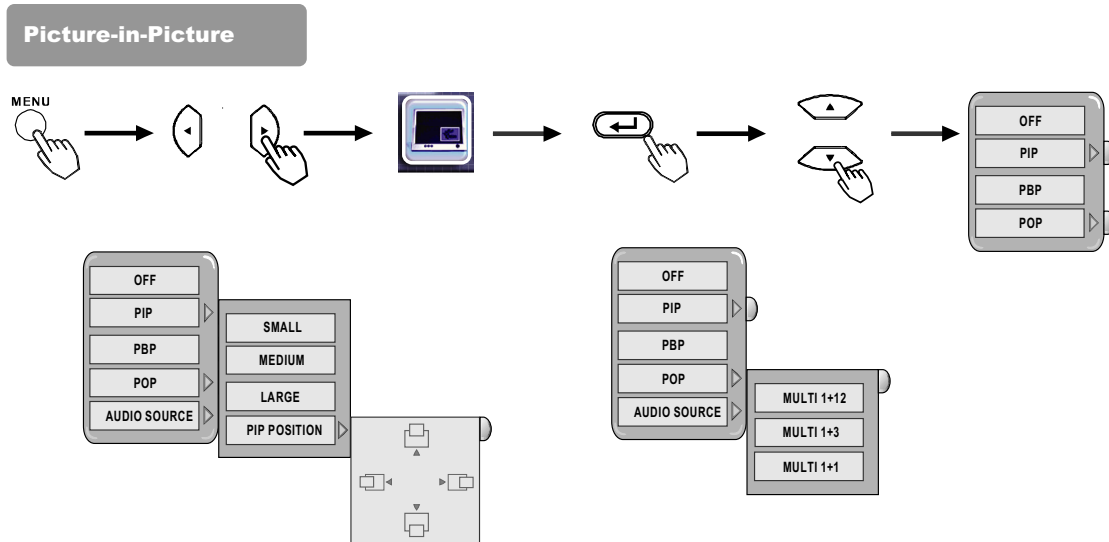

PIP function description

Selected	◀	▶	Setup hint
OFF	Press Enter button to turn off.		Turn off Picture-in-Picture function
PIP POSITION	<p>PIP Position: Use the ▲ ▼ buttons to adjust pictures to the up or down positions. Use the ◀ ▶ buttons to adjust pictures to the right or left positions.</p>		Change PIP display size & position.
PBP	Press Enter button to turn on.		Turn on Picture-by-Picture function
POP	(MULTI 1+12) ↔ (MULTI 1+3) ↔ (MULTI 1+1)		use the ▲ ▼ buttons to select the PIP setting.
AUDIO SOURCE	MAIN	PIP	Select MAIN or PIP audio function.

Note: Not all menus are available for every input source.

Operating Instructions continued

PICTURE IN PICTURE (Continued)

Selecting PIP size

When the PIP button on the remote control is pressed, a black box will appear on the screen.



Each time the PIP button is pressed, the size of box changes as follows.

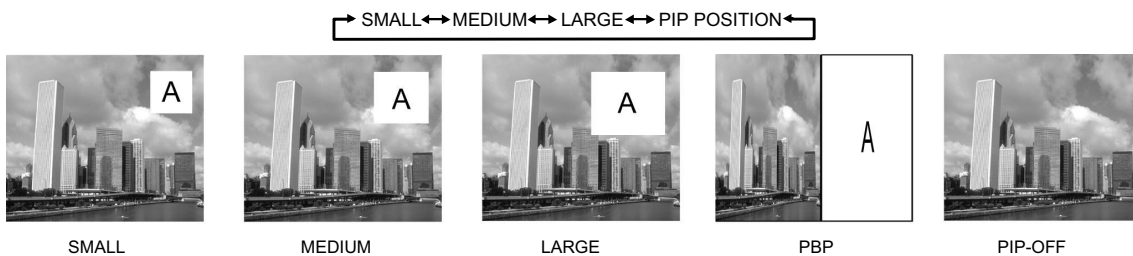
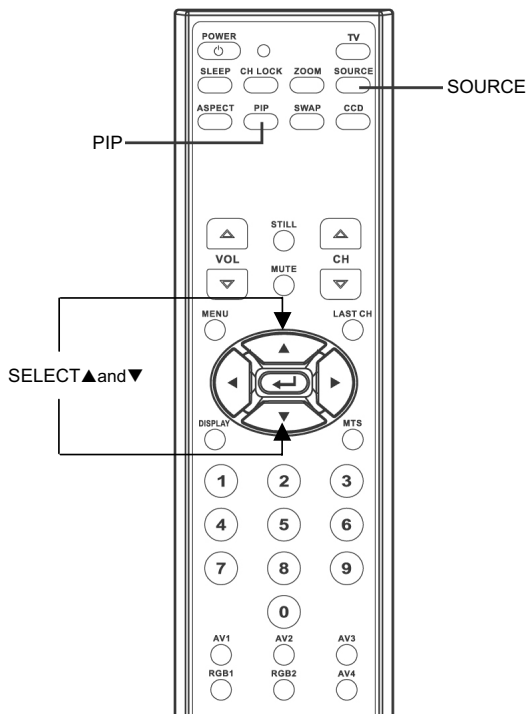

Selecting PIP Source

While a black box appears on the screen, press SOURCE button and PIP SOURCE menu appears.

Picture mode will change in the following sequence, each time the remote button is pressed.

Select the SOURCE by using the ▼ ▲ select keys on the remote control. Then, press the ENTER button.

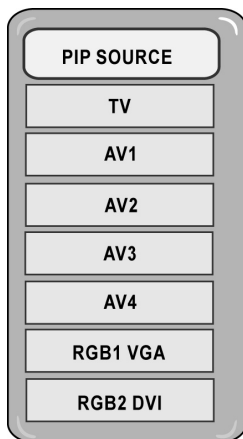

Note: Not all menus are available for every input source.

Operating Instructions continued

PICTURE IN PICTURE (Continued)

Setting Up PIP through On Screen Main Menu



1. Press the "MENU" button to display the Main Menu screen.
2. Select " PICTURE IN PICTURE" Menu with ◀▶ ADJUST button and press ⏏ ENTER button, then following menu will appear.

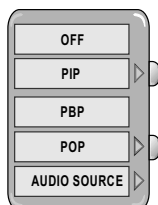

Select PIP size

1. Press ⏏ ENTER button.
2. Select the PIP size with ▲ ▼ SELECT button.
3. Press ⏏ ENTER button.
4. Press "MENU" button 2 times to return to PICTURE IN PICTURE Main Menu.
5. Press "MENU" to exit.

Select PIP Source

While a black box appears on the screen, press SOURCE button and PIP source MENU appears.

Select the SOURCE by using the▲ ▼ SELECT buttons on the remote control. Then press the ⏏ ENTER button.

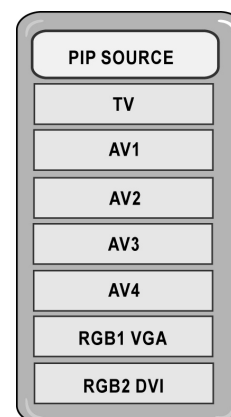

PIP Combination Table

Available signals are limited in PIP mode as shown in the table below.

		Sub Source						
		RGB1 VGA	RGB2 DVI	TV	AV1 COMPOSITE	AV2 S-VIDEO	AV3 COMPONENT1	AV4 COMPONENT2
Main Source	RGB1 VGA	X	O	O	O	O	O	O
	RGB2 DVI	O	X	O	O	O	O	O
	AV1 COMPOSITE	O	O	X	X	X	O	O
	AV2 S-VIDEO	O	O	X	X	X	O	O
	AV3 COMPONENT 1	O	O	O	O	O	X	X
	AV4 COMPONENT 2	O	O	O	O	O	X	X
	TV	O	O	X	X	X	O	O



Note: Not all menus are available for every input source.

Operating Instructions continued

PICTURE IN PICTURE (Continued)

Change PIP Position

After selecting PIP and PIP Source,

1. Press the "MENU" button to display on the On Screen Main Menu.
2. Select "PICTURE IN PICTURE" Menu with ◀ ▶ ADJUST button.
3. Press  ENTER button. The following Menu and a diagram will appear.
4. Select "PIP" with ▲ ▼ SELECT button.
5. Press the  ENTER Key, then select "PIP POSITION" with ▲ ▼ SELECT button and a white ball appears in the center of the diagram.

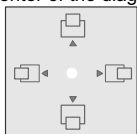

6. Move the PIP display with ▲ ▼ SELECT and ◀ ▶ ADJUST buttons.
7. Press "MENU" button 2 times to return to "PICTURE IN PICTURE" Menu.

Multi PIP

After selecting PIP Size and PIP Source

1. Press the "MENU" button to display on the On Screen Main Menu.
2. Select "PICTURE IN PICTURE" Menu with ◀ ▶ ADJUST button.
3. Press ENTER button. The following Menu and a diagram will appear.
4. Select "POP" with ▲ ▼ SELECT button.
5. Press the  ENTER Key, then select "MULTI" with ▲ ▼ SELECT button



6. Press "MENU" key 2 times to return to "PICTURE IN PICTURE" Menu.

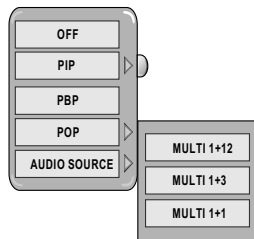
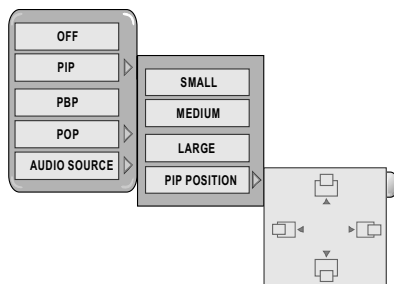

MULTI(1+12)

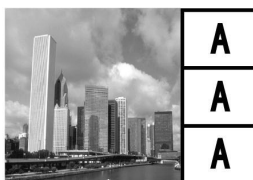

MULTI(1+3)



MULTI(1+1)

Note: Not all menus are available for every input source.

Operating Instructions continued

Other Functions

- The MTS button is used only when using the TV channel selector.

Stereo and SAP (2nd Audio program) sound program

When a bilingual program is received, the sound mode display appears as shown on the right.

Press the MTS button to select the sound to be heard.

Each time the button is pressed, Stereo, SAP or Mono appears on the screen.

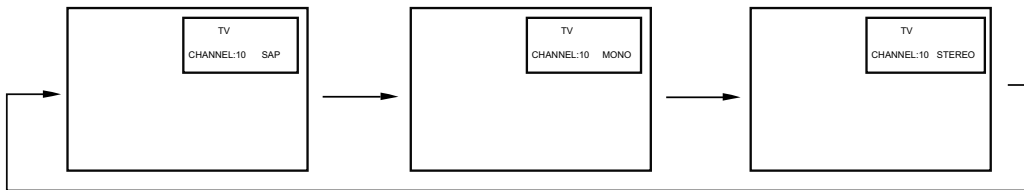

Mono and SAP (2nd Audio program) sound program

When a program is received, the sound mode display will appear as shown on the right, and you can press the MTS button to select between SAP and mono sound.

Each time the button is pressed, SAP or Mono will appear on the screen.

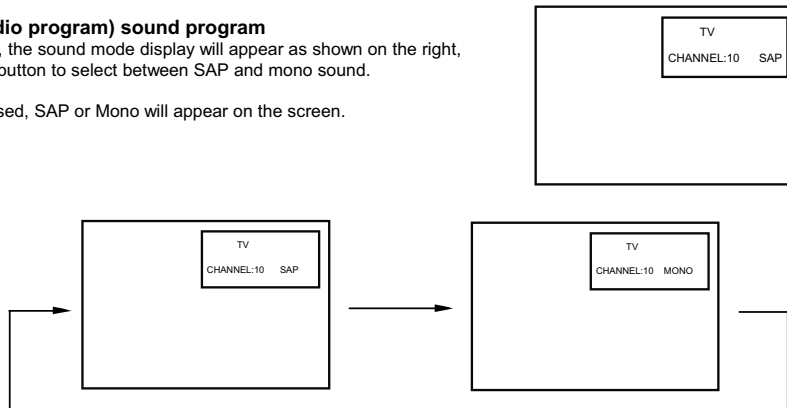

Monaural sound

When a monaural program is received, the sound mode display will be shown. You can press the MTS button to manually select monaural Sound.

NOTES

- If the sound signal is not strong enough, press the MTS button until Mono appears on the screen, to receive a clear mono sound.
- If the sound has a hiss noise or keeps switching between stereo and mono mode or SAP and mono mode due to signal strength, press the MTS button until Mono appears on the screen to receive a clear mono sound.

Stereo sound

When a stereo program is received, the sound mode display will be shown.

You can press the MTS button to select the sound mode for stereo or mono reception.

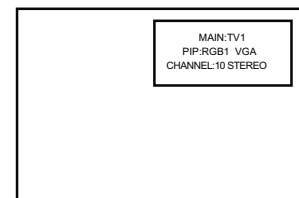

Note: Not all menus are available for every input source.

Operating Instructions continued

Parental Controls

Press "MENU" button and select PARENTAL CONTROLS menu with the ◀ ▶ PROGRAM ADJUST buttons, then press the ↵ ENTER button. Enter the V chip Password: the factory preset code is 1111.

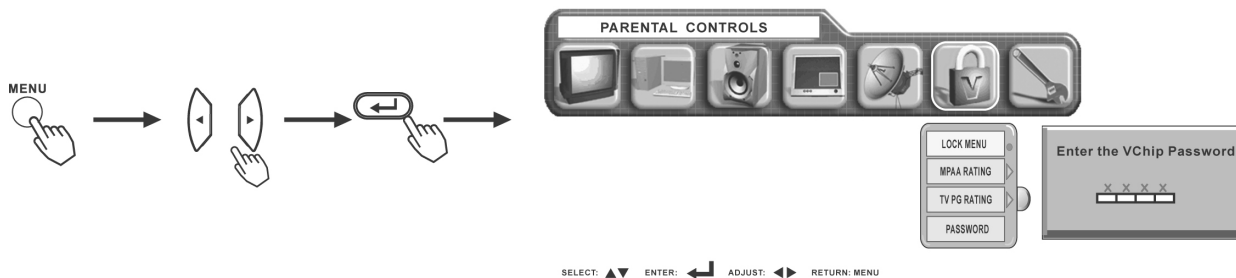

MPAA RATING

A second Menu appears. Select MPAA by pressing the ↵ ENTER button. Select rating by pressing the ▼ ▲ SELECT buttons. Press the ↵ ENTER button to enter the rating. Press "MENU" button twice to return to parental controls. Press "Menu" button to exit screen.

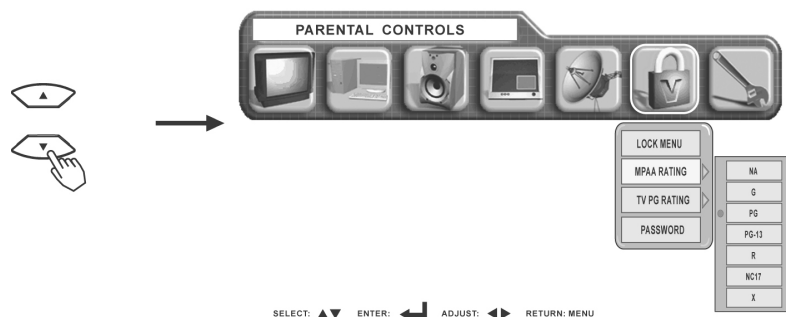

TV PG RATING

1. Press "MENU" button and select PARENTAL CONTROLS menu with the ◀ ▶ PROGRAM ADJUST buttons, then press the ↵ ENTER button. Enter the V chip Password: the factory preset code is 1111.
2. A second Menu appears. Select TV PG Rating by pressing the ▼ SELECT button. Press the ↵ ENTER button, a third Menu appears. Press the ▼ ▲ SELECT buttons to select rating, press the ↵ ENTER button to enter the rating.
3. Select the ratings with ▼ ▲ PROGRAM ADJUST buttons. Press the ENTER button to set the rating, a dot will appear next to the rating.
4. To exit the sub menu press "MENU" button.
5. To exit the TV PG Rating menu, press the "MENU" button.
6. To exit Parental Controls Menu, press the "MENU" button a second time.

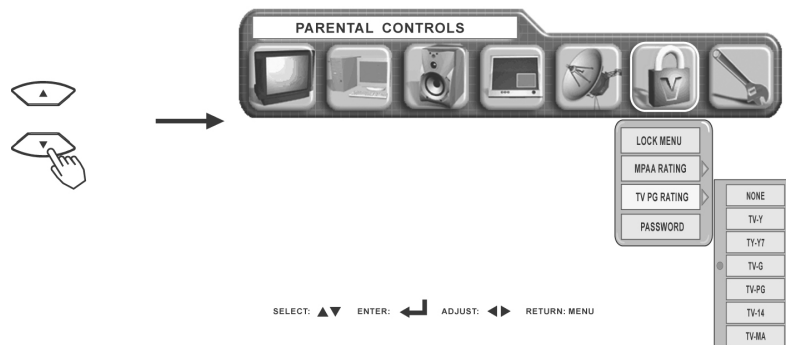

Note: Not all menus are available for every input source.

Operating Instructions continued

Parental Controls (Continued)

PASSWORD

1. Press "MENU" button and select PARENTAL CONTROLS menu with the ◀ ▶ PROGRAM ADJUST buttons, then press the ⏏ ENTER button. Enter the V chip Password: the factory preset code is 1111.
2. A second Menu appears. Select password by pressing the ▼ SELECT button, press the ⏏ ENTER button, Enter the new password using the numbers on the TV's remote control.
3. Enter the password a second time to continue.
4. A password confirmed window will appear. Press Menu button to exit Parental Controls.

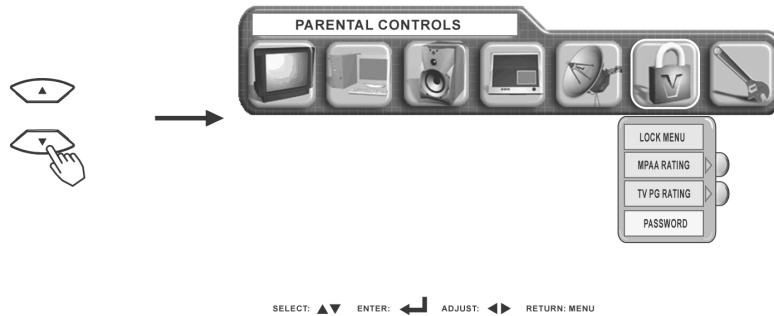

This function will block out the selected channel or video input. The code to enter the LOCKS feature is a four-digit secret code number. Use the number buttons to select the secret code.

Change Password	Enter Password	The factory preset code is (1111).
	Enter NEW Password	This is used to enter a new four digit number you prefer.
MPAA RATING	NA; G; PG; PG-13; R; NC-17; X	When this is selected, you can block various types of movies and videotapes based on motion picture ratings. Picture-in Picture will also be blocked automatically.
TV PG RATING	NONE; TV-Y; TV-Y7 (FV); TV-G; TV-PG (D; L; S; V) TV-14 (D; L; S; V); TV-MA (L; S; V)	When this is selected, various types of television programming based on parental guide ratings will be blocked. Picture-in-Picture will also be blocked automatically.

The password prevents viewing of any movie that you feel may be inappropriate due to its content. Use the ▲ or ▼ SELECT buttons to select the MPAA RATING category that you want to block. Press the OK button to block the MPAA RATING that you have selected. Once the rating is selected, for example PG-13, all MPAA rated PG-13 and higher (R, NC-17 and X) movies will be blocked. Press RETURN to return to the previous menu.

Motion Picture Ratings Chart	
NA	Contains no rating. Not Rated and Not Applicable (NA) programs. Movie has not been rated or ratings do not apply.
G	General audiences. All ages are permitted to watch.
PG	Parental guidance suggested. Some material may not be suitable for children.
PG-13	Parents strongly cautioned. Some material may be inappropriate for children under 13.
R	Restricted. Under 17 requires an accompanying parent or adult guardian.
NC-17	No one 17 and under are permitted to watch.
X	Adults only.

Operating Instructions continued

TV PG RATING

This is to prevent viewing of any TV program that you feel may be inappropriate due to its content. Use the ▲ or ▼ SELECT buttons to highlight the category that you want to block. Press the OK button to block the TV PG RATING that you have selected. Press the RETURN button to return to the previous menu.

TV Parental Guide Ratings Chart	
TV-Y	All children. The themes and elements in this program are specifically designed for a very young audience, including children from ages 2-6.
TV-Y7	Directed to older children. Themes and elements in this program may include mild physical or comic violence, or may frighten children under the age of 7.
TV-G	General audience. It contains little or no violence, no strong language, and little or no sexual dialogue or situations.
TV-PG	Parental guidance suggested. The program may contain infrequent coarse language, limited violence, some suggestive sexual dialogue and situations.
TV-14	Parents strongly cautioned. This program may contain sophisticated themes, intense sexual situation, more intense violence and intensely suggestive dialogues.
TV-MA	Mature audience only. This program may contain mature themes, indecent language, graphic violence and explicit sexual content.
F VIOLENCE	Fantasy Violence
VIOLENCE	Moderate Violence
SEXUAL CONTENT	Sexual Situations
FOUL LANGUAGE	Coarse Language
SUGGESTIVE DIA	Suggestive Dialogue

NOTE

If you block TV-14D, you will still permit TV MA programs; if you block TV-14DV, you will automatically block TV-MAV programs, but you will still permit TV-MALS programs. This means that the TV will block violence in TV-14 and higher (TV-MA), but not language and sex.

Operating Instructions continued

General Setting

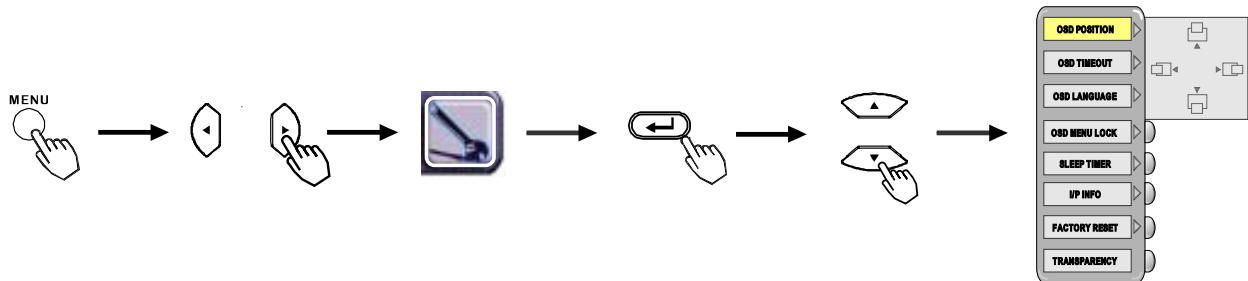

Selected characters	▲	▼	Setup hint
OSD POSITION	Use the ▲ ▼ and ◀ ▶ buttons to adjust the OSD position		Adjusts the OSD position
OSD TIMEOUT	10SEC--30SEC—1 MIN		Adjusts OSD display and on-screen time
OSD LANGUAGE	English—Japan—Espanol—Francais		Sets the language for the OSD.
OSD MENU LOCK	ON	OFF	1. Select "ON" to lock OSD MENU. A message appears stating that the TV is lock. 2. Press the MENU button and volume increase (on the keypad) simultaneously. A message appears stating that the TV is unlocked.
SLEEP TIMER	Use the ▲ ▼ buttons to set the TV off time mode.		Set the TV off time for each mode (OFF/30MIN/ 60MIN/ 120 MIN)
INPUT INFO	To display information about the input signal.		Displays information about the input signal
FACTORY RESET	YES	NO	Resets all settings to FACTORY defaults.
TRANSPARENCY	Use the ◀ ▶ buttons to adjust OSD menu transparency		Adjusts OSD MENU transparency



* Depending on the type of signal displayed, displays may not be optimized through automatic adjustment. Manually adjust to optimize them.



* When operating the TV at first time, its TV system is at "default factory mode" and this mode cannot display the image normally on the screen. In order to watch the TV program without problem, please refer to the page 25 to setup the TV system accordingly for normally display.

Operating Instructions continued

Captions Menu

Setup Closed Caption



Press the CCD button on the remote control then press the  ENTER button. Select MODE menu by pressing the  SELECT button and press the  ENTER button.

Select the closed caption by pressing the  SELECT buttons. Press the  ENTER button.

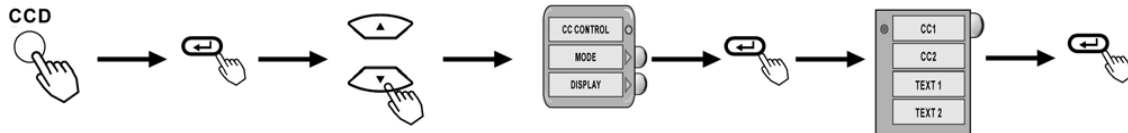
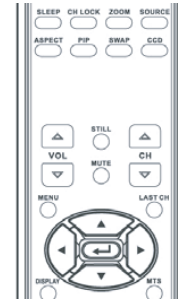
To exit Captions Menu, press the MENU button twice.



To Select Box or Shadow display

Press the CCD button on the remote control and DISPLAY menu by pressing the  SELECT button and press the  ENTER button.

Select BOX or SHADOW. Press the  ENTER button.

To exit Captions Menu, press the MENU button twice.

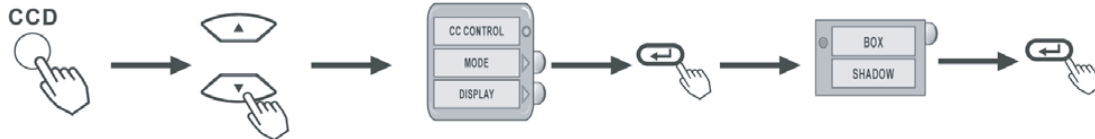

Closed Captions are the dialogues, narration and/or sound effects of a television program or home video that are displayed on the LCD Television screen.

Caption Display	Press the CCD button then press Enter button.	[1] Press the CCD button on the remote control then press the ENTER button to enter the captions Menu. [2] Press the MENU button twice to exit.
Mode	CC1- -CC2- - TEX1---TEXT2	[Captions] is for the program you are viewing. [Text] is for additional information such as news reports or a TV program guide. This information covers the entire screen and viewing the TV program is not possible. Text may not be available with every [C.C] program.
Channel (Captions)	CC1- -CC2	[1] is used for the primary language (usually English)
Channel (Text)	TEX1---TEXT2	[2] is sometimes used for a second language (may vary by region). [3] is sometimes used for a third language (may vary by region). [4] is sometimes used for a fourth language (may vary by region).
BOX		[1] is used for the primary language, and has a black back ground.
SHADOW		[1] is used for the primary language, and has a line back ground.

NOTE

CAPTION DISPLAY will not work when viewing a picture via COMPONENT input (AV3/AV4:Y-CbCr/Y-PbPr) or DVI-HDTV inputs. CAPTION DISPLAY will not work for other Extended Data Services. When PIP (Multi Picture) mode is on, CAPTION DISPLAY is activated on the selected display.

Features

23" diagonal screen size adds a new option to information display visual offerings.

1280 x 768 resolution allows for crisp text and precise images.

No permanent phosphor image burn-in contributes to optimal screen performance and longer monitor life.

XtraView® technology allows for wide-angle viewing.

User-friendly, efficient design features the currently proposed VESA-standard mounting and an overall lightweight construction for easy transport and installation.

Speaker Bar delivers an enhanced multimedia experience with amazing sound quality.

Low power consumption and reduced heat emission lead to a lower total cost of ownership.

NEC's quality and reliability provide peace of mind with a 1-year warranty (including backlight) and 24/7 customer service and technical support.

No Touch Auto Adjust: No Touch Auto Adjust automatically adjusts the monitor to optimal settings upon initial setup.

Reduced Footprint: Provides the ideal solution for environments requiring superior image quality but with size and weight limitations. The monitor's small footprint and low weight allow it to be moved or transported easily from one location to another.

AccuColor® Control System with allows you to change between the color settings on your display to match your personal preference.

Plug and Play: The Microsoft® solution with the Windows®95/98/ME/2000/XP operating system facilitates setup and installation by allowing the monitor to send its capabilities (such as screen size and resolutions supported) directly to your computer, automatically optimizing display performance.

Intelligent Power Manager (IPM™) System provides innovative power-saving methods, saving two-thirds of your monitor energy costs.

Multiple Frequency Technology automatically adjusts monitor to the display card's scanning frequency, thus displaying the resolution required.

FullScan® Capability allows you to use the entire screen area in most resolutions, significantly expanding image size.

VESA Standard Mounting Interface allows users to connect their LCD monitor to any VESA standard third party mounting arm or bracket. Allows for the monitor to be mounted on a wall or an arm using any third party compliant device. NEC recommends using mounting interface that comply with UL1678 standard in North America.

DVI-D: The digital-only subset of DVI created by the Digital Display Working Group (DDWG) for digital connections between computers and displays. As a digital-only connector, analog support is not provided off a DVI-D connector. As a DVI-based digital only connection, only a simple adapter is necessary for compatibility between DVI-D and other DVI-based digital connectors such as DFP and P&D.

Troubleshooting

No picture

- The signal cable should be completely connected to the display card/computer.
- The display card should be completely seated in its slot.
- Front Power Switch and computer power switch should be in the ON position.
- Check to make sure that a supported mode has been selected on the display card or system being used. (Please consult display card or system manual to change graphics mode.)
- Check the monitor and your display card with respect to compatibility and recommended settings.
- Check the signal cable connector for bent or pushed-in pins.

Power Button does not respond

- Unplug the power cord of the monitor from the AC outlet for a minimum of 30 seconds to turn off and reset the monitor.

Image persistence

- Please be aware that LCD Technology may experience a phenomena known as Image Persistence.
- Image persistence is when a residual or "ghost" image of a previous image remains visible on the screen. Unlike CRT monitors, LCD monitors image persistence is not permanent, but constant images being displayed for a long period of time should be avoided. To alleviate image persistence, turn off the monitor for as long as the previous image was displayed. For example, if an image was on the monitor for one hour and a residual image remains, the monitor should be turned off for one hour to erase the image.

NOTE: As with all personal display devices, NEC-Mitsubishi Electronics Display recommends using a moving screen saver at regular intervals whenever the screen is idle or turning off the monitor when not in use.

Image is unstable, unfocused or swimming is apparent

- Signal cable should be completely attached to the computer.
- Use the OSD screen controls to focus and adjust display by increasing or decreasing the clock phase total. When the display mode is changed, the OSD Image Adjust settings may need to be readjusted.
- Check the monitor and your display card with respect to compatibility and recommended signal timings.
- If your text is garbled, change the video mode to non-interlace and use 60Hz refresh rate.

Image of component signal is greenish

- Check to see if the DVD/HD input connector is selected.

LED on monitor is not lit (no green or red color can be seen)

- Power Switch should be in the ON position and power cord should be connected.
- Make certain the computer is not in a power-saving mode (touch the keyboard or mouse).

Display image is not sized properly

- Use the OSDscreen controls to increase or decrease the clock total.
- Check to make sure that a supported mode has been selected on the display card or system being used. (Please consult display card or system manual to change graphics mode.)

Selected resolution is not displayed properly

- Use OSD information to enter Information menu and confirm that the appropriate resolution has been selected. If not, select corresponding option.

No Sound

- Check to see if speaker cable is properly connected.
- Check to see if mute is activated.
- Check to see if volume is set at minimum.

Remote Control is not available









- Test the Remote Control's batteries for strength/life.
- Check if the batteries are inserted correctly.
- Check if the Remote Control is pointed at the monitor's remote sensor.

Troubleshooting continued

Symptoms

If the solution does not correct the symptoms, please contact your local Service center for assistance.

	WARNING	DO NOT OPEN THE MONITOR. Self servicing can be hazardous. There are no user serviceable parts inside and opening or removing covers may expose you to dangerous shock hazards or other risks. Refer all servicing to qualified personnel.
---	----------------	--

Symptom		Point to check	See Page
There is no picture and the power-indicating lamp is off.		Check to see that the power cable is properly connected. Press the main switch.	11
The message "No cable connected" or "Going to sleep" is displayed. There is no picture and the power indicating lamp lights orange.	 	No sync signal is detected. Check that the signal cable is properly connected. Make sure that the computer, imaging equipment, etc., is turned on. Make sure the computer is not in power-save mode. Ensure that the input selection matches the connection terminal.	
The message "Invalid Mode." is displayed.		An input signal is received abnormally. Ensure that the input signal matches the monitor specifications. Check to see that the signal cable is properly connected.	32
The power indicating lamp is lit normally but there is no picture.		Check the contrast and brightness settings (adjust them for higher contrast and brightness). Check to see that the signal cable is properly connected.	13
The display image appears slanted. Text displayed across the screen appears vertically streaked, with the characters in vertical columns blurred.	 	Adjust the clock frequency and the phase. (Adjust the clock frequency first, the dot clock phase next.) (RGB input)	14
Text displayed across the screen appears blurred. A fine pattern flickers when displayed on the screen.	 	Adjust the clock phase till the desired clarity is obtained. (RGB input)	14
The remote control does not work.		Ensure that the batteries in the remote control are inserted with the correct polarity. Check to see that the batteries in the remote control are functional.	5

Troubleshooting continued

Symptoms(continued)

Symptom	Point to check
The temperature of the display panel surface is warm.	The LCD display panel works by lighting phosphors. In some cases, this may cause the temperature of the panel surface to increase. Please note that this is not a malfunction.
Points that do not light, points with brightness different from that of the periphery, points with color different from that of the periphery, etc.	High-precision technology is used to manufacture the LCD display panel, However over the life of the LCD panel, a few pixel elements may fail. This is not to be considered a defect in the panel.
Coarse horizontal stripes appear in FULL display.	Adjusting the Clock Phase will reduce the horizontal stripes. (RGB input)
The screen flickers in the form of horizontal lines oscillating up and down. (PC INPUT MODE only)	If the frequency from the computer is below 85Hz, try a higher frequency (to a maximum limit of 85Hz). There may be a slight attenuation of the current image.
The top surface of the monitor heats up.	When used for long periods of time, the top surface of the monitor may heat up. This is not a malfunction.
Text characters are displayed with varying thickness.	The thickness of characters and lines may vary when images with a vertical resolution greater than 720 lines are displayed; however this is not a malfunction.
The display does not seem bright enough.	The ambient temperature of the monitor may be low. Ambient temperatures less than about 15° degrees, may cause lower luminance. The panel protection circuit automatically lowers the luminance, and is not a malfunction. The luminance will be restored when power is turned on for a while.
The display does not seem bright enough. (RGB input)	The setup-frequency setting in RGB input may be set to PC mode. When set to PC mode, the luminance is lowered by about 10% than when set as Movie mode. This is not a malfunction. If you do not mind flicker on the display, please switch to Movie mode.

Troubleshooting continued



Symptoms(continued)

Make the checks suggested below depending on the symptoms observed. If the symptoms remain unresolved, contact your dealer.

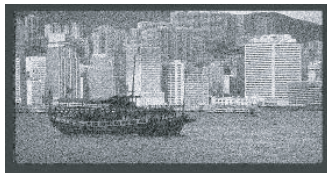
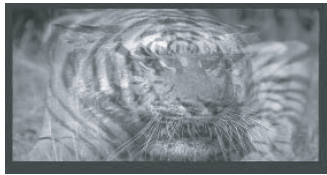
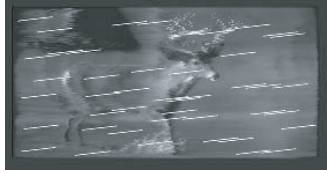

WARNING

DO NOT OPEN THE MONITOR.
Self servicing can be hazardous. There are no user serviceable parts inside and opening or removing covers may expose you to dangerous shock hazards or other risks.
Refer all servicing to qualified personnel.

Symptom	Possible reason	Remedy
 snowy picture - poor sound	<ol style="list-style-type: none"> (1) Connection of antenna/cable lead in wire to the TV is poor. (2) Corroded or poor antenna/cable connections. (3) Antenna has moved position. (4) Adverse weather conditions. (5) Transmitter problems. 	<ol style="list-style-type: none"> (1) Make new connection and/or change antenna plug. (2) Make new connections or use new cable. (3) Re-align the antenna. (4) None. (5) Check with the local Operator.
 multiple images - sound O.K	<ol style="list-style-type: none"> (1) Antenna has moved position. (2) Adverse weather conditions. (3) Transmitter problems. (4) AV Input is not set correctly. (5) Corroded or poor antenna / cable connections. 	<ol style="list-style-type: none"> (1) Re-align the antenna. (2) None. (3) Check with the local Operator. (4) Check the external equipment connected. (5) Make new connections or use new cable.
 intermittent interference	<ol style="list-style-type: none"> (1) Interference from electrical or mechanical motors, fluorescent lights, portable radios etc. (2) Corroded or poor antenna/cable connections. 	<ol style="list-style-type: none"> (1) Check devices for shielding and renew if necessary or move further from TV. (2) Make new connections or use new cable.
 no picture or sound	<ol style="list-style-type: none"> (1) TV may be in AV mode. (2) Picture/sound setting is set to minimum. (3) TV is in standby or power save mode. (4) Corroded or poor antenna / cable connections. 	<ol style="list-style-type: none"> (1) Press the PROGRAM button or the ⑩ to ⑨ buttons on your remote control to return to normal TV mode. (2) Check picture / sound controls (go to MAIN MENU). (3) Press POWER ON / OFF button. (4) Make new connections or use new cable. <div style="border: 1px solid black; padding: 5px; width: fit-content; margin: 10px auto;"> <p style="text-align: center;">TV CHANNEL:10 MONO</p> </div>

References

NEC-Mitsubishi Monitor Customer Service & Support

Customer Service and Technical Support: (800) 632-4662
Fax: (800) 695-3044

Parts and Accessories/Macintosh

Cable Adapter: (888) NEC-MITS [888-632-6487]

Warranty Information: www.necmitsubishi.com/warranty

Online Technical Support

www.necmitsubishi.com/support

Sales and Product Information

Sales Information Line: (888) NEC-MITS [888-632-6487]

Canadian Customers: (866) 771-0266, Ext#: 4037

Government Sales: (800) 284-6320

Government Sales email: gov@necmitsubishi.com

Electronic Channels

World Wide Web: www.necmitsubishi.com

Product Registration: www.necmitsubishi.com/productregistration

European Operations: www.nec-mitsubishi.com

Drivers and Downloads

www.necmitsubishi.com/downloads

Specifications

LCD Module	Diagonal :	23.0 inch	Active matrix; thin film transistor (TFT)
	Viewable Image Size :	23.0 inch	liquid crystal display (LCD); 0.390 mm dot pitch; 500cd/m ² white luminance;
	Native Resolution (Pixel Count) :	1280 x 768	500:1 contrast ratio, typical
Input Signal	PC INPUT	ANALOG 0.7 V _{p-p} /75 Ohms Separate sync. TTL Level Horizontal sync. Positive/Negative Vertical sync. Positive/Negative	Digital Input: DVI
	VIDEO INPUT	Composite 1.0V p-p Input Impedance 75 Ohm Y/C Y:0.7V p-p C:0.283V p-p Input Impedance 75 Ohm S-TERMINAL-INPUT 2 component 1.0/0.7V p-p Input Impedance 75 Ohm	RCA-INPUT
	AUDIO INPUT	RCA PIN-JACK L/R 3 INPUT, STEREO Mini Jack 1INPUT 500mV rms Input Impedance 22 Kohm	
	AUDIO OUTPUT	RCA PIN-JACK L/R 1OUTPUT 500mV rms RCA PIN-JACK Subwoofer 1 OUTPUT 300mV rms	
Display Colors		Over 16,000,000	Dependent on display card used.
Maximum Viewing Angles	Left/Right :	85°/85° (CR>10)	
	Up/Down :	85°/85° (CR>10)	
Synchronization Range	Horizontal :	31.5 kHz to 60.0 kHz	Automatically
	Vertical :	56.0 Hz to 75.0 Hz	Automatically
Resolutions Supported		720 x 400* ¹ :VGA text 640 x 480* ¹ @ 60 Hz to 75 Hz 800 x 600* ¹ @ 56 Hz to 75 Hz 1024 x 768* ¹ @ 60 Hz to 75 Hz 1280 x 768 @ 60 Hz to 75 Hz..... 1152 x 864* ¹ @ 60 Hz to 70 Hz 1280 x 960* ¹ @ 60 Hz to 70 Hz 1280 x 1024* ¹ @ 60 Hz to 70 Hz	Some systems may not support all modes listed. NEC-Mitsubishi Electronics Display cites recommended resolution at 60 Hz for optimal display performance.
		NTSC HDTV: 480i (60 Hz), 480p (60 Hz), 576i (50 Hz), 720p (50/60 Hz), 1080i (50/60 Hz)	
Active Display Area	Horizontal :	19.7 inch	
	Vertical :	11.8 inch	
Power Supply		100 – 240 V ~ 50/60 Hz	
Current Rating		19V DC 6.3A	
Dimensions		580.0 mm (W) x 467.5 mm (H) x 210.0 mm (D) 22.8 inches (W) x 18.4 inches (H) x 8.3 inches (D)	
Weight		10.0 kg 22.0 lbs	
Environmental Considerations			
	Operating Temperature :	5°C to 35°C/41°F to 95°F	
	Humidity :	30% to 80%	
	Feet :	0 to 12,001 Feet	
	Storage Temperature :	-10°C to 60°C/14°F to 140°F	
	Humidity :	10% to 85%	
	Feet :	0 to 40,000 Feet	

*¹ Interpolated Resolutions: When resolutions are shown that are lower than the pixel count of the LCD module, text may appear different. This is normal and necessary for all current flat panel technologies when displaying non-native resolutions full screen. In flat panel technologies, each dot on the screen is actually one pixel, so to expand resolutions to full screen, an interpolation of the resolution must be done.

NOTE: Technical specifications are subject to change without notice.

Limited Warranty

NEC-Mitsubishi Electronics Display of America, Inc. (hereinafter "NMD-A") warrants this Product to be free from defects in material and workmanship and, subject to the conditions set forth below, agrees to repair or replace (at NMD-A's sole option) any part of the enclosed unit which proves defective for a period of one (1) year from the date of first consumer purchase. Spare parts are warranted for ninety (90) days. Replacement parts or unit may be new or refurbished and will meet specifications of the original parts or unit.

This warranty gives you specific legal rights and you may also have other rights, which vary from state to state. This warranty is limited to the original purchaser of the Product and is not transferable. This warranty covers only NMD-A-supplied components. Service required as a result of third party components is not covered under this warranty. In order to be covered under this warranty, the Product must have been purchased in the U.S.A. or Canada by the original purchaser. This warranty only covers Product distribution in the U.S.A. or Canada by NMD-A. No warranty service is provided outside of the U.S.A. or Canada. Proof of Purchase will be required by NMD-A to substantiate date of purchase. Such proof of purchase must be an original bill of sale or receipt containing name and address of seller, purchaser, and the serial model number of the product.

It shall be your obligation and expense to have the Product shipped, freight prepaid, or delivered to the authorized reseller from whom it was purchased or other facility authorized by NMD-A to render the services provided hereunder in the original package. All Products returned to NMD-A for service MUST have prior approval, which may be obtained by calling 1-800-632-4662. The Product shall not have been previously altered, repaired, or serviced by anyone other than a service facility authorized by NMD-A to render such service, the serial number of the product shall not have been altered or removed. In order to be covered by this warranty the Product shall not have been subjected to displaying of fixed images for long periods of time resulting in image persistence (afterimage effects), accident, misuse or abuse or operated contrary to the instructions contained in the User's Manual. Any such conditions will void this warranty.

NMD-A SHALL NOT BE LIABLE FOR DIRECT, INDIRECT, INCIDENTAL, CONSEQUENTIAL, OR OTHER TYPES OF DAMAGES RESULTING FROM THE USE OF ANY NMD-A PRODUCT OTHER THAN THE LIABILITY STATED ABOVE. THESE WARRANTIES ARE IN LIEU OF ALL OTHER WARRANTIES EXPRESS OR IMPLIED, INCLUDING, BUT NOT LIMITED TO, THE IMPLIED WARRANTIES OF MERCHANTABILITY OR FITNESS FOR A PARTICULAR PURPOSE. SOME STATES DO NOT ALLOW THE EXCLUSION OF IMPLIED WARRANTIES OR THE LIMITATION OR EXCLUSION OF LIABILITY FOR INCIDENTAL OR CONSEQUENTIAL DAMAGES SO THE ABOVE EXCLUSIONS OR LIMITATIONS MAY NOT APPLY TO YOU.

This Product is warranted in accordance with the terms of this limited warranty. Consumers are cautioned that Product performance is affected by system configuration, software, the application, customer data, and operator control of the system, among other factors. While NMD-A Products are considered to be compatible with many systems, specific functional implementation by the customers of the Product may vary. Therefore, suitability of a Product for a specific purpose or application must be determined by consumer and is not warranted by NMD-A.

For the name of your nearest authorized NEC-Mitsubishi Electronics Display service facility, contact NEC-Mitsubishi Electronics Display of America at 1-800-632-4662.

TCO'99

Congratulations! You have just purchased a TCO'99 approved and labelled product! Your choice has provided you with a product developed for professional use. Your purchase has also contributed to reducing the burden on the environment and also to the further development of environmentally adapted electronics products.



Why do we have environmentally labelled computers?

In many countries, environmental labelling has become an established method for encouraging the adaptation of goods and services to the environment. The main problem, as far as computers and other electronics equipment are concerned, is that environmentally harmful substances are used both in the products and during the manufacturing. Since it has not been possible for the majority of electronics equipment to be recycled in a satisfactory way, most of these potentially damaging substances sooner or later enter Nature.

There are also other characteristics of a computer, such as energy consumption levels, that are important from the viewpoints of both the work (Internal) and natural (external) environments. Since all methods of conventional electricity generation have a negative effect on the environment (acidic and climate-influencing emissions, radioactive waste, etc.), it is vital to conserve energy. Electronics equipment in offices consume an enormous amount of energy since they are often left running continuously.

What does labelling involve?

This product meets the requirements for the TCO'99 scheme which provides for international and environmental labelling of personal computers. The labelling scheme was developed as a joint effort by the TCO (The Swedish Confederation of Professional Employees), Svenska Naturskyddsforeningen (The Swedish Society for Nature Conservation) and Statens Energimyndighet (The Swedish National Energy Administration).

The requirements cover a wide range of issues: environment, ergonomics, usability, emission of electrical and magnetic fields, energy consumption and electrical and fire safety.

The environmental demands concern restrictions on the presence and use of heavy metals, brominated and chlorinated flame retardants, CFCs (freons) and chlorinated solvents, among other things. The product must be prepared for recycling and the manufacturer is obliged to have an environmental plan which must be adhered to in each country where the company implements its operational policy. The energy requirements include a demand that the computer and/or display, after a certain period of inactivity, shall reduce its power consumption to a lower level in one or more stages. The length of time to reactivate the computer shall be reasonable for the user.

Labelled products must meet strict environmental demands, for example, in respect of the reduction of electric and magnetic fields, physical and visual ergonomics and good usability.

Environmental Requirements

Flame retardants

Flame retardants are present in printed circuit boards, cables, wires, casings and housings. In turn, they delay the spread of fire. Up to thirty percent of the plastic in a computer casing can consist of flame retardant substances. Most flame retardants contain bromine or chloride and these are related to another group of environmental toxins, PCBs, which are suspected to give rise to severe health effects, including reproductive damage in fish-eating birds and mammals, due to the bio-

TCO'99 –continued

accumulative* processes. Flame retardants have been found in human blood and researchers fear that disturbances in foetus development may occur.

TCO'99 demand requires that plastic components weighing more than 25 grams must not contain flame retardants with organically bound chlorine and bromine. Flame retardants are allowed in the printed circuit boards since no substitutes are available.

Lead**

Lead can be found in picture tubes, display screens, solders and capacitors. Lead damages the nervous system and in higher doses, causes lead poisoning.

TCO'99 requirement permits the inclusion of lead since no replacement has yet been developed.

Cadmium**

Cadmium is present in rechargeable batteries and in the colourgenerating layers of certain computer displays. Cadmium damages the nervous system and is toxic in high doses.

TCO'99 requirement states that batteries, the colourgenerating layers of display screens and the electrical or electronics components must not contain any cadmium.

Mercury**

Mercury is sometimes found in batteries, relays and switches, Mercury damages the nervous system and is toxic in high doses.

TCO'99 requirement states that batteries may not contain any Mercury. It also demands that no mercury is present in any of the electrical or electronics components associated with the display unit.

CFCs (freons)

CFCs (freons) are sometimes used for washing printed circuit boards. CFCs break down ozone and thereby damage the ozone layer in the stratosphere, causing increased reception on Earth of ultraviolet light with consequent increased risks of skin cancer (malignant melanoma).

The relevant TCO'99 requirement; Neither CFCs nor HCFCs may be used during the manufacturing and assembly of the product or its packaging.

*Bio-accumulative is defined as substances which accumulate within living organisms.

**Lead, Cadmium and Mercury are heavy metals which are Bio-accumulative.

To obtain complete information on the environmental criteria document, order from:

TCO Development Unit
SE-114 94 Stockholm
SWEDEN
FAX Number: +46 8 782 92 07
E-mail (Internet): development@tco.se

You may also obtain current information on TCO'99 approved and labelled products by visiting their website at: <http://www.tcodevelopment.com/>

Declaration of the Manufacturer

We hereby certify that the color monitors LCD2335WXM is in compliance with Council Directive 73/23/EEC:
– EN 60950-1

Council Directive 89/336/EEC:
– EN 55022
– EN 61000-3-2
– EN 61000-3-3
– EN 55024

and marked with



NEC-Mitsubishi Electric Visual
Systems Corporation
4-13-23, Shibaura,
Minato-Ku
Tokyo 108-0023, Japan

NEC LCD2335WXM

PROPRIETARY NOTICE AND LIABILITY DISCLAIMER

The information disclosed in this document, including all designs and related materials, is the valuable property of NEC-Mitsubishi Electronics Display of America and/or its licensors, as appropriate, reserve all patent, copyright and other proprietary rights to this document, including all design, manufacturing, reproduction, use and sales rights thereto, except to the extent said rights are expressly granted to others.

The NEC-Mitsubishi Electronics Display of America product(s) discussed in this document are warranted in accordance with the terms of the Limited Warranty Statement accompanying each product. However, actual performance of each such product is dependent upon factors such as system configuration, customer data and operator control. Since implementation by customers of each product may vary, the suitability of specific product configurations and applications must be determined by the customer and is not warranted by NEC-Mitsubishi Electronics Display of America.

To allow for design and specification improvements, the information in this document is subject to change at any time without notice. Reproduction of this document or portions thereof without prior approval of NEC-Mitsubishi Electronics Display of America is prohibited.

DECLARATION OF CONFORMITY

This device complies with Part 15 of FCC Rules. Operation is subject to the following two conditions. (1) This device may not cause harmful interference, and (2) this device must accept any interference received, including interference that may cause undesired operation.

U.S. Responsible Party:	NEC-Mitsubishi Electronics Display of America, Inc.
Address:	1250 North Arlington Heights Road, Suite 500 Itasca, Illinois 60143-1248
Tel. No.:	(630) 467-3000

Type of Product:	Display Monitor
Equipment Classification:	Class B Peripheral
Model:	MultiSync®LCD2335WXM™ (L234GC)



We hereby declare that the equipment specified above conforms to the technical standards as specified in the FCC Rules.

Windows is a registered trademark of Microsoft Corporation. NEC is a registered trademark of NEC Corporation. All other brands and product names are trademarks or registered trademarks of their respective owners.

As an ENERGY STAR® Partner, NEC-Mitsubishi Electronics Display of America has determined that this product meets the ENERGY STAR guidelines for energy efficiency. The ENERGY STAR emblem does not represent EPA endorsement of any product or service.

NEC