



# User Manual

## Set MidRanger + Antenna (9217967)

The MidRanger + Antenna set is the ideal RFID item scanner for your library staff. The shielded antenna is developed to only read items that are put on top of the antenna, resulting that no mistakes will be made in reading the wrong items. The design of the product is perfected and aimed to fit in any environment.

*Version: 2.8*

*published on Monday, January 02, 2017*

# Technical support

## Email address

support-library@nedap.com

## Visitors address

Nedap Library Solutions  
Parallelweg 2d  
Groenlo  
The Netherlands

## Postal address

Nedap Library Solutions  
P.O. box 102  
7140 AC Groenlo  
The Netherlands

## Telephone Number

Tel: +31(0)85 88 88 850

©2016 Nedap Library Solutions

The software / hardware described in this document / file is furnished under a license agreement and may be used only in accordance with the terms of agreement.

## Documentation copyright notice

Any technical documentation that is made available by Nedap Library Solutions is the copyrighted work of Nedap Library Solutions and is owned by Nedap Library Solutions.

## Disclaimer

NO WARRANTY. The technical documentation is being delivered to you and Nedap Library Solutions makes no warranty as to its accuracy or use. Any use of the technical documentation or the information contained herein is at the risk of the user. Documentation may include technical or other inaccuracies or typographical errors. Nedap Library Solutions has the right to make changes without prior notice. No part of this publication may be copied without the express written permission of Nedap Library Solutions, Parallelweg 2d, 7141 DC Groenlo, The Netherlands.

## Trademarks

Nedap, and the Nedap logo are registered trademarks of Nedap N.V. Groenlo. Other product names mentioned in this manual may be trademarks or registered trademarks of their respective companies and are hereby acknowledged. Printed in the Netherlands.

# Table of Contents

|  |    |
|--|----|
| Technical support .....                        | 2  |
| Table of Contents.....                         | 3  |
| Safety Precaution.....                         | 4  |
| IC FCC / IC STATEMENT.....                     | 5  |
| Compliance statements (part15.19) .....        | 5  |
| Warning (part15.21) .....                      | 5  |
| Information to the User (Part 15.106(b)) ..... | 5  |
| Dimensions .....                               | 6  |
| Content of Box.....                            | 7  |
| Installation Guide .....                       | 8  |
| Antenna .....                                  | 8  |
| Reader .....                                   | 10 |
| First setup .....                              | 11 |
| IP Networking.....                             | 12 |
| RFID modes .....                               | 13 |
| EAS.....                                       | 14 |
| ISO 15693 / I-Code .....                       | 15 |
| Monitor .....                                  | 16 |
| Operation of product.....                      | 17 |
| Setup.....                                     | 17 |
| Switching on/off .....                         | 17 |
| Use of antenna .....                           | 17 |
| Maintenance .....                              | 18 |
| Software .....                                 | 18 |
| Cleaning instruction .....                     | 18 |
| Frequently Asked Questions.....                | 19 |
| Discarding.....                                | 20 |
| Technical Specifications.....                  | 21 |
| EU Declaration of Conformity .....             | 23 |

# Safety Precaution

- Installation of these products must be performed by a qualified installation partner.
- Do not use the product in damp places.
- If you smell smoke or other odors or hear a strange sound, unplug the power cord and contact your dealer.
- Protect the power cord, USB cable, Ethernet cable and antenna cable from physical or mechanical abuse, such as being twisted, kinked, pinched, closed in a door, or walked upon. Pay particular attention to plugs, wall outlets, and the point where the cable connects to the product.
- Do not disassemble, repair or modify the product at your own discretion.
- To reduce the risk of electrical shock or damage, do not expose this device to rain or moisture.
- Refer all servicing to qualified service personnel. Servicing is required when the system has been damaged in any way, such as power supply cord or plug is damaged, liquid has been spilled, or the device has been dropped.



**WARNING:** Do not place near electromagnetic fields.



  
Made in the Netherlands  
NL\_Parallelweg 2, 7141DC Groenlo, Netherlands



**9564675**  
RFID Reader MidRanger MR-100-UE  
MAC:  
Model: MidRanger  
FCC ID: CGDMIDRANGER  
IC: 1444A-MIDRANGER  
CAN ICES-3(B)/NMB-3(B)

    
S/N: HN15001 

This device complies with part 15 of the FCC Rules and to RSS210 Industry Canada. Operation is subject to the following two conditions:  
(1) this device may not cause interference, and  
(2) this device must accept any interference, including interference that may cause undesired operation of the device.

  
Made in the Netherlands  
NL\_Parallelweg 2, 7141DC Groenlo, Netherlands

**9564918**  
Antenna MidRange 50Ohm  
S/N: HN15001

# IC FCC / IC STATEMENT

*FCC ID: CGDMIDRANGER  
IC: 1444A-MIDRANGER*

## Compliance statements (part15.19)

This device complies with part 15 of the FCC Rules and to RSS210 of Industry Canada. Operation is subject to the following two conditions:

- (1) this device may not cause harmful interference, and
- (2) this device must accept any interference received, including interference that may cause undesired operation.

Cet appareil se conforme aux normes CNR210 exemptés de licence du Industriel Canada. L'opération est soumise aux deux conditions suivantes:

- (1) cet appareil ne doit causer aucune interférence, et
- (2) cet appareil doit accepter n'importe quelle interférence, y inclus interférence qui peut causer une opération non pas voulu de cet appareil.

## Warning (part15.21)

Changes or modifications not expressly approved by party responsible for compliance could void the user's authority to operate the equipment.

## Information to the User (Part 15.106(b))

Note: This equipment has been tested and found to comply with the limits for a class B digital devices, pursuant to part 15 of the FCC Rules. These limits are designed to provide reasonable protection against harmful interference in a residential installation. This equipment generates, uses and can radiate radio frequent energy and, if not installed and used in accordance with the instructions, may cause harmful interference to radio communications. However, there is no guarantee that interference will not occur in a particular installation. If this equipment does not cause harmful interference to radio or television reception, which can be determine by turning the equipment off and on, the user is encouraged to try to correct the interference by one or more of the following measures:

- Reorient or relocate the receiving antenna.
- Increase the separation between the equipment and receiver.
- Connect the equipment into an outlet on a circuit different from that to which the receiver is connected.
- Consult the dealer or an experienced radio/TV technician for help.

This radio transmitter 1444A-MIDRANGER has been approved by Industry Canada to operate with the antenna type Model 9564918 (see page 7 of this Manual) with the maximum permissible gain indicated. Antenna types other than 9564918 having a gain greater than the maximum gain indicated for that type, are strictly prohibited for use with this device.

# Dimensions

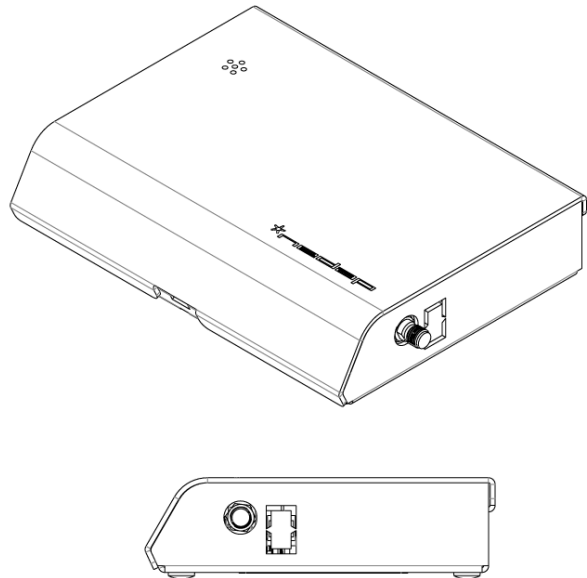
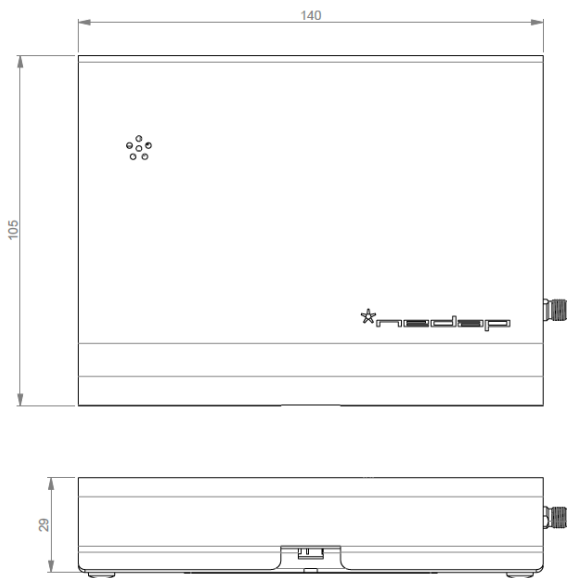
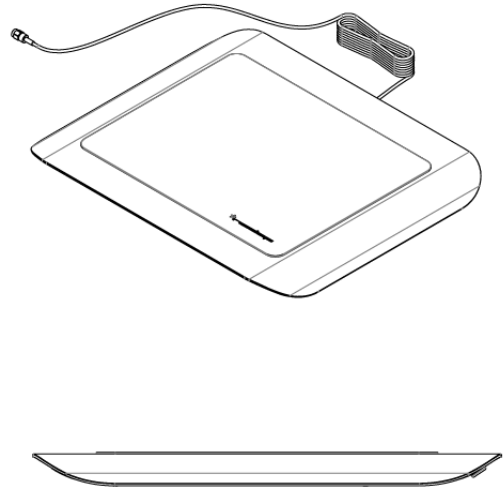
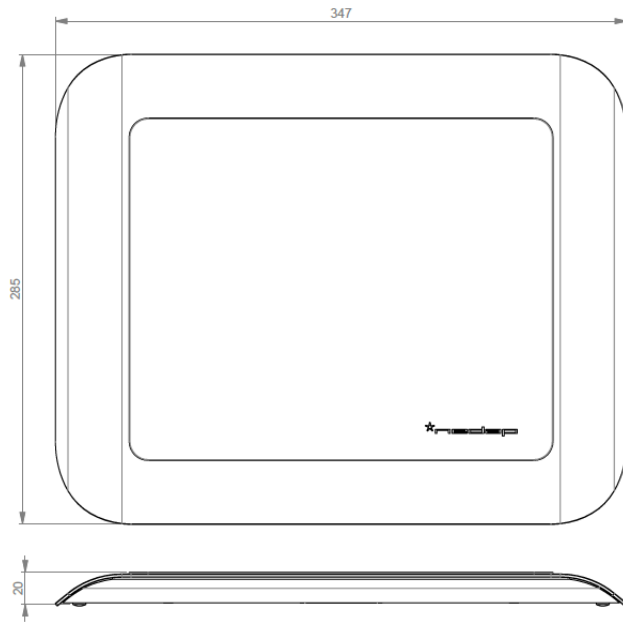

# Content of Box

When you receive the box, it is strongly advised to check the contents of the box before installation. The box should contain the following components:

- Antenna 9564918
- Reader 9564675
- Net adapter 9651802
- Documentation
  - This manual
  - RF.Test Lite manual

The **antenna** has a 2 meter RG174 cable with a SMA connector.

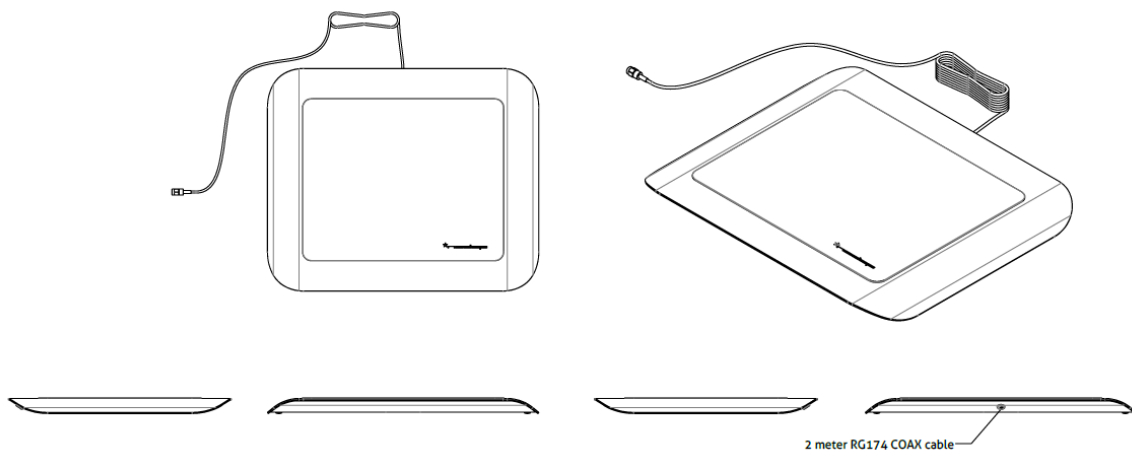

The **reader** has a power connector, an USB port, an Ethernet port, and a SMA connector for the antenna.

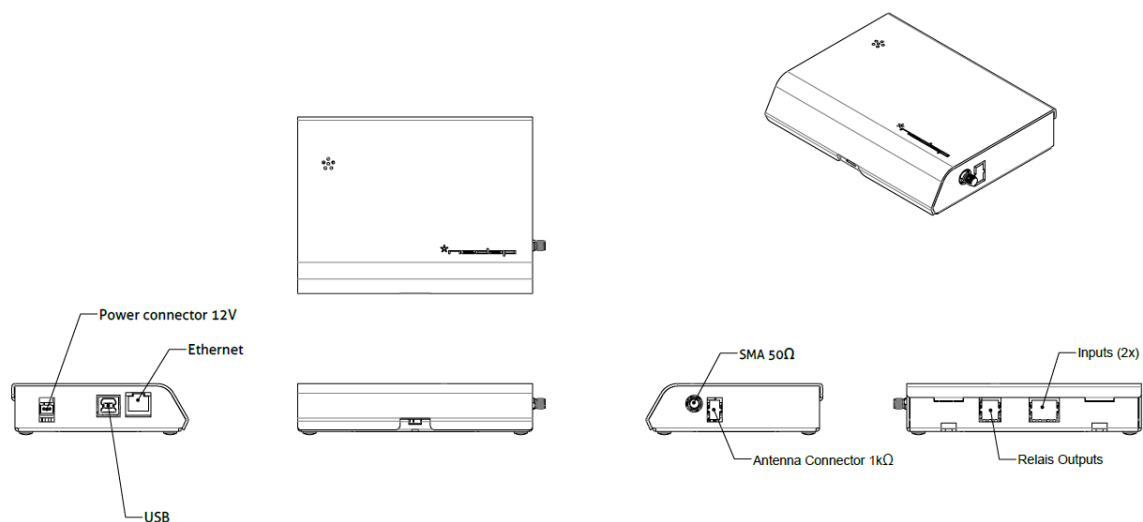

# Installation Guide

## Antenna

Because the antenna is shielded, it can be used in a lot of different environments. It can be placed on any desk type, but when it is mounted below a table, the table should be made of a material that doesn't influence 13.56MHz RFID fields. So wooden tables or plastic tables will work, but metal tables will disrupt the antenna and make it not work.

The field in which the antenna will read a tag can be found in the image below. Make sure that when a book is placed on the reader, the actual tag is within the area shown below.

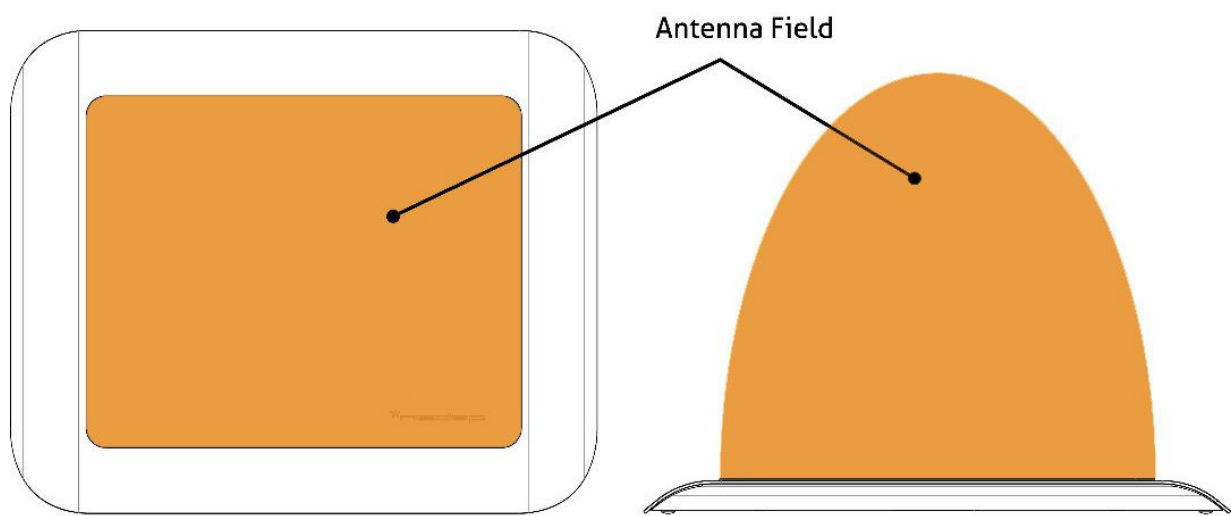

*Note: The antenna might disrupt the functionality of mice, keyboard or other input devices when these devices are put in the antenna field.*

### On table

Make sure that there will not be any metals present in the antenna field when using it on top of a table. Also make sure that the cable of the antenna is not kinked or stressed in any way possible.



## Below table

When looking for a good spot to mount the antenna, make sure the table doesn't have any metals near the antenna (field). When a good spot is found, you will need 4 fastening screws (corresponding to your table material), and a drill to prepare the table.

Tape the template (which you can cut out from the next page) on the surface where you want to place the antenna. Make sure to take into account the minimum distances from the sides of the template. These go both ways.

Open up the MidRange Antenna, by carefully removing the screws on the bottom of the product. Put the hood in the desired position, and drill four holes through the hood into the table while holding the hood in place. Make sure to use a smaller drill than the diameter of the screw, so that the screw will tap itself further into the table.

*TIP: Use DuctTape, or a clamp to keep the hood in place, whilst drilling the holes and mounting the hood with the screws. (Remove when remounting the bottom)*

Re-attach the bottom of the antenna to the mounted hood. Be careful not to destroy the thread in the mounting points of the hood when doing so.

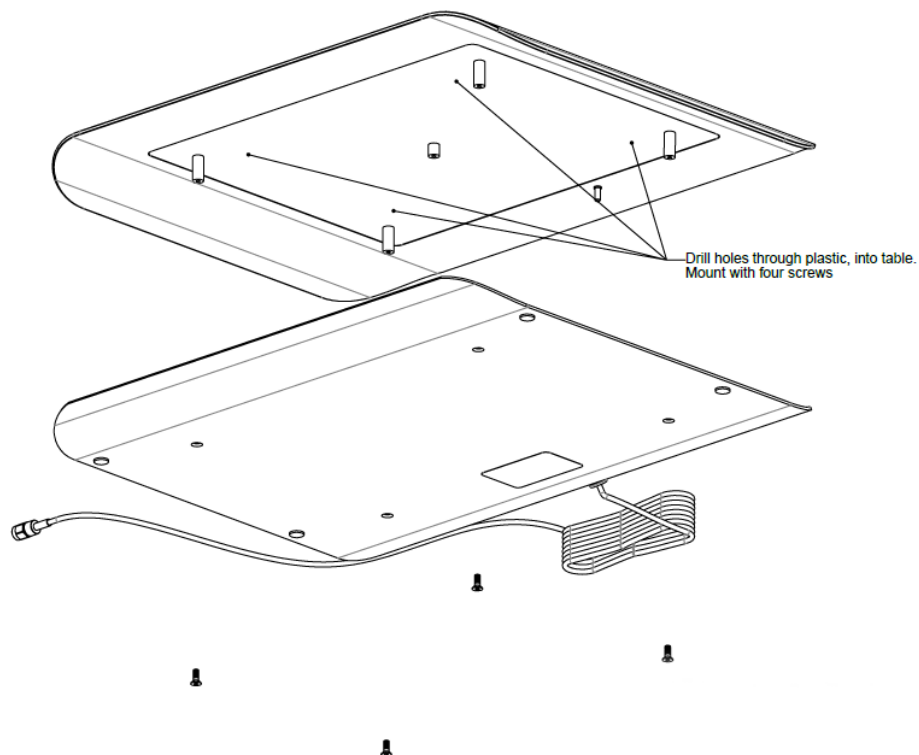

## Reader

The reader itself can also be placed on top of a table, or can be mounted under a table, or against a wall. The reader is mounted using three screws. Always make sure that none of the cables is under any stress when mounting the reader.

### On table

Get the rubber feet from the packaging, and place these under the reader casing to make sure it will not scratch the surface that it will be placed upon.

### Below table or on wall

The reader can also be mounted under a table, or against a wall. This can be done using 3 screws, supplied with the reader.

Pre-drill the three holes in the surface. The pattern for these holes can be found in the drawing T5760925-40.01.

Place the top two screws, and screw them in so that the head of the screw is only 1 or 2 mm out of the surface. Remove the hood of the MidRanger by levering a screwdriver carefully in the opening at the front of the reader. Slide the MidRanger onto the two screws, and place the third and final screw. Snap the hood back onto the reader.

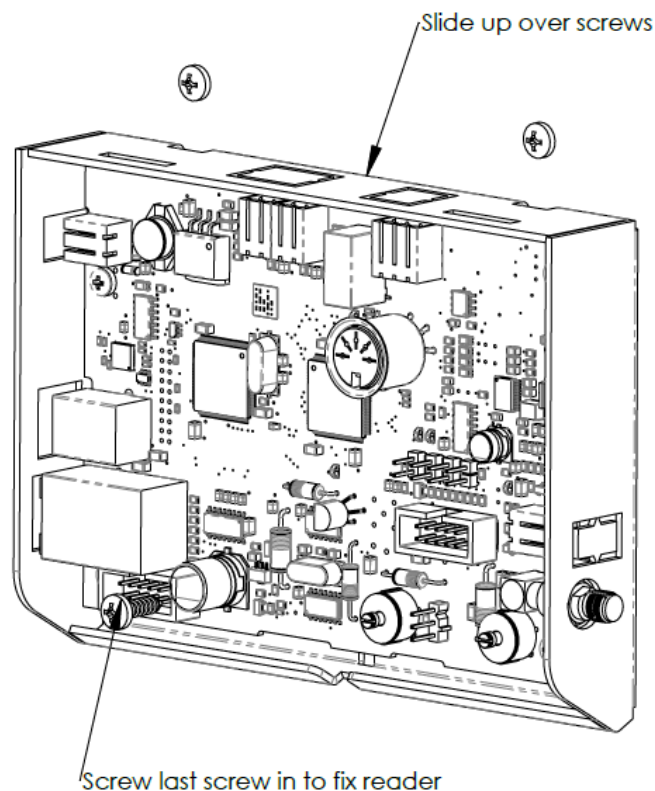

## First setup

Before connecting and switching the reader on, make sure to download the drivers and the RF.Test Lite tool on the computer which is going to be used to configure the reader. The drivers and RF.Test Lite can be found on the support site (<http://www.nedaplibrary.com/support>).

Although the reader can be connected to the network via Ethernet, the reader will always need to be set up the first time via USB. Connect the reader to the computer with the drivers, using the USB cable.

The product can now be configured with the RF.Test Lite tool. Find out which virtual COM-port is corresponding to the RFID reader, by checking its settings in the device manager (⌨ > Control Panel > Devices and Printers > Device Manager).

The reader will be called 'Silicon Labs CP210x USB to UART Bridge (COM#)' under 'Ports (COM & LPT)'. The number between the brackets is the number that you will need to configure the reader.

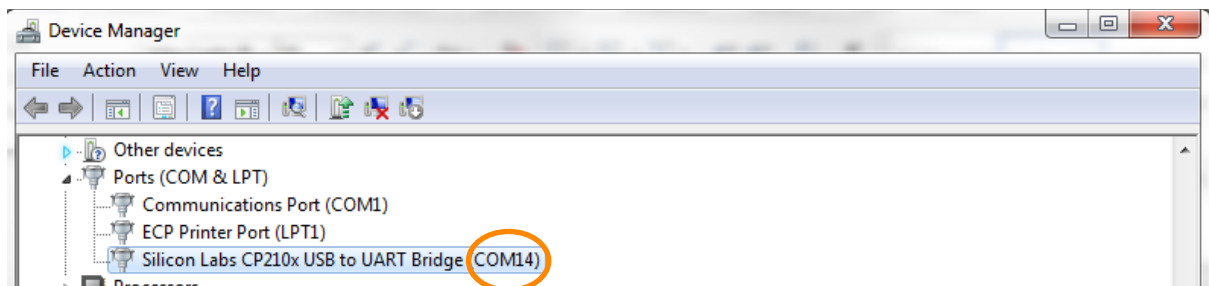

*Note: Whenever the reader is disconnected and reconnected, it could get a new COM-port number.*

Now you may start the RF.Test Lite tool, press the CFG button, and select the correct COM-port according to the number you've just found in the Device Manager.

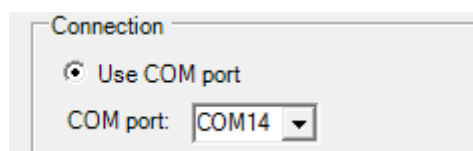
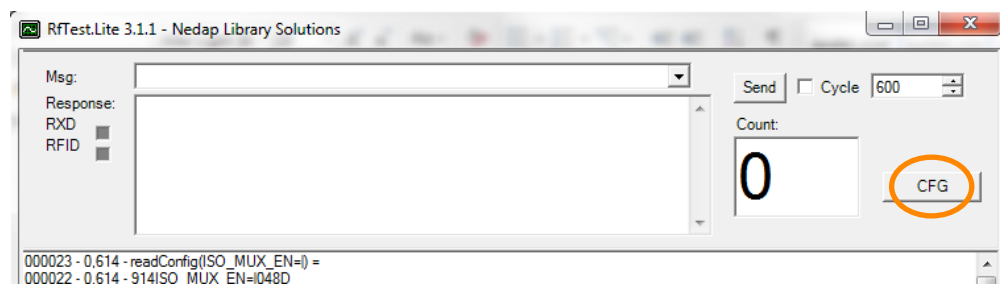

Now the Reader is connected via USB, and you may alter the settings under the 'TUNING' button.

## IP Networking

To change the IP-address of the reader, the reader needs to be connected with an RS232 or USB connection to the pc. When a different IP-address is configured the changes are effectively immediate, so when connected over the network, the connection will be lost immediately.

1. Press the 'Tuning' button in the bottom right corner of the 'Communication Setup' window.

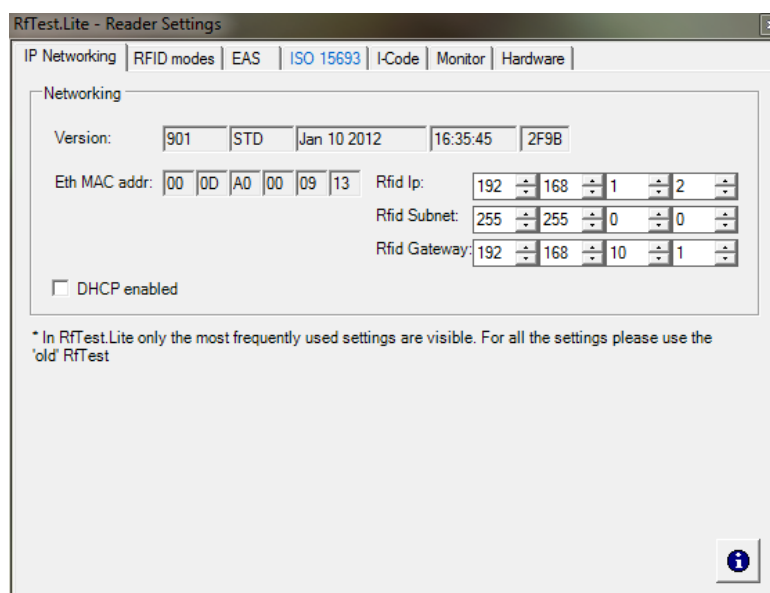
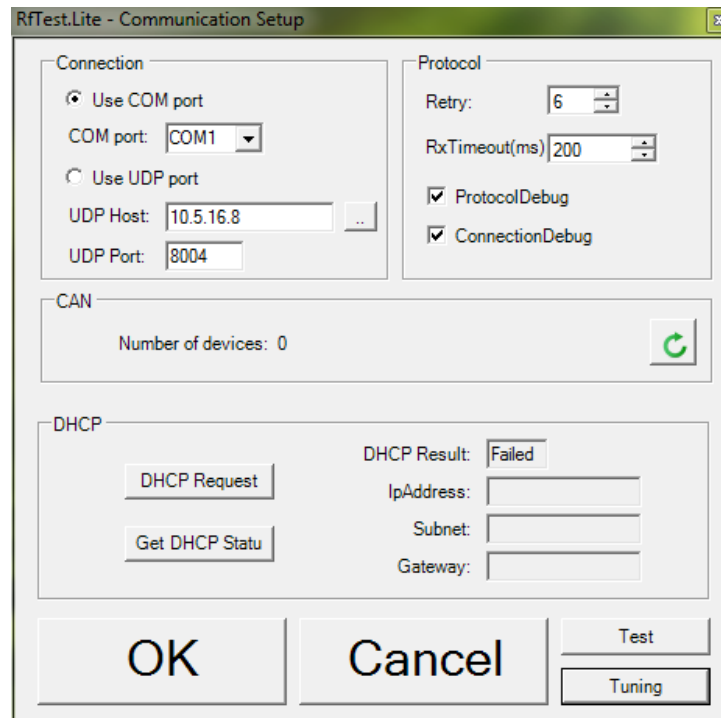

2. RfTest.Lite will now read all the settings from the reader. This will take a few seconds. When it has finished, the 'Reader Settings' window will appear.
3. The 'Reader Settings' window has different tabs which all configure different settings. See chapter 4 for a more detailed explanation of this window.
4. Select the 'IP Networking' tab.

5. Here you can find the following settings:
  - a. **RFID IP:** IP address of RFID reader
  - b. **RFID Subnet:** Subnet address of the RFID reader
  - c. **RFID Gateway:** Gateway of the reader
6. It is also possible to put the reader in DHCP mode, so it will get an IP-address from a local DHCP server in the network during power-up. In the 'Communication Setup' window the current IP-address of the reader can be retrieved by using the 'Get DHCP Status' button. With the 'DHCP Request' button a manual DHCP request can be performed.

*When changing a setting, the setting will be saved when another field is activated via the 'Tab' key or by clicking another field with the mouse.*

## RFID modes

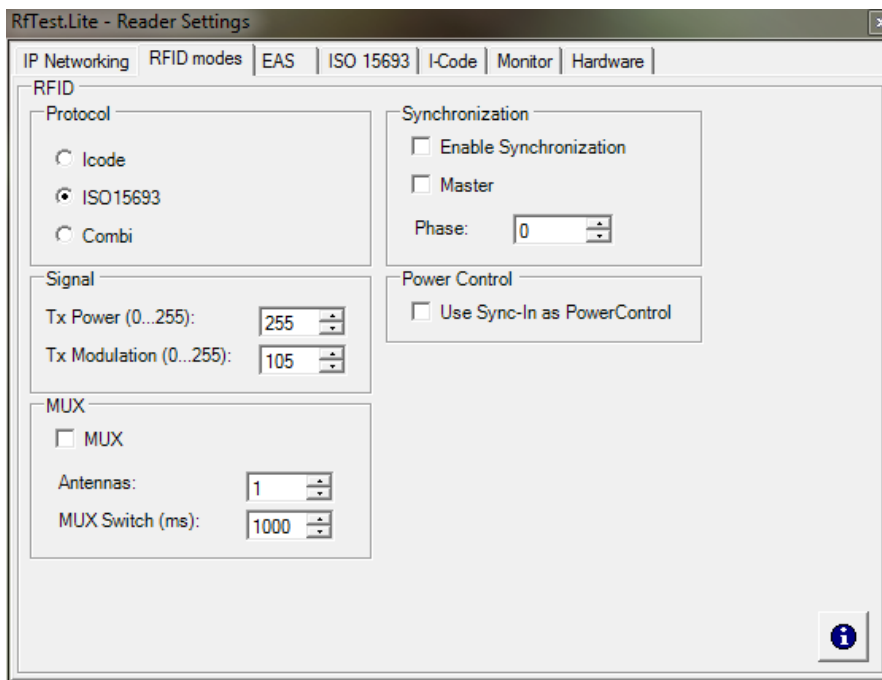

In this tab, the following settings can be changed:

- **RFID Protocol:** choose either the Icode or ISO15693 protocol, or set it to Combi for both.
- **Signal:** choose the Power and Modulation from 0 to 255, 0 being lowest and 255 being highest.
- **MUX:** when using a MUX, here you may select how much antennas you've connected and how high the MUX switching time should be in milliseconds.
- **Synchronization:** enable you to synchronize multiple readers.
- **Power control:** Use the sync-In to control the power of the reader.

# EAS

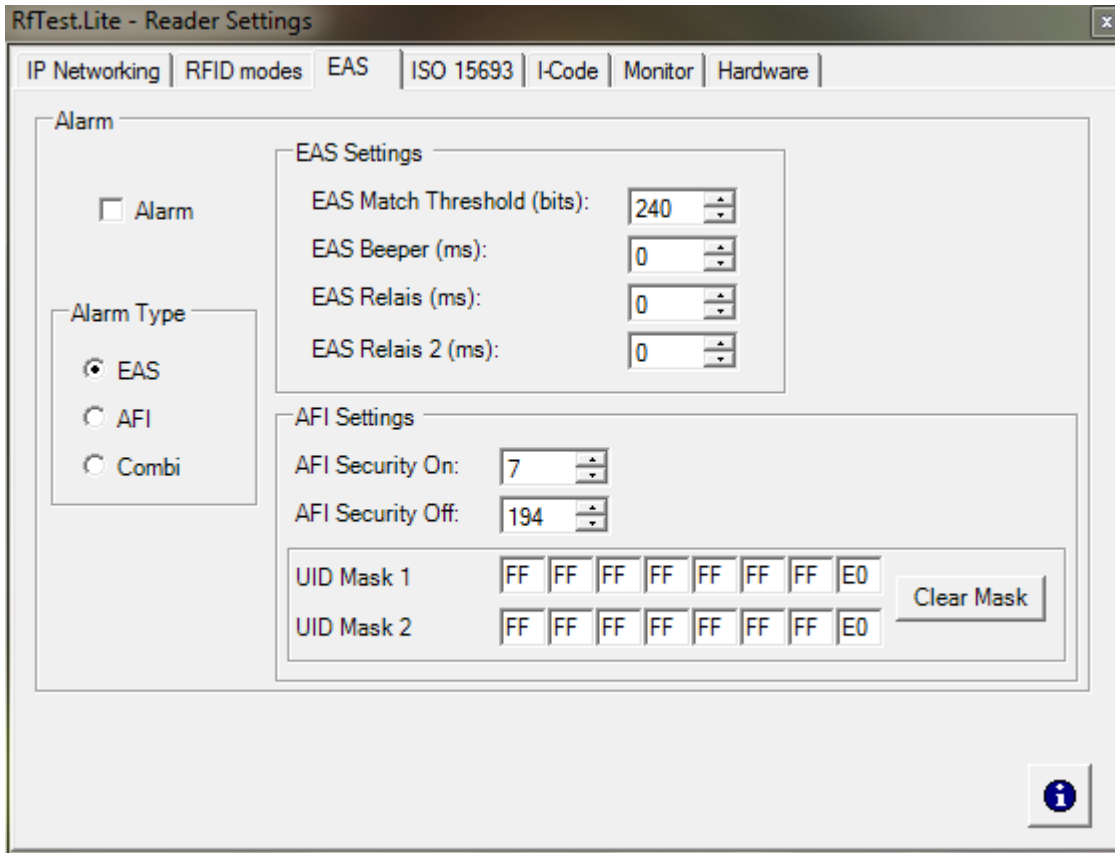

This tab shows the settings for an EAS or an AFI alarm.

- **Alarm:** Check to switch the relais/beeper upon the detection of a tag
- **Alarm Type:** Select the type of alarm (note: this type will also be programmed when enabling/disabling the alarm on a tag using the appropriate commands)
- **EAS Settings:** Edit the EAS beeper length and relais lengths
- **AFI Settings:** Edit the settings for the AFI alarm

# ISO 15693 / I-Code

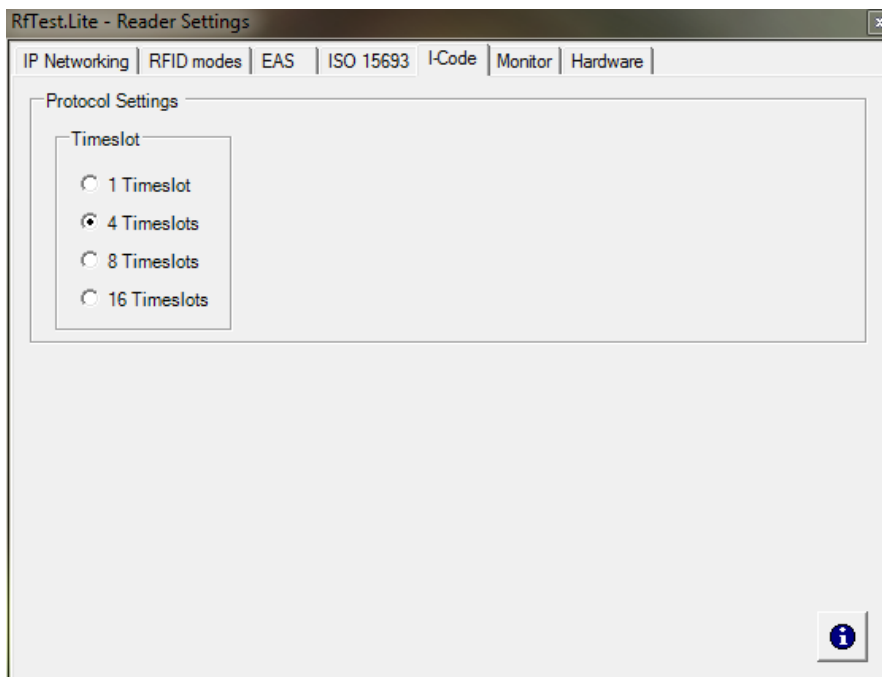
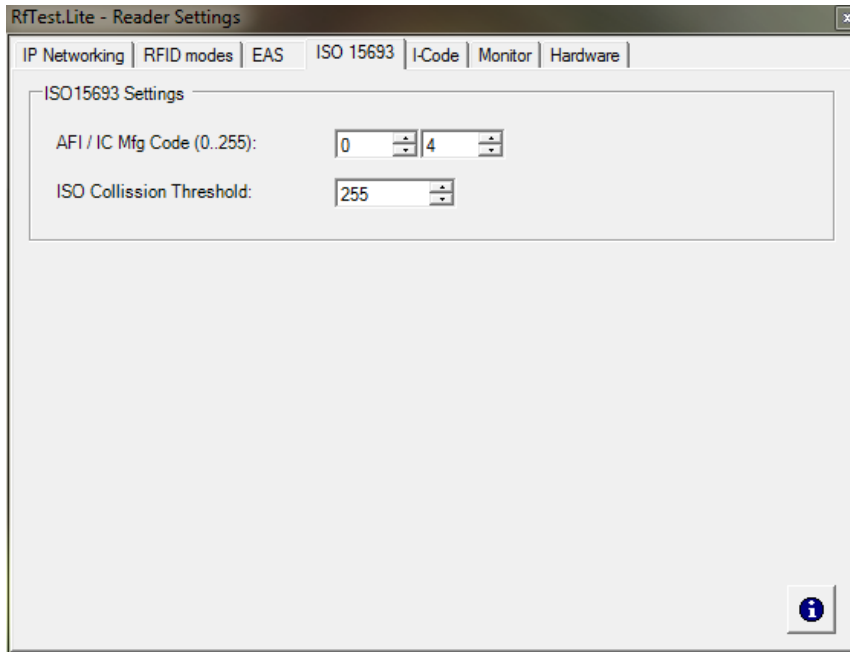

## Monitor

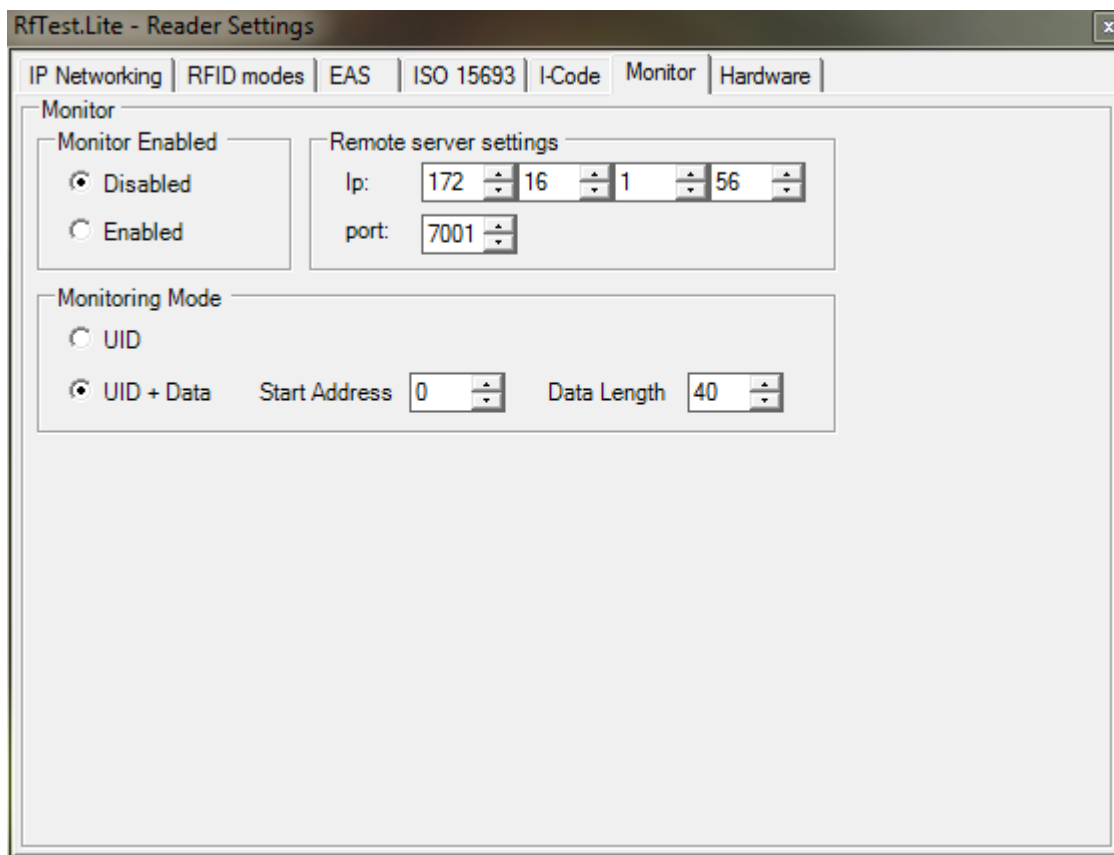

This tab enables the different Monitor settings to be changed.

- **Monitor Enabled:** when monitoring is enabled, the reader will send out UDP packets over the network with the data of a detected RFID label. It will only do this when EAS is enabled.
- **Ip:** Fill in the IP address of the pc where the UDP packets should be sent to
- **Port:** Give the port number for connecting to the IP address. Default port is 7001

### Notes

*See the BiblioCheck4 Monitor document to see how the packets can be received and handled.*

*EAS needs to be turned on for the monitor function to work*

*For ISO15693 tags this function will only work when in AFI mode. Then the UID and data of a tag is transmitted in a packet*

*When an optionally UHF module is connected, the EPC number of an UHF tag is transmitted in the data field of the udp packet. The UID (or ID) field of the packet contains the 64bit truncated version of this EPC number. See the BiblioCheck4 Monitor document.*

*All the settings of the configuration can be found in the RF.Test Lite manual (this manual can also be found on the Nedap library support site).*



# Operation of product

## Setup

Screw the SMA connector from the Antenna tightly on the Reader. Then connect the USB and/or the Ethernet cable to connect it to your laptop or network. The last connector is the power cable, which you use to switch the setup on or off.

## Switching on/off

To switch the reader on, connect the supplied 12V power adapter, and plug it in. To switch the reader off, disconnect the power adapter.

## Use of antenna

The antenna can be connected with the SMA-connector to the reader. The antenna is designed so that you can slide over one item at a time, or you can stack the items upon it.

*TIP: Make sure that the tag of an item is in the Antenna Field when you want to scan it.*

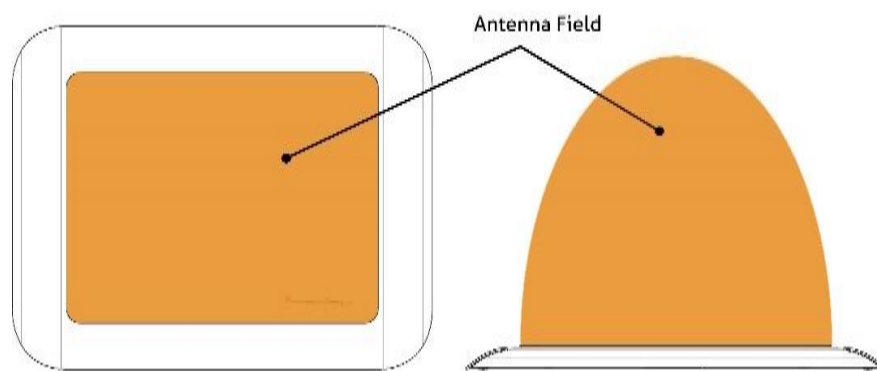

It might happen that your item is bigger than the reader. In that case, if the reader doesn't see the book, try to move the large item through the antenna field, making sure that all the edges of the book will be in the antenna field, until the reader recognizes the item.

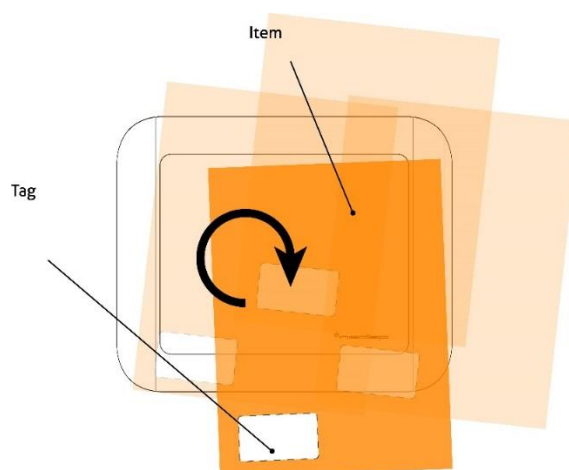

# Maintenance

## Software

It is always recommended to update the software versions to the latest version, which can be downloaded from the Nedap Library website: <http://www.nedaplibrary.com/support>.

This should at least be done once a year, during a maintenance check.

## Cleaning instruction

The Antenna and reader should be cleaned in three steps:

- 1) Clean with a damp cotton cloth
- 2) Clean with a dry microfiber cloth
- 3) Apply a Stainless Steel cleaner to the stainless steel parts.

*Do not use any solvents, abrasives, alcohol, spirit, thinners or other harsh cleaning liquids.*

# Frequently Asked Questions

## Question 1.: Why are there not yet any FAQ's?

Since the product is just released, we do not have any questions which are frequently asked. For any questions please contact the helpdesk at <http://www.nedaplibrary.com/support.html>.

## Discarding

The product should be discarded as electronic equipment, according to the Waste Electrical and Electronic Equipment Directive (WEEE).



# Technical Specifications

## Physical Specifications

|                         |  |                                |
|-------------------------|--|--------------------------------|
| <b>Article numbers:</b> | 9217967 Set MidRanger + Antenna<br>9564675 (MidRanger) and 9564918 (Antenna) |                                |
| <b>Dimensions (mm):</b> | MidRanger:   | Ca. 140 x 105 x 29 (L x w x h) |
|                         | Antenna:   | Ca. 348 x 285 x 20 (L x w x h) |
| <b>Material:</b>        | Stainless Steel, Zincd Steel (Powder coated) and HIPS                        |                                |
| <b>Weight:</b>          | Antenna ca. 4kg<br>Reader ca. 0,6kg  |                                |
| <b>Function:</b>        | Check-in / Check-out / staff-station   |                                |
| <b>Color:</b>           | Black (RAL 9005) and Brushed Stainless Steel                                 |                                |
| <b>Mounting:</b>        | Placed on desk, or mount underneath Table/Desk                               |                                |
| <b>Cable length:</b>    | 2m   |                                |

## RFID specifications

|                       |                                   |
|-----------------------|-----------------------------------|
| <b>Technology:</b>    | RFID                              |
| <b>Frequency:</b>     | 13.56MHz                          |
| <b>Maximal power:</b> | 1W                                |
| <b>Identifies:</b>    | ISO 15693 / ISO 18000-3.1         |
| <b>EAS-function:</b>  | Yes, based on EAS-bits and/or AFI |

## Connection / Communication specifications

|  |                    |
|--|--------------------|
| <b>Communication ports:</b>            | USB / UTP          |
| <b>Max length communication cable:</b> | USB: 5m / UTP: 90m |
| <b>IP address:</b>                     | Static/DHCP        |

### Electrical Specifications

|                            |                        |
|----------------------------|------------------------|
| <b>Supply voltage:</b>     | AC: 100V-230V, 50/60HZ |
| <b>Working voltage:</b>    | DC: 12V                |
| <b>Power consumption:</b>  | Max. 5 Watt            |
| <b>Length power cable:</b> | 1,5m                   |

### Environmental Specifications

|                               |                    |
|-------------------------------|--------------------|
| <b>Operating temperature:</b> | +0 / +40 °C        |
| <b>Storage temperature:</b>   | -10 / +55 °C       |
| <b>Do not mount under:</b>    | Metal desk / table |

# EU Declaration of Conformity



## Declaration of Conformity

We, the undersigned,

|                               |   |
|-------------------------------|---|
| <b>Company</b>                | N.V. Nederlandsche Apparatenfabriek Nedap       |
| <b>Address, City, Country</b> | Parallelweg 2, 7141 DC Groenlo, The Netherlands |
| <b>Phone number</b>           | +31 544 471 162                                 |
| <b>Fax number</b>             | +31 544 463 475                                 |

certify and declare under our sole responsibility that the following equipment:

|  |  |
|--|--|
| <b>Product description / Intended use</b>  | Multi-purpose solution for reading RFID activated library items on 13,56 MHz   |
| <b>Manufacturer</b>  | N.V. Nederlandsche Apparatenfabriek Nedap, Parallelweg 2, 7141 DC Groenlo (NL) |
| <b>Brand</b>   | Nedap  |
| <b>Model: MidRanger with Antenna 8684818</b>   |  |
| <b>Power Supply: PW-024A-1Y120K by Power-Win Technology Corp (In: 100-240 Vao, 50-60 Hz, 0.8-0.3 A. Out: 12 Vdc, 2 A).</b> |  |

is tested to and conforms with the essential requirements for protection of health and the safety of the user and any other person and Electromagnetic Compatibility, as included in following standards:

| Standard                         | Issue date                       |
|----------------------------------|----------------------------------|
| EN 60950-1 + A1 + A11 + A12 + A2 | 2006 + 2010 + 2009 + 2011 + 2013 |
| EN 62369-1 and EN 50364          | 2010                             |
| EN 301 489-1V1.9.2 and -3 V1.6.1 | 2011 and 2002                    |
| EN 55022 and EN 55024            | Both 2010                        |
| EN 61000-6-2 + EN61000-6-3 + A1  | 2005 + 2007 + 2011               |

and is tested to and conforms with the essential radio test suites so that it effectively uses the frequency spectrum allocated to terrestrial/space radio communication and orbital resources so to as to avoid harmful interference, as included in following standards:

| Standard                           | Issue date |
|------------------------------------|------------|
| EN 300 330-1 V 1.8.1 and -2 V1.6.1 | Both 2015  |
| ERC REC 70-03                      | 2016       |

and therefore complies with the essential requirements and provisions of the Directive 1988/6/EC of the European Parliament and of the council of March 9, 1989 on Radio equipment and Telecommunications Terminal Equipment and the mutual recognition of their conformity and with the provisions of Annex III (Conformity Assessment procedure referred to in article 10).

The equipment also complies with Directive 2011/86/EU of the European Parliament and of the Council of 8 June 2011 on the restriction of the use of certain hazardous substances in electrical and electronic equipment.

The following Notified Body has been consulted in the Conformity Assessment procedure:

| Report-Declaration Numbers  | Issued by  |
|---|--|
| 10053133 001, 10058145 001,<br>50051171-001, 50051171 001 AppendixD,<br>50051171 001 AppendixP<br>NEMKO Report 306422 | TÜV Rheinland Taiwan Ltd., 11F., No.758, Sec. 4, Bade Rd., Songshan Dist., Taipei City 105, Taiwan, R.O.C.   |
| 141116.02 HE, 141116.03 RoHS  | Power-Win Technology Corp. 5F-6, No.79, Sec.1, Hsin-Tai 5 <sup>th</sup> Rd., Shi-Chi, Taipei Hsien 221 Taiwan, R.O.C<br>Nedap, Parallelweg 2, 7141 DC Groenlo, The Netherlands |

The technical documentation as required by the Conformity Assessment procedure is kept at the following address:

|                                |  |
|--------------------------------|--|
| <b>Company</b>                 | N.V. Nederlandsche Apparatenfabriek Nedap                                |
| <b>Address, City + Country</b> | Parallelweg 2, 7141 DC Groenlo, The Netherlands                          |
| <b>Phone number</b>            | +31 544 471 162  |
| <b>Fax number</b>              | +31 544 463 475  |
| <b>E-mail</b>                  | <a href="mailto:jacques.Hulshof@nedap.com">jacques.Hulshof@nedap.com</a> |



|                          |   |
|--------------------------|---|
| <b>TF reference nr.</b>  | 141116.01                                 |
| <b>Drawn up in</b>       | Groenlo, The Netherlands                  |
| <b>Date</b>              |   |
| <b>Name and position</b> | Jacques A.M. Hulshof, Approbation Officer |

N.V. Nederlandsche Apparatenfabriek "Nedap"  
Parallelweg 2  
NL-7141 DC Groenlo  
P.O. Box 6  
NL-7140 AC Groenlo

T +31 (0)544 471 111  
F +31 (0)544 463 475  
E [info@nedap.com](mailto:info@nedap.com)  
www.nedap.com

Traderegister 08013836  
ABN-AMRO 59.16.32.330  
IBAN NL83ABNA0591632330  
BIC ABNANL2A  
VAT NL006456285801

The General Terms & Conditions of ICT-Office apply to all our offers and agreements. These conditions can be found at our website [www.nedap.com](http://www.nedap.com) and can be provided upon request.



Nedap Library Solutions | [www.nedaplibrary.com](http://www.nedaplibrary.com) | [info@nedaplibrary.com](mailto:info@nedaplibrary.com)