

uPASS Access Installation Guide



FCC ID: CGDUPASSACC
IC: 1444A-UPASSACC

Compliance statement:

This device complies with part 15 of the FCC rules and to RSS210 of Industrial Canada.

Operation is subject to the following two conditions:

- (1) this device may not cause harmful interference, and
- (2) this device must accept any interference received, including interference that may cause undesired operation.

Déclaration conformité:

Cet appareil se conforme aux normes RSS210 exemptés de license du Industry Canada.

L'opération est soumis aux deux conditions suivantes:

- (1) cet appareil ne doit causer aucune interférence, et
- (2) cet appareil doit accepter n'importe quelle interférence, y inclus interférence qui peut causer une opération non pas voulu de cet appareil.

Warning:

Changes or modifications not expressly approved by the party responsible for compliance could void the user's authority to operate the equipment.

This equipment complies with FCC RF radiation exposure limits set forth for an uncontrolled environment.

This device shall be installed to provide a separation distance of at least 20 cm from all persons.

CONTENTS

1	INTRODUCTION	4
1.1	SUPPORTED TAGS	4
1.2	TAG SECURITY	5
2	INSTALLATION	6
2.1	SAFETY INSTRUCTION	6
2.2	MOUNTING INSTRUCTIONS	6
3	CONNECTIONS	8
3.1	POWER SUPPLY	9
3.2	COMMUNICATION	9
3.2.1	RS485	9
3.2.2	USB	9
3.2.3	WIEGAND / MAGSTRIPE	10
3.3	LED CONTROL	11
3.4	TAMPER SWITCH	11
3.5	NEDAP ANTENNA INTERFACE	11
4	UHF FREQUENCIES	12
4.1	RADIO REGULATIONS	12
4.2	FREQUENCY CHANNEL SELECTION	12
5	READER CONFIGURATION	13
5.1	UHFTOOL SOFTWARE	13
5.2	SETTINGS	13
5.2.1	READ DATA	13
5.2.2	DECODE NEDAP XS	14
5.2.3	RELAY / TIMING	15
5.2.4	LED CONTROL	15
5.3	EXPERT SETTINGS	16
5.3.1	OUTPUT	16
5.3.2	OUTPUT MESSAGE FORMAT	16
5.3.3	EXTRA OUTPUT	17
5.3.4	FREQUENCY	18
5.3.5	READ RANGE	18
A	TECHNICAL SPECIFICATIONS	19
B	PART NUMBERS	19

1 INTRODUCTION

The uPASS Access reader offers a revolutionary and enduring solution for hands-free door access. The uPASS Access has the dimensions of a conventionally access control reader but offers read range unmatched in the industry. The uPASS Access offers identification up to 2 meter (6 feet) using the latest UHF technology.

The uPASS Access includes a RS485 interface, a wiegand/magstripe and a RF-modulation interface. The uPASS Access can also be connected to NEDAP AEOS access control hardware such as the AP1001, using the RF-modulation interface.

The uPASS Access does not offer the TRANSIT compatibility features.

The uPASS Access is equipped with a fixed shielded cable pigtail, 12 x 0.14 mm², length 5 meter (15 feet). The cable shield shall be connected to the metal case of the external device or external devices.

In the case of extending this pigtail cable, ONLY shielded cables shall be used and all shields shall be connected to the metal case of the external device(s).

1.1 SUPPORTED TAGS

Any EPC Class 1 Gen 2 tag is supported by the uPASS Access.

NEDAP formatted UHF tags can have the following formats:

- NEDAP UHF wiegand tags
These tags will contain all wiegand information including facility code and parity bits. All wiegand formats can be supported. The reader transparently sends this information via the wiegand outputs. There is no need to change any DIP-switches or configuration settings. See chapter 3.2.3 for wiring details.

Note: The Wiegand output format is determined by the tag and not by the reader.

- NEDAP UHF magstripe tags
These tags will contain all magstripe information. The reader transparently sends this information onto the magstripe interface. There is no need to change any DIP-switches or configuration settings. See chapter 3.2.3 for wiring details.

Note: The magstripe output format is determined by the tag and not by the reader.

- NEDAP UHF XS tag
These tags are especially programmed in the same format as our 2.45GHz AVI tags (Compact-Tag, Window-Button and Heavy-Duty-Tag). The tags will also have a customer-code and id-number. The reader will modulate the tag-info onto the Nedap antenna interface output, which can be connected to NEDAP AEOS access control hardware such as the AP1001.

Note: See also the 'decode nedap xs' feature as described in chapter 5.2.2.

1.2 TAG SECURITY

EPC (Electronic Product Code) tags were introduced as a possible successor to the barcode with added functionalities. The tag emits its EPC in plain text. This makes the tags vulnerable to cloning and counterfeiting attacks. Unlike many 13MHz smartcards, EPC tags do not support any DES, 3DES or AES encryption.

EPC tags contain a data field known as the Tag Identifier (TID). At the discretion of the EPC manufacturer, the value may be factory programmed and locked, ensuring that tags have a unique identity and (theoretically) cannot be cross-copied. This TID based anti-cloning mechanism is not considered to be a strong protection.

NEDAP UHF tags support a locked serialized TID and the uPASS Access reader can be configured to read the TID data field.

In addition NEDAP has also implemented an advanced anti-cloning and anti-counterfeiting method based upon a two way authentication. This feature is supported in combination with all NEDAP UHF tags.

By default the uPASS Access reader is configured to read any EPC tag.

We encourage customers to enable the TID-check or the two way authentication. But also advise not to completely rely on these methods in high-security applications.

2 INSTALLATION

2.1 SAFETY INSTRUCTION

The following safety precautions should be observed during normal use, service and repair.

- The uPASS Access may only be installed and serviced by qualified service personnel.
- Disconnect the power supply before (dis)connecting any wires, uPASS Access is NOT hot-swappable, so when making or changing connections, power must be switched OFF.
- The cable shield shall be connected with safety ground and the metal case of the external device(s).
- To be sure of safety, do not modify or add anything to the uPASS Access other than mentioned in this installation guide or indicated by NEDAP N.V.

2.2 MOUNTING INSTRUCTIONS

The uPASS Access can be mounted to any surface, including directly to metal. See the picture below for details about the dimensions.

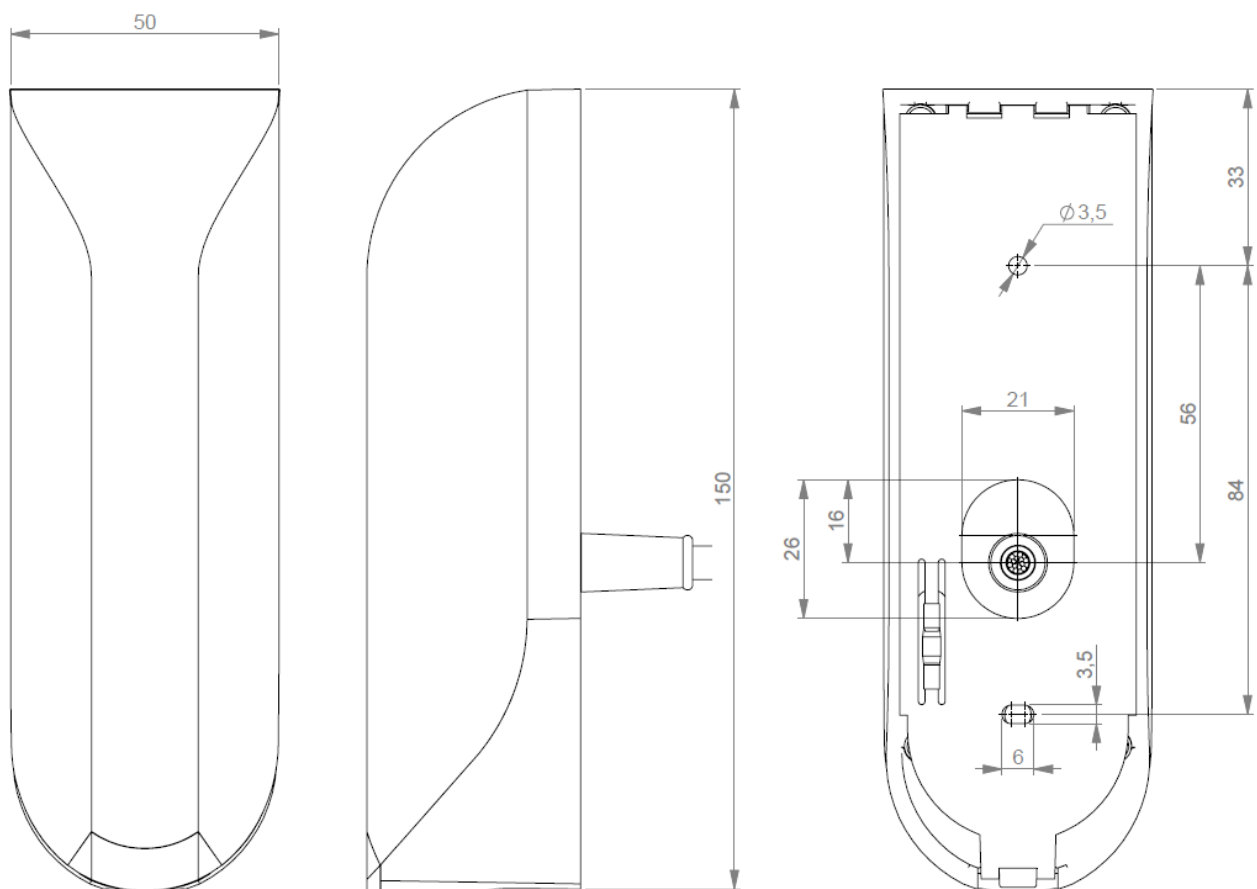

Figure 1: uPASS Access dimensions (mm)

Mount the base-plate on the required location.

Ensure that it is placed correctly covering the cable entry hole. Properly fix the base-plate into its position using the 2 screws. When mounting on a stone or concrete wall drill 5mm holes for the plugs. When mounting on wood, drill with 2.5mm.

Install the uPASS Access reader onto the base-plate.

1. Feed the cable through the cable entry hole. Important note: minimum bending radius 30mm.
2. Attach the top of the uPASS Access onto the base-plate.
3. Fix the assembly using the screw on the bottom.

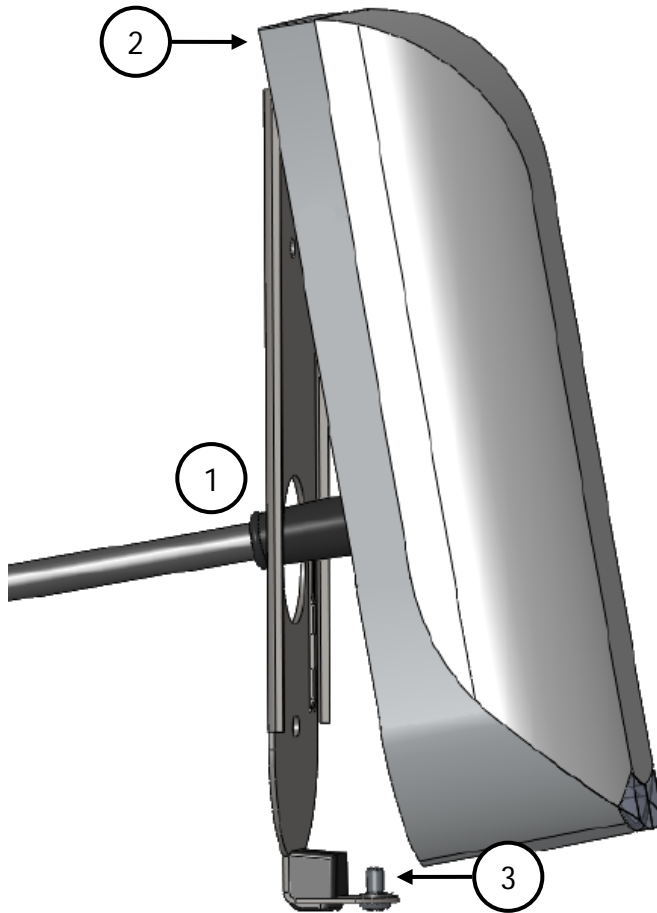

Figure 2: uPASS Access installation

3 CONNECTIONS

The uPASS Access is supplied with a 5 meter (15 feet) shielded cable pigtail with 12 multi-color wires.

RED	Power supply 12 - 24VDC.
BLACK	Power supply 0VDC, DC-Ground.
BROWN	RS485 A-
GREEN	RS485 A+
GRAY	Data-0 / Clock
PINK	Data-1 / Data
YELLOW	Tamper switch (normally closed)
GRY / PNK	Tamper switch (common)
RED/BLU	Led_UL_IN*
WHITE	Led_NA_IN*
PURPLE	Nedap antenna interface. RFMOD antenna modulation. Connect to ANT.
BLUE	Beeper_IN*
SHIELD	Shield

Note: Cable shield shall be connected to the metal case of the external device(s).
Cable extensions shall only be made by means of shielded cable(s).
All shields of the shielded cable extensions shall be connected together and to the metal case of the external device(s).
Led_UL_IN*, Led_NA_IN* and Beeper_IN* are inputs that are active LOW.

3.1 POWER SUPPLY

The uPASS Access requires DC power supply in the range from 12 – 24V. Maximum current consumption is 1A @ 12VDC, 0.5A @ 24VDC.

Connections:

RED	Power supply 12 - 24VDC.
BLACK	Power supply 0V / DC-ground.
SHIELD	Shield connected to DC-ground .

*Note: Extending this connection beyond the 5 meter pig tail length shall ONLY be allowed using shielded cable.
The minimum voltage at the end of the fixed shielded pigtail cable shall be greater than 12VDC -10%
The shield shall be connected to the metal case of the external device.*

3.2 COMMUNICATION

3.2.1 RS485

The uPASS Access reader has a RS485 interface for communication with a host system or for configuring reader settings. The RS485 interface is a 2-wire half-duplex serial communication interface using balanced lines.

Connections:

BROWN	RS485 A-	Balanced RX/TX
GREEN	RS485 A+	Balanced RX/TR
SHIELD	Shield connected to DC-ground.	

*Note: The RS485 interface is disabled while the USB interface is in use!
Extending this connection beyond the 5 meter pig tail length shall ONLY be allowed using shielded twisted pair cable(2 x 2 x 0.25 mm²) as long as the total length is shorter than 1200 meters, 6000 feet, cable capacity < 100 pF/meter.
The second twisted pair shall be used for the DC power supply.
The shield shall be connected to the metal case of the external device.*

3.2.2 USB

The uPASS Access reader features an USB interface for service, installation and firmware upgrade purposes. The Mini-USB connector is located on the bottom of the device and can only be reached when the bottom screw is opened and the uPASS Access is lifted away from the base-plate. This ensures that unauthorized modifications to the reader settings can be detected using the tamper switch.

The USB interface can be used to configure the reader using the UHFTOOL software.

*Note: While the shielded USB cable is connected, the RS485 interface is disabled!
The maximum shielded cable length shall be < 2 meter.*

USB Driver installation

Make sure your computer is connected to the internet. The driver should install automatically via Windows update when the uPASS Access reader is connected to your PC via the USB cable. Follow the driver installation wizard. If you do not see the Windows update pop-up, you can manually install the driver. To manually install, you need to go to FTDI's website at www.ftdichip.com/Drivers/VCP.htm and download the VCP (Virtual Com Port) drivers for your operating system. Drivers for MacOS and Linux are available as well.

3.2.3 WIEGAND / MAGSTRIPE

The wiegand interface connections also support magstripe.
 NEDAP UHF Wiegand tags will generate a wiegand message on the interface.
 NEDAP UHF Magstripe tags will generate a magstripe message on the interface.
 Other UHF tags will not generate a message on this interface, unless the 'Extra output' settings are used!

The wiegand/magstripe output format is determined by the programmed format of the tag.
 Make sure to order the correct tag formatting if you want to use the wiegand or magstripe interface. See also the UHF tags order guide for more information.

Connections:

	Wiegand connections	Magstripe connections
GRAY	Data-0	Clock
PINK	Data-1	Data
BLACK	Ground	Ground
SHIELD	Shield connected to DC-ground.	

*Note: Extending these connections beyond the 5 meter pig tail length shall ONLY be allowed using shielded cable (4 x 0.25 mm²) as long as the total length is shorter then 150 meters (500 feet).
 The shield shall be connected to the metal case of the external device.*

3.2.3.1 WIEGAND TIMING

In the figure below the Wiegand protocol timing is specified.

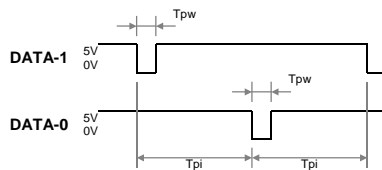

Timing constants:

Tpi	Pulse interval time	1msec
Tpw	Pulse width time	50µsec

Figure 3: Wiegand protocol timing

3.2.3.2 MAGSTRIPE TIMING

The magstripe message length is determined by the tag. The first character will be a start-sentinel (0xB). The message is terminated with an end-sentinel character (0xF) and an LRC character.

The figure below shows the timing for one magstripe character. Each bit consists out of one period low (220µsec) and two periods high (440µsec). The Data-signal is valid and stable on the falling edge of the Clock-signal. Before and after the data 16 clock pulses are generated (postamble and preamble).

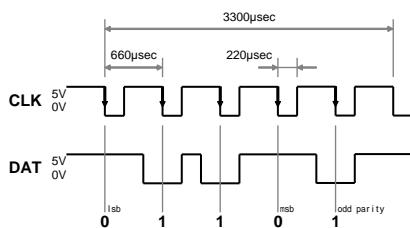

Timing constants:

Clock period	660µsec
Clock high	440µsec
Clock low	220µsec
Data pre-amble	16 clock periods
Data post-amble	16 clock periods

Figure 4: Magstripe protocol timing one character

3.3 LED CONTROL

The built-in high intensity LED provides visual feedback that the tag has been read or authorized. The LED and buzzer can be controlled by the access control system.

Automatic mode:

Default the uPASS Access will automatically control the LED.

During stand-by the LED will be RED and upon identification it will be GREEN. These colors can be changed!

Remote control:

The LED can be controlled remotely by a connected access control system. Digital inputs will determine the color indicated on the LED. Use UHFTOOL to enable the Remote LED control mode.

RED/BLU	Led_UL_IN*
WHITE	Led_NA_IN*
BLUE	Beeper_IN*
BLACK	Ground
SHIELD	Shield connected to DC-ground.

*Note: Extending these connections beyond the 5 meter pig tail length shall ONLY be allowed using shielded cable (4 x 0.25 mm²) as long as the total length is shorter than 150 meters (500 feet).
The shield shall be connected to the metal case of the external device.*

3.4 TAMPER SWITCH

An internal magnet provides tamper indication when the reader is dismounted. This contact may be connected to an external alarm system. The contacts are normally closed when the reader is in place.

Tamper switches of multiple readers can be connected in series.

Connections:

YELLOW	Tamper switch (normally closed)
GRY/PNK	Tamper switch (common)
SHIELD	Shield connected to DC-ground.

Contact ratings:

Max. current 50 mA (0.5 Volt voltage drop)
Max. switching voltage +24 VDC

*Note: Extending this connection beyond the 5 meter pig tail length shall ONLY be allowed using shielded cable (2 x 0.25 mm²) as long as the total length is shorter than 150 meters (500 feet).
The shield shall be connected to the metal case of the external device.*

3.5 NEDAP ANTENNA INTERFACE

The Nedap antenna interface is used to connect the uPASS Access to NEDAP AEOS access control hardware such as the AP1001. Instead of proximity antenna the uPASS Access can be connected.

Connections:

PURPLE	Nedap antenna interface. RFMOD antenna modulation. Connect to ANT.
BLACK	Nedap antenna interface. Ground, shield. Connect to ANT GND.
SHIELD	Shield connected to DC-ground.

*Note: Extending this connection beyond the 5 meter pig tail length shall ONLY be allowed using coaxial cable, RG58U, as long as the total length is shorter than 100 meters (350 feet).
The shield shall be connected to the metal case of the external device.*

4 UHF FREQUENCIES

4.1 RADIO REGULATIONS

The uPASS Access reader operates on the 860 – 960 MHz band. Regulations in this band are not standardized world-wide. Generally the regulations can be divided into several regions.

Per region a specific frequency band is available. This frequency band is divided into frequency channels. If local radio regulations require frequency hopping (FHSS), then the uPASS Access automatically selects and uses the available channels.

Region	Technique	Frequency	Channels
Europe		865.6 - 867.6 MHz	4
Americas	FHSS	902.7 - 927.2 MHz	52
Brazil	FHSS	915.5 - 927.5 MHz	43
China	FHSS	920.5 - 924.5 MHz	20
Australia	FHSS	920.7 - 925.2 MHz	12
Israel		915.0 - 917.0 MHz	4
Korea	FHSS	917.7 - 920.1 MHz	5
New Zealand	FHSS	917.7 - 920.1 MHz	8
Japan		917.3 - 920.3 MHz	6
Malaysia		919.8 - 922.2 MHz	5
Taiwan	FHSS	922.6 - 927.4 MHz	9
Vietnam		920.7 - 924.3 MHz	7

Table 1: Region specific parameters

4.2 FREQUENCY CHANNEL SELECTION

If no frequency hopping is required, you should select an available frequency channel manually. This can be realized as described below. Select an available frequency channel to achieve the best performance and to avoid interference from other readers or equipment.

Use UHF TOOL to setup the frequency channel selection.

5 READER CONFIGURATION

The uPASS reader settings can be configured easily using the UHF TOOL software. Software developers can find the communication protocol description in the firmware manual.

5.1 UHF TOOL SOFTWARE

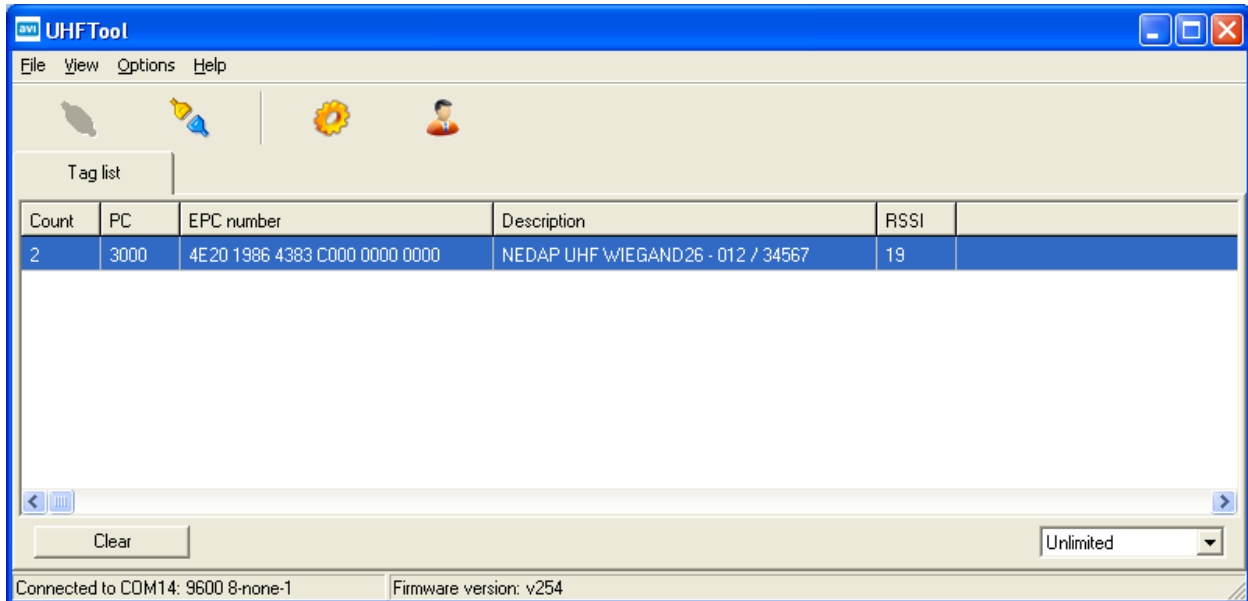

Figure 5: UHF TOOL software

5.2 SETTINGS

Click 'View', 'Show config sidebar' or press F11 to show the configuration sidebar. In the sidebar the configuration categories are shown. Expand or collapse the setting panels by clicking on it.

5.2.1 READ DATA

Configure here which tags should be selected, how to access these tags, what data should be read from these tags and if a security check should be performed.

By default the reader is configured to select ANY TAG and read its EPC number.

Select NEDAP to read only Nedap tags.

NEDAP DUAL-ID (introduced in firmware version 2.29) enables the uPASS to search for Nedap vehicle-id tags. When a vehicle-id tag is found, the uPASS searches for driver-id tags.

Example 1: Read only NEDAP UHF tags and use two way authentication:

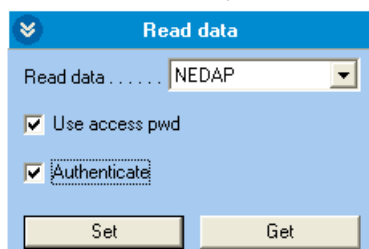

Figure 6: Read data example 1

Example 2: Read only NXP UCODE tags (TID starts with E2006) and read 4 words from user memory.

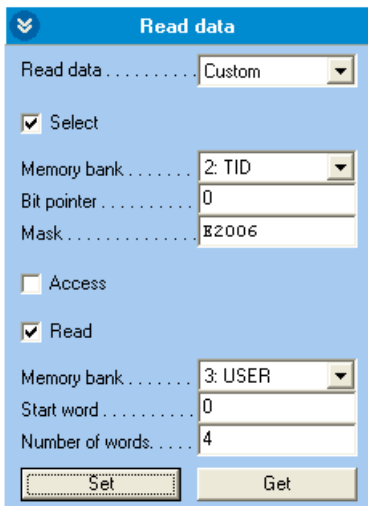

Figure 7: Read data example 2

5.2.2 DECODE NEDAP XS

Enable decode Nedap XS formatted tags. Introduced in firmware version 2.54.

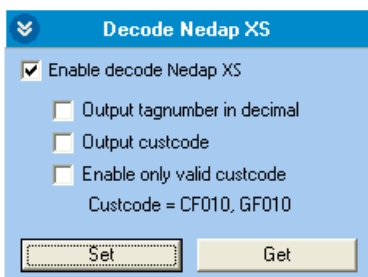

Figure 8: Output settings

By default the data on NEDAP XS formatted tags will be transmitted to the TRANSIT compatible processor or the the NEDAP antenna modulation interface. In this case the UPASS will not perform any decoding.

Enable decode Nedap XS when you do not want to use the TRANSIT compatible processor or the antenna modulation interface. The UPASS will decode the NEDAP XS tag data and output its plain tag-number. You can also enable to output or verify the customer code.

The decoded NEDAP XS output number contains:

Byte 1:	4E	NEDAP UHF
Byte 2:	<FMT>	FMT=01: Nedap XS decoded hex tagno FMT=02: Nedap XS decoded decimal tagno.
Byte 3-4:	00	Unused
Byte 5-7:	CC	CC=Customer code (zero if not transmitted)
Byte 8-12:	TAGNO	TAGNO=Tag number

Examples:

NEDAP UHF XS:	Output: 4E10 3FFF C415 A87C BD51 8000
NEDAP UHF XS decoded:	Output: 4E01 0000 0000 0000 0000 3039
NEDAP UHF XS decoded decimal:	Output: 4E02 0000 0000 0000 0001 2345
NEDAP UHF XS decoded + custocode:	Output: 4E01 0000 0415 A000 0000 3039
NEDAP UHF XS decoded decimal + custocode:	Output: 4E02 0000 0415 A000 0001 2345

5.2.3 RELAY / TIMING

Configure relay output and timing parameters.



Figure 9: Relay / timing settings

Enable 'Automatic relay activation' to activate the relay upon identification. When disabled the relay can only be activated manually.

The 'Relay hold time' setting is the minimum time the relay is activated.

The 'Vehicle hold time' setting is the time, after a vehicle-id tags has been found, for which the reader will search for driver-id tags. This setting is only used in the NEDAP DUAL-ID mode. Introduced in firmware version 2.29.

The (random) RF off time parameter can be used to enable time sharing between multiple readers on the same frequency.

5.2.4 LED CONTROL

Only for UPASS ACCESS: setup LED control mode.

Automatic mode:

Default the uPASS Access will automatically control the LED.

During stand-by the LED will be BLUE and upon identification it will be GREEN. These colors can be changed!

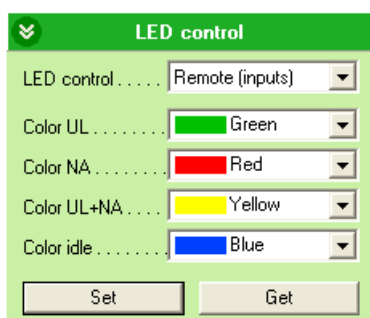

Figure 10: LED control

Remote control:

The LED can be controlled remotely by a connected access control system. Digital inputs will determine the color indicated on the LED.

5.3 EXPERT SETTINGS

Click 'Options', 'Usermode', 'Expert' to show additional configuration settings for advanced users.

5.3.1 OUTPUT

Configure communication output settings.

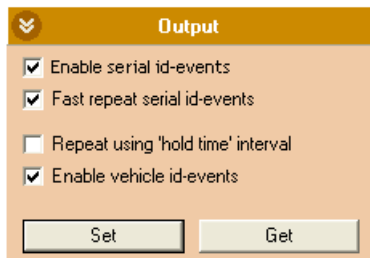

Figure 11: Output settings

Select 'Enable serial id-events' to enable the serial output upon identification. Only disable the serial id-events to optimize the identification speed when using the wiegand or magstripe interface or the TRANSIT compatible processor.

When 'Fast repeat serial id-events' is selected (default) the serial output is repeated upon every identification. When this option is disabled, the message is only sent once.

Enable 'Repeat using hold-time interval' to repeat id-events with hold-time interval. The repeating will be enabled for the serial and also for the wiegand or magstripe interface.

'Enable vehicle id-events' allows enabling or disabling the id-event messages for vehicle-ids. This may be useful in combination with the NEDAP DUAL-ID mode and an access control panel that does not support the dual-id feature.

5.3.2 OUTPUT MESSAGE FORMAT

Configure output message format.

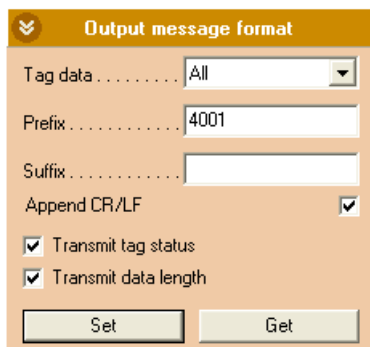

Figure 12: Output message format

The output message format is configurable:

<prefix> [<tagstatus>] [<epclen>] [<epc>] [<datlen>] [<data>] <suffix> [CR/LF]

Note: When the output message format is changed, identified tags may no longer be shown in the UHF TOOL.

5.3.3 EXTRA OUTPUT

Optionally enable wiegand or magstripe output for tags that are not programmed by Nedap in a wiegand, magstripe or nedap-xs format. This feature is introduced in firmware version 2.13 or newer.

'Protocol':

- Disabled Do not use the additional output feature.
- Wiegand Enable additional wiegand output.
- Magstripe Enable additional magstripe output.

'Data source':

- EPC number Output the EPC number using the selected protocol.
- Custom read data Output the custom data read using the selected protocol.
See for more information about how to setup custom read data chapter 5.2.1.

'Alignment':

- Full Use the complete EPC number (or all custom read data).
- Left Truncate data. Keep left.
- Right Truncate data. Keep right.

'Data length':

Data length in bits for wiegand (or in digits for magstripe).

'Offset':

Data offset in bits for wiegand (or in digits for magstripe).

'Add constant':

Enable to add a constant to the output before or after the data read from the tag.

Example 1: Output a wiegand 26-bit message with facility code 10:

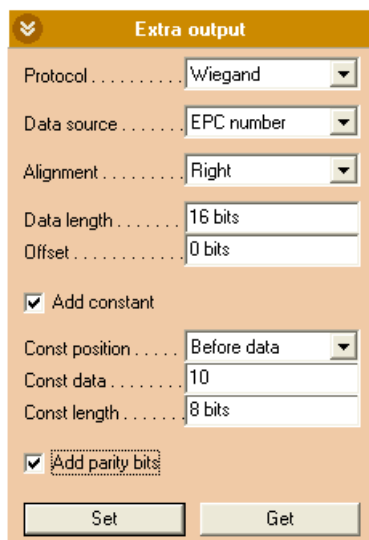

Figure 13: Additional output example 1

Example 2: Output the 13 rightmost digits from the EPC number using the magstripe interface:

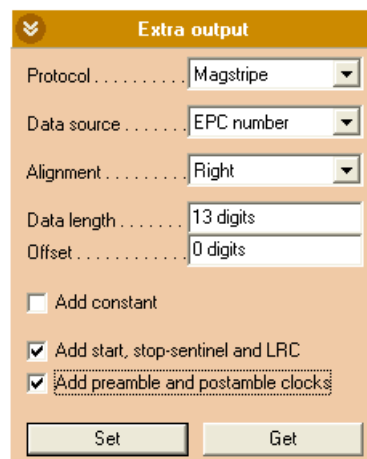

Figure 14: Additional output example 2

5.3.4 FREQUENCY

Here is shown the reader's operating frequency region.
Only for systems that do not use frequency hopping (e.g. in Europe):
You can select a frequency channel within the available frequency band.

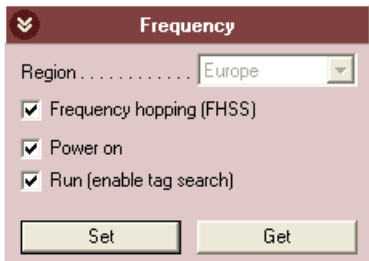

Figure 15: Frequency

5.3.5 READ RANGE

Enable the squelch to reduce the read range. This is useful to optimize lane separation.
When the squelch is enabled, you can set the squelch level. This level ensures that only tags with a returned signal strength higher than the squelch level are identified.
When the squelch is enabled and the returned signal strength is lower than the squelch level, the SQ-ACT LED indicates that the tag is rejected.

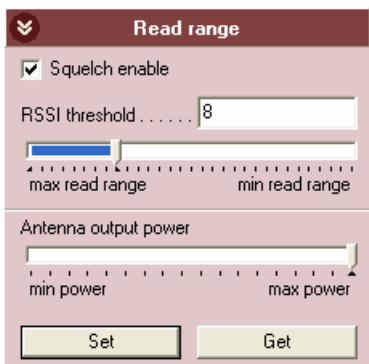



Figure 16: Read range

A TECHNICAL SPECIFICATIONS

ITEM	SPECIFICATION	REMARK
Dimensions	150x50x40mm (5.9 x 1.9 x 1.5 inch)	
Weight	0.5 kg (1.1 lbs)	
Enclosure	Polycarbonate (RAL7016)	
Chassis material	Aluminum (Zamak5) (RAL9006)	
Protection class	IP65 (Approx. NEMA4x)	
Operational temperature	-30 °C ... + 60 °C (-22°F ... +140°F)	
Relative humidity	10 .. 93 % non condensing	
Identification range	Up to 2 meters (Line Off Site) (6 feet)	With passive NEDAP UHF tags
Power supply	12 ... 24VDC ±10% linear power supply	
Current consumption	1A @ 12VDC, 0.5A @ 24VDC	
Inputs	2 digital input for LED control 1 digital input for buzzer control	Active low inputs
Tamper indication	Yes by tamper switch	Dry contact
Output	Wiegand, magstripe (clock & data)	
Cable	Fixed shielded cable length of 5 meter (16 feet) included	Cable extensions beyond the 5 meter shall ONLY be allowed using shielded cable
Interfaces	RS485 and USB	USB local service only
Air interface	ISO18000-6C	
Operating frequency	Europe: 865 ... 868 MHz Americas: 902 ... 928 MHz (FHSS) Brazil: 915 ... 928 MHz (FHSS) China: 920 ... 928 MHz (FHSS) Australia: 920 ... 926 MHz (FHSS)	
Polarization	Horizontal + Vertical	Switched every query round
ERP / EIRP	< 1 W (30 dBm) ERP (CE) < 4 W (36 dBm) EIRP (FCC)	
Safety	EN 60950	
Emission	EN 302 208-1,-2 v1.3.1 FCC part 15.247 incl. Spread Spectrum Industry Canada RSS210	

B PART NUMBERS

READERS		
	NEDAP uPASS Access (EUR) NEDAP uPASS Access (USA)	part number: 9958240 part number: 9206663