

Panel Reader VP1850

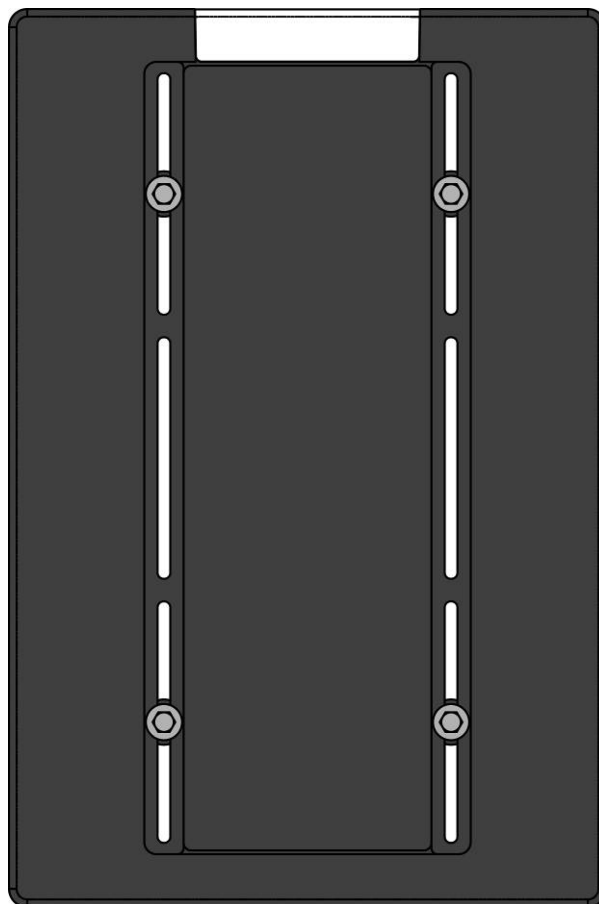

Preface

This manual describes the installation, operation, troubleshooting and maintenance of the VP1850 Panel reader. Read this manual entirely and when installing, carefully follow the instructions step by step as described in the manual.

Pictograms



Please pay extra attention here. This pictogram indicates an important subject.

Version overview

Manual version 1.0 / May 2010	First release.
Manual version 1.1 / October 2010	Wiring adjusted.
Manual version 1.2 / February 2011	IP utility wizard instructions for CD adjusted.

MODEL: VP1850 VELOS

IC: 1444A-VP1850 and FCC ID: CGDVP1850

Compliance statements

This device complies with part 15 of the FCC Rules and to RSS210 of Industry Canada.

Operation is subject to the following two conditions:

- (1) this device may not cause harmful interference, and
- (2) this device must accept any interference received, including interference that may cause undesired operation.

Cet appareil se conforme aux normes RSS210 exemptés de license du Industry Canada. L'opération est soumis aux deux conditions suivantes:

- (1) cet appareil ne doit causer aucune interférence, et
- (2) cet appareil doit accepter n'importe quelle interférence, y inclus interférence qui peut causer une opération non pas voulu de cet appareil.

Warning (part15.21)

Changes or modifications not expressly approved by party responsible for compliance could void the user's authority to operate the equipment.

This in particular is applicable for the antenna which can be delivered with the System.

This information is furnished for guidance, and with no guarantee as to its accuracy or completeness; its publication conveys no license under any patent or other right, nor does the publisher assume liability for any consequence of its use; specifications and availability of goods mentioned in it are subject to change without notice; it is not to be reproduced in any way, in whole or in part, without the written consent of the publisher.

© Nedap N.V., AGRI P.O. Box 104 NL-7140 AC GROENLO The Netherlands

Table of contents

Preface and Version overview

Table of contents

1. Introduction	1
1.1. Description	1
1.2. Functioning.....	1
2. Mounting the VP1850 Panel reader	3
3. Starting up operation	4
3.1. Connecting the VP1850 Panel reader	4
3.2. Setting up the network configuration	5
3.3. Setting up the VP1850 Panel reader software	6
4. Operation	8
5. Malfunctions and disposal	9
5.1. Trouble shooting	9
5.2. Resetting the VP1850 Panel reader	10
6. Maintenance and disposal	11
6.1. Maintenance.....	11
6.2. Disposal	11
Appendix A Technical specifications	12
Appendix B Wiring Panel reader	13
Appendix C Corridor requirements	15

1. Introduction

The VP1850 Panel reader identifies RFID ear tags attached to individual animals. The identification can be used for registration of the animals that have passed the VP1850 Panel reader unit. A weight scale can optionally be connected to the Panel reader.

This device complies with Part 15 of the FCC Rules and to RSS-210 of Industry Canada. Operation is subject to the following two conditions: (1) this device may not cause harmful interference, and (2) this device must accept any interference received, including interference that may cause undesired operation.

1.1. Description

The VP1850 Panel reader system consists of a Panel reader unit that is connected to an adaptor, a PC or a network or optionally a weight scale.

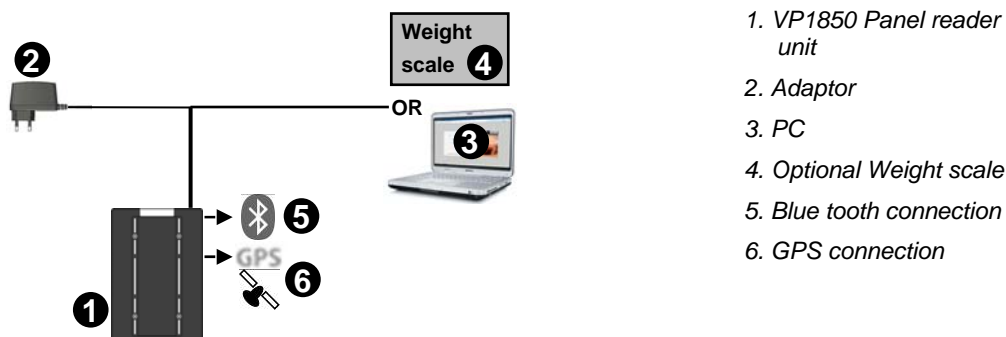

Figure 1. Overview VP1850 Panel reader system

1.2. Functioning

The VP1850 Panel reader creates a magnetic field around the antenna that is used to identify the tags on ISO frequency 134.2 kHz. The Panel reader antenna identifies RFID ear tags attached to individual animals that pass the Panel Reader unit. The identification is indicated with five blue burning led lights in the top of the Panel reader.

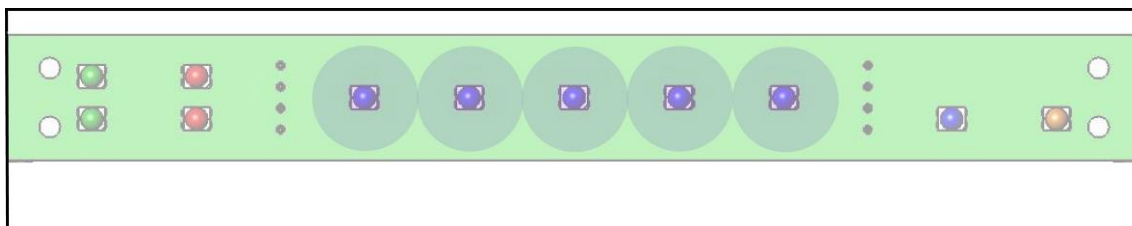

Figure 2. Identification blue led lights

When an animal is identified in the Panel reader antenna, the responder number will be stored. The responder number will be shown in the web server program. A PC or a network is used to access the web server (and the Internet worldwide). It does not have to be connected all the time.

Data				
Filename	Created	# Animals	Delete	Download
2081210.LOG	2010/02/08 12:10:42	88	X	Download icon

File content			
GPS location: 000000000 0 0000000000 0			
984000000321934	2010/02/08	12:10:42	
984000000321934	2010/02/08	12:10:51	
984000000321934	2010/02/08	12:11:00	
984000000321934	2010/02/08	12:11:03	
984000000321934	2010/02/08	12:11:05	

1. VP1850 Panel reader unit
2. Responder number (animal identification)
3. Data in web server program

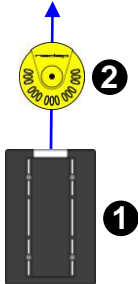

Figure 3. Connection between VP1850 Panel reader and web server program

2. Mounting the VP1850 Panel reader

See Appendix A for technical specifications before mounting. See Appendix C for corridor requirements.



Mounting requirements:

1. The Panel reader must be mounted at the side where the ear tags of the animals are attached.
2. The Panel reader must be mounted on a wall close to a stable power supply.
3. The Panel reader must **not** be mounted close to any iron. Iron will affect the performance of the antenna.
4. The Panel reader must be mounted **> 1.5 m.** from electrical cables or power supply / transformers.
5. The Panel reader must **not** be mounted close to electrical equipment (e.g. a power supply) with background noise. This can disturb the antenna.
6. The Panel reader may **not** be exposed to direct sunlight.

Mount the VP1850 Panel reader unit firmly on a wall or at a (non metal) frame.

1. Drill $\varnothing 10$ and at least 50 mm deep holes to mount the Panel reader in the 4 positions indicated in the picture below.
2. Use the bolts that are supplied with the unit to mount the Panel reader. Use the 4 big bolts for a wall or the 4 smaller ones for a metal surface.

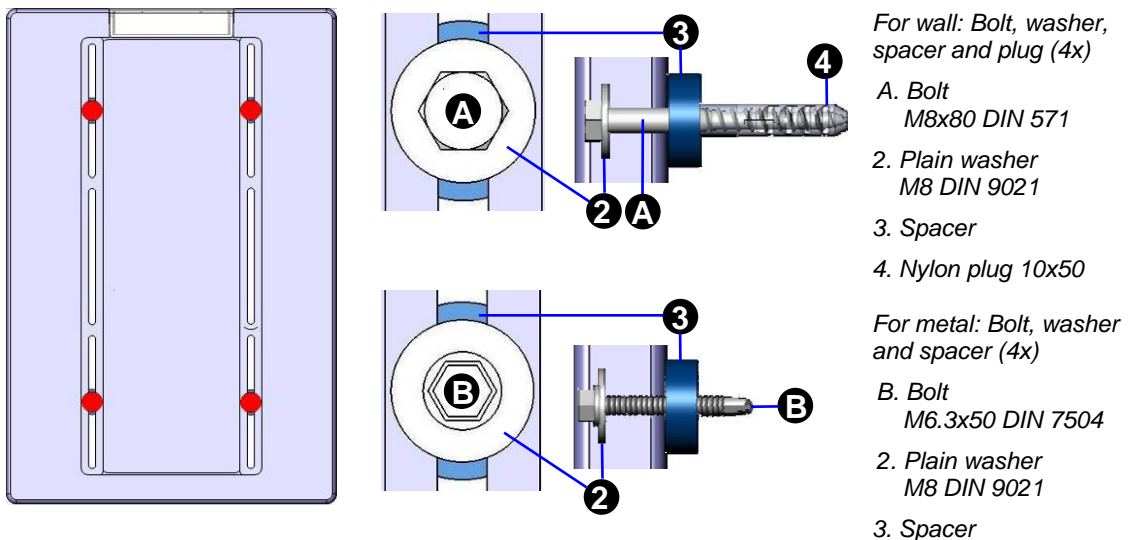

Figure 4. Mounting positions for the VP1850 Panel reader



General remark: **Don't drill through the Panel reader.** This could damage the electronics and affect the functioning of the Panel reader.

3. Starting up operation

The VP1850 Panel reader is pre-tuned and ready for use.

3.1. Connecting the VP1850 Panel reader

Connect the VP1850 Panel reader to a PC or a weight scale through an RS232 connection or to a PC or router through a LAN (or Bluetooth) connection. The Panel reader is already connected to the adapter through the connector. The adapter is optionally used when connected to a weight scale (depends on weight scale type). See appendix B for a wiring scheme of the Panel reader cable.

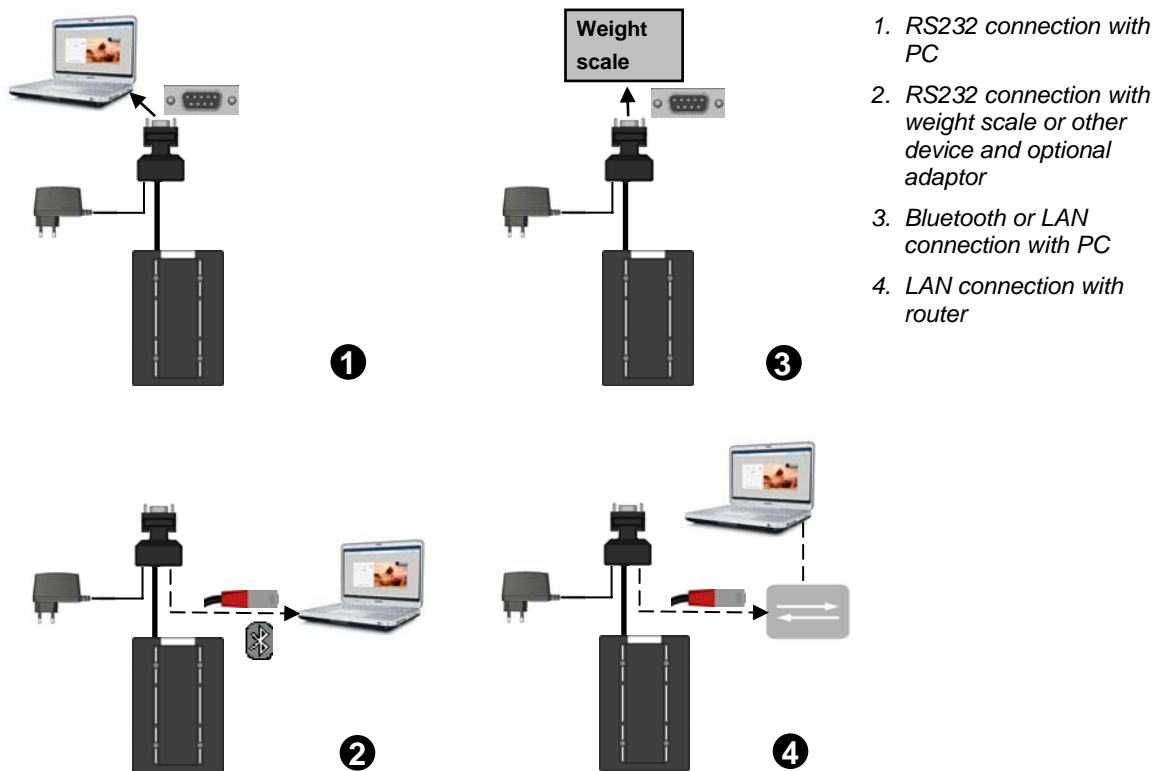

Figure 5. Overview VP1850 Panel reader system to be connected

Connect the VP1850 Panel reader to a PC or a network and optionally to a weight scale.



Install cables and power supplies / transformers > 1.5 m. from the Panel reader if possible.

3. Connect a PC to the Sub-D connection from the connector if there is no weight scale or connect a PC via the Bluetooth or LAN connection or connect a network via the LAN connection.
4. Optionally connect a weight scale to the Sub-D connection from the connector.
5. Put the adaptor into an electric socket.
6. Check the operation of the Panel reader.



Use an extension cable (art. nr 7707037) of 4 meters to extend the Velos Panel reader cable if necessary.

3.2. Setting up the network configuration

Make sure the VP1850 Panel reader is connected to the network and is operating. Take the IP Utility wizard CD and run it on the connected PC to set the IP address correctly.

1. Click on the IP utility wizard icon from the IP wizard CD.



2. Turn off the fire wall (in the Control panel - Security centre) and click Next.

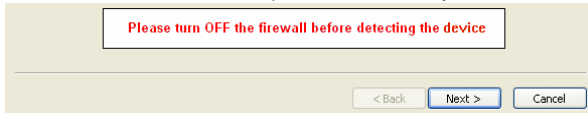

3. Click Next.

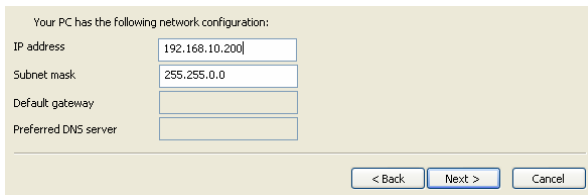

4. Click on copy advice if this is suggested and click Next.

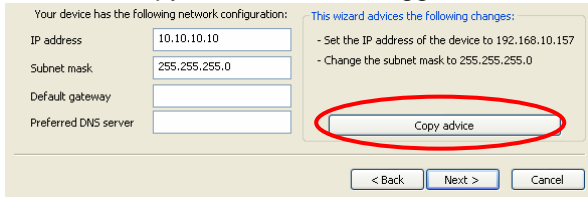

If the VP1850 Panel reader is not found check if the Panel reader is running and if the network is connected correctly. Click Back and try again. Contact a network specialist if necessary.

5. Click Next. The IP address will now be changed and a web server program shortcut will be created on the desktop.

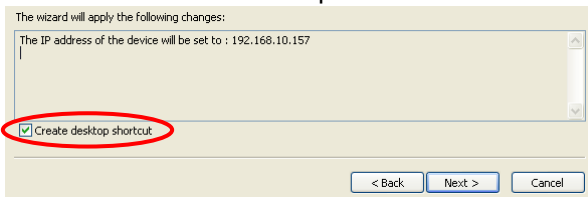

Click OK.

6. Click on OK and on Finish.

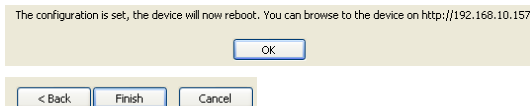

7. The web server program shortcut is now on the desktop. Click on it to start the program.



3.3. Setting up the VP1850 Panel reader software

Click on the web server shortcut icon on the desktop  to start the web server program if available or open the web browser with the IP address set with the IP Utility wizard (factory default *http://10.10.10.10*).

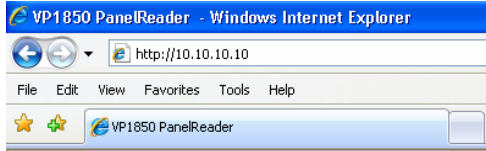

1. Set the clock time in the screen Settings > Clock and press Submit. Press refresh or F5 to get the new value from the Panel reader.

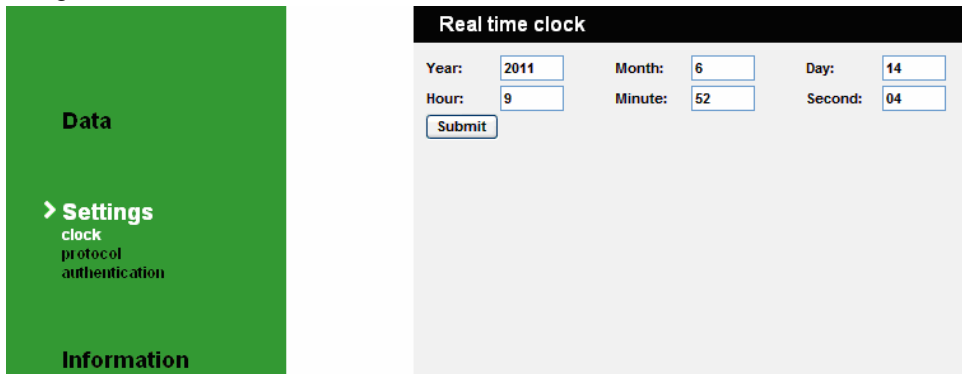

2. Change the output and storage protocol if necessary in the screen Settings > Protocol and press Submit. The output and storage settings will influence the output data that will be send by the RS232 and the Bluetooth every time a number is read.

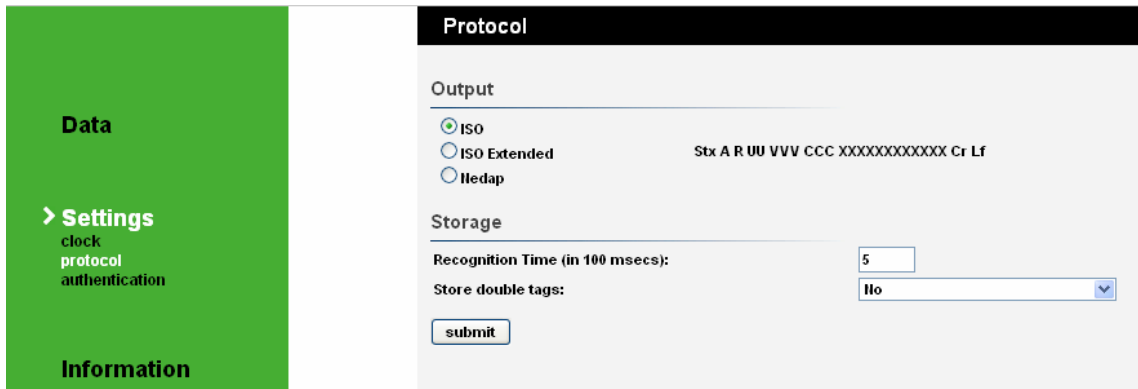

The default and recommended output setting is: ISO extended.

Output protocol:

- ISO: output data send according ISO standards.
- ISO Extended: output data send according to ISO standards, including timestamp.
- Nedap: output data send according to Nedap Velos protocol.

For advanced user: In UDP the number is sent real-time.

The default and storage settings are: Recognition time 5 and store double tags No.

- Store double tags Yes: store the identification time of double tags in the same file.
- Store double tags No: store only the last identification time.

- Optionally enter a user name and password. Especially when the Panel reader is integrated in a network this is advised.

- Change the RS232 and Bluetooth settings in the Settings screen if necessary and press Submit. The network settings have been made in § 3.2.

The default RS232 settings are: Baud rate 9600, Data bits 8, Parity None and Stop bits 1. The default Bluetooth name is BlueMod+B20 %:4a and the default security pin code is 0000. These settings can be changed.

4. Operation

The Panel reader web server data program can be opened and operated on a PC.

Click on the web server shortcut icon on the desktop  to start the web server program if available or open the web browser with the IP address set with the IP Utility wizard (factory default *http://10.10.10.10*).

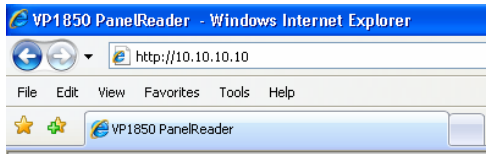



A list of filenames is shown in the data page. The last created data log file is shown at the top. Click on a filename to look at the content of a file. The data can be downloaded or deleted.

Click on download to download the data to another web page. Here you can select and copy data.

> Data

Settings

Information

Data				
Filename	Created	# Animals	Delete	Download
1082319.LOG	2000/01/08 23:19:32	2	X	
1082251.LOG	2000/01/08 22:51:02	1	X	

File content

GPS location: 5202.2113 II 00637.5422 E

984000711435048	2000/01/08	23:19:48
999000000667565	2000/01/08	23:20:01

A new data file is automatically created at midnight and after a power down.

Please note: it's a static webpage. To see new numbers click refresh or press F5.

5. Malfunctions and disposal

5.1. Trouble shooting

Check the operation of the VP1850 Panel reader regularly with (a few) tag(s). Check the actual state of the Panel reader. The Panel reader led lights will show if there are any malfunctions.

The Panel reader led lights will show if the system is working correctly or not.

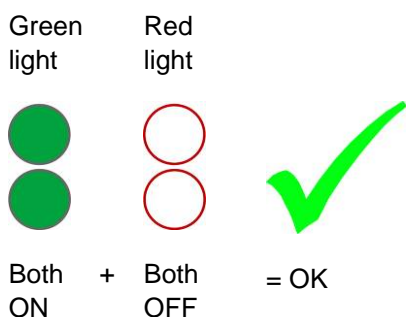

Display VP1850 Panel reader

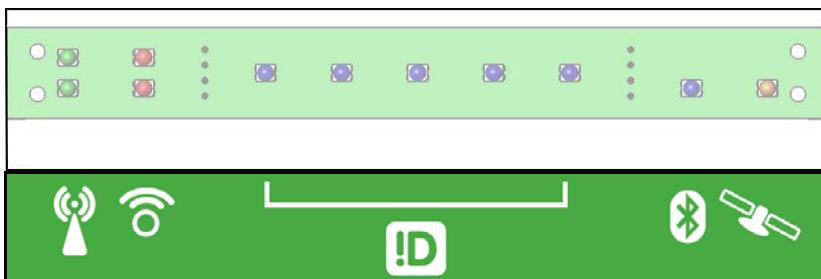

Check the cause of the malfunction and solve it.

	Problem	What/How to check or re-install	See §
	1 green light on: reduced antenna field caused by some iron. Identification possible but reduced performance.	Antenna tuning. Remove the iron from the Panel reader area.	
	2 flashing green lights: no correct antenna field caused by a lot of iron. Identification possible but a very much reduced performance.	Antenna tuning. Remove the iron from the Panel reader area.	
	1 red light(s) on: identification possible but reduced performance caused by electrical equipment with background noise. Possibly cable or power supply / transformer < 1.5 m. from the Panel reader.	Find source of the background noise in the Panel reader area that disturbs the antenna e.g. a power supply, fluorescent lightning, another antenna or a frequency controller. Delete it or turn it off.	2
	2 red light(s) on: strongly reduced performance caused by a no synchronisation with a nearby HDX reader or electrical equipment with strong electrical background noise. Possibly cable or power supply / transformer < 1.5 m. from the Panel reader. No identification possible.	Find source of the background noise in the Panel reader area that disturbs the antenna e.g. a power supply, fluorescent lightning, another antenna or a frequency controller. Delete it or turn it off. Install cables and power supply / transformer > 1.5 m. from the Panel reader if possible.	2
	Blue light not on: no signal or blue tooth pincode not entered correctly.	Check the pin code.	3.3
	Yellow light not on: no GPS signal in the area or building.	If indoors move Panel reader outdoors. If outdoors no GPS signal available.	

5.2. Resetting the VP1850 Panel reader

If necessary set the VP1850 Panel reader back to its factory defaults:

1. Turn on the power
2. Put a magnet on the spot indicated on the back of the Panel reader with a circle ○ on the sticker and keep it there. A row of blue leds will light up when the magnet is in the correct position.

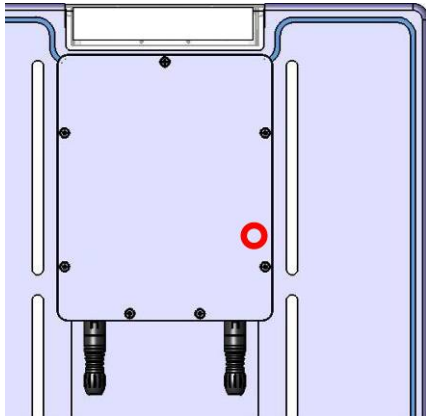

3. Turn off the power and turn it back on. The row of blue leds will light up again.
4. Remove the magnet from the Panel reader.
5. Turn off the power and turn it back on again.

The Panel reader is now set back to its factory defaults.



The IP address now is 10.10.10.10 again like in the beginning.

See chapter 3 to start up the operation again by setting the network configuration and the software settings.

6. Maintenance and disposal

6.1. Maintenance

Check the operation of the VP1850 Panel reader regularly.

No regular maintenance is required.

The Panel reader can be cleaned with water and sponge. Avoid (aggressive) cleaning liquids.

6.2. Disposal

At discard dispose of materials from the Panel reader in accordance with the current environmental rules of the state or local governing authorities.

Appendix A Technical specifications

Measurements VP1850 Panel reader

Total height	595 mm
Total width	395 mm
Depth	30 mm

Specifications for transport / installation

Weight VP1850 Panel reader	6.2 kg
Electrical supply	
Main supply	100V - 240V
Frequency	50 – 60 Hz
Input voltage (use Nedap power supply)	12 – 48 V DC
Input current (mA) depends on input voltage (without buzzer)	1 – 0.5 A
Environmental	
Operating temperatures	- 10°C / + 45°C
Transport / storage temperatures	- 40°C / + 70°C
Humidity (rh)	45°C / 85%
Enclosure protection class (when cover and cables installed correctly)	IP67
The Panel reader may not be exposed to direct sunlight.	
The Panel reader must always be transported and stored dry and frost-free.	

Appendix B Wiring Panel reader

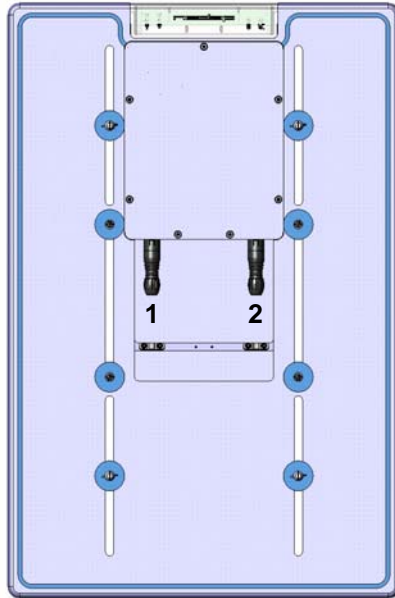

Wiring scheme Panel reader cable 1.

Connector number	Velos Panel reader cable (art.nr.7707029)			
1	Red	+	(12 – 48 V)	
2	Black	-		
3	Blue	Tx+	Ethernet 10 Mb Tx+	
4	Blue / White	Tx-	Ethernet 10 Mb Tx-	
	Shield	⊥	Shielding	
5	Orange	Rx+	Ethernet 10 Mb Rx+	
6	Orange / White	Rx-	Ethernet 10 Mb Rx-	
7	Green	TxD	RS232 TxD	
8	Green / White	RxD	RS232 RxD	



Wiring scheme Panel reader cable 2.

Connector number	Velos Panel reader cable (art.nr.7707029)			
1	Red		Not connected	
2	Black	-	Minus	
3	Blue	FDX in	F-synchronization FDX in	
4	Blue / White	FDX out	F-synchronization FDX out	
	Shield	⊥	Shielding	
5	Orange	HDX	HDX synchronization	
6	Orange / White	HDX	HDX synchronization	
7	Green		Output Buzzer -	
8	Green / White		Output Buzzer + (10 - 24 V)	



Wiring more than one Panel reader.

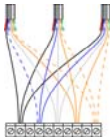
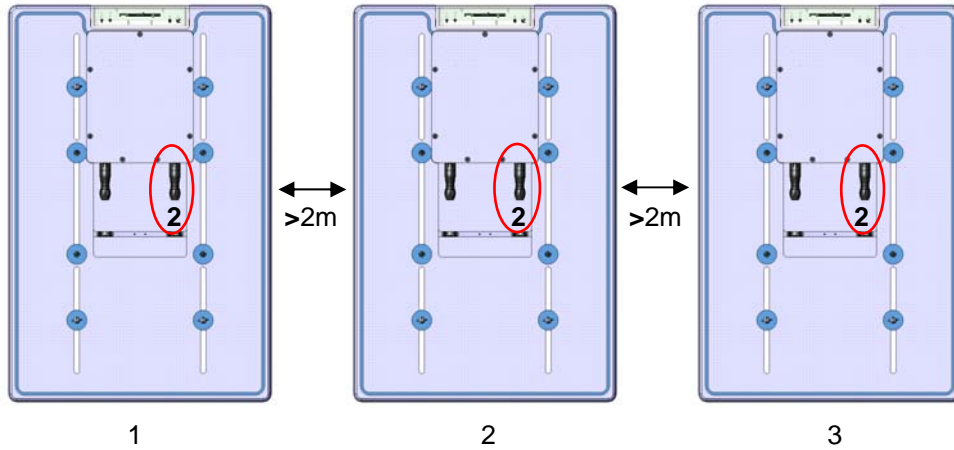

Connect all cables with number 2 to a Connector block. Connect the 1st blue-white wire and the 2nd and 3rd blue wires to one connector point. Connect all 3 black, shielding, orange and orange-white wires, each colour to one connector block point.

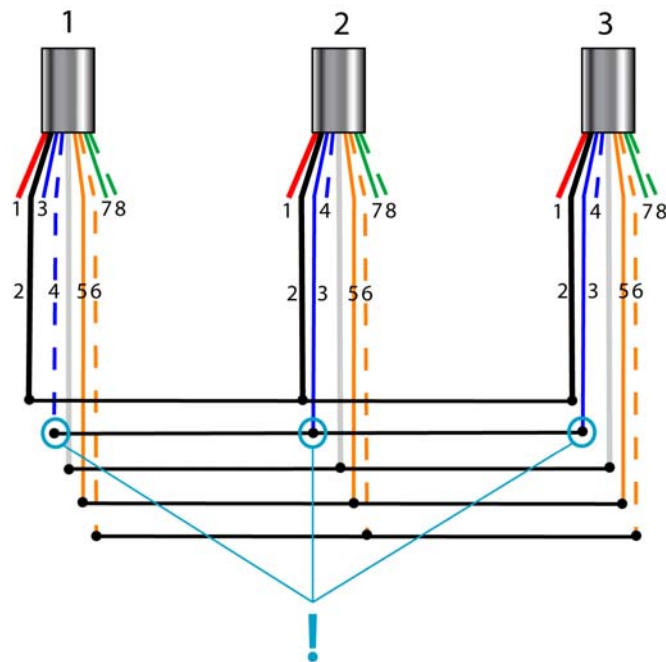

Wiring scheme Panel reader cable 2.

Connector number	Velos Panel reader cable (art.nr.7707029)		
1	Red	-	Not connected
2	Black	-	Minus
3	Blue	FDX in	F-synchronization FDX in
4	Blue / White	FDX out	F-synchronization FDX out
	Shield	⊥	Shielding
5	Orange	HDX	HDX synchronization
6	Orange / White	HDX	HDX synchronization
7	Green		Output Buzzer -
8	Green / White		Output Buzzer + (10 - 24 V)



Appendix C Corridor requirements

The maximum corridor width at the Panel reader location will be different for each animal sort and breed. Make sure the corridor is not too wide at the Panel reader location.



The maximum width of the corridor is essential to achieve a proper working system. Animals should never be able to pass each other, turn around or walk in the wrong direction.

