

IDnote



Preface

This manual describes the installation, operation, troubleshooting and maintenance of the **IDnote handheld reader**. Read this manual entirely and install the IDnote step by step as described in the manual.

Pictograms



Please pay extra attention here. This pictogram indicates an important subject.

More information

Later versions of this document will be posted to the Nedap Agri Website, as required. Please visit our website (<http://www.nedap-agri.com>) for more information or to find related manuals.

For questions or for further information, please contact your dealer or Nedap Agri.

Software

Check our website (<http://www.nedap-agri.com>) for the latest software releases.

Version overview

Manual version 1.0 / July 2012	First release.
Manual version 1.1 / August 2012	FCC and IC warning.

Compliance statements (part15.19)

This device complies with part 15 of the FCC Rules and to RSS210 of Industry Canada.

Operation is subject to the following two conditions:

- (1) this device may not cause harmful interference, and
- (2) this device must accept any interference received, including interference that may cause undesired operation.

Cet appareil se conforme aux normes RSS210 exemptés de license du Industry Canada. L'opération est soumis aux deux conditions suivantes:

- (1) cet appareil ne doit causer aucune interférence, et
- (2) cet appareil doit accepter n'importe quelle interférence, y inclus interférence qui peut causer une opération non pas voulu de cet appareil.

Warning (part15.21)

Changes or modifications not expressly approved by party responsible for compliance could void the user's authority to operate the equipment.

This information is furnished for guidance, and with no guarantee as to its accuracy or completeness; its publication conveys no license under any patent or other right, nor does the publisher assume liability for any consequence of its use; specifications and availability of goods mentioned in it are subject to change without notice; it is not to be reproduced in any way, in whole or in part, without the written consent of the publisher.

© Nedap N.V., AGRI P.O. Box 104 NL-7140 AC GROENLO The Netherlands

Table of contents

Version overview

Preface

Table of contents

1. Description	2
1.1. Tag scan mode	3
1.2. Batch scan mode	3
2. Working/Functioning	4
2.1. Tag scan mode	4
2.2. Batch scan mode	4
3. Safety	6
4. Installation	7
5. Start up operation	10
5.1. IDnote Data Manager program settings on PC.....	10
5.2. Bluetooth device settings	11
5.3. IDnote device settings.....	12
6. Operation	14
6.1. Scan button	14
6.2. Main menu	14
6.3. Tag menu	15
6.4. Batch menu.....	16
6.5. Batch data transfer.....	17
6.6. Operation IDnote Data Manager PC program	18
7. Maintenance, cleaning and disposal	19
7.1. Batteries	19
7.2. Cleaning	20
7.3. Disposal	20
Appendix A Technical specifications	21
Appendix B Display Icons	22
Appendix C Setup a Bluetooth connection	23

1. Description

The IDnote handheld reader is used for easy and reliable ISO tag reading. The IDnote has a scan button and a display. The scan button is used to scan a tag or to navigate through the IDnote menu. After scanning a tag, the animal ID number is visible on the IDnote display. A battery inside makes it possible to use the device wireless.

- **Display** -----
 - Icon on battery, scanning or connection status
 - Tag mode
 - Batch mode
 - Menu settings
- **Scan button:** -----

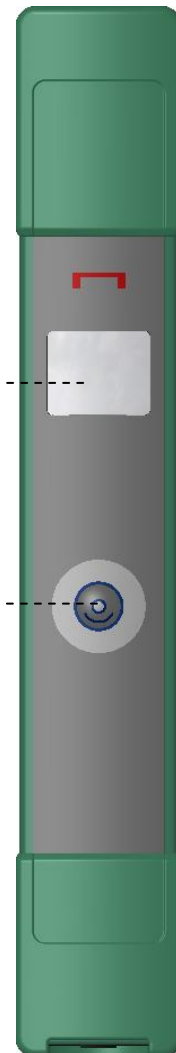

1.1. Tag scan mode

The tag scan mode is used to check the animal ID number or to check other details like the type of tag or the activity data from an animal.

- Scan a tag from one **individual animal**.
- **Scanning stops** after first identification.
- Animal ID number visible on the **display**.
- **No data storage**. Data dump right after identification.

1.2. Batch scan mode

The batch scan mode is used to scan the animals from a group.

- Scan tags from a batch of animals (a **group**).
- Rapid **continuous scanning**. Press scan button to start scanning and when ready press again to stop scanning. An animal that is scanned more often is only stored once.
- Number of animals in the batch, the batch number and the animal ID number of the last scanned animal are visible on the **display** and **stored in memory**.
- **Data transfer** between the IDnote and any PC via an USB or Bluetooth connection or a Bluetooth device like a thermal printer or an automated weighing scale is possible any time.

2. Working/Functioning

The IDnote handheld reader is used to scan the tag of individual animals. There are 2 modes that can be used to scan tags: the Tag scan mode or the Batch scan mode.

2.1. Tag scan mode

In the Tag mode it is possible to scan a tag from one individual animal. When a new tag is identified the device stops scanning. After scanning a tag, the animal ID number is visible on the IDnote display. The tag scan mode is used to check the animal ID number or to check other details like the type of tag or the activity data from the animal.



Tag scan mode

948 0000 HDX/FDX

First 7 digits of the animal ID

12345678

Last 8 digits of the animal ID

R:2 UD:34 A:1

R: Retag count, UD: User data (if animal bit is 1), A: Animal bit

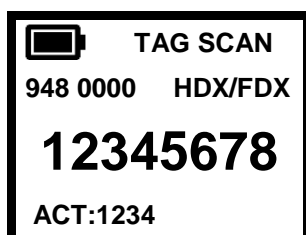

Tag scan mode

948 0000 HDX/FDX

First 7 digits of the animal ID

12345678

Last 8 digits of the animal ID

ACT:1234

ACT: Activity data (counter value activity tag. if animal bit is 0)

More details can be shown through the "Detail" menu.

2.2. Batch scan mode

In the Batch mode it is possible to scan a batch of animals.. When multiscan is turned on (default) the tags can be scanned rapidly because reader starts scanning when the scan button is pressed short and it continues to scan new tags until the scan button is pressed short again. When scanning a group of animals, the batch number and the number of animals in this batch will be visible on the IDnote display. The ID number of the last scanned animal is also visible on the display. All new ID's are stored in the batch as a list of tag numbers.



An animal is scanned for the first time.

123

Batch number

Animal counter

(>999 animals smaller digits)

123

123456789012

Animal ID number (last 12 digits)

If a tag is scanned for the second time then the display will show the number inverse in white on a black surface and the number of animals will not increase.



If the animal is scanned for the second time.

Animals counter: same number of animals.

Same Animal ID number (last 12 digits)

The collected data will be saved on the IDnote and can be transferred to a PC. The IDnote enables easy data transfer between the IDnote and any PC via an USB or Bluetooth connection or a Bluetooth device like a thermal printer or an automated weighing scale. An ASCII protocol is available to send the read and/or stored data in the IDnote to an host application. See Appendix D for more information about this protocol.

3. Safety

Before connecting and using the IDnote read this information. Not following this guidelines may be dangerous and helps to avoid possible problems using the IDnote. Read this complete user manual for further information.

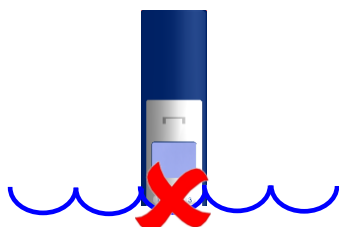

- Do not submerge.
- Do not power hose.



Keep connectors free of dirt. Always close lid when cables are not connected.



Use wrist cord to prevent from dropping.

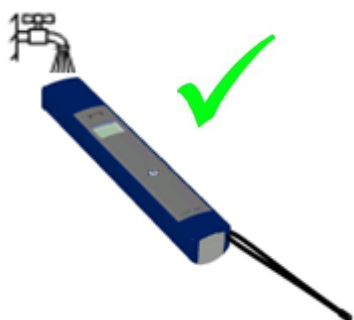

The IDnote can be rinsed with water for cleaning.

4. Installation

Execute the set up to install the necessary drivers and the IDnote data manager transfer program on a Windows computer.

1. Before first use of the IDnote, charge batteries at least **16 hours** for obtaining the maximum battery capacity (ambient temperature between 5 and 25°C) During charging communication between IDnote and PC is possible. Scanning tags is disabled.

Connect the plug in the connector on the right side to charge the batteries.



Before first use of the IDnote, charge batteries at least 16 hours for obtaining the maximum battery capacity.

1. Insert the IDnote - Velos Sync CD in the CD-ROM drive The IDnote Setup Wizard will start automatically. If not, choose Start > Run > open D:\setup.exe and click OK (supposing D is CD-ROM drive).

2. Install a new version of NET Framework if necessary. Click *Accept*.



3. Install IDnote application Click *Next*.

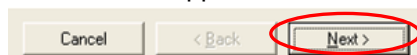

4. Change installation folder, if necessary, click *Next*.

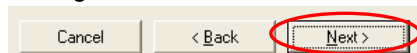

5. Confirm installation, click *Next*.

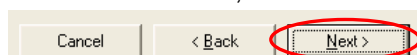

6. Software will be installed, please wait.

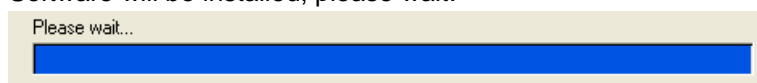

7. Continue Software Installation, click *Continue Anyway (XP)*, or *Install this driver anyway (Vista)*.

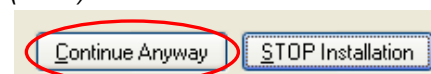

Windows XP

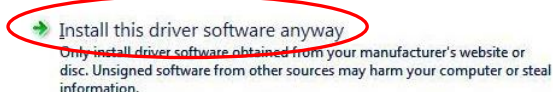

Windows Vista

8. Setup is completed, click *Close*.

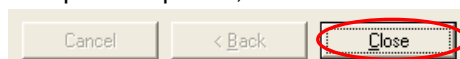

9. Connect the IDnote to the PC and switch on the IDnote.

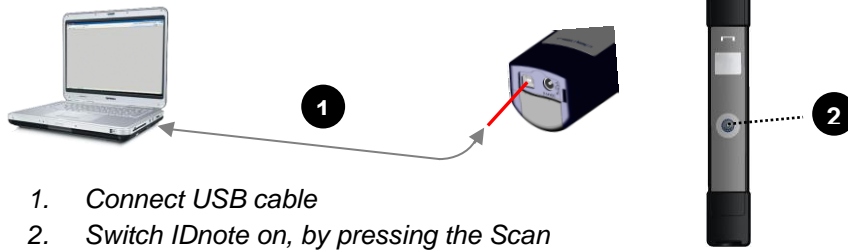

10. After the IDnote is connected to the PC, the message “Found New Hardware” appears.



The next screen will appear. Install **USB to COM** driver as described below.
(Microsoft Vista: driver will be installed automatically)

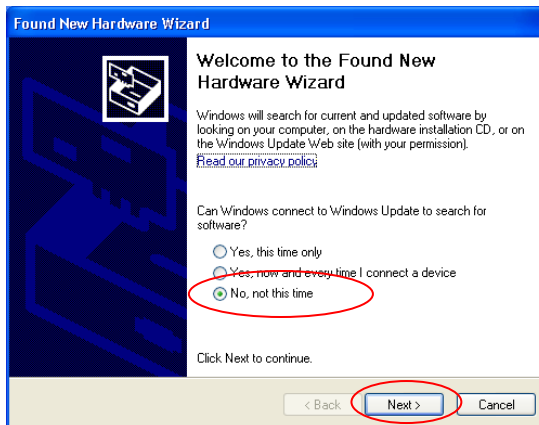

Choose *No, not this time*.

Click *Next*.

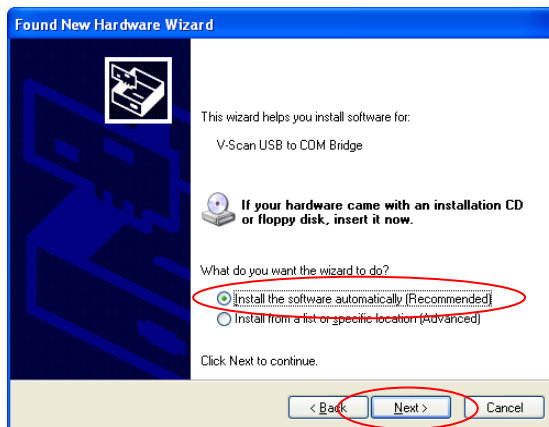

Choose *Install the software automatically*.

Click *Next*.

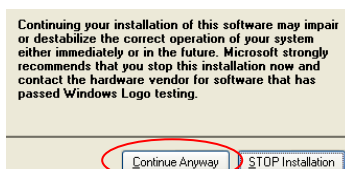

Continue Software Installation, click *Continue Anyway*.

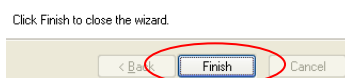

After completing the installation, click *Finish*.

- Open the IDnote Transfer Application by double clicking the **IDnote - Velos Sync** icon on the desktop. The IDnote has to be connected to the PC with the USB cable.



- When the **Windows Security Alert** appears, choose *Unblock*.

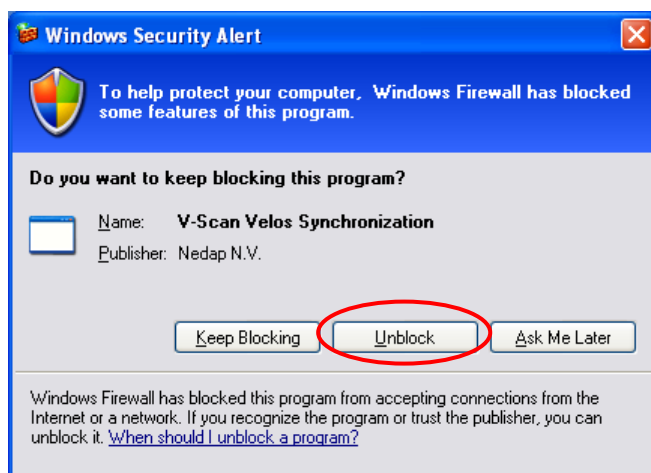

- Following screen appears. The IDnote is connected to the PC.

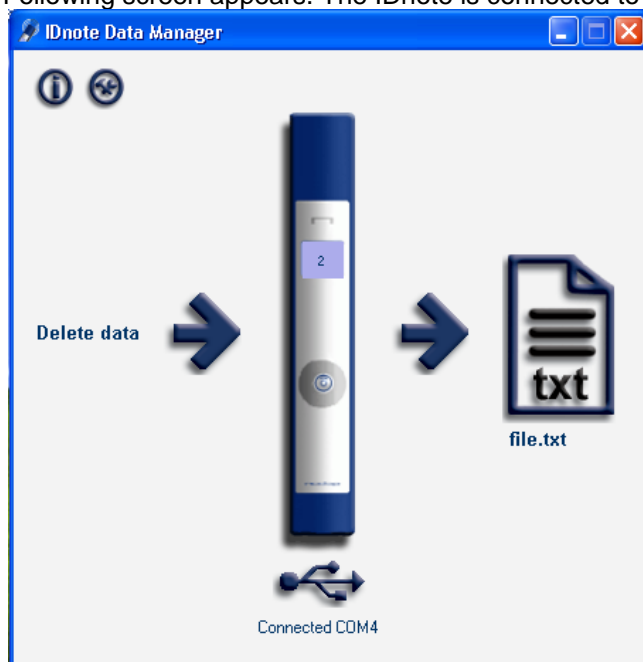

Click on the bottom image to select the com port. 

Service menu: Click on the IDnote image in the IDnote Data Manager program to check or alter the settings of the device in this program e.g. to view or update the firmware.

5. Start up operation

5.1. IDnote Data Manager program settings on PC

Connect the charger. Click on the IDnote image in the IDnote Data Manager program to check the service settings and alter them if necessary. Most of these settings can also be made in the IDnote device.

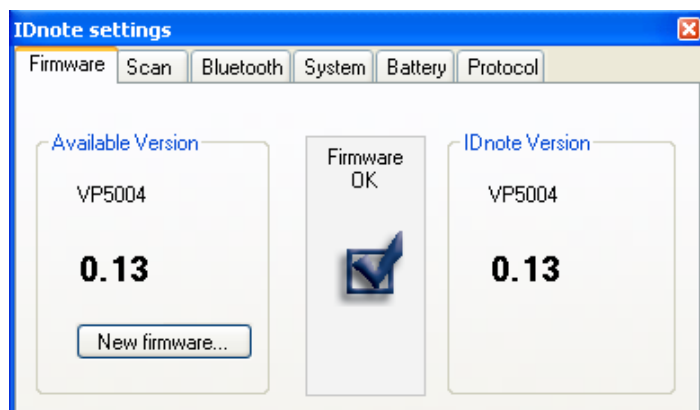

Firmware:

- Firmware version Check firmware version of the IDnote. Update the version if necessary.

Scan:

- Auto create Auto create has to be switched on!
- Scan time:  The time the IDnote keeps scanning for tags after the scan button is released when using multiscan. The IDnote keeps scanning until Scan time is passed or until the Scan key is pressed again. The Scan time must be set other than zero for the multiscan function.
- Sound: Select whether sound is enabled/disabled when scanning tags.

Bluetooth:

- On/Off: Switch the Bluetooth communication on/off.
- Name: Enter a name for the IDnote
- Pin: Enter the Pincode (option)
- Address: Enter the Mac Address

System:

- Language Select a language.
- Display contrast: Set the contrast level (1- 7) of the display. 1 means little contrast.
- Date format: Set the system type European (eur) or American date format (usa).
- Date Set the system date.
- Time Set the system date.
- Factory defaults Return to default settings.  Data will be lost!

Battery:

- Battery info Displays battery voltage and battery level (percentage).

Protocol:

- Type: Protocol type (Nedap, ISO, Sync) used when "Dump on serial comm" is enabled.

5.2. Bluetooth device settings

The IDnote can be set up as a master Bluetooth device so that other slave devices, like Bluetooth printers, can be connected to it. The Bluetooth connection uses the serial port profile.

Click on the IDnote image in the IDnote Data Manager program and on the Bluetooth tabsheet to alter the bluetooth settings. The bluetooth settings can only be modified when Bluetooth is switched off and the USB cable is connected. Click on the arrow down behind Bluetooth to switch it off.

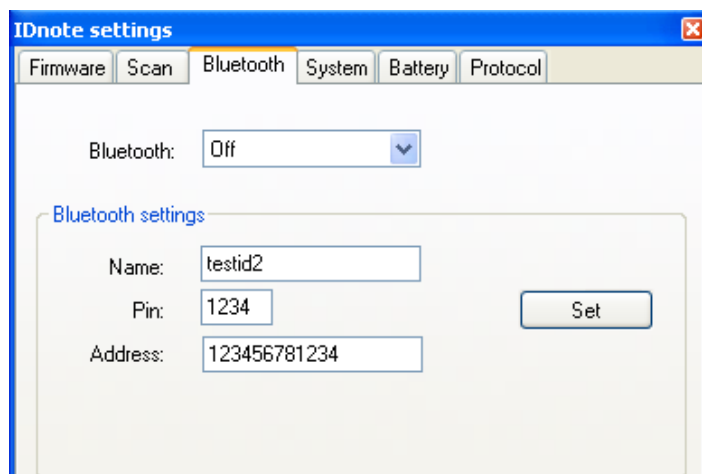

Enter a Name for the IDnote and enter the Mac Address of the device and if necessary the pincode. Click on set to save the new Bluetooth settings. Click on the arrow down behind Bluetooth to switch it back on.

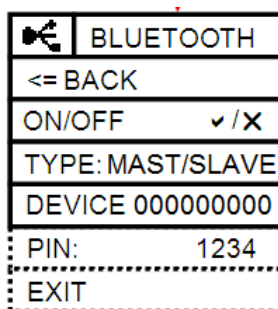
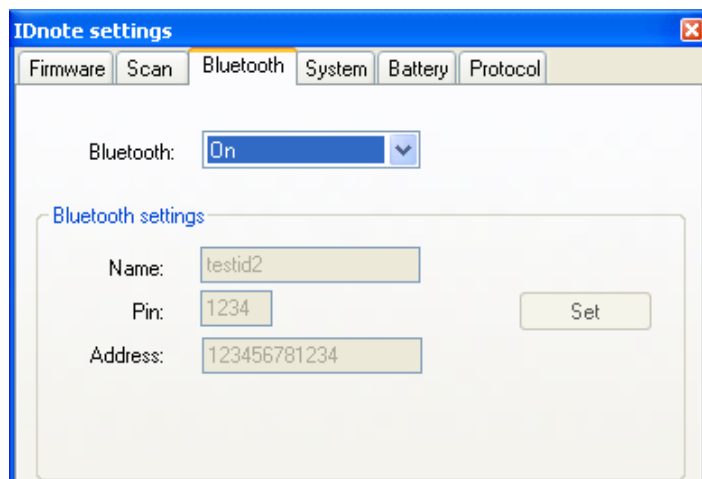

Now go to the Bluetooth Settings in the Menu on the IDnote device and change the Bluetooth setting from Type slave to Type master. Be aware that the scanning process might now operate slower because the data are to be transferred to the bluetooth device after scanning. See the next chapter for more information about the menu.

5.3. IDnote device settings

Connect the charger. Use the scan button to change the default settings if necessary.



Use the scan button to navigate through the different settings in the menu screens. Press the scan button long to switch from the Tag or Batch scan mode to the menu. Use the scan button short to navigate through the different settings in the menu screens. Press long to enter a menu choice.

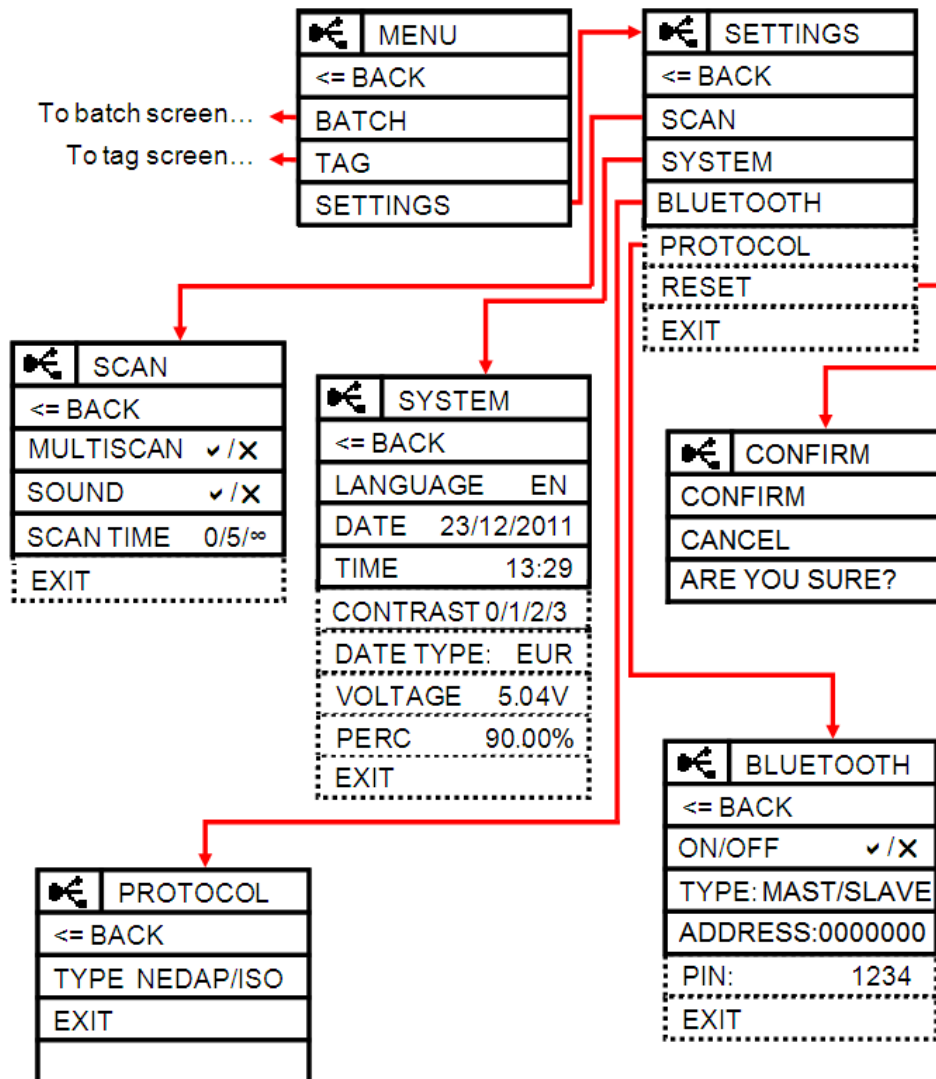

See the next page for more information about the settings in the menu. Most of these settings can also be made in the IDnote Data Manager program on the PC.

Scan

- Multiscan: More than one tag can be scanned during one read-session without pressing the scan key again.
 - Sound: Select whether sound is enabled/disabled when scanning tags.
 - Scan time: The time the IDnote keeps scanning for tags after the scan button is released when using multiscan. The IDnote keeps scanning until Scan time is passed or until the Scan key is pressed again.
- 
- The Scan time must be set other than zero for the multiscan function.

System

- Language: Select a language.
- Date: Set the system date.
- Time: Set the system time.
- Date type: Set the system type European (eur) or American date format (usa).
- Contrast: Set the contrast level (1- 7) of the display. 1 means little contrast.
- Voltage: Displays battery voltage.
- Percentage: Displays battery level (percentage).

Bluetooth

- On/Off: Switch the Bluetooth communication on/off.
- Type: Master or Slave device
- Address: Mac Address (enter via PC)
- Pin: Pincode (enter via PC)

Protocol

- Type: Protocol type (Nedap, ISO, ASCII 15 used when “Dump on serial comm” is enabled. X =no dump.

Reset:

- Confirm  All data will be lost!
- Cancel <= Back

6. Operation

Use the Tag or the Batch scan mode to scan tags or use the menu for other actions. Press the scan button long to switch from the scan mode to the menu. Use the exit option in the menu to return to the Tag or Batch scan mode. Use the option <= Back o go back to the previous menu.

6.1. Scan button



Use the scan button for scanning or to navigate through the different settings in the menu screens.

Tag scan mode: Press the scan button short in the Tag scan mode to scan a tag.

Batch scan mode: Use the Batch scan mode to scan tags of one or more groups of animals. Press the scan button short to turn on the scanning mode and press it short again to turn it off.

Menu: Use the scan button to navigate through the different settings in the menu screens. Press the scan button long to switch from the Tag or Batch scan mode to the menu. Use the scan button short to navigate through the different settings in the menu screens. Press long to enter a menu choice.

Press short

- turn on the IDnote
- start a scan routine (tag mode)
- start/stop a scan routine (batch mode)
- navigate through the menu

Press long

- enter a menu
- enter a menu option

Use the scan button to turn on the IDnote. The IDnote turns off automatically. Connect the charger to prevent that.

6.2. Main menu

The main menu is the same for both the Tag and the Batch menu.

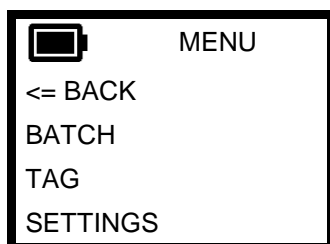

Main menu title

Switch to Batch scan mode

Switch to Tag scan mode

Navigate to Settings submenus

See the chapter Installation for more information about the settings in the menu.

6.4. Batch menu



Use the Batch scan mode to scan and store tags of one or more groups of animals. Press the scan button short to turn on the scanning mode and press it short again to turn it off. Watch the displayed information e.g. the group number and the number of animals in the group.

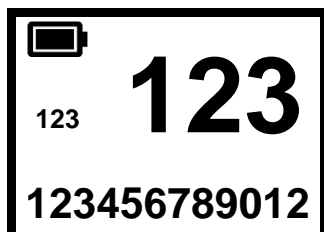

Batch number

Animal counter

(>999 animals smaller numbers)

Animal ID number (last 12 digits)

After scanning a group of animals, press the scan button long to switch from the scan mode to the menu. Use the scan button to navigate through the different options in the Batch menu screens. It is possible to start a new batch, select another batch, to delete the batch or the tag of the last scanned animal, to print a batch or view the tags in a batch.

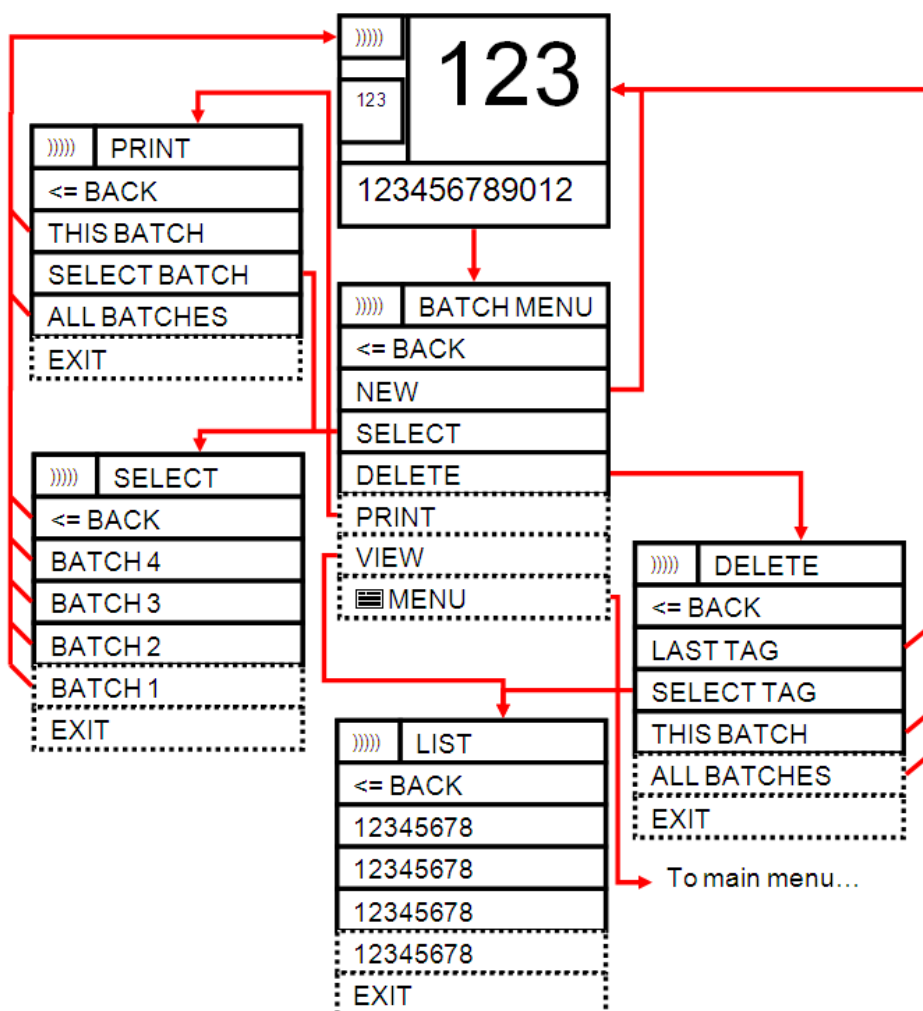

6.5. Batch data transfer

In the Batch scan mode the data of the scanned tags are stored by the IDnote.

Stored information:

Data item	Description	Size
Tag number	Complete ID of the animal	
Record index	Index of record in database	
Batch number	Number of batch to which ID belongs	
Batch index	Index of record in batch	
Scan date	Date when tag was scanned	
Scan time	Time when tag was scanned	
IF animalbit == 0	Store activity data	
Classic activity	Step counter	2 bytes / 12 bits
IF animalbit == 1	Store iso data	
Retag count	Animal got new tag	
Animal bit	Iso data	1 bit
Userinfo	Iso data	

Save or change the information of the batches on the IDnote or export the data to a PC or to a Bluetooth connected storage.

The data collected by the device can be transferred to a computer through a (USB or Bluetooth) serial port. In the scan settings menu is a dump option which causes the device to transmit every scanned tag immediately over the serial port.

See manual VP5002-100SS-05 ASCII Protocols on the Cd that was supplied with the IDnote for a description of the dump protocols Nedap, ISO and Sync.

6.6. Operation IDnote Data Manager PC program

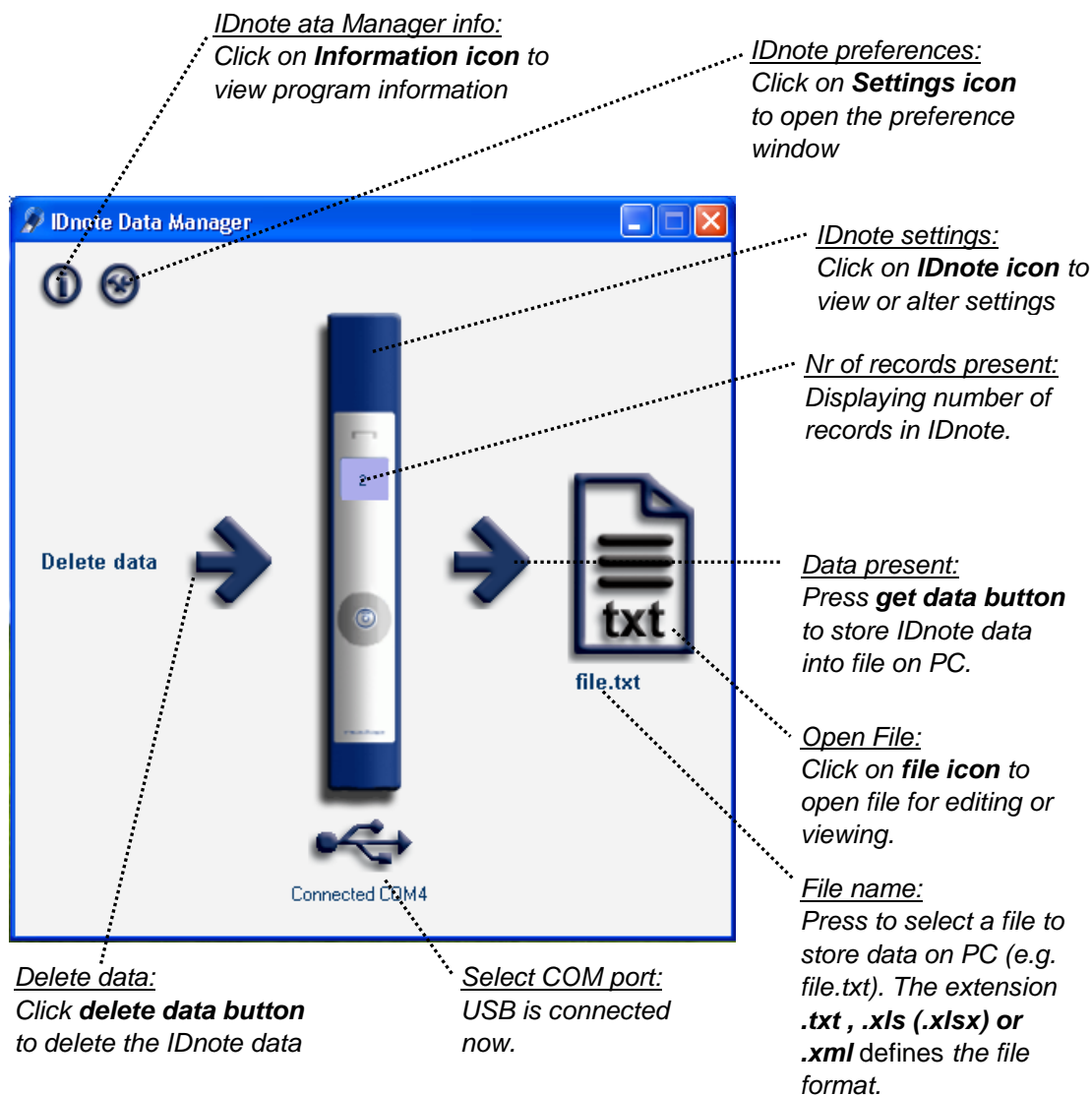

Click on the IDnote image in the IDnote Data Manager program to view or alter the settings of the device in this program e.g. to view or update the firmware. View the number of animals in the IDnote display.

Click on the arrow behind Delete data to delete all data from the IDnote. Click on the arrow before the data file to transfer the data from the IDnote to the data file. Click on the file image to view or edit the data. The transfer program can export the data to a .xls, xml and .txt file. Click on the file name to change the file or the type of file to e.g. an excel file.

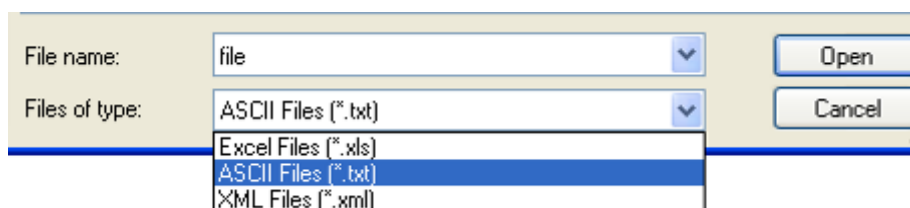

7. Maintenance, cleaning and disposal

7.1. Batteries

The IDnote is powered by four rechargeable batteries. The full performance of new batteries is achieved only after a few charge and discharge cycles. The ambient temperature for charging the batteries of the IDnote must be between 5°C and 25°C. **Only use the charger (230/110V AC – 12VDC) provided along with the IDnote.**



Before first use of the IDnote, charge batteries at least 16 hours for obtaining the maximum battery capacity.

Connect the plug in the connector on the right side to charge the batteries.



The batteries can be charged and discharged hundreds of times, but it will eventually wear out. When the scanning time is noticeable shorter than normal, replace the batteries. Warranty is not applicable for the rechargeable batteries.

Steps for replacement of rechargeable batteries:

1. Open the back cover of the IDnote. Use **PZ2** screw driver.
 2. Open the back cover.
 3. Replace the batteries. Mount the batteries in the correct direction. Watch the positive and negative terminals of the batteries for the direction.
- Dispose of batteries according to local regulations (e.g. recycling). Do not dispose as household waste.
4. After replacing batteries, close the back cover and fix the screws firmly.
 5. Connect the charger, now the IDnote can be switched on.

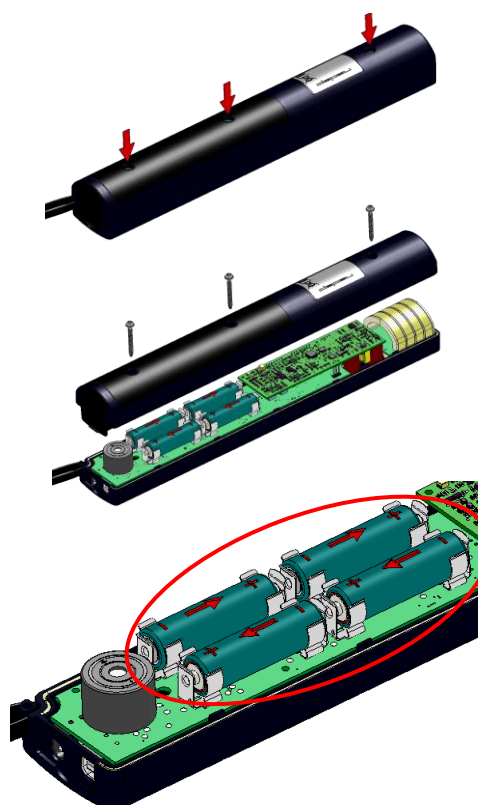

Only replace batteries with same type (4x AA-size, rechargeable, Recyko+, 1.2V, 2100mAh, NiMH, GP210AAHCB)

7.2. Cleaning

The IDnote can be rinsed with water for cleaning. Be sure that the cover lid is closed.

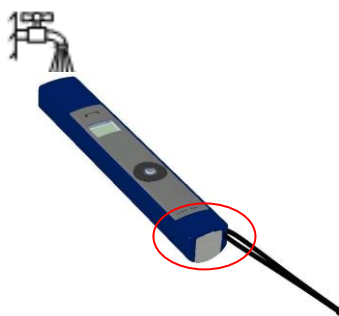

7.3. Disposal



The crossed-out wheeled bin means that within the European Union the product must be taken to separate collection at the product-end-of-life. This applies to your device but also to any enhancements marked with this symbol. Do not dispose of these products as unsorted municipal waste.



Appendix A Technical specifications

VP5004, IDnote ISO hand Held Reader (EU/USA)

Physical	
Size (LxWxH)	330 x 50 x 40 mm
Weight	0,535 kg
Display	LCD with back light, 6 rows of 16 positions
Keyboard	Numeric + Menu control keys
Environment	
Operating temperature	-10 - +50 °C
Storage temperature	-25 - +50 °C
Relative humidity	30 -100 %
Protection classification	IP64
Reliability	
MTBF	200.000 hours
Expected Life	5 years, minimum
RFID	
Technology	ISO 11784 ISO 11785 FDX and HDX
Synchronization	ISO 11985 Annex C compliant
Reading distance	> 20 cm (depending on label)
Reading speed	< 70 msec
Reading confirmation	Audible and visible signal
Certifications	CE, IC, FCC
Data	
Clock	Real time clock for reading time stamp
Communication	USB 2.0 and Bluetooth (at least 5 m)
Format	ASCII (Nedap Dump, ISO Dump or Nedap Sync)
Memory	1 Mbyte static memory (=10000 animals)
Power	
Power source	4x AA-size, rechargeable, Recyko+, 1.2V, 2100mAh, NiMH (GP210AAHCB)
Stand-by	50 days
In action scanning tags	> 2 hours equals ± 5000 readings
Charging time	± 3 – 4 hours
Charger	230/110V AC – 12V DC > 1A
Accessories	Battery charger 230/110V AC – 12V DC, USB cable, Software package, User manuals



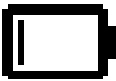

Appendix B Display Icons

In the header the battery status and the connection is displayed. The table below shows the meaning of the battery icons.

Icon	Function	Description
	Battery capacity	(100%.. 0%) , no charger connected
	Battery charge*	Charger is continuing with normal charge.

**) If the temperature of the batteries is too low or too high, the charger stops charging temporarily until the right temperature is reached. The charger remains in fast charge mode until it detects the full status. Then a period of normal charging is done to achieve the maximum capacity.*

The table below shows the meaning of the communication icons:

Icon	Function	Description
	Scanning is turned on	Scan button has been pressed.
	USB cable connected	USB cable connected
	USB cable connected and communication	USB cable connected and communication is established with the IDnote application.
	Bluetooth paired with host	A host has paired the IDnote device using Bluetooth.
	Bluetooth paired with host and communication	A host has paired the IDnote device using Bluetooth and communication is established with IDnote application.

For a Bluetooth connection the IDnote device must be paired. Appendix D explains how to pair a Bluetooth device using the PC.

Appendix C Setup a Bluetooth connection

The IDnote Application only communicates with serial COM Ports. The USB connection automatically generates a COM Port on the PC by the installed drivers. These drivers come along with the IDnote Application



The Bluetooth COM-Port driver software is not included in IDnote Application installation software. This driver software is dependent on the manufacturer of your Bluetooth Device.



*Make sure that Bluetooth is switched on in the IDnote. **Settings > System menu***

Before the IDnote can be connected to the PC using Bluetooth, the “Bluetooth Serial Port” must be installed on the PC. Follow up next steps to setup the “Bluetooth serial Port” .

1. Right mouse button click on the icon in the system tray. Select *Advanced Configuration*.

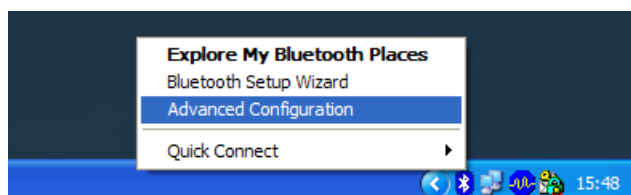

2. Open the tab “*Local Services*”. If no Bluetooth Serial Port is listed, click *Add Serial Device*. If a Bluetooth Serial Port is listed, start with **step 5**.

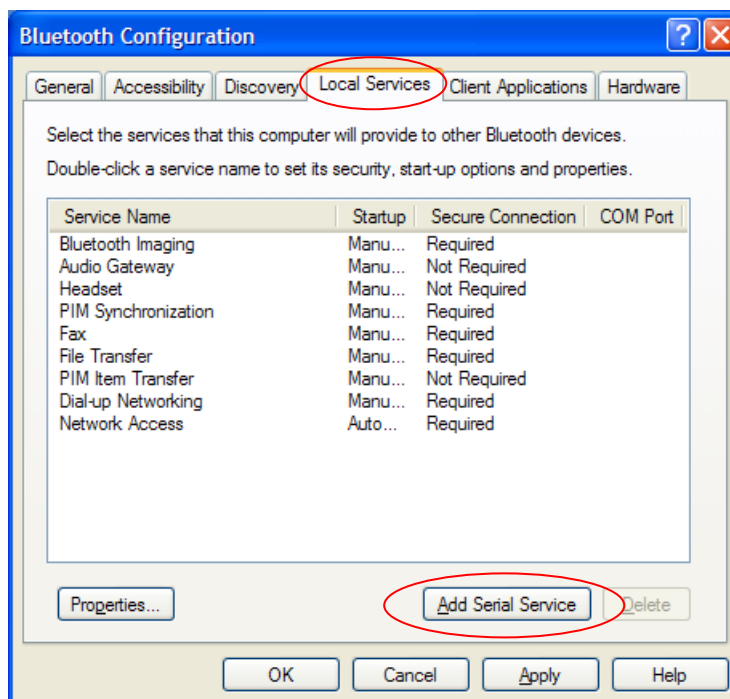

3. Select the *COM Port* and setup *Startup Automatically*. Click *OK* to save the setup.

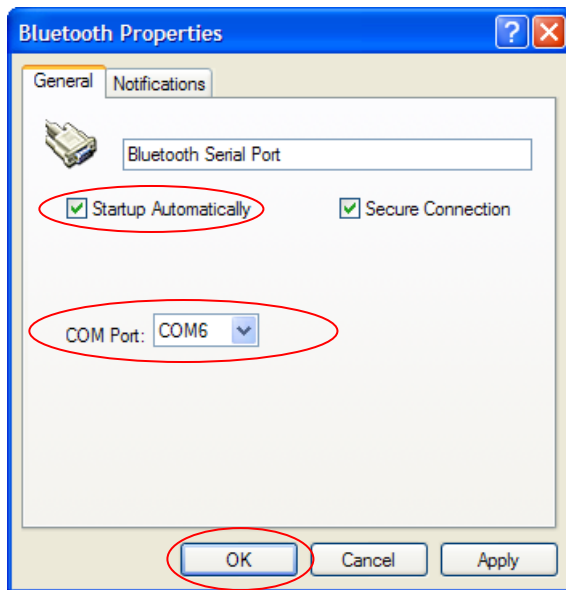

4. Now the Bluetooth Serial Port (COM 6) is setup, Click *OK*

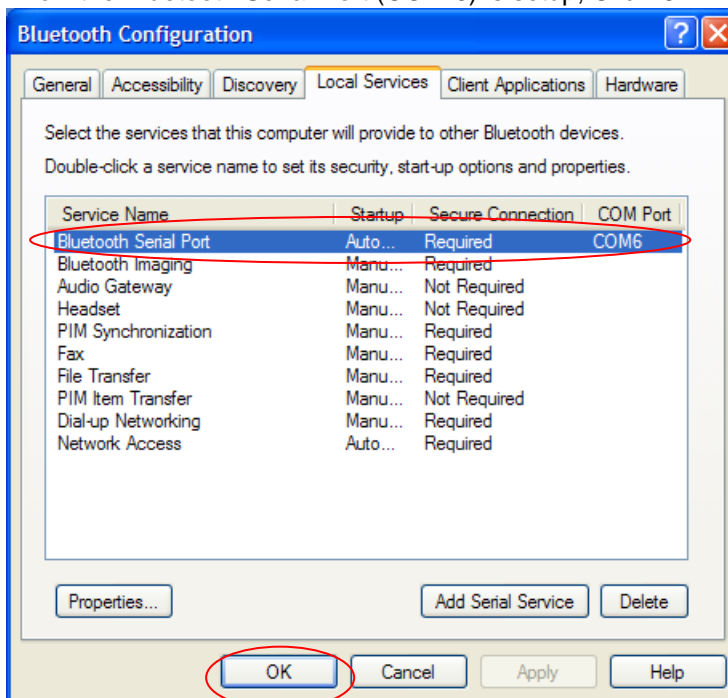

5. Switch on the IDnote.
6. Right mouse button click on the icon in the system tray. Select *Find devices*.

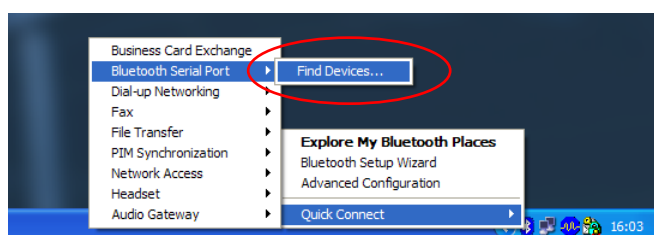

- Click on the *Refresh* button. “IDnote xx” will appear in the list. The IDnote number is the last number of the IDnote’s serial number. Select the correct IDnote and click *Connect*.

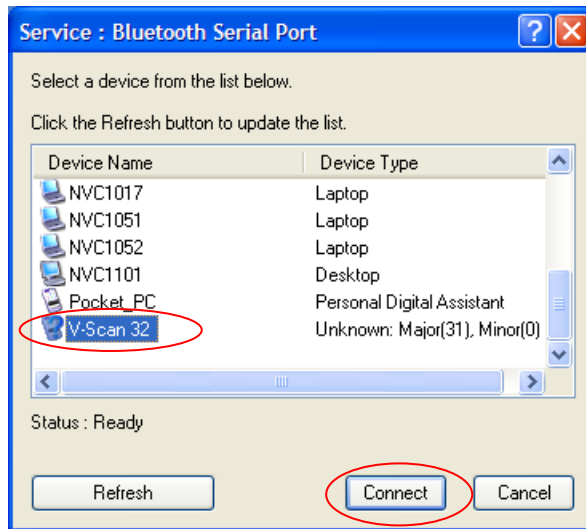

- The PC starts to make a connection with the IDnote (“pairing this IDnote”). A pop-up balloon may appear in the right bottom corner of the screen. Click on the balloon.

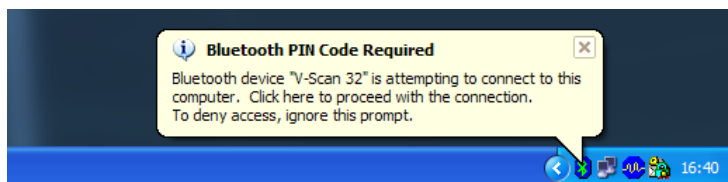

- Enter the PIN code “0000”(four zeros) and press *OK*.

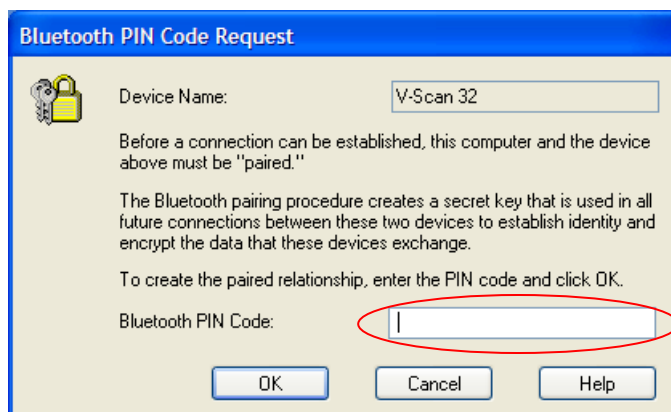

- Next screen appears. The connection with the IDnote is made successfully. Click *OK*.

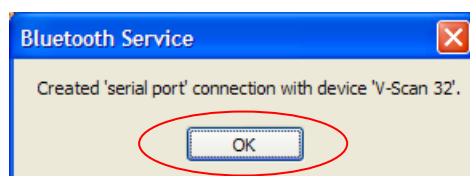

11. From now on the Bluetooth Serial Connection with the IDnote is set up.



When the IDnote switches off (automatically), the communication will be lost. It takes some time (> 5 seconds) before the IDnote Application gets the “no connection signal” from the Bluetooth Serial Port. Also when the IDnote is switched on again, it takes some time before the communication is established again.

After the setup, the Bluetooth connection will be established automatically. Steps to proceed:

1. Switch on the IDnote
2. Start the IDnote Data Manager / IDnote – Velos synchronisation application.
3. The connection will be established automatically.

Appendix A Declarations

Declaration of Conformity

We, the undersigned,

Company	N.V. Nederlandsche Apparatenfabriek "Nedap"
Address, City, country	Parallelweg 2, 7141 DC Groenlo, The Netherlands
Phone number/Fax number	+31 544 471 162/+31 544 463 475

certify and declare under our sole responsibility that the following equipment:

Product description / Intended use	Cattle Code hand held transmitter operating at 134.2 kHz
Manufacturer	N.V. Nederlandsche Apparatenfabriek "Nedap"
Brand	GEA
Models	VP5002 GEA and VP5004 GEA, BlueMod +B20/AI

is tested to and conforms with the essential requirements for protection of health and the safety of the user and any other person and Electromagnetic Compatibility, as included in following standards:

Standard	Issue date
EN 60950-1 and EN 60950-1/A11/A12	2006 and 2009/2010/2011
EN 62369-1 and EN 50364	Both 2010
EN 301 489-1V1.9.2 and -3 V1.4.1	2011 and 2002
NOTE: Immunity tested according to Industrial levels	

and is tested to and conforms with the essential radio test suites so that it effectively uses the frequency spectrum allocated to terrestrial/space radio communication and orbital resources so to as to avoid harmful interference, as included in following standards:

Standard	Issue date
EN 300 330-1 V1.7.1 and -2 V 1.5.1	Both 2010

and therefore complies with the essential requirements and provisions of the **Directive 1999/5/EC** of the European Parliament and of the council of March 9, 1999 on Radio equipment and Telecommunications Terminal Equipment and the mutual recognition of their conformity and with the provisions of Annex III (Conformity Assessment procedure referred to in article 10).

The following laboratories and institutions performed the tests and issued the relevant reports:

Report- or Declaration Numbers	Issued by
12062004.e01, 12062004.p01, 12062004.p02, 12062004.r01, 12062004.s01	TÜV Rheinland EPS, Eiberkamp 10, 9351 VT Leek, The Netherlands
031012.s01, 041012.01_HE	Nedap, Parallelweg 2, 7141 DE Groenlo, The Netherlands
Manual Hardware Reference BlueMod+B20/AI	Stollmann Entwicklungs-und Vertriebs GmbH, Mendelssohnstr. 15d, 22761, Hamburg, Germany

The technical documentation as required by the Conformity Assessment procedure is kept at the following address:

Company	N.V. Nederlandsche Apparatenfabriek "Nedap"
Address, City + Country	Parallelweg 2, 7141 DC Groenlo, The Netherlands
E-mail	Jacques.Hulshof@nedap.com
TF reference nr.	041012.03
Drawn up in	Groenlo, The Netherlands
Date	04 October 2012
Name and position	Jacques A.M. Hulshof, Approbation Management



