

NEEWER[®]

Q-C TTL Wireless Trigger

FCC Warning:

This equipment has been tested and found to comply with the limits for a Class B digital device, pursuant to part 15 of the FCC Rules. These limits are designed to provide reasonable protection against harmful interference in a residential installation. This equipment generates, uses and can radiate radio

frequency energy and, if not installed and used in accordance with the instructions, may cause harmful interference to radio communications. However, there is no guarantee that interference will not occur in a particular installation. If this equipment does cause harmful interference to radio or television reception, which can be determined by turning the equipment off and on, the user is encouraged to try to correct the interference by one or more of the following measures:

- Reorient or relocate the receiving antenna.
- Increase the separation between the equipment and receiver.
- Connect the equipment into an outlet on a circuit different from that to which the receiver is connected.
- Consult the dealer or an experienced radio/TV technician for help.

Caution: Any changes or modifications to this device not explicitly approved by manufacturer could void your authority to operate this equipment.

This device complies with part 15 of the FCC Rules. Operation is subject to the following two conditions: (1) This device may not cause harmful interference, and (2) this device must accept any interference received, including interference that may cause undesired operation.

The device has been evaluated to meet general RF exposure requirement. The device can be used in portable exposure condition without restriction.

About This Manual

Thank you for purchasing the **NEEWER**® Q-C TTL Wireless Trigger.
The manual will cover the following:

- | the basic operation procedures and functions of the Wireless Trigger.
- | the application environment and safety use of the Wireless Trigger.
- | the installation of the accessories of the Wireless Trigger.

Table of Contents

1.Package Contents	1
2.Compatible Device	2
3.Nomenclature	3
4.Power Supply Mode	6
5.Mode	7
6.Set-up Procedures	13
7.Safety Notes	14
8.Caution	15
9.Maintenance	15
10.Product Parameters	16
11.Warranty Policy	17
12.Trademark and Statement	18
13.Contact Us	18

1.Package Contents

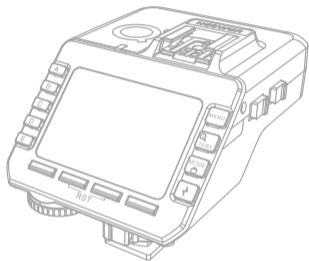

Upon receiving the package, please check whether all the products are included. If there are any missing or broken products, please contact Neewer Customer Service (support@neewer.com).

Accessories



Screw Adapter

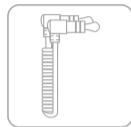

Sync Cable



Hot Shoe Stand



Manual

2.Compatible Device



Camera



On-camera Flash

3.Nomenclature

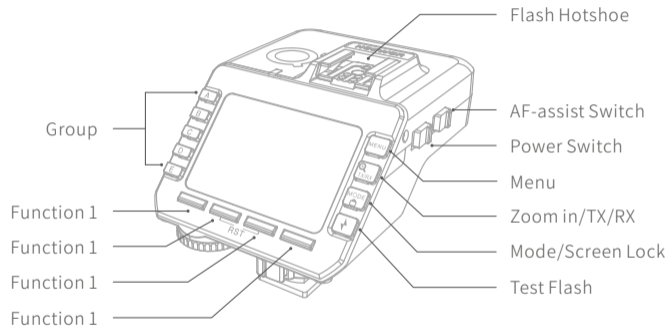

You can press the Function 2 and Function 3 button together for three seconds to restore the trigger to default settings.

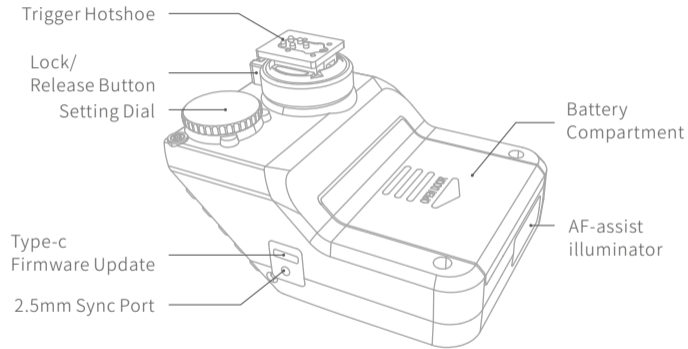

Display

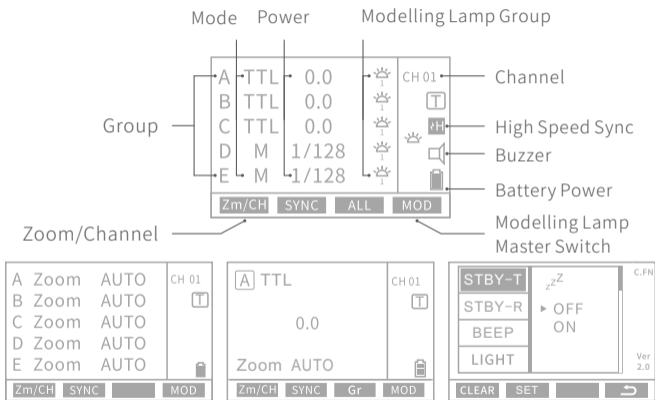

4. Power Supply Mode

by AA Battery

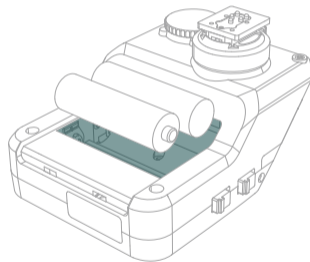

5.Mode

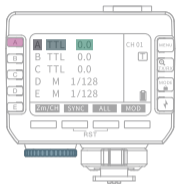

Exposure Compensation Setting

In this mode, the trigger can adjust the flash output between -3 and +3 in 1/3 stop increments. At the level of 0, there will be no exposure compensation. Choose a specific group and rotate the Setting Dial to change the compensation level: -3.0、-2.7.....0.0.....+3.0、+2.7....

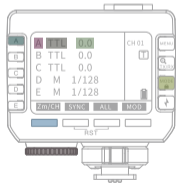

Mode Switch

Choose one group (demo: Group A) and press the “” button to switch mode in the following order: TTL→M→OFF.



Group Display

When on multiple group display, the trigger will switch to single group display when you quick press the “” button. It will switch back to the multiple group display if you press the button again.

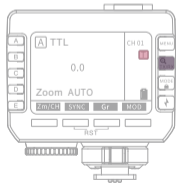

As Transmitter or Receiver

The trigger will work as transmitter when you press the “” button for three seconds until the symbol “T” appears on the display. It will turn into a receiver if you press the button again for 3 seconds until the “R” letter shows on the display.

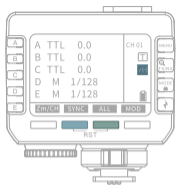

Restore Default Setting/High Speed Sync

The trigger will restore to default settings when the Function 2 and Function 3 button are pressed together for three seconds. To activate the HSS function, please adjust to main menu page and press the Function 2 button until the “H” symbol appears on the display.

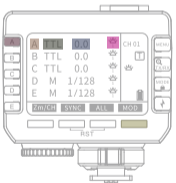

Modelling Lamp Control

When no specific group is chosen, the trigger can turn on/off all modelling lamps when you quick press the “Function 4” button. When controlling a specific group of lights, please quick press the “Function 4” button to change their light intensity from Level 1 to Level 6. (The modelling lamps within the group can all be turned off by pressing the Function 4 button for 3 seconds.)

⚠ The light intensity level only fits that of Q5 TTL strobe light.

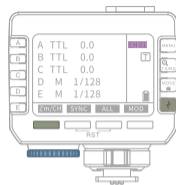

Channel/Test Flash

Press the “Function 1” button for 3 seconds. Then you can rotate the Setting Dial to choose a suitable channel. The trigger can make a flashlight fire test flash when you press the “↕” button.

The trigger features 32 channels, available for switch from Channel 01 to Channel 32. Please make sure that the transmitting and receiving devices are on the same channel.

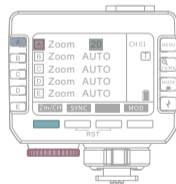

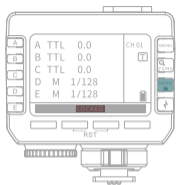

Zoom Setting

Quick press the “Function 1” button. Then choose a specific group and rotate the Setting Dial to change zoom settings: auto/20-200mm. To exit the Zoom Setting page, please quick press the “Function 1” button again.



Screen Lock

Press the “” button for 3 seconds until the word “LOCKED” appears on the display, which suggests that all buttons have been deactivated (except for the test flash button “”). To unlock it, please press the “” button for 3 seconds until the word “LOCKED” disappears on the display.



Standby Mode

The trigger display will turn off if no operations are performed for 90 seconds. To activate the display, press any button on the trigger.

If mounted on the hotshoe of a camera, the trigger can be activated by pressing the camera's shutter release button halfway.

Custom Settings

Custom Symbol	Function	Option	Description
SRBY-T	Standby Timer	ON	On
		OFF	Off
SRBY-R	Standby Timer	30min	will turn off when no operations are performed for 30 minutes.
		1H	will turn off when no operations are performed for 1 hour.
		2H	will turn off when no operations are performed for 2 hour.
BEEP	Buzzer	ON	On
		OFF	Off
LIGHT	Backlight Timer	12sec	will turn off when no operations are performed for 12 seconds.
		OFF	Always off
		ON	Always on
SYNC	Sync Port	IN	fire Q3 flash
		OUT	trigger signal input
LCD	LCD Contrast	-3-+3	between -3 and 3
ID	WIFI ID	OFF	Off
		01-29	available from 01 to 99

6. Set-up Procedures

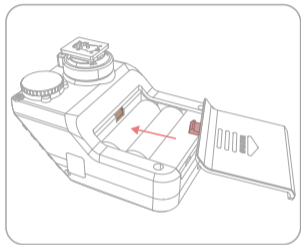

Insert AA batteries in the battery compartment and latch the cover.

- ⚠ Please heed the positive or negative polarity when inserting the batteries. If they are wrongly placed, the trigger wouldn't turn on.

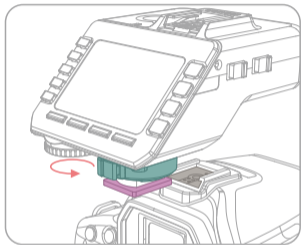

Attach the trigger hotshoe to your camera's coldshoe. Then, turn the knob in the picture above clockwise until it is tightened.

7. Safety Notes



- ⚠ Please do not use the light in the rain or in a humid environment.

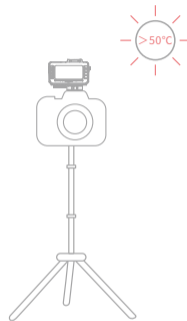

- ⚠ Please avoid using the product where it will be exposed to higher temperatures than 50 degrees Celsius.

8. Caution

- Please don't disassemble or modify the product unless professionally certified. Otherwise there might be risk of malfunction.
- Please keep the product dry and avoid touching it with wet hands.
- Please don't use the trigger near flammable or explosive items.
- Please avoid disposing of battery in a fire or keeping it near fire source.
- Should there be malfunction of the trigger, please turn it off immediately and try to identify the possible cause.
- Please avoid using new and old batteries together or different types of battery.
- Please don't short circuit or dismantle batteries

9. Maintenance

- Soft cloth is recommended to clean the trigger screen.
- Please remove the batteries when the trigger is left unused for a long period of time.
- The trigger should be kept in a dry and well-ventilated environment.
- Please avoid using the trigger in close proximity to magnetic devices and strong electrostatic field, such as radio transmitter, otherwise the trigger might malfunction.

10. Product Parameters

Model	Q-C
Signal Transmission Distance	0-100m
Built-in WIFI	2.4 GHz
Modulation	MSK
Channel	32
WIFI ID	01-99
Group	5
2.5mm Sync Port	A receiver device can control camera shooting with a 2.5mm sync cable.
TX/RX	master/slave mode switch
Firmware Update	via the Type-C USB interface on the trigger
Power Supply	AA battery
Dimension	105*75*64MM
Net Weight	about 120 grams

11.Warranty Policy

Warranty Period

You can register your NEEWER® product for its free 1-year warranty at www.neewer.com.Thanks!

Your questions or suggestion are highly valued and appreciated. Please feel free to contact us, and we will do our best to fully satisfy you.

E-MAIL:support@neewer.com

Reminder: Please keep the package box for at least 15 days because it is necessary to use the package box to protect the product during transportation.

Warranty Restrictions

The following conditions are NOT covered by the NEEWER® Warranty:

- (1)The product has expired the one-year warranty period;
- (2)The product is malfunctioned or damaged because the user did not follow the Wireless Trigger to use, adjust, or operate the product;
- (3)The product is malfunctioned or damaged due to rain, hailstorm, fumigation, medicine, chemicals or natural wastage; and due to force majeure (include but not limited to earthquake, Typhoon, fire, flood, violent crime);
- (4)The user modify, dismantle, repair the product and its parts without permission;
- (5)The user damaged the parts of Wireless Trigger by using non-original accessories, or changed the circuit, line configuration without permission;
- (6)The product is malfunctioned or damaged by collision or fall-off due to the user;

(7)Warranty Card, After-sale Service Card, invoice or item No does not conform to the product;

(8)An user changes the warranty service date of the product and its parts without permission;

(9)The panel and main parts are beyond maintenance range; The security label on the product is missing or damaged;

(10)The Wireless Trigger is used as a commercial product;

12.Trademark and Statement

NEEWER® is a registered trademark of **NEEWER®** Technology Company, Ltd, which is protected by law. **NEEWER®** company reserves all rights for this trademark.

NEEWER® has continuously devoted itself to developing and improving photography and music products. We hold it our mission to pursue excellence and improve customer experience.

The actual product may differ from the picture in this manual in color and appearance.

13.Contact Us

Your questions or suggestion are highly valued and appreciated. Please feel free to contact us, and we will do our best to offer satisfying services for you.

E-MAIL: support@neewer.com WEB: www.neewer.com