

# NETGEAR®

---

## N300 Wireless Gigabit Router with USB Model JNR3210

### User Manual



350 East Plumeria Drive  
San Jose, CA 95134  
USA

December 2011  
202-14541-01  
v1.0

© 2011 NETGEAR, Inc. All rights reserved

No part of this publication may be reproduced, transmitted, transcribed, stored in a retrieval system, or translated into any language in any form or by any means without the written permission of NETGEAR, Inc.

## Technical Support

Thank you for choosing NETGEAR. To register your product, get the latest product updates, get support online, or for more information about the topics covered in this manual, visit the Support website at <http://support.netgear.com>.

Phone (US & Canada only): 1-888-NETGEAR

Phone (Other Countries): Check the list of phone numbers at [http://support.netgear.com/app/answers/detail/a\\_id/984](http://support.netgear.com/app/answers/detail/a_id/984)

## Trademarks

NETGEAR, the NETGEAR logo, and Connect with Innovation are trademarks and/or registered trademarks of NETGEAR, Inc. and/or its subsidiaries in the United States and/or other countries. Information is subject to change without notice. Other brand and product names are trademarks or registered trademarks of their respective holders. © 2011 NETGEAR, Inc. All rights reserved.

## Statement of Conditions

To improve internal design, operational function, and/or reliability, NETGEAR reserves the right to make changes to the products described in this document without notice. NETGEAR does not assume any liability that may occur due to the use, or application of, the product(s) or circuit layout(s) described herein.

# Contents

## Chapter 1 Hardware Setup

Unpack Your Router . . . . .	7
Hardware Features . . . . .	7
Label . . . . .	7
Back Panel . . . . .	9
Position Your Router . . . . .	10
Cable Your Router . . . . .	11
Verify the Cabling . . . . .	14

## Chapter 2 Router Internet Setup

Router Setup Preparation . . . . .	16
Use Standard TCP/IP Properties for DHCP . . . . .	16
Replace an Existing Router . . . . .	16
Gather ISP Information . . . . .	16
Log In to the Router . . . . .	17
Upgrade Router Firmware . . . . .	18
Router Interface . . . . .	19
Select a Language for Your Screen Display . . . . .	20
Setup Wizard . . . . .	21
Manual Setup (Basic Settings) . . . . .	21
Basic Settings Screen . . . . .	22
Unsuccessful Internet Connection . . . . .	24
Change Password . . . . .	25
Log Out Manually . . . . .	26
Types of Logins . . . . .	26

## Chapter 3 Wireless Settings

Security Basics . . . . .	28
Turn Off Wireless Connectivity . . . . .	28
Disable SSID Broadcast . . . . .	28
Restrict Access by MAC Address . . . . .	28
Wireless Security Options . . . . .	29
Add Clients (Computers or Devices) to Your Network . . . . .	30
Manual Method . . . . .	30
Wi-Fi Protected Setup (WPS) Method . . . . .	30
Wireless Settings . . . . .	31
Consider Every Device on Your Network . . . . .	32
View or Change Wireless Settings . . . . .	32

Wireless Settings Screen Fields . . . . .	33
Set Up WPA-PSK and WPA2-PSK Wireless Security . . . . .	34
Set Up WEP Wireless Security . . . . .	35
Add Guest Networks . . . . .	36

## Chapter 4 Content Filtering

Live Parental Controls . . . . .	39
Keyword Blocking of HTTP Traffic . . . . .	39
Delete a Keyword or Domain . . . . .	40
Specify a Trusted Computer . . . . .	40
Block Outbound Traffic to Internet Services . . . . .	40
Block Services by IP Address Range . . . . .	42
Set the Time Zone . . . . .	42
Schedule Blocking . . . . .	43
Enable Security Event Email Notification . . . . .	44
View Logs of Web Access or Attempted Web Access . . . . .	45
Allow Inbound Connections to Your Network . . . . .	46
Port Forwarding to a Local Server . . . . .	47
Add a Custom Service . . . . .	48
Edit or Delete a Port Forwarding Entry . . . . .	49
Port Triggering . . . . .	50

## Chapter 5 Network Maintenance

Upgrade the Router Firmware . . . . .	54
Turn Off Automatic Firmware Checking . . . . .	54
Automatic Firmware Checking On . . . . .	55
Manually Check for Firmware Upgrades . . . . .	55
Manage the Configuration File . . . . .	56
Back Up . . . . .	56
Restore . . . . .	57
Erase . . . . .	57
View Router Status . . . . .	58
View Attached Devices . . . . .	61
Remote Management Access . . . . .	61

## Chapter 6 Advanced Settings

WAN Setup . . . . .	64
Set Up a Default DMZ Server . . . . .	65
Dynamic DNS . . . . .	65
LAN Setup . . . . .	67
LAN Setup Screen Fields . . . . .	68
Use the Router as a DHCP Server . . . . .	68
Reserved IP Addresses Setup . . . . .	69
Advanced Wireless Settings . . . . .	70
Restrict Wireless Access by MAC Address . . . . .	71
Set Up Static Routes . . . . .	73

Quality of Service . . . . .	74
WMM QoS for Wireless Multimedia Applications . . . . .	75
QoS for Internet Access . . . . .	75
Traffic Meter . . . . .	79
Universal Plug and Play . . . . .	80
Wireless Repeating (Also Called WDS) . . . . .	81
Wireless Repeating Function . . . . .	82
Set Up the Base Station . . . . .	82
Set Up a Repeater Unit. . . . .	83

**Chapter 7 Troubleshooting**

Quick Tips. . . . .	86
Troubleshooting Basic Functions . . . . .	86
Login Problems. . . . .	88
Check the Internet Service Connection . . . . .	89
Obtaining an Internet IP Address . . . . .	89
Troubleshooting PPPoE . . . . .	90
Troubleshooting Internet Browsing . . . . .	90
Troubleshoot Your Network Using the Ping Utility . . . . .	91
Test the LAN Path to Your Router . . . . .	91
Test the Path from Your Computer to a Remote Device . . . . .	92
Problems with Date and Time . . . . .	92
Problems with Wireless Adapter Connections . . . . .	93
Restore the Default Configuration and Password . . . . .	94

**Appendix A Supplemental Information**

Factory Default Settings . . . . .	96
Specifications . . . . .	97

**Appendix B Notification of Compliance**

**Index**

# Hardware Setup

---

# 1

## Getting to know your router

The NETGEAR N300 Wireless Gigabit Router with USB JNR3210 User Manual provides you with an easy and secure way to set up a wireless home network.

For more information on the topics covered in this manual, visit the Support website at <http://support.netgear.com>.

If you have not already set up your new router using the installation guide that comes in the box, this chapter walks you through the hardware setup. The next chapter explains how to set up your Internet connection.

This chapter contains the following sections:

- *Unpack Your Router*
- *Hardware Features*
- *Position Your Router*
- *Cable Your Router*
- *Verify the Cabling*

## Unpack Your Router

Your box should contain the following items:

- N300 Wireless Gigabit Router with USB Model JNR3210
- AC power adapter (plug varies by region)
- Category 5 (Cat 5) Ethernet cable
- Installation guide with cabling and router setup instructions

If any parts are incorrect, missing, or damaged, contact your NETGEAR dealer. Keep the carton and original packing materials, in case you need to return the product for repair.

## Hardware Features

Before you cable your router, take a moment to become familiar with the label and the front and back panels. Pay particular attention to the LEDs on the front panel.

### Label

The label on the bottom shows the router's MAC address, serial number, security PIN, and login information.

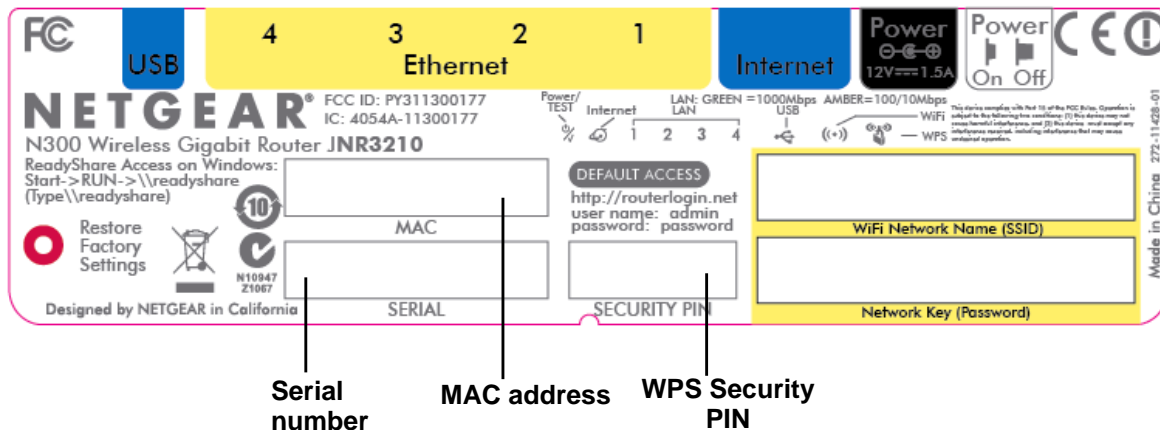

Figure 1. Label on router bottom

The router front panel has status LEDs and icons shown in the figure.

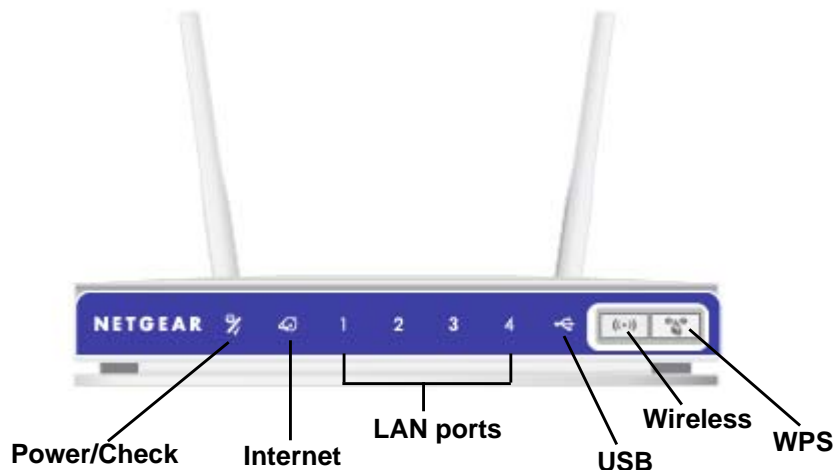





Figure 2. Front panel LEDs and icons

Table 1. Front Panel LEDs

Icon	LED Activity	Description
LAN ports 1–4	Solid green Blinking green Solid amber Blinking amber Off	The local port is connected to a 100 Mbps device. Data is being transmitted at 100 Mbps. The local port is connected to a 10 Mbps device. Data is being transmitted at 10 Mbps. No link is detected on this port.
Wireless 	Solid green Blinking green Off	The wireless interface is enabled. Data is being communicated over the wireless network. The wireless interface is turned off.
Internet (WAN) 	Solid green Blinking green Off	The router has acquired an Internet address. Data is being communicated with the Internet. No Ethernet cable is connected to the modem.
WPS 	Solid green Blinking green Off	Indicates a (WPS) connection to a WPS-capable device. WPS-capable device can associate with the router within 2 minutes. No WPS connection exists.
Power/ Check 	Solid green Fast blink green Slow blink green Off	The power is on and the router is ready. A software update is in progress. Performing basic power-on self-test diagnostic, or firmware is corrupted (see <a href="#">Troubleshooting Basic Functions</a> on page 86). Power is not being supplied to the router



## Back Panel

The back panel has the following features:

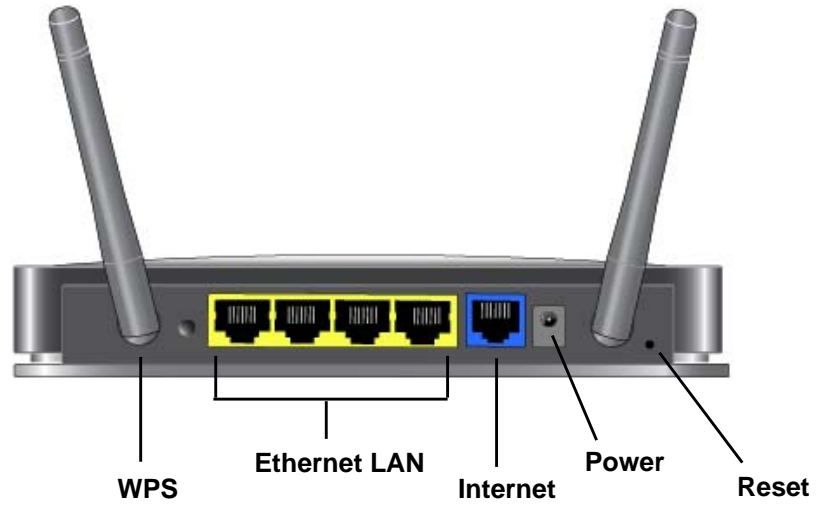

Figure 3. Back panel

## Position Your Router

The router lets you access your network from virtually anywhere within the operating range of your wireless network. However, the operating distance or range of your wireless connection can vary significantly depending on the physical placement of your router. For example, the thickness and number of walls the wireless signal passes through can limit the range. For best results, place your router:

- Near the center of the area where your computers and other devices operate, and preferably within line of sight to your wireless devices.
- So it is accessible to an AC power outlet and near Ethernet cables for wired computers.
- In an elevated location such as a high shelf, keeping the number of walls and ceilings between the router and your other devices to a minimum.
- Away from electrical devices that are potential sources of interference, such as ceiling fans, home security systems, microwaves, PCs, or the base of a cordless phone or 2.4 GHz cordless phone.
- Away from any large metal surfaces, such as a solid metal door or aluminum studs. Large expanses of other materials such as glass, insulated walls, fish tanks, mirrors, brick, and concrete can also affect your wireless signal.
- With the antennas in a vertical position to provide the best side-to-side coverage or in a horizontal position to provide the best up-and-down coverage, as applicable.

When you use multiple access points, it is better if adjacent access points use different radio frequency channels to reduce interference. The recommended channel spacing between adjacent access points is 5 channels (for example, use Channels 1 and 6, or 6 and 11).

## Cable Your Router

The installation guide that came in the box has a cabling diagram on the first page. This section walks you through cabling with detailed illustrations.

### To connect the router, the computer, and the modem:

1. Turn off and unplug your broadband modem.
2. Locate the cable (A) that connects your computer to the modem. Disconnect the cable at the modem end only (B). You will connect it to the router later.

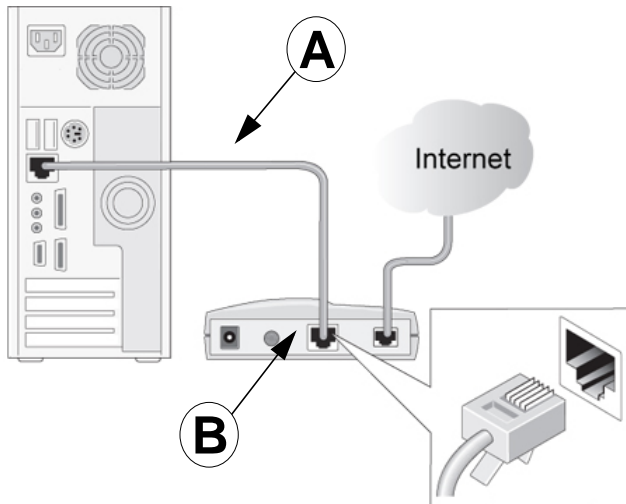

Figure 4. Disconnect the modem end of the Ethernet cable

3. Connect the blue Ethernet cable (C) that came with the router to the Internet (WAN) port (D) on the router, and to the Ethernet port on your broadband modem. The cable and the Internet port label are color coded.

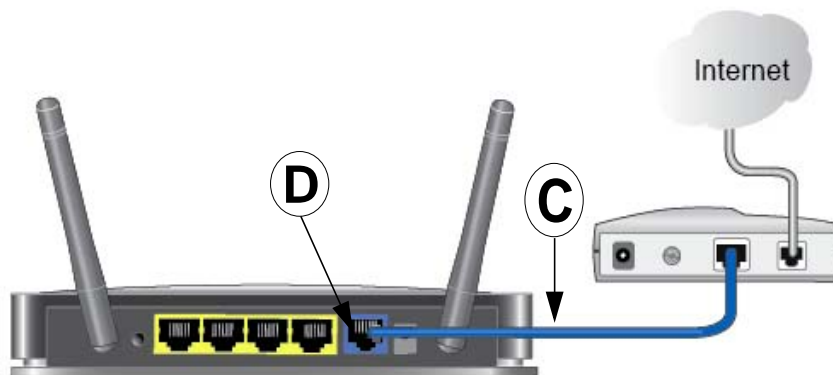
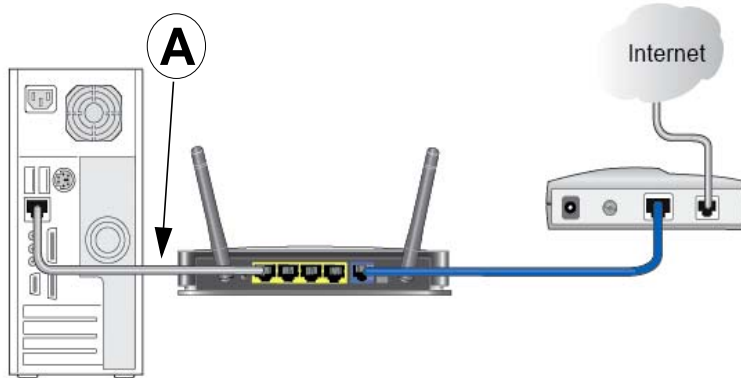

Figure 5. Use the Ethernet cable to connect the modem to the router

4. Locate the cable (A) that is still attached to your computer. Insert that cable into a yellow LAN port on the router, as shown in the following figure:



**Figure 6. Connect the Ethernet cable to a LAN port on the router**

5. Connect any additional wired PCs to your router by inserting an Ethernet cable from a PC into one of the three remaining LAN ports.
6. Start your network in the correct sequence, as described below.



**CAUTION:**

Failure to start or restart your network in the correct sequence could prevent you from accessing the Internet.

**To start your network:**

1. Plug in and turn on the cable or DSL modem. Wait 2 minutes.

2. Plug the power adapter into the AC power adapter input (labeled Power), and plug the other end into a power outlet. Press the **On/Off** button to turn on the router. Wait 2 minutes.

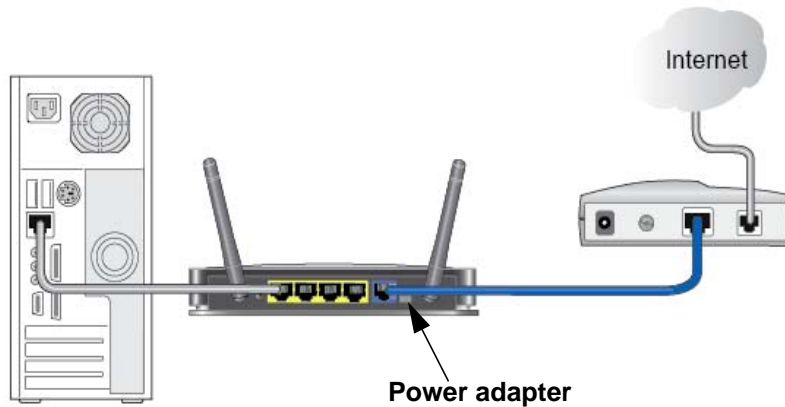

**Figure 7. Connect the power adapter cord and turn on the router**

It takes several minutes for your router to establish a connection with your computer and your Internet provider.

---

**Note:** For DSL customers, if software logs you in to the Internet, *do not* run that software. You might need to go to the Internet Explorer Tools menu, Internet Options, Connections tab and select “Never dial a connection.”

---

3. To set up your Internet connection:
  - a. In your browser address field, type **<http://www.routerlogin.net>** and click **Enter**.
  - b. When the Welcome screen opens, click **Next**. It will detect your type of Internet connection. Follow the prompts to complete your router Internet connection.
4. To set up wireless security:
  - a. First, assign a name to your wireless network. Choose a name (SSID) that is easy to remember. You might want to write it down in the area provided on the middle panel. (The default name is NETGEAR.) Click **Next**.
  - b. Select the **Yes** option to add security, then select your security method. NETGEAR recommends WPA-PSK [TKIP] + WPA2-PSK [AES].
  - c. Choose a Passphrase (for example, HomeNetwork). You might want to write it down in the area provided on the middle panel. Click **Next**.

---

**Note:** Both your network name (SSID and passphrase are case sensitive.

---

- d. Review your network settings on the Success page. You may want to print this for your records.
- e. Click **Next** to apply all settings.

## Verify the Cabling

Verify that your router is cabled correctly, is turned on, and is receiving power by checking the router LEDs. The following figure shows the LEDs.

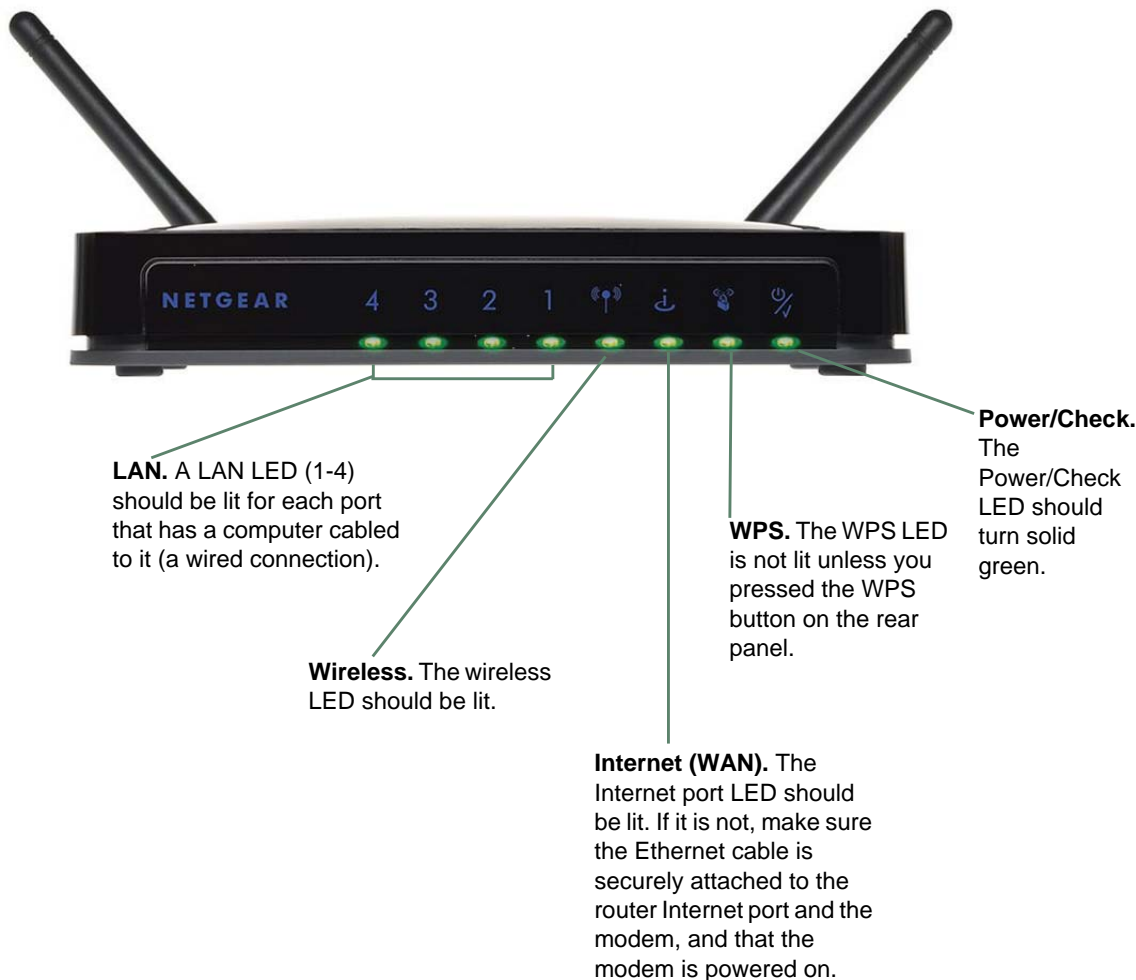

Figure 8. Check the LEDs

# 2 Router Internet Setup

---

# 2

## Connecting to the Internet

This chapter explains how to set up your Internet connection using one of three methods: NETGEAR Genie (recommended), Setup Wizard, or manual setup. If you have already set up your router using one of these methods, the initial router setup is complete. Refer to this chapter if you want to become familiar with the router menus, view or adjust the initial settings, or change the router password and login time-out.

This chapter contains the following sections:

- *Router Setup Preparation*
- *Log In to the Router*
- *Select a Language for Your Screen Display*
- *Router Interface*
- *Setup Wizard*
- *Manual Setup (Basic Settings)*
- *Unsuccessful Internet Connection*
- *Change Password*
- *Log Out Manually*
- *Types of Logins*

## Router Setup Preparation

You can set up your router with the Smart Wizard on the *Resource CD* as described in the installation guide with the Setup Wizard (see [Setup Wizard](#) on page 21), or manually (see [Manual Setup \(Basic Settings\)](#) on page 21). Before you start the setup process, you need to have your ISP information on hand and make sure the laptops, PCs, and other devices in the network have the settings described here.

### Use Standard TCP/IP Properties for DHCP

If you configured your computer to use a static IP address, you need to change the settings back so that it uses Dynamic Host Configuration Protocol (DHCP). See [Appendix A, Supplemental Information](#) for more information.

### Replace an Existing Router

To replace an existing router, disconnect it completely from your network and set it aside before starting the router setup.

### Gather ISP Information

You need the following information to set up your router and to check that your Internet configuration is correct. Your Internet Service Provider (ISP) should have provided you with all of the information needed to connect to the Internet. If you cannot locate this information, ask your ISP to provide it. When your Internet connection is working, you no longer need to launch the ISP's login program on your computer to access the Internet. When you start an Internet application, your router automatically logs you in.

- Active Internet service provided by a DSL account
- The ISP configuration information for your DSL account
  - ISP login name and password
  - ISP Domain Name Server (DNS) addresses
  - Fixed or static IP address
  - Host and domain names
  - Depending on how your ISP set up your Internet account, you could need to know one or more of these settings for a manual setup:
    - Virtual path identifier (VPI) and virtual channel identifier (VCI) parameters
    - Multiplexing method
    - Host and domain names



## Log In to the Router

Log in to the router to view or change settings or to set up the router.

1. In your browser address field, type **http://www.routerlogin.net** and click **Enter**.



2. When prompted, enter **admin** for the router user name and **password** for the router password, both in lowercase letters.

**Note:** The router user name and password are probably different from the user name and password for logging in to your Internet connection. See [Types of Logins](#) on page 26 for more information.

The router menus display where you can do things like change settings or add other devices to your network. See [Router Interface](#) on page 19 for a brief description of the available functionality, and [Wi-Fi Protected Setup \(WPS\) Method](#) on page 30 or information about adding devices to your network.

If you do not see the login prompt:

- Check the LEDs on the router front panel to make sure that the modem router is plugged into an electrical outlet, its power is on, and the Ethernet cable between your computer and the router is connected to a LAN port.
- If you connected the Ethernet cable and quickly launched your browser and typed in the router URL, your computer might need a minute or two to recognize the LAN connection. Relaunch your browser and try again.
- If you are having trouble accessing the router wirelessly, NETGEAR recommends that during setup you use an Ethernet cable to connect your computer so that you can log in to the router.

If you cannot connect to the wireless router, check the Internet Protocol (TCP/IP) properties in the Network Connections section of your PC Control Panel. They should be set to obtain both IP and DNS server addresses automatically.

3. When the Welcome screen opens, click **Next**. It will detect your type of Internet connection. Follow the prompts to complete your Internet connection.

## Upgrade Router Firmware

When you log in and if you are connected to the Internet, the Firmware Upgrade Assistant screen displays so you can upgrade to the latest available firmware. See [Chapter 5, Network Maintenance](#) for more information about upgrading firmware.

1. Click **Yes** to check for new firmware (recommended). The modem router checks the NETGEAR database for new firmware.
2. If no new firmware is available, click **No** to exit. You can check for new firmware later.
3. If new firmware is available, click **Yes** to upgrade the router with the latest firmware. After the upgrade, the router restarts.



### CAUTION:

Do not try to go online, turn off the router, shut down the computer, or do anything else to the router until the router finishes restarting and the Power/Check LED has stopped blinking for several seconds.

You cannot upgrade firmware until you have established your Internet connection as described in [Setup Wizard](#) on page 21.

## Router Interface

The router interface gives you access to the router's current settings so you can view or change them (if needed). The left column has the router menus, and the right column provides online help. The middle column is the screen for the current menu option.

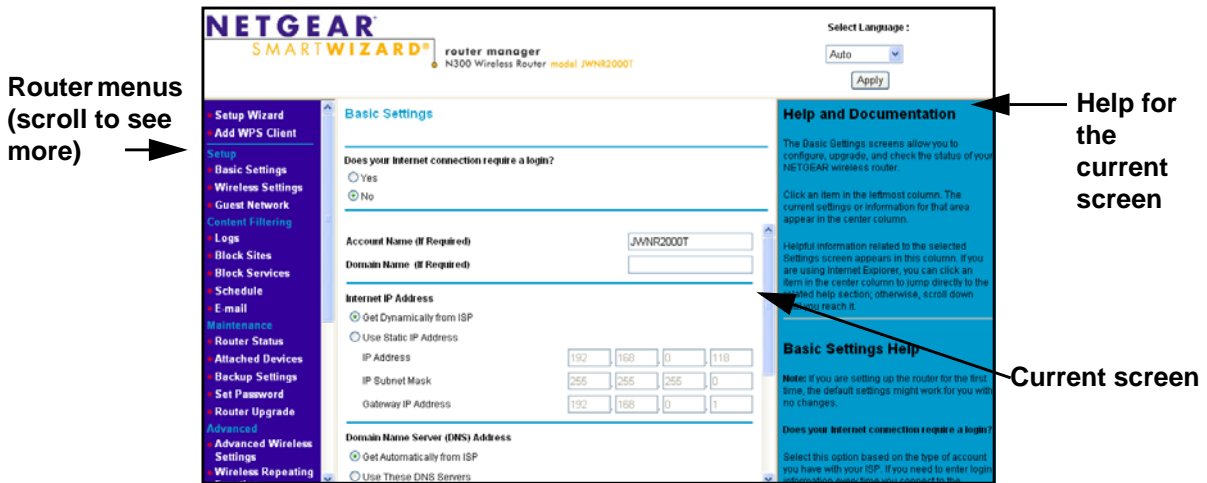
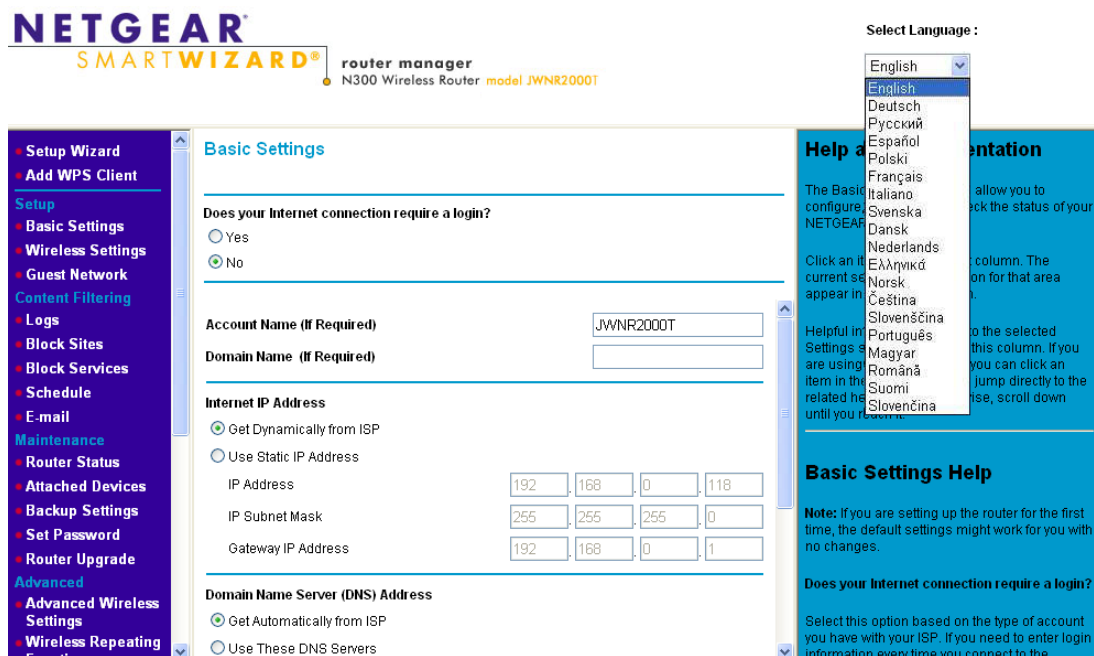

Figure 1. Router menus, Basic Settings screen, and online help

- **Setup Wizard.** Specify the language, location, and automatically detect the Internet connection.
- **Add WPS Client.** Add WPS-compatible wireless devices and other equipment to your wireless network.
- **Setup Menu.** Set, upgrade, and check the ISP and wireless network settings of your router.
- **Content Filtering Menu.** View and configure the router firewall settings to prevent objectionable content from reaching your PCs.
- **Maintenance Menu.** Administer and maintain your router and network.
- **Advanced Menu.** Set the router up for unique situations such as when remote access by IP or by domain name from the Internet is needed.
- **Web Support.** Go to the NETGEAR support site to get information, help, and product documentation. These links work once you have an Internet connection.

## Select a Language for Your Screen Display

Using the Select Language drop-down menu, located in the upper right corner of the Router Manager screen, you can display the router manager screens in any of languages shown in Figure 2.



**Figure 2. Select a Language**

The language is set to English by default. The default language, as well as German, Russian, and Portuguese are always stored in memory. When you select a language other than those automatically stored in flash memory, if you are connected to the Internet at the time you select it, that language is also stored in memory.

- If you are connected to the Internet and select a language that is not already stored in flash memory, the language is downloaded from the NETGEAR server and stored in the current language partition of flash memory.
- If you are not connected to the Internet when you select a language, you can only select as the current language one of the languages that is stored in flash memory.

To specify a language to be used on your router manager screens, do the following:

1. Expand the list and select the language you want.
2. Click **Apply**.

The language you select is then downloaded and displayed in the language selection box, and your screen display will be in the selected language.

---

**Note:** If you are not connected to the Internet and select a language that is not stored in flash memory, your selection may fail. If you see a “download fails” message after your language selection, make sure you are connected to the Internet and make your selection.

---

## Setup Wizard

If you do not use the Smart Wizard on the *Resource CD*, you have to log in to the router to set the country, language, and Internet connection.

---

**Note:** If you performed the NETGEAR Genie setup, the country, language, Internet, and wireless network settings are already configured.

---

1. Select **Setup Wizard** from the top of the router menus.
2. Select either **Yes** or **No, I want to configure the Router myself**. If you select No, proceed to *Manual Setup (Basic Settings)* on page 21.
3. If you selected Yes, click **Next**.

With automatic Internet detection, the Setup Wizard searches your Internet connection for servers and protocols to determine your ISP configuration.

## Manual Setup (Basic Settings)

The Basic Settings screen displays when you select No. I want to configure the Router myself in the Setup Wizard and is also available from the router menus. It is where you view or change ISP information. The fields that display vary depending on whether or not your Internet connection requires a login.

1. Select **Set Up > Basic Settings** and select **Yes** or **No** depending on whether or not your ISP requires a login. *Figure 3, Basic Settings screen without (left) and with (right) login.* shows both forms of the Basic Settings screen.
  - **Yes.** Select the encapsulation method and enter the login name. If you want to change the login time-out, enter a new value in minutes.
  - **No.** Enter the account and domain names, as needed.
2. Enter the settings for the IP address and DNS server.
3. If no login is required, you can specify the MAC Address setting.
4. Click **Apply** to save your settings.
5. Click **Test** to test your Internet connection. If the NETGEAR website does not appear within 1 minute, see *Troubleshooting* on page 85.

## Basic Settings Screen

**ISP does not require login**

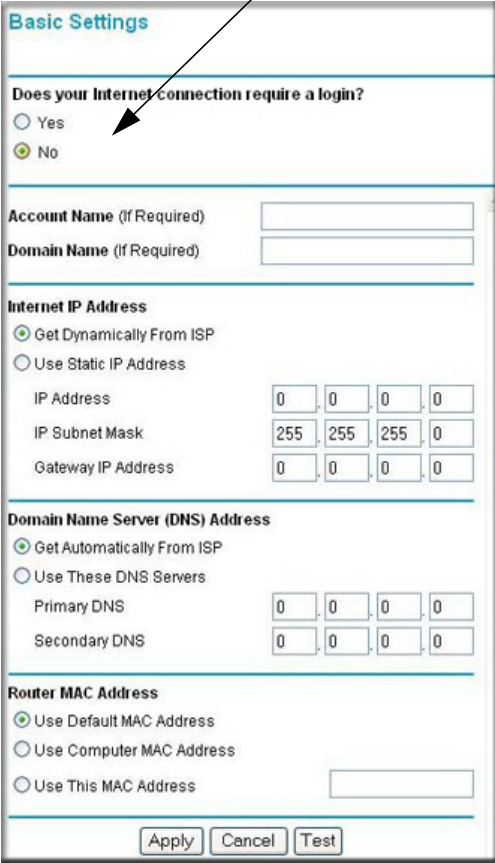

**ISP does require login**

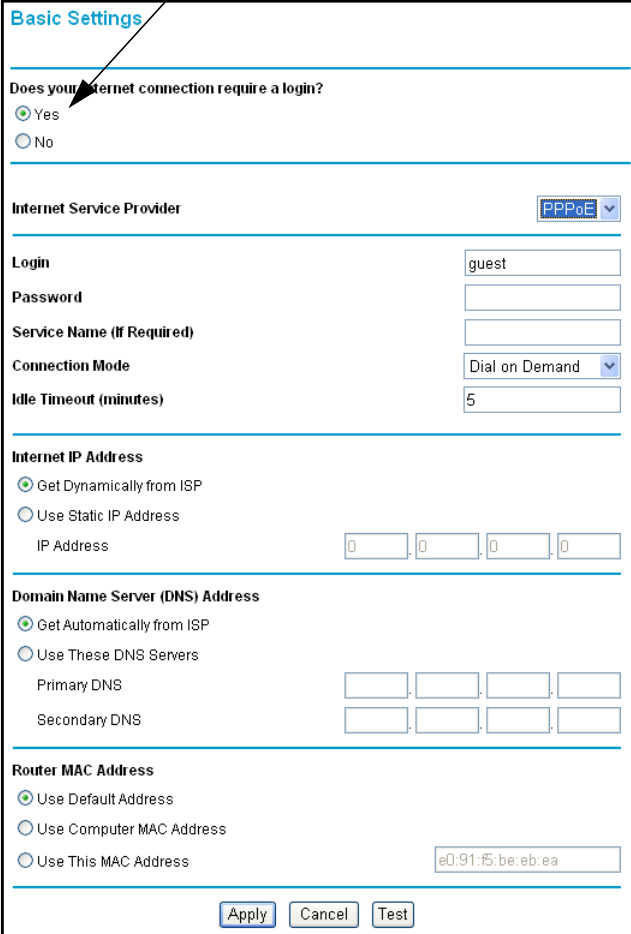

**Figure 3. Basic Settings screen without (left) and with (right) login.**

The following descriptions explain all the possible fields in the Basic Settings screen. Note that which fields appear in this screen depends on whether or not an ISP login is required.

**Does Your ISP Require a Login?** Answer either yes or no.

- *When no login is required, these fields display:*

**Account Name (If required).** Enter the account name provided by your ISP. This might also be called the host name.

**Domain Name (If required).** Enter the domain name provided by your ISP.

- *When your ISP requires a login, these fields display:*

**Internet Service Provider.** This drop-down list contains a few ISPs that need special protocols for connection.

The screenshot shows a configuration form with the following elements:

- Internet Service Provider:** A drop-down menu with a blue arrow pointing down. The menu is open, showing four options: PPPoE, PPTP, PPPoE (highlighted in blue), and L2TP.
- Login:** A text input field containing the text "guest".
- Password:** An empty text input field.

The list includes:

- **PPTP** (Point to Point Tunneling Protocol), used primarily in Austrian DSL services.
- **PPPoE** (Point to Point Protocol over Ethernet), the protocol used by most DSL services worldwide.
- **L2TP** (Layer 2 Tunneling Protocol), used to support virtual private networks (VPNs).

**Login.** The login name provided by your ISP. This is often an email address.

**Password.** The password that you use to log in to your ISP.

**Service Name.** If your connection is capable of connecting to multiple Internet services, this setting specifies which service to use.

**Connection Mode.** You can use this drop-down list to select when the router connects to and disconnect from the Internet.

The screenshot shows a configuration form with the following elements:

- Connection Mode:** A drop-down menu with a blue arrow pointing down. The menu is open, showing four options: Dial on Demand, Always On, Dial on Demand (highlighted in blue), and Manually Connect.
- Idle Timeout (In minutes):** A text input field.
- Internet IP Address:** A text input field.

The list includes:

- **Always On.** The router logs in to the Internet immediately after booting and never disconnects.
- **Dial on Demand.** The router logs in only when outgoing traffic is present and logs out after the idle time-out.
- **Manually Connect.** The router logs in or logs out only when the user clicks **Connect** or **Disconnect** in the Router Status screen.

**Idle Timeout (In minutes).** If you want to change the login timeout, enter a new value in minutes. This determines how long the router keeps the Internet connection active after there is no Internet activity from the LAN. Entering a value of 0 (zero) means never log out.

### Internet IP Address

- *When a login is required, these fields display:*

**Get Dynamically from ISP.** Your ISP uses DHCP to assign your IP address. Your ISP automatically assigns these addresses.

**Use Static IP Address.** Enter the IP address, IP subnet mask, and the gateway IP address that your ISP assigned. The gateway is the ISP's router to which your router will connect.

- *When a login is not required, this field displays:*

**Use IP Over ATM (IPoA).** Your ISP uses classical IP addresses (RFC 1577). Enter the IP address, IP subnet mask, and gateway IP addresses that your ISP assigned.

**Domain Name Server (DNS) Address.** The DNS server is used to look up site addresses based on their names.

**Get Automatically from ISP.** Your ISP uses DHCP to assign your DNS servers. Your ISP automatically assigns this address.

**Use These DNS Servers.** If you know that your ISP does not automatically transmit DNS addresses to the router during login, select this option, and enter the IP address of your ISP's primary DNS server. If a secondary DNS server address is available, enter it also.

**NAT (Network Address Translation).** NAT automatically assigns private IP addresses (10.1.1.x) to LAN-connected devices.

**Enable.** Usually NAT is enabled.

**Disable.** This disables NAT, but leaves the firewall active. Disable NAT only if you are sure you do not need it. When NAT is disabled, only standard routing is performed by this router. Classical routing lets you directly manage the IP addresses that the router uses. Classical routing should be selected only by experienced users.<sup>1</sup>

**Disable firewall.** This disables the firewall in addition to disabling NAT. With the firewall disabled, the protections usually provided to your network are disabled.

*When no login is required, this field displays:*

**Router MAC Address.** The Ethernet MAC address used by the router on the Internet port. Some ISPs register the MAC address of the network interface card in your computer when your account is first opened. They will then accept traffic only from the MAC address of that computer. This feature allows your router to use your computer's MAC address (this is also called cloning).

**Use Default Address.** Use the default MAC address.

**Use Computer MAC Address.** The router captures and uses the MAC address of the computer that you are now using. This has to be the computer that is allowed by the ISP.

**Use This MAC Address.** Enter the MAC address that you want to use.

## Unsuccessful Internet Connection

1. Review your settings to be sure you have selected the correct options and typed everything correctly.

---

1. Disabling NAT reboots the router and resets its settings to the factory defaults. Disable NAT only if you plan to set up the router in a setting where you will be manually administering the IP address space on the LAN side of the router.



2. Contact your ISP to verify that you have the correct configuration information.
3. Read [Chapter 7, Troubleshooting](#). If problems persist, register your NETGEAR product and contact NETGEAR Technical Support.

---

**Note:** If you cannot connect to the wireless router, check the Internet Protocol (TCP/IP) properties in the Network Connections section of your PC Control Panel. They should be set to obtain *both* IP and DNS server addresses automatically.

---

## Change Password

For security reasons, the router has its own user name and password that default to **admin** and **password**. You can and should change these to a secure user name and password that are easy to remember. The ideal password contains no dictionary words from any language and is a mixture of upper case and lower case letters, numbers, and symbols. It can be up to 30 characters.

---

**Note:** The router user name and password are not the same as the user name and password for logging in to your Internet connection. See [Types of Logins](#) on page 26 for more information about login types.

---

1. Select **Maintenance > Set Password** to display the following screen:.

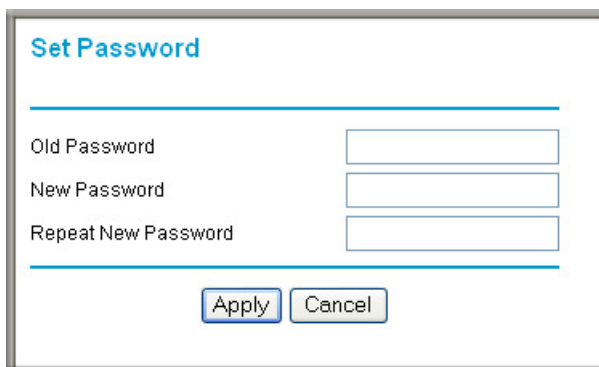
The screenshot shows a web browser window titled "Set Password". It contains three text input fields: "Old Password", "New Password", and "Repeat New Password". Below the fields are two buttons: "Apply" and "Cancel".

2. Enter the old password.
3. Enter the new password twice.
4. Click **Apply** to save your changes.

After changing the password, you are required to log in again to continue the configuration. If you have backed up the router settings previously, you should do a new backup so that the saved settings file includes the new password. See [Back Up](#) on page 56 for information about backing up your network configuration.

## Log Out Manually

The router interface provides a Logout command at the bottom of the router menus. Log out when you expect to be away from your computer for a relatively long period of time.

## Types of Logins

There are three separate types of logins that have different purposes. It is important that you understand the difference so that you know which login to use when.

- **Router login** logs you in to the router interface. See [Log In to the Router](#) on page 17 for details about this login.
- **ISP login** logs you in to your Internet service. Your service provider has provided you with this login information in a letter or some other way. If you cannot find this login information, contact your service provider.
- **Wi-Fi network name and passphrase** logs you in to your wireless network. See [Chapter 3, Wireless Settings](#) for more information.

# 3 Wireless Settings

---

# 3

## Protecting your network

This chapter describes how to use the Wireless Settings screens to view and change (if needed) your wireless network settings. Security features to prevent objectionable content from reaching your PCs are covered in [Chapter 4, Content Filtering](#).

This chapter includes the following sections:

- [Security Basics](#)
- [Add Clients \(Computers or Devices\) to Your Network Wireless Settings](#)
- [Wireless Settings](#)
- [Add Guest Networks](#)

## Security Basics

Unlike wired network data, wireless data transmissions extend beyond your walls and can be received by any device with a compatible wireless adapter (radio). For this reason, it is very important to maintain the preset security and understand the other security features available to you. Besides the preset security settings described above, your router has the security features described here and in [Chapter 4, Content Filtering](#).

- Turn off wireless connectivity
- Disable SSID broadcast
- Restrict access by MAC address
- Wireless security options

### Turn Off Wireless Connectivity

You can completely turn off the wireless connectivity of the router. For example, if you use your notebook computer to wirelessly connect to your router and you take a business trip, you can turn off the wireless portion of the modem router while you are traveling. Other members of your household who use computers connected to the router through Ethernet cables can still use the router.

### Disable SSID Broadcast

By default, the router broadcasts its Wi-Fi network name (SSID) so devices can find it. If you change this setting to not allow the broadcast, wireless devices do not find your router unless they are configured with the same SSID.

---

**Note:** Turning off SSID broadcast nullifies the wireless network discovery feature of some products such as Windows XP, but the data is still fully exposed to a determined snoop using specialized test equipment like wireless sniffers. If you allow the broadcast, be sure to keep wireless security enabled.

---

### Restrict Access by MAC Address

You can enhance your network security by allowing access to only specific PCs based on their Media Access Control (MAC) addresses. You can restrict access to only trusted PCs so that unknown PCs cannot wirelessly connect to the router. MAC address filtering adds additional security protection to the wireless security option you have in force. The Wireless Station Access List determines which wireless hardware devices are allowed to connect to the router by MAC address. See [Restrict Access by MAC Address](#) on page 28 for the procedure.

## Wireless Security Options

A security option is the type of security protocol applied to your wireless network. The security protocol in force encrypts data transmissions and ensures that only trusted devices receive authorization to connect to your network. There are two types of encryption: Wired Equivalent Privacy (WEP) and Wi-Fi Protected Access (WPA). WPA is stronger, and therefore, recommended over WEP. WPA has several options including pre-shared key (PSK) encryption.

This section presents an overview of the security options and provides guidance on when to use which option. Note that it is also possible to disable wireless security. NETGEAR does *not* recommend this.

### WPA Encryption

WPA encryption is built into all hardware that has the Wi-Fi-certified seal. This seal means the product is authorized by the Wi-Fi Alliance (<http://www.wi-fi.org/>) because it complies with the worldwide single standard for high-speed wireless local area networking.

- WPA2-PSK is the strongest. It is advertised to be theoretically indecipherable due to the greater degree of randomness in encryption keys that it generates. WPA2-PSK gets higher speed because it is usually implemented through hardware, while WPA-PSK is usually implemented through software. WPA2-PSK uses a passphrase to authenticate and generate the initial data encryption keys. Then it dynamically varies the encryption key.
- WPS-PSK + WPA2-PSK Mixed Mode provides broader support for all wireless clients. WPA2-PSK clients get higher speed and security, and WPA-PSK clients get decent speed and security. The product documentation for your wireless adapter and WPA client software should have instructions about configuring their WPA settings.

WPA-PSK uses a passphrase to perform the authentication and generate the initial data encryption keys. Then it dynamically varies the encryption key. WPA-PSK uses Temporal Key Integrity Protocol (TKIP) data encryption, implements most of the IEEE 802.11i standard, and is designed to work with all wireless network interface cards, but not all wireless access points. It is superseded by WPA2-PSK.

### WEP Encryption

WEP uses an old encryption method and can be easily decoded with today's powerful computers. Use this mode only when you have a very old legacy wireless client that does not support WPA-PSK. WEP is only available with certain Mode settings. The Wi-Fi alliance highly recommends against using WEP and plans to make it obsolete.

## Add Clients (Computers or Devices) to Your Network

Choose either the manual or the WPS method to add wireless computers or devices to your wireless network.

### Manual Method

1. Open the software that manages your wireless connections on the wireless device (laptop computer, gaming device, iPhone) that you want to connect to your router. This software scans for all wireless networks in your area.
2. Look for your network and select it. If you did not change the name of your network during the setup process, look for the default Wi-Fi network name (SSID) and select it. The default Wi-Fi network name (SSID) is located on the product label on the bottom of the router.
3. When prompted, enter the passphrase (password) to join the wireless network. This is the password that you set up in the Wireless Settings screen in the Security Options section.
4. Repeat steps 1–3 to add other wireless devices.

### Wi-Fi Protected Setup (WPS) Method

Wi-Fi Protected Setup (WPS) is a standard that lets you easily join a secure wireless network with WPA or WPA2 wireless security. The router automatically sets security for each computer or device that uses WPS to join the wireless network. To use WPS, make sure that your wireless devices are Wi-Fi certified and support WPS. NETGEAR products that use WPS call it Push 'N' Connect.<sup>1</sup>

---

**Note:** If the wireless network name (SSID) changes each time you add a WPS client, the Keep Existing Wireless Settings check box on the Advanced Wireless Settings screen has been cleared. See [Advanced Wireless Settings](#) on page 70 for more information about this setting.

---

You can use a WPS button or the router interface method to add wireless computers and devices to your wireless network.

### WPS Button Method

1. Press the **WPS** button on the rear panel of the router.
2. Within 2 minutes, press the **WPS** button on your wireless computer or device, or follow the WPS instructions that came with the computer. The device is now connected to your router.
3. Repeat steps 1–2 to add other WPS wireless computers or devices.

---

1. For a list of other Wi-Fi-certified products available from NETGEAR, go to <http://www.wi-fi.org>.

## Router Interface Method

1. Select **Add WPS Client** at the top of the router menus.
2. Click **Next**. The following screen lets you select the method for adding the WPS client.

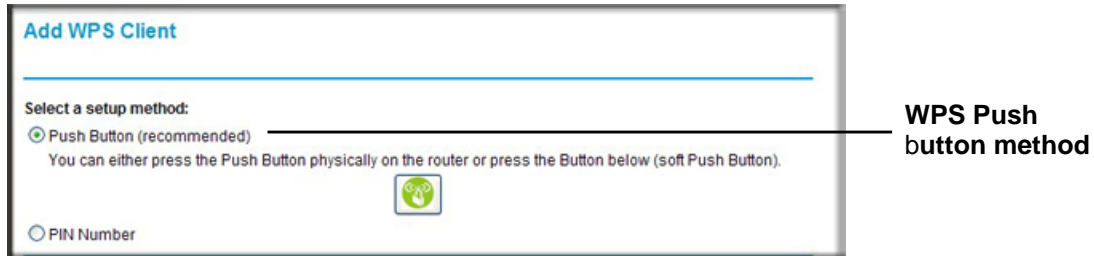

3. Select either **Push Button** or **PIN Number**. With either method, the router tries to communicate with the computer or wireless device, set the wireless security for wireless device, and allow it to join the wireless network.

The PIN method displays this screen so you can enter the client security PIN number:

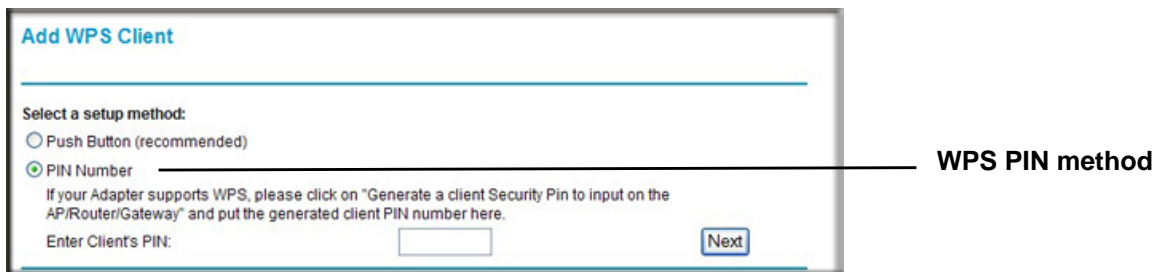

While the router attempts to connect, the WPS LED on the front of the router blinks green. When the router establishes a WPS connection, the LED is solid green and the router WPS screen displays a confirmation message.

4. Repeat to add another WPS client to your network.

## Wireless Settings

The Wireless Settings screen lets you view or change the wireless network settings. Note that your preset router has a unique network name and password, located on the product label. NETGEAR recommends that you use these settings. If you decide to change them, note the new settings and save them in a secure location.

---

**Note:** If you use a wireless computer to change the wireless network name (SSID) or security options, you are disconnected when you click Apply. To avoid this problem, use a computer with a wired connection to access the router.

---

## Consider Every Device on Your Network

Before you begin, check the following:

- Every wireless computer has to be able to obtain an IP address by DHCP from the router as described in *Use Standard TCP/IP Properties for DHCP* on page 16.
- Each computer or wireless adapter in your network must have the same SSID and wireless mode (bandwidth/data rate) as the router. Check that the wireless adapter on each computer can support the mode and security option you want to use.
- The security option on each wireless device in the network must match the router. For example, if you select a security option that requires a passphrase, be sure to use same passphrase for each wireless computer in the network.

## View or Change Wireless Settings

NETGEAR recommends that you use wireless security to protect your network from unwanted access and that you change the default network name of NETGEAR to a name that you can easily recognize when connecting wirelessly to the router. You view or change these settings in the Wireless Settings screen.

**To view or change wireless settings:**

1. Select **Setup > Wireless Settings**. The Wireless Settings screen displays.

**Wireless Settings**

---

**Region Selection**  
Region: Japan

---

**Wireless Network**  
 Enable SSID Broadcast  
 Enable Wireless Isolation  
 Name (SSID): NETGEAR  
 Channel: Auto  
 Mode: Up to 145 Mbps

---

**Security Options**  
 None  
 WPA2-PSK [AES]  
 WPA-PSK [TKIP] + WPA2-PSK [AES]

---

**Security Options (WPA-PSK + WPA2-PSK)**  
 Passphrase: loneranger (8-63 characters or 64 hex digits)

Apply Cancel

2. Make any changes that are needed, and click **Apply** when done to save your settings.



---

**Note:** The screen sections, settings, and procedures are explained in the following sections.

---

3. Set up and test your computers for wireless connectivity:
  - a. Use your wireless computer or device to join your network. When prompted, enter the network password.
  - b. From the wirelessly connected computer, make sure that you can access the Internet.

## Wireless Settings Screen Fields

### Region

- This field identifies the region where the JNR3210 router can be used. It might not be legal to operate the wireless features of the router in a region other than one of those identified in this field. In North America, the region cannot be changed, and is set by default to US.

### Wireless Network

- **Allow Broadcast of Name (SSID).** This setting allows the router to broadcast its SSID so that a wireless station can display this wireless name (SSID) in its scanned network list. This check box is selected by default. To turn off the SSID broadcast, clear the Allow Broadcast of Name (SSID) check box and click **Apply**.
- **Wireless Isolation.** When this check box is selected, wireless stations cannot communicate with each other or with stations on the wired network. By default, this check box is not selected.
- **Name (SSID).** The SSID is also known as the wireless network name. Enter a value of up to 32 alphanumeric characters. When more than one wireless network is active, different wireless network names provide a way to separate the traffic. For a wireless device to participate in a particular wireless network, it must be configured with the SSID for that network. The JNR3210 default SSID is **NETGEAR**. You can disable this broadcast as described in [Click Apply to save your settings.](#) on page 36.
- **Channel.** This field determines which operating frequency is used. It should not be necessary to change the wireless channel unless you notice interference problems with another nearby wireless network. The router uses channel bonding technology to extend the bandwidth for data transmission.
- **Mode.** This field determines which data communications protocol is used. You can choose from:
  - **Up To 54 Mbps.** Legacy mode, for compatibility with the slower 802.11b and 802.11g wireless devices. WEP and WPA security options are supported at 54 Mbps only.
  - **Up To 145 Mbps.** Neighbor friendly mode, for reduced interference with neighboring wireless networks. Provides two transmission streams with different data on the same

channel at the same time, but also allows 802.11b and 802.11g wireless devices. This is the default mode.

- **Up To 300 Mbps.** Performance mode, using channel expansion to achieve the 300 Mbps data rate. The JNR3210 router uses the channel you selected as the primary channel and expands to the secondary channel (primary channel +4 or -4) to achieve a 40 MHz frame-by-frame bandwidth. The router detects channel usage and disables frame-by-frame expansion if the expansion would result in interference with the data transmission of other access points or clients.

---

**Note:** The maximum wireless signal rate is derived from the IEEE Standard 802.11 specifications. Actual data throughput can vary. Network conditions and environmental factors, including volume of network traffic, building materials and construction, and network overhead, lower actual data throughput rate.

---

- **Security Options.** The selection of wireless security options can significantly affect your network performance. The time it takes to establish a wireless connection can vary depending on both your security settings and router placement.

## Set Up WPA-PSK and WPA2-PSK Wireless Security

WPA-Pre-Shared Key performs authentication. WPA-PSK uses TKIP (Temporal Key Integrity Protocol) data encryption, and WPA2-PSK uses AES (Advanced Encryption Standard) data encryption. Both methods dynamically change the encryption keys making them nearly impossible to circumvent.

Mixed mode allows clients using either WPA-PSK (TKIP) or WPA2-PSK (AES). This provides the most reliable security, and is easiest to implement, but it might not be compatible with older adapters.

---

**Note:** To display the security options WPA-PSK and WEP, you have to use the legacy mode setting of Up to 54 Mbps.

---

### To set up WPA2 or WPA:

1. Select **Setup > Wireless Settings**. The Wireless Settings screen displays.
2. Select a radio button for the security option that you want to use. Mixed mode (WPA-PSK [TKIP] + WPA2-PSK [AES]) is the most flexible, since it allows clients using either WPA-PSK or WPA2-PSK.

3. In the **Passphrase** field, enter a word or group of 8–63 printable characters. The passphrase is case-sensitive.

4. Click **Apply** to save your settings.

## Set Up WEP Wireless Security

WEP Shared Key authentication and WEP data encryption can be defeated by a determined eavesdropper using publicly available tools.

### To set up WEP data encryption:

If you use a wireless computer to setup WEP, you will be disconnected when you click **Apply**. You can rejoin the network with its new security settings or use a wired connection to make further changes. router. Not all wireless devices support passphrases. If yours does not, then you will need to manually enter the WEP key in order to join the wireless network.

1. Select **Setup > Wireless Settings**.
2. In the Mode field, select the legacy mode setting of **Up to 54 Mbps**.  
The WEP and WPA radio buttons display in the Security Options section of the screen.
3. Select the **WEP** radio button and the screen expands as shown in the following figure:

4. Select the authentication type and encryption strength.

5. You can manually or automatically program the four data encryption keys. These values must be identical on all computers and access points in your network.
  - **Automatically Generate.** In the Passphrase field, enter a word or group of printable characters, and click **Generate**. The passphrase is case-sensitive. For example, NETGEAR is not the same as nETgear. The four key fields are automatically populated with key values.
  - **Manual.** Enter 10 hexadecimal digits (any combination of 0–9, a–f, or A–F). These entries are not case-sensitive. For example, AA is the same as aa. Select which of the four keys to activate.
6. Click **Apply** to save your settings.

### WEP Security Encryption Fields

- **Automatic.** With the Automatic option, the router tries both Open System and Shared Key authentication. Usually, this setting works fine. If it fails, select **Open System** or **Shared Key**. You can also refer to your wireless adapter's documentation to see what method to use.
- **Open System.** With Open System authentication and 64 or 128 bit WEP data encryption, the router performs data encryption but *does not* perform any authentication. Anyone can join the network. This setting provides very little practical wireless security.
- **Shared Key.** A wireless device must know the WEP key to join the network. Select the encryption strength (64 or 128 bit data encryption). Manually enter the key values, or enter a word or group of printable characters in the **Passphrase** field. Manually entered keys *are not* case-sensitive, but passphrase characters *are* case-sensitive.

## Add Guest Networks

Adding a guest network allows visitors at your home to use the Internet without having to know your wireless security key. The JNR3210 router supports three guest networks.

To add a guest network, do the following:

1. Select **Guest Network** from the Setup menu. The Guest Network Settings screen appears.

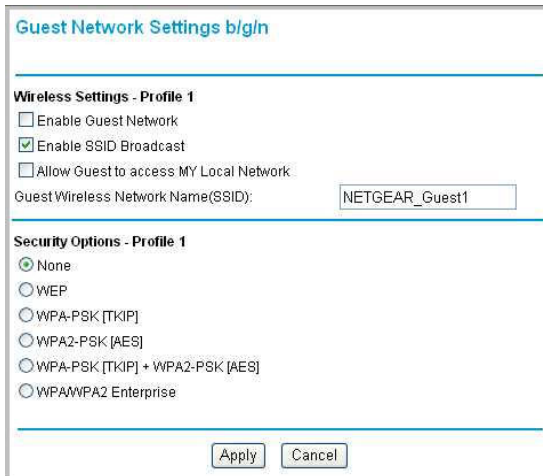

The screenshot shows the 'Guest Network Settings' web interface. At the top, it says 'Guest Network Settings b/g/n'. Below this, there are two main sections: 'Wireless Settings - Profile 1' and 'Security Options - Profile 1'. In the 'Wireless Settings' section, there are three checkboxes: 'Enable Guest Network' (unchecked), 'Enable SSID Broadcast' (checked), and 'Allow Guest to access MY Local Network' (unchecked). Below these is a text input field for 'Guest Wireless Network Name(SSID)' with the value 'NETGEAR\_Guest1'. In the 'Security Options' section, there are five radio button options: 'None' (selected), 'WEP', 'WPA-PSK [TKIP]', 'WPA2-PSK [AES]', and 'WPA-PSK [TKIP] + WPA2-PSK [AES]'. At the bottom of the form are 'Apply' and 'Cancel' buttons.

Figure 3-1

2. Select any of the following Wireless settings:
  - **Enable Guest Network** – When this check box is selected, the guest network is enabled, and guests can connect to your network using the SSID of this profile.
  - **Enable SSID Broadcast** – If selected, the Wireless Access Point broadcasts its name (SSID) to all Wireless Stations. Stations with no SSID can adopt the correct SSID for connections to this Access Point.
  - **Allow Guest to access MY Local Network** – If selected any user who connects to this SSID can access local networks associated with the router like users in the primary SSID.
3. Give the wireless network a name.
4. The name is case-sensitive and can be up to 32 characters. The same name must be assigned to all wireless devices in your network. NETGEAR recommends that you change the name to a different value.
5. Select a Security option from the list.
6. Click **Apply** to save your selections.

# 4 Content Filtering

---

# 4

This chapter explains how to use the basic firewall features of the router to prevent objectionable content from reaching the PCs and other devices connected to your network.

This chapter includes the following sections:

- *Live Parental Controls*
- *Keyword Blocking of HTTP Traffic*
- *Block Outbound Traffic to Internet Services*
- *Set the Time Zone*
- *Schedule Blocking*
- *Enable Security Event Email Notification*
- *View Logs of Web Access or Attempted Web Access*
- *Allow Inbound Connections to Your Network*
- *Port Forwarding to a Local Server*
- *Port Triggering*

## Live Parental Controls

NETGEAR Live Parental Controls, powered by OpenDNS, is a router-based Web filtering solution available on NETGEAR N300 Wireless router and gateway products. Designed to protect you from identity theft and scams, Live Parental Controls blocks up to 50 categories of Internet content.

Live Parental Controls protects all Internet-connected devices through the router. It protects not only computers, but also set-top boxes, iPhones, iPods, and gaming consoles that are attached to your network. Default and per-user settings allow you to customize configurations for different computing arrangements and personalize the settings for each person. Per-time settings allow Internet access during scheduled time slots.

Live Parental Controls requires a one-time installation of the management utility. Once set up, Live Parental Controls runs in the background and does not interfere with normal Internet usage.

Download Live Parental Controls from this website: <http://www.netgear.com/lpc>.

## Keyword Blocking of HTTP Traffic

Use keyword blocking to prevent certain types of HTTP traffic from accessing your network. The blocking can be always or according to a scheduled.

1. Select **Security > Block Sites**.

The screenshot shows the 'Block Sites' configuration page. At the top, the title 'Block Sites' is displayed in blue. Below the title, there is a section for 'Keyword Blocking' with three radio button options: 'Never', 'Per Schedule', and 'Always'. The 'Always' option is selected. Below this, there is a text input field labeled 'Type Keyword or Domain Name Here.' with an 'Add Keyword' button to its right. Underneath, a list box is labeled 'Block Sites Containing these Keywords or Domain Names:'. Below the list box are two buttons: 'Delete Keyword' and 'Clear List'. At the bottom, there is a checkbox labeled 'Allow Trusted IP Address to Visit Blocked Sites' which is currently unchecked. Below the checkbox is a text input field for 'Trusted IP Address' with a dotted pattern. At the very bottom, there are 'Apply' and 'Cancel' buttons.

2. Select one of the keyword blocking options:
  - **Per Schedule.** Turn on keyword blocking according to the Schedule screen settings.
  - **Always.** Turn on keyword blocking all the time, independent of the Schedule screen.
3. In the Keyword field, enter a keyword or domain, click **Add Keyword**, and click **Apply**.  
The Keyword list. supports up to 32 entries. Here are some sample entries:
  - Specify XXX to block `http://www.badstuff.com/xxx.html`
  - Specify .com if you want to allow only sites with domain suffixes such as .edu or .gov
  - Enter a period (.) to block all Internet browsing access

## Delete a Keyword or Domain

1. Select the keyword you want to delete from the list.
2. Click **Delete Keyword** and click **Apply** to save your changes.

## Specify a Trusted Computer

You can exempt one trusted computer from blocking and logging. That computer has to be configured to use a fixed IP address.

1. In the **Trusted IP Address** field, enter the IP address.
2. Click **Apply** to save your changes.

## Block Outbound Traffic to Internet Services

The router lets you block computers on your local network from using certain Internet services. This is called service blocking or port filtering. You can block Internet access from a local computer based on local computer, Internet site being contacted, time of day, and type of service being requested.



**To block access to Internet services:**

1. Select **Content Filtering > Block Services**. The Block Services screen displays.

2. Enable service blocking by selecting either **Per Schedule** or **Always**, and then click **Apply**.

To block by schedule, be sure to specify a time period in the Schedule screen. For information about scheduling, see [Schedule Blocking](#) on page 43.

3. Specify a service for blocking by clicking **Add**. The Block Services Setup screen displays.

4. From the Service Type list, select the application or service to be allowed or blocked.
5. If you do not see the service or application that you want to block in the list, select **User Defined**.

To define a service or application, you need to know which port number or range of numbers it uses. The service port numbers for many common protocols are defined by the Internet Engineering Task Force (IETF) and published in RFC1700, “Assigned Numbers.” Service numbers for other applications are typically chosen from the range 1024 to 65535 by the authors of the application. You can often determine port number

information by contacting the publisher of the application, by asking user groups or newsgroups, or by searching.

- Enter the starting port and ending port numbers. If the application uses a single port number, enter that number in both fields.
  - If you know that the application uses either TCP or UDP, select the appropriate protocol. If you are not sure, select **Both**.
6. Select the radio button for the IP address configuration you want to block, and then enter the IP addresses in the appropriate fields.
  7. Click **Add** to enable your Block Services Setup selections.

## Block Services by IP Address Range

In the Filter Services For area, you can block the specified service for a single computer, a range of computers (having consecutive IP addresses), or all computers on your network.

## Set the Time Zone

The router uses the Network Time Protocol (NTP) to obtain the current time and date from one of several network time servers on the Internet. You can check and set (if needed) the time zone to ensure time stamps match your local time.

1. Select **Security > Schedule** to display the following screen:

**Schedule**

---

**Days to Block**

Every Day  
 Sunday  
 Monday  
 Tuesday  
 Wednesday  
 Thursday  
 Friday  
 Saturday

---

**Days to Block**

Every Day  
 Sunday  
 Monday  
 Tuesday  
 Wednesday  
 Thursday  
 Friday  
 Saturday

---

**Time of day to block:**(use 24-hour clock)

All Day

Start Blocking     hour(s)  minute(s)

End Blocking      hour(s)  minute(s)

---

**Time Zone**

(GMT) Casablanca, Monrovia

Automatically adjust for daylight savings time

Current Time Wednesday, Mar 30, 2011 22:05:21

2. Select your time zone. This setting determines the blocking schedule and time-stamping of log entries.
3. If your time zone is in daylight savings time, select the **Adjust for Daylight Savings Time** check box to add one hour to standard time.

If your region uses daylight savings time, select **Adjust for Daylight Savings Time** on the first day and clear it after the last day.

4. The router has a list of NETGEAR NTP servers. If you would prefer to use a particular NTP server as the primary server, select the **Use this NTP Server** check box, and enter its IP address.
5. Click **Apply** to save your settings.

## Schedule Blocking

You can set up a schedule for when blocking occurs or when access is not restricted.

1. Select **Security > Schedule** to display the following screen:

2. To block Internet services based on a schedule, select **Every Day** or select one or more days. If you want to limit access completely for the selected days, select **All Day**. Otherwise, to limit access during certain times for the selected days, enter times in the **Start Time** and **End Time** fields.
  - Enter the values in 24-hour time format. For example, 10:30 a.m. is 10 hours and 30 minutes, and 10:30 p.m. is 22 hours and 30 minutes.
  - If you set the start time after the end time, the schedule is effective through midnight the next day.

3. Click **Apply** to save your settings.

## Enable Security Event Email Notification

To receive logs and alerts by email, provide your email information in the E-mail screen and specify which alerts you want to receive and how often.

Select **Security > Email** to display the following screen:

The screenshot shows the 'E-mail' configuration page. At the top, there is a title 'E-mail' and a checkbox labeled 'Turn E-mail Notification On'. Below this is a section titled 'Send alerts and logs through e-mail' containing several input fields: 'Your Outgoing Mail Server', 'Send to This E-mail Address', 'Secure connection (use SSL)', and 'My mail server requires authentication'. Under the 'My mail server requires authentication' checkbox, there are fields for 'User Name' and 'Password'. A section titled 'Send Alert Immediately' has a checked checkbox and the text 'When someone attempts to visit a blocked site'. Below that is a section 'Send logs according to this schedule' with a dropdown menu for 'When log is full', a 'Day' dropdown set to 'Sunday', and a 'Time' dropdown set to '0:00' with radio buttons for 'a.m.' and 'p.m.'. At the bottom of the form are 'Apply' and 'Cancel' buttons.

Fill in the fields as follows:

**Turn Email Notification On.** Select this check box if you want to receive email logs and alerts from the router.

**Your Outgoing Mail Server.** Enter the name or IP address of your ISP's outgoing (SMTP) mail server (such as mail.myISP.com). You might be able to find this information in the configuration settings of your email program. Enter the email address to which logs and alerts are sent. This email address is also used as the From address. If you leave this field blank, log and alert messages are not sent by email.

**Send to This E-mail Address.** Enter the email address where you want logs and alerts sent. This email address is also used as the From address. If you leave this field blank, log and alert messages are not sent by email.

**My mail server requires authentication.** If you use an outgoing mail server provided by your current ISP, you do not need to select this field. If you use an email account that is not provided by your ISP, select this field, and enter the required user name and password information.

**Send Alert Immediately.** Select the corresponding check box if you would like immediate notification of a significant security event, such as a known attack, port scan, or attempted access to a blocked site.

**Send logs according to this schedule.** Specifies how often to send the logs: Hourly, Daily, Weekly, or When Full.

**Day for sending logs** specifies which day of the week to send the log. This is relevant when the log is sent weekly.

**Time for sending log** specifies the time of day to send the log. This is relevant when the log is sent daily or weekly.

---

**Note:** If the Weekly, Daily, or Hourly option is selected and the log fills up before the specified period, the log is automatically emailed to the specified email address. After the log is sent, it is cleared from the router's memory. If the router cannot email the log file, the log buffer might fill up. In this case, the router overwrites the log and discards its contents.

---

## View Logs of Web Access or Attempted Web Access

The log is a detailed record of the websites you have accessed or attempted to access. Up to 128 entries are stored in the log. Log entries appear only when keyword blocking is enabled and no log entries are made for the trusted user.

Select **Content Filtering > Logs**. The Logs screen displays.

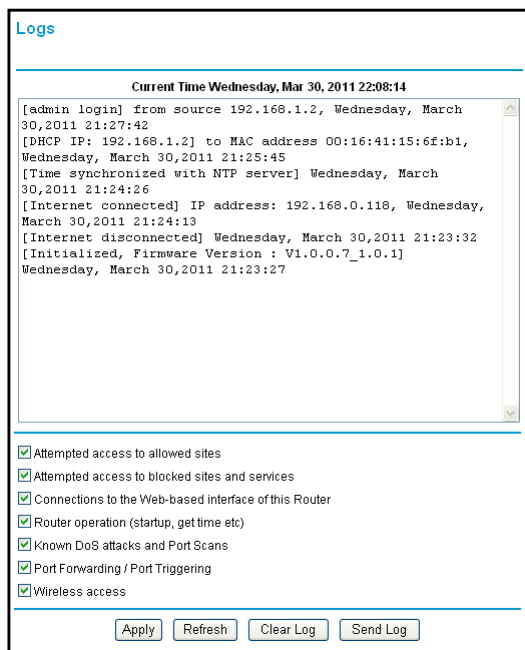

- **Date and time.** The date and time the log entry was recorded.
- **Source IP.** The IP address of the initiating device for this log entry.
- **Target address.** The name or IP address of the website or newsgroup visited or to which access was attempted.
- **Action.** Whether the access was blocked or allowed.

If you change the check box selections, click **Apply** so that your changes take effect. You can select as many or as few of these items as you wish.

To refresh the log screen, click the **Refresh** button.

To clear the log entries, click the **Clear Log** button.

To e-mail the log immediately, click the **Send Log** button.

## Allow Inbound Connections to Your Network

By default, the JNR3210 router blocks any inbound traffic from the Internet to your computers except for replies to your outbound traffic. However, you might need to create exceptions to this rule for the following purposes:

- To allow remote computers on the Internet to access a server on your local network.
- To allow certain applications and games to work correctly when their replies are not recognized by your router.

Your router provides two features for creating these exceptions: port forwarding and port triggering.

- **Port forwarding.** You can use this feature to allow certain types of incoming traffic to reach servers on your local network. For example, you might make a local Web server, FTP server, or game server visible and available to the Internet.
- **Port triggering.** Port triggering is a dynamic extension of port forwarding that is useful in these cases:
  - More than one local computer needs port forwarding for the same application (but not simultaneously).
  - An application needs to open incoming ports that are different from the outgoing port.

Port forwarding and port triggering are described in the following sections.

## Port Forwarding to a Local Server

Using the port forwarding feature, you can allow certain types of incoming traffic to reach servers on your local network. For example, you might make a local Web server, FTP server, or game server visible and available to the Internet.

Use the Port Forwarding screen to configure the router to forward specific incoming protocols to computers on your local network. In addition to servers for specific applications, you can also specify a default DMZ server to which all other incoming protocols are forwarded. The DMZ server is configured in the WAN Setup screen, as discussed in [Set Up a Default DMZ Server](#) on page 65.

Before starting, you need to determine which type of service, application, or game you will provide, and the local IP address of the computer that will provide the service. Be sure the computer's IP address never changes.

**Tip:** To ensure that your server computer always has the same IP address, use the reserved IP address feature of your JNR3210 router. See [Reserved IP Addresses Setup](#) on page 69 for instructions on how to use reserved IP addresses.

## To set up port forwarding to a local server:

1. Select **Advanced > Port Forwarding/Port Triggering**. The Port Forwarding/Port Triggering screen displays:

**Port Forwarding / Port Triggering**

Please select the service type.

Port Forwarding  
 Port Triggering

Service Name: FTP Server IP Address: 192 . 168 . 1 . [ ] Add

#	Service Name	External Start Port	External End Port	Internal Start Port	Internal End Port	Server IP Address

Edit Service Delete Service

Add Custom Service

2. From the Service Name list, select the service or game that you will host on your network. If the service does not appear in the list, see the following section, *Add a Custom Service*.
3. In the corresponding Server IP Address fields, enter the last digit of the IP address of your local computer that will provide this service.
4. To the right of Server IP Address, click **Add**. The service appears in the list in the screen.

## Add a Custom Service

To define a service, game, or application that does not appear in the Service Name list, you must first determine which port number or range of numbers is used by the application. You can usually determine this information by contacting the publisher of the application or user groups or newsgroups. When you have the port number information, follow these steps:

1. Select **Advanced > Port Forwarding/Port Triggering** and then click **Add Custom Service**. The Ports–Custom Services screen displays.

**Ports - Custom Services**

Service Name: [ ]

Service Type: TCP/UDP

External Starting Port: [ ] (1~65534)

External Ending Port: [ ] (1~65534)

Use the same port range for Internal port

Internal Starting Port: [ ] (1~65534)

Internal Ending Port: [ ]

Internal IP address: 192 . 168 . 1 . [ ]

Or select from currently attached devices

	IP Address	Device Name
<input checked="" type="radio"/>	192.168.1.2	DVOISIN

Apply Cancel

2. In the Service Name field, enter a descriptive name.



3. In the Service Type field, select the protocol. If you are unsure, select **TCP/UDP**.
4. In the Starting Port field, enter the beginning port number.
  - If the application uses only a single port, enter the same port number in the Ending Port field.
  - If the application uses a range of ports, enter the ending port number of the range in the Ending Port field.
5. In the Server IP Address field, enter the IP address of your local computer that will provide this service.
6. Click **Apply**. The service appears in the list in the Port Forwarding/Port Triggering screen.

## Edit or Delete a Port Forwarding Entry

1. In the table, select the button next to the service name.

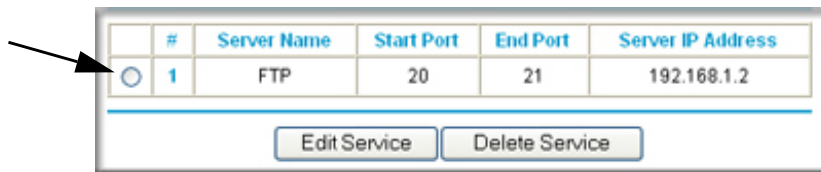

2. Click **Edit Service** or **Delete Service** to make changes.
3. Click **Apply**.

### *Application Example: Making a Local Web Server Public*

If you host a Web server on your local network, you can use port forwarding to allow Web requests from anyone on the Internet to reach your Web server.

To make a local Web server public:

1. Assign your Web server either a fixed IP address or a dynamic IP address using DHCP address reservation, as explained in *Use the Router as a DHCP Server* on page 68. In this example, your router will always give your Web server an IP address of 192.168.1.33.
2. In the Port Forwarding screen, configure the router to forward the HTTP service to the local address of your Web server at **192.168.1.33**. HTTP (port 80) is the standard protocol for Web servers.
3. (Optional) Register a host name with a Dynamic DNS service, and configure your router to use the name as described in *Dynamic DNS* on page 65. To access your Web server from the Internet, a remote user must know the IP address that has been assigned by your ISP. However, if you use a Dynamic DNS service, the remote user can reach your server by a user-friendly Internet name, such as mynetgear.dyndns.org.

## Port Triggering

Port triggering is a dynamic extension of port forwarding that is useful in these cases:

- More than one local computer needs port forwarding for the same application (but not simultaneously).
- An application needs to open incoming ports that are different from the outgoing port.

When port triggering is enabled, the router monitors outbound traffic looking for a specified outbound “trigger” port. When the router detects outbound traffic on that port, it remembers the IP address of the local computer that sent the data. The router then temporarily opens the specified incoming port or ports, and forwards incoming traffic on the triggered ports to the triggering computer.

While port forwarding creates a static mapping of a port number or range to a single local computer, port triggering can dynamically open ports to any computer that needs them and can close the ports when they are no longer needed.

---

**Note:** If you use applications such as multiplayer gaming, peer-to-peer connections, real-time communications such as instant messaging, or remote assistance (a feature in Windows XP), you should also enable Universal Plug and Play (UPnP) according to the instructions in *Click Apply. The service appears in the Port Triggering Portmap table.* on page 52.

---

To configure port triggering, you need to know which inbound ports the application needs. Also, you need to know the number of the outbound port that will trigger the opening of the inbound ports. You can usually determine this information by contacting the publisher of the application or user groups or newsgroups.

## To set up port triggering:

1. Select **Advanced > Port Forwarding/Port Triggering** and then select the **Port Triggering** radio button. The port triggering information displays.

**Port Forwarding / Port Triggering**

Please select the service type.

Port Forwarding  
 Port Triggering

Disable Port Triggering

Port Triggering Time-out (in minutes)

**Port Triggering Portmap Table**

#	Enable	Service Name	Service Type	Inbound Connection	Service User
<input type="button" value="Add Service"/> <input type="button" value="Edit Service"/> <input type="button" value="Delete Service"/>					

2. Clear the **Disable Port Triggering** check box.

---

**Note:** If the Disable Port Triggering check box is selected after you configure port triggering, port triggering is disabled. However, any port triggering configuration information you added to the router is retained even though it is not used.

---

3. In the Port Triggering Timeout field, enter a value up to 9999 minutes. This value controls the inactivity timer for the designated inbound ports. The inbound ports close when the inactivity time expires. This is required because the router cannot be sure when the application has terminated.
4. Click **Add Service**.

**Port Triggering - Services**

Service Name

Service User

Service Type

Triggering Port  (1~65535)

**Inbound Connection**

Connection Type

Starting Port  (1~65535)

Ending Port  (1~65535)

5. The Port Triggering–Services screen displays.
6. In the Service Name field, enter a descriptive service name.

7. In the Service User field, select **Any** (the default) to allow this service to be used by any computer on the Internet. Otherwise, select **Single address**, and enter the IP address of one computer to restrict the service to a particular computer.
8. Select the service type, either **TCP** or **UDP**.
9. In the Triggering Port field, enter the number of the outbound traffic port that will cause the inbound ports to be opened.
10. Enter the inbound connection port information in the Connection Type, Starting Port, and Ending Port fields.
11. Click **Apply**. The service appears in the Port Triggering Portmap table.

**Port Forwarding / Port Triggering**

---

Please select the service type.

Port Forwarding  
 Port Triggering

---

Disable Port Triggering

Port Triggering Time-out (in minutes)

---

**Port Triggering Portmap Table**

	#	Enable	Service Name	Service Type	Inbound Connection	Service User
<input type="radio"/>	1	<input checked="" type="checkbox"/>	dialpad_1	TCP:1	TCP/UDP:1..2	any

---

---

# 5 Network Maintenance

---

# 5

## Administering your network

This chapter describes the router settings for administering and maintaining the router and home network.

This chapter contains the following sections:

- *Upgrade the Router Firmware*
- *Manage the Configuration File*
- *View Router Status*
- *View Attached Devices*
- *Remote Management Access*

## Upgrade the Router Firmware

The router firmware (routing software) is stored in flash memory. By default, when you log in to your router, it checks the NETGEAR website for new firmware and alerts you if there is a newer version.



### WARNING!

When uploading firmware to the router, *do not* interrupt the Web browser by closing the window, clicking a link, or loading a new page. If the browser is interrupted, it could corrupt the firmware.

## Turn Off Automatic Firmware Checking

You can turn the automatic firmware checking off and check for firmware updates manually if you prefer. See [Manually Check for Firmware Upgrades](#) on page 55. To turn off the automatic firmware check at log in:

1. Select **Maintenance > Router Upgrade**.
2. Clear the **Check for Updated Firmware Upon Log-in** check box at the bottom of this screen:.

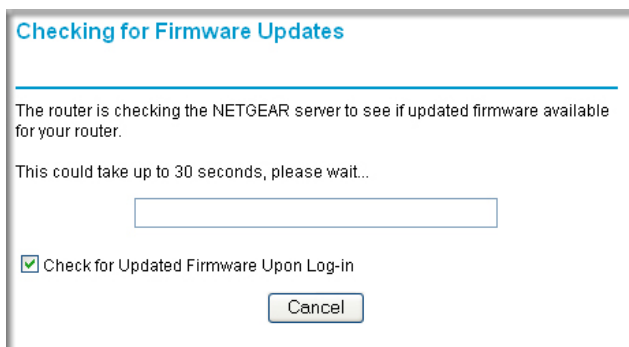

## Automatic Firmware Checking On

When automatic firmware checking is on, the router performs the check and notifies you if an upgrade is available or not as shown here.



1. Click **Yes** to allow the router to download and install the new firmware. The upgrade process could take a few minutes. When the upload is complete, your router restarts.
2. Go to the JNR3210 support page at <http://www.netgear.com/support> and read the new firmware release notes to determine whether you need to reconfigure the modem router after upgrading.

---

**Note:** If you get a “Firmware needs to be reloaded” message, it means a problem has been detected with the router’s firmware. Follow the prompts to correct the problem or see the next section for a description of the steps.

---

## Manually Check for Firmware Upgrades

You can use the Router Upgrade screen to manually check the NETGEAR website for newer versions of firmware for your product.



### WARNING!

When uploading firmware to the router, **do not** interrupt the Web browser by closing the window, clicking a link, or loading a new page. If the browser is interrupted, it could corrupt the firmware.

1. Select **Maintenance > Router Status** and make a note of the router firmware version number.

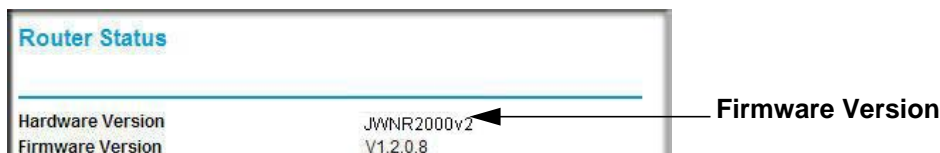

2. Go to the JNR3210 support page on the NETGEAR website at <http://www.netgear.com/support>.

3. If the firmware version on the NETGEAR website is newer than the firmware on your router, download the file to your computer.
4. To upload the newer firmware, select **Maintenance > Router Upgrade** to display the following screen:

5. Click **Browse**, and locate the firmware you downloaded (the file ends in .img).
6. Click **Upload** to send the firmware to the router.

When the upload completes, your router restarts. The upgrade process typically takes about one minute. Read the new firmware release notes to determine whether or not you need to reconfigure the router after upgrading.

## Manage the Configuration File

The router configuration settings are stored in a configuration file (\*.cfg). This file can be backed up to your computer, restored, or reverted to factory default settings.

### Back Up

1. Select **Maintenance > Backup Settings** to display the following screen:

2. Click **Backup** to save a copy of the current settings.
3. Choose a location to store the .cfg file that is on a computer on your network.



## Restore

1. Enter the full path to the file on your network, or click the **Browse** button to find the file.
2. When you have located the .cfg file, click the **Restore** button to upload the file to the router.

Upon completion, the router reboots.



### **WARNING!**

**Do not interrupt the reboot process.**

## Erase

Under some circumstances (for example, if you move the router to a different network or if you have forgotten the password), you might want to erase the configuration and restore the factory default settings.

Click the **Erase** button to reset the router to its factory default settings. Alternately, press the Wireless On/Off and WPS buttons on the side panel of the router simultaneously for 6 seconds.

Erase sets the user name to admin, the password to password, the LAN IP address to 192.168.1.1, and enables the router's DHCP.

To restore the factory default configuration settings when you do not know the login password or IP address, use the restore factory settings button on the bottom of the router (see [Restore the Default Configuration and Password](#) on page 94).

## View Router Status

Select **Maintenance > Router Status** to display the following screen. The Router Status screen provides the status and usage information described in the following figure.

Router Status	
Hardware Version	JWNR2000v2
Firmware Version	V1.2.0.8
GUI Language Version:	V1.1.5.4
<b>Internet Port</b>	
MAC Address	00:1E:2A:E0:04:8D
IP Address	10.1.10.74
DHCP	DHCPClient
IP Subnet Mask	255.255.255.0
Domain Name Server	10.1.1.6 10.1.1.7
<b>LAN Port</b>	
MAC Address	00:1E:2A:E0:04:8C
IP Address	192.168.1.1
DHCP	ON
IP Subnet Mask	255.255.255.0
<b>Wireless Port</b>	
Name (SSID)	NETGEAR
Region	Asia
Channel	auto(10)
Mode	Up to 145Mbps
Wireless AP	ON
Broadcast Name	ON
Wi-Fi Protected Setup	Configured
<input type="button" value="Show Statistics"/> <input type="button" value="Connection Status"/>	

**Hardware Version.** The firmware version.

**Firmware Version.** The version of the current software installed in the router. This changes if you update your router.

**GUI Language Version.** The version of the selected GUI language for the router manager screens.

**Internet Port.**

**MAC Address.** The Ethernet MAC address of the Internet port.

**IP Address.** The Internet port IP address. If no address is shown, the router cannot connect to the Internet.

**DHCP.** If set to None, the router is configured to use a fixed IP address on the WAN. If set to DHCP Client, the router is configured to obtain an IP address dynamically from the ISP.

**IP Subnet Mask.** The Internet port IP subnet mask.

**Domain Name Server.** The router DNS server IP addresses. These addresses are usually obtained dynamically from the ISP.

**LAN Port (Local Ports).**

**MAC Address.** The router LAN port Ethernet MAC address.

**IP Address.** The router LAN port IP address. The default is 192.168.0.1.

**DHCP.** If Off, the router does not assign IP addresses to PCs on the LAN. If On, the router does assign IP addresses to PCs on the LAN.

**IP Subnet Mask.** The IP subnet mask used by the router LAN. The default is 255.255.255.0.

**Wireless Port.**

See [Wireless Settings](#) on page 31 for more information on these settings.

**Name (SSID).** The Wi-Fi network name (service set ID) for the wireless network.

**Region.** The country where the unit is set up for use.

**Channel.** The current channel, which determines the operating frequency.

**Mode.** Indicates the wireless communication mode:

- Up to 54 Mbps.
- Up to 145 Mbps.
- Up to 300 Mbps (in this mode, there are two channels: a primary channel [P] and a secondary channel [S]).

**Wireless AP.** Indicates if the access point feature is enabled. If disabled, the Wireless LED on the front panel is off.

**Broadcast Name.** Indicates if the router is configured to broadcast its SSID.

**Wi-Fi Protected Setup.** Indicates whether the router's PIN is enabled and whether the router is configured for Push 'N' Connect (Wi-Fi Protected Setup).

**Show Statistics Button.** Click the **Show Statistics** button on the Router Status screen to display a screen similar to this:

The screenshot shows a 'Router Status' window with the following data:

Port	Status	TxPkts	RxPkts	Collisions	Tx B/s	Rx B/s	Up Time
WAN	100Mbps/Full	201446	237177	0	266	1505	1 day 21:37:49
LAN1	100Mbps/Full	135629	129768	0	1360	179	1 day 05:33:08
LAN2	Link Down						--
LAN3	Link Down						--
LAN4	Link Down						--
WLAN	300M	95234	79713	0	481	159	1 day 21:38:00

Below the table, there is a 'Poll Interval' field set to '5' (secs), a 'Set Interval' button, and a 'Stop' button.

- **System Up Time.** The time elapsed since the router was last restarted.
- **Port.** The statistics for the WAN (Internet) and LAN (Ethernet) ports. For each port, the screen displays the following:

**Status.** The link status of the port.

**TxPkts.** The number of packets transmitted on this port since reset or manual clear.

**RxPkts.** The number of packets received on this port since reset or manual clear.

**Collisions.** The number of collisions on this port since reset or manual clear.

**Tx B/s.** The current transmission (outbound) bandwidth used on the WAN and LAN ports

**Rx B/s.** The current reception (inbound) bandwidth used on the WAN and LAN ports.

**Up Time.** The time elapsed since this port acquired the link.

- **Poll Interval.** The intervals at which the statistics are updated in this screen.

To change the polling frequency, enter a time in seconds in the Poll Interval field, and click **Set Interval**. To stop the polling entirely, click **Stop**.

**Connection Status Button.** In the Router Status screen, click the **Connection Status** button to display a screen similar to this:

The screenshot shows a window titled "Connection Status" with a table of network parameters and control buttons. The table contains the following data:

IP Address	192.168.100.102
Subnet Mask	255.255.255.0
Default Gateway	192.168.100.1
DHCP Server	192.168.100.1
DNS Server	192.168.100.1
Lease Obtained	1 days,0 hrs,0 minutes
Lease Expires	0 days,14 hrs,28 minutes

Below the table are two buttons: "Release" and "Renew". At the bottom of the window is a "Close Window" button.

**IP Address.** The IP address that is assigned to the router.

**Subnet Mask.** The subnet mask that is assigned to the router.

**Default Gateway.** The IP address for the default gateway that the router communicates with.

**DHCP Server.** The IP address for the Dynamic Host Configuration Protocol server that provides the TCP/IP configuration for all the computers that are connected to the router.

**DNS Server.** The IP address of the Domain Name Service server that provides translation of network names to IP addresses.

**Lease Obtained.** The date and time that the lease was obtained.

**Lease Expires.** The date and time that the lease expires.

## View Attached Devices

The Attached Devices screen presents a table of all IP devices that the router has discovered on the local network. Select **Maintenance > Attached Devices** to view the following table:

**Attached Devices**

---

**Wired Devices**

#	IP Address	MAC Address	Device Name
1	192.168.1.2	00:16:41:15:6F:B1	DVOISIN

**Wireless Devices (Wireless intruders also show up here)**

#	IP Address	MAC Address	Device Name
---	------------	-------------	-------------

---

For each device, the table shows the IP address, device name if available, and the Ethernet MAC address. Note that if the router is rebooted, the table data is lost until the router rediscovers the devices. To force the router to look for attached devices, click the **Refresh** button.

## Remote Management Access

Using the Remote Management feature, you can allow a user on the Internet to configure, upgrade, and check the status of your JNR3210 router.

### To set up your router for remote management:

1. Select **Advanced > Remote Management**. The Remote Management screen displays.

**Remote Management**

---

Turn Remote Management On

---

**Remote Management Address:**  
10.1.32.90:8080

---

**Allow Remote Access By:**

Only This Computer:  .  .  .

IP Address Range: From  .  .  .   
To  .  .  .

Everyone

---

**Port Number:**

---

2. Make sure that you have changed the router's default password to a very secure password.  
The ideal password should contain no dictionary words from any language, and should be a mixture of letters (both uppercase and lowercase), numbers, and symbols. Your password can be up to 30 characters.

3. Select the **Turn Remote Management On** check box.
4. Under Allow Remote Access By, specify what external IP addresses will be allowed to access the router's remote management.

For enhanced security, restrict access to as few external IP addresses as practical.

- To allow access from any IP address on the Internet, select **Everyone**.
- To allow access from a range of IP addresses on the Internet, select **IP Address Range**.  
Enter a beginning and ending IP address to define the allowed range.
- To allow access from a single IP address on the Internet, select **Only This Computer**.  
Enter the IP address that will be allowed access.

5. Specify the port number for accessing the management interface.

Normal Web browser access uses the standard HTTP service port 80. For greater security, enter a custom port number for the remote management Web interface. Choose a number between 1024 and 65535, but do not use the number of any common service port. The default is 8080, which is a common alternate for HTTP.

6. Click **Apply** to have your changes take effect.

When accessing your router from the Internet, enter your router's WAN IP address into your browser's address or location field, followed by a colon (:) and the custom port number. For example, if your external address is 134.177.0.123 and you use port number 8080, then enter **http://134.177.0.123:8080** in your browser.

# Advanced Settings

---

# 6

## Configuring for unique situations

This chapter describes the advanced features of your router. The information is for users with a solid understanding of networking concepts who want to set the router up for unique situations such as when remote access from the Internet by IP or domain name is needed.

It contains the following sections:

- *WAN Setup*
- *Dynamic DNS*
- *LAN Setup*
- *Advanced Wireless Settings*
- *Set Up Static Routes*
- *Quality of Service*
- *Universal Plug and Play*
- *Wireless Repeating (Also Called WDS)*

For information about port triggering and port forwarding, see [Chapter 4, Content Filtering](#).

## WAN Setup

The WAN Setup screen lets you disable port scan and DoS protection, configure a DMZ (demilitarized zone) server, enable the router to respond to a ping on the WAN (Internet) port, enable IGMP proxying, and change the Maximum Transmit Unit (MTU) size.

Select **Advanced > WAN Setup** to display the following screen:

**Disable Port Scan and DOS Protection.** The firewall protects your LAN against port scans and denial of service (DOS) attacks. This protection should be disabled only in special circumstances.

**Default DMZ Server.** The default demilitarized zone (DMZ) server feature is helpful when you use online games and video conferencing applications that are incompatible with NAT. The router is programmed to recognize some of these applications and to work correctly with them, but there are other applications that might not function well. In some cases, one local computer can run the application correctly if that computer's IP address is entered as the default DMZ server.

**Respond to Ping on Internet.** If you want the router to respond to a ping from the Internet, select this check box. This should be used only as a diagnostic tool, because it allows your router to be discovered. Do not select this check box unless you have a specific reason to do so.

**Disable IGMP Proxying.** IGMP (Internet Group Management Protocol) proxying is disabled by default. When IGMP Proxying is enabled, your router acts as an IGMP-based host, forwarding IGMP messages and responding to IGMP queries.

**MTU Size (in bytes).** The normal Maximum Transmit Unit (MTU) value for most Ethernet networks is 1500 bytes, or 1492 bytes for PPPoE connections. For some ISPs you might need to reduce the MTU. But this is rarely required, and should not be done unless you are sure it is necessary for your ISP connection.



**NAT Filtering.** Network Address Translation (NAT) determines how the router processes inbound traffic. Secured NAT provides a secured firewall to protect the computers on the LAN from attacks from the Internet, but might prevent some Internet games, point-to-point applications, or multimedia applications from functioning. Open NAT provides a much less secured firewall, but allows almost all Internet applications to function.

- **Disabling the SIP ALG.** The Session Initiation Protocol (SIP) Application Level Gateway (ALG) is enabled by default to optimize VoIP phone calls that use the SIP. The Disable SIP ALG check box allows you to disable the SIP ALG. Disabling the SIP ALG might be useful when running certain applications.
- **Enable IPv6 pass-through.** Select this check box if your Internet service provider (ISP) specifies that your Internet connection uses IPv6 pass-through.

## Set Up a Default DMZ Server

---

**Note:** For security reasons, you should avoid using the default DMZ server feature. When a computer is designated as the default DMZ server, it loses much of the protection of the firewall and is exposed to many exploits from the Internet. If compromised, the computer can be used to attack your network.

---

Incoming traffic from the Internet is usually discarded by the router unless the traffic is a response to one of your local computers or a service that you have configured in the Ports screen. Instead of discarding this traffic, you can have it forwarded to one computer on your network. This computer is called the default DMZ server.

**To assign a computer or server to be a default DMZ server:**

1. In the **WAN** screen, select the **Default DMZ Server** check box
2. In the **Default DMZ Server** fields, enter the IP address for that computer or server.
3. Click **Apply**.

## Dynamic DNS

If your Internet Service Provider (ISP) gave you a permanently assigned IP address, you can register a domain name and have that name linked with your IP address by public Domain Name Servers (DNS). However, if your Internet account uses a dynamically assigned IP address, you do not know in advance what your IP address will be, and the address can change frequently. In this case, you can use a commercial Dynamic DNS service, which allows you to register your domain to their IP address, and forwards traffic directed at your domain to your frequently changing IP address.

---

**Note:** If your ISP assigns a private WAN IP address (such as 192.168.x.x or 10.x.x.x), the Dynamic DNS service does not work because private addresses are not routed on the Internet.

---

Your router contains a client that can connect to the Dynamic DNS service provided by DynDNS.org. You must first visit their website at [www.dyndns.org](http://www.dyndns.org) and obtain an account and host name, which you specify in the router. Then, whenever your ISP-assigned IP address changes, your router automatically contacts the Dynamic DNS service provider, logs in to your account, and registers your new IP address. If your host name is hostname, for example, you can reach your router at hostname.dyndns.org.

Select **Advanced > Dynamic DNS**. The Dynamic DNS screen displays.

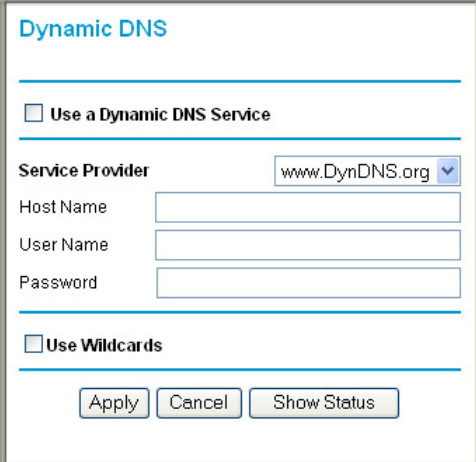

The screenshot shows the 'Dynamic DNS' configuration page. At the top, the title 'Dynamic DNS' is displayed in blue. Below the title is a horizontal line. Underneath, there is a checkbox labeled 'Use a Dynamic DNS Service'. Below this is another horizontal line. The 'Service Provider' is set to 'www.DynDNS.org' in a dropdown menu. Below the dropdown are three text input fields: 'Host Name', 'User Name', and 'Password'. Below these fields is another horizontal line. At the bottom, there is a checkbox labeled 'Use Wildcards'. At the very bottom, there are three buttons: 'Apply', 'Cancel', and 'Show Status'.

#### To configure for a Dynamic DNS service:

1. Register for an account with one of the Dynamic DNS service providers whose names appear in the **Service Provider** list. For example, for DynDNS.org, select **www.dyndns.org**.
2. Select the **Use a Dynamic DNS Service** check box.
3. Select the name of your Dynamic DNS service provider.
4. Enter the host name (or domain name) that your Dynamic DNS service provider gave you.
5. Enter the user name for your Dynamic DNS account. This is the name that you use to log in to your account, not your host name.
6. Enter the password (or key) for your Dynamic DNS account.
7. If your Dynamic DNS provider allows the use of wildcards in resolving your URL, you can select the **Use Wildcards** check box to activate this feature. For example, the wildcard feature causes \*.yourhost.dyndns.org to be aliased to the same IP address as yourhost.dyndns.org.
8. Click **Apply** to save your configuration.

## LAN Setup

The LAN Setup screen allows configuration of LAN IP services such as DHCP and Routing Information Protocol (RIP). The router is shipped preconfigured to use private IP addresses on the LAN side and to act as a DHCP server. The router's default LAN IP configuration is as follows:

- **LAN IP address.** 192.168.0.1
- **Subnet mask.** 255.255.255.0

These addresses are part of the private address range designated by the Internet Engineering Task Force (IETF <http://www.ietf.org>) for use in private networks, and should be suitable in most applications. If your network has a requirement to use a different IP addressing scheme, you can make those changes in the LAN IP Setup screen.

---

**Note:** If you change the LAN IP address of the router while connected through the browser, you are disconnected. To reconnect, open a new connection to the new IP address and log in.

---

### To configure LAN settings:

1. Select **Advanced > LAN Setup**. The LAN Setup screen displays.

**LAN Setup**

Device Name: JWNR2000v2

**LAN TCP/IP Setup**

IP Address: 192 . 168 . 1 . 1

IP Subnet Mask: 255 . 255 . 255 . 0

RIP Direction: Both

RIP Version: Disabled

Use Router as DHCP Server

Starting IP Address: 192 . 168 . 1 . 2

Ending IP Address: 192 . 168 . 1 . 254

**Address Reservation**

#	IP Address	Device Name	MAC Address

Add Edit Delete

Apply Cancel

2. Enter the configuration and click **Apply** to save your changes.

## LAN Setup Screen Fields

**Device Name.** The device name is a user-friendly name for the router. This name is shown in the Network on Windows Vista and the Network Explorer on all Windows systems. The Device Name field cannot be blank. The default name is JNR3210.

### LAN TCP/IP Setup

**IP Address.** The LAN IP address of the router.

**IP Subnet Mask.** The LAN subnet mask of the router. Combined with the IP address, the IP subnet mask allows a device to know which other addresses are local to it, and which have to be reached through a gateway or router.

**RIP Direction.** RIP allows a router to exchange routing information with other routers. The RIP Direction selection controls how the router sends and receives RIP packets. The default setting is Both.

- When set to **Both** or **Out Only**, the router broadcasts its routing table periodically.
- When set to **Both** or **In Only**, the router incorporates the RIP information that it receives.
- When set to **None**, the router does not send any RIP packets and ignores any RIP packets received.

**RIP Version.** This controls the format and the broadcasting method of the RIP packets that the router sends. It recognizes both formats when receiving. By default, this is set for RIP-1.

- **RIP-1.** This version is universally supported. It is probably adequate for most networks, unless you have an unusual network setup.
- **RIP-2.** This version carries more information. Both RIP-2B and RIP-2M send the routing data in RIP-2 format.
- **RIP-2B.** This version uses subnet broadcasting.
- **RIP-2M.** This version uses multicasting.

**Use Router as a DHCP Server.** By default, the router functions as a DHCP server, allowing it to assign IP, DNS server, and default gateway addresses to all computers connected to the router's LAN. See [Use the Router as a DHCP Server](#) on page 68.

**Address Reservation.** When you specify a reserved IP address for a computer on the LAN, that computer always receives the same IP address each time it accesses the router's DHCP server. Reserved IP addresses should be assigned to computers or servers that require permanent IP settings. See [Reserved IP Addresses Setup](#) on page 69.

## Use the Router as a DHCP Server

By default, the router functions as a DHCP server, allowing it to assign IP, DNS server, and default gateway addresses to all computers connected to the router's LAN. The assigned default gateway address is the LAN address of the router. The router assigns IP addresses to

the attached computers from a pool of addresses specified in this screen. Each pool address is tested before it is assigned to avoid duplicate addresses on the LAN.

---

**Note:** For most applications, the default DHCP and TCP/IP settings of the router are satisfactory.

---

To specify a pool of IP addresses to be assigned, set the starting IP address and ending IP address. These addresses should be part of the same IP address subnet as the router's LAN IP address. Using the default addressing scheme, you should define a range between **192.168.1.2** and **192.168.1.254**, although you might wish to save part of the range for devices with fixed addresses.

The router delivers the following parameters to any LAN device that requests DHCP:

- An IP address from the range you have defined
- Subnet mask
- Gateway IP address (the router's LAN IP address)
- Primary DNS server (if you entered a primary DNS address in the Basic Settings screen; otherwise, the router's LAN IP address)
- Secondary DNS server (if you entered a secondary DNS address in the Basic Settings screen)

To use another device on your network as the DHCP server, or to manually specify the network settings of all of your computers, clear the **Use Router as DHCP Server** check box. Otherwise, leave it selected. If this service is not selected and no other DHCP server is available on your network, you need to set your computers' IP addresses manually or they will not be able to access the router.

## Reserved IP Addresses Setup

When you specify a reserved IP address for a computer on the LAN, that computer always receives the same IP address each time it accesses the router's DHCP server. Reserved IP addresses should be assigned to servers that require permanent IP settings.

### To reserve an IP address:

1. Select **Advanced > LAN Setup** and click the **Add** button.
2. In the **IP Address** field, type the IP address to assign to the computer or server. Choose an IP address from the router's LAN subnet, such as 192.168.0.x.
3. Type the MAC address of the computer or server.

**Tip:** If the computer is already present on your network, copy its MAC address from the Attached Devices screen and paste it here.

4. Click **Apply** to enter the reserved address into the table.

---

**Note:** The reserved address is not assigned until the next time the computer contacts the router's DHCP server. Reboot the computer or access its IP configuration to force a DHCP release and renew.

---

### To edit or delete a reserved address entry:

1. Click the button next to the reserved address that you want to edit or delete.
2. Click **Edit** or **Delete**.

## Advanced Wireless Settings

Select **Advanced > Advanced Wireless Settings**. The Advanced Wireless Settings screen displays:

### Advanced Wireless Settings

- **Enable Wireless Router Radio.** If you disable the wireless router radio, wireless devices cannot connect to the JNR3210 router. If you will not be using your wireless network for a period of time, you can clear this check box and disable all wireless connectivity.
- **Fragmentation Length, CTS/RTS Threshold, Preamble Mode and Transmit Power Control.** The Fragmentation Threshold, CTS/RTS Threshold, Preamble Mode, and Transmit Power Control options are reserved for wireless testing and advanced configuration only. Do not change these settings.
- **WPS Settings.** For information about these settings, see the section, *Advanced Wireless Settings* on page 70.

- **Wireless Card Access List.** For information about this list, see [Restrict Wireless Access by MAC Address](#) on page 71.

### WPS Settings

These options are available if the settings in the Wireless Settings screen are compatible with WPS.

- **Router's PIN.** The PIN is displayed so that you can use it to configure the router through WPS (Wi-Fi Protected Setup). It is also displayed on the router's label.
- **Disable Router's PIN.** If the router's PIN is disabled, you cannot configure the router's wireless settings with WPS. However, if your settings are already configured, you can still add WPS-enabled wireless clients. The router might disable the PIN if it detects suspicious attempts to break into your wireless settings; this can happen if the check box is selected. You can enable the PIN by clearing the check box and clicking **Apply**.
- **Keep Existing Wireless Settings.** This check box is automatically selected after WPS is enabled to prevent unwanted settings changes, and is also selected if you have already specified wireless security settings or your SSID without using WPS. When this check box is *not* selected, adding a new wireless client using the push button or the Add WPS Client screen (see [Wi-Fi Protected Setup \(WPS\) Method](#) on page 30) changes the router's SSID and security passphrase. You might need to clear it if you are using certain registrars, such as for a Windows Vista PC, to configure the router through WPS.

### Wireless Card Access List

You can use this feature to restrict access by MAC address as described in the following section.

## Restrict Wireless Access by MAC Address

MAC address filtering adds an obstacle against unwanted access to your network by the general public. However, because your trusted MAC addresses appear in your wireless transmissions, an intruder can read them and impersonate them. Do not rely on MAC address filtering alone to secure your network.

When a wireless card access list is configured and enabled, the router checks the MAC address of any wireless device attempting a connection and allows only connections to computers identified on the trusted computers list.

The Wireless Card Access List displays a list of wireless computers that you allow to connect to the router based on their MAC addresses. These wireless computers must also have the correct SSID and wireless security settings to access the wireless router.

The MAC address is a network device's unique 12-character physical address, containing the hexadecimal characters 0–9, a–f, or A–F only, and separated by colons (for example, 00:09:AB:CD:EF:01). It can usually be found on the bottom of the wireless card or network interface device. If you do not have access to the physical label, you can display the MAC address using the network configuration utilities of the computer. In WindowsXP, for example, typing the `ipconfig/all` command in an MSDOS command prompt window displays the MAC address as Physical Address. You might also find the MAC addresses in the router's Attached Devices screen.

### To restrict access based on MAC addresses:

1. Select **Advanced > Wireless Settings**.
2. In the Advanced Wireless Settings screen, click **Setup Access List** to display the Wireless Card Access List.

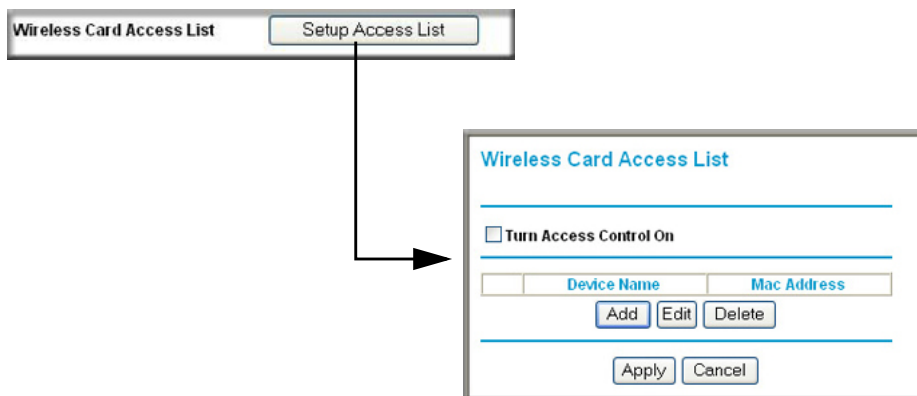

3. Click **Add** to add a wireless device to the wireless access control list. The Wireless Card Access Setup screen opens and displays a list of currently active wireless cards and their Ethernet MAC addresses.

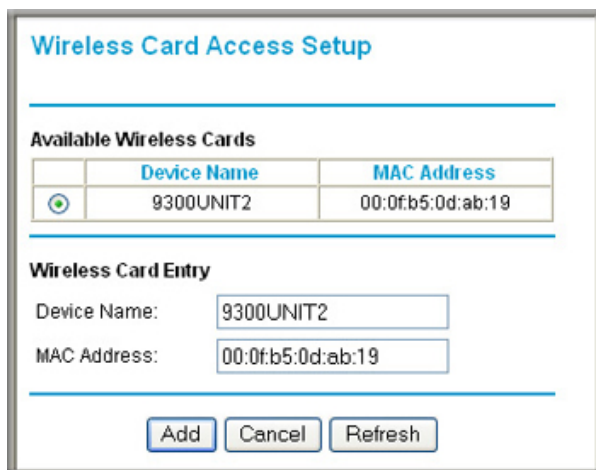

4. If the computer you want appears in the Available Wireless Cards list, you can select the radio button of that computer to capture its MAC address; otherwise, you can manually enter a name and the MAC address of the authorized computer. You can usually find the MAC address on the bottom of the wireless device.

**Tip:** You can copy and paste the MAC addresses from the router's Attached Devices screen into the MAC Address field of this screen. To do this, configure each wireless computer to obtain a wireless link to the router. The computer should then appear in the Attached Devices screen.

5. Click **Add** to add this wireless device to the Wireless Card Access List. The screen changes back to the list screen.



6. Repeat **step 3** through **step 5** for each additional device you want to add to the list.
7. Select the **Turn Access Control On** check box

When configuring the router from a wireless computer whose MAC address is not in the Trusted PC list, if you select **Turn Access Control On**, you lose your wireless connection when you click **Apply**. You must then access the router from a wired computer or from a wireless computer that is on the access control list to make any further changes.

8. Click **Apply** to save your Wireless Card Access List settings.

Now, only devices on this list can wirelessly connect to the JNR3210 router.

## Set Up Static Routes

Static routes provide additional routing information to your router. Under usual circumstances, the router has adequate routing information after it has been configured for Internet access, and you do not need to configure additional static routes. You must configure static routes only for unusual cases such as multiple routers or multiple IP subnets located on your network.

As an example of when a static route is needed, consider the following case:

- Your primary Internet access is through a cable modem to an ISP.
- You have an ISDN router on your home network for connecting to the company where you are employed. This router's address on your LAN is 192.168.1.100.
- Your company's network address is 134.177.0.0.

When you first configured your router, two implicit static routes were created. A default route was created with your ISP as the gateway, and a second static route was created to your local network for all 192.168.1.x addresses. With this configuration, if you attempt to access a device on the 134.177.0.0 network, your router forwards your request to the ISP. The ISP forwards your request to the company where you are employed, and the request is likely to be denied by the company's firewall.

In this case you must define a static route, telling your router that 134.177.0.0 should be accessed through the ISDN router at 192.168.1.100.

In this example:

- The **Destination IP Address** and **IP Subnet Mask** fields specify that this static route applies to all 134.177.x.x addresses.
- The **Gateway IP Address** field specifies that all traffic for these addresses should be forwarded to the ISDN router at 192.168.1.100.
- A **Metric** value of 1 will work since the ISDN router is on the LAN.
- **Private** is selected only as a precautionary security measure in case RIP is activated.

**To add or edit a static route:**

1. Select **Advanced > Static Routes**. The Static Routes screen displays.

The screenshot shows the 'Static Routes' configuration page. At the top, there is a title 'Static Routes'. Below it is a table with the following columns: '#', 'Active', 'Name', 'Destination', and 'Gateway'. The table is currently empty. Below the table are three buttons: 'Add', 'Edit', and 'Delete'.

2. Click **Add** to expand the Static Routes screen.

The screenshot shows the expanded 'Static Routes' configuration page. It includes the following fields and options:
 

- Route Name:** A text input field.
- Private:** An unchecked checkbox.
- Active:** A checked checkbox.
- Destination IP Address:** Four input fields for the IP address (e.g., . . .).
- IP Subnet Mask:** Four input fields for the subnet mask (e.g., . . .).
- Gateway IP Address:** Four input fields for the gateway IP address (e.g., . . .).
- Metric:** A single input field.

 At the bottom of the form are two buttons: 'Apply' and 'Cancel'.

3. In the Route Name field, enter a name for this static route. (This is for identification purposes only.)
4. Select the **Private** check box if you want to limit access to the LAN only. If Private is selected, the static route is not reported in RIP.
5. Select the **Active** check box to make this route effective.
6. In the Destination IP Address field, enter the IP address of the final destination.
7. In the IP Subnet Mask field, enter the IP subnet mask for this destination. If the destination is a single host, enter **255.255.255.255**.
8. In the Gateway IP Address field, enter the gateway IP address, which must be a router on the same LAN segment as the JNR3210 router.
9. In the Metric field, enter a number between 1 and 15 as the metric value.  
This represents the number of routers between your network and the destination. Usually, a setting of 2 or 3 works, but if this is a direct connection, set it to 1.
10. Click **Apply** to have the static route entered into the table.

## Quality of Service

Quality of Service (QoS) is an advanced feature that can be used to prioritize some types of traffic ahead of others. The JNR3210 router can provide QoS prioritization over the wireless link.

## WMM QoS for Wireless Multimedia Applications

The JNR3210 router supports Wi-Fi Multimedia Quality of Service (WMM QoS) to prioritize wireless voice and video traffic over the wireless link. WMM QoS provides prioritization of wireless data packets from different applications based on four access categories: voice, video, best effort, and background. For an application to receive the benefits of WMM QoS, both it and the client running that application must be WMM enabled. Legacy applications that do not support WMM, and applications that do not require QoS, are assigned to the best effort category, which receives a lower priority than voice and video.

## QoS for Internet Access

To specify prioritization of traffic, you must create a policy for the type of traffic and add the policy to the QoS Policy table in the QoS Setup screen.

### To create a QoS policy:

From the main menu of the browser interface, under *Advanced*, select **QoS Setup**. The QoS Setup screen displays:

WMM QoS is enabled by default. You can disable it by clearing the **Enable WMM** check box and clicking **Apply**.

### To create a QoS policy for applications or online games:

1. Select **Advanced > QoS Setup**.

- On the QoS screen, click **Setup QoS rule**. The QoS - Priority Rules screen displays.

QoS Setup

#	QoS Policy	Priority	Description
1	MSN_messenger	High	MSN_messenger application
2	Skype	Highest	Skype application
3	Yahoo_Messenger	High	Yahoo_messenger application
4	IP_Phone	Highest	IP_Phone application
5	Vonage_IP_Phone	Highest	Vonage_IP_Phone application
6	NetMeeting	High	Netmeeting application
7	AIM	High	AIM application
8	Google_Talk	Highest	Google_Talk application
9	Counter Strike	High	On-line Gaming Counter Strike
10	Age of Empires	High	On-line Gaming Age of Empires
11	Diablo II	High	On-line Gaming Diablo II
12	Everquest	High	On-line Gaming Everquest
13	Half Life	High	On-line Gaming Half Life
14	Quake 2	High	On-line Gaming Quake 2
15	Quake 3	High	On-line Gaming Quake 3
16	Unreal Tourment	High	On-line Gaming Unreal Tourment
17	Warcraft	High	On-line Gaming Warcraft
18	Return to Castle Wolfenstein	High	On-line Gaming Return to Castle Wolfenstein

For convenience, the QoS Policy table lists many common applications and online games that can benefit from QoS handling.

- Click **Add Priority Rule**. The QoS - Priority Rules screen displays.

QoS - Priority rules

**Priority**  
 QoS Policy for:   
 Priority Category:   
 Applications:   
 Priority:

- In the Priority Category list, select either **Applications** or **Online Gaming**. In either case, a list of predefined applications or games displays in the Applications drop-down list.
- From the Applications list, you can select an existing item, or you can scroll to the bottom of the list and select **Add a New Application** or **Add a New Game**.

If you chose to add a new entry, the screen expands as shown:

- a. In the QoS Policy for field, enter a descriptive name for the new application or game.
- b. Select the packet type, either **TCP**, **UDP**, or both (**TCP/UDP**), and specify the port number or range of port numbers used by the application or game.
6. From the Priority drop-down list, select the priority that this traffic should receive relative to other applications and traffic when accessing the Internet. The options are Low, Normal, High, and Highest.
7. Click **Apply** to save this rule to the QoS Policy list and return to the QoS Setup screen.
8. In the QoS Setup screen, select the **Turn Internet Access QoS On** check box.
9. Click **Apply**.

#### To create a QoS policy for a router LAN ports:

1. Select **Advanced > QoS Setup**.
2. On the QoS Setup screen, click **Add Priority Rule**.
3. From the Priority Category list, select **Ethernet LAN Port**. The QoS - Priority Rules screen changes:

4. From the LAN port list, select the LAN port that will have a QoS policy.
5. From the Priority drop-down list, select the priority that this port's traffic should receive relative to other applications and traffic when accessing the Internet. The options are Low, Normal, High, and Highest.
6. Click **Apply** to save this rule to the QoS Policy list and return to the QoS Setup screen.
7. In the QoS Setup screen, select the **Turn Internet Access QoS On** check box.

8. Click **Apply**.

## QoS for a MAC Address

### To create a QoS policy for traffic from a specific MAC address:

1. Select **Advanced > QoS Setup**. The QoS Setup screen displays.
2. On the QoS Setup screen, click **Add Priority Rule**.
3. From the Priority Category list, select **MAC Address**. The QoS - Priority Rules screen changes:

QoS - Priority rules

Priority  
QoS Policy for  
Priority Category: MAC Address

MAC Device List			
QoS Policy	Priority	Device Name	MAC Address
Pri_MAC_59F408	Normal	DELL	00:0D:56:59:F4:08

MAC Address  
Device Name  
Priority: Normal

Add Edit Delete Refresh

Apply Cancel

4. If the device to be prioritized appears in the MAC Device List, select it. The information from the MAC Device List is used to populate the policy name, MAC Address, and Device Name fields. If the device does not appear in the MAC Device List, click **Refresh**. If it still does not appear, you must complete these fields manually.
5. From the Priority drop-down list, select the priority that this device's traffic should receive relative to other applications and traffic when accessing the Internet. The options are Low, Normal, High, and Highest.
6. Click **Apply** to save this rule to the QoS Policy list and return to the QoS Setup screen.
7. In the QoS Setup screen, select the **Turn Internet Access QoS On** check box.
8. Click **Apply**.

### To edit or delete an existing QoS policy:

1. Select **Advanced > QoS Setup**. The QoS Setup screen displays.
2. On the QoS Setup screen, select the radio button next to the QoS policy to be edited or deleted, and do one of the following:
  - Click **Delete** to remove the QoS policy.
  - Click **Edit** to edit the QoS policy. Follow the instructions in the preceding sections to change the policy settings.
3. Click **Apply** in the QoS Setup screen to save your changes.

## Traffic Meter

Traffic Metering allows you to monitor the volume of Internet traffic passing through your router's Internet port. With the Traffic Meter utility, you can set limits for traffic volume, set a monthly limit, and get a live update of traffic usage.

**To monitor traffic on your router, do the following:**

1. Select **Advanced > Traffic Meter**.

### Traffic Meter

---

**Internet Traffic Meter**

Enable Traffic Meter

Traffic volume control by No limit

Monthly Limit  Mbytes

Round up data volume for each connection by  Mbytes

Connection time control

Monthly Limit  hours

---

**Traffic Counter**

Restart traffic counter at  :  am  On the  day of each month

---

**Traffic Control**

Pop up a warning message

Mbytes/Minutes before the monthly limit is reached

When the monthly limit is reached

Turn the Internet LED to flashing green/amber

Disconnect and disable the Internet connection

---

**Internet Traffic Statistics**

start date / time: Wed Dec 31 16:00:00 1969

Current(s) Date / Time: Fri Dec 31 16:00:36 2009

Remaining data volume: 0 Bytes

Counting Period	Connection Time (hh:mm)	Traffic Volume (Mbytes)		
		Upload/Avg	Download/Avg	Total/Avg
Today	0.0	0.00	0.00	0.00
Yesterday	0.0	0.00	0.00	0.00
This week	0.0	0.00/0.00	0.00/0.00	0.00/0.00
This month	0.0	0.00/0.00	0.00/0.00	0.00/0.00
Last month	0.0	0.00/0.00	0.00/0.00	0.00/0.00

2. Select the **Enable Traffic Meter** check box.
3. Click **Apply**.

## Universal Plug and Play

Universal Plug and Play (UPnP) helps devices, such as Internet appliances and computers, to access the network and connect to other devices as needed. UPnP devices can automatically discover the services from other registered UPnP devices on the network.

---

**Note:** If you use applications such as multiplayer gaming, peer-to-peer connections, real-time communications such as instant messaging, or remote assistance (a feature in Windows XP), you should enable UPnP.

---

### To turn on Universal Plug and Play:

1. Select **Advanced > UPnP**. The UPnP screen displays.

Active	Protocol	Int. Port	Ext. Port	IP Address
Yes	TCP	9198	11913	192.168.0.2
Yes	UDP	5339	7102	192.168.0.2

2. The available settings and information displayed in this screen are:
  - **Turn UPnP On.** UPnP can be enabled or disabled for automatic device configuration. The default setting for UPnP is disabled. If this check box is not selected, the router does not allow any device to automatically control the resources, such as port forwarding (mapping) of the router.
  - **Advertisement Period.** The advertisement period is how often the router broadcasts its UPnP information. This value can range from 1 to 1440 minutes. The default period is 30 minutes. Shorter durations ensure that control points have current device status at the expense of additional network traffic. Longer durations might compromise the freshness of the device status but can significantly reduce network traffic.
  - **Advertisement Time To Live.** The time to live for the advertisement is measured in hops (steps) for each UPnP packet sent. The time to live hop count is the number of steps a broadcast packet is allowed to propagate for each UPnP advertisement before it disappears. The number of hops can range from 1 to 255. The default value for the advertisement time to live is 4 hops, which should be fine for most home



networks. If you notice that some devices are not being updated or reached correctly, then it might be necessary to increase this value.

- **UPnP Portmap Table.** The UPnP Portmap Table displays the IP address of each UPnP device that is currently accessing the router and which ports (Internal and External) that device has opened. The UPnP Portmap Table also displays what type of port is open and whether that port is still active for each IP address.

3. Click **Apply** to save your settings.

## Wireless Repeating (Also Called WDS)

The router can be used with a wireless access point (AP) to build large bridged wireless networks. Wireless repeating is a type of Wireless Distribution System (WDS).



### WARNING!

If you use the wireless repeating function, your options for wireless security are limited to **None** or **WEP**. For more information about wireless security, see [Wireless Settings](#) on page 27.

The following figure shows a wireless repeating scenario:

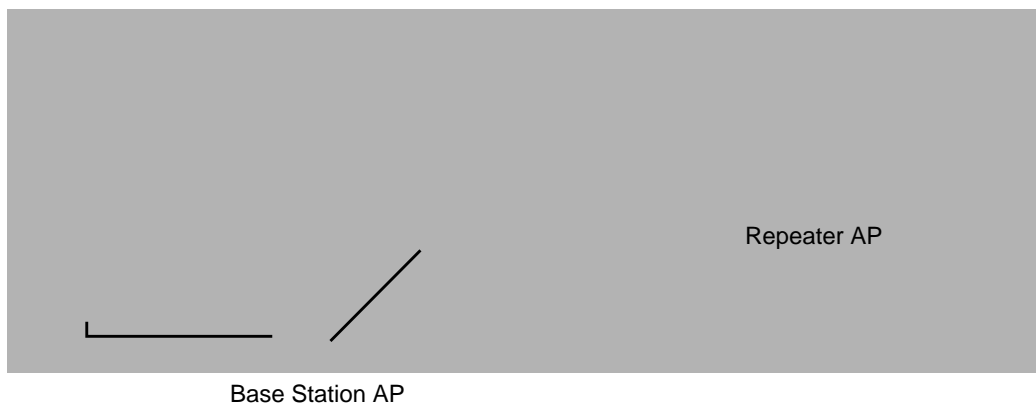

**Figure 1. Wireless repeating example**

To set up a wireless network using WDS, the following conditions must be met for both APs:

- Both APs must use the same SSID, wireless channel, and encryption mode.
- Both APs must be on the same LAN IP subnet. That is, all the access point LAN IP addresses are in the same network.
- All LAN devices (wired and wireless computers) must be configured to operate in the same LAN network address range as the APs.
- If you make changes in the Wireless Settings screen, click **Apply** so that they take effect.

## Wireless Repeating Function

You can view or change wireless repeater settings for the router. From the main menu of the browser interface, under Advanced, click **Wireless Repeating Function** to display the Wireless Repeating Function screen.

**Wireless Repeating Function**

Enable Wireless Repeating Function

Disable Wireless Client Association

Wireless MAC of this router e0:91:f5:be:eb:e9

**Wireless Repeater**

Repeater IP Address: 192 . 168 . 1 .

Base Station MAC Address:

**Wireless Base Station**

Repeater MAC Address 1:

Repeater MAC Address 2:

Repeater MAC Address 3:

Repeater MAC Address 4:

The router supports two modes of the wireless repeating function, and allows you to control wireless client association:

- **Wireless Repeater.** The router sends all traffic from its local wireless or wired computers to a remote access point. To configure this mode, you must know the MAC address of the remote parent access point.
- **Wireless Base Station.** The router acts as the parent access point, bridging traffic to and from the child repeater access point, as well as handling wireless and wired local computers. To configure this mode, you must know the MAC addresses of the child repeater access point.
- **Disable Wireless Client Association.** Usually this check box is cleared so that the router is an access point for wireless computers.

If this check box is selected, the router communicates wirelessly only with other APs whose MAC addresses are listed in this screen. The router still communicates with wire-connected LAN devices.

## Set Up the Base Station

The wireless repeating function works only in hub and spoke mode. The units cannot be daisy chained. You must know the wireless settings for both units. You must know the MAC address of the remote unit. First, set up the base station, and then set up the repeater.

### To set up the base station:

1. Set up both units with exactly the same wireless settings (SSID, mode, channel, and security). Note that the wireless security option must be set to **None** or **WEP**.

2. Log into the router base unit, under the Advanced heading, select **Wireless Repeating Function** to display the Wireless Repeating Function screen.

3. Select the **Enable Wireless Repeating Function** check box and the **Wireless Base Station** radio button.
4. Enter the MAC address for the repeater units.
5. Click **Apply** to save your changes.

## Set Up a Repeater Unit

Use a wired Ethernet connection to set up the repeater unit to avoid conflicts with the wireless connection to the base station.

---

**Note:** If you are using the JNR3210 base station with a non-NETGEAR router as the repeater, you might need to change additional configuration settings. In particular, you should disable the DHCP server function on the wireless repeater access point.

---

### To configure a JNR3210 router as a repeater unit:

1. If you are using the same model of router for both the base station and repeaters, you must change the LAN IP address for each repeater to a different IP address in the same subnet (see [LAN Setup](#) on page 67).

---

**Note:** Failing to change the LAN IP address will cause an IP address conflict in the network because the factory default LAN IP is the same for both units.

---

2. Log in to the router that will be the repeater. Check the Wireless Settings screen, and verify that the wireless settings match the base station exactly. If the settings are different, be sure to configure the wireless settings to match the base station settings (see [Wireless Settings](#) on page 31).
3. In the Wireless Repeating Function screen, select the **Enable Wireless Repeating Function** check box and the **Wireless Repeater** radio button.
4. Fill in the **IP Address** field. This IP address must be in the same subnet as the base station, but different from the LAN IP of the base station.
5. Fill in the **Base Station MAC Address** field.
6. Click **Apply** to save your changes.
7. Verify connectivity across the LANs.

A computer on any wireless or wired LAN segment of the router should be able to connect to the Internet or share files and printers with any other wireless or wired computer or server connected to the other access point.

# 7 Troubleshooting

---

# 7

This chapter provides information about troubleshooting your N300 Wireless Gigabit Router with USB Model JNR3210. After each problem description, instructions are provided to help you diagnose and solve the problem. As a first step, please review the Quick Tips.

**Tip:** NETGEAR provides helpful articles, documentation, and the latest software updates at <http://www.netgear.com/support>.

This chapter includes the following sections:

- *Quick Tips*
- *Troubleshooting Basic Functions*
- *Login Problems*
- *Check the Internet Service Connection*
- *Troubleshoot Your Network Using the Ping Utility*
- *Problems with Date and Time*
- *Problems with Wireless Adapter Connections*
- *Restore the Default Configuration and Password*

## Quick Tips

This section describes tips for troubleshooting some common problems:

### **Be sure to restart your network in this sequence.**

1. Turn off *and* unplug the modem.
2. Turn off the router and computers.
3. Plug in the modem and turn it on. Wait 2 minutes.
4. Turn on the router and wait 1 minute.
5. Turn on the computers.

### **Make sure that the Ethernet cables are securely plugged in.**

- The Internet status LED on the router is on if the Ethernet cable connecting the router and the modem is plugged in securely and the modem and router are turned on.
- For each powered-on computer connected to the router by an Ethernet cable, the corresponding numbered router LAN port LED is on.

### **Make sure that the wireless settings in the computer and router match exactly.**

- For a wirelessly connected computer, the wireless network name (SSID) and WEP or WPA security settings of the router and wireless computer must match exactly.
- If you have enabled the router to restrict wireless access by MAC address, you must add the wireless computer's MAC address to the router's wireless card access list.

### **Make sure that the network settings of the computer are correct.**

- LAN connected computers must be configured to obtain an IP address automatically using DHCP.
- Some cable modem services require you to use the MAC address of the computer registered on the account. If so, in the Router MAC Address section of the Basic Settings menu, select **Use this Computer's MAC Address**. Click **Apply** to save your settings. Restart the network in the correct sequence.

## Troubleshooting Basic Functions

After you turn on power to the router, the following sequence of events should occur:

1. When power is first applied, verify that the power/check icon  is on.
2. Verify that the Power/check LED turns green and blinks slowly, indicating that the system is initializing.
3. After approximately 20 seconds, verify that:
  - a. The Power/Check LED changes to solid green.
  - b. The LAN port lights are lit for any local ports that are connected.

If a port's LED is lit, a link has been established to the connected device. If a LAN port is connected to a 100 Mbps device, verify that the port's LED is green. If the port is 10 Mbps, the LED is amber.

- c. The Internet port is connected and its LED is lit.
- 4. If you have enabled WPS security, verify that the WPS LED stops blinking and changes to green (otherwise the WPS LED should be off).

If the correct behavior does not occur, see the appropriate following section.

#### **The Power/Check LED is off.**

If the Power and other lights are off when your router is turned on:

- Make sure that the power cord is properly connected to your router and that the power adapter is properly connected to a functioning power outlet.
- Check that you are using the power adapter supplied by NETGEAR for this product.

If the error persists, you have a hardware problem and should contact Technical Support.

#### **The Power/Check LED blinks green slowly and continuously (Case 1).**

The router firmware is corrupted or system initialization has failed.

To restore your firmware:

1. Make sure your PC is connected to your router and the router is powered on.
2. Download the firmware from the NETGEAR support page.
3. Follow the instructions to restore your firmware.
4. After firmware recovery is complete, follow the prompts to restore your configuration settings.

#### **The Power/Check LED blinks green slowly and continuously (Case 2).**

If the Power/Check LED continues to blink for over 1 minute after powering on power to the router:

1. Turn the power off and back on to see if the router recovers.
2. Clear the router's configuration to factory defaults. This will set the router's IP address to 192.168.1.1. This procedure is explained in *Restore the Default Configuration and Password* on page 94.

If the error persists, you might have a hardware problem and should contact Technical Support.

#### **The Internet or LAN port lights are not on.**

If a LAN or Internet LED does not light when the Ethernet connection is made, check the following:

1. Make sure that the Ethernet cable connections are secure at the router and at the computer.
2. Make sure that power is turned on to the connected computer.

3. Be sure you are using Ethernet cables like the cable that was supplied with the router. See the *NETGEAR Wireless Router Setup Manual* for instructions.

## Login Problems

If you are unable to log in to the router, check the following:

- If you are using an Ethernet-connected computer, check the Ethernet connection between the computer and the router as described in the *NETGEAR Wireless Router Setup Manual*.
- Make sure you are using the correct login information. The factory default login name is **admin** and the password is **password**. Make sure that the Caps Lock is off when entering this information.
- Make sure your computer's IP address is on the same subnet as the router. If you are using the recommended addressing scheme, your computer's address should be in the range of 192.168.1.2 to 192.168.1.254. Refer to your computer's documentation.

---

**Note:** If your computer cannot reach a DHCP server, some operating systems will assign an IP address in the range 169.254.x.x. If your IP address is in this range, verify that you have a good connection from the computer to the router, then restart (reboot) your computer.

---

- If your router's IP address has been changed and you don't know the current IP address, reset the router's configuration to the factory defaults. This procedure will reset the router's IP address to 192.168.1.1 (see *Factory Default Settings* in Appendix A).
- Make sure your browser has Java, JavaScript, or ActiveX enabled. If you are using Internet Explorer, click Refresh to be sure the Java applet is loaded. Try closing the browser and reopening it again.
- If you are attempting to set up your NETGEAR router as an additional router behind an existing router in your network, consider replacing the existing router instead. NETGEAR does not support such a configuration.
- If you are attempting to set up your NETGEAR router as a replacement for an ADSL gateway in your network, the router cannot perform many gateway services, for example, converting ADSL or Cable data into Ethernet networking information. NETGEAR does not support such a configuration.



## Check the Internet Service Connection

If you can access your router, but your router is unable to access the Internet, review the topics in this section:

- [Obtaining an Internet IP Address](#)
- [Troubleshooting PPPoE](#)
- [Troubleshooting Internet Browsing](#)

### Obtaining an Internet IP Address

If your router is unable to access the Internet, and your Internet LED is amber, check the router to see if it is able to get an Internet IP address from your service provider. Unless you have a static IP address, your router automatically requests an IP address from your service provider.

#### To check your router's Internet IP address:

1. Log in to the router.
2. Select **Maintenance > Router Status** to check that an IP address is shown for the Internet Port. If 0.0.0.0 is shown, your router has not obtained an IP address from your service provider.

If your router is unable to obtain an IP address from the your service provider, the problem might be one of the following:

- You might need to force your cable or DSL modem to recognize your new router by restarting your network, in the sequence described in the *NETGEAR Wireless Router Setup Manual*.
- Your service provider might require a login. Ask your service provider whether they require a PPP over Ethernet (PPPoE) login (see [Troubleshooting PPPoE](#) on page 90).
- You might have incorrectly set the service name, user name or password. Review your router's **Basic Settings** screen.
- Your service provider might check for your computer's host name. Assign the computer Host Name of your ISP account to the router on the **Basic Settings** screen.
- Your service provider might only allow one Ethernet MAC address to connect to the Internet, and check for your computer's MAC address. If this is the case:
  - Inform your service provider that you have bought a new network device, and ask them to use the router's MAC address, or
  - Configure your router to spoof your computer's MAC address. On the **Basic Settings** screen in the Router MAC Address section, select "Use this Computer's MAC Address" and click **Apply**. Then restart your network in the correct sequence (see the *NETGEAR Wireless Router Setup Manual* for instructions).

## Troubleshooting PPPoE

If you are using PPPoE, try troubleshooting your Internet connection.

### To troubleshoot a PPPoE connection:

1. Log in to the router.
2. Select **Maintenance > Router Status**.
3. Click **Connection Status**. If all of the steps indicate “OK,” then your PPPoE connection is up and working.

If any of the steps indicate “Failed,” you can attempt to reconnect by clicking **Connect**. The router will continue to attempt to connect indefinitely.

If you cannot connect after several minutes, you might be using an incorrect service name, user name, or password. There also might be a provisioning problem with your ISP.

---

**Note:** Unless you connect manually, the router will not authenticate using PPPoE until data is transmitted to the network.

---

## Troubleshooting Internet Browsing

If your router can obtain an IP address but your computer is unable to load any web pages from the Internet, check the following:

- **Your computer might not recognize any DNS server addresses.** A DNS server is a host on the Internet that translates Internet names (such as www addresses) to numeric IP addresses. Typically, your ISP will provide the addresses of one or two DNS servers for your use. If you entered a DNS address during the router’s configuration, restart your computer. Alternatively, you can configure your computer manually with a DNS address, as explained in the documentation for your computer.
- **Your computer might not have the router configured as its default gateway.** Reboot the computer and verify that the router address (192.168.1.1) is listed by your computer as the default gateway address.
- **You might be running login software that is no longer needed.** If your ISP provided a program to log you in to the Internet (such as WinPoET), you no longer need to run that software after installing your router. You might need to go to Internet Explorer and select **Tools > Internet Options**, click the Connections tab, and select **Never dial a connection**.

If the router does not save changes you have made in the browser interface, check the following:

- When entering configuration settings, be sure to click **Apply** before moving to another screen or tab, or your changes could be lost.

- Click **Refresh** or **Reload** in the Web browser. The changes might have occurred, but the Web browser might be caching the old configuration.

## Troubleshoot Your Network Using the Ping Utility

Most network devices and routers contain a ping utility that sends an echo request packet to the designated device. The device then responds with an echo reply. Troubleshooting a network is made very easy by using the ping utility in your computer or workstation. This section includes:

- *Test the LAN Path to Your Router*
- *Test the Path from Your Computer to a Remote Device*

### Test the LAN Path to Your Router

You can ping the router from your computer to verify that the LAN path to your router is set up correctly.

#### To ping the router from a running Windows PC:

1. From the Windows toolbar, click **Start**, and then select **Run**.
2. In the field provided, type **ping** followed by the IP address of the router, as in this example:  
`ping www.routerlogin.net`
3. Click **OK**.

You should see a message like this one:

```
Pinging <IP address > with 32 bytes of data
```

If the path is working, you see this message:

```
Reply from < IP address >: bytes=32 time=NN ms TTL=xxx
```

If the path is not working, you see this message:

```
Request timed out
```

If the path is not functioning correctly, you could have one of the following problems:

- Wrong physical connections
  - For a wired connection, make sure that the numbered LAN port LED is on for the port to which you are connected. If the LED is off, follow the instructions in [Troubleshooting Basic Functions](#) on page 86.
  - Check that the appropriate LEDs are on for your network devices. If your router and computer are connected to a separate Ethernet switch, make sure that the link lights are on for the switch ports that are connected to your computer and router.
- Wrong network configuration

- Verify that the Ethernet card driver software and TCP/IP software are both installed and configured on your computer.
- Verify that the IP address for your router and your computer are correct and that the addresses are on the same subnet.

## Test the Path from Your Computer to a Remote Device

After verifying that the LAN path works correctly, test the path from your computer to a remote device.

1. From the Windows toolbar, click the **Start** button, and then select **Run**.
2. In the Windows Run window, type:

```
ping -n 10 <IP address>
```

where <IP address> is the IP address of a remote device such as your ISP's DNS server.

If the path is functioning correctly, replies like those shown in the previous section are displayed. If you do not receive replies:

- Check that your computer has the IP address of your router listed as the default gateway. If the IP configuration of your computer is assigned by DHCP, this information is not be visible in your computer's Network Control Panel. Verify that the IP address of the router is listed as the default gateway.
- Check to see that the network address of your computer (the portion of the IP address specified by the subnet mask) is different from the network address of the remote device.
- Check that your cable or DSL modem is connected and functioning.
- If your ISP assigned a host name to your computer, enter that host name as the account name in the Basic Settings screen.
- Your ISP could be rejecting the Ethernet MAC addresses of all but one of your computers. Many broadband ISPs restrict access by allowing traffic only from the MAC address of your broadband modem, but some ISPs additionally restrict access to the MAC address of a single computer connected to that modem. If this is the case, you must configure your router to "clone" or "spoof" the MAC address from the authorized computer.

## Problems with Date and Time

Select **Content Filtering > Email** to display a screen that shows the current date and time of day. The JNR3210 router uses the Network Time Protocol (NTP) to obtain the current time from one of several network time servers on the Internet. Each entry in the log is stamped with the date and time of day. Problems with the date and time function can include the following:

- Date shown is January 1, 2000.  
Cause: The router has not yet successfully reached a network time server. Check that your Internet access settings are correct. If you have just completed configuring the router, wait at least 5 minutes, and check the date and time again.

- Time is off by one hour.  
Cause: The router does not adjust for daylight savings time. In the E-mail screen, select the **Automatically Adjust for Daylight Savings Time** check box.

## Problems with Wireless Adapter Connections

If your wireless adapter is unable to connect, check its connection settings.

### To check the adapter's connection settings:

1. Open the adapter setup utility to check connections:
  - **NETGEAR Smart Wizard utility.** If you installed a NETGEAR wireless adapter in your computer, a Smart Wizard utility program is installed that can provide helpful information about your wireless network. You can find this program in your Windows Program menu or as an icon in your system tray. Other wireless card manufacturers might include a similar program.
  - **Windows basic setup utility.** If you have no specific wireless card setup program installed, you can use the basic setup utility in Windows:
    - Open the Windows Control Panel, and double-click **Network Connections**.
    - In the LAN section, double-click **Wireless Network Connection**.
2. Use the adapter's setup program to scan for available wireless networks, looking for the network name (SSID) of **NETGEAR**, or your custom SSID if you have changed it.
3. If your wireless network appears and has good signal strength, configure and test with the simplest wireless connection possible.

If your wireless network does not appear, check these conditions:

- Is your router's wireless radio enabled? See [Click Apply to save your settings.](#) on page 36.
- Is your router's SSID broadcast enabled? See [Click Apply to save your settings.](#) on page 36.
- Is your router set to a wireless standard that is not supported by your wireless adapter? Check the Mode setting as described in [Wireless Settings Screen Fields](#) on page 33.

If your wireless network appears, but the signal strength is weak, check these conditions:

- Is your router too far from your adapter, or too close? Place the computer that has the adapter near the router, but at least 6 feet away, and see whether the signal strength improves.
- Is your wireless signal obstructed by objects between the router and your adapter? See [Optimize Wireless Performance](#) on page 76.

## Restore the Default Configuration and Password

This section explains how to restore the factory default configuration settings that reset the router's user name to **admin**, the password to **password**, and the IP address to **192.168.1.1**.



### WARNING!

**These procedures erase all current configuration settings.**

You can erase the current configuration and restore factory defaults in two ways:

- Use the Erase function of the router. To use the Erase function, see [Erase](#) on page 57.
- Use the restore factory settings button on the rear panel of the router. Use this method for cases when the administration password or IP address is not known.

#### To use the restore settings button:

1. Locate the restore factory settings button on the rear panel of the router.
2. Use a sharp object such as a pen or a paper clip to press and hold the **restore factory settings** button for about 5 seconds, until the Power/Check LED begins to blink.
3. Release the restore factory settings button, and wait for the router to restart, and for the Power/Check LED to stop blinking and become solid green.

The factory default settings will be restored so that you can access the router from your Web browser using the factory defaults.

If the router fails to restart, or the Power/Check LED continues to blink or turns solid amber, the unit might be defective. If the error persists, you might have a hardware problem and should contact Technical Support at <http://www.netgear.com/support>.

A.

# Supplemental Information

---



This appendix provides factory default settings and technical specifications for the router

- *Factory Default Settings*
- *Specifications*

## Factory Default Settings

**Table 1. Router Default Settings**

Feature	Default Setting
Router Login URL	http://www.routerlogin.net or http://www.routerlogin.com
Login name (case-sensitive)	admin (printed on product label)
Login password (case-sensitive)	password (printed on product label)
WAN MAC address	Default hardware address (on label)
MTU Size	1500
LAN IP address (gateway IP address)	192.168.1.1 (printed on product label)
Router subnet	255.255.255.0
DHCP server	Enabled
DHCP range	192.168.1.2 to 192.168.1.254
Time zone	GMT
Adjust for daylight saving time	Disabled
Allow a registrar to configure this router	Enabled
Wireless communication	Enabled
SSID Name	NETGEAR
Security	Disabled
Wireless access list (MAC Filtering)	All wireless stations allowed
Broadcast SSID	Enabled
Transmission speed	Auto*
Country/Region	United States in NA only, otherwise varies by country and region
RF channel	6 until region selected
Operating mode	145 Mbps
Data rate	Best
Output power	Full
Inbound communication from the Internet	Disabled (bars unsolicited requests except traffic on port 80, the http port)
Outbound communication to the Internet	Enabled (all)

\*. Maximum wireless signal rate derived from IEEE Standard 802.11 specifications. Actual throughput will vary. Network conditions and environmental factors, including volume of network traffic, building materials and construction, and network overhead lower actual data throughput rate.



## Specifications

**Table 2. Router Technical Specifications**

Feature	Specification
Data and routing protocols	TCP/IP, RIP-1, RIP-2, DHCP, PPPoE, PPTP, Bigpond, Dynamic DNS, and UPnP
Power adapter	<ul style="list-style-type: none"> <li>• North America: 120V, 60 Hz, input</li> <li>• UK, Australia: 240V, 50 Hz, input</li> <li>• Europe: 230V, 50 Hz, input</li> <li>• Japan: 100V, 50/60 Hz, input</li> <li>• All regions (output): 12V DC @ 1.0A, output</li> </ul>
Dimensions	6.8" x 4.6" x 1.4" 172.7 x 115.7 x 32.6 mm
Weight	0.48 lbs. 0.216 kg
Operating temperature	0° to 40° C (32° to 104° F)
Operating humidity	90% maximum relative humidity, noncondensing
Designed to conform to the following standards	CCC SRRC
LAN	10BASE-T or 100BASE-Tx, RJ-45
WAN	10BASE-T or 100BASE-Tx, RJ-45

# B Notification of Compliance

---



## GPL License Agreement

GPL may be included in this product; to view the GPL license agreement go to <ftp://downloads.netgear.com/files/GPLnotice.pdf>.

For GNU General Public License (GPL) related information, please visit [http://support.netgear.com/app/answers/detail/a\\_id/2649](http://support.netgear.com/app/answers/detail/a_id/2649).

## Interference Reduction Table

The table below shows the Recommended Minimum Distance between NETGEAR equipment and household appliances to reduce interference (in feet and meters).

Household Appliance	Recommended Minimum Distance (in feet and meters)
Microwave ovens	30 feet / 9 meters
Baby Monitor - Analog	20 feet / 6 meters
Baby Monitor - Digital	40 feet / 12 meters
Cordless phone - Analog	20 feet / 6 meters
Cordless phone - Digital	30 feet / 9 meters
Bluetooth devices	20 feet / 6 meters
ZigBee	20 feet / 6 meters

# Index

## A

- access
  - blocking **39**
  - remote **61**
  - restricting by MAC address **71**
  - viewing logs **45**
- access control
  - turning on **73**
- access points **81**
- adding
  - custom service **48**
  - priority rules **76**
  - reserved IP addresses **68**
  - static routes **74**
  - See also configuring
- addresses, DNS **24**
- advanced wireless settings **70**
- advertisement period **80**
- AES (Advanced Encryption Standard) encryption **34**
- alerts, emailing **44**
- Application Level Gateway (ALG), disabling **65**
- applications, QoS for **76**
- attached devices, viewing **61**
- automatic firmware checking **54**
- automatic Internet connection **21**

## B

- back panel **9**
- backing up configuration **56**
- base station, setting up **82**
- Basic Settings screen
  - described **22**
- blocking
  - access **39**
  - inbound traffic **46**
- blocking keywords, examples **40**
- blocking settings examples **40**
- box contents **7**

## C

- cables, checking **86**
- cablings
  - Ethernet **11**
- channel, frequency **33**
- communication mode **33**
- compliance **98**
- configuration file
  - backing up **56**
  - erase **57**
  - erasing **57**
  - managing **56**
  - restoring **57**
- configuring
  - advanced security **70**
  - Dynamic DNS **66**
  - LAN IP settings **67**
  - NAT **65**
  - port forwarding **47**
  - port triggering **47, 50**
  - repeater unit **83**
  - See also adding
- connecting wirelessly **10**
- connection mode **23**
- content filtering **38**
- country setting **21**
- CTS/RTS Threshold **70**
- custom service (port forwarding) **48**

## D

- date and time, troubleshooting **92**
- daylight savings time **43, 93**
- default factory settings
  - restoring **57, 94**
- deleting configuration **57**
- denial of service (DoS)
  - port scans **64**
  - protection **38**
- device name **68**
- devices, adding **30**
- DHCP server **68**
- disable SSID **28**

disabling  
  firewalls **24**  
  router PIN **71**  
  SIP ALG **65**  
  SSID broadcast **28**  
  wireless client association **82**  
Domain Name Server (DNS) addresses **24**  
Domain Name Server (DNS), secondary **24**  
DSL port settings **58**  
Dynamic DNS **65**  
DynDNS.org **66**

## E

email notices **44**  
encryption keys **36**  
erasing configuration **57**  
erasing configuration file **57**  
Ethernet cable **11**

## F

factory default settings  
  restoring **57, 94**  
factory settings  
  resetting **7**  
filtering content **38**  
firewalls  
  outbound rules **40**  
firmware  
  automatic check **54**  
  restoring **87**  
  upgrade **54**  
  upgrade at log in **18**  
  upgrade manually **55**  
Fragmentation Threshold **70**  
frequency, channel **33**  
front panel **8**  
  LEDs described **8**

## G

games, QoS for **76**  
gateway IP address **24**  
generating encryption keys **36**

## H

host name **22**  
host trusted **40**

## I

inbound traffic, allowing or blocking **46**  
installing  
  Setup Wizard **21**  
Internet port **21**  
Internet port, no connection **25**  
Internet Service Provider (ISP), see ISP  
interval, poll **60**  
IP address  
  DHCP **16**  
  LAN service **67**  
  reserved **69**  
IP addresses  
  blocking access by **42**  
  registering domain name **65**  
  reserved **68**  
IP setup, LAN **67**  
ISP  
  account information **16**  
  Basic Settings screen **22**  
ISP login **16**

## K

keys, encryption **36**  
keywords  
  blocking **39**  
  deleting **40**

## L

L2TP **23**  
LAN  
  ports **59**  
LAN path, troubleshooting **91**  
LAN port  
  QoS for **77**  
language setting **21**  
LEDs  
  verifying cabling **14**  
Legacy mode **33**  
local servers, port forwarding to **47**  
logging in  
  changing password **25**  
  ISP **16**  
  router **17**  
  types **26**  
  upgrade firmware **18**  
login time-out **25**  
logs  
  viewing **45**  
logs, emailing **44**

**M**

MAC addresses  
 described **28**  
 QoS for **75, 78**  
 restricting access by **71**  
 spoofing **89**

maintenance settings **53**

managing router remotely **61**

manual logout **26**

Maximum Transmit Unit (MTU) **64**

menus, described **19**

metric value **74**

mixed mode encryption **34**

mixed mode security options **29**

mode, communication **33**

multicasting **68**

**N**

NAT (Network Address Translation) **65**

Neighbor Friendly mode **33**

Network Address Translation (NAT) **24**

Network Time Protocol (NTP) **42, 92**

no Internet connection **25**

**O**

On/Off LED **8**

online games, QoS for **76**

online help, router **19**

Open System authentication **36**

**P**

passphrases **35, 36**

password  
 restoring **94**

path, testing **92**

Performance mode **34**

PIN **71**

ping **91**

pinging WAN port **64**

poll interval **60**

port forwarding  
 configuring **47**

port scanning, disabling **64**

port status **59**

port triggering  
 configuring **47, 50**

portmap table **81**

ports  
 filtering **40**  
 listed, back panel **9**

positioning the router **10**

Power light, troubleshooting and **86**

PPPoE **23**

PPTP **23**

PPTP (Point to Point Tunneling Protocol) **23**

Preamble mode **70**

primary DNS addresses **24**

prioritizing traffic **74**

Push 'N' Connect **88**

**Q**

QoS (Quality of Service) **74**

**R**

radio, wireless **70**

range of wireless connections **10**

region of operation **33**

remote devices, testing path **92**

remote management **61**

repeater units **83**

replace existing router **16**

reserved IP address **69**

reserved IP addresses **68**

restarting network **86**

restore  
 configuration file **57**

restoring  
 default factory settings **57, 94**

restoring firmware **87**

restricting access by MAC address **71**

route name **74**

router interface, described **19**

router PIN **71**

router, status **58**

Routing Information Protocol (RIP) **67**

**S**

secondary DNS **24**

security **28**  
 see also security options

security features **28**

security options  
 described **29**  
 settings **29**

security PIN **31, 71**

- security settings **38**
- sending logs by email **44**
- service numbers **41**
- services **40**
- Session Initiation Protocol (SIP), disabling **65**
- setting time zone **42**
- settings, default. See default factory settings
- Setup Wizard **21**
- Shared Key authentication **36**
- Simple Mail Transfer Protocol (SMTP) **44**
- sites, blocking **39**
- specifications
  - technical **95**
- spoofing MAC addresses **89**
- SSID **33**
  - disable **28**
- static routes **73**
- statistics, viewing **59**
- status
  - Internet connection **60**
  - router **58**

## **T**

- TCP/IP
  - no Internet connection **25**
- TCP/IP network, troubleshooting **91**
- technical specifications **95**
- technical support **2**
- Temporal Key Integrity Protocol (TKIP) **29**
- time of day, troubleshooting **92**
- time to live, advertisement **80**
- time zone, setting **42**
- time-out
  - port triggering **51**
- time-stamping **43**
- TKIP (Temporal Key Integrity Protocol) encryption **34**
- trademarks **2**
- traffic metering **79**
- traffic, prioritizing **74**
- troubleshooting **85**
- trusted host **40**
- Trusted IP Address field **40**
- turn off wireless connectivity **28**

## **U**

- Universal Plug and Play (UPnP) **80**
- upgrading firmware **54**

## **V**

- viewing
  - advanced wireless settings **70**
  - logs **45**
- Virtual Channel Identifier (VCI) **16**
- Virtual Path Identifier (VPI) **16**

## **W**

- WAN **64**
  - advanced setup **64**
  - ping response **64**
  - settings **64**
- WAN port
  - scanning **64**
- WAN setup **64**
- WDS **81, 82**
- WEP encryption **35**
- Wi-Fi Protected Setup (WPS) **30, 31, 88**
  - adding devices **30**
- wildcards, DNS and **66**
- Wired Equivalent Privacy (WEP) encryption
  - when to use **29**
- Wireless Card Access List **71, 72**
- wireless connections **10**
- wireless connectivity **28**
- Wireless Distribution System (WDS) **81**
- wireless isolation **33**
- wireless network name **33**
- wireless port settings **59**
- wireless radio **70**
- wireless repeating **81, 82**
  - base station **82**
  - repeater unit **83**
- wireless repeating function **81, 82**
- wireless security options **29**
- wireless settings
  - advanced **70**
- Wireless Settings screen **31**
- wireless settings, SSID broadcast **33**
- WMM (Wi-Fi Multimedia) **75**
- WPA encryption **29**
- WPA2 encryption **29**
- WPA2-PSK encryption **29**
- WPA-PSK encryption **29**
- WPA-PSK/WPA2-PSK mixed mode **29**
- WPS button **30**
- WPS-PSK encryption **29**
- WPS-PSK+ WPA2-PSK encryption **29**

## **Federal Communication Commission Interference Statement**

This equipment has been tested and found to comply with the limits for a Class B digital device, pursuant to Part 15 of the FCC Rules. These limits are designed to provide reasonable protection against harmful interference in a residential installation. This equipment generates, uses and can radiate radio frequency energy and, if not installed and used in accordance with the instructions, may cause harmful interference to radio communications. However, there is no guarantee that interference will not occur in a particular installation. If this equipment does cause harmful interference to radio or television reception, which can be determined by turning the equipment off and on, the user is encouraged to try to correct the interference by one of the following measures:

- Reorient or relocate the receiving antenna.
- Increase the separation between the equipment and receiver.
- Connect the equipment into an outlet on a circuit different from that to which the receiver is connected.
- Consult the dealer or an experienced radio/TV technician for help.

FCC Caution: Any changes or modifications not expressly approved by the party responsible for compliance could void the user's authority to operate this equipment.

This device complies with Part 15 of the FCC Rules. Operation is subject to the following two conditions: (1) This device may not cause harmful interference, and (2) this device must accept any interference received, including interference that may cause undesired operation.

### **IMPORTANT NOTE:**

#### **Radiation Exposure Statement:**

This equipment complies with FCC radiation exposure limits set forth for an uncontrolled environment. This equipment should be installed and operated with minimum distance 20cm between the radiator & your body.

This transmitter must not be co-located or operating in conjunction with any other antenna or transmitter.

Note: The country code selection is for non-US model only and is not available to all US model. Per FCC regulation, all WiFi product marketed in US must fixed to US operation channels only.