

# NETGEAR®

---

## CENTRIA WNDR4700/WNDR4720 User Manual



350 East Plumeria Drive  
San Jose, CA 95134  
USA

December 2012  
202-11016-02  
v1.0

## Support

Thank you for choosing NETGEAR.

After installing your device, locate the serial number on the label of your product and use it to register your product at <https://my.netgear.com>. You must register your product before you can use NETGEAR telephone support. NETGEAR recommends registering your product through the NETGEAR web site. For product updates and web support, visit <http://support.netgear.com>.

Phone (US & Canada only): 1-888-NETGEAR.

Phone (Other Countries): Check the list of phone numbers at <http://support.netgear.com/general/contact/default.aspx>.

NETGEAR recommends that you use only the official NETGEAR support resources.

## Trademarks

NETGEAR, the NETGEAR logo, and Connect with Innovation are trademarks and/or registered trademarks of NETGEAR, Inc. and/or its subsidiaries in the United States and/or other countries. Information is subject to change without notice. © All rights reserved.

# Contents

## Chapter 1 Hardware Setup

Unpack CENTRIA . . . . .	8
Position CENTRIA . . . . .	8
Hardware Features . . . . .	9
Front and Side Panel . . . . .	9
Back Panel . . . . .	11
Label . . . . .	11
Install CENTRIA . . . . .	12
Install an Optional Internal Hard Disk Drive (HDD) . . . . .	15
HDD Format . . . . .	17
Remove a Hard Disk Drive . . . . .	17
Requirements for Optional USB Devices . . . . .	19

## Chapter 2 Getting Started with NETGEAR genie

Router Setup Preparation . . . . .	21
Use Standard TCP/IP Properties for DHCP . . . . .	21
Gather ISP Information . . . . .	21
Wireless Devices and Security Settings . . . . .	21
Types of Logins and Access . . . . .	21
Use NETGEAR genie after Installation . . . . .	22
Upgrade the Firmware . . . . .	22
Dashboard (Basic Home Screen) . . . . .	23
Join Your Wireless Network . . . . .	24
Manual Method . . . . .	24
Wi-Fi Protected Setup (WPS) Method . . . . .	24
NETGEAR genie App and Mobile genie App . . . . .	25

## Chapter 3 NETGEAR genie Basic Settings

Basic Home Screen . . . . .	27
Internet Setup . . . . .	27
Internet Setup Screen Fields . . . . .	28
Attached Devices . . . . .	29
Parental Controls . . . . .	30
ReadySHARE Storage . . . . .	32
Basic Wireless Settings . . . . .	33
Wireless Settings Screen Fields . . . . .	34
Change WPA Security Option and Password . . . . .	35
Guest Networks . . . . .	36
Guest Network Wireless Security Options . . . . .	37

**Chapter 4 NETGEAR genie Advanced Home**

NETGEAR genie Advanced Home Screen .....	39
Setup Wizard .....	39
WPS Wizard .....	40
Setup Menu .....	41
WAN Setup .....	42
Default DMZ Server .....	43
Change the MTU Size .....	44
LAN Setup .....	45
LAN Setup Screen Settings .....	46
Use the Router as a DHCP Server .....	47
Address Reservation .....	48
Quality of Service (QoS) Setup .....	48

**Chapter 5 Storage**

ReadySHARE Access .....	53
User Setup .....	53
File-Sharing Scenarios .....	54
Storage Basic Settings .....	56
Add or Edit a Network Folder .....	57
Storage Advanced Settings .....	58
Safely Remove a USB or Internal Hard Drive .....	59
Media Server .....	60
Specify Approved USB Devices .....	60
Connect to the USB Drive from a Remote Computer .....	61
Access the Router's USB Drive Remotely Using FTP .....	61
ReadySHARE Cloud .....	62
Back Up Your Computers .....	63
ReadySHARE Vault Windows Backup .....	63
Time Machine HDD Backup .....	65
Time Machine USB Drive Backup .....	66
Back Up an SD Card onto the Internal HDD .....	70
Replace the Internal Hard Disk Drive .....	71
Format the HDD .....	73

**Chapter 6 ReadySHARE Printer**

ReadySHARE Printer .....	76
USB Control Center Utility .....	80
Control Center Configuration .....	81
USB Printer .....	81
Scan with a Multifunction Printer .....	82

**Chapter 7 Security**

Keyword Blocking of HTTP Traffic .....	84
Block Services (Port Filtering) .....	85

Schedule Blocking .....	87
Security Event Email Notifications .....	88

## Chapter 8 Administration

Upgrade the Firmware .....	90
View Router Status .....	91
Router Information .....	91
Internet Port (WAN) Setup .....	92
Wireless Settings (2.4 GHz and 5 GHz) .....	94
View Logs of Web Access or Attempted Web Access .....	95
Manage the Configuration File .....	96
Back Up Settings .....	96
Restore Configuration Settings .....	96
Erase .....	97
Set Password .....	97
Password Recovery .....	97

## Chapter 9 Advanced Settings

Advanced Wireless Settings .....	100
Restrict Wireless Access by MAC Address .....	101
Wireless AP .....	102
Wireless Repeating Function (WDS) .....	103
Set Up the Base Station .....	105
Set Up a Repeater Unit .....	106
Port Forwarding and Triggering .....	107
Remote Computer Access Basics .....	107
Port Triggering to Open Incoming Ports .....	108
Port Forwarding to Permit External Host Communications .....	110
How Port Forwarding Differs from Port Triggering .....	111
Set Up Port Forwarding to Local Servers .....	111
Add a Custom Service .....	112
Edit or Delete a Port Forwarding Entry .....	113
Set Up Port Triggering .....	113
Dynamic DNS .....	115
Static Routes .....	116
Remote Management .....	118
USB Settings .....	119
Universal Plug and Play .....	119
IPv6 .....	120
Auto Detect Fields .....	121
Auto Config .....	122
6to4 Tunnel .....	123
Pass Through .....	123
Fixed .....	124
DHCP .....	125
PPPoE .....	126
Traffic Meter .....	126

**Chapter 10 Troubleshooting**

Quick Tips ..... 129

    Sequence to Restart Your Network ..... 129

    Check Ethernet Cable Connections ..... 129

    Hard Disk Drive (HDD) ..... 129

    Wireless Settings ..... 129

    Network Settings ..... 130

Troubleshooting with the LEDs ..... 130

    Power LED Is Off or Blinking ..... 130

    Power LED Stays Amber ..... 130

    HDD LED Is Red or Red and Green ..... 131

    LEDs Never Turn Off ..... 131

    Internet LED Is Off ..... 131

    Wireless LED Is Off ..... 131

Cannot Log In to CENTRIA ..... 132

Cannot Access the Internet ..... 132

    Troubleshoot PPPoE ..... 134

    Troubleshooting Internet Browsing ..... 134

Changes Not Saved ..... 135

Wireless Connectivity ..... 135

    Wireless Signal Strength ..... 135

Restore the Factory Settings and Password ..... 136

Troubleshoot Your Network Using the Ping Utility ..... 136

    Test the LAN Path to CENTRIA ..... 136

    Test the Path from Your Computer to a Remote Device ..... 137

**Appendix A Supplemental Information**

Factory Settings ..... 139

Technical Specifications ..... 140

**Appendix B Notification of Compliance**

# Hardware Setup

---

# 1

## Getting to know your CENTRIA

NETGEAR CENTRIA is an all-in-one device with three essential functions.

- Back up automatically. All your computers—Windows PCs and Macs—can back up incrementally on the CENTRIA internal hard drive or on an external USB storage drive.
- Share easily. Store your files and media on your CENTRIA and access or stream them from any Internet-enabled device.
- Connect quickly. Enjoy high-performance connectivity throughout your home with your 900 Mbps, dual-band WiFi router.

CENTRIA comes in two models: WNDR4720, which comes with a 2 TB hard drive, and WNDR4700, for which you provide your own hard drive. You can upgrade the hard disk drive at any time. Both models have two SuperSpeed USB 3.0 ports for adding even more storage, should you need it. An SD card reader affords simple, single-click backup of media to the internal hard drive.

This chapter contains the following sections:

- *Unpack CENTRIA*
- *Position CENTRIA*
- *Hardware Features*
- *Install an Optional Internal Hard Disk Drive (HDD)*
- *Remove a Hard Disk Drive*
- *Requirements for Optional USB Devices*

For information about ReadySHARE features in your product, see *Chapter 5, Storage*, and visit [www.netgear.com/readystatechange](http://www.netgear.com/readystatechange).

For more information about the topics covered in this manual, visit the support website at <http://support.netgear.com>.

## Unpack CENTRIA

Open the box and remove the router, cables, and installation guide.

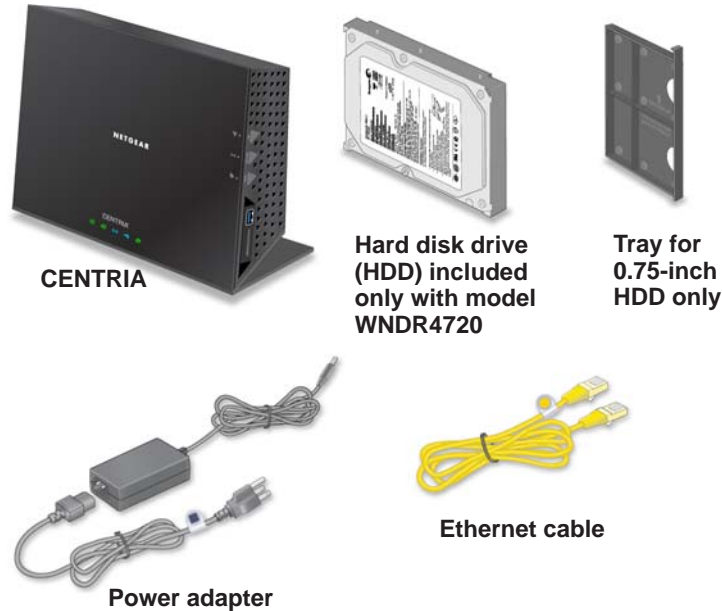

**Note:** If you purchased model WNDR4720, your hard disk drive was shipped external to CENTRIA to protect it from any accidental damage. Always remove the hard drive from the internal slot when shipping CENTRIA.

**Figure 1. Check the package contents**

Your box contains the following items:

- CENTRIA WNDR4700/WNDR4720
- HDD (model WNDR4720 only)
- Tray to allow installation of an optional 0.75-inch HDD
- AC power adapter and power cord (plug varies by region)
- Category 5 (Cat 5) Ethernet cable
- Installation guide with cabling and router setup instructions

If any parts are incorrect, missing, or damaged, contact your NETGEAR dealer. Keep the carton and original packing materials, in case you need to return the product for repair.

## Position CENTRIA

The router lets you access your network from virtually anywhere within the operating range of your wireless network. However, the operating distance or range of your wireless connection can vary significantly depending on the physical placement of your router. For example, the thickness and number of walls the wireless signal passes through can limit the range. For best results, place your router:



- Near the center of the area where your computers and other devices operate and preferably within line of sight to your wireless devices.
- So it is accessible to an AC power outlet and near Ethernet cables for wired computers.
- In an elevated location such as a high shelf, keeping the number of walls and ceilings between the router and your other devices to a minimum.
- Away from electrical devices that are potential sources of interference. Equipment that might cause interference includes ceiling fans, home security systems, microwaves, computers, the base of a cordless phone, or 2.4 GHz cordless phone.
- Away from any large metal surfaces, such as a solid metal door or aluminum studs. Large expanses of other materials such as glass, insulated walls, fish tanks, mirrors, brick, and concrete can also affect your wireless signal.

When there is more than one wireless network in the area and they use the same channel, that can create interference in some instances. If this happens, you can use a different radio frequency channel to reduce interference. The recommended channel spacing is five channels. For example, different networks in the same area could use Channels 1 and 6, or 6 and 11.

## Hardware Features

Before you cable your router, take a moment to become familiar with the front, side, and back panels and the label. Pay particular attention to the LEDs on the front panel.

### Front and Side Panel

The router front panel has status LEDs and icons. Buttons and connectors are on the side.

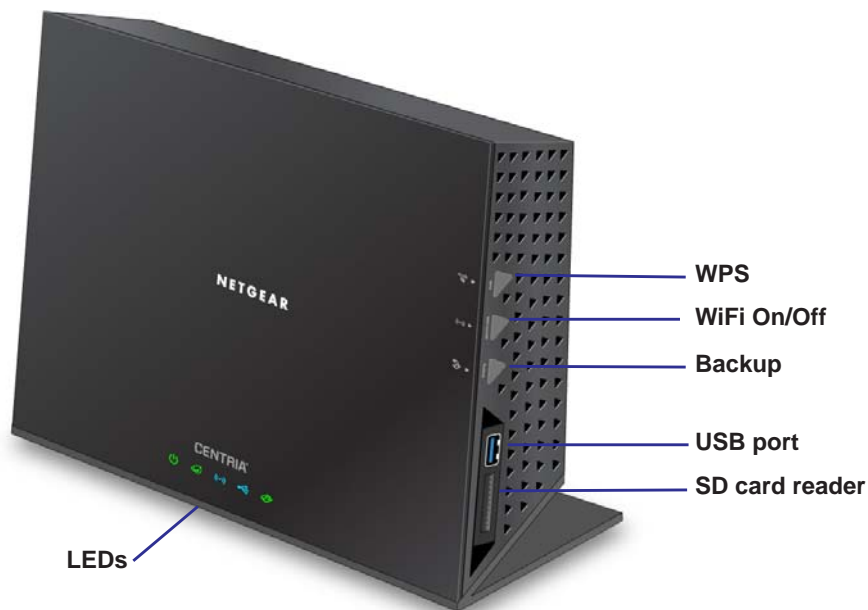







Figure 2. CENTRIA, front and side view

Table 1. LED description

LED	Description
Power 	<ul style="list-style-type: none"> <li>• <b>Solid amber.</b> CENTRIA is starting up.</li> <li>• <b>Blinking amber.</b> The firmware is upgrading, or the Reset button was pressed.</li> <li>• <b>Solid green.</b> CENTRIA is ready.</li> <li>• <b>Blinking green.</b> The firmware is corrupted. Visit <a href="http://www.netgear.com/support">www.netgear.com/support</a>.</li> <li>• <b>Off.</b> Power is not supplied to CENTRIA.</li> </ul>
Internet 	<ul style="list-style-type: none"> <li>• <b>Solid green.</b> The Internet connection is ready.</li> <li>• <b>Solid amber.</b> The Ethernet cable connection to the modem has been detected.</li> <li>• <b>Off.</b> No Ethernet cable is connected to CENTRIA.</li> </ul>
Wireless 	<ul style="list-style-type: none"> <li>• <b>Solid blue.</b> The wireless radio is operating in either 2.4 GHz or 5 GHz mode.</li> <li>• <b>Blinking.</b> The router is in WPS (WiFi protected setup) mode.</li> <li>• <b>Off.</b> The wireless radios are off for both 2.4 GHz and 5 GHz.</li> </ul>
USB 	<ul style="list-style-type: none"> <li>• <b>Solid blue:</b> The router has accepted the USB device. The USB device is ready to be used.</li> <li>• <b>Blinking blue.</b> A USB device is plugged in and is trying to connect.</li> <li>• <b>Off.</b> No USB device is connected; someone clicked the Safely Remove Hardware button, and it is now safe to remove the attached USB device.</li> </ul>
HDD 	<ul style="list-style-type: none"> <li>• <b>Solid green.</b> The internal HDD is working and is not full.</li> <li>• <b>Solid green plus red.</b> The HDD is 85% full.</li> <li>• <b>Blinking green.</b> Someone pressed the Backup button; the SD card data is being copied to the internal HDD.</li> <li>• <b>Blinking green and red.</b> The HDD is 95% full.</li> <li>• <b>Solid red.</b> The HDD is not formatted, the HDD connection is loose, or there is a failure alert.</li> <li>• <b>Off.</b> No internal HDD is connected.</li> </ul>

The following are located on the side.

- **WiFi On/Off button.** Pressing and holding the WiFi On/Off button for 2 seconds turns on or off the 2.4 GHz and 5 GHz wireless radios. If the Wireless LED is lit, then the wireless radio is on. If the LED is off, then the wireless radios are turned off and you cannot connect wirelessly to the router.
- **WPS button.** You can use this button to use WPS to add a wireless device or computer to your wireless network.
- **Backup button.** You can use this button to back up files and folders onto the internal hard disk drive from an SD card attached to the card reader. See [Back Up an SD Card onto the Internal HDD](#) on page 70.
- **USB drive.** You can use this to attach a USB device such as a flash drive. Files and folders on the USB device can be shared.
- **SD card reader.** The SD card reader supports SD, MMC, MS, or MS Pro type cards. You can attach an SD card here, and then use the Backup button to back up files and folders on the SD card onto the internal HDD.

## Back Panel

The back panel has the connections shown in the following figure.

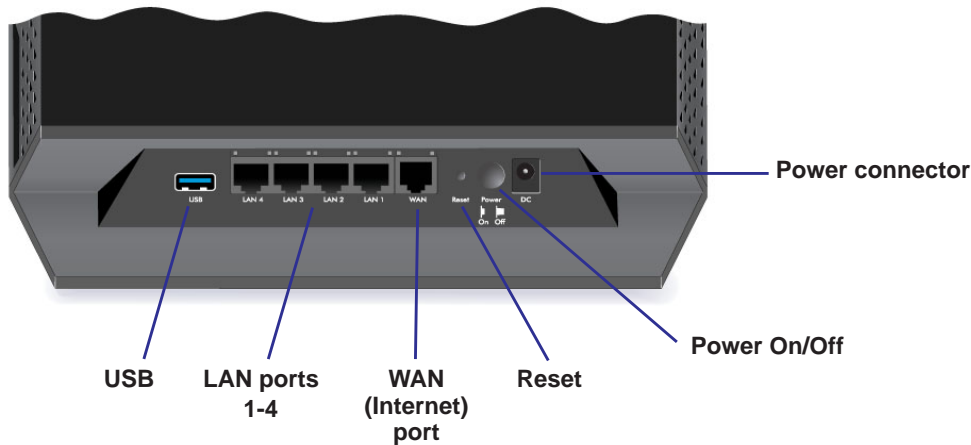

Figure 3. CENTRIA, rear view

See *Factory Settings* on page 139 for information about restoring factory settings.

## Label

The label on the bottom of the router shows the login information, MAC address, and serial number.

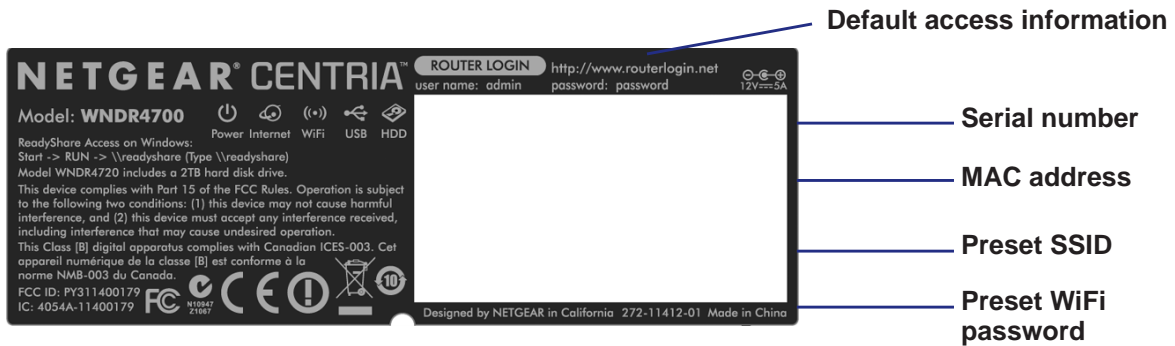

Figure 4. The label shows unique information about CENTRIA

## Install CENTRIA

To view the CENTRIA Installation video, visit [http://kb.netgear.com/app/answers/detail/a\\_id/21753/~/-centria-hard-drive-installation-video](http://kb.netgear.com/app/answers/detail/a_id/21753/~/-centria-hard-drive-installation-video), or use the following QR code.



➤ **To install CENTRIA:**

Make sure that your Internet service is working before you install the router. Follow steps 1 through 5.

**1. Prepare your modem.**

- a. Unplug your modem's power.

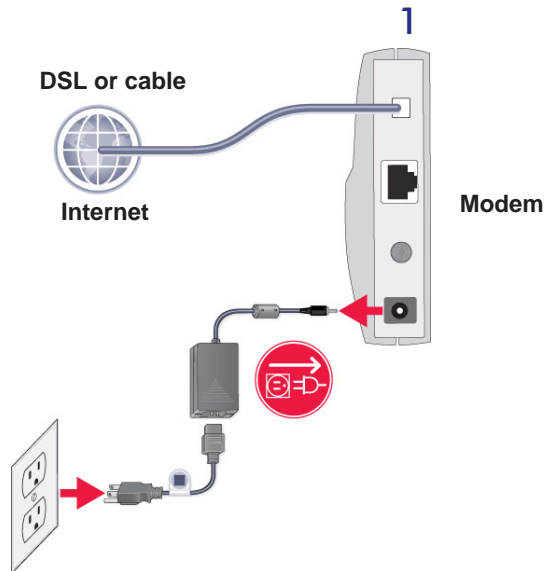

- b. If the modem has a battery backup, remove its batteries.  
c. If your modem was already connected to another router, disconnect the cable between your modem and that router.

Now your modem should be turned off and cabled only to the wall jack for your Internet service.

**2. Connect your modem.**

- a. Plug in and turn on your modem. (Replace the batteries if you removed them previously.)

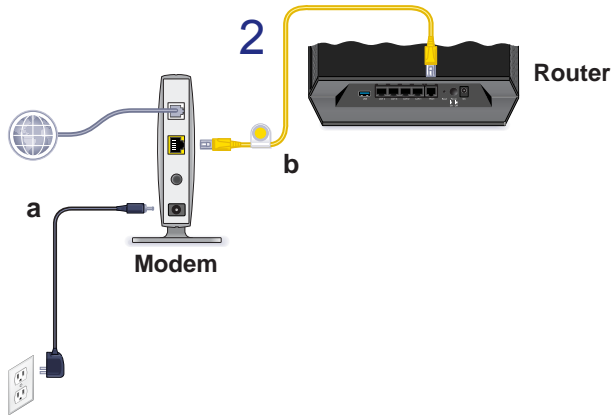

- b. With the yellow Ethernet cable that came with the router, connect your modem to the Internet port of your router.
3. Install a hard disk drive (optional).

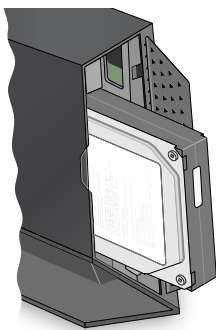

3

For details, see *Install an Optional Internal Hard Disk Drive (HDD)* on page 15.

4. Power on the router.

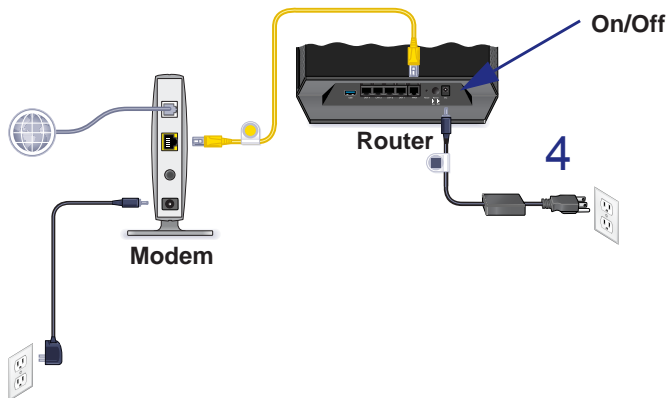

- a. Connect the power adapter to the router and plug the power adapter into an outlet.
- b. Before going to Step 5, wait for the Power LED on the front panel to turn from solid amber to solid green. If none of the LEDs on the front panel are on, press the **Power On/Off** button on the rear panel.

5. Connect a computer.

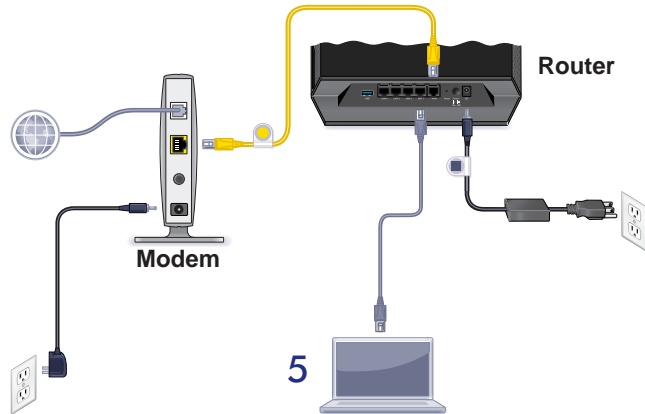

You can use an Ethernet cable (not included) or connect wirelessly.

- Use an Ethernet cable to connect your computer to an Ethernet port on your Router.
- Or, connect wirelessly by using the preset SSID and preset WiFi password on the label on the bottom of the router.

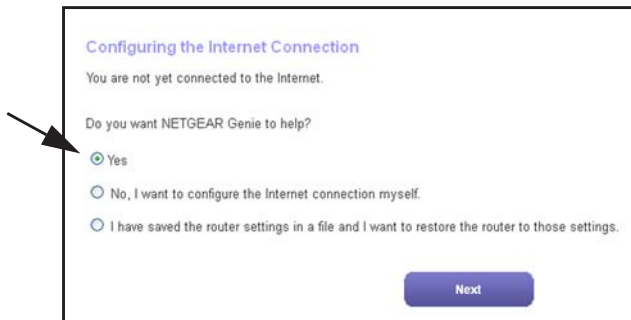

6. Launch a browser, and the genie screen displays.



7. Click **Next**, and follow the onscreen instructions to set up your router.

- If you installed an HDD, you can format it when prompted, or do that later.
- During installation, you can download and install the ReadySHARE Vault app, or do that later. ReadySHARE Vault lets you manage your backups from your computer. See [ReadySHARE Vault Windows Backup](#) on page 63.

**If the browser cannot display the web page:**

- Make sure that the computer is connected to one of the four LAN Ethernet ports or wirelessly to the router.
- Make sure that the router Power LED  is green and that its Wireless LED  is lit.
- Close and reopen the browser to make sure that the browser does not cache the previous page.
- Browse to <http://www.routerlogin.net>.

- If the computer is set to a static or fixed IP address (this is uncommon), change it to obtain an IP address automatically from the router. Consult the documentation that came with your computer or operating system for instructions about how to do this.

**If the router does not connect to the Internet:**

1. Review your settings to be sure that you have selected the correct options and typed everything correctly.
2. Contact your ISP to verify that you have the correct configuration information.
3. Read *Chapter 11, Troubleshooting*. If problems persist, register your NETGEAR product and contact NETGEAR technical support.

## Install an Optional Internal Hard Disk Drive (HDD)

CENTRIA supports an optional HDD. The router supports 3.5-inch SATA HDDs (both 0.75 and 1-inch thickness). Visit [www.netgear.com/CENTRIA\\_HD](http://www.netgear.com/CENTRIA_HD) for list of compatible hard drives.



**CAUTION:**

To protect your equipment, always turn off the router before removing or inserting an HDD.

➤ **To install a hard disk drive:**

1. Make sure the router is powered off.
2. Open the router side door (a) and move the internal latch down (b) as shown (c).

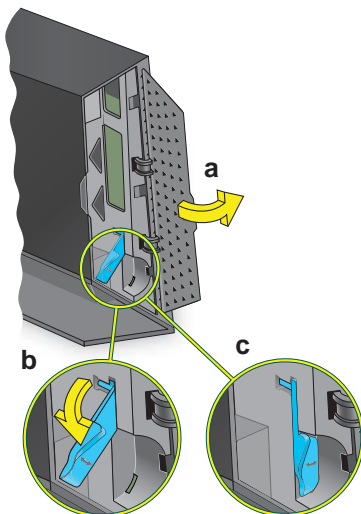

This allows you to insert the HDD.

3. If you are installing a 0.75-inch-thick HDD (this is uncommon), insert the tray into the router.

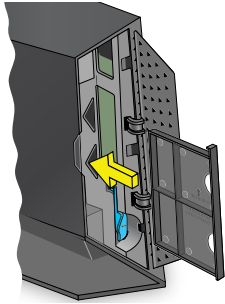

Follow the *THIS SIDE UP* and the *BACK OF PRODUCT* signs on the tray to place it in the correct orientation.

4. Insert the HDD.

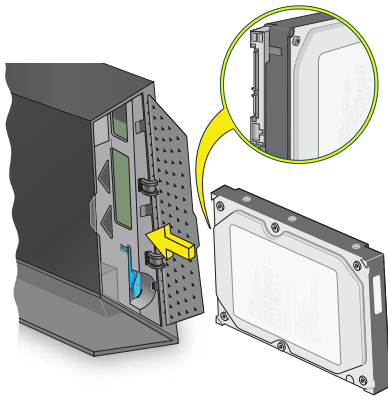

The metal connector on the HDD is up.

5. Close the latch to secure the HDD in place.
6. Close the side door.

---

**Note:** If the latch is not in the correct position or the HDD is inserted in the wrong direction, then the side door to the router cannot be closed.

---

When you turn on the router, the HDD LED shows the status of the HDD.

- **Solid green.** The internal HDD is working and is not full.
- **Solid green plus red.** The HDD is 85% full.
- **Solid red.** The HDD is not formatted, the HDD connection is loose, or there is a failure alert.
- **Off.** No internal HDD is connected.



## HDD Format

If you install an HDD during your initial router setup, the router detects it. A preformatted HDD does not have to be reformatted. If the HDD has not yet been formatted, you are prompted to format the HDD.

**CAUTION:**

Formatting the hard disks erases any data stored on it.

You can follow the prompts to do so, or wait until later and log in to the router to format the HDD from the router menu. See [Format the HDD](#) on page 73.

## Remove a Hard Disk Drive

**CAUTION:**

To protect your equipment, always turn off the router before removing or inserting a hard disk drive (HDD).

➤ **To remove the hard disk drive (HDD):**

1. Power off the router with the Power On/Off button.

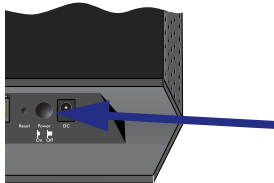

2. Open the router side door and release the internal latch as shown.

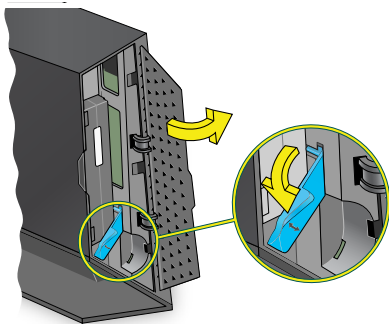

3. Grab the top and bottom of the HDD with your fingers and pull to remove it.

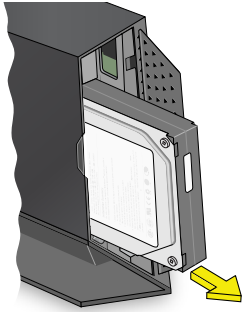

4. If you removed a 0.75-inch HDD, remove the tray from the router.

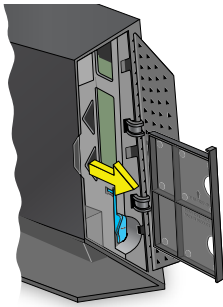

5. Place the latch back to the left (a) so that the router side door can be closed (b).

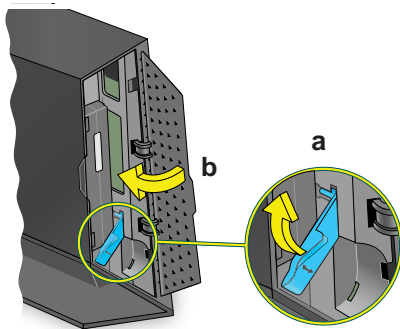

## Requirements for Optional USB Devices

The router works with USB 3.0 (USB Super Speed), 2.0 (USB High Speed), and 1.0 and 1.1 (USB Full Speed) standards. The approximate USB bus speeds are shown in the following table. Actual bus speeds can vary, depending on the CPU speed, memory, speed of the network, and other variables.

**Table 2. USB drive speeds**

Bus	Speed/Sec
USB 3.0	5,000 Mbits
USB 2.0	480 Mbits
USB 1.1	12 Mbits

The router works with most USB-compliant external flash and hard drives. For the most up-to-date list of USB drives that the router supports, go to:

<http://kbserver.netgear.com/readystatechange>

The router supports both read and write for FAT16, FAT32, NTFS, Linux file systems (EXT2, EXT3, EXT4), HFS+ (Hierarchical File System Plus), HFS+ journaled system.

---

**Note:** Some USB external hard drives and flash drives require you to load the drivers onto the computer before the computer can access the USB device. Such USB devices do not work with the router.

---

## 2 Getting Started with NETGEAR genie

---

# 2

### Connecting to CENTRIA

This chapter explains how to use NETGEAR genie to set up your router after you complete cabling as described in the installation guide and in the previous chapter.

This chapter contains the following sections:

- *Router Setup Preparation*
- *Types of Logins and Access*
- *Use NETGEAR genie after Installation*
- *Upgrade the Firmware*
- *Dashboard (Basic Home Screen)*
- *Join Your Wireless Network*
- *NETGEAR genie App and Mobile genie App*

## Router Setup Preparation

You can allow NETGEAR genie to automatically set up your router, or you can use the genie menus and screens to set up your router manually. Before you start the setup process, get your ISP information and make sure the computers and devices in the network have the settings described here.

### Use Standard TCP/IP Properties for DHCP

If you set up your computer to use a static IP address, you need to change the settings so that it uses Dynamic Host Configuration Protocol (DHCP). Consult the documentation that came with your computer or operating system for instructions about how to do this.

### Gather ISP Information

If you have DSL broadband service, you might need the following information to set up your router and to check that your Internet configuration is correct. Your Internet service provider (ISP) should have provided you with all of the information needed to connect to the Internet. If you cannot locate this information, ask your ISP to provide it. When your Internet connection is working, you no longer need to launch the ISP login program on your computer to access the Internet. When you start an Internet application, your router automatically logs you in. Make sure that you have the following information:

- The ISP configuration information for your DSL account
- ISP login name and password
- Fixed or static IP address settings (special deployment by ISP; this is rare)

### Wireless Devices and Security Settings

Make sure that the wireless device or computer that you are using supports WPA or WPA2 wireless security, which is the wireless security supported by the router.

## Types of Logins and Access

Different types of logins have different purposes: It is important that you understand the difference so that you know which login to use when.

- **Router login** logs you in to the router interface from NETGEAR genie. See [Use NETGEAR genie after Installation](#) on page 22 for details about this login.
- **ISP login** logs you in to your Internet service. Your service provider has provided you with this login information, typically in a letter. If you cannot find this login information, contact your service provider.
- **WiFi password.** The preset SSID (WiFi network name) and preset WiFi password for your router are unique. This information is on the label on the bottom of your router.

## Use NETGEAR genie after Installation

When you first set up your router, NETGEAR genie automatically starts when you launch an Internet browser on a computer that is connected to the router. You can use NETGEAR genie again if you want to view or change settings for the router.

1. Launch your browser from a computer or wireless device that is connected to the router.
2. Enter **http://www.routerlogin.net** in the web browser address bar.

A login window displays.



The screenshot shows a login dialog box with a light beige background. It has two input fields: 'User name:' with a dropdown menu showing 'admin' and a blue arrow, and 'Password:' with a masked field of seven asterisks. Below the password field is a checkbox labeled 'Remember my password' which is currently unchecked. At the bottom of the dialog are two buttons: 'OK' and 'Cancel'.

3. Enter **admin** for the router user name and **password** for the router password, both in lowercase letters.

**Note:** The router user name and password are different from the user name and password for logging in to your Internet connection. See [Types of Logins and Access](#) on page 21 for more information.

## Upgrade the Firmware

When you set up your router and are connected to the Internet, the router automatically checks for you to see if newer firmware is available. If it is, a message is displayed on the top of the screen. See [Upgrade the Modem Router Firmware](#) on page 82 for more information about upgrading firmware.

Click the message when it shows up, and click **Yes** to upgrade the router with the latest firmware. After the upgrade, the router restarts automatically.



### CAUTION:

Do not try to go online, turn off the router, shut down the computer, or do anything else to the router until the router finishes restarting and the Power LED has stopped blinking for several seconds.

## Dashboard (Basic Home Screen)

The Basic Home screen has a dashboard that lets you see the status of your Internet connection and network at a glance. You can click any of the six sections of the dashboard to view more detailed information. The left column has the menus, and at the top, there is an Advanced tab that you can use to access more menus and screens.

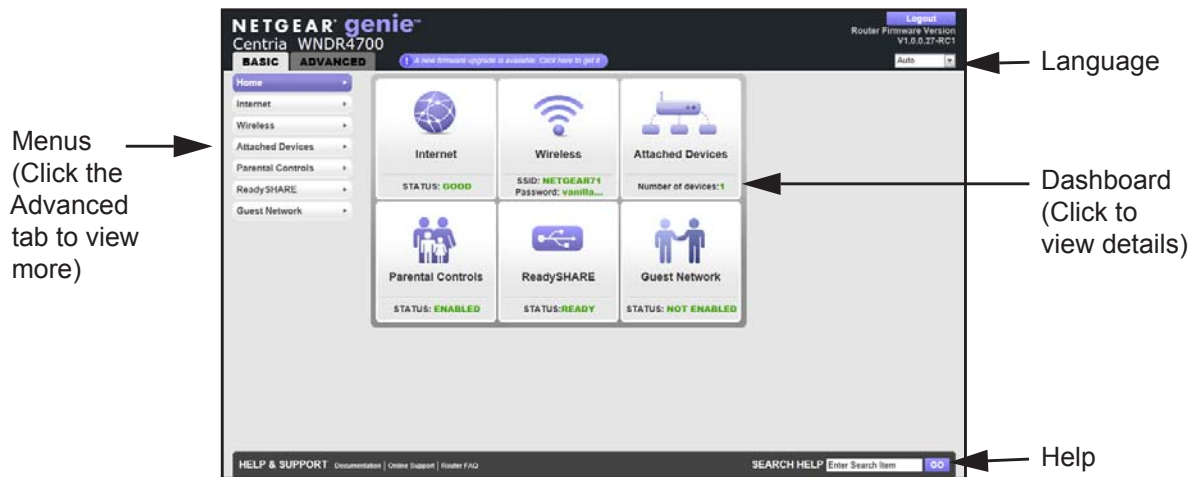

Figure 5. Basic Home screen with dashboard, language, and online help

- **Home.** This dashboard screen displays when you log in to the router.
- **Internet.** Set, update, and check the ISP settings of your router.
- **Wireless.** View or change the wireless settings for your router.
- **Attached Devices.** View the devices connected to your network.
- **Parental Controls.** Download and set up parental controls to prevent objectionable content from reaching your computers.
- **ReadySHARE.** Manage storage on the internal hard disk drive (HDD) and USB devices that you connect to the router USB drive.
- **Guest Network.** Set up a guest network to allow visitors to use your router's Internet connection.
- **Advanced tab.** Set the router up for unique situations such as when remote access by IP or by domain name from the Internet is needed. See [Chapter 9, Advanced Settings](#). You need a solid understanding of networking protocols to use this tab.
- **Help & Support.** Visit the NETGEAR support site to get information, help, and product documentation. These links work once you have an Internet connection.

## Join Your Wireless Network

You can use the manual or the WPS method to join your wireless network. See [Guest Networks](#) on page 36 for instructions about how to set up a guest network.

### Manual Method

With the manual method, you choose the network that you want and enter its password to connect.

➤ **To connect manually:**

1. On your computer or wireless device, open the software that manages your wireless connections. The wireless software scans for all wireless networks in your area.
2. Look for your network and select it.  
The preset SSID (wireless network name) and preset WiFi password are on the router label. If you changed these settings, then look for the network name that you used.
3. Enter the router password and click **Connect**.

### Wi-Fi Protected Setup (WPS) Method

Wi-Fi Protected Setup (WPS) lets you connect to a secure WiFi network without typing its password. Instead, press a button or enter a PIN. NETGEAR calls WPS Push 'N' Connect.

Some older WiFi equipment is not compatible with WPS. WPS works only with WPA2 or WPA wireless security.

➤ **To use WPS to join the wireless network:**

1. Press the **WPS** button on the router side panel.
2. Within 2 minutes, press the **WPS** button on your wireless device, or follow the WPS instructions that came with the device.

The WPS process automatically sets up your wireless computer with the network password and connects you to the wireless network.



## NETGEAR genie App and Mobile genie App

The genie app is the easy dashboard for managing, monitoring, and repairing your home network. See the NETGEAR genie App User Manual for details about the genie apps.



The genie app can help you with the following:

- Automatically repair common wireless network problems.
- Have easy access to router features like Live Parental Controls, guest access, Internet traffic meter, speed test, and more.

The genie mobile app works on your iPhone, iPad, or Android phone:

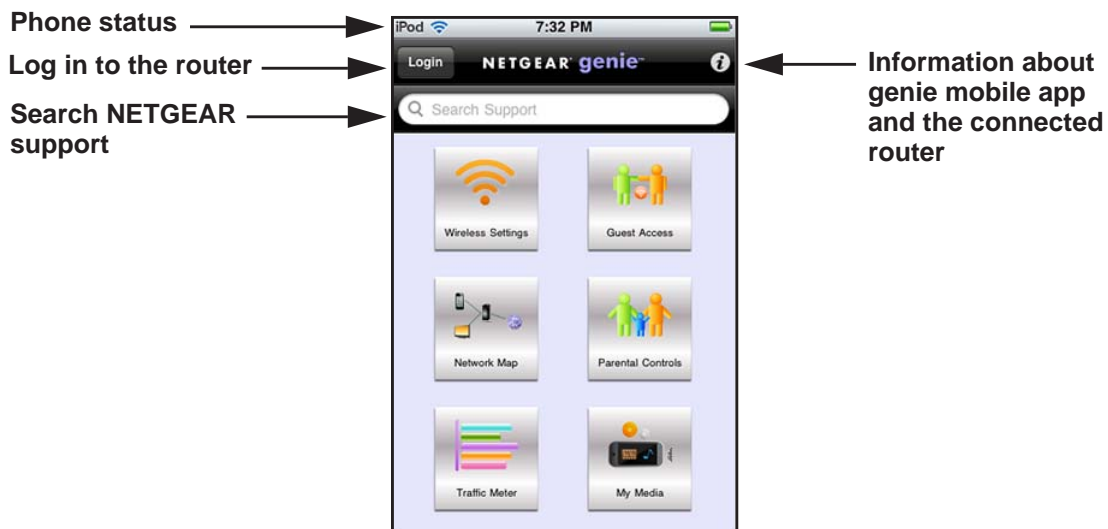

# 3 NETGEAR genie Basic Settings

---

# 3

## Your Internet connection and network

This chapter contains the following sections:

- *Basic Home Screen*
- *Internet Setup*
- *Attached Devices*
- *Parental Controls*
- *ReadySHARE Storage*
- *Basic Wireless Settings*
- *Guest Networks*

## Basic Home Screen

The genie Basic Home screen is shown in the following figure:



## Internet Setup

The Internet Setup screen is where you view or change basic ISP information.

You can use the Setup Wizard to detect the Internet connection and automatically set up the router. See [Setup Wizard](#) on page 39.

➤ **To view or change the basic Internet setup:**

1. From the Home screen, select **Internet**. The following screen displays:

Scroll to view more settings

The fields that display in the Internet Setup screen depend on whether your Internet connection requires a login.

- **Yes.** Select the encapsulation method and enter the login name. If you want to change the login time-out, enter a new value in minutes.
  - **No.** Enter the account and domain names, only if needed.
2. Enter the settings for the IP address and DNS server. The default settings usually work fine. If you have problems with your connection, check to make sure that the settings in this screen match the information from your ISP.
  3. Click **Apply** to save your settings.
  4. Click **Test** to test your Internet connection. If the NETGEAR website does not display within 1 minute, see [Chapter 11, Troubleshooting](#).

## Internet Setup Screen Fields

The following descriptions explain all of the possible fields in the Internet Setup screen. The fields that display in this screen depend on whether an ISP login is required.

**Does Your ISP Require a Login?** Answer either yes or no.

These fields display when no login is required:

- **Account Name (if required)** Enter the account name that your ISP provided. This might also be called the host name.
- **Domain Name (if required)** Enter the domain name that your ISP provided.

These fields display when your ISP requires a login:

- **Internet Service Provider Encapsulation.** ISP types. The choices are PPPoE, PPTP, or L2TP. If you are not sure, check with your ISP.
- **Login.** The login name that your ISP provided. This login name is often an email address.
- **Password.** The password that you use to log in to your ISP.
- **Idle Timeout (In minutes).** If you want to change the login time-out, enter a new value in minutes. This setting determines how long the router keeps the Internet connection active after there is no Internet activity from the LAN. A value of 0 (zero) means never log out.

**Internet IP Address.**

- **Get Dynamically from ISP.** Your ISP uses DHCP to assign your IP address. Your ISP automatically assigns these addresses.
- **Use Static IP Address.** Enter the IP address, IP subnet mask, and the gateway IP address that your ISP assigned. The gateway is the ISP router to which your router will connect.

**Domain Name Server (DNS) Address.** The DNS server is used to look up site addresses based on their names.

- **Get Automatically from ISP.** Your ISP uses DHCP to assign your DNS servers. Your ISP automatically assigns this address.
- **Use These DNS Servers.** If you know that your ISP requires specific servers, select this option. Enter the IP address of your ISP's primary DNS server. If a secondary DNS server address is available, enter it also.

**Router MAC Address.** The Ethernet MAC address that the router uses on the Internet port. Some ISPs register the MAC address of the network interface card in your computer when your account is first opened. They accept traffic only from the MAC address of that computer. This feature allows your router to use your computer's MAC address (this is also called cloning).

- **Use Default Address.** Use the default MAC address.
- **Use Computer MAC Address.** The router captures and uses the MAC address of the computer that you are now using. You have to use the one computer that the ISP allows.
- **Use This MAC Address.** Enter the MAC address that you want to use.

## Attached Devices

Use the Attached Device screen to view all computers or devices that are currently connected to your network.

### ➤ To go to the Attached Devices screen:

From the Basic Home screen, select **Attached Devices** to display the following screen:

Attached Devices			
<b>Wired Devices</b>			
#	IP Address	MAC Address	Device Name
1	192.168.1.2	B8:AC:6F:54:78:66	USABILITY-PC
<b>Wireless Devices (Wireless intruders also show up here)</b>			
#	IP Address	MAC Address	Device Name
<a href="#">Refresh</a>			

Wired devices are connected to the router with Ethernet cables. Wireless devices have joined the wireless network.

- **# (number).** The order in which the device joined the network.
- **IP Address.** The IP address that the router assigned to this device when it joined the network. This number can change if a device is disconnected and rejoins the network.
- **MAC Address.** The unique MAC address for each device does not change. The MAC address is typically shown on the product label.
- **Device Name.** If the device name is known, it is shown here.

You can click **Refresh** to update this screen.

## Parental Controls

The first time you select Parental Controls from the Basic Home screen, your browser goes to the Parental Controls website. You can learn more about Live Parental Controls or download the application.

➤ **To set up Live Parental Controls:**

1. Select **Parental Controls** on the Home (dashboard) screen.

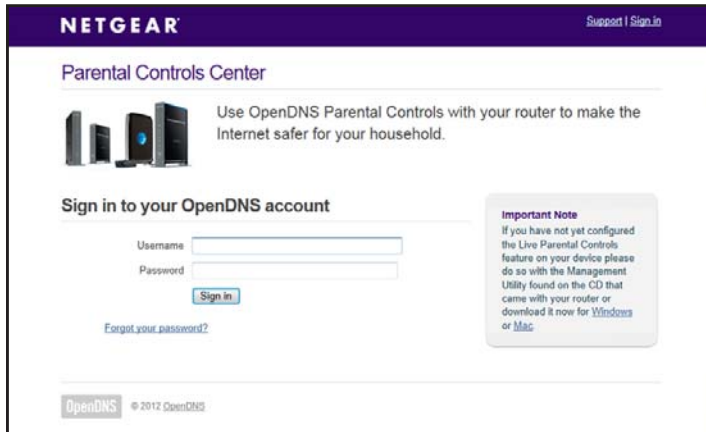

Live Parental Controls uses free OpenDNS accounts. If you do not have one, you can create one now.

2. Log in to manage Parental Control settings.



3. Click either the **Windows Users** or **Mac Users** button.
4. Follow the onscreen instructions to download and install the NETGEAR Live Parental Controls Management Utility.

After installation, Live Parental Controls automatically starts.

**Live Parental Controls**  
Powered by OpenDNS

**NETGEAR** OpenDNS

You're about to setup NETGEAR Live Parental Controls Powered by OpenDNS on your router to filter websites visited on your computers and other networked devices.

Set different filtering rules for each user on your network.  
 Set rules based on the time of day.

Our custom settings let you relax security settings for some users or at some times of the day. [Learn more](#)

**Next**

5. Click **Next**, read the note, and click **Next** again to proceed.

You are prompted to log in or create a free account.

**Setting up Live Parental Controls**

Welcome, this setup wizard will quickly configure NETGEAR Live Parental Controls Powered by OpenDNS on your NETGEAR router.

In order to use Live Parental Controls, you need a free OpenDNS account. Do you already have one?

Yes, use my existing OpenDNS account.  
 No, I need to create a free OpenDNS account.

6. Select the radio button that applies to you and click **Next**.
- If you already have an OpenDNS account, leave the **Yes** radio button selected.
  - If you do not have an OpenDNS account, select the **No** radio button.

After you log on or create your account, the filtering level screen displays:

**Live Parental Controls: choose a filtering level for your network**

All computers connected to your router will be protected from the content you select below. You can customize your Live Parental Controls later on our website.

**High**  
 Protects against all adult-related sites, illegal activity, social networking sites, video sharing sites, phishing attacks and general time-wasters.

**Moderate**  
 Protects against all adult-related sites, illegal activity and phishing attacks.

**Low**  
 Protects against pornography and phishing attacks.

**Minimal**  
 Protects only against phishing attacks.

**None**  
 Nothing blocked.

7. Select the radio button for the filtering level that you want and click **Next**.

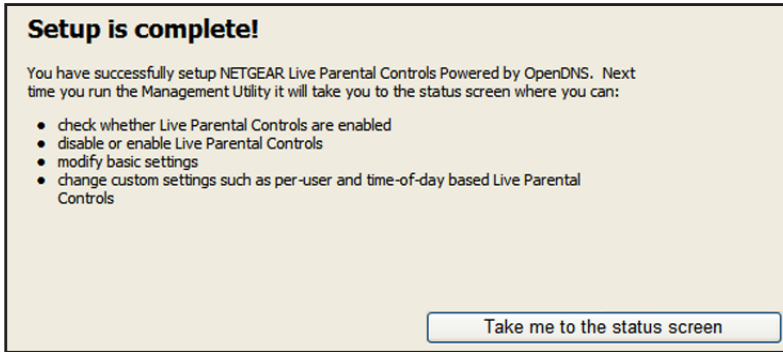

8. Click the **Take me to the status screen** button.

Parental controls are now set up for the router. The dashboard shows Parental Controls as enabled.

## ReadySHARE Storage

You can view information about an internal hard disk drive (HDD) or a USB storage device that is connected to the router's USB port here. From the Basic Home screen, select **ReadySHARE** to display the USB Storage (Basic Settings) screen:

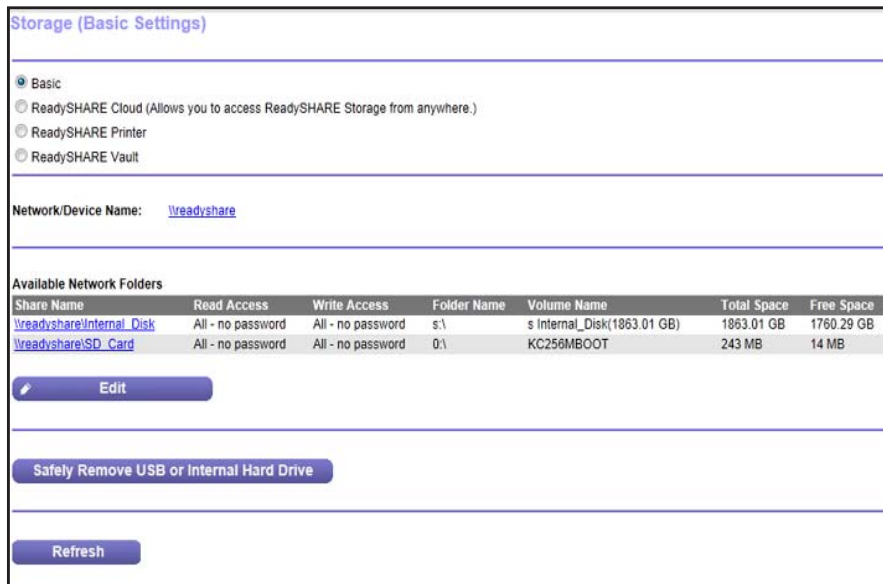

To work with storage, leave the Basic radio button selected. This screen displays the following:

- **Network/Device Name.** The default is \\readyshare.
- **Available Network Folders.** The folders on the HDD or USB device.



**Share Name.** You can click the name shown, or you can type it in the address field of your web browser. If Not Shared is shown, the default share has been deleted and no other share for the root folder exists. Click the link to change this setting.

**Read Access and Write Access.** Shows the permissions and access controls on the network folder: All – no password (the default) allows all users to access the network folder. The user name (account name) for All – no password is guest. The password for admin is the same one that you use to log in to the router. By default, it is **password**.

**Folder Name.** Full path of the network folder.

**Volume Name.** Volume name from the storage device (either USB drive or HDD).

**Total Space and Free Space.** Shows the current utilization of the storage device.

- **Edit.** Click the **Edit** button to edit the Available Network Folders settings.
- **Safely Remove USB or Internal Hard Disk Drive.** Safely remove the USB device attached to your router.

You can click **Refresh** to update this screen. For more information about USB storage, see [Chapter 5, Storage](#).

## Basic Wireless Settings

The Wireless Settings screen lets you view or configure the wireless network setup.

The CENTRIA comes with preset security. This means that the Wi-Fi network name (SSID), network key (password), and security option (encryption protocol) are preset in the factory. You can find the preset SSID and password on the bottom of the unit.

---

**Note:** The preset SSID and password are uniquely generated for every device to protect and maximize your wireless security.

---

### ➤ To view or change basic wireless settings:

*NETGEAR recommends that you do not change your preset security settings.* If you change your preset security settings, make a note of the new settings and store it in a safe place where you can easily find it.

If you use a wireless computer to change the wireless network name (SSID) or other wireless security settings, you are disconnected when you click Apply. To avoid this problem, use a computer with a wired connection to access the router.

1. Select **Basic > Wireless** to display the Wireless Settings screen.

The screen sections, settings, and procedures are explained in the following sections.

2. Make any changes that are needed and click **Apply** to save your settings.
3. Set up and test your wireless devices and computers to make sure that they can connect wirelessly. If they do not, check the following:
  - Is your wireless device or computer connected to your network or another wireless network in your area? Some wireless devices automatically connect to the first open network (without wireless security) that they discover.
  - Does your wireless device or computer show up on the Attached Devices screen? If it does, then it is connected to the network.
  - If you are not sure what the network name (SSID) or password is, look on the label on the bottom of your router.

## Wireless Settings Screen Fields

### *Region Selection*

The location where the router is used. Select from the countries in the list. In the United States, the region is fixed to United States and is not changeable.

### *Wireless Network (2.4 GHz b/g/n and 5 GHz)*

The b/g/n notation references the 802.11 standards of conformance for the 2.4 GHz radio frequency.

**Enable Wireless Isolation.** If this check box is selected, wireless computers or devices that join the network can use the Internet but cannot access each other or access Ethernet devices on the network.

**Enable SSID Broadcast.** This setting allows the router to broadcast its SSID so wireless stations can see this wireless name (SSID) in their scanned network lists. This check box is selected by default. To turn off the SSID broadcast, clear the **Enable SSID Broadcast** check box and click **Apply**.

**Name (SSID).** The SSID is also known as the wireless network name. Enter a 32-character (maximum) name in this field. This field is case-sensitive. The default SSID is randomly generated, and *NETGEAR strongly recommends that you do not change this setting.*

**Channel.** This setting is the wireless channel the gateway uses. Enter a value from 1 through 13. For products in the North America market, only channels 1 through 11 can be operated. Do not change the channel unless you experience interference (shown by lost connections or slow data transfers). If this happens, experiment with different channels to see which is the best.

**Mode.** Up to 150 Mbps is the default and allows 802.11n and 802.11g wireless devices to join the network. g & b supports up to 54 Mbps. Up to 65 Mbps supports up to 65 Mbps.

### Security Options Settings

The Security Options section of the Wireless Settings screen lets you change the security option and passphrase. *NETGEAR recommends that you do not change the security option or passphrase, but if you want to change these settings, this section explains how. Do not disable security.*

## Change WPA Security Option and Password

You can change the security settings for your router. If you do so, then write down the new settings and store them in a secure place for future reference.

#### ➤ To change the WPA settings:

1. On the Wireless Settings screen, under Security Options, select the WPA option you want.

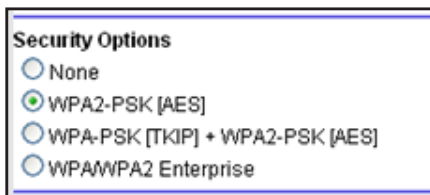

2. In the Passphrase field that displays when you select a WPA security option, enter the network passphrase (password) that you want to use. It is a text string from 8 to 63 characters.

## Guest Networks

Adding a guest network allows visitors at your home to use the Internet without having your wireless security key. You can add a guest network to each wireless network: 2.4 GHz b/g/n and 5.0 GHz a/n

➤ **To set up a guest network:**

1. Select **Basic > Guest Network** to display the following screen:

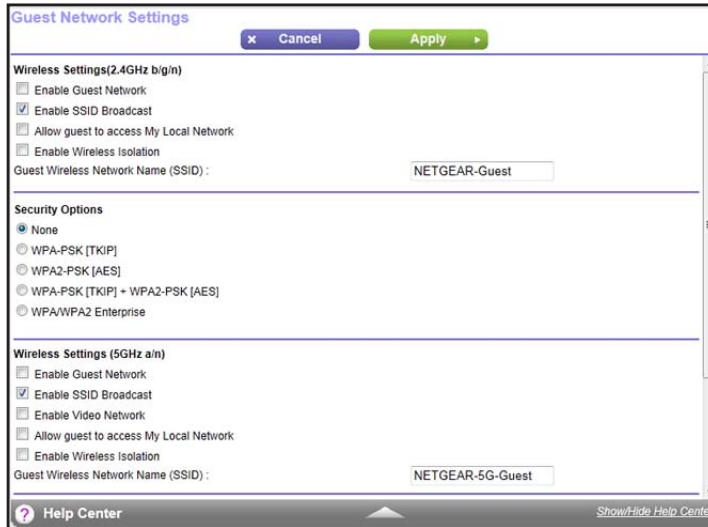

2. Select any of the following wireless settings:

**Enable this wireless network.** When this check box is selected, the guest network is enabled, and guests can connect to your network using the SSID of this profile.

**Enable SSID Broadcast.** If this check box is selected, the wireless access point broadcasts its name (SSID) to all wireless stations. Stations with no SSID can adopt the correct SSID for connections to this access point.

**Allow guest to access My Local Network.** If this check box is selected, anyone who connects to this SSID has access to your local network, not just Internet access.

**Enable Wireless Isolation.** If this check box is selected, wireless computers or devices that join the network can use the Internet but cannot access each other or access Ethernet devices on the network.

3. Give the guest network a name.

The guest network name is case-sensitive and can be up to 32 characters. You then manually configure the wireless devices in your network to use the guest network name in addition to the main SSID.

4. Select a security option from the list. The security options are described in [Guest Network Wireless Security Options](#) on page 37.
5. Click **Apply** to save your selections.

## Guest Network Wireless Security Options

A security option is the type of security protocol applied to your wireless network. The security protocol in force encrypts data transmissions and ensures that only trusted devices receive authorization to connect to your network. Wi-Fi Protected Access (WPA) has several options including pre-shared key (PSK) encryption.

This section presents an overview of the security options and provides guidance on when to use which option. It is also possible to set up a guest network without wireless security. NETGEAR does *not* recommend this.

### *WPA Encryption*

WPA encryption is built into all hardware that has the Wi-Fi-certified seal. This seal means that the product is authorized by the Wi-Fi Alliance (<http://www.wi-fi.org/>) because it complies with the worldwide single standard for high-speed wireless local area networking.

WPA uses a password for authentication and to generate the initial data encryption keys. Then it dynamically varies the encryption key. WPA-PSK uses Temporal Key Integrity Protocol (TKIP) data encryption, implements most of the IEEE 802.11i standard, and works with all wireless network interface cards, but not all wireless access points.

WPA2-PSK is stronger than WPA-PSK. It is advertised to be theoretically indecipherable due to the greater degree of randomness in encryption keys that it generates. WPA2-PSK gets higher speed because it is usually implemented through hardware, while WPA-PSK is usually implemented through software. WPA2-PSK uses a password to authenticate and generate the initial data encryption keys. Then it dynamically varies the encryption key.

WPS-PSK + WPA2-PSK Mixed Mode can provide broader support for all wireless clients. WPA2-PSK clients get higher speed and security, and WPA-PSK clients get decent speed and security. For help with WPA settings on your wireless computer or device, see the instructions that came with your product.

# 4 NETGEAR genie Advanced Home

---

# 4

## Specifying custom settings

This chapter contains the following sections:

- *NETGEAR genie Advanced Home Screen*
- *Setup Wizard*
- *WPS Wizard*
- *Setup Menu*
- *WAN Setup*
- *LAN Setup*
- *Quality of Service (QoS) Setup*

Some selections on the Advanced Home screen are described in separate chapters:

- **Storage.** See *Chapter 5, Storage*.
- **Security.** See *Chapter 7, Security*.
- **Administration.** See *Chapter 8, Administration*.
- **Advanced Setup.** See *Chapter 9, Advanced Settings*.

## NETGEAR genie Advanced Home Screen

The genie Advanced Home dashboard presents status information. The content is the same as what is on the Router Status screen available from the Administration menu. The genie Advanced Home screen is shown in the following figure:

The screenshot shows the 'ADVANCED' tab selected in the top navigation bar. The left sidebar contains the following menu items: ADVANCED Home (highlighted), Setup Wizard, WPS Wizard, Setup, USB Storage, Security, Administration, and Advanced Setup. The main content area is divided into four panels:

- Router Information:** Hardware Version R6300, Firmware Version V1.0.0.68\_1.0.16, GUI Language Version V1.0.0.68\_2.1.17.5, LAN Port (MAC: 4C:60:DE:FF:03:92, IP: 192.168.1.1, DHCP: On), and a Reboot button.
- Internet Port:** MAC Address 4C:60:DE:FF:03:93, IP Address 192.168.0.208, Connection DHCP, IP Subnet Mask 255.255.255.0, and Domain Name Server 192.168.0.1. Includes Show Statistics and Connection Status buttons.
- Wireless Settings (2.4GHz):** Name (SSID) NETGEAR36, Region North America, Channel Auto (1), Mode Up to 217 Mbps, Wireless AP On, Broadcast Name On, Wireless isolation Off, and Wi-Fi Protected Setup Configured.
- Wireless Settings (5GHz):** Name (SSID) NETGEAR36-5G, Region North America, Channel 149 + 153(P) + 157 + 161, Mode Up to 1300 Mbps, Wireless AP On, Broadcast Name On, Wireless isolation Off, and Wi-Fi Protected Setup Configured.

An arrow points from the text box on the right to the Internet Port section of the screenshot.

## Setup Wizard

You can use the Setup Wizard to detect your Internet settings and automatically set up your router. The Setup Wizard is not the same as the genie screens that display the first time you connect to your router to set it up.

### ➤ To use the Setup Wizard:

1. Select **Advanced > Setup Wizard** to display the following screen:

The screenshot shows the 'Setup Wizard' screen with the following content:

**Setup Wizard**

The Smart Setup Wizard can detect the type of Internet connection that you have. Do you want the Smart Setup Wizard to try and detect the connection type now?

Yes

No, I want to configure the router myself.

**Next**

2. Select either **Yes** or **No, I want to configure the router myself**. If you select No, you are taken to the Internet Setup screen (see [Internet Setup](#) on page 26).

3. Select **Yes** and click **Next**.

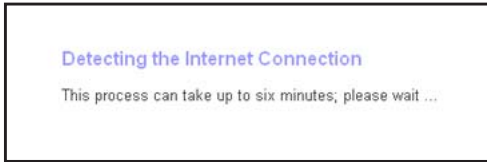

The Setup Wizard searches your Internet connection for servers and protocols to determine your ISP configuration. The following screen displays:

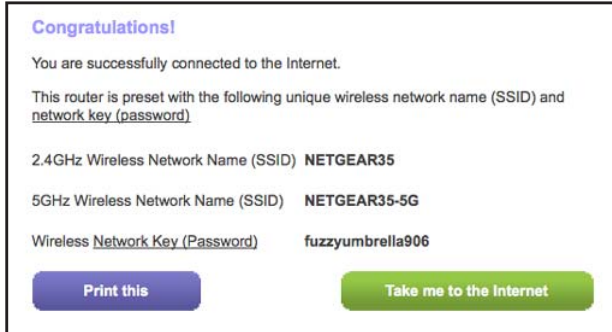

## WPS Wizard

The WPS Wizard helps you add a WPS-capable client device (a wireless device or computer) to your network. On the client device, either press its **WPS** button or locate its WPS PIN.

➤ **To use the WPS Wizard:**

1. Select **Advanced > WPS Wizard**.
2. Click **Next**. The following screen lets you select the method for adding the WPS client (a wireless device or computer).

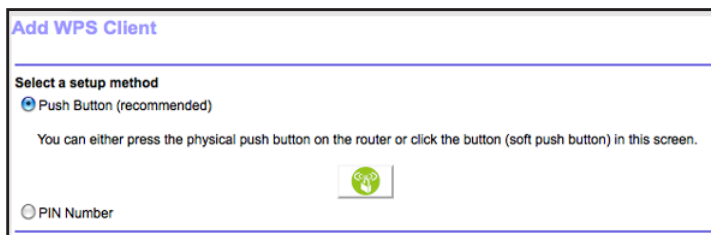

You can use either the push button or PIN method.

3. Select either **Push Button** or **PIN Number**.
  - To use the push button method, either click the **WPS** button on this screen, or press the **WPS** button on the side of the router. Within 2 minutes, go to the wireless client and press its **WPS** button to join the network without entering a password.
  - To use the PIN method, select the **PIN Number** radio button, enter the client security PIN, and click **Next**.



**Add WPS Client**

---

**Select a setup method :**

Push Button (recommended)

PIN Number

This is the security PIN of the WPS client. While connecting, WPS-enabled adapters provide a randomly-generated security PIN.

Enter Client's PIN :

Within 2 minutes, go to the client device and use its WPS software to join the network without entering a password.

The router attempts to add the WPS-capable device. The WPS LED  on the front of the router blinks green. When the router establishes a WPS connection, the LED is solid green, and the router WPS screen displays a confirmation message.

4. Repeat Step 2 and Step 3 to add another WPS client to your network.

## Setup Menu

Select **Advanced > Setup** to display the Setup menu. The following selections are available:

- **Internet Setup.** Go to the same Internet Setup screen that you can access from the dashboard on the Basic Home screen. See [Internet Setup](#) on page 26.
- **Wireless Setup.** Go to the same Wireless Settings screen that you can access from the dashboard on the Basic Home screen. See [Basic Wireless Settings](#) on page 33.
- **Guest Network.** This selection is a shortcut to the same Guest Network screen that you can access from the dashboard on the Basic Home screen. See [Guest Networks](#) on page 36.
- **WAN Setup.** Internet (WAN) setup. See [WAN Setup](#) on page 42.
- **LAN Setup.** Local area network (LAN) setup. See [LAN Setup](#) on page 45.
- **QoS Setup.** Quality of Service (QoS) setup. See [Quality of Service \(QoS\) Setup](#) on page 48.

## WAN Setup

The WAN Setup screen lets you configure a DMZ (demilitarized zone) server, change the maximum transmit unit (MTU) size, and enable the router to respond to a ping on the WAN (Internet) port.

➤ **To view or change the WAN settings:**

Select **Advanced > Setup > WAN Setup**

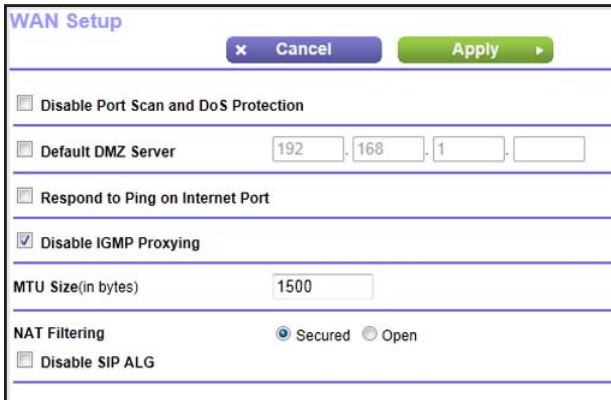

The following settings are available:

- **Disable Port Scan and DoS Protection.** DoS protection protects your LAN against denial of service attacks such as Syn flood, Smurf Attack, Ping of Death, Teardrop Attack, UDP Flood, ARP Attack, Spoofing ICMP, Null Scan, and many others. This should be disabled only in special circumstances.
- **Default DMZ Server.** This feature is sometimes helpful when you are playing online games or videoconferencing. Be careful when using this feature because it makes the firewall security less effective. See the following section, [Default DMZ Server](#), for more details.
- **Respond to Ping on Internet Port.** If you want the router to respond to a ping from the Internet, select this check box. Use this setting only as a diagnostic tool because it allows your router to be discovered. Do not select this check box unless you have a specific reason.
- **Disable IGMP Proxying.** The IGMP Proxying feature lets a LAN computer receive the multicast traffic directed to it from the Internet. Selecting this check box prevents this from occurring.
- **MTU Size (in bytes).** The normal MTU (maximum transmit unit) value for most Ethernet networks is 1500 bytes, or 1492 bytes for PPPoE connections. For some ISPs, you might need to reduce the MTU. This is rarely required. You should change the setting in this field only if you are sure that it is necessary for your ISP connection. See [Change the MTU Size](#) on page 44.
- **NAT Filtering.** Network Address Translation (NAT) determines how the router processes inbound traffic. Secured NAT provides a secured firewall to protect the computers on the

LAN from attacks from the Internet, but might prevent some Internet games, point-to-point applications, or multimedia applications from functioning. Open NAT provides a much less secured firewall, but allows almost all Internet applications to function.

- **Disable SIP ALG.** The Session Initiation Protocol (SIP) Application Level Gateway (ALG) is enabled by default to optimize VoIP phone calls that use the SIP. The Disable SIP ALG check box allows you to disable the SIP ALG. Disabling the SIP ALG might be useful when running certain applications.

## Default DMZ Server

The default DMZ server feature is helpful when you are using some online games and videoconferencing applications that are incompatible with Network Address Translation (NAT). The router recognizes some of these applications and works correctly with them, but there are other applications that might not function well. In some cases, one local computer can run the application correctly if that computer's IP address is entered as the default DMZ server.



### WARNING!

**DMZ servers pose a security risk. A computer designated as the default DMZ server loses much of the protection of the firewall and is exposed to exploits from the Internet. If compromised, the DMZ server computer can be used to attack other computers on your network.**

The router usually detects and discards incoming traffic from the Internet that is not a response to local computers or a service that you set up in the Port Forwarding/Port Triggering screen. Instead of discarding this traffic, you can have the router forward the traffic to one computer on your network. This computer is called the default DMZ server.

#### ➤ To set up a default DMZ server:

1. On the WAN Setup screen, select the **Default DMZ Server** check box.
2. Type the IP address.
3. Click **Apply**.

## Change the MTU Size

The maximum transmission unit (MTU) is the largest data packet a network device transmits. When one network device communicates across the Internet with another, the data packets travel through many devices along the way. If a device in the data path has a lower MTU setting than the other devices, the data packets are split or “fragmented” to accommodate the device with the smallest MTU.

The best MTU setting for NETGEAR equipment is often just the default value. In some situations, changing the value fixes one problem but causes another. Leave the MTU unchanged unless one of these situations occurs:

- You have problems connecting to your ISP or other Internet service, and the technical support of either the ISP or NETGEAR recommends changing the MTU setting. These web-based applications might require an MTU change:
  - A secure website that does not open, or displays only part of a web page
  - Yahoo email
  - MSN portal
  - America Online’s DSL service
- You use VPN and have severe performance problems.
- You used a program to optimize MTU for performance reasons, and now you have connectivity or performance problems.

---

**Note:** An incorrect MTU setting can cause Internet communication problems. For example, you might not be able to access certain websites, frames within websites, secure login pages, or FTP or POP servers.

---

If you suspect an MTU problem, a common solution is to change the MTU to 1400. If you are willing to experiment, you can gradually reduce the MTU from the maximum value of 1500 until the problem goes away. The following table describes common MTU sizes and applications.

**Table 3. Common MTU sizes**

MTU	Application
1500	The largest Ethernet packet size and the default value. This setting is typical for connections that do not use PPPoE or VPN, and is the default value for NETGEAR routers, adapters, and switches.
1492	Used in PPPoE environments.
1472	Maximum size to use for pinging. (Larger packets are fragmented.)
1468	Used in some DHCP environments.

**Table 3. Common MTU sizes (Continued)**

MTU	Application
1460	Usable by AOL if you do not have large email attachments..
1436	Used in PPTP environments or with VPN.
1400	Maximum size for AOL DSL.
576	Typical value to connect to dial-up ISPs.

➤ **To change the MTU size:**

1. Select **Advanced > Setup > WAN Setup**.
2. In the MTU Size field, enter a value from 64 to 1500.
3. Click **Apply** to save the settings.

## LAN Setup

The LAN Setup screen allows configuration of LAN IP services such as Dynamic Host Configuration Protocol (DHCP) and Routing Information Protocol (RIP).

The router is shipped preconfigured to use private IP addresses on the LAN side and to act as a DHCP server. The router's default LAN IP configuration is:

- LAN IP address. **192.168.1.1**
- Subnet mask. **255.255.255.0**

These addresses are part of the designated private address range for use in private networks and are suitable for most applications. If your network requires a different IP addressing scheme, you can change these settings in the LAN Setup screen.

➤ **To change the LAN settings:**

---

**Note:** If you change the LAN IP address of the router, you are disconnected. To use the router menus, you must use a browser to connect to the new IP address and log in again.

---

1. Select **Advanced > Setup > LAN Setup** to display the following screen:

**LAN Setup**

Cancel Apply

Device Name WNDR4700

**LAN TCP/IP Setup**

IP Address 192 . 168 . 1 . 1

IP Subnet Mask 255 . 255 . 255 . 0

RIP Direction Both

RIP Version Disabled

Use Router as DHCP Server

Starting IP Address 192 . 168 . 1 . 2

Ending IP Address 192 . 168 . 1 . 254

**Address Reservation**

#	IP Address	Device Name	MAC Address

+ Add Edit Delete

2. Enter the settings that you want to customize. These settings are described in the following section, *LAN Setup Screen Settings*.
3. Click **Apply** to save your changes.

## LAN Setup Screen Settings

### LAN TCP/IP Setup

- **IP Address.** The LAN IP address of the router.
- **IP Subnet Mask.** The LAN subnet mask of the router. Combined with the IP address, the IP subnet mask allows a device to know which other addresses are local to it, and which addresses have to be reached through a gateway or router.
- **RIP Direction.** Router Information Protocol (RIP) allows a router to exchange routing information with other routers. This setting controls how the router sends and receives RIP packets. Both is the default setting. With the Both or Out Only setting, the router broadcasts its routing table periodically. With the Both or In Only setting, the router incorporates the RIP information that it receives.
- **RIP Version.** This setting controls the format and the broadcasting method of the RIP packets that the router sends. It recognizes both formats when receiving. By default, the RIP function is disabled.

**RIP-1** is universally supported. It is adequate for most networks, unless you have an unusual network setup.

**RIP-2** carries more information. Both RIP-2B and RIP-2M send the routing data in RIP-2 format. RIP-2B uses subnet broadcasting. RIP-2M uses multicasting.

## Use Router as a DHCP Server

Usually, this check box is selected so that the router functions as a Dynamic Host Configuration Protocol (DHCP) server.

- **Starting IP Address.** Specify the start of the range for the pool of IP addresses in the same subnet as the router.
- **Ending IP Address.** Specify the end of the range for the pool of IP addresses in the same subnet as the router.

## Address Reservation

When you specify a reserved IP address for a computer on the LAN, that computer receives the same IP address each time it accesses the router's DHCP server. Assign reserved IP addresses to servers that require permanent IP settings. See [Address Reservation](#) on page 48.

## Use the Router as a DHCP Server

By default, the router acts as a DHCP server. The router assigns IP, DNS server, and default gateway addresses to all computers connected to the LAN. The assigned default gateway address is the LAN address of the router. The router assigns IP addresses to the attached computers from a pool of addresses specified in this screen. Each pool address is tested before it is assigned to avoid duplicate addresses on the LAN. For most applications, the default DHCP and TCP/IP settings of the router are satisfactory.

You can specify the pool of IP addresses that can be assigned by setting the starting IP address and ending IP address. These addresses should be part of the same IP address subnet as the router's LAN IP address. Using the default addressing scheme, define a range between 192.168.1.2 and 192.168.1.254, although you might want to save part of the range for devices with fixed addresses.

The router delivers the following parameters to any LAN device that requests DHCP:

- An IP address from the range you have defined
- Subnet mask
- Gateway IP address (the router's LAN IP address)
- Primary DNS server (if you entered a primary DNS address in the Internet Setup screen; otherwise, the router's LAN IP address)
- Secondary DNS server (if you entered a secondary DNS address in the Internet Setup screen)

To use another device on your network as the DHCP server, or to specify the network settings of all of your computers, clear the **Use Router as DHCP Server** check box and click **Apply**. Otherwise, leave this check box selected. If this service is not enabled and no other DHCP server is available on your network, set your computers' IP addresses manually so that they can access the router.

## Address Reservation

When you specify a reserved IP address for a computer on the LAN, that computer always receives the same IP address each time it accesses the router's DHCP server. Reserved IP addresses should be assigned to computers or servers that require permanent IP settings.

➤ **To reserve an IP address:**

1. In the Address Reservation section of the screen, click the **Add** button.
2. In the IP Address field, type the IP address to assign to the computer or server. (Choose an IP address from the router's LAN subnet, such as 192.168.1.x.)
3. Type the MAC address of the computer or server.

**Tip:** If the computer is already on your network, you can copy its MAC address from the Attached Devices screen and paste it here.

4. Click **Apply** to enter the reserved address into the table.

The reserved address is not assigned until the next time the computer contacts the router's DHCP server. Reboot the computer, or access its IP configuration and force a DHCP release and renew.

To edit or delete a reserved address entry, select the radio button next to the reserved address you want to edit or delete. Then click **Edit** or **Delete**.

## Quality of Service (QoS) Setup

QoS is an advanced feature that can be used to prioritize some types of traffic ahead of others. The CENTRIA can provide QoS prioritization over the wireless link and on the Internet connection.

➤ **To configure QoS:**

Select **Advanced > Setup > QoS Setup** to display the following screen:



## Enable WMM QoS for Wireless Multimedia Applications

The CENTRIA supports Wi-Fi Multimedia Quality of Service (WMM QoS) to prioritize wireless voice and video traffic over the wireless link. WMM QoS provides prioritization of wireless data packets from different applications based on four access categories: voice, video, best effort, and background. For an application to receive the benefits of WMM QoS, both it and the client running that application have to have WMM enabled. Legacy applications that do not support WMM and applications that do not require QoS, are assigned to the best effort category, which receives a lower priority than voice and video.

WMM QoS is enabled by default. You can disable it in the QoS Setup screen by clearing the **Enable WMM** check box and clicking **Apply**.

## Set Up QoS for Internet Access

You can give prioritized Internet access to the following types of traffic:

- Specific applications
- Specific online games
- Individual Ethernet LAN ports of the router
- A specific device by MAC address

To specify prioritization of traffic, create a policy for the type of traffic and add the policy to the QoS Policy table in the QoS Setup screen. For convenience, the QoS Policy table lists many common applications and online games that can benefit from QoS handling.

## QoS for Applications and Online Gaming

### ➤ To create a QoS policy for applications and online games:

1. In the QoS Setup screen, select the **Turn Internet Access QoS On** check box.
2. Click the **Setup QoS Rule** button to see the QoS Priority Rule list.

#	QoS Policy	Priority	Description
1	MSN Messenger	High	MSN Messenger application
2	Yahoo Messenger	High	Yahoo Messenger application
3	IP Phone	Highest	IP Phone application
4	Vonage IP Phone	Highest	Vonage IP Phone application
5	NetMeeting	High	NetMeeting application
6	AIM	High	AIM application
7	Google Talk	Highest	Google Talk application
8	Netgear EVA	Highest	Netgear EVA application
9	Counter Strike	High	On-line gaming Counter Strike
10	Age of Empires	High	On-line gaming Age of Empires
11	Everquest	High	On-line gaming Everquest
12	Quake 2	High	On-line gaming Quake 2
13	Quake 3	High	On-line gaming Quake 3
14	Unreal Tournament	High	On-line gaming Unreal Tournament
15	Warcraft	High	On-line gaming Warcraft

You can edit or delete a rule by selecting its radio button and clicking either the **Edit** or **Delete** button. You can also delete all the rules by clicking the **Delete All** button.

- To add a priority rule, scroll down to the bottom of the QoS Setup screen and click **Add Priority Rule** to display the following screen:

The screenshot shows the 'QoS - Priority Rules' configuration window. At the top, there are 'Cancel' and 'Apply' buttons. Below, the 'Priority' section contains the following fields:

- QoS Policy for:** IP Phone
- Priority Category:** Applications
- Applications:** IP Phone
- Priority:** Normal

- In the QoS Policy for field, type the name of the application or game.
- In the Priority Category list, select either **Applications** or **Online Gaming**. A list of applications or games displays.
- You can select an existing item from the list, or you can scroll and select **Add a New Application** or **Add a New Game**, as applicable.
- If prompted, in the Connection Type list, select either **TCP**, **UDP**, or both (**TCP/UDP**). Specify the port number or range of port numbers that the application or game uses.
- From the Priority list, select the priority for Internet access for this traffic relative to other applications and traffic. The options are Low, Normal, High, and Highest.
- Click **Apply** to save this rule to the QoS Policy list and return to the QoS Setup screen.

### QoS for a Router LAN Port

- To create a QoS policy for a device connected to one of the router's LAN ports:
  - Select **Advanced > Setup > QoS Setup** to display the QoS Setup screen.
  - Select the **Turn Internet Access QoS On** check box.
  - Click the **Setup QoS Rule** button.
  - Click the **Add Priority Rule** button.
  - From the Priority Category list, select **Ethernet LAN Port**, as shown in the following figure:

The screenshot shows the 'QoS - Priority Rules' configuration window for a LAN port. At the top, there are 'Cancel' and 'Apply' buttons. Below, the 'Priority' section contains the following fields:

- QoS Policy for:** LAN Port 1
- Priority Category:** Ethernet LAN Port
- LAN Port:** 1
- Priority:** Normal

- From the LAN port list, select the LAN port.
- From the Priority list, select the priority for Internet access for this port's traffic relative to other applications. The options are Low, Normal, High, and Highest.
- Click **Apply** to save this rule to the QoS Policy list and return to the QoS Setup screen.
- In the QoS Setup screen, click **Apply**.

## QoS for a MAC Address

### ➤ To create a QoS policy for traffic from a specific MAC address:

1. Select **Advanced > Setup > QoS Setup**, and click the **Setup QoS Rule** button. The QoS Setup screen displays.
2. Click **Add Priority Rule**.
3. From the Priority Category list, select **MAC Address** to display the following screen:

The screenshot shows the 'QoS - Priority Rules' configuration window. At the top, there are 'Cancel' and 'Apply' buttons. The 'Priority' section includes a text field for 'QoS Policy for' and a dropdown menu for 'Priority Category' currently set to 'MAC Address'. Below this is a table titled 'MAC Device List' with columns: 'QoS Policy', 'Priority', 'Device Name', and 'MAC Address'. Underneath the table are input fields for 'MAC Address' (with a dotted separator), 'Device Name', and 'Priority' (set to 'Normal'). At the bottom of the window are four buttons: '+ Add', 'Edit', 'Delete', and 'Refresh'.

4. If the device to be prioritized appears in the MAC Device List, select its radio button. The information from the MAC Device List populates the policy name, MAC Address, and Device Name fields. If the device does not appear in the MAC Device List, click **Refresh**. If it still does not appear, then fill in these fields manually.
5. From the Priority list, select the priority for Internet access for this device's traffic relative to other applications and traffic. The options are Low, Normal, High, and Highest.
6. Click **Apply** to save this rule to the QoS Policy list and return to the QoS Setup screen.
7. In the QoS Setup screen, select the **Turn Internet Access QoS On** check box.
8. Click **Apply**.

## Edit or Delete an Existing QoS Policy

### ➤ To edit or delete a QoS policy:

1. Select **Advanced > QoS Setup** to display the QoS Setup screen.
2. Select the radio button next to the QoS policy that you want to edit or delete, and do one of the following:
  - Click **Delete** to remove the QoS policy.
  - Click **Edit** to edit the QoS policy. Follow the instructions in the preceding sections to change the policy settings.
3. Click **Apply** in the QoS Setup screen to save your changes.

# 5 Storage

---

# 5

## Accessing and configuring an HDD or USB storage drive

This chapter describes how to access and configure a storage drive attached to your router. The USB port on the router can be used to connect only USB storage devices like flash drives or hard drives, or a printer. Do not connect computers, USB modems, CD drives, or DVD drives to the router USB port.

This chapter contains the following sections:

- *ReadySHARE Access*
- *User Setup*
- *File-Sharing Scenarios*
- *Storage Basic Settings*
- *Storage Advanced Settings*
- *Safely Remove a USB or Internal Hard Drive*
- *Media Server*
- *Specify Approved USB Devices*
- *Connect to the USB Drive from a Remote Computer*
- *ReadySHARE Cloud*
- *Back Up Your Computers*
- *Replace the Internal Hard Disk Drive*
- *Format the HDD*

For information about using the ReadySHARE Printer feature, see *Chapter 6, ReadySHARE Printer*.

For more information about ReadySHARE features, see [www.netgear.com/readyshare](http://www.netgear.com/readyshare).

## ReadySHARE Access

ReadySHARE lets you access and share the HDD inside the router or a USB drive connected the router USB port. (If your USB device has special drivers, it is not compatible.) When you connect the USB device, it might take up to 2 minutes before it is ready for sharing.

---

**Note:** If your USB device has a power supply, you must use it when you connect the USB device to the router.

---

➤ **To access the internal HDD or USB device from Windows:**

The readyshareconnect.exe file is available to download here: [www.netgear.com/readystatechange](http://www.netgear.com/readystatechange). You can use any of these methods:

- Select **Start > Run**. Enter **\\readyshare** in the dialog box and click **OK**.
- Open a browser and enter **\\readyshare** in the address bar.
- Open My Network Places and enter **\\readyshare** in the address bar.

➤ **To access the internal HDD or USB device from a Mac:**

1. Select **Go > Connect to Server**.
2. Enter **smb://readyshare** as the server address.
3. Click **Connect**.

## User Setup

The router comes with the admin user name that allows you to log in to the router to view its settings and change them. In the User Setup screen, you can add up to four users in addition to admin. Each user name and password can contain printable ASCII characters (ASCII 0x20 through 0x7E) and can be up to 60 characters in length.

➤ **To add a user:**

1. Select **Advanced > Storage > User Setup**.

The screenshot shows the 'User Setup' configuration page. At the top, there are 'Cancel' and 'Apply' buttons. Below them is a link that says 'click here to change admin password'. The main part of the screen is a table with three columns: '#', 'User Name', and 'Password'. The first row contains the values '1', 'admin', and 'password'. Below the table, there are three buttons: '+ Add', 'Edit', and 'Delete'.

#	User Name	Password
1	admin	password

2. Click **Add**.

3. In the User Name field, type a name.
4. Type the password in the Password field and in the Re-enter Password field to confirm it.
5. Click the **Add** button when finished.

## File-Sharing Scenarios

You can share files on the USB drive for a wide variety of business and recreational purposes. The files can be any computer, Mac, or Linux file type including text files, Word, PowerPoint, Excel, MP3, pictures, and multimedia files. USB drive applications include:

- Sharing multimedia with friends and family such as MP3 files, pictures, and other multimedia with local and remote users.
- Sharing resources on your network. You can store files in a central location so that you do not have to power up a computer to perform local sharing. In addition, you can share files between Macintosh, Linux, and Windows computers by using the USB drive as a go-between across the systems.
- Sharing files such as Word documents, PowerPoint presentations, and text files with remote users.

A few common uses are described in the following sections.

### *Share Photos*

You can create your own central storage location for photos and multimedia. This method eliminates the need to log in to (and pay for) an external photo-sharing site.

#### ➤ **To share files with your friends and family:**

1. Insert your USB drive into the USB port on the router either directly or with a USB cable.  
Computers on your local area network (LAN) can automatically access this USB drive using a web browser or Microsoft Networking.
2. If you want to specify read-only access or to allow access from the Internet, see [Storage Advanced Settings](#) on page 58.

### ***Store Files in a Central Location for Printing***

This scenario is for a family that has one high-quality color printer directly attached to a computer, but not shared on the local area network (LAN). This family does not have a print server.

- One family member has photos on a Macintosh computer that she wants to print.
- The photo-capable color printer is directly attached to a PC, but not shared on the network.
- The Mac and PC are not visible to each other on the network.

#### ➤ **To print photos from a Mac on the printer attached to a PC:**

1. On the Mac, access the USB drive by typing `\\readyshare` in the address field of a web browser. Then copy the photos to the USB drive.
2. On the PC, use a web browser or Microsoft Networking to copy the files from the USB drive to the PC. Then print the files.

### ***Share Large Files over the Internet***

Sending files that are larger than 5 MB can pose a problem for many email systems. The router allows you to share large files such as PowerPoint presentations or .zip files over the Internet. FTP can be used to easily download shared files from the router.

Sharing files with a remote colleague involves the following considerations:

- There are three kinds of accounts: admin, guest, and user accounts. The password for admin is the same one that you use to access the router. By default, it is **password**. The guest user account has no password. You specify the passwords for user accounts in the User Setup screen (*User Setup* on page 53).
- On the FTP site, the person receiving the files uses the guest user account and enters the password. (FTP requires that you type something in the password field.)
- Be sure to select the **FTP (via Internet)** check box in the USB Storage (Advanced Settings) screen. This option supports both downloading and uploading of files.

You can enable the HTTP (via Internet) option on the USB Storage (Advanced Settings) screen to share large files. This option supports downloading files only.

## Storage Basic Settings

You can view or edit basic settings for an internal hard disk drive (HDD) in the router and a USB storage device attached to your router.

➤ **To go to Storage Basic Settings:**

Select **Basic > ReadySHARE**.

Storage (Basic Settings)

Basic  
 ReadySHARE Cloud (Allows you to access ReadySHARE Storage from anywhere.)  
 ReadySHARE Printer  
 ReadySHARE Vault

Network/Device Name: [\\readyshare](#)

Share Name	Read Access	Write Access	Folder Name	Volume Name	Total Space	Free Space
<a href="#">\\readyshare\Internal_Disk</a>	All - no password	All - no password	s:\	s Internal_Disk(1863.01 GB)	1863.01 GB	1760.29 GB
<a href="#">\\readyshare\SD_Card</a>	All - no password	All - no password	0:\	KC256MBOOT	243 MB	14 MB

[Edit](#)

[Safely Remove USB or Internal Hard Drive](#)

[Refresh](#)

By default, the HDD and USB storage device are available to all computers on your local area network (LAN).

The ReadySHARE print feature allows you to share a printer that you connect to the USB port on your router. To use the ReadySHARE print feature on a Windows computer, you need to use the NETGEAR USB Control Center utility. For information about this feature, see [Chapter 6, ReadySHARE Printer](#).

➤ **To access your HDD or USB device:**

1. Click the network device name or the share name in your computer's network folders list.
2. For SMB://readyshare, click **Connect**.

---

**Note:** If you logged in to the router before you connected your USB device, you might not see your USB device in the router screens. If this happens, log out and then log back in.

---



## Add or Edit a Network Folder

1. You can access this feature by selecting **Basic > ReadySHARE**, and clicking **Edit**, or selecting **Advanced > USB Storage > Advanced Settings**.

**Storage (Advanced Settings)**

Refresh Apply

Network/Device Name:

Workgroup:

Enable	Access Method	Link	Port
<input checked="" type="checkbox"/>	Network Neighborhood/MacShare	<a href="#">\readysare</a>	-
<input checked="" type="checkbox"/>	HTTP	<a href="http://readysare.routerlogin.net/shares">http://readysare.routerlogin.net/shares</a>	80
<input type="checkbox"/>	HTTP(via internet)	<a href="https://10.1.15.151/shares">https://10.1.15.151/shares</a>	443
<input type="checkbox"/>	FTP	<a href="ftp://readysare.routerlogin.net/shares">ftp://readysare.routerlogin.net/shares</a>	21
<input type="checkbox"/>	FTP(via internet)	<a href="ftp://10.1.15.151/shares">ftp://10.1.15.151/shares</a>	21

**Available Network Folders**

Share Name	Read Access	Write Access	Folder Name	Total Space	Free Space	S.M.A.R.T st
<input checked="" type="radio"/> \readysare\Internal_Disk	All - no password	All - no password	s:\	1863.01 GB	1757.86 GB	<a href="#">click here</a>

+ Create Network Folder Edit Delete

Safely Remove USB or Internal Hard Drive

Format Internal Disk

2. Specify the changes that you want to make:
  - To add a folder, click **Create Network Folder**.

**Create Network Folder**

USB Device: U:(TESSA)

Folder:

Share Name:

Read Access:  All - no password  admin

Write Access:  All - no password  admin

Apply

Close Window

- To edit a folder, select its radio button and then click **Edit**.
3. You can use this screen to select a folder, change the share name, or change the read access or write access from All – no password to admin.

The user name (account name) for All – no password is guest. The password for admin is the same one that is used to log in to the router. By default, it is password.

4. Click **Apply** for your changes to take effect.

## Storage Advanced Settings

You can set up the device name, workgroups, and network folders for your USB device.

➤ **To go to storage advances settings:**

On the USB Settings screen, click the **Edit** button to display the following screen:

**Storage (Advanced Settings)**

Refresh Apply

Network/Device Name: readyshare

Workgroup: Workgroup

Enable	Access Method	Link	Port
<input checked="" type="checkbox"/>	Network Neighborhood/MacShare	<a href="#">\readyshare</a>	-
<input checked="" type="checkbox"/>	HTTP	<a href="http://readyshare.routerlogin.net/shares">http://readyshare.routerlogin.net/shares</a>	80
<input type="checkbox"/>	HTTP(via internet)	<a href="https://10.1.15.151/shares">https://10.1.15.151/shares</a>	443
<input type="checkbox"/>	FTP	<a href="ftp://readyshare.routerlogin.net/shares">ftp://readyshare.routerlogin.net/shares</a>	21
<input type="checkbox"/>	FTP(via internet)	<a href="ftp://10.1.15.151/shares">ftp://10.1.15.151/shares</a>	21

**Available Network Folders**

Share Name	Read Access	Write Access	Folder Name	Total Space	Free Space	S.M.A.R.T status
<a href="#">\readyshare\Internal_Disk</a>	All - no password	All - no password	s:\	1863.01 GB	1757.86 GB	<a href="#">click here</a>

+ Create Network Folder Edit Delete

Safely Remove USB or Internal Hard Drive

Format Internal Disk

You can use this screen to specify access to the USB storage device.

- **Network Device Name.** The default is readyshare. This is the name used to access the USB device connected to the router.
- **Workgroup.** If you are using a Windows workgroup rather than a domain, the workgroup name is displayed here. The name works only in an operating system that supports NetBIOS, such as Microsoft Windows.
- **Access Method.** The access methods are described here.

**Network Connection.** Enabled by default, this connection allows all users on the LAN to have access to the USB drive.

**HTTP.** Enabled by default. You can type **http://readyshare.routerlogin.net/shares** to access the USB drive.

**HTTP (via Internet).** Disabled by default. If you enable this setting, remote users can type **http://<public IP address/shares>** (for example, **http://1.1.10.102/shares**) or a URL domain name to access the USB drive over the Internet. This setting supports file uploading only.

**FTP.** Disabled by default.

**FTP (via Internet).** Disabled by default. If you enable this setting, remote users can access the USB drive through FTP over the Internet. This setting supports both downloading and uploading of files.

## Available Network Folders

You might need to scroll down to view this section of the screen:

The screenshot shows the 'Storage (Advanced Settings)' page. At the top, there are 'Refresh' and 'Apply' buttons. Below that, there are input fields for 'Network/Device Name' (set to 'readyshare') and 'Workgroup' (set to 'Workgroup'). A table lists various access methods with checkboxes for enabling them. Below the table is the 'Available Network Folders' section, which includes a table with columns for Share Name, Read Access, Write Access, Folder Name, Total Space, Free Space, and S.M.A.R.T. status. At the bottom of the screenshot, there are buttons for 'Create Network Folder', 'Edit', 'Delete', 'Safely Remove USB or Internal Hard Drive', and 'Format Internal Disk'.

Enable	Access Method	Link	Port
<input checked="" type="checkbox"/>	Network Neighborhood/MacShare	<a href="#">\readyshare</a>	-
<input checked="" type="checkbox"/>	HTTP	<a href="http://readyshare.routerlogin.net/shares">http://readyshare.routerlogin.net/shares</a>	80
<input type="checkbox"/>	HTTP(via internet)	<a href="https://10.1.15.151/shares">https://10.1.15.151/shares</a>	443
<input type="checkbox"/>	FTP	<a href="ftp://readyshare.routerlogin.net/shares">ftp://readyshare.routerlogin.net/shares</a>	21
<input type="checkbox"/>	FTP(via internet)	<a href="ftp://10.1.15.151/shares">ftp://10.1.15.151/shares</a>	21

Share Name	Read Access	Write Access	Folder Name	Total Space	Free Space	S.M.A.R.T. sta
<a href="#">\readyshare\Internal Disk</a>	All - no password	All - no password	s:\	1863.01 GB	1757.86 GB	<a href="#">click here</a>

- **Share Name.** If only one device is connected, the default share name is USB\_Storage. You can click the name shown, or you can type it in the address field of your web browser. If Not Shared is shown, the default share has been deleted and no other share for the root folder exists. Click the link to change this setting.
- **Read Access and Write Access.** Shows the permissions and access controls on the network folder: All - no password (the default) allows all users to access the network folder. The password for admin is the same one that you use to log in to the router.
- **Folder Name.** Full path of the network folder.
- **Volume Name.** Volume name from the storage device (either USB drive or HDD).
- **Total Space and Free Space.** Shows the current utilization of the storage device.
- **S.M.A.R.T.** This information is for advanced users. Click the **click here** link to display S.M.A.R.T. information of the internal HDD.
- **Format Internal Disk.** You click this button to format the internal hard disk drive. This erases all data on the drive. When you click Format Internal Disk, you are asked to confirm before any data is erased. For more information about formatting the internal hard disk drive, see [See \*Format the HDD\* on page 73.](#)

## Safely Remove a USB or Internal Hard Drive

To remove a USB device or internal hard disk drive (HDD) safely, select **Storage > Basic Settings**, and click the **Safely Remove USB or Internal Hard Drive** button. This takes the drive offline.

## Media Server

By default, the router is set up to act as a ReadyDLNA media server. This setting lets you view movies and photos on DLNA/UPnP AV-compliant media players, such as Xbox360, Playstation, and NETGEAR's Digital Entertainer Live.

To view these settings, select **Advanced > USB Storage > Media Server** to display the following screen:

By default the Enable Media Server check box and the Automatic (when new files are added) radio button are selected. When these options are selected, the router scans for media files whenever new files are added to the ReadySHARE USB hard drive.

## Specify Approved USB Devices

For more security, you can set up the router to share approved USB devices only. You can access this feature from the Advanced Setup menu on the Advanced tab.

### ➤ To set up approved USB devices:

1. Select **Advanced > Advanced Setup > USB Settings**. The following screen displays.

- Click the **Approved Devices** button. The USB Drive Approved Devices screen displays:

The screenshot shows a web interface titled "USB Drive Approved Devices". At the top, there are two buttons: "Refresh" (blue) and "Apply" (green). Below these is a checkbox labeled "Allow only approved devices". The interface is divided into two main sections. The first section, "Approved USB Devices", contains a table with three columns: "Volume Name", "Device Name", and "Capacity". A blue "Delete" button with a white 'x' icon is positioned to the left of the first row in this table. The second section, "Available USB Devices", also contains a table with the same three columns. A blue "Add" button with a white '+' icon is positioned to the left of the first row in this table.

This screen shows the approved USB devices and the available USB devices. You can remove or add approved USB devices.

- To add an approved USB device, select it from the Available USB Devices list, and then click **Add**.
- Select the **Allow only approved devices** check box.
- Click **Apply** so that your change takes effect.

If you want to work with another USB device, first click the **Safely Remove USB Device** button for the currently connected USB device. Connect the other USB device and repeat this process.

## Connect to the USB Drive from a Remote Computer

To connect to the USB drive from remote computers with a web browser, use the router's Internet port IP address. If you are using Dynamic DNS, you can type the DNS name rather than the IP address. You can view the router's Internet IP address from the dashboard on the Basic Home screen or the Advanced Home screen.

## Access the Router's USB Drive Remotely Using FTP

### ➤ To connect to the router's USB drive using a web browser:

- Connect to the router by typing **ftp://** and the Internet port IP address in the address field of Internet Explorer or Netscape Navigator. For example:

**ftp://10.1.65.4**

If you are using Dynamic DNS, you can type the DNS name rather than the IP address.

- Type the account name and password that has access rights to the USB drive. The user name (account name) for All – no password is **guest**.
- The directories of the USB drive that your account has access to display. For example, you could see: share/partition1/directory1. You can now read and copy files from the USB directory.

## ReadySHARE Cloud

ReadySHARE Cloud gives you remote access over the Internet to a USB storage device that is connected to your router's USB port.

To enable ReadySHARE Cloud, log in to the router and select ReadySHARE. Follow the instructions to register your router with the ReadySHARE Cloud server.

Use this feature to invite friends and family members to access the shared contents on the USB device.

If your friends and family do not have a ReadySHARE Cloud account, they are invited to create one so they can access the shared contents.

Visit <http://readyshare.netgear.com> and create an account to make your files and folders accessible at any time, from anywhere.

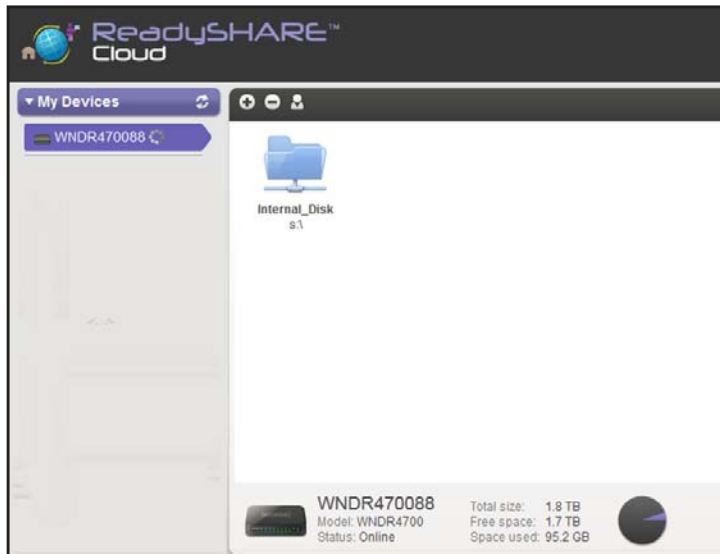

In addition to remotely sharing anything stored on the USB device connected to your router, you can:

- Control friend and family access to each item stored on the USB device.
- Invite new users to access the shared contents.

## Back Up Your Computers

You can back up your computers onto the CENTRIA internal SATA hard disk drive or to a connected external USB storage drive. You can use a formatted HDD or you can format an HDD from the router menu (see *Format the HDD* on page 73).

---

**Note:** For information about backing up the router configuration file, see *Manage the Configuration File* on page 96.

---

The following figure shows an example of the sequence of tasks you could use to back up your computers.

1. Install CENTRIA using a PC, Mac, tablet, or smartphone.

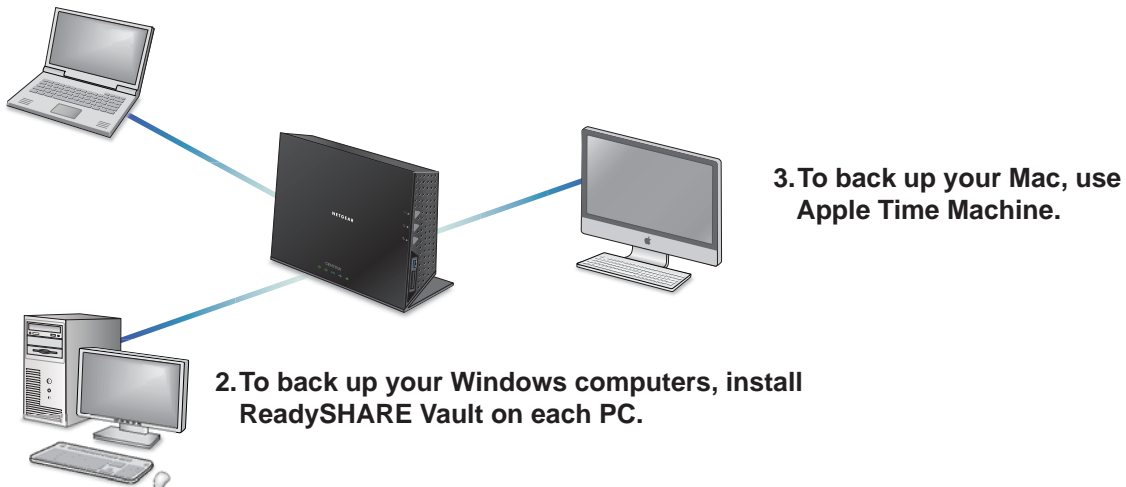

Figure 6. Install CENTRIA, then back up your Windows computers and Macs.



**CAUTION:**

NETGEAR assumes no responsibility for lost data and does not offer data recovery services if a drive fails.

## ReadySHARE Vault Windows Backup

ReadySHARE Vault lets you back up files from your Windows PC onto the internal hard disk in the router or to a USB device attached to the router USB port. ReadySHARE Vault uses incremental backup technology. After the first backup has been completed, ReadySHARE Vault checks to find out which files have changed since the last backup, and then backs up only the changes.

➤ **To back up a Windows PC on to an HDD in the router:**

The first time you back up your PC, the backup could take a while to complete. During the backup you can continue to use your computer.

1. Install the genie app on each PC by downloading the software from [www.netgear.com/genie](http://www.netgear.com/genie).
2. Install ReadySHARE Vault on each PC by downloading the software from [www.netgear.com/readysshare](http://www.netgear.com/readysshare).
3. Launch ReadySHARE Vault. The Dashboard screen displays.

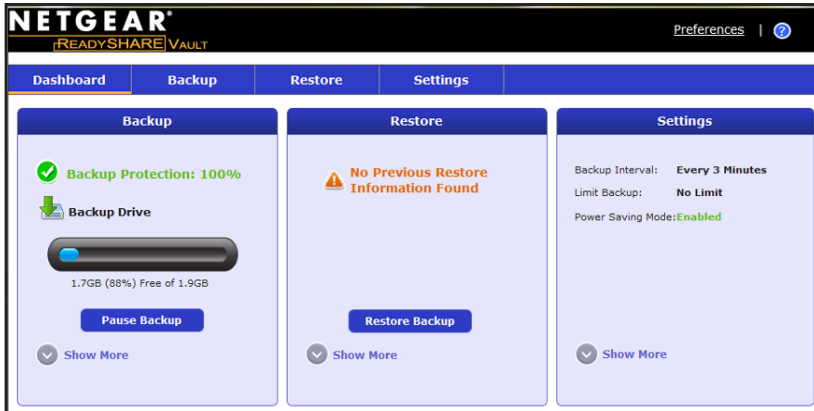

4. Click the **Backup** tab.



5. Follow the steps on this screen to specify the backup drive, which files and folders you want to back up, and whether you want to enable security.
6. Click **Save and Start Backup**.



## Time Machine HDD Backup

Time Machine works on Mac computers only, and automatically backs up your computer.

➤ **To back up a Mac onto an HDD in the router:**

1. From your Mac Desktop, open Macintosh HD or Finder.
2. Select **WNDR4700** from the SHARED list in the left menu.
3. Click the **Connect As** button.
4. In the pop-up window, select **Registered User**, and enter **admin** as the user name and **password** as the password.



5. Click **Connect**.

After connecting, you can list connected devices. One extra device, called admin, displays whenever you log in as admin.

6. From the Apple menu, select **System Preferences**, and then open Time Machine.
7. Click **Select Disk** and select the backup disk.
8. Click the **Use for Backup** button to complete your selection.

If you do not see the HDD, use Mac Finder to locate it. Then select it in Time Machine.

9. Enter the password (**password**), and the backup begins.

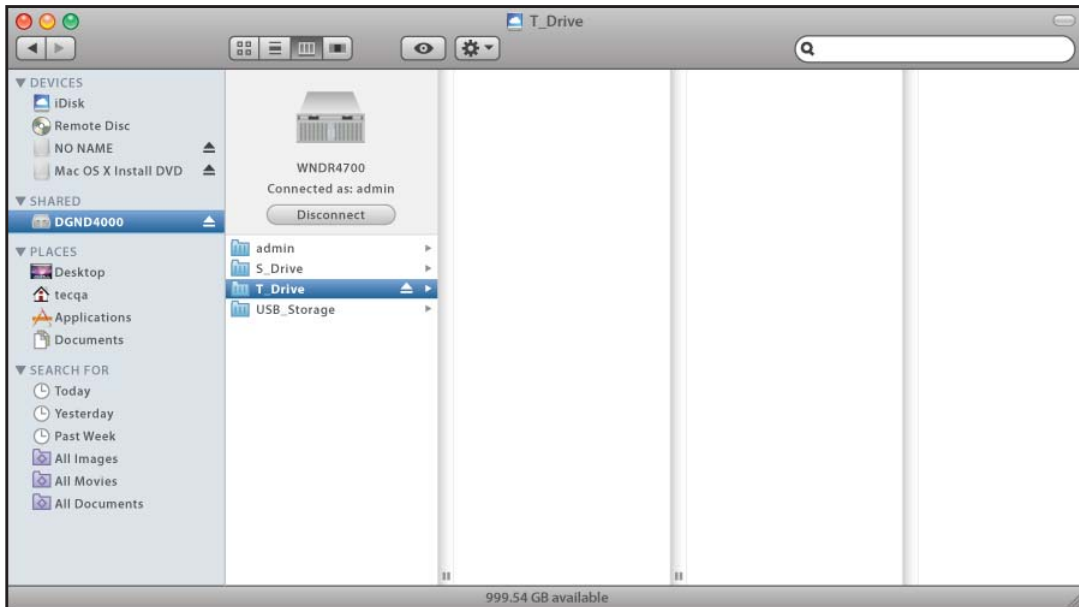

## Time Machine USB Drive Backup

If you are already using Time Machine software with your USB hard drive, you can skip this section.

- **To set up a USB drive for Time Machine:**
  1. Physically connect the USB hard drive to your Mac.
  2. On your Mac, go to the magnifying glass at the top right of the desktop, and search for **disk utility**.

- Open the Disk Utility and format your drive, as shown here.

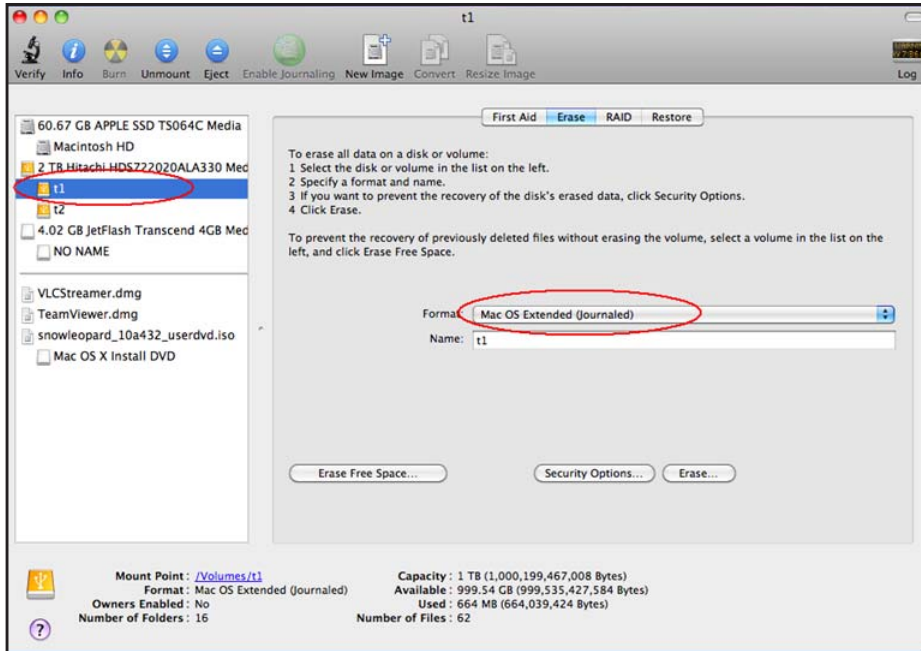

The router supports GUID and MBR partitions only. To see how to change the partition scheme, see [Change the Partition Scheme](#) on page 70.

You can now use Time Machine wirelessly by connecting the USB hard drive to your router.

- **To back up a Mac onto a USB drive attached to the router USB port:**
  - From your Mac Desktop, open Macintosh HD or Finder.
  - Click the **Connect As** button.
  - In the pop-up window, select **Registered User**, and enter **admin** as the user name and **password** as the password.



4. Click **Connect**.

After connecting, you can list connected devices. One extra device, called admin, displays whenever you log in as admin.

5. From the Apple menu, select **System Preferences**, and then open Time Machine.

6. Click **Select Disk** and select the backup disk.

7. Click the **Use for Backup** button to complete your selection.

If you do not see the HDD, use Mac Finder to locate it. Then select it in Time Machine.

8. Enter the password (**password**), and the backup begins.

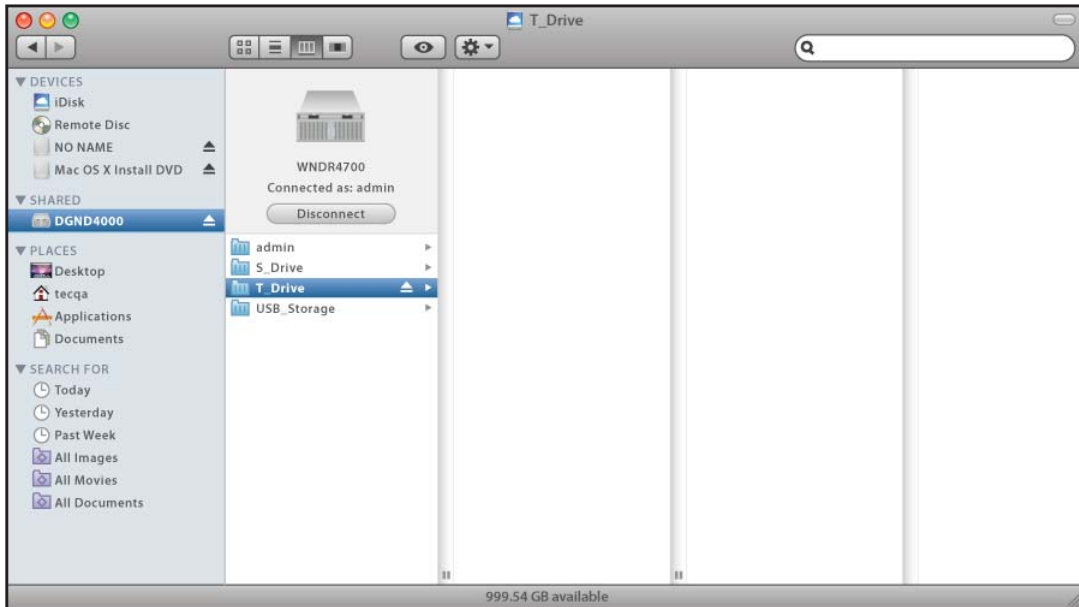

### *Before You Back up a Large Amount of Data*

Before you back up a large amount of data with Time Machine, NETGEAR recommends that you do the following to ensure a successful operation:

1. Upgrade the operating system of the Mac machine.
2. Verify and repair the backup disk and the local disk.
3. Verify and repair the permissions on the local disk.
4. Set Energy Saver.
  - a. From the Apple menu, select **System Preferences**.
  - b. From the View menu, select **Energy Saver**.

- c. On the Energy Saver screen, select **Wake for Ethernet network access**.

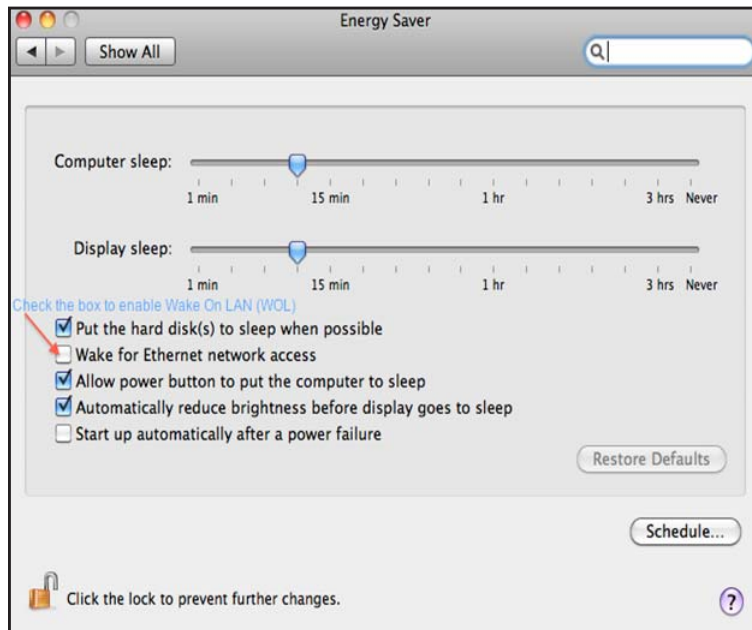

- d. Click the Back arrow to exit this screen. Your changes are saved.
5. Modify your Security settings.
- From the Apple menu, select **System Preferences**.
  - From the View menu, select **Security**.
  - On the Security screen, leave the **Log out after minutes of inactivity** check box **cleared** (not selected).

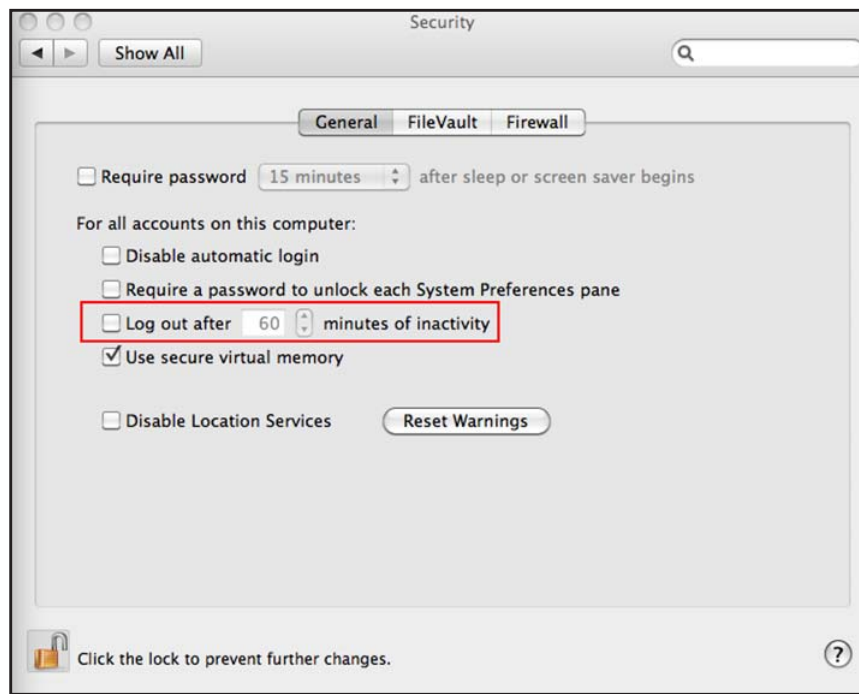

## Change the Partition Scheme

To run with the router, the partition scheme on your Mac has to be set to either GUID or MBR.

➤ **To make sure the partition scheme is set to one of these supported schemes:**

1. Open the Disk Utility and select your USB drive.
2. Select the **Partition** tab.
3. Select **Volume Scheme** and set the number of partitions you would like to use.

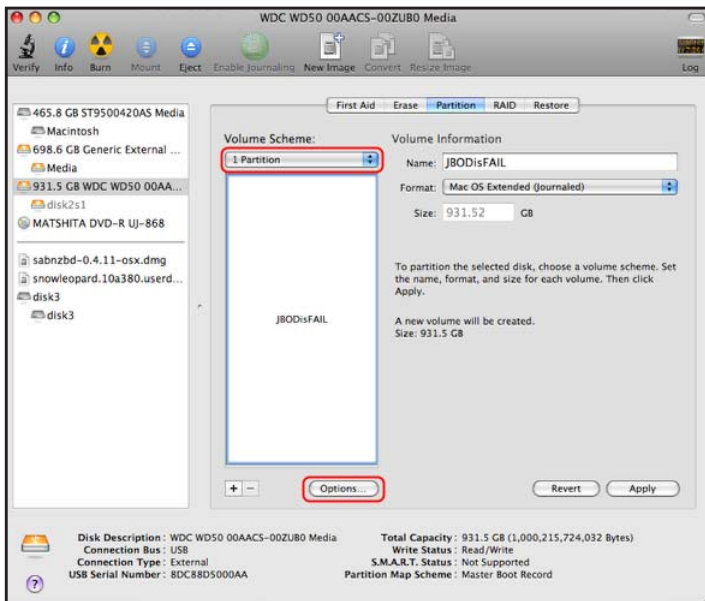

4. Click **Options**, and the Partition options appear.
5. Select **GUID Partition Table** or **Master Boot Record (MBR)**.
6. Click **OK**.

## Back Up an SD Card onto the Internal HDD

The SD card reader supports SD, MMC, MS, or MS Pro type cards. You can use the Backup button on the side of the router to backup files and folders on an SD card onto the internal HDD. This is a convenient way to back up files such as pictures from a digital camera.

➤ **To back up all files and folders on an SD card:**

An internal HDD must be installed inside the router.

1. Plug the SD card into the SD card reader on the side of the router.
2. Press the **Backup** button on the side of the router for 2 seconds.

The HDD LED starts blinking green.

All the data on SD card is backed up in a folder on the internal HDD root directory. The folder name is Card\_1\_Backup\_<time stamp>, where time stamp is the time of the backup.

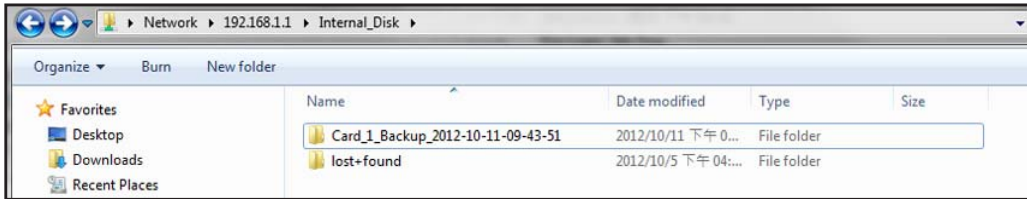

When the backup is done, the HDD LED stops blinking. You can go to the root directory of the internal HDD to check the data.

## Replace the Internal Hard Disk Drive

You can install a hard disk drive (HDD) inside the router and back up files from your computers onto the HDD. For instructions about how to install an HDD, see the installation guide that came in the package with your product.

When your HDD is 95% full, the HDD LED  blinks red and green.

### ➤ To replace an HDD:

1. Obtain a compatible HDD. It can be preformatted or unformatted.

For a list of HDDs that are compatible with the router, visit [www.netgear.com/CENTRIA\\_HD](http://www.netgear.com/CENTRIA_HD).

2. Select **Advanced > USB Storage > Advanced Settings**.

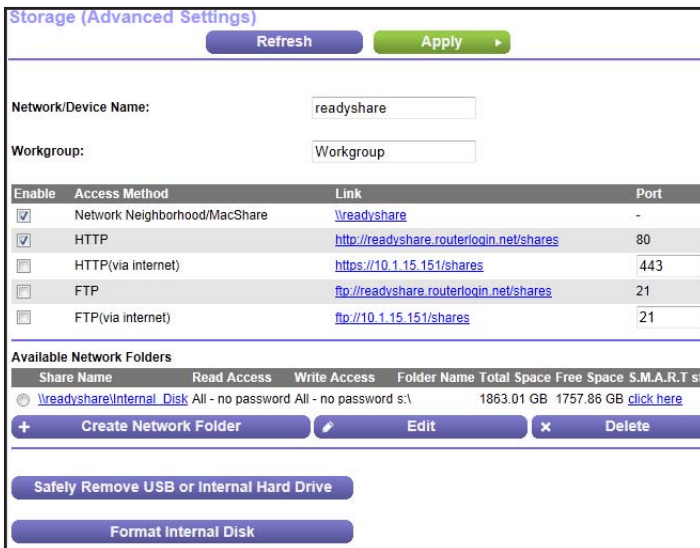

3. Click the **Safely Remove USB or Internal Hard Drive** button.

4. Use the Power On/Off button to turn off the router.

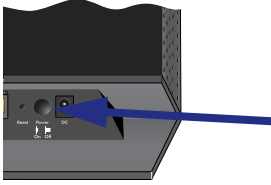

5. Open the router side door and release the internal latch as shown.

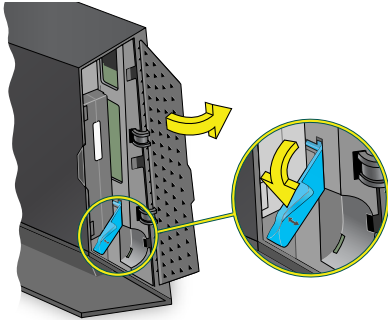

6. Grab the top and bottom of the HDD with your fingers and pull to remove it.

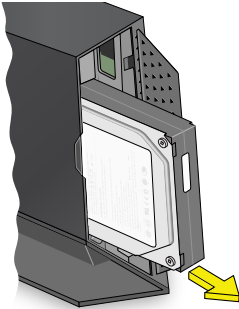

7. If you are installing a 0.75-inch-thick HDD (this is uncommon), insert the tray into the router.

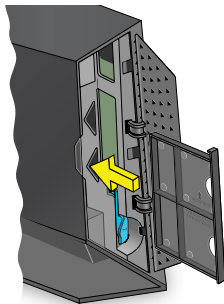

Follow the *THIS SIDE UP* and the *BACK OF PRODUCT* signs on the tray to place it in the correct orientation.

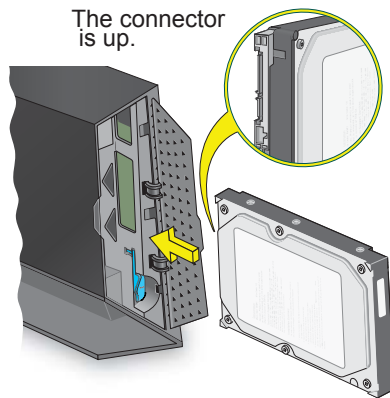

**8.** Insert the HDD.**9.** Close the latch to secure the HDD in place.**10.** Close the side door of the router.

If the latch is not in the correct position or the HDD is inserted in the wrong direction, then the side door to the router cannot be closed.

When you turn on the router, the HDD LED shows the status of the HDD. See [Table 1, LED description](#) on page 10.

## Format the HDD

If you install the HDD during your initial router setup, the router detects it and prompts you to format the HDD. You can follow the prompts to do so, or wait until later and log in to the router to format the HDD from the router menu.

**CAUTION:**

Formatting the internal disk drive erases all files and folders that are stored on it.

➤ To format the HDD:

1. Select **Advanced > Storage > Advanced Settings**.

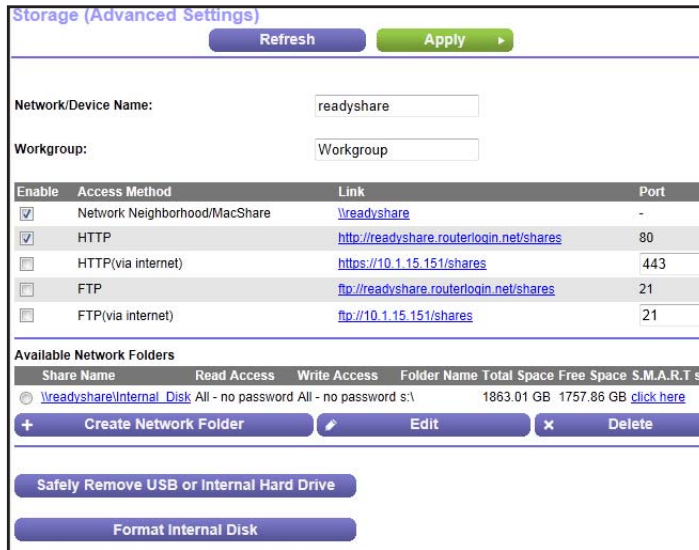

2. Click the **Format Internal Disk** button.

# 6 ReadySHARE Printer

---

# 6

## Share a printer connected to the USB port

ReadySHARE Printer is compatible with Macs and Windows PCs. It lets you connect a USB printer to the router's USB port, and access it wirelessly.

This chapter contains the following sections:

- *ReadySHARE Printer*
- *USB Control Center Utility*

For more information about ReadySHARE features, visit [www.netgear.com/readystatechange](http://www.netgear.com/readystatechange).

## ReadySHARE Printer

You can connect a USB printer to the router's USB port, and share it among Windows and Mac computers on the network.

➤ **To set up ReadySHARE Printer:**

1. Connect the USB printer to the router's USB port with a USB printer cable.
2. Install the USB printer driver software *on each computer* that will share the printer. If you do not have the printer driver, contact the printer manufacturer to find and download the most recent printer driver software.
3. On each computer that shares the printer, download the NETGEAR USB Control Center utility. The NETGEAR USB utility has a Mac version and a Windows version, which you can access in two different ways:
  - From the ReadySHARE Printer area of the page you reach through this URL: [www.netgear.com/readyspace](http://www.netgear.com/readyspace)



- From the ReadySHARE tab of genie. (See *NETGEAR genie App and Mobile genie App* on page 25).

---

**Note:** You *have to* install this utility before you can use the ReadySHARE Printer feature. For the ReadySHARE Printer feature to work, this utility has to be running in the background.

---

4. Follow the instructions to install the NETGEAR USB Control Center utility.



5. After you have installed the utility, select the language.



6. The first time you access the utility, you are asked to select the printer and click the **Connect** button.

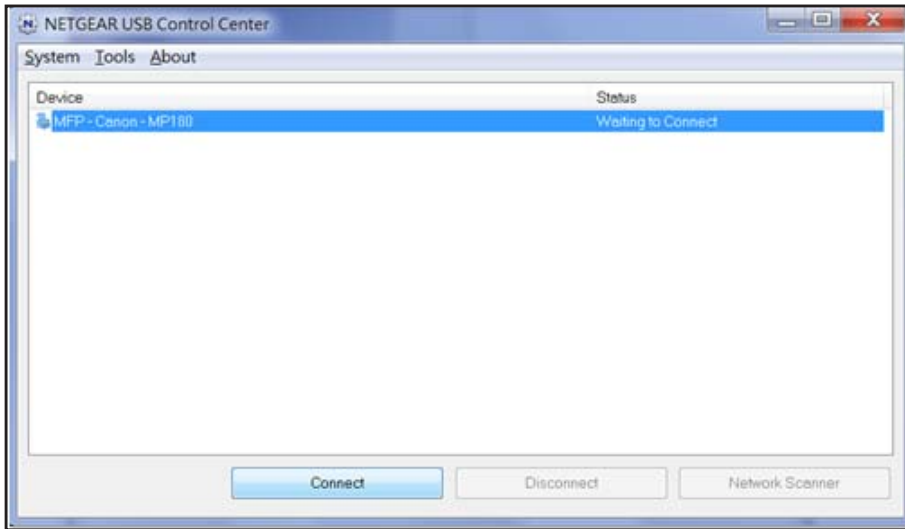

Once the connection is established, the status changes to Manually connected by xxx.

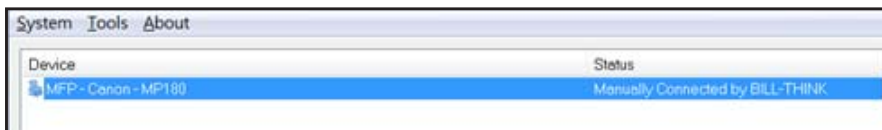

You can click the **Disconnect** button at any time to release the connection. The status then changes to Available.

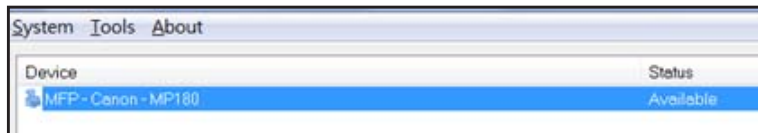

After you click the Connect button once on each computer in the network, the utility on each of them handles the printing queue and handling. The status of the printer is Available on all of the computers.

- When the status is Available, you can use the USB printer.
- When the status is Manually connected by xxx, only the xxx computer can use the printer. Other network devices must wait until the xxx computer has released the connection, or until the connection times out (the default time-out value is 30 seconds).

- You can set the value for the default time-out time from **Tools > Configuration**.



- The USB Control Center utility must be running for the computer to be able to print to the USB printer attached to the router. If you exit the utility, printing does not work.
  - Some firewall software, such as Comodo, blocks the ReadySHARE Print utility from accessing the USB printer. If you do not see the printer in the utility, you can disable the firewall temporarily to allow the utility to work.
7. If your printer supports scanning, make sure that the printer is in the Available state, and click the **Network Scanner** button. The Scanner window opens so you can use the printer for scanning.

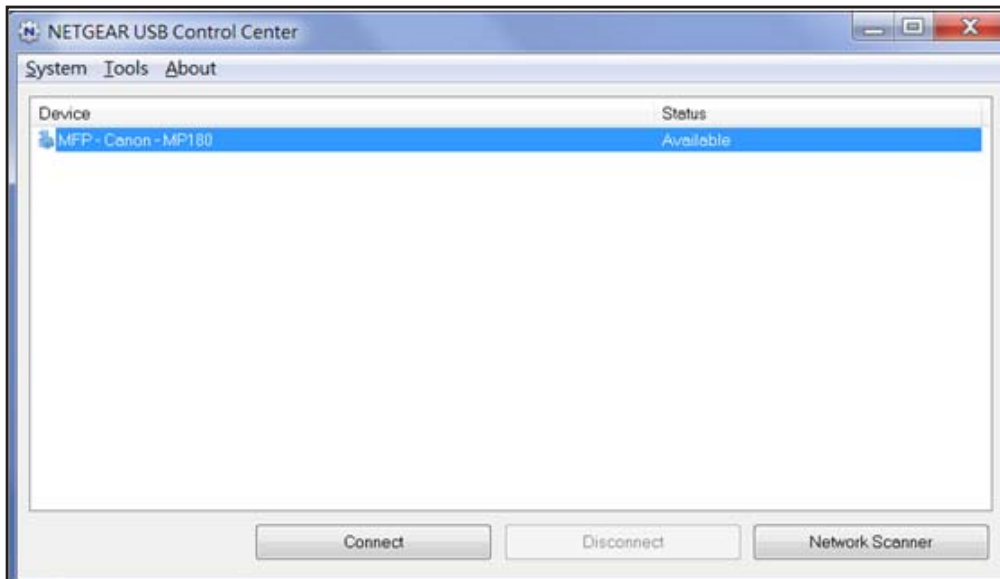

## USB Control Center Utility

The USB Control Center utility allows you to control a shared USB device from your computer that is connected to the USB port on your router. The utility allows you to control a printer and a scanner.

You have to install the utility on each computer on the network from which you want to control the device. You can download this utility for PC and Mac at [www.netgear.com/landing/en-us/readystatechange.aspx](http://www.netgear.com/landing/en-us/readystatechange.aspx).

When you launch the USB Control Center utility, a screen similar to the following displays:

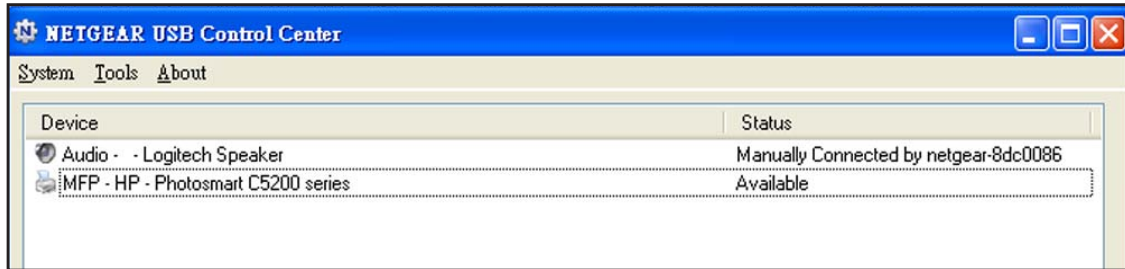

The main screen shows a device icon, the description for this USB device, and its status.

**Available.** The device is available from the computer that you are using.

**Waiting to Connect.** You need to connect to this device from the computer that you are using. If this is the first time you are connecting, you might be prompted to install the device driver.

Menu selections:

- **System.** Exit the utility.
- **Tools.** Access the Control Center Configuration to set up your shared USB device. See the following section, [Control Center Configuration](#).
- **About.** View details about the USB Control Center software.



## Control Center Configuration

Select **Tools > Configuration** to display the following screen:



**Automatically execute when logging on Windows.** Enable this utility to start automatically when you are logged in to Windows.

**Timeout.** Specify the time-out value for holding the USB resource when it is not in use.

**Language.** Select the display language for this utility.

## USB Printer

The first time you use a printer, click **Connect**. You might be asked to install the driver for this printer. After the driver is installed, the printer status changes to Available.

---

**Note:** Some USB printers (for example: HP and Lexmark printers) request that you do not connect the USB cable until their installation software prompts you to do so.

---

If the USB printer is detected and connected automatically, you need to disconnect the printer, and then wait for the prompt asking you to click **Connect**.

Once the printer shows Available status, it is no longer grayed out in a Paused state in the Windows Printers window.

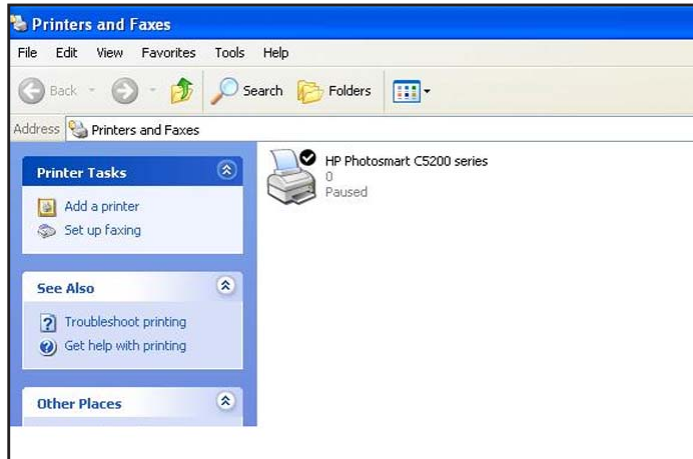

This USB printer is ready. The utility does not need to hold the connection of this USB printer. Once there is any print job for this printer, the USB utility connects to this USB printer and prints. After the print job is done, the printer status returns to the Paused state.

## Scan with a Multifunction Printer

You can use the scan feature of a multifunction printer.

1. Make sure that the printer status shows as Available.
2. Click the **Network Scanner** button.

This activates the scanner window to perform scans.

# 7 Security

---

# 7

## Keeping unwanted content out of your network

This chapter explains how to use the basic firewall features of the router to prevent objectionable content from reaching the computers and devices on your network.

This chapter includes the following sections:

- *Keyword Blocking of HTTP Traffic*
- *Block Services (Port Filtering)*
- *Schedule Blocking*
- *Security Event Email Notifications*

## Keyword Blocking of HTTP Traffic

Use keyword blocking to prevent certain types of HTTP traffic from accessing your network. The blocking can be always or according to a schedule.

1. Select **Advanced > Security > Block Sites** to display the following screen:

2. Select one of the keyword blocking options:
  - **Per Schedule.** Turn on keyword blocking according to the Schedule screen settings.
  - **Always.** Turn on keyword blocking all the time, independent of the Schedule screen.
3. In the keyword field, enter a keyword or domain, click **Add Keyword**, and click **Apply**.

The keyword list supports up to 32 entries. Here are some sample entries:

- Specify XXX to block <http://www.badstuff.com/xxx.html>.
- Specify .com if you want to allow only sites with domain suffixes such as .edu or .gov.
- Enter a period (.) to block all Internet browsing access.

➤ **To delete a keyword or domain:**

1. Select the keyword you want to delete from the list.
2. Click **Delete Keyword** and then **Apply** to save your changes.

➤ **To specify a trusted computer:**

You can exempt one trusted computer from blocking and logging. The computer you exempt has to have a fixed IP address.

1. In the Trusted IP Address field, enter the IP address.
2. Click **Apply** to save your changes.

## Block Services (Port Filtering)

Services are functions that server computers perform at the request of client computers. For example, web servers serve web pages, time servers serve time and date information, and game hosts serve data about other players' moves. When a computer on the Internet sends a request for service to a server computer, the requested service is identified by a service or port number. This number appears as the destination port number in the transmitted IP packets. For example, a packet that is sent with the destination port number 80 is an HTTP (web server) request.

The service numbers for many common protocols are defined by the Internet Engineering Task Force (IETF at <http://www.ietf.org/>) and published in RFC1700, "Assigned Numbers." Service numbers for other applications are typically chosen from the range 1024 to 65535 by the authors of the application. Although the router already holds a list of many service port numbers, you are not limited to these choices. Usually, you can determine this information by contacting the publisher of the application or the relevant user groups or news groups.

The Block Services screen lets you add and block specific Internet services by computers on your network. This is called service blocking or port filtering. To add a service for blocking, first determine which port number or range of numbers the application uses.

### ➤ To block services:

1. Select **Advanced > Security > Block Services** to display the following screen:

The screenshot shows the 'Block Services' configuration interface. At the top, there are 'Cancel' and 'Apply' buttons. The 'Services Blocking' section has three radio button options: 'Never' (which is selected), 'Per Schedule', and 'Always'. Below this is a 'Service Table' with a header row containing columns for '#', 'Service Type', 'Port', and 'IP'. At the bottom of the table area, there are three buttons: '+ Add', 'Edit', and 'Delete'.

2. Select either **Per Schedule** or **Always** to enable service blocking, and click **Apply**. If you selected **Per Schedule**, specify a time period in the *Schedule Blocking* screen as described in *Schedule Blocking* on page 87.

3. Click **Add** to add a service. The Block Services Setup screen displays:

4. From the Service Type list, select the application or service to allow or block. The list already displays several common services, but you are not limited to these choices. To add any additional services or applications that do not already appear, select **User Defined**.
5. If you know that the application uses either TCP or UDP, select the appropriate protocol. If you are not sure, select **Both**.
6. Enter the starting and ending port numbers. If the application uses a single port number, enter that number in both fields.
7. Select the radio button for the IP address configuration you want to block, and enter the IP addresses. You can block the specified service for a single computer, a range of computers with consecutive IP addresses, or all computers on your network.
8. Click **Add** to enable your Block Services Setup selections.

## Schedule Blocking

You can specify the days and time that you want to block Internet access.

➤ **To schedule blocking:**

1. Select **Advanced > Security > Schedule** to display the following screen:

**Schedule**

✕ Cancel Apply ▶

**Days to Block:**

Every Day

Sunday

Monday

Tuesday

Wednesday

Thursday

Friday

Saturday

---

**Time of day to block:(use 24-hour clock)**

All Day

Start Blocking  Hour  Minute

End Blocking  Hour  Minute

---

**Time Zone**

(GMT-08:00) Pacific Time (US & Canada); Tijuana ▼

Automatically adjust for daylight savings time

Current Time: Thursday, Sep 13, 2012 12:59:36

2. Set up the schedule for blocking keywords and services.
  - **Days to Block.** Select days on which you want to apply blocking by selecting the appropriate check boxes, or select **Every Day** to select the check boxes for all days.
  - **Time of Day to Block** Select a start and end time in 24-hour format, or select **All Day** for 24-hour blocking.
3. Select your time zone from the list. If you use daylight savings time, select the **Automatically adjust for daylight savings time** check box.
4. Click **Apply** to save your settings.

## Security Event Email Notifications

To receive logs and alerts by email, provide your email information in the Email screen, and specify which alerts you want to receive and how often.

➤ **To set up email notifications:**

1. Select **Advanced > Security > Email** to display the following screen:

2. To receive email logs and alerts from the router, select the **Turn Email Notification On** check box.
3. In the Your Outgoing Mail Server field, enter the name of your ISP's outgoing (SMTP) mail server (such as mail.myISP.com). You might be able to find this information in the configuration screen of your email program. If you leave this field blank, no log and alert messages are sent.
4. Enter the email address to which logs and alerts are sent in the Send to This Email Address field. This email address is also used for the From address. If you leave this field blank, log and alert messages are not sent.
5. If your outgoing email server requires authentication, select the **My mail server requires authentication** check box. Fill in the User Name and Password fields for the outgoing email server.
6. You can have email alerts sent immediately when someone attempts to visit a blocked site, and you can specify that logs are sent automatically.

If you select the Weekly, Daily, or Hourly option and the log fills up before the specified period, the log is emailed to the specified email address. After the log is sent, the log is cleared from the router's memory. If the router cannot email the log file, the log buffer might fill up. In this case, the router overwrites the log and discards its contents.

7. Click **Apply** to save your settings.



# 8 Administration

---

# 8

## Managing your network

This chapter describes the router settings for administering and maintaining your router and home network. See [Remote Management](#) on page 118 for information about upgrading or checking the status of your router over the Internet. For information about monitoring Internet traffic, see [Traffic Meter](#) on page 126.

This chapter includes the following sections:

- [Upgrade the Firmware](#)
- [View Router Status](#)
- [View Logs of Web Access or Attempted Web Access](#)
- [Manage the Configuration File](#)
- [Set Password](#)

## Upgrade the Firmware

The router firmware (routing software) is stored in flash memory. You can update the firmware from the Administration menu on the Advanced tab. You might see a message at the top of the genie screens when new firmware is available for your product.

You can use the Check button on the Router Update screen to check and update to the latest firmware for your product if new firmware is available.

➤ **To check for new firmware and update your router:**

1. Select **Advanced > Administration > Firmware Upgrade** to display the following screen:

2. Click **Check**.  
If new firmware is available, the router finds it.
3. Click **Yes** to update and locate the firmware you downloaded (the file ends in .img).



### WARNING!

**When uploading firmware to the router, *do not* interrupt the web browser by closing the window, clicking a link, or loading a new page. If the browser is interrupted, it could corrupt the firmware.**

When the upload is complete, your router restarts. The upgrade process typically takes about 1 minute. Read the new firmware release notes to determine whether you need to reconfigure the router after upgrading.

## View Router Status

To view router status and usage information, select **Advanced Home** or select **Administration > Router Status** to display the following screen:

The screenshot displays the router's status page with the following sections:

- Router Information:** Hardware Version (WNDR4700), Firmware Version (V1.0.0.27-RC1), GUI Language Version (V1.0.0.120), Operation Mode (Router), and a Reboot button.
- Internet Port:** MAC Address (84:1B:5E:87:8C:FD), IP Address (10.1.15.151), Connection (DHCP), IP Subnet Mask (255.255.255.0), and Domain Name Server (208.67.222.222). Includes Show Statistics and Connection Status buttons.
- LAN Port:** MAC Address (84:1B:5E:87:8C:FC), IP Address (192.168.1.1), and DHCP Server (On).
- Wireless Settings (2.4GHz):** Name (SSID) (NETGEAR71), Region (North America), Channel (Auto (6)), Mode (Up to 195 Mbps), Wireless AP (On), Broadcast Name (On), Wireless isolation (Off), and Wi-Fi Protected Setup (Configured).
- Wireless Settings (5.0GHz):** Name (SSID) (NETGEAR71...), Region (North America), Channel (153(P)+149(S)), Mode (Up to 450 Mbps), Wireless AP (On), Broadcast Name (On), Wireless isolation (Off), and Wi-Fi Protected Setup (Configured).
- Guest Network (2.4GHz) and (5.0GHz):** Both sections show a warning icon.

## Router Information

**Hardware Version.** The router model.

**Firmware Version.** The version of the router firmware. It changes if you upgrade the router firmware.

**GUI Language Version.** The localized language of the user interface.

**LAN Port.**

- **MAC Address.** The Media Access Control address. This is the unique physical address that the Ethernet (LAN) port of the router uses.
- **IP Address.** The IP address that the Ethernet (LAN) port of the router uses. The default is 192.168.1.1.
- **DHCP Server.** Identifies whether the router's built-in DHCP server is active for devices on the LAN.

## Internet Port (WAN) Setup

**MAC Address.** The Media Access Control address, which is the unique physical address that the Internet (WAN) port of the router uses.

**IP Address.** The IP address that the Internet (WAN) port of the router uses. If no address is shown or the address is 0.0.0, the router cannot connect to the Internet.

**Connection.** This shows if the router is using a fixed IP address on the WAN. If the value is DHCP Client, the router obtains an IP address dynamically from the ISP.

**IP Subnet Mask.** The IP subnet mask that the Internet (WAN) port of the router uses.

**Domain Name Server.** The Domain Name Server addresses that the router uses. A Domain Name Server translates human-language URLs such as www.netgear.com into IP addresses.

### Statistics Button

On the Router Status screen, in the Internet Port pane, click the **Show Statistics** button to display the following screen:

System Up Time 00:13:29							
Port	Status	TxPkts	RxPkts	Collisions	Tx B/s	Rx B/s	Up Time
WAN	1000M/Full	3292	37955	0	563	8480	00:13:10
LAN 1	Link Down	5116	4259	0	4771	652	00:00:00
LAN 2	1000M/Full						00:12:58
LAN 3	Link Down						00:00:00
LAN 4	10M/Full						00:13:00
WLAN b/g/n	195M	207	0	0	101	0	00:12:28
WLAN a/n	450M	309	0	0	143	0	00:12:28

Poll Interval : 5 (secs) Set Interval Stop

Figure 7. System up time and poll interval statistics

**System Up Time.** The time elapsed since the router was last restarted.

**Port.** The statistics for the WAN (Internet) and LAN (Ethernet) ports. For each port, the screen displays:

- **Status.** The link status of the port.
- **TxPkts.** The number of packets transmitted on this port since reset or manual clear.
- **RxPkts.** The number of packets received on this port since reset or manual clear.
- **Collisions.** The number of collisions on this port since reset or manual clear.
- **Tx B/s.** The current transmission (outbound) bandwidth used on the WAN and LAN ports.
- **Rx B/s.** The current reception (inbound) bandwidth used on the WAN and LAN ports.
- **Up Time.** The time elapsed since this port acquired the link.
- **Poll Interval.** The interval at which the statistics are updated in this screen.

To change the polling frequency, enter a time in seconds in the Poll Interval field, and click **Set Interval**.

To stop the polling entirely, click **Stop**.

### Connection Status Button

On the Router Status screen in the Internet Port pane, click the **Connection Status** button to view connection status information.

Connection Status	
IP Address	172.24.0.80
Subnet Mask	255.255.240.0
Default Gateway	172.24.0.13
DHCP Server	172.24.0.6
DNS Server	172.24.0.6 10.1.1.6
Lease Obtained	0 days, 4 hours, 0 minutes
Lease Expires	0 days, 3 hours, 46 minutes
<input type="button" value="Release"/> <input type="button" value="Renew"/>	
<input type="button" value="x Close Window"/>	

**Figure 8. View connection status information**

The Release button returns the status of all items to 0. The Renew button refreshes the items. The Close Window button closes the Connection Status screen.

**IP Address.** The IP address that is assigned to the router.

**Subnet Mask.** The subnet mask that is assigned to the router.

**Default Gateway.** The IP address for the default gateway that the router communicates with.

**DHCP Server.** The IP address for the Dynamic Host Configuration Protocol server that provides the TCP/IP configuration for all the computers that are connected to the router.

**DNS Server.** The IP address of the Domain Name Service server that provides translation of network names to IP addresses.

**Lease Obtained.** The date and time when the lease was obtained.

**Lease Expires.** The date and time that the lease expires.

## Wireless Settings (2.4 GHz and 5 GHz)

✓ Wireless Settings (2.4GHz)		✓ Wireless Settings (5.0GHz)	
Name (SSID)	NETGEAR71	Name (SSID)	NETGEAR71-...
Region	North America	Region	North America
Channel	Auto ( 6 )	Channel	153(P)+149(S)
Mode	Up to 195 Mbps	Mode	Up to 450 Mbps
Wireless AP	On	Wireless AP	On
Broadcast Name	On	Broadcast Name	On
Wireless isolation	Off	Wireless isolation	Off
Wi-Fi Protected Setup	Configured	Wi-Fi Protected Setup	Configured

The following settings are displayed:

**Name (SSID).** The wireless network name (SSID) that the router uses. The default name for 5 GHz ends in -5G to distinguish it from the 2.4 GHz network.

**Region.** The geographic region where the router is being used. It might be illegal to use the wireless features of the router in some parts of the world.

**Channel.** Identifies the operating channel of the wireless port being used. The default channel is Auto. When Auto is selected, the router finds the best operating channel available. If you notice interference from nearby devices, you can select a different channel. Channels 1, 6, and 11 do not interfere with each other.

**Mode.** Indicates the wireless communication mode: Up to 54 Mbps, Up to 217 Mbps (default), or Up to 1300 Mbps.

**Wireless AP.** Indicates whether the radio feature of the router is enabled. If this feature is not enabled, the Wireless LED on the front panel is off.

**Broadcast Name.** Indicates whether the router is broadcasting its SSID.

**Wireless Isolation.** Select this check box only if you want to prevent wireless connections to the router.

**Wi-Fi Protected Setup.** Indicates whether Wi-Fi Protected Setup is configured for this network.

## View Logs of Web Access or Attempted Web Access

The log is a detailed record of the websites you have accessed or attempted to access. Up to 256 entries are stored in the log. Log entries appear only when keyword blocking is enabled and no log entries are made for the trusted user.

Select **Advanced > Administration > Logs**. The Logs screen displays.

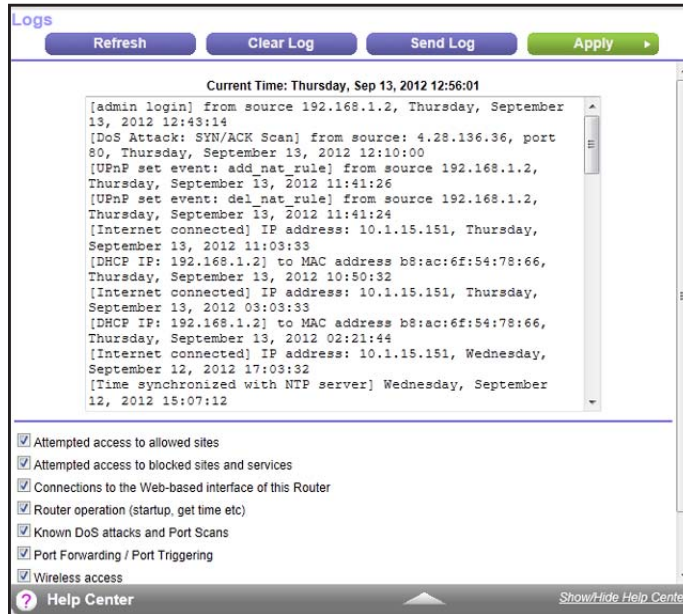

The log screen shows the following information:

- **Date and time.** The date and time the log entry was recorded.
- **Source IP.** The IP address of the initiating device for this log entry.
- **Target address.** The name or IP address of the website or news group visited or to which access was attempted.
- **Action.** Whether the access was blocked or allowed.

To refresh the log screen, click the **Refresh** button.

To clear the log entries, click the **Clear Log** button.

To email the log immediately, click the **Send Log** button.

## Manage the Configuration File

The configuration settings of the CENTRIA are stored within the router in a configuration file. You can back up (save) this file to your computer, restore it, or reset it to the factory default settings.

---

**Note:** For information about backing up your computer onto the router's internal hard disk drive (HDD) or onto a USB device attached to the router USB port, see *Back Up Your Computers* on page 63.

---

### Back Up Settings

➤ **To back up the router's configuration settings:**

1. Select **Advanced > Administration > Backup Settings** to display the following screen:

The screenshot shows the 'Backup Settings' page. It has a title bar 'Backup Settings'. Below it are three sections separated by horizontal lines. The first section is 'Save a copy of current settings' with a blue 'Back Up' button. The second section is 'Restore saved settings from a file' with a 'Browse...' button and a blue 'Restore' button. The third section is 'Revert to factory default settings' with a blue 'Erase' button.

2. Click **Back Up** to save a copy of the current settings.
3. Choose a location to store the .cfg file that is on a computer on your network.

### Restore Configuration Settings

➤ **To restore configuration settings that you backed up:**

1. Enter the full path to the file on your network or click the **Browse** button to find the file.
2. When you have located the .cfg file, click the **Restore** button to upload the file to the router.

Upon completion, the router reboots.



**WARNING!**

**Do not interrupt the reboot process.**



## Erase

Under some circumstances, you might want to erase the configuration and restore the factory default settings. Some examples are if you move the router to a different network or if you have forgotten the password.

You can use the Reset button on the back of the router (see *Factory Settings* on page 139), or you can click the **Erase** button in this screen.

Erase sets the user name to admin, the password to password, and the LAN IP address to 192.168.1.1, and enables the router's DHCP.

## Set Password

This feature allows you to change the default password that is used to log in to the router with the user name admin.

This is not the same as changing the password for wireless access. The label on the bottom of your router shows your unique wireless network name (SSID) and password for wireless access (see *Label* on page 11).

### ➤ To set the password for the user name admin:

1. Select **Advanced > Administration > Set Password** to display the following screen:

2. Type the old password and type the new password twice in the fields on this screen.
3. If you want to be able to recover the password, select the **Enable Password Recovery** check box.
4. Click **Apply** so that your changes take effect.

## Password Recovery

NETGEAR recommends that you enable password recovery if you change the password for the router's user name of admin. Then if you forget the password, you will have an easy way to recover it. This recovery process is supported in Internet Explorer, Firefox, and Chrome browsers, but not in the Safari browser.

### ➤ To set up password recovery:

1. Select the **Enable Password Recovery** check box.
2. Select two security questions and provide answers to them.

3. Click **Apply** to save your changes.

When you use your browser to access the router, the login window displays. If password recovery is enabled, when you click Cancel, the password recovery process starts. You can then enter the saved answers to the security questions to recover the password.

# 9 Advanced Settings

---

# 9

## Customize your network

This chapter describes the advanced features of your router. The information is for readers with advanced networking knowledge who want to set the router up for unique situations such as when remote access from the Internet by IP or domain name is needed.

This chapter includes the following sections:

- *Advanced Wireless Settings*
- *Wireless AP*
- *Wireless Repeating Function (WDS)*
- *Port Forwarding and Triggering*
- *Set Up Port Forwarding to Local Servers*
- *Set Up Port Triggering*
- *Dynamic DNS*
- *Static Routes*
- *Remote Management*
- *USB Settings*
- *Universal Plug and Play*
- *IPv6*
- *Traffic Meter*

## Advanced Wireless Settings

Select **Advanced > Advanced Setup > Wireless Settings** to display the following screen:

**Advanced Wireless Settings**

**Advanced Wireless Settings (2.4GHz b/g/n)**

Enable Wireless Router Radio

Enable 20/40 MHz Coexistence

Fragmentation Length (256-2346)

CTS/RTS Threshold (1-2347)

Preamble Mode

Transmit Power Control

Turn off wireless signal by schedule

The wireless signal is scheduled to turn off during the following time period:

Period	Start	End	Recurrence pattern

---

**Advanced Wireless Settings (5GHz a/n)**

Enable Wireless Router Radio

Enable 20/40 MHz Coexistence

Fragmentation Length (256-2346)

CTS/RTS Threshold (1-2347)

Preamble Mode

Transmit Power Control

Turn off wireless signal by schedule

The wireless signal is scheduled to turn off during the following time period:

Period	Start	End	Recurrence pattern

[? Help Center](#) [Show/Hide Help Center](#)

The following settings are available in this screen:

**Enable Wireless Router Radio.** You can completely turn off the wireless portion of the wireless router by clearing this check box. Select this check box again to enable the wireless portion of the router. When the wireless radio is disabled, other members of your household can use the router by connecting their computers to the router with an Ethernet cable.

**Enable 20/40 MHz Coexistence.** This is for the 2.4 GHz band only. The 20/40 MHz coexistence function is enabled by default, which is required for Wi-Fi certification.

CENTRIA can run in either 40 MHz mode or 20 MHz mode. When this check box is selected, CENTRIA runs in 40 MHz mode unless there is another nearby WiFi network in the area already running in 40 MHz mode. If that happens, CENTRIA runs in 20 MHz mode to coexist with that network.

If you want CENTRIA to always run in 40 MHz mode, clear this check box and click **Apply**.

---

**Note:** The Fragmentation Length, CTS/RTS Threshold, and Preamble Mode options are reserved for wireless testing and advanced configuration only. Do not change these settings.

---

**Turn off wireless signal by schedule.** You can use this feature to turn off the wireless signal from your router at times when you do not need a wireless connection. For example, you could turn it off for the weekend if you leave town.

**WPS Settings.** You can add WPS devices to your network.

**AP Mode.** You can set up the CENTRIA as a wireless AP (access point). See [Wireless AP](#) on page 102.

**Wireless Card Access List.** Click the **Set Up Access List** button display the Wireless Card Access List screen. You can restrict access to your network to specific devices based on their MAC address.

## Restrict Wireless Access by MAC Address

You can set up a list of computers and wireless devices that are allowed to join the wireless network. This list is based on the unique MAC address of each computer and device.

Each network device has a MAC address, which is a unique 12-character physical address, containing the hexadecimal characters 0–9, a–f, or A–F only, and separated by colons (for example, 00:09:AB:CD:EF:01). Typically, the MAC address is on the label of the wireless card or network interface device. If you do not have access to the label, you can display the MAC address using the network configuration utilities of the computer. You might also find the MAC addresses in the Attached Devices screen.

### ➤ To restrict access based on MAC addresses:

1. On the Advanced Wireless Settings screen, click the **Setup Access List** to display the Wireless Card Access List.

2. Click **Add** to add a wireless device to the wireless access control list.

The Wireless Card Access Setup screen opens and displays a list of currently active wireless cards and their Ethernet MAC addresses.

3. If the computer or device you want is in the Available Wireless Cards list, select that radio button; otherwise, type a name and the MAC address. You can usually find the MAC address on the bottom of the wireless device.

**Tip:** You can copy and paste the MAC addresses from the Attached Devices screen into the MAC Address field of this screen. To do this, use each wireless computer to join the wireless network. The computer should then appear in the Attached Devices screen.

4. Click **Add** to add this wireless device to the Wireless Card Access List. The screen changes back to the list screen.
5. Add each computer or device you want to allow to connect wirelessly.
6. Select the **Turn Access Control On** check box.
7. Click **Apply**.

## Wireless AP

The CENTRIA can be configured as a wireless AP. This mode lets you add a second router to your network. To use the wireless AP feature, you need two routers: one set up as a router and the other set up as a wireless AP.

For example, you could install the first router in a room like a home office that has your Internet connection. Then, set up the second router as a wireless AP. Place the router that is an AP in a different room that has your home entertainment center. Cable the router that is a wireless AP to your Smart TV, DVR, game console or Blu-ray player, and then use its 802.11ac WiFi connection to the first router.

➤ **To set up a router as a wireless access point:**

1. Make sure that your router has an Internet connection and that wireless devices can connect to it.
2. Select **Advanced > Advanced Setup > Wireless AP**.

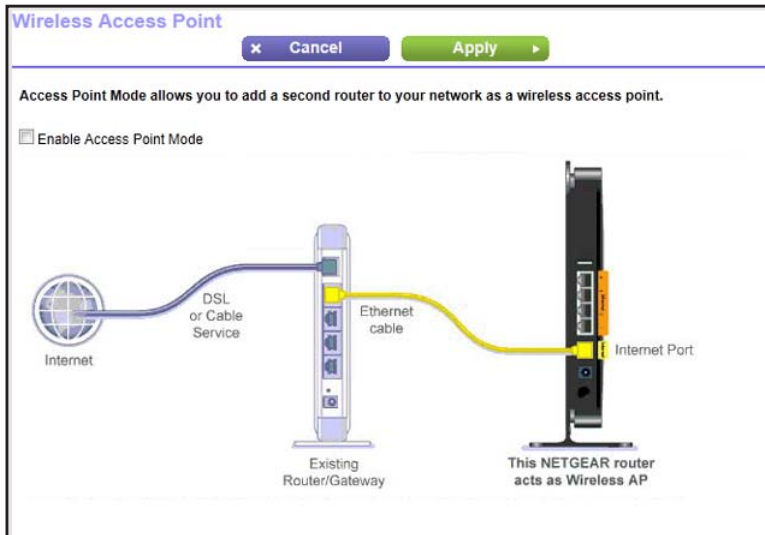

3. Select the **Enable Access Point Mode** radio button.
4. Click **Apply**.

## Wireless Repeating Function (WDS)

You can set the CENTRIA up to be used as a wireless access point (AP). Doing this enables the router to act as a wireless repeater. A wireless repeater connects to another wireless router as a client where the network to which it connects becomes the ISP service.

Wireless repeating is a type of Wireless Distribution System (WDS). A WDS allows a wireless network to be expanded through multiple access points instead of using a wired backbone to link them. The following figure shows a wireless repeating scenario.

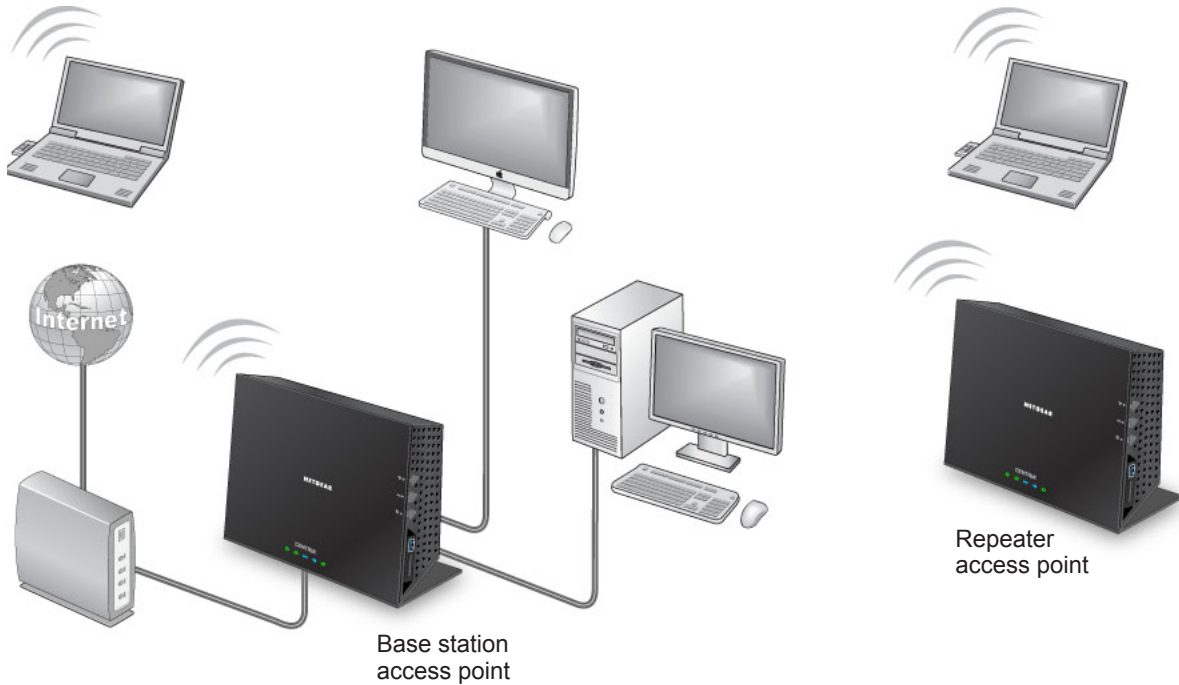

**Figure 9. Wireless repeating scenario**

---

**Note:** If you use the wireless repeating function, you need to select either **WEP** or **None** as a security option in the Wireless Settings screen. The WEP option displays only if you select the wireless mode **Up to 54 Mbps** in the Wireless Settings screen.

---

**Wireless base station.** The router acts as the parent access point, bridging traffic to and from the child repeater access point. The base station also handles wireless and wired local computers. To configure this mode, you have to know the MAC addresses of the child repeater access point.

**Wireless repeater.** The router sends all traffic from its local wireless or wired computers to a remote access point. To configure this mode, you have to know the MAC address of the remote parent access point.

The router is always in dual-band concurrent mode, unless you turn off one radio. If you enable the wireless repeater in either radio band, the wireless base station or wireless repeater cannot be enabled in the other radio band. However, if you enable the wireless base station in either radio band and use the other radio band as a wireless router or wireless base station, dual-band concurrent mode is not affected.

For you to set up a wireless network with WDS, both access points must meet the following conditions:

- Both access points have to use the same SSID, wireless channel, and encryption mode.
- Both access points have to be on the same LAN IP subnet. That is, all the access point LAN IP addresses are in the same network.
- All LAN devices (wired and wireless computers) are configured to operate in the same LAN network address range as the access points.

➤ **To view or change the Wireless Repeating Function settings:**

Select **Advanced > Advanced Setup > Wireless Repeating** to view or change wireless repeater settings for the router.

Scroll to view more settings

The following settings are available:

- **Enable Wireless Repeating Function.** Select the check box for the 2.4 GHz or 5 GHz network to use the wireless repeating function.
- **Wireless MAC of this router.** This field displays the MAC address for your router for your reference. You need to enter this MAC address in the corresponding Wireless Repeating Function screen of the other access point you are using.
- **Wireless Repeater.** If your router is the repeater, select this check box.



**Repeater IP Address.** If your router is the repeater, enter the IP address of the other access point.

**Disable Wireless Client Association.** If your router is the repeater, selecting this check box means that wireless clients cannot associate with it. Only LAN client associations are allowed.

- If you are setting up a point-to-point bridge, select this check box.
- If you want all client traffic to go through the other access point (repeater with wireless client association), leave this check box cleared.

**Base Station MAC Address.** If your router is the repeater, enter the MAC address for the access point that is the base station.

- **Wireless Base Station.** If your router is the base station, select this check box.

**Disable Wireless Client Association.** If your router is the base station, selecting this check box means that wireless clients cannot associate with it. Only LAN client associations are allowed.

**Repeater MAC Address (1 through 4).** If your router is the base station, it can act as the “parent” of up to four other access points. Enter the MAC addresses of the other access points in these fields.

## Set Up the Base Station

The wireless repeating function works only in hub and spoke mode. The units cannot be daisy-chained. You have to know the wireless settings for both units. You have to know the MAC address of the remote unit. First, set up the base station, and then set up the repeater.

### ➤ To set up the base station:

1. Set up both units with the same wireless settings (SSID, mode, channel, and security). The wireless security option must be set to None or WEP.

2. Select **Advanced > Advanced Setup > Wireless Repeating Function** to display the Wireless Repeating Function screen.

← Scroll to view more settings

3. Select the **Enable Wireless Repeating Function** check box and select the **Wireless Base Station** radio button.
4. Enter the MAC address for one or more repeater units.
5. Click **Apply** to save your changes.

## Set Up a Repeater Unit

Use a wired Ethernet connection to set up the repeater unit to avoid conflicts with the wireless connection to the base station.

---

**Note:** If you are using the WNDR4700/WNDR4720 base station with a non-NETGEAR router as the repeater, you might need to change additional configuration settings. In particular, you should disable the DHCP server function on the wireless repeater AP.

---

### ➤ To configure the router as a repeater unit:

1. Log in to the router that will be the repeater.
2. Select **Basic > Wireless Settings** and verify that the wireless settings match the base unit exactly. The wireless security option must be set to None or WEP.
3. Select **Advanced > Wireless Repeating Function**, and select the **Enable Wireless Repeating Function** check box and the **Wireless Repeater** radio button.

4. Fill in the Repeater IP Address field. This IP address must be in the same subnet as the base station, but different from the LAN IP address of the base station.
5. Click **Apply** to save your changes.
6. Verify connectivity across the LANs.

A computer on any wireless or wired LAN segment of the router can connect to the Internet or share files and printers with any other wireless or wired computer or server connected to the other access point.

## Port Forwarding and Triggering

By default, the router blocks inbound traffic from the Internet to your computers except replies to your outbound traffic. You might need to create exceptions to this rule for these purposes:

- To allow remote computers on the Internet to access a server on your local network.
- To allow certain applications and games to work correctly when your router does not recognize their replies.

Your router provides two features for creating these exceptions: port forwarding and port triggering. The next sections provide background information to help you understand how port forwarding and port triggering work, and the differences between the two.

### Remote Computer Access Basics

When a computer on your network needs to access a computer on the Internet, your computer sends your router a message containing the source and destination address and process information. Before forwarding your message to the remote computer, your router has to modify the source information and create and track the communication session so that replies can be routed back to your computer.

Here is an example of normal outbound traffic and the resulting inbound responses:

1. You open a browser and your operating system assigns port number 5678 to this browser session.
2. You type `http://www.example.com` into the URL field, and your computer creates a web page request message with the following address and port information. The request message is sent to your router.

**Source address.** Your computer's IP address.

**Source port number.** 5678, which is the browser session.

**Destination address.** The IP address of `www.example.com`, which your computer finds by asking a DNS server.

**Destination port number.** 80, which is the standard port number for a web server process.

3. Your router creates an entry in its internal session table describing this communication session between your computer and the web server at `www.example.com`. Before sending

the web page request message to `www.example.com`, your router stores the original information and then modifies the source information in the request message, performing Network Address Translation (NAT):

- The source address is replaced with your router's public IP address. This is necessary because your computer uses a private IP address that is not globally unique and cannot be used on the Internet.
- The source port number is changed to a number chosen by the router, such as 33333. This is necessary because two computers could independently be using the same session number.

Your router then sends this request message through the Internet to the web server at `www.example.com`.

4. The web server at `www.example.com` composes a return message with the requested web page data. The return message contains the following address and port information. The web server then sends this reply message to your router.

**Source address.** The IP address of `www.example.com`.

**Source port number.** 80, which is the standard port number for a web server process.

**Destination address.** The public IP address of your router.

**Destination port number.** 33333.

5. Upon receiving the incoming message, your router checks its session table to determine whether there is an active session for port number 33333. Finding an active session, the router then modifies the message to restore the original address information replaced by NAT. Your router sends this reply message to your computer, which displays the web page from `www.example.com`. The message now contains the following address and port information.

**Source address.** The IP address of `www.example.com`.

**Source port number.** 80, which is the standard port number for a web server process.

**Destination address.** Your computer's IP address.

**Destination port number.** 5678, which is the browser session that made the initial request.

6. When you finish your browser session, your router eventually detects a period of inactivity in the communications. Your router then removes the session information from its session table, and incoming traffic is no longer accepted on port number 33333.

## Port Triggering to Open Incoming Ports

In the preceding example, requests are sent to a remote computer by your router from a particular service port number. Replies from the remote computer to your router are directed to that port number. If the remote server sends a reply to a different port number, your router does not recognize it and discards it. However, some application servers (such as FTP and IRC servers) send replies to multiple port numbers. Using the port triggering function of your

router, you can tell the router to open additional incoming ports when a particular outgoing port originates a session.

An example is Internet Relay Chat (IRC). Your computer connects to an IRC server at destination port 6667. The IRC server not only responds to your originating source port, but also sends an “identify” message to your computer on port 113. Using port triggering, you can tell the router, “When you initiate a session with destination port 6667, you have to also allow incoming traffic on port 113 to reach the originating computer.” Using steps similar to the preceding example, the following sequence shows the effects of the port triggering rule you have defined:

1. You open an IRC client program to start a chat session on your computer.
2. Your IRC client composes a request message to an IRC server using a destination port number of 6667, the standard port number for an IRC server process. Your computer then sends this request message to your router.
3. Your router creates an entry in its internal session table describing this communication session between your computer and the IRC server. Your router stores the original information, performs Network Address Translation (NAT) on the source address and port, and sends this request message through the Internet to the IRC server.
4. Noting your port triggering rule and having observed the destination port number of 6667, your router creates an additional session entry to send any incoming port 113 traffic to your computer.
5. The IRC server sends a return message to your router using the NAT-assigned source port (as in the previous example, say port 33333) as the destination port. The IRC server also sends an “identify” message to your router with destination port 113.
6. Upon receiving the incoming message to destination port 33333, your router checks its session table to determine whether there is an active session for port number 33333. Finding an active session, the router restores the original address information replaced by NAT and sends this reply message to your computer.
7. Upon receiving the incoming message to destination port 113, your router checks its session table and learns that there is an active session for port 113, associated with your computer. The router replaces the message’s destination IP address with your computer’s IP address and forwards the message to your computer.
8. When you finish your chat session, your router eventually senses a period of inactivity in the communications. The router then removes the session information from its session table, and incoming traffic is no longer accepted on port numbers 33333 or 113.

To configure port triggering, you need to know which inbound ports the application needs. Also, you need to know the number of the outbound port that will trigger the opening of the inbound ports. Usually, you can determine this information by contacting the publisher of the application or the relevant user groups or news groups.

---

**Note:** Only one computer at a time can use the triggered application.

---

## Port Forwarding to Permit External Host Communications

In both of the preceding examples, your computer initiates an application session with a server computer on the Internet. However, you might need to allow a client computer on the Internet to initiate a connection to a server computer on your network. Normally, your router ignores any inbound traffic that is not a response to your own outbound traffic. You can configure exceptions to this default rule by using the port forwarding feature.

A typical application of port forwarding can be shown by reversing the client-server relationship from the previous web server example. In this case, a remote computer's browser needs to access a web server running on a computer in your local network. Using port forwarding, you can tell the router, "When you receive incoming traffic on port 80 (the standard port number for a web server process), forward it to the local computer at 192.168.1.123." The following sequence shows the effects of the port forwarding rule you have defined:

1. The user of a remote computer opens a browser and requests a web page from `www.example.com`, which resolves to the public IP address of your router. The remote computer composes a web page request message with the following destination information:

**Destination address.** The IP address of `www.example.com`, which is the address of your router.

**Destination port number.** 80, which is the standard port number for a web server process.

The remote computer then sends this request message through the Internet to your router.

2. Your router receives the request message and looks in its rules table for any rules covering the disposition of incoming port 80 traffic. Your port forwarding rule specifies that incoming port 80 traffic should be forwarded to local IP address 192.168.1.123. Therefore, your router modifies the destination information in the request message:

The destination address is replaced with 192.168.1.123.

Your router then sends this request message to your local network.

3. Your web server at 192.168.1.123 receives the request and composes a return message with the requested web page data. Your web server then sends this reply message to your router.
4. Your router performs NAT on the source IP address, and sends this request message through the Internet to the remote computer, which displays the web page from `www.example.com`.

To configure port forwarding, you need to know which inbound ports the application needs. Usually, you can determine this information by contacting the publisher of the application or the relevant user groups or news groups.

## How Port Forwarding Differs from Port Triggering

The following points summarize the differences between port forwarding and port triggering:

- Port triggering can be used by any computer on your network, although only one computer can use it at a time.
- Port forwarding is configured for a single computer on your network.
- Port triggering does not require that you know the computer's IP address in advance. The IP address is captured automatically.
- Port forwarding requires that you specify the computer's IP address during configuration, and the IP address can never change.
- Port triggering requires specific outbound traffic to open the inbound ports, and the triggered ports are closed after a period of no activity.
- Port forwarding is always active and does not need to be triggered.

## Set Up Port Forwarding to Local Servers

Using the port forwarding feature, you can allow certain types of incoming traffic to reach servers on your local network. For example, you might want to make a local web server, FTP server, or game server visible and available to the Internet.

Use the Port Forwarding screen to configure the router to forward specific incoming protocols to computers on your local network. In addition to servers for specific applications, you can also specify a default DMZ server to which all other incoming protocols are forwarded.

Before starting, determine which type of service, application, or game you want to provide. Find out the local IP address of the computer that will provide the service. The server computer has to always have the same IP address.

### ➤ To set up port forwarding:

**Tip:** To ensure that your server computer always has the same IP address, use the reserved IP address feature of your CENTRIA.

1. Select **Advanced Setup > Port Forwarding/Port Triggering** to display the following screen:

Port Forwarding / Port Triggering

Please select the service type.

Port Forwarding  
 Port Triggering

Service Name: FTP      Server IP Address: 192.168.1      + Add

#	Service Name	External Start Port	External End Port	Internal Start Port	Internal End Port	Internal IP address
<input type="button" value="Edit Service"/> <input type="button" value="Delete Service"/>						
<input type="button" value="+ Add Custom Service"/>						

Port Forwarding is selected as the service type.

- From the Service Name list, select the service or game that you will host on your network. If the service does not appear in the list, see [Add a Custom Service](#) on page 112.
- In the corresponding Server IP Address field, enter the last digit of the IP address of your local computer that will provide this service.
- Click **Add**. The service appears in the list in the screen.

## Add a Custom Service

To define a service, game, or application that does not appear in the Service Name list, first determine which port number or range of numbers the application uses. Usually, you can determine this information by contacting the publisher of the application or the relevant user groups or news groups.

### ➤ To add a custom service:

- Select **Advanced > Advanced Setup > Port Forwarding/Port Triggering**.
- Select **Port Forwarding** as the service type.
- Click the **Add Custom Service** button to display the following screen:

Or select from currently attached devices	
IP Address	Device Name
192.168.1.2	TECHPUBS

- In the Service Name field, enter a descriptive name.
- In the Protocol list, select the protocol. If you are unsure, select **TCP/UDP**.
- Specify the port settings:
  - External Starting Port** and **External Ending Port**. These are the starting number and ending number for the public ports at the Internet interface. For single port forwarding, number in the External Starting Port and External Ending Port fields can be the same. The range is from 1 to 65534.
  - Use the same port range for Internal port**. This check box is selected by default. If you want to use different ports, clear this check box and specify the internal ports.
  - Internal Starting Port** and **Internal Ending Port**. These are the starting number and ending number for the ports of a computer on the router's local area network (LAN). These are private ports. The router calculates the internal ending port.



7. In the Internal IP Address field, enter the IP address of your local computer that will provide this service.
8. Click **Apply**. The service appears in the list in the Port Forwarding/Port Triggering screen.

## Edit or Delete a Port Forwarding Entry

### ➤ To edit or delete a port forwarding entry:

1. In the table, select the radio button next to the service name.
2. Click **Edit Service** or **Delete Service**.

### *Application Example: Making a Local Web Server Public*

If you host a web server on your local network, you can use port forwarding to allow web requests from anyone on the Internet to reach your web server.

### ➤ To make a local web server public:

1. Assign your web server either a fixed IP address or a dynamic IP address using DHCP address reservation. In this example, your router always gives your web server an IP address of 192.168.1.33.
2. In the Port Forwarding/Port Triggering screen, configure the router to forward the HTTP service to the local address of your web server at **192.168.1.33**. HTTP (port 80) is the standard protocol for web servers.
3. (Optional) Register a host name with a Dynamic DNS service, and configure your router to use the name as described in *Dynamic DNS* on page 115. To access your web server from the Internet, a remote user has to know the IP address that your ISP assigned. However, if you use a Dynamic DNS service, the remote user can reach your server by a user-friendly Internet name, such as mynetgear.dyndns.org.

## Set Up Port Triggering

Port triggering is a dynamic extension of port forwarding that is useful in these cases:

- More than one local computer needs port forwarding for the same application (but not simultaneously).
- An application needs to open incoming ports that are different from the outgoing port.

When port triggering is enabled, the router monitors outbound traffic looking for a specified outbound “trigger” port. When the router detects outbound traffic on that port, it remembers the IP address of the local computer that sent the data. The router then temporarily opens the specified incoming port or ports, and forwards incoming traffic on the triggered ports to the triggering computer.

Port forwarding creates a static mapping of a port number or range to a single local computer. Port triggering can dynamically open ports to any computer that needs them and can close the ports when they are no longer needed.

---

**Note:** If you use applications such as multiplayer gaming, peer-to-peer connections, real-time communications such as instant messaging, or remote assistance (a feature in Windows XP), you should also enable Universal Plug and Play (UPnP) according to the instructions in *Universal Plug and Play* on page 119.

---

To configure port triggering, you need to know which inbound ports the application needs, and the number of the outbound port that will trigger the opening of the inbound ports. Usually, you can determine this information by contacting the publisher of the application or the relevant user groups or news groups.

➤ **To set up port triggering:**

1. Select **Advanced > Advanced Setup > Port Forwarding/Port Triggering**.
2. Select the **Port Triggering** radio button to display the port triggering information.

Port Forwarding / Port Triggering

Cancel Apply

Please select the service type.

Port Forwarding

Port Triggering

Disable Port Triggering

Port Triggering Time-out:(in minutes) 20

#	Enable	Service Name	Service Type	Inbound Connection	Service User
+ Add Service Edit Service Delete Service					

3. Clear the **Disable Port Triggering** check box if it is selected.

**Note:** If the *Disable Port Triggering* check box is selected after you configure port triggering, port triggering is disabled. However, any port triggering configuration information you added to the router is retained even though it is not used.

4. In the Port Triggering Timeout field, enter a value up to 9999 minutes.

This value controls the inactivity timer for the designated inbound ports. The inbound ports close when the inactivity time expires. This is required because the router cannot be sure when the application has terminated.

- Click **Add Service** to display the following screen:

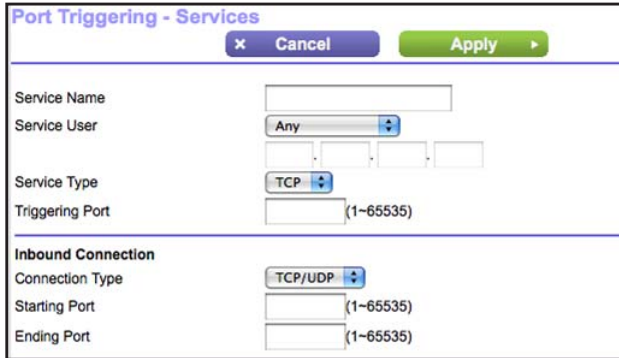

- In the Service Name field, type a descriptive service name.
- In the Service User list, select **Any** (the default) to allow this service to be used by any computer on the Internet. Otherwise, select **Single address**, and enter the IP address of one computer to restrict the service to a particular computer.
- Select the service type, either **TCP** or **UDP** or both (**TCP/UDP**). If you are not sure, select TCP/UDP.
- In the Triggering Port field, enter the number of the outbound traffic port that you want to cause the inbound ports to open.
- Enter the inbound connection port information in the Connection Type, Starting Port, and Ending Port fields.
- Click **Apply**. The service appears in the Port Triggering Portmap table.

## Dynamic DNS

If your Internet service provider (ISP) gave you a permanently assigned IP address, you can register a domain name and have that name linked with your IP address by public Domain Name Servers (DNS). However, if your Internet account uses a dynamically assigned IP address, you do not know in advance what your IP address will be, and the address can change frequently. In this case, you can use a commercial Dynamic DNS service. This type of service lets you register your domain to their IP address and forwards traffic directed at your domain to your frequently changing IP address.

If your ISP assigns a private WAN IP address (such as 192.168.x.x or 10.x.x.x), the Dynamic DNS service does not work because private addresses are not routed on the Internet.

Your router contains a client that can connect to the Dynamic DNS service provided by DynDNS.org. First visit their website at <http://www.dyndns.org> and obtain an account and host name that you configure in the router. Then, whenever your ISP-assigned IP address changes, your router contacts the Dynamic DNS service provider, logs in to your account, and registers your new IP address. If your host name is hostname, for example, you can reach your router at <http://hostname.dyndns.org>.

On the Advanced tab, select **Advanced Setup > Dynamic DNS** to display the following screen:

➤ **To set up Dynamic DNS:**

1. Register for an account with one of the Dynamic DNS service providers whose names appear in the Service Provider list.
2. Select the **Use a Dynamic DNS Service** check box.
3. Select the web address of your Dynamic DNS service provider.  
For example, for DynDNS.org, select `www.dyndns.org`.
4. Type the host name (or domain name) that your Dynamic DNS service provider gave you.
5. Type the user name for your Dynamic DNS account. This is the name that you use to log in to your account, not your host name.
6. Type the password (or key) for your Dynamic DNS account.
7. If your Dynamic DNS provider allows the use of wildcards in resolving your URL, you can select the **Use Wildcards** check box to activate this feature.  
For example, the wildcard feature causes `*.yourhost.dyndns.org` to be aliased to the same IP address as `yourhost.dyndns.org`.
8. Click **Apply** to save your configuration.

## Static Routes

Static routes provide additional routing information to your router. Typically, you do not need to add static routes. You have to configure static routes only for unusual cases such as multiple routers or multiple IP subnets on your network.

As an example of when a static route is needed, consider the following case:

- Your primary Internet access is through a cable modem to an ISP.
- You have an ISDN router on your home network for connecting to the company where you are employed. This router's address on your LAN is 192.168.1.100.
- Your company's network address is 134.177.0.0.

When you first configured your router, two implicit static routes were created. A default route was created with your ISP as the gateway, and a second static route was created to your local network for all 192.168.1.x addresses. With this configuration, if you attempt to access a device on the 134.177.0.0 network, your router forwards your request to the ISP. The ISP

forwards your request to the company where you are employed, and the request is likely to be denied by the company's firewall.

In this case you have to define a static route, telling your router that 134.177.0.0 should be accessed through the ISDN router at 192.168.1.100. In this example:

- The Destination IP Address and IP Subnet Mask fields specify that this static route applies to all 134.177.x.x addresses.
- The Gateway IP Address field specifies that all traffic for these addresses should be forwarded to the ISDN router at 192.168.1.100.
- A metric value of 1 works since the ISDN router is on the LAN.
- Private is selected only as a precautionary security measure in case RIP is activated.

➤ **To set up a static route:**

1. Select **Advanced > Advanced Setup > Static Routes**, and click **Add** to display the following screen:

2. In the Route Name field, type a name for this static route (for identification purposes only.)
3. Select the **Private** check box if you want to limit access to the LAN only. If Private is selected, the static route is not reported in RIP.
4. Select the **Active** check box to make this route effective.
5. Type the IP address of the final destination.
6. Type the IP subnet mask for this destination. If the destination is a single host, type **255.255.255.255**.
7. Type the gateway IP address, which has to be a router on the same LAN segment as the router.
8. Type a number from 1 through 15 as the metric value.  
This value represents the number of routers between your network and the destination. Usually, a setting of 2 or 3 works, but if this is a direct connection, set it to 1.
9. Click **Apply** to add the static route.

## Remote Management

The remote management feature lets you upgrade or check the status of your CENTRIA over the Internet.

➤ **To set up remote management:**

1. Select **Advanced > Advanced Setup > Remote Management**.

The screenshot shows the 'Remote Management' configuration interface. At the top, there are 'Cancel' and 'Apply' buttons. Below that is a checkbox labeled 'Turn Remote Management On' which is checked. The 'Remote Management Address' field contains 'https://10.1.151.8443'. Under the 'Allow Remote Access By:' section, three radio buttons are present: 'Only This Computer', 'IP Address Range', and 'Everyone'. The 'Everyone' radio button is selected. To the right of these radio buttons are input fields for 'From' and 'To' IP addresses, each with four sub-fields for octets. At the bottom, the 'Port Number' field contains the value '8443'.

**Note:** Be sure to change the router's default login password to a secure password. The ideal password contains no dictionary words from any language and contains uppercase and lowercase letters, numbers, and symbols. It can be up to 30 characters.

2. Select the **Turn Remote Management On** check box.
3. Under Allow Remote Access By, specify the external IP addresses to be allowed to access the router's remote management.

For enhanced security, restrict access to as few external IP addresses as practical.

- To allow access from a single IP address on the Internet, select **Only This Computer**. Enter the IP address that will be allowed access.
- To allow access from a range of IP addresses on the Internet, select **IP Address Range**. Enter a beginning and ending IP address to define the allowed range.
- To allow access from any IP address on the Internet, select **Everyone**.

4. Specify the port number for accessing the management interface.

Normal web browser access uses the standard HTTP service port 80. For greater security, enter a custom port number for the remote web management interface. Choose a number from 1024 to 65535, but do not use the number of any common service port. The default is 8080, which is a common alternate for HTTP.

5. Click **Apply** to have your changes take effect.
6. When accessing your router from the Internet, type your router's WAN IP address into your browser's address or location field followed by a colon (:) and the custom port number. For example, if your external address is 134.177.0.123 and you use port number 8080, enter **http://134.177.0.123:8080** in your browser.

## USB Settings

For added security, the router can be set up to share only approved USB devices. See *Specify Approved USB Devices* on page 60 for the procedure.

## Universal Plug and Play

Universal Plug and Play (UPnP) helps devices, such as Internet appliances and computers, access the network and connect to other devices as needed. UPnP devices can automatically discover the services from other registered UPnP devices on the network.

If you use applications such as multiplayer gaming, peer-to-peer connections, or real-time communications such as instant messaging or remote assistance (a feature in Windows XP), you should enable UPnP.

### ➤ To turn on Universal Plug and Play:

1. Select **Advanced > Advanced Setup > UPnP**. The UPnP screen displays.

Active	Protocol	Int. Port	Ext. Port	IP Address
YES	UDP	54362	54362	192.168.1.2
YES	TCP	54362	54362	192.168.1.2

2. The available settings and information in this screen are:

**Turn UPnP On.** UPnP can be enabled or disabled for automatic device configuration. The default setting for UPnP is disabled. If this check box is not selected, the router does not allow any device to automatically control the resources, such as port forwarding (mapping) of the router.

**Advertisement Period.** The advertisement period is how often the router broadcasts its UPnP information. This value can range from 1 to 1440 minutes. The default period is 30 minutes. Shorter durations ensure that control points have current device status at the expense of additional network traffic. Longer durations can compromise the freshness of the device status, but can significantly reduce network traffic.

**Advertisement Time to Live.** The time to live for the advertisement is measured in hops (steps) for each UPnP packet sent. The time to live hop count is the number of steps a broadcast packet is allowed to propagate for each UPnP advertisement before it disappears. The number of hops can range from 1 to 255. The default value for the advertisement time to live is 4 hops, which is fine for most home networks. If you notice that some devices are not being updated or reached correctly, then it might be necessary to increase this value.

**UPnP Portmap Table.** The UPnP Portmap Table displays the IP address of each UPnP device that is currently accessing the router and which ports (internal and external) that device has opened. The UPnP Portmap Table also displays what type of port is open and whether that port is still active for each IP address.

3. Click **Apply** to save your settings.

## IPv6

You can use this feature to set up an IPv6 Internet connection type if genie does not detect it automatically.

### ➤ To set up an IPv6 Internet connection type:

1. Select **Advanced > Advanced Setup > IPv6** to display the following screen:



2. Select the IPv6 connection type from the list. Your Internet service provider (ISP) can provide this information.
  - If your ISP did not provide details, you can select **IPv6 Tunnel**.
  - If you are not sure, select **Auto Detect** so that the router detects the IPv6 type that is in use.
  - If your Internet connection does not use PPPoE, DHCP, or fixed, but is IPv6, select **Auto Config**.
  - For more detailed information about Internet connection types, see the following sections.
3. Click **Apply** so that your changes take effect.



## Auto Detect Fields

In the IPv6 screen, when you select **Auto Detect** from the drop-down list, the following screen displays.

The screenshot shows the IPv6 configuration interface. At the top, there are three buttons: 'Status Refresh', 'Cancel', and 'Apply'. Below the buttons, the 'Internet Connection Type' is set to 'Auto Detect'. The 'Connection Type' is 'DHCP/Auto Config'. Under 'Router's IPv6 Address On WAN', it says 'Not Available'. The 'LAN Setup' section shows 'Router's IPv6 Address On LAN' as 'Not Available'. Under 'IP Address Assignment', 'Auto Config' is selected with a radio button. There is also an option for 'Use This Interface ID' with four input fields, all containing '0'. At the bottom, 'IPv6 Filtering' is set to 'Secured'.

The Connection Type field indicates the connection type detected. The following fields are also included in this screen:

### IPv6 LAN Setup

**Router's IPv6 Address on WAN.** The IPv6 address acquired for the router's WAN (or Internet) interface. The number after the slash (/) is the length of the prefix, which is also roughly indicated by the underline ('\_') under the IPv6 address.

**Router's IPv6 Address on LAN.** The IPv6 address acquired for the router's LAN interface. The number after the slash (/) is the length of the prefix, which is also roughly indicated by the underline ('\_') under the IPv6 address.

**IP Address Assignment.** You can select how you want to assign IPv6 address to the devices on your home network (the LAN). You can select either **DHCP Server** or **Auto Config** to assign an IPv6 address. Using DHCP Server might pass more information to LAN devices, but some IPv6 systems might not support the DHCv6 client function. Auto Config is selected by default.

**Use This Interface ID.** You can enable this option and specify the interface ID that you want for the IPv6 address for the router's LAN interface. If you do not specify an ID here, the router generates one automatically from its MAC address.

### IPv6 Filtering

When the connection type is not IPv6 Pass Through or Disabled, the router starts the SPI firewall function on the WAN interface. The router creates connection records and checks every inbound IPv6 packet. If the inbound packet is not destined to the router itself and the router does expect to receive such a packet, or the packet is not in the connection record, the

router blocks this packet. This function has two modes. The default is Secured mode, which checks both TCP and UDP packets. For Open mode, the checking is applied only to the UDP connection.

## Auto Config

In the IPv6 screen, when you select **Auto Config** from the drop-down list, the following screen displays.

The screenshot shows the IPv6 configuration interface. At the top, there are three buttons: 'Status Refresh', 'Cancel', and 'Apply'. Below these, the 'Internet Connection Type' is set to 'Auto Config'. There are two empty text input fields for 'DHCP User Class (if Required)' and 'DHCP Domain Name (if Required)'. The 'Router's IPv6 Address On WAN' is 'Not Available'. Under 'LAN Setup', the 'Router's IPv6 Address On LAN' is also 'Not Available'. For 'IP Address Assignment', the 'Auto Config' radio button is selected. There is a checkbox for 'Use This Interface ID' which is currently unchecked, with four adjacent numeric input fields. At the bottom, the 'IPv6 Filtering' section has 'Secured' selected and 'Open' unselected.

The following fields are included in this screen:

**DHCP User Class.** Most people do not need to fill in this field, but if your ISP has given you a specific host name, enter it here.

**DHCP Domain Name.** This is not needed for most connections. You can type the domain name of your ISP. For example, if your ISP's mail server is mail.xxx.yyy.zzz, you would type xxx.yyy.zzz as the domain name.

If your ISP provided you with a domain name, type it in this field. For example, Earthlink Cable might require a host name of *home* and Comcast sometimes supplies a domain name.

This is the domain name for the IPv6 connection. Do not enter the domain name for the IPv4 connection here.

The other settings are the same as Auto Detect mode. See [IPv6 LAN Setup](#) and [IPv6 Filtering](#) on page 121.

## 6to4 Tunnel

In the IPv6 screen, when you select **6to4 Tunnel** from the drop-down list, the following screen displays.

The screenshot shows the IPv6 configuration interface. At the top, there are three buttons: 'Status Refresh', 'Cancel', and 'Apply'. Below these, the 'Internet Connection Type' is set to '6to4 Tunnel'. Under 'Remote 6to4 Relay Router', the 'Auto' radio button is selected, and there are four empty input boxes for a static IP address. The 'LAN Setup' section shows 'Router's IPv6 Address On LAN' as 'Not Available'. Under 'IP Address Assignment', the 'Auto Config' radio button is selected. There is a checkbox for 'Use This Interface ID' which is currently unchecked, with four empty input boxes below it. At the bottom, the 'IPv6 Filtering' section has the 'Secured' radio button selected and the 'Open' radio button unselected.

The following fields are included in this screen:

**Remote 6to4 Relay Router.** The remote relay router to which your router creates the 6to4 tunnel. If your ISP provides the address of its own relay router, you can put it here. You can also leave it as Auto and the router uses any remote relay router that is available. The 6to4 tunnel connection needs the IPv4 Internet connection to be working first.

The other settings are the same as Auto Detect mode. See [IPv6 LAN Setup](#) and [IPv6 Filtering](#) on page 121

## Pass Through

In this mode, the router works as a layer 2 Ethernet switch with 2 ports (LAN and WAN Ethernet ports) for IPv6 packets. The router does not process any IPv6 header packets.

## Fixed

In the IPv6 screen, when you select **Fixed** from the drop-down list, the following screen displays.

The screenshot shows the IPv6 configuration interface. At the top, there are 'Cancel' and 'Apply' buttons. Below them, the 'Internet Connection Type' is set to 'Fixed'. The 'WAN Setup' section includes fields for 'IPv6 Address/Prefix Length', 'Default IPv6 Gateway', 'Primary DNS Server', and 'Secondary DNS Server'. The 'LAN Setup' section has radio buttons for 'Use DHCP Server' and 'Auto Config' (which is selected), and a field for 'IPv6 Address/Prefix Length'. At the bottom, there is an 'IPv6 Filtering' section with 'Secured' and 'Open' radio buttons.

The following fields are included in this screen:

### *IPv6 Fixed WAN Setup*

**IPv6 Address/Prefix Length.** The IPv6 address and prefix length of the router's WAN interface.

**Default IPv6 Gateway.** The IPv6 address of the default IPv6 gateway, which is supposed to be on the router's WAN interface.

**Primary/Secondary DNS Server.** The DNS servers that resolve IPv6 domain name records for you. If these fields are not specified, the router uses the DNS server configured for the IPv4 Internet connection on the Internet Settings screen. (See [Internet Setup](#) on page 27.)

**IP Address Assignment.** You can select how you want to assign IPv6 addresses to the devices on your home network (the LAN). You can use either DHCP Server or Auto Config to assign IPv6 address. Using DHCP Server might pass more information to LAN devices, but some IPv6 systems might not support the DHCv6 client function. Auto Config is used by default.

### *IPv6 Fixed LAN Setup*

**IPv6 Address/Prefix Length.** The IPv6 address and prefix length of the router's LAN interface.

## DHCP

In the IPv6 screen, when you select **DHCP** from the drop-down list, the following screen displays.

The screenshot shows the IPv6 configuration interface. At the top, there are three buttons: 'Status Refresh', 'Cancel', and 'Apply'. Below these, the 'Internet Connection Type' is set to 'DHCP'. The 'User Class (if Required)' field is empty. The 'Domain Name (if Required)' field is also empty. Under 'Router's IPv6 Address On WAN', it says 'Not Available'. The 'LAN Setup' section includes 'Router's IPv6 Address On LAN' (Not Available), 'IP Address Assignment' with radio buttons for 'Use DHCP Server' and 'Auto Config' (selected), and a checkbox for 'Use This Interface ID' which is unchecked. Below this, there are four input fields for the interface ID, each containing a '0'. At the bottom, 'IPv6 Filtering' is set to 'Secured'.

The following fields are included in this screen:

**User Class.** Most people do not need to fill in this field, but if your ISP has given you a specific host name, enter it here.

**Domain Name.** This is not needed for Internet connections. You can type the domain name of your ISP. For example, if your ISP's mail server is mail.xxx.yyy.zzz, you would type xxx.yyy.zzz as the domain name. If your ISP provided a domain name, type it in this field. (For example, Earthlink Cable might require a host name of *home* and Comcast sometimes supplies a domain name.)

This is the domain name for the IPv6 connection. Do not enter the domain name for the IPv4 connection here.

The other settings are the same as Auto Detect mode. See [IPv6 LAN Setup](#) and [IPv6 Filtering](#) on page 121.

## PPPoE

In the IPv6 screen, when you select **PPPoE** from the drop-down list, the following screen displays.

The screenshot shows the IPv6 configuration interface. At the top, there are buttons for 'Status Refresh', 'Cancel', and 'Apply'. The 'Internet Connection Type' is set to 'PPPoE'. Below this, there are input fields for 'Login', 'Password', and 'Service Name (If Required)'. The 'Connection Mode' is set to 'Always On'. Under 'Router's IPv6 Address On WAN', it says 'Not Available'. The 'LAN Setup' section shows 'Router's IPv6 Address On LAN' as 'Not Available'. For 'IP Address Assignment', the 'Auto Config' radio button is selected. There is a checkbox for 'Use This Interface ID' with four input boxes below it. At the bottom, 'IPv6 Filtering' is set to 'Secured'.

The following fields are included in this screen:

**Login.** This is usually the name that you use in your email address. For example, if your main mail account is JerAB@ISP.com, then you would put JerAB in this field.

Some ISPs (like Mindspring, Earthlink, and T-DSL) require that you use your full email address when you log in. If your ISP requires your full email address, type it in this field.

**Password.** Type the password that you use to log in to your ISP.

**Service Name.** If your ISP provided a service name, enter it here. Otherwise, you can leave this field blank.

**Connection Mode.** This specifies when the router should establish the PPPoE connection. Currently the connection mode is *always on* to provide a steady IPv6 connection. The router never disconnects the connection, and in case the connection is broken (such as if the modem is turned off), the router establishes the connection right after the PPPoE connection is available.

The other settings are the same as Auto Detect mode. See [IPv6 LAN Setup](#) and [IPv6 Filtering](#) on page 121.

## Traffic Meter

Traffic metering allows you to monitor the volume of Internet traffic passing through your router's Internet port. With the Traffic Meter utility, you can set limits for traffic volume, set a monthly limit, and get a live update of traffic usage.

➤ **To monitor Internet traffic:**

1. Click **Advanced > Advanced Setup > Traffic Meter** to display the following screen.

**Internet Traffic Meter**

Enable Traffic Meter

Traffic volume control by No limit

Monthly limit  (MBytes)

Round up data volume for each connection by  (MBytes)

Connection time control

Monthly limit  (hours)

---

**Traffic Counter**

Restart traffic counter at  :  am on the  day of each month

[Restart Counter Now](#)

---

**Traffic Control**

Pop up a warning message

MBytes/Minutes before the monthly limit is reached

When the monthly limit is reached

Turn the Internet LED green/amber flashing

Disconnect and disable the Internet connection

---

**Internet Traffic Statistics**

Start Date/Time: Wednesday, 1 Aug 2012 00:00 AM

Current Date/Time: Wednesday, 31 Dec 1999 04:00 PM

Traffic Volume Left: 0 Bytes

Period	Connection Time (hh:mm)	Traffic Volume (Mbytes)		
		Upload/Avg	Download/Avg	Total/Avg
Today	0:0	0.00	0.00	0.00
Yesterday	0:0	0.00	0.00	0.00

[Help Center](#) Show/Hide Help Center

← Scroll to view more settings

2. To enable the traffic meter, select the **Enable Traffic Meter** check box.
3. If you would like to record and restrict the volume of Internet traffic, select the **Traffic volume control by** radio button. You can select one of the following options for controlling the traffic volume:
  - No Limit.** No restriction is applied when the traffic limit is reached.
  - Download only.** The restriction is applied to incoming traffic only.
  - Both Directions.** The restriction is applied to both incoming and outgoing traffic.
4. You can limit the amount of data traffic allowed per month by specifying how many Mbytes per month are allowed or by specifying how many hours of traffic are allowed.
5. Set the Traffic Counter to begin at a specific time and date.
6. Set up Traffic Control to issue a warning message before the monthly limit of Mbytes or hours is reached. You can select one of the following to occur when the limit is attained:
  - The Internet LED flashes green or amber.
  - The Internet connection is disconnected and disabled.
7. Set up Internet Traffic Statistics to monitor the data traffic.
8. Click the **Traffic Status** button for an update on Internet traffic status on your router.
9. Click **Apply** to save your settings.

This chapter provides information to help you diagnose and solve problems you might have with your router. If you do not find the solution here, check the NETGEAR support site at <http://support.netgear.com> for product and contact information.

This chapter contains the following sections:

- *Quick Tips*
- *Troubleshooting with the LEDs*
- *Cannot Log In to CENTRIA*
- *Cannot Access the Internet*
- *Changes Not Saved*
- *Wireless Connectivity*
- *Restore the Factory Settings and Password*
- *Troubleshoot Your Network Using the Ping Utility*



## Quick Tips

This section describes tips for troubleshooting some common problems.

### Sequence to Restart Your Network

Be sure to restart your network in this sequence:

1. Turn off and unplug the modem.
2. Turn off the router and computers.
3. Plug in the modem and turn it on. Wait 2 minutes.
4. Turn on the router and wait 2 minutes.
5. Turn on the computers.

### Check Ethernet Cable Connections

Make sure that the Ethernet cables are securely plugged in:

- The Internet LED on the router is on if the Ethernet cable connecting the router and the modem is plugged in securely and the modem and router are turned on.
- For each powered-on computer connected to the router by an Ethernet cable, the corresponding numbered router LAN port LED is on.

### Hard Disk Drive (HDD)

If you turn off the router when an HDD is installed, wait 2 seconds before turning it back on to give the HDD enough time to reset.

If the HDD LED is red and it used to be green, the HDD connection could be loose. Turn off the router. Disconnect the HDD, and then connect it again. Turn on the router and check the HDD LED.

### Wireless Settings

Make sure that the wireless settings in the computer and router match exactly.

- For a wirelessly connected computer, the wireless network name (SSID) and wireless security settings of the router and wireless computer need to match exactly.
- If you set up an access list in the Advanced Wireless Settings screen, you have to add each wireless computer's MAC address to the router's access list.

## Network Settings

Make sure that the network settings of the computer are correct:

- Wired and wirelessly connected computers need to have network (IP) addresses on the same network as the router. The simplest way to do this is to configure each computer to obtain an IP address automatically using DHCP.
- Some cable modem service providers require you to use the MAC address of the computer initially registered on the account. You can view the MAC address in the Attached Devices screen.

## Troubleshooting with the LEDs

After you turn on power to the router, the following sequence of events should occur:

1. When power is first applied, verify that the Power LED  is on.
2. Verify that the Power LED turns amber within a few seconds, indicating that the self-test is running.
3. After 2 minutes, verify the following:
  - The Power LED lights solid green.
  - The Internet LED lights.
  - The Wireless LED lights blue.

The LEDs on the front panel of the router can be used for troubleshooting.

### Power LED Is Off or Blinking

- Make sure that the power cord is securely connected to your router and that the power adapter is securely connected to a functioning power outlet.
- Check that you are using the 12V DC, 5A power adapter that NETGEAR supplied for this product.
- If the Power LED blinks slowly and continuously, the router firmware is corrupted. This can happen if a firmware upgrade is interrupted, or if the router detects a problem with the firmware. If the error persists, you have a hardware problem. For recovery instructions, or help with a hardware problem, contact technical support at [www.netgear.com/support](http://www.netgear.com/support).

## Power LED Stays Amber

When the router is turned on, the Power LED turns amber for about 20 seconds and then turns green. If the LED does not turn green, the router has a problem.

If the Power LED is still amber 1 minute after you turn on power to the router:

1. Turn off the power and then turn it back on to see if the router recovers.
2. Press and hold the **Reset** button to return the router to its factory settings. as explained in *Restore the Factory Settings and Password* on page 136.

If the error persists, you might have a hardware problem and should contact technical support at [www.netgear.com/support](http://www.netgear.com/support).

## HDD LED Is Red or Red and Green

- If the HDD LED is solid green plus red, the internal hard disk drive (HDD) is 85% full.
- If the HDD LED is blinking green and red, the HDD is 95% full.
- If the HDD LED is solid red, the HDD is not formatted, the HDD connection is loose, or there is a failure alert.

## LEDs Never Turn Off

When the router is turned on, the LEDs turn on for about 10 seconds and then turn off. If all the LEDs stay on, there is a fault within the router.

If all LEDs are still on 1 minute after power-up:

- Cycle the power to see if the router recovers.
- Press and hold the **Reset** button to return the router to its factory settings as explained in *Restore the Factory Settings and Password* on page 136.

If the error persists, you might have a hardware problem and should contact technical support at [www.netgear.com/support](http://www.netgear.com/support).

## Internet LED Is Off

If the Internet LED does not light, check the following:

- Make sure that the Ethernet cable connections are secure at the router and at the modem or computer.
- Make sure that power is turned on to the connected modem or computer.
- Be sure that you are using the correct cable.

When connecting the router's Internet port to a cable or DSL modem, use the cable that was supplied with the cable or DSL modem. This cable could be a standard straight-through Ethernet cable or an Ethernet crossover cable.

## Wireless LED Is Off

If the Wireless LED stays off, check to see if the Wi-Fi On/Off button on the router has been pressed. This button turns the wireless radios in the router on and off. The Wireless LEDs are lit when the wireless radio is turned on.

## Cannot Log In to CENTRIA

If you are unable to log in to CENTRIA from a computer on your local network, check the following:

- If you are using an Ethernet-connected computer, check the Ethernet connection between the computer and the router as described in the previous section.
- Make sure that your computer's IP address is on the same subnet as the router. If you are using the recommended addressing scheme, your computer's address should be in the range of 192.168.1.2 to 192.168.1.254.
- If your computer's IP address is shown as 169.254.x.x, recent versions of Windows and Mac OS generate and assign an IP address if the computer cannot reach a DHCP server. These autogenerated addresses are in the range of 169.254.x.x. If your IP address is in this range, check the connection from the computer to the router, and reboot your computer.
- If your router's IP address was changed and you do not know the current IP address, clear the router's configuration to factory defaults. This sets the router's IP address to 192.168.1.1. This procedure is explained in *Factory Settings* on page 139.
- Make sure that your browser has Java, JavaScript, or ActiveX enabled. If you are using Internet Explorer, click **Refresh** to be sure that the Java applet is loaded.
- Try quitting the browser and launching it again.
- Make sure that you are using the correct login information. The factory default login name is admin and the password is password. Make sure that Caps Lock is off when you enter this information.
- If you are attempting to set up your NETGEAR router as a replacement for an ADSL gateway in your network, the router cannot perform many gateway services. For example, the router cannot convert ADSL or cable data into Ethernet networking information. NETGEAR does not support such a configuration.

## Cannot Access the Internet

If you can access CENTRIA but not the Internet, check to see if the router can obtain an IP address from your Internet service provider (ISP). Unless your ISP provides a fixed IP address, your router requests an IP address from the ISP. You can determine whether the request was successful using the Router Status screen.

➤ **To check the WAN IP address:**

1. Start your browser, and select an external site such as [www.netgear.com](http://www.netgear.com).
2. Access the router interface at **www.routerlogin.net**.
3. Select **Administration > Router Status**.
4. Check that an IP address is shown for the Internet port. If 0.0.0.0 is shown, your router has not obtained an IP address from your ISP.

If your router cannot obtain an IP address from the ISP, you might need to force your cable or DSL modem to recognize your new router by restarting your network, as described in [Sequence to Restart Your Network](#) on page 129.

If your router is still unable to obtain an IP address from the ISP, the problem might be one of the following:

- Your Internet service provider (ISP) might require a login program.  
Ask your ISP whether it requires PPP over Ethernet (PPPoE) or some other type of login.
- If your ISP requires a login, the login name and password might be set incorrectly.
- Your ISP might check for your computer's host name.  
Assign the computer host name of your ISP account as the account name in the Internet Setup screen.
- Your ISP allows only one Ethernet MAC address to connect to Internet and might check for your computer's MAC address. In this case, do one of the following:
  - Inform your ISP that you have bought a new network device, and ask them to use the router's MAC address.
  - Configure your router to clone your computer's MAC address.

If your router can obtain an IP address, but your computer is unable to load any web pages from the Internet:

- Your computer might not recognize any DNS server addresses.

A DNS server is a host on the Internet that translates Internet names (such as www addresses) to numeric IP addresses. Typically, your ISP provides the addresses of one or two DNS servers for your use. If you entered a DNS address during the router's configuration, reboot your computer, and verify the DNS address. You can configure your computer manually with DNS addresses, as explained in your operating system documentation.

- Your computer might not have the router configured as its TCP/IP gateway.

If your computer obtains its information from the router by DHCP, reboot the computer, and verify the gateway address.

- You might be running login software that is no longer needed.

If your ISP provided a program to log you in to the Internet (such as WinPoET), you no longer need to run that software after installing your router. You might need to go to Internet Explorer and select **Tools > Internet Options**, click the **Connections** tab, and select **Never dial a connection**.

## Troubleshoot PPPoE

If you are using PPPoE, try troubleshooting your Internet connection.

➤ **To troubleshoot a PPPoE connection:**

1. Log in to the router.
2. Select **Administration > Router Status**.
3. Click **Connection Status**. If all of the steps indicate OK, then your PPPoE connection is up and working.

If any of the steps indicate Failed, you can attempt to reconnect by clicking **Connect**. The router continues to attempt to connect indefinitely.

If you cannot connect after several minutes, you might be using an incorrect service name, user name, or password. There might be a provisioning problem with your ISP.

---

**Note:** Unless you connect manually, the router does not authenticate using PPPoE until data is transmitted to the network.

---

## Troubleshooting Internet Browsing

If your router can obtain an IP address but your computer is unable to load any web pages from the Internet, check the following:

- Your computer might not recognize any DNS server addresses. A DNS server is a host on the Internet that translates Internet names (such as www addresses) to numeric IP addresses.

Typically, your ISP provides the addresses of one or two DNS servers for your use. If you entered a DNS address during the router's configuration, restart your computer.

Alternatively, you can configure your computer manually with a DNS address, as explained in the documentation for your computer.

- Your computer might not have the router configured as its default gateway.

Reboot the computer and verify that the router address (www.routerlogin.net) is listed by your computer as the default gateway address.

- You might be running log in software that is no longer needed. If your ISP provided a program to log you in to the Internet (such as WinPoET), you no longer need to run that software after installing your router. You might need to go to Internet Explorer and select **Tools > Internet Options**, click the **Connections** tab, and select **Never dial a connection**.

## Changes Not Saved

If the router does not save the changes you make in the router interface, check the following:

- When entering configuration settings, always click the **Apply** button before moving to another screen or tab, or your changes are lost.
- Click the **Refresh** or **Reload** button in the web browser. The changes might have occurred, but the old settings might be in the web browser's cache.

## Wireless Connectivity

If you are having trouble connecting wirelessly to the router, try to isolate the problem.

- Does the wireless device or computer that you are using find your wireless network?

If not, check the Wireless LEDs on the front of the router. It should be lit. If it is not, you can press the **WiFi On/Off** button on the back of the router to turn the router's wireless radio back on.

If you disabled the router's SSID broadcast, then your wireless network is hidden and does not show up in your wireless client's scanning list. By default, SSID broadcast is enabled.

- Does your wireless device support the security that you are using for your wireless network (WPA or WPA2)?
- If you want to view the wireless settings for the router, use an Ethernet cable to connect a computer to a LAN port on the router. Then log in to the router, and select **Wireless** (see *Basic Wireless Settings* on page 33).

**Note:** Be sure to click **Apply** to save your changes.

## Wireless Signal Strength

If your wireless device finds your network, but the signal strength is weak, check these conditions:

- Is your router too far from your computer, or too close? Place your computer near the router, but at least 6 feet (1.8 meters) away, and see whether the signal strength improves.
- Is your wireless signal blocked by objects between the router and your computer?

## Restore the Factory Settings and Password

This section explains how to restore the factory settings, changing the router's administration password back to **password**. You can erase the current configuration and restore factory defaults in two ways:

- Use the Erase function of the router (see *Erase* on page 97).
- Use the Reset button on the back of the router. See *Factory Settings* on page 139. If you restore the factory settings and the router fails to restart, or the green Power LED continues to blink, the unit might be defective. If the error persists, you might have a hardware problem and should contact technical support at <http://www.netgear.com/support>.

## Troubleshoot Your Network Using the Ping Utility

Most network devices and routers contain a ping utility that sends an echo request packet to the designated device. The device then responds with an echo reply. You can easily troubleshoot a network by using the ping utility in your computer or workstation.

### Test the LAN Path to CENTRIA

You can ping the router from your computer to verify that the LAN path to your router is set up correctly.

➤ **To ping the router from a running Windows computer:**

1. From the Windows toolbar, click **Start**, and then select **Run**.
2. In the field provided, type **ping** followed by the IP address of the router, as in this example:  
**ping www.routerlogin.net**
3. Click **OK**.

You should see a message like this one:

```
Pinging <IP address > with 32 bytes of data
```

If the path is working, you see this message:

```
Reply from < IP address >: bytes=32 time=NN ms TTL=xxx
```

If the path is not working, you see this message:

```
Request timed out
```

If the path is not functioning correctly, you could have one of the following problems:

- Wrong physical connections

For a wired connection, make sure that the numbered LAN port LED is on for the port to which you are connected.



Check that the appropriate LEDs are on for your network devices. If your router and computer are connected to a separate Ethernet switch, make sure that the link LEDs are on for the switch ports that are connected to your computer and router.

- Wrong network configuration

Verify that the Ethernet card driver software and TCP/IP software are both installed and configured on your computer.

Verify that the IP address for your router and your computer are correct and that the addresses are on the same subnet.

## Test the Path from Your Computer to a Remote Device

After verifying that the LAN path works correctly, test the path from your computer to a remote device.

1. From the Windows toolbar, click the **Start** button, and then select **Run**.
2. In the Windows Run window, type:

```
ping -n 10 <IP address>
```

where <IP address> is the IP address of a remote device such as your ISP DNS server.

If the path is functioning correctly, replies like those shown in the previous section are displayed.

If you do not receive replies:

- Check that your computer has the IP address of your router listed as the default gateway. If the IP configuration of your computer is assigned by DHCP, this information is not visible in your computer's Network Control Panel. Verify that the IP address of the router is listed as the default gateway.
- Check to see that the network address of your computer (the portion of the IP address specified by the subnet mask) is different from the network address of the remote device.
- Check that your cable or DSL modem is connected and functioning.
- If your ISP assigned a host name to your computer, enter that host name as the account name in the Internet Setup screen.
- Your ISP could be rejecting the Ethernet MAC addresses of all but one of your computers.

Many broadband ISPs restrict access by allowing traffic only from the MAC address of your broadband modem. Some ISPs additionally restrict access to the MAC address of a single computer connected to that modem. If this is the case, configure your router to "clone" or "spoof" the MAC address from the authorized computer.

# A Supplemental Information

---



This appendix provides factory default settings and technical specifications for the CENTRIA WNDR4700/WNDR4720.

This appendix includes the following sections:

- *Factory Settings*
- *Technical Specifications*

## Factory Settings

You can return the router to its factory settings. Use the end of a paper clip or a similar object to press and hold the **Reset** button on the back of the router for at least 7 seconds. The router resets, and returns to the factory configuration settings shown in the following table.

**Table 4. Factory default settings**

Feature		Default behavior
Router login	User login URL	www.routerlogin.com or www.routerlogin.net
	User name (case-sensitive)	admin
	Login password (case-sensitive)	password
Internet connection	WAN MAC address	Use default hardware address
	WAN MTU size	1500
	Port speed	AutoSensing
Local network (LAN)	LAN IP address	192.168.1.1
	Subnet mask	255.255.255.0
	DHCP server	Enabled
	DHCP range	192.168.1.2 to 192.168.1.254
	Time zone	Pacific time
	Time zone daylight savings time	Disabled
	Allow a registrar to configure this router	Enabled
Local network (LAN) continued	DHCP starting IP address	192.168.1.2
	DHCP ending IP address	192.168.1.254
	DMZ	Disabled
	Time zone	GMT for WW except NA and GR, GMT+1 for GR, GMT-8 for NA
	Time zone adjusted for daylight savings time	Disabled
	SNMP	Disabled
Firewall	Inbound (communications coming in from the Internet)	Disabled (except traffic on port 80, the HTTP port)
	Outbound (communications going out to the Internet)	Enabled (all)
	Source MAC filtering	Disabled

**Table 4. Factory default settings (Continued)**

Feature		Default behavior
Wireless	Wireless communication	Enabled
	SSID name	See router label
	Security	WPA2-PSK (AES)
	Broadcast SSID	Enabled
	Transmission speed	Auto*
	Country/region	United States in the US, otherwise varies by region
	RF channel	6 until region selected
Firewall	Operating mode	2.4 GHz b/g/n: Up to 195 Mbps 5 GHz a/n: Up to 450 Mbps
	Inbound (communications coming in from the Internet)	Disabled (bars all unsolicited requests)
	Outbound (communications going out to the Internet)	Enabled (all)

\*. Maximum Wireless signal rate derived from IEEE Standard 802.11 specifications. Actual throughput can vary. Network conditions and environmental factors, including volume of network traffic, building materials and construction, and network overhead, lower actual data throughput rate.

## Technical Specifications

**Table 5. WNDR4700/WNDR4720 Router specifications**

Feature	Description
Data and routing protocols	TCP/IP, RIP-1, RIP-2, DHCP, PPPoE, PPTP, Bigpond, Dynamic DNS, UPnP, and SMB
Power adapter	<ul style="list-style-type: none"> <li>• North America: 120V, 60 Hz, input</li> <li>• UK, Australia: 240V, 50 Hz, input</li> <li>• Europe: 230V, 50 Hz, input</li> <li>• All regions (output): 12V DC @ 5A, output</li> </ul>
Dimensions	256 x 206 x 85 mm (10.07 x 8.11 x 3.34 in)
Weight	0.87 kg (1.91 lbs)
Operating temperature	0° to 40° C (32° to 104° F)
Operating humidity	90% maximum relative humidity, noncondensing
Electromagnetic Emissions	FCC Part 15 Class B VCCI Class B EN 55 022 (CISPR 22), Class B C-Tick N10947

**Table 5. WNDR4700/WNDR4720 Router specifications (Continued)**

Feature	Description
LAN	10BASE-T or 100BASE-Tx or 1000BASE-T, RJ-45
WAN	10BASE-T or 100BASE-Tx or 1000BASE-T, RJ-45
Wireless	Maximum wireless signal rate complies with the IEEE 802.11 standard. See the footnote for the previous table.
Radio data rates	Auto Rate Sensing
Data encoding standards	IEEE 802.11n version 2.0 IEEE 802.11n, IEEE 802.11g, IEEE 802.11b 2.4 GHz IEEE 802.11n, IEEE 802.11a 5.0 GHz
Maximum computers per wireless network	Limited by the amount of wireless network traffic generated by each node (typically 50–70 nodes).
Operating frequency range	2.4 GHz 2.412–2.462 GHz (US) 2.412–2.472 GHz (Japan) 2.412–2.472 GHz (Europe ETSI) 5 GHz 5.18–5.24 + 5.745–5.825 GHz (US) 5.18–5.24 GHz (Europe ETSI)
802.11 security	40-bit (also called 64-bit) and 128-bit WEP, WPA-PSK, WPA2-PSK, and WPA/WPA2 Enterprise.

# Notification of Compliance



## NETGEAR Dual Band - Wireless

### Regulatory Compliance Information

This section includes user requirements for operating this product in accordance with National laws for usage of radio spectrum and operation of radio devices. Failure of the end-user to comply with the applicable requirements may result in unlawful operation and adverse action against the end-user by the applicable National regulatory authority.

Note: Note: This product's firmware limits operation to only the channels allowed in a particular Region or Country. Therefore, all options described in this user's guide may not be available in your version of the product.

### Europe - EU Declaration of Conformity



Marking by the above symbol indicates compliance with the Essential Requirements of the R&TTE Directive of the European Union (1999/5/EC). This equipment meets the following conformance standards:

EN300 328 (2.4Ghz), EN301 489-17, EN301 893 (5Ghz), EN60950-1

For complete DoC please visit the NETGEAR EU Declarations of Conformity website at:  
[http://support.netgear.com/app/answers/detail/a\\_id/11621/](http://support.netgear.com/app/answers/detail/a_id/11621/)

### EDOC in Languages of the European Community

Language	Statement
Cesky [Czech]	<i>NETGEAR Inc.</i> tímto prohlašuje, že tento Radiolan je ve shode se základními požadavky a dalšími příslušnými ustanoveními směrnice 1999/5/ES.
Dansk [Danish]	Undertegnede <i>NETGEAR Inc.</i> erklærer herved, at følgende udstyr Radiolan overholder de væsentlige krav og øvrige relevante krav i direktiv 1999/5/EF.
Deutsch [German]	Hiermit erkläre <i>NETGEAR Inc.</i> , dass sich das Gerät Radiolan in Übereinstimmung mit den grundlegenden Anforderungen und den übrigen einschlägigen Bestimmungen der Richtlinie 1999/5/EG befindet.
Eesti [Estonian]	Käesolevaga kinnitab <i>NETGEAR Inc.</i> seadme Radiolan vastavust direktiivi 1999/5/EÜ põhinõuetele ja nimetatud direktiivist tulenevatele teistele asjakohastele sätetele.
English	Hereby, <i>NETGEAR Inc.</i> , declares that this Radiolan is in compliance with the essential requirements and other relevant provisions of Directive 1999/5/EC.

**CENTRIA WNDR4700/WNDR4720**

<p>Español [Spanish]</p>	<p>Por medio de la presente <i>NETGEAR Inc.</i> declara que el Radiolan cumple con los requisitos esenciales y cualesquiera otras disposiciones aplicables o exigibles de la Directiva 1999/5/CE.</p>
<p>Ελληνική [Greek]</p>	<p>ΜΕ ΤΗΝ ΠΑΡΟΥΣΑ <i>NETGEAR Inc.</i> ΔΗΛΩΝΕΙ ΟΤΙ Radiolan ΣΥΜΜΟΡΦΩΝΕΤΑΙ ΠΡΟΣ ΤΙΣ ΟΥΣΙΩΔΕΙΣ ΑΠΑΙΤΗΣΕΙΣ ΚΑΙ ΤΙΣ ΛΟΙΠΕΣ ΣΧΕΤΙΚΕΣ ΔΙΑΤΑΞΕΙΣ ΤΗΣ ΟΔΗΓΙΑΣ 1999/5/ΕΚ.</p>
<p>Français [French]</p>	<p>Par la présente <i>NETGEAR Inc.</i> déclare que l'appareil Radiolan est conforme aux exigences essentielles et aux autres dispositions pertinentes de la directive 1999/5/CE.</p>
<p>Italiano [Italian]</p>	<p>Con la presente <i>NETGEAR Inc.</i> dichiara che questo Radiolan è conforme ai requisiti essenziali ed alle altre disposizioni pertinenti stabilite dalla direttiva 1999/5/CE.</p>
<p>Latviski [Latvian]</p>	<p>Ar šo <i>NETGEAR Inc.</i> deklarē, ka Radiolan atbilst Direktīvas 1999/5/EK būtiskajām prasībām un citiem ar to saistītajiem noteikumiem.</p>
<p>Lietuvių [Lithuanian]</p>	<p>Šiuo <i>NETGEAR Inc.</i> deklaruoja, kad šis Radiolan atitinka esminius reikalavimus ir kitas 1999/5/EB Direktyvos nuostatas.</p>
<p>Nederlands [Dutch]</p>	<p>Hierbij verklaart <i>NETGEAR Inc.</i> dat het toestel Radiolan in overeenstemming is met de essentiële eisen en de andere relevante bepalingen van richtlijn 1999/5/EG.</p>
<p>Malti [Maltese]</p>	<p>Hawnhekk, <i>NETGEAR Inc.</i>, jiddikjara li dan Radiolan jikkonforma mal-htigijiet essenzjali u ma provvedimenti oħrajn rilevanti li hemm fid-Dirrettiva 1999/5/EC.</p>
<p>Magyar [Hungarian]</p>	<p>Alulírott, <i>NETGEAR Inc.</i> nyilatkozom, hogy a Radiolan megfelel a vonatkozó alapvető követelményeknek és az 1999/5/EC irányelv egyéb előírásainak.</p>
<p>Polski [Polish]</p>	<p>Niniejszym <i>NETGEAR Inc.</i> oświadcza, że Radiolan jest zgodny z zasadniczymi wymogami oraz pozostałymi stosownymi postanowieniami Dyrektywy 1999/5/EC.</p>
<p>Português [Portuguese]</p>	<p><i>NETGEAR Inc.</i> declara que este Radiolan está conforme com os requisitos essenciais e outras disposições da Directiva 1999/5/CE.</p>
<p>Slovensko [Slovenian]</p>	<p><i>NETGEAR Inc.</i> izjavlja, da je ta Radiolan v skladu z bistvenimi zahtevami in ostalimi relevantnimi določili direktive 1999/5/ES.</p>
<p>Slovensky [Slovak]</p>	<p><i>NETGEAR Inc.</i> týmto vyhlasuje, že Radiolan spĺňa základné požiadavky a všetky príslušné ustanovenia Smernice 1999/5/ES.</p>
<p>Suomi [Finnish]</p>	<p><i>NETGEAR Inc.</i> vakuuttaa täten että Radiolan tyyppinen laite on direktiivin 1999/5/EY oleellisten vaatimusten ja sitä koskevien direktiivin muiden ehtojen mukainen.</p>
<p>Svenska [Swedish]</p>	<p>Härmed intygar <i>NETGEAR Inc.</i> att denna Radiolan står i överensstämmelse med de väsentliga egenskapskrav och övriga relevanta bestämmelser som framgår av direktiv 1999/5/EG.</p>

## CENTRIA WNDR4700/WNDR4720

Íslenska [Icelandic]	Hér með lýsir <i>NETGEAR Inc.</i> yfir því að Radiolan er í samræmi við grunnkröfur og aðrar kröfur, sem gerðar eru í tilskipun 1999/5/EC.
Norsk [Norwegian]	<i>NETGEAR Inc.</i> erklærer herved at utstyret <i>Radiolan</i> er i samsvar med de grunnleggende krav og øvrige relevante krav i direktiv 1999/5/EF.

This device is a 2.4 GHz and 5 GHz wideband transmission system (transceiver), intended for use in all EU member states and EFTA states, and Switzerland.

In Italy the end-user should apply for a license at the national spectrum authorities in order to obtain authorization to use the device for setting up outdoor radio links and/or for supplying public access to telecommunications and/or network services.

This device may not be used for setting up outdoor radio links in France and in some areas the RF output power may be limited to 10 mW EIRP in the frequency range of 2454 - 2483.5 MHz. For detailed information the end-user should contact the national spectrum authority in France.

### FCC Requirements for Operation in the United States

For operation within 5.15 ~ 5.25GHz, the CENTRIA WNDR4700/WNDR4720 is restricted to indoor environment.

#### FCC Information to User

This product does not contain any user serviceable components and is to be used with approved antennas only. Any product changes or modifications will invalidate all applicable regulatory certifications and approvals.

#### FCC Guidelines for Human Exposure

This equipment complies with FCC radiation exposure limits set forth for an uncontrolled environment. This equipment should be installed and operated with minimum distance of 22 cm between the radiator and your body.

This transmitter must not be co-located or operating in conjunction with any other antenna or transmitter.

#### FCC Declaration of Conformity

We, NETGEAR, Inc., 350 East Plumeria Drive, San Jose, CA 95134, declare under our sole responsibility that the CENTRIA WNDR4700/WNDR4720 complies with Part 15 Subpart B of FCC CFR47 Rules. Operation is subject to the following two conditions:

- This device may not cause harmful interference, and
- This device must accept any interference received, including interference that may cause undesired operation.

#### Federal Communication Commission Interference Statement

This device complies with Part 15 of the FCC Rules. Operation is subject to the following two conditions: (1) This device may not cause harmful interference, and (2) this device must accept any interference received, including interference that may cause undesired operation.

This equipment has been tested and found to comply with the limits for a Class B digital device, pursuant to Part 15 of the FCC Rules. These limits are designed to provide reasonable protection against harmful interference in a residential installation. This equipment generates, uses and can radiate radio frequency energy and, if not installed and used in accordance with the instructions, may cause harmful interference to radio communications. However, there is no guarantee that interference will not occur in a particular installation. If this equipment does cause harmful interference to radio or television reception, which can be determined by turning the equipment off and on, the user is encouraged to try to correct the interference by one of the following measures:

- Reorient or relocate the receiving antenna.
- Increase the separation between the equipment and receiver.
- Connect the equipment into an outlet on a circuit different from that to which the receiver is connected.
- Consult the dealer or an experienced radio/TV technician for help.

#### FCC Caution:

Any changes or modifications not expressly approved by the party responsible for compliance could void the user's authority to operate this equipment.



This transmitter must not be co-located or operating in conjunction with any other antenna or transmitter.

For operation within 5.15 ~ 5.25GHz / 5.47 ~5.725GHz frequency range, it is restricted to indoor environment. The band from 5600-5650MHz will be disabled by the software during the manufacturing and cannot be changed by the end user. This device meets all the other requirements specified in Part 15E, Section 15.407 of the FCC Rules.

FOR MOBILE DEVICE USAGE (>22cm/low power)

**Radiation Exposure Statement:**

This equipment complies with FCC radiation exposure limits set forth for an uncontrolled environment. This equipment should be installed and operated with minimum distance 22cm between the radiator & your body.

**Canadian Department of Communications Radio Interference Regulations**

This digital apparatus (CENTRIA WNDR4700/WNDR4720) does not exceed the Class B limits for radio-noise emissions from digital apparatus as set out in the Radio Interference Regulations of the Canadian Department of Communications.

This Class [B] digital apparatus complies with Canadian ICES-003.

Cet appareil numérique de la classe [B] est conforme à la norme NMB-003 du Canada

**Industry Canada**

This device complies with RSS-210 of the Industry Canada Rules. Operation is subject to the following two conditions: (1) This device may not cause harmful interference, and (2) this device must accept any interference received, including interference that may cause undesired operation.

interference that may cause undesired operation.

Ce dispositif est conforme à la norme CNR-210 d'Industrie Canada applicable aux appareils radio exempts de licence. Son fonctionnement est sujet aux deux conditions suivantes: (1) le dispositif ne doit pas produire de brouillage préjudiciable, et (2) ce dispositif doit accepter tout brouillage reçu, y compris un brouillage susceptible de provoquer un fonctionnement indésirable.

**IMPORTANT NOTE: Radiation Exposure Statement:**

This equipment complies with IC radiation exposure limits set forth for an uncontrolled environment. This equipment should be installed and operated with minimum distance 22 cm between the radiator & your body.

**Caution:**

The device for the band 5150-5250 MHz is only for indoor usage to reduce po-tential for harmful interference to co-channel mobile satellite systems.

High power radars are allocated as primary users (meaning they have priority) of 5250-5350 MHz and 5650-5850 MHz and these radars could cause interference and/or damage to LE-LAN devices.

Ce dispositif est conforme à la norme CNR-210 d'Industrie Canada applicable aux appareils radio exempts de licence. Son fonctionnement est sujet aux deux conditions suivantes: (1) le dispositif ne doit pas produire de brouillage préjudiciable, et (2) ce dispositif doit accepter tout brouillage reçu, y compris un brouillage susceptible de provoquer un fonctionnement indésirable.

**NOTE IMPORTANTE: Déclaration d'exposition aux radiations:**

Cet équipement est conforme aux limites d'exposition aux rayonnements IC établies pour un environnement non contrôlé. Cet équipement doit être installé et utilisé avec un minimum de 22 cm de distance entre la source de rayonnement et votre corps.

**Avertissement:**

Le dispositif fonctionnant dans la bande 5150-5250 MHz est réservé uniquement pour une utili-sation à l'intérieur afin de réduire les risques de brouillage préjudiciable aux systèmes de satellites mobiles utilisant les mêmes canaux.

Les utilisateurs de radars de haute puissance sont désignés utilisateurs principaux (c.-à-d., qu'ils ont la priorité) pour les bandes 5250-5350 MHz et 5650-5850 MHz et que ces radars pourraient causer du brouillage et/ou des dommages aux dispositifs LAN-EL.

### Interference Reduction Table

The table below shows the Recommended Minimum Distance between NETGEAR equipment and household appliances to reduce interference (in feet and meters).

Household Appliance	Recommended Minimum Distance (in feet and meters)
Microwave ovens	30 feet / 9 meters
Baby Monitor - Analog	20 feet / 6 meters
Baby Monitor - Digital	40 feet / 12 meters
Cordless phone - Analog	20 feet / 6 meters
Cordless phone - Digital	30 feet / 9 meters
Bluetooth devices	20 feet / 6 meters
ZigBee	20 feet / 6 meters