eBook

Electronic Book Reader

User Manual

Date: 2010/7

FCC Certifications

FCC Interference Statement

This equipment has been tested and found to comply with the limits for a Class B digital device, pursuant to Part 15 of the FCC Rules. These limits are designed to provide reasonable protection against harmful interference in a residential installation. This equipment generates, uses and can radiate radio frequency energy and, if not installed and used in accordance with the instructions, may cause harmful interference to radio communications. However, there is no guarantee that interference will not occur in a particular installation. If this equipment does cause harmful interference to radio or television reception, which can be determined by turning the equipment off and on, the user is encouraged to try to correct the interference by one of the following

measures:

- Reorient or relocate the receiving antenna.
- Increase the separation between the equipment and receiver.
- Connect the equipment into an outlet on a circuit different from that to which the receiver is connected.
- Consult the dealer or an experienced radio/TV technician for help.

This device complies with Part 15 of the FCC Rules.

Operation is subject to the following two conditions:

(1) This device may not cause harmful interference, and (2) this device must accept any interference received, including interference that may cause undesired operation.

FCC Caution: Any changes or modifications not expressly approved by the party responsible for compliance could void the user's authority to operate this equipment.

IEEE 802.11b or 802.11g operation of this product in the U.S.A. is firmware-limited to channels 1 through 11.

IMPORTANT NOTE:

The product comply with the US portable RF exposure limit set forth for an uncontrolled environment and are safe for intended operation as described in this manual. The further RF exposure reduction can be achieved if the product can be kept as far as possible from the user body or reduce output power if it doesn't affect the transmission/receiving quality.

CE Mark Warning

This equipment complies with the requirements relating to electromagnetic compatibility, EN 55022 Class B for ITE, the essential protection requirement of Council Directive 89/336/EEC on the approximation of the laws of the Member States relating to electromagnetic compatibility.

Company has an on-going policy of upgrading its

products and it may be possible that information in this document is not up-to-date. Please check with your local distributors for the latest information. No part of this document can be copied or reproduced in any form without written consent from the company.

Trademarks:

All trade names and trademarks are the properties of their respective companies.

Copyright © 2009, All Rights Reserved.

This product contains Adobe® Reader® Mobile software under license from Adobe Systems Incorporated, Copyright© 1995-2009 Adobe Systems Incorporated. All rights reserved. Adobe and Reader are trademarks of Adobe System Incorporated.

Contains Reader® Mobile technology by Adobe System Incorporated

Chapter 1: Introduction

Thank you for purchasing the product. Read this chapter to know about your eBook Reader including features, components, and capabilities.

1.1. Package Contents

Before using eBook Reader, please check your package contents to ensure that all items have been included. If any of the listed items are missing, please contact your reseller from where you purchased eBook Reader for assistance.

The package includes:

1. eBook Reader*1
2. AC Power Adapter*1
3. USB cable*1
4. Earphone*1
5. Leather case*1
6. Quick start guide*1

7. Warranty card*1

1.2. Overview

Lightweight and super-portable, this eBook Reader can hold hundreds of electronic books inside. Just like carrying a portable library, you can enjoy reading at anytime and anywhere!

Our eBook Reader is integrated with the E-Ink display to bring rich text and picture without needing a backlight and is easy to read in bright environments. The high-contrast screen is as close to actual ink on paper. It is natural, anti-glare and easy on the eyes. Furthermore, it is very power-saving, capable running up to 30 hours, 8000 pages available with a full single charged.

eBook Reader displays files in pdf, epub, html, txt, mob, prc, or doc formats with library management functions. And keep all the files in JPG format. It is also able to display books in a number of the world's most popular languages including English, Deutsch, French, Españoles, Pycckññ, Netherland, Traditional

Chinese, and Simple Chinese.

e-reader has the functional hot key for users to with turn pages, add bookmark, screen orientation, and adjust the font size, it is suitable from young to old.

No more paper, no more heavy books, with this eBook Reader, you can bring lots of books with you without increasing the heaviness on your backpack, and reduce the burden on your wrist. Reading becomes more comfortable than ever!

Downloaded
eBooks...

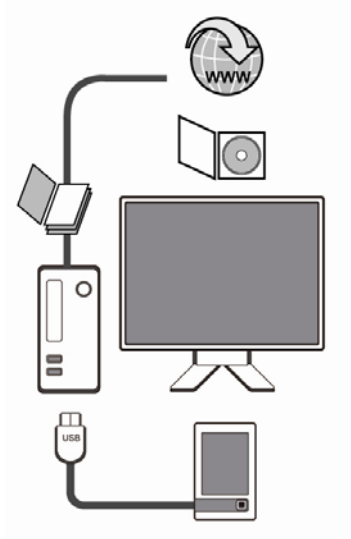

...and then transfer!

1.3. Physical Details

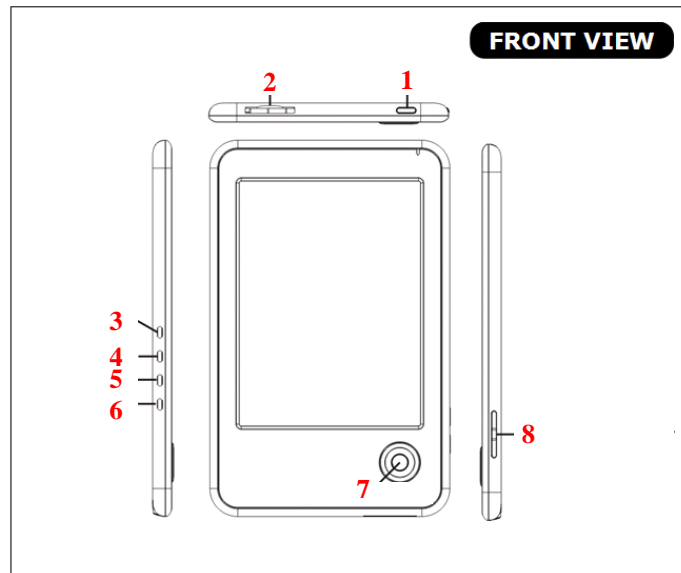

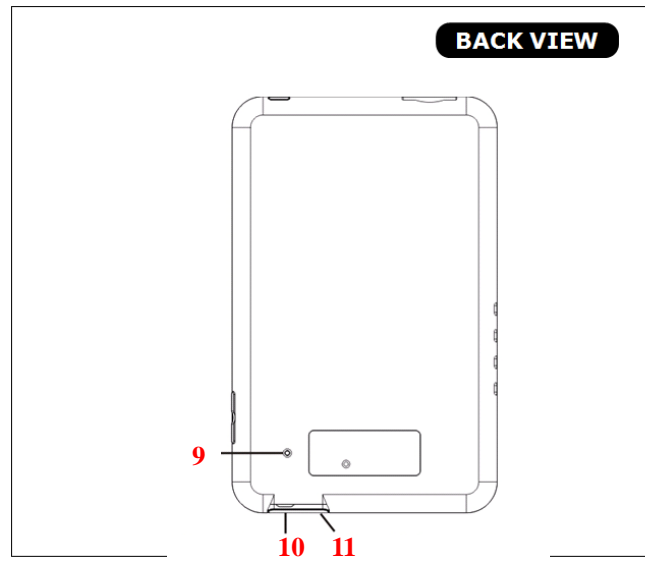

1. Power Button :

Turn the device on and off. To activate the device, press this "Power Button" for two seconds. To power off, press and hold the button for five seconds.

2. SD Card Slot :

Insert a SD card.

3. Favorite :

Add / Remove favorite files from Library, Reading History, Favorites and Music Page.

Add / Remove Bookmark while reading.

4. Screen Rotate :

Rotate the screen (landscape/ portrait)

5. Back :

Return to the previous layer at any environment.

6. Menu :

Press this button to show pop out menu including reader menu and setting.

7. five way Button :

Move cursor up, down, left or right; and then press select to confirm.

While reading, you can use five way button to

turn page and press enter to show the pop up menu.

8. Volume / Font Adjust :

Adjust font size while reading.

Adjust volume while playing music.

9. Reset :

To reset the device if no operation is possible.



10. Headphone Port :



Connect headphones.

11. USB port and AC power adapter port :

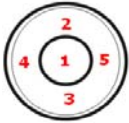
Connect the USB cable or AC power adapter.

Function & Basic Operation:

Cursor Kay & Select Button		Home	Reading
	1	Select Button	Menu / Select Button
	2	Move cursor up	Previous item
	3	Move cursor down	Next item
	4	Move cursor left	Previous page
	5	Move cursor right	Next page
Functional Hot Key		Home	Reading
 Font Adjust		NA	font size adjusting
 Favorite		Add/remove to my favorite list from Library, Reading History, Favorites and	Add / Remove Bookmark

	Music Page.	
 Rotate Screen	NA	Rotates the screen (landscape/portrait)
 Back	Back to previous layer	Back to library
 Menu	Setting Menu: Power, Date/Time, Language, Default, About and Owner.	Reader Menu: Bookmark, Contents, Rotate, Search, Page.

11.1. SD Card Installation

eBook Reader supports SD type SDHC cards, up to 32GB. Please follow the steps to properly insert/remove the SD card to the device.

TO INSERT SD CARD

STEP 1

Insert the card into the device with the metallic connectors facing upwards as shown in the picture.

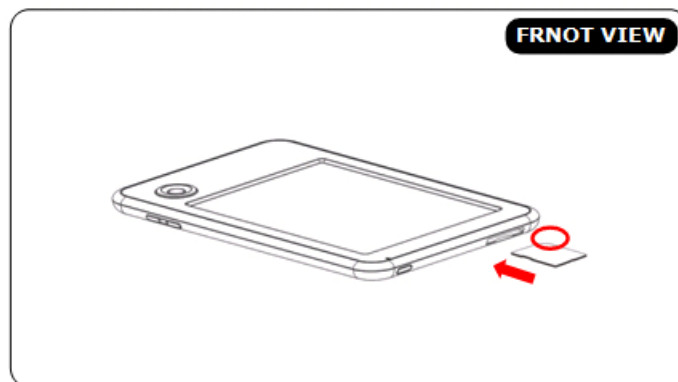

STEP 2

Insert the memory card until it clicks into place.



TO REMOVE SD CARD**STEP 1**

Gently push in the memory card. It will click and then push back out.

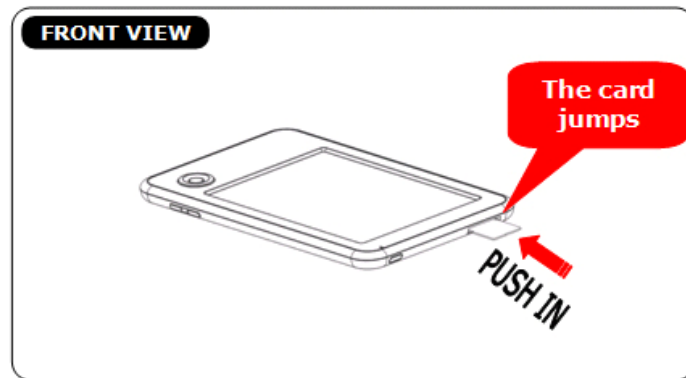

STEP 2

Remove the memory card carefully from the slot.

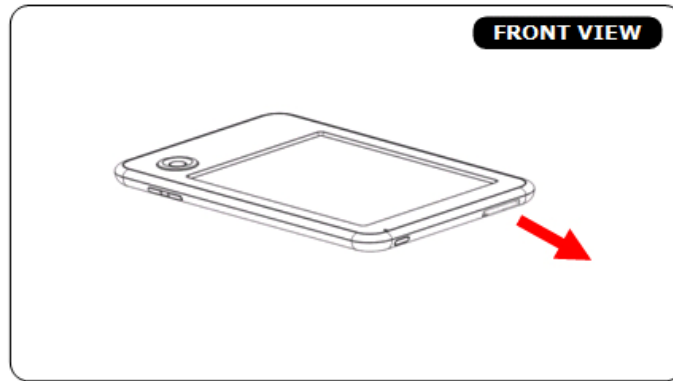

11.2. Charging the Battery

eBook Reader has an internal, nonremovable battery. The battery is 80-percent charged in about two hours, and fully charged in about four hours. If you charge eBook reader by connecting it to your computer, it may take longer to charge.

To charge the battery with computer:

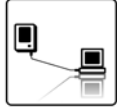

Connect eBook Reader to your computer with the USB cable in the package. When eBook reader connects to the computer, the device power turns red automatically and the screen shows "USB Link" status.

Important Advise:

The computer must be turned on and not in sleep mode during charging.

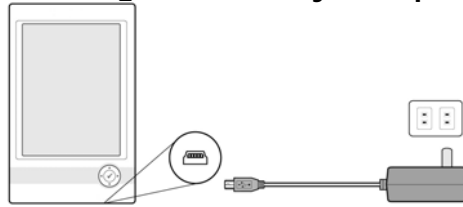
To charge the battery with power adapter:

Use the power adapter in the package. Insert the mini USB end of the cable to the device, and then plug the power adapter into an outlet. When eBook Reader connects to the power outlet, the device power turns red automatically. If the battery icon on the top-right corner of the eBook screen changes into , it means the battery is charging.

Battery Power Status:

When the device is not connected to a power source, a battery icon on the top-right corner of the eBook screen shows the battery status.

For example: this icon  shows the battery is about halfway charged.

Low Battery Warning:

This device provides low battery warning system.
Less than 20%: Battery low.
Less than 10%: Battery Critical.

Chapter 2: Content

This chapter provides information to install the content to the eBook Reader Device.

2.1 File Transfer

When connecting to PC, the eBook Reader Device is recognized as a mass storage device.

Copy the eBook folders or files which you've bought/downloaded from the internet to the disk, and then disconnect the eBook Reader Device to start reading.

Or copy the eBook folders/files to a SD card, and plug the SD card to the device to read directly.

Important Advise:

It is recommended to make regular backups of the content of your eBook reader to prevent the total loss of files from physical damage, failure, loss or theft.

2.2 Adobe Reader

This eBook Reader is embedded with Adobe Reader Mobile 9. The Reader Mobile 9 enables eBook Reader devices to easily acquire, manage and display encrypted and unencrypted PDF and EPUB content. Users can adopt Adobe Digital Editions as eBook management Utility between PC and eBook Reader.

Adobe® Digital Editions (ADE) software offers an engaging way to view and manage eBooks and other digital publications. Use it to download and purchase digital content, which can be read both online and offline. Transfer copy-protected eBooks from computers or devices. Organize your eBooks into a custom library and annotate pages. Digital Editions also supports industry-standard eBook formats, including PDF/A and EPUB.

Installing ADE, following the authorization process to start reading and transfer Digital Rights Management (DRM) content to your eBooks Reader, and you are ready to enjoy over hundreds of books

in just a few grams.

Step 1 :

Apply an Adobe ID on Adobe Website

<https://www.adobe.com/cfusion/membership/>

The image shows a screenshot of the Adobe website's 'New to Adobe?' section. At the top, there is a yellow button labeled 'Create an Adobe Account'. Below this button, the text reads 'It's free and only takes a minute' followed by 'Get complete access to:'. A list of benefits follows, including 'Free trial downloads', 'Hundreds of free product extensions', 'Community areas', 'Members-only white papers and downloads', 'On-demand seminars', and 'Manage your activity in the Adobe Worldwide Store'. A red callout box with a white border points to the 'Create an Adobe Account' button. The callout box contains the text: 'Click to start, and then follow the process to finish the application'.

Step 2 :

- To download Adobe Digital Editions go online to www.adobe.com/products/digitaleditions
- Find the installer which will look like the box shown to the right. **Click Install.**



- Press **Yes** to continue **Install**.

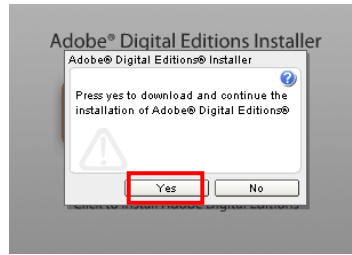

- A pop-up installer will appear. Follow the installer procedures choosing the install options and path you require.

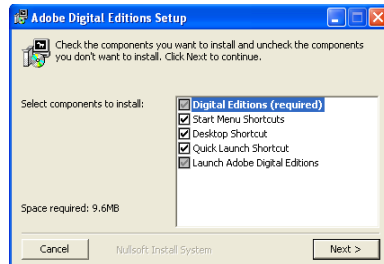

- When the install has completed, please agree to

the User Agreement and Digital Editions will automatically open.

Step 3 :

- When Digital Editions opens for the first time you will be asked to enter your Adobe ID credentials. Key in your Adobe ID, password and press **Authorize**. Once activated press **Finish**.

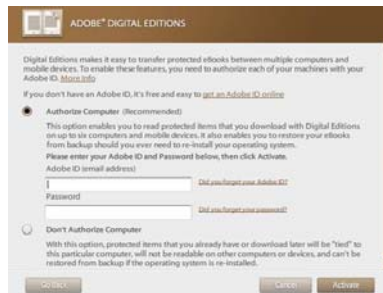

Step 4 :



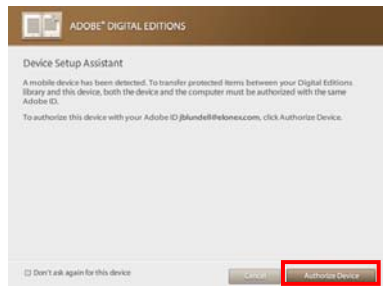

- Once the eBook has automatically installed itself with your operating system Digital Editions will automatically detect the eBook as a Mobile Device. Press **Authorize Device**.





**Step 5 :**

After authorizing your PC and reader, you are allowed to read the contents with DRM. Otherwise, you can't purchase, download, or read the contents with DRM.

Chapter 3: Homepage

The Homepage shows on the device as the main page. The following table lists the information and items of the Homepage

Icons	Information
 Favorite	Keep all the reading files marked favorite.
 Library	Keep all the files in PDF, EPUB, HTML, TXT, RTF, MOBI, PRC, or DOC formats.
 Music	Keep all the files in MP3 format, with music management functions.
 Explorer	List all the files in all kinds of formats, categorized by flash or SD card to indicate the file locations.

 Reading History	Keep the reading records of the latest 5 files ever read/open.
 Sudoku	Play Sudoku.
 Dictionary	Look up words inside the pre-loaded dictionary database.
 Picture	View your JPEG photos (grey scale)
 Settings	Device settings includes Power, Date/Time, Language, Default, About and Owner, etc. Please refer to 3.9 Settings for more information of this function.

3.1. Favorite

Favorite List keeps all the files marked favorite. You can designate any file by marking the tag on library page or in reading statement.

Please refer to [3.2 Library](#) for more information of favorite page.

3.2. Library

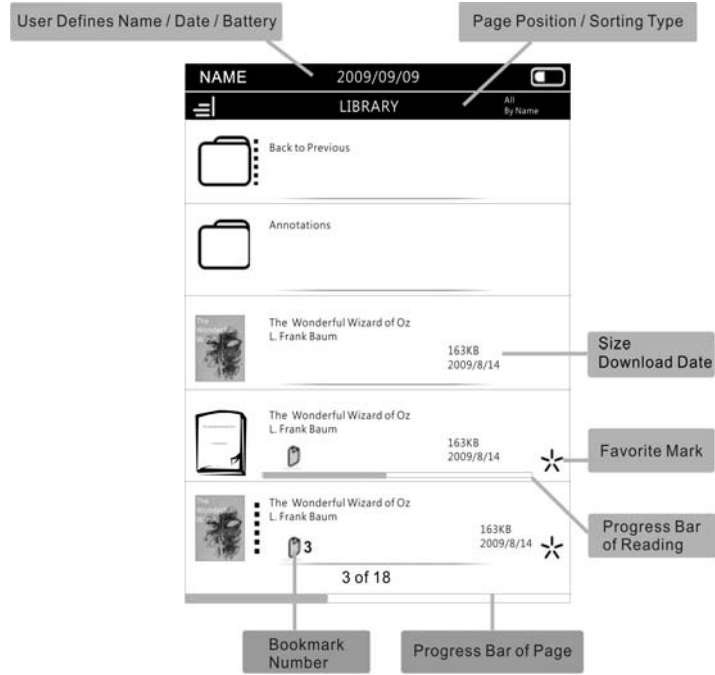

Library keeps all the files in PDF, EPUB, HTML, TXT, RTF, MOBI, PRC, or DOC formats inside the device and SD card.

Please refer to [4.1 Reading eBooks](#) for more information while reading.



Library Menu :

- On library page, press the [Menu Button] to open [Library Menu].
- The following table lists the information and items of [Library Menu].

Item	Function/Operation
 Favorite	Add/remove files to/from my favorite list.
 Filter	<ol style="list-style-type: none"> 1. Filter the files by file type. 2. The library list displays the style as you wish.
 Sort	<ol style="list-style-type: none"> 1. Sort the files by date, name, file type, ascend, descend and size. 2. The device refreshes the page according to the sorting type you have selected.

	3. Sorting type displays on the top-right corner of the screen.
 View	View all the files of eBook reader and SD card in list/thumbnail mode.

3.3. Music

Music page lists all the MP3 formats inside the device and SD card.

Please refer to [4.4 Listening to Music](#) for more information while listening to music.

3.4. Explorer

Explorer lists all the files in all kind of formats, categorized by flash or SD card.

3.5. Reading History

Reading History records 5 files you have read or open recently.

3.6. Game

eBook Reader provides SUDOKU game.

Please also refer to [4.3 Playing Games](#) to know more information of this function.

3.7. Dictionary

e-Reader provides dictionary for you to look up words inside the pre-loaded dictionary database.

3.8. Picture





In Picture file, it keeps the all images in JPG format of the device or SD card.



Please also refer to [4.2 Watching Pictures and Comics](#) for more information of this function.

3.9. Settings

Device setting includes Power, Date/Time, Language, Default, About and Owner.

Please follow the table below for more information.

Items	Function/Operation
 Power	Automatic power off with time regulation from 0 to 20 minutes while there is no operating on the device for a certain period of time.
 Date/Time	Date and time setting.
 Language	Select user interface language.
 Default	Clean up the Digital Right Manager files created by users and reset the device.

 About	The information of this device.
 owner	Configure owner's name.
 Dictionary	Select the dictionary type and language.



Chapter 4: What You Can Do with eBook Reader







4.1. Reading eBooks

- On [Library], [Reading History], [Favorite] page, select the files and enter to reading page.
- On reading page, press the [Select Button or Menu] to open [Reader Menu].
- Please refer to the table below for more information of [Reader Menu].

Reader Menu :



Item	Function/Operation
 Bookmark	Add/delete bookmarks.
 Contents	List the table of content in the reading book.
 Rotate	Switch the screen orientation.





 Search	Provide soft keyboard to input English / European Language / Chinese and search a certain word in whole books.
 Page	Open the number keyboard to insert the appointed page.
 Font	Select the font size.
 Back	Back to the reading page.
 More	Enter Reader Menu Subcategory.

Reader Menu Subcategory:

- On Reader Menu, enter [ more]. Open Reader Menu [Subcategory].
- Please refer to the table below for more information of the Reader Menu [Subcategory].

Subcategory:

Item	Function/Operation
 Annotation	Display the Bookmark list. You can select any Bookmark file to open the reading page and keep reading.
 Font Family	Change the font type.
 Full Screen	Change the reading screen into a full page mode.



 property	Show the information of the file you are reading.
 Favorite	Add/Delete the file to/from my favorite list.
 Delete	Delete the file.
 Back	Back to main [Reader Menu].

4.2. Watching Pictures and Comics

This part introduces the image page information and basic operations.

- On Picture page, press [Select Button or Menu] to open the [picture menu].
- Please refer to the table below for more information of the [Picture Menu].

Picture Menu:

Item	Function/Operation
 Zoom	Zoom in/out the image.
 Rotate	Rotate the image to vertical or horizontal.
 Sliding	Sliding pictures with time regulation from 0 to 20 seconds.

<p>i About</p>	<p>The information of the image file.</p>
----------------------------------	---

4.3. Listening to Music

This part introduces the audio page information and basic operations.

- On homepage, enter Music list.
- Select the file and press enter to start playing music.
- While listening to music, easily adjust the volume by pressing the [Prev. / Next Page Buttons].
- You also can press [Menu button] to open [Music Setting] during listening to music.
- Please refer to the following table to reach more information of [Music Setting].

Music Setting:

Item	Function/Operation
Music On Music Off	Turn on/off the background music.
Play Mode	Select playing mode: repeat single,

	repeat all or random.
Exit Menu	Close [music setting].

Note:

1. By turning on background music, you can listen to music and read the files at the same time.
2. When listening to music, press [+/-] buttons only can adjust the volume.

4.4. Playing Sudoku





This part introduces the game page information and basic operations.

- This device provides SUDOKU game.
- In the game, you need to fill out the correct number to complete the grid.
- The digits from 1 to 9 can only appear one time in each column, row, and each of the nine 3x3 boxes.
- Please refer to the following table for more information and basic operations.

Playing Game:

Function/Operation
<p>New game window:</p> <ol style="list-style-type: none"> 1. On Homepage, enter to SUDOKU page and open the new game window. 2. Select game level and press enter to start playing. Or select [Exit Menu] item to leave the game.
<p>How to play:</p> <ol style="list-style-type: none"> 1. On the plan grid, press enter to open the [Number

Menu].

2. Select  PEN to confirm the number,
-  PENCIL to mark the possible number,
-  ERASE to refill the number,
-  MENU to open the new game window and restart the game.
-  EXIT to close the [Number Menu].

Appendix

Appendix A: Reset

Reset eBook Reader by using a small pin or clip, the contents stored inside are not affected by resetting, and no information is erased.

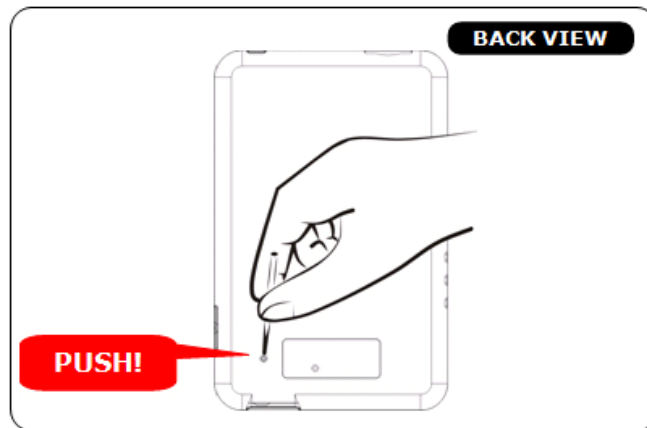

Appendix B: Cleaning and Safety

➤ **CLEANING**

Before cleaning, please power off and disconnect cables from system and AC outlet. After finish of cleaning, please make sure that the monitor is completely dry before you reconnect cables and power it on. Please do not use any liquid or spray cleaners directly on surface of screen or case. Please use a soft, clean, lint-free cloth with cleaners to clear your monitor.

1. Screen

Please use a soft, clean, lint-free cloth to remove dust and dirt from the screen. For fingerprints & smudges, please use a soft cloth with cleaners.

2. Case

Please clean the case with a soft cloth slightly moistened with a mild detergent solution. Please rinse the cloth with clear water, wring it dry, and wipe the case to remove any detergent residue.

➤ **SAFETY**

1. To reduce risk of electric shock, please follow all safety notices, never open case of products by yourself, and turn off power before cleaning.

2. The products are equipped with a power adapter. (The type of power adapter may be different according to different countries.) The power adapter plug only fit into a safety ground outlet. Do not attempt to fit the plug into an outlet that has not been configured for this purpose. Please only use power adapter that comes with the products. Using an unauthorized power adapter may invalidate the warranty of the products.
3. Please do not insert or block any object inside four edges of the screen.
4. Please do not pour liquid into or onto products and wash with a wet cloth. If the products become wet, please do not turn on or attempt to repair by yourself. Please ask a qualified service technician to check it for you before you turn on the power again.
5. Please use products under suitable environment written in specification and protect products working away from extremely bad environment.
6. Please keep the products away from bumps and drops.

7. Please keep the products away from dust, sand, and dirt.

Appendix C: Specifications

OS	Linux 2.6.28
CPU	Freescale ARM11, 532 MHz
Interface	1 x USB Client v2.0 - Mini USB connector 1 x 2.5mm stereo earphone connector 1 x SDHC card slot Buttons: 4 functional hot keys +2 volume adjust buttons +5 way buttons + Power button
Screen	6" E Ink® Vizplex Screen { 4.8" x 3.6" – 122 x 91mm }
Resolution	600 x 800 pixels, 16 grayscale Daylight readable, no backlight
Power Source	Built-in rechargeable Li-Polymer battery: 1000mAh

	Adapter: DC 5V 1000mA
Battery Life	Approx. 8,000 pages (battery is full charged)
Internal Storage Size	2 GB
Expandability	SD type SDHC, up to 32GB
Support Language	English, Deutsch, French, Españoles, Pycckññ, Netherland, Traditional Chinese, Simple Chinese
Dimensions	120 x 188 x 9.5 mm – 4.7" x 7.4" x 0.37"
Weight	180g (battery included)
Temperature	Operating: 0° ~ 45°C Storage: -10° ~ 60°C

Humidity	10%~95% RH, non condensing
Regulatory Certification	FCC, CE Class B, Adobe Reader Mobile 9

Contains Reader® Mobile technology by Adobe Systems Incorporated.