

For FCC Certification

Kobo eReader User Guide

May 2013
Kobo Inc.

For Internal Use Only

Safety, Regulatory and Warranty Information

Important safety, regulatory and warranty details about your Kobo eReader can be found on the Kobo website at www.kobo.com/userguides.

Note: The Declaration of Conformity may vary for different models of the Kobo eReader. The web site includes details of how to find your Kobo eReader model number.

What's covered





- Anatomy of your Kobo eReader
- Turning your Kobo eReader on and off
- Charging your Kobo eReader
- Using the light
- Turning pages
- Connecting to the Kobo Store or syncing your Library over Wi Fi
- Adding books using a Micro SD card
- Adding books using your computer

Note:

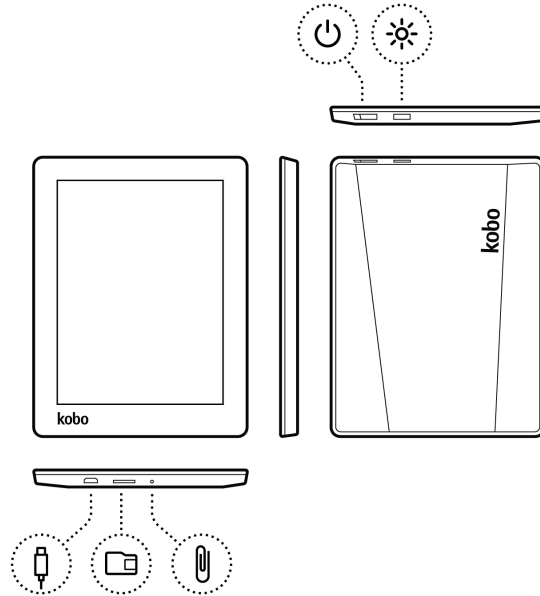
- This device does not have 3G capabilities, and only supports wireless LAN networks (WLAN).

Anatomy of your Kobo eReader



	Light button	Turn on the screen light to read in the dark.
	Power slider	Turn your eReader on and off, or put it to sleep.
	Micro SD card slot	Increase the number of books your eReader can hold by inserting a micro SD card.
	Reset hole	Insert a paper clip and press gently to reset your eReader.
	USB port	Connect your eReader to your computer using the supplied USB cable to charge your eReader or to add books to it.

Turning your Kobo eReader on & off

You can turn your eReader on and off or put it to sleep using the power slider.

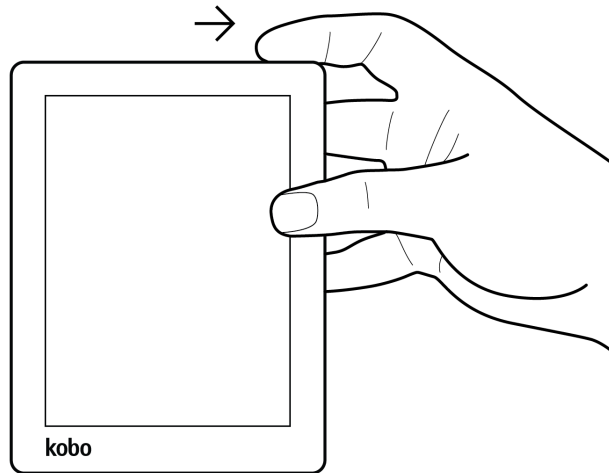

To turn on your eReader:

- Slide the power switch.

To turn off your eReader:

- Slide and hold the power switch down until the Off screen appears.

To put your eReader to sleep:

- Slide the power switch briefly when your eReader is on.

Charging your Kobo eReader

Your eReader can last several weeks after a full charge. If this is your first time using your eReader out of the box, it's recommended to charge your eReader for up to 3 hours before using it.

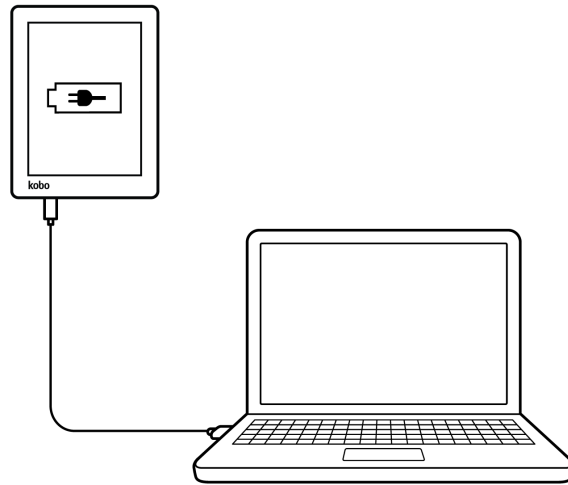

To charge your eReader:

1. Turn on your computer.
2. Connect your eReader to your computer using the USB cable.

When you're finished charging, simply unplug the USB cable from your eReader.

Using the light

You can read in areas with low light or even in the dark using the front light. The front light can be used for hours without affecting your eReader's battery life.

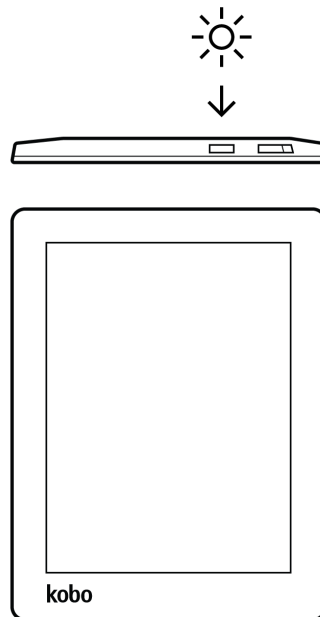

To turn the front light on and off:

- Press the  front light button

Turning pages

You can turn pages while you read by tapping or swiping the touch screen.

To turn pages in a book:

- Tap or swipe the sides of the page.

If you want to jump forward by more than a page or two, you can:

- Use the navigation bar to change pages or chapters.
- Use the Table of Contents to browse a list of chapters and change chapters.

Connecting to the Kobo Store or syncing your Library over Wi Fi

Your eReader lets you use Wi Fi (wireless internet) so that you can shop for books, sync your library, and more. All you need is a wireless network in your area.

To connect to a wireless network:

1. Tap the Home icon at the top of the screen.
2. Tap **Sync**.
Your eReader will look for Wi Fi networks that are in range.
3. Tap the name of the Wi Fi network that you'd like to connect to.
4. If required, enter the Wi Fi password.
5. Tap **Join**.

After you've connected to a Wi Fi connection, you'll see a Wi Fi symbol at the top right corner of the screen. This means that you're connected to Wi Fi. This icon will disappear when your eReader is trying to conserve battery. When you connect to the Kobo Store or sync your books, your eReader will automatically connect to Wi Fi.

Adding books using a Micro SD card

You can increase the number of books your eReader can hold by adding a microSD card with books already stored on it. Books must be in EPUB or PDF format. It does not matter how they are organized on the card — your eReader will scan the entire card for books and list any that it finds in your library. The eReader will ignore any files that it cannot read.

Notes:

- You can't add DRM-protected books using a micro SD card.
- Your eReader does not copy books from the card, it merely reads the books that are stored on it. This means that you need to leave your card inserted while you read any books on it.

To add books on a micro SD card:

1. Put your EPUB or PDF files on a micro SD card.
2. Turn off your eReader.
3. Insert the card into the the card slot at the side of the eReader and push gently until it slides in.
4. Turn on your eReader.

Your eReader will scan the card for books and documents, and update your library. This may take a few moments.

Adding books using your computer

You can connect your eReader to your computer and then drag and drop books to add them to your eReader library.

To do this you need:

- A Windows or Mac computer
- A USB cable provided with your eReader
- The books you want to add to your eReader in EPUB or PDF format

To add books using a Mac computer:

1. Connect your eReader to your computer using the provided USB cable.
2. Tap **Connect** on your eReader screen.
3. On your computer's desktop, double-click **KOBOeReader**.
4. Open a Finder window, and go to where you stored the EPUB or PDF files you want to transfer to your eReader.
5. Drag and drop the files into the eReader window.

To add books using a Windows computer:

1. Connect your eReader to your computer using the provided USB cable.
2. Tap **Connect** on your eReader screen.
3. When Window prompts you for an action, select 'Open folder to view files.' A window should open, showing the contents of your eReader.
4. In another window, go to where you stored your eBooks you want to add to your eReader.
5. Drag and drop your eBooks into the eReader window.

Legal

Regulatory Compliance Statement

Regulatory and device approval markings can be viewed on the Kobo eReader by completing these instructions:

1. Slide the power button to the right to turn on your eReader.
2. From the Home screen, tap the  Menu icon at the top of the screen.
3. Tap **Settings**.
4. Tap **Device information**.
5. Beside Warranty & Legal, tap **View**.

CE 0560

EU Declaration of Conformity

Български [Bulgarian]

Kobo Inc. декларира, че този оборудване е в съответствие със съществените изисквания и другите приложими правила на Директива 1999/5/EC.

Česky [Czech]

Kobo Inc tímto prohlašuje, že tento zařizení je ve shodě se základními požadavky a dalšími příslušnými ustanoveními směrnice 1999/5/ES.

Dansk [Danish]

Kobo Inc erklærer herved, at følgende udstyr overholder de væsentlige krav og øvrige relevante krav i direktiv 1999/5/EF.

Deutsch [German]

Kobo Inc, erklärt dieses Gerät entspricht den grundlegenden Anforderungen und den weiteren entsprechenden Vorgaben der Richtlinie 1999/5/EU.

Eesti [Estonian]

Kobo Inc deklareerib seadme seadme vastavust direktiivi 1999/5/EÜ põhinõuetele ja nimetatud direktiivist tulenevatele teistele asjakohastele sätetele.

English

Kobo Inc declares that this equipment is in compliance with the essential requirements and other relevant provisions of Directive 1999/5/EC.

Español [Spanish]

Kobo Inc declara que el equipo cumple con los requisitos esenciales y cualesquiera otras disposiciones aplicables o exigibles de la Directiva 1999/5/CE.

Ελληνική [Greek]

Kobo Inc ΔΗΛΩΝΕΙ ΟΤΙ ΕΞΟΠΛΙΣΜΟΣ ΣΥΜΜΟΡΦΩΝΕΤΑΙ ΠΡΟΣ ΤΙΣ ΟΥΣΙΩΔΕΙΣ ΑΠΑΙΤΗΣΕΙΣ ΚΑΙ ΤΙΣ ΛΟΙΠΕΣ ΣΧΕΤΙΚΕΣ ΔΙΑΤΑΞΕΙΣ ΤΗΣ ΟΔΗΓΙΑΣ 1999/5/ΕΚ.

Français [French]

Kobo Inc déclare que l'appareil est conforme aux exigences essentielles et aux autres dispositions pertinentes de la directive 1999/5/CE.

Italiano [Italian]

Kobo Inc dichiara che questo apparecchio è conforme ai requisiti essenziali ed alle altre disposizioni pertinenti stabilite dalla direttiva 1999/5/CE.

Latviski [Latvian]

Kobo Inc deklarē, ka iekārta atbilst būtiskajām prasībām un citiem ar to saistītajiem noteikumiem Direktīvas 1999/5/EK.

Lietuvių [Lithuanian]

Kobo Inc deklaruoja, kad šis įranga atitinka esminius reikalavimus ir kitas 1999/5/EB Direktyvos nuostatas.

Nederlands [Dutch]

Kobo Inc dat het toestel toestel in overeenstemming is met de essentiële eisen en de andere relevante bepalingen van richtlijn 1999/5/EG.

Malti [Maltese]

Kobo Inc jiddikjara li dan prodott jikkonforma mal-ħtiġijiet essenzjali u ma provvedimenti oħrajn rilevanti li hemm fid-Direttiva 1999/5/EC.

Magyar [Hungarian]

Kobo Inc nyilatkozik, hogy a berendezés megfelel a vonatkozó alapvető követelményeknek és az 1999/5/EC irányelv egyéb előírásainak.

Polski [Polish]

Kobo Inc oświadcza, że wyrobu jest zgodny z zasadniczymi wymogami oraz pozostałymi stosownymi postanowieniami Dyrektywy 1999/5/EC.

Português [Portuguese]

Kobo Inc declara que este equipamento está conforme com os requisitos essenciais e outras disposições da Directiva 1999/5/CE.

Româna [Romanian]

Kobo Inc declară că acest echipament este în conformitate cu cerințele esențiale și cu celelalte prevederi relevante ale Directivei 1999/5/CE.

Slovensko [Slovenian]

Kobo Inc izjavlja, da je ta opreme v skladu z bistvenimi zahtevami in ostalimi relevantnimi določili direktive 1999/5/ES.

Slovensky [Slovak]

Kobo Inc týmto vyhlasuje, že zariadenia spĺňa základné požiadavky a všetky príslušné ustanovenia Smernice 1999/5/ES.

Suomi [Finnish]

Kobo Inc vakuuttaa täten että laitteet on direktiivin 1999/5/EY oleellisten vaatimusten ja sitä koskevien direktiivin muiden ehtojen mukainen.

Svenska [Swedish]

Kobo Inc förklarar att denna utrustningstyp står i överensstämmelse med de väsentliga egenskapskrav och övriga relevanta bestämmelser som framgår av direktiv 1999/5/EG.

The declaration of conformity may be consulted at www.kobo.com/userguides

SAR Limits

The exposure standard for wireless devices employs a unit of measurement known as the Specific Absorption Rate, or SAR. The SAR limit set by the FCC/IC is 1.27W/kg. The SAR limit recommended by The Council of the European Union is 2.0W/kg. This device's maximum SAR value is well below the FCC/IC and EU limits with specific measurements shown in the below table.

Device Model	FCC/IC 1g SAR Limit	Highest Value
N514	1.27	TBD
Device Model	EU 10g SAR Limit	Highest Value
N514	2.0	TBD

Important: Changes or modifications to this product not authorized by Kobo could void the EMC and wireless compliance and negate your authority to operate the product. This product has demonstrated EMC compliance under conditions that included the use of compliant peripheral devices and shielded cables between system components. It is important that you use compliant peripheral devices and shielded cables between system components to reduce the possibility of causing interference to radios, televisions, and other electronic devices.

FCC Compliance Statement



This device complies with Part 15 of the FCC Rules. Operation is subject to the following two conditions: (1) This device may not cause harmful interference, and (2) this device must accept any interference received, including interference that may cause undesired operation.

This equipment has been tested and found to comply with the limits for a Class B digital device, pursuant to part 15 of the FCC Rules. These limits are designed to provide reasonable protection against harmful interference in a residential installation. This equipment generates, uses and can radiate radio frequency energy and, if not installed and used in accordance with the instructions, may cause harmful interference to radio communications. However, there is no guarantee that interference will not occur in a

particular installation. If this equipment does cause harmful interference to radio or television reception, which can be determined by turning the equipment off and on, the user is encouraged to try to correct the interference by one or more of the following measures:

- Reorient or relocate the receiving antenna.
- Increase the separation between the equipment and receiver.
- Connect the equipment into an outlet on a circuit different from that to which the receiver is connected.
- Consult the dealer or an experienced radio/TV technician for help.

Any changes or modifications not expressly approved by the party responsible for compliance could void the user's authority to operate this equipment. This device is limited to operation on permissible Part 15 frequencies, and it does not have the ability to be configured by end users or professional installers to operate outside the authorized bands.

Industry Canada statement

This device complies with RSS-210 of the Industry Canada Rules. Operation is subject to the following two conditions: (1) This device may not cause harmful interference, and (2) this device must accept any interference received, including interference that may cause undesired operation.

This Class B digital apparatus complies with Canadian ICES-003

Ce dispositif est conforme à la norme CNR-210 d'Industrie Canada applicable aux appareils radio exempts de licence. Son fonctionnement est sujet aux deux conditions suivantes: (1) le dispositif ne doit pas produire de brouillage préjudiciable, et (2) ce dispositif doit accepter tout brouillage reçu, y compris un brouillage susceptible de provoquer un fonctionnement indésirable.

Cet appareil numérique de la classe B est conforme à la norme NMB-003 du Canada

FOR PORTABLE DEVICE USAGE

Radiation Exposure Statement:

The product complies with portable RF exposure limit in Canada and the USA set forth for an uncontrolled environment and is safe for intended operation as described in this manual. Further RF exposure reduction can be achieved if the product can be kept as far as possible from the user body.

Déclaration d'exposition aux radiations:

Le produit est conforme aux limites d'exposition pour les appareils portables RF pour les États-Unis et le Canada établies pour un environnement non contrôlé.

Le produit est sûr pour un fonctionnement tel que décrit dans ce manuel. La réduction aux expositions RF peut être augmentée si l'appareil peut être conservé aussi loin que possible du corps de l'utilisateur ou que le dispositif est réglé sur la puissance de sortie la plus faible si une telle fonction est disponible.

Recycling Information

WEEE – European Union Only

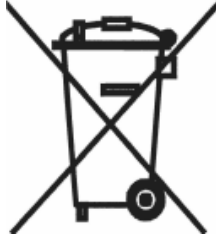

This symbol on the product or on its packaging indicates that this product must not be disposed of with your other household waste. Instead, it is your responsibility to dispose of your waste equipment by handing it over to a designated collection point for the recycling of waste electrical and electronic equipment. The separate collection and recycling of your waste equipment at the time of disposal will help to conserve natural resources and ensure that it is recycled in a manner that protects human health and the environment. For more information about where you can drop off your waste equipment for recycling, please contact your local city office, your household waste disposal service or the shop where you purchased the product.

The European Union is not the only jurisdiction where electronics are separately collected and treated. Please contact your local waste authority for how you should dispose of your device.

For further information on how you can recycle your device, please contact Kobo at: www.kobobooks.com/recycling

Other Safety Information

1. The RF signals generated by your device can cause interference with or malfunction to medical devices such as pacemakers or hearing aids, including the potential for serious injury. If you have any concerns about using your Kobo device in proximity to any medical devices, please consult the manufacturer of the medical device in question.
2. Certain locations, such as health care facilities or construction sites, may be put at risk when radio frequency (RF) signals are generated, including through use of the wireless functionality on your device. If you see signs and other material requesting that two-way radios or cellular phones should be turned off, please turn off the wireless connection of your device in these areas.
3. This Kobo device has been tested to comply with specific absorption rate (SAR) limits. The maximum allowable level for the European Union is 2.0 W/kg and operation of this device is below that value.
4. Do not open or attempt to repair your device, including repair or replacement of the lithium ion battery in this device; contact Kobo Support for any repair and/or battery-related safety concerns.
5. It is recommended to only use Kobo adapters or chargers that are specifically designed or approved for your Kobo device. Do not use your adapter if the cord or plug is damaged.

6. Avoid exposing your device to fire and other direct heat, including hair dryers and microwave ovens and other appliances.
7. As this device contains small components that could lead to a choking hazard for small children, Kobo recommends that you do not open the device for any reason, including repair.
7. Avoid storing your device in temperatures lower than -10° and higher than 60° C (14° to 140° F). Operation of the device should occur in temperatures between 0° and 45° C (32° to 113° F). Dramatic changes in temperature or humidity may affect the functioning of the device due to the formation of condensation.
8. Do not force objects into your device ports (USB port), connections or buttons. If a connector does not easily fit, then it may not be a match for this device.
9. Do not operate the device when driving and do not store your device in a location that is covering an airbag location. Airbags erupt with incredible force and could cause injury or damage if your device or its accessories are in the path of the expected airbag's inflation area.
10. During travel on an airplane, follow all instructions provided by your flight operator. Your Kobo device wireless "Wi-Fi" on/off function available in your device settings.
11. Some individuals may be susceptible to seizures, blackouts, and eyestrain when operating devices with flashing lights or similar light patterns. If you have experienced any of these symptoms or you have any concerns about this issue, please consult a physician. It should be noted that this may occur even if you have not had a prior occurrence.