

**CAUTION-ELECTRICALLY OPERATED PRODUCT:**  
NOT RECOMMENDED FOR CHILDREN UNDER 8 YEARS OF AGE.  
AS WITH ALL ELECTRIC PRODUCTS, PRECAUTIONS SHOULD BE  
OBSERVED DURING HANDLING AND USE TO PREVENT ELECTRIC  
SHOCK. INPUT: 120V AC 60Hz 6.5W. OUTPUT: 11.6V DC 165mA.

**Thank you for choosing a premium New Bright product.**

**9.6V NiCd** **Radio Control**  
*RECHARGEABLE* **Vehicle**

# **OWNERS MANUAL**

*Please read and understand all precautions prior to use.*

- Page 1: Table of Contents**
- Page 2: Component Checklist**
- Page 3: Charging the Battery**
- Page 4: Battery Installation in Vehicle**
- Page 5: Vehicle Features and Functions**
- Page 6: Antenna Placement  
Transmitter Battery Installation**
- Page 7: Transmitter Features and Functions**
- Page 8: Proper Use  
Precautions and Care**
- Page 9: Trouble shooting and Support**
- Page 10: Cautions**
- Page 11: Warranty Info**

# New Bright

## Component Checklist

*To protect components from damage, they may be packed in the styrofoam tray out of plain sight. Please search styrofoam tray and remove all of the components shown below. Styrofoam should be saved for storing your vehicle.*

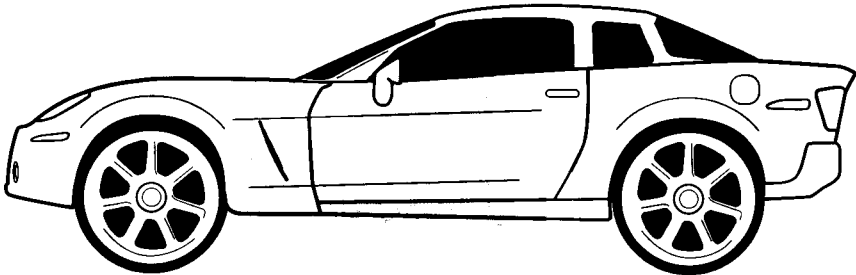

1

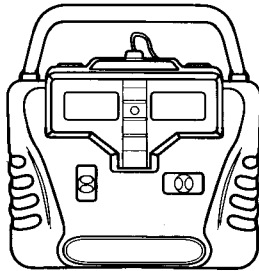

1

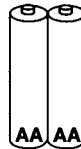

2



1

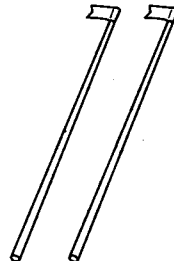
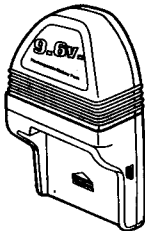

2

# Battery Pack

## Charging the Battery

### IMPORTANT!

The included 9.6V NiCd battery pack is NOT charged prior to shipment and must be **charged at least 8 hours** before the first use.

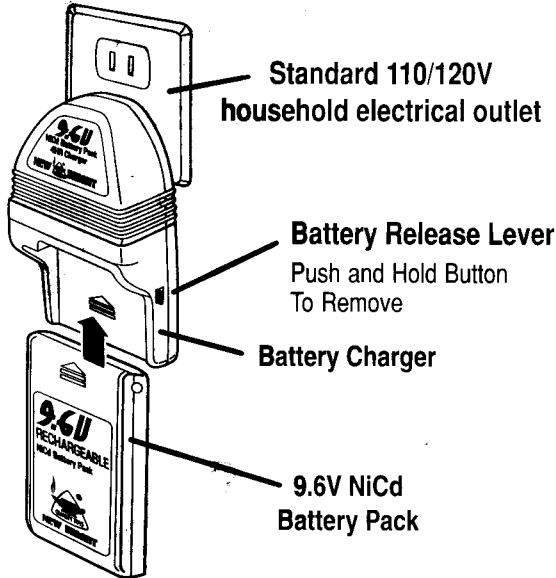

1. Plug the Charger into a standard indoor electrical outlet.
2. Insert the 9.6V NiCd rechargeable battery pack securely into the charging cradle (as shown above). Be sure the arrows are properly matched.
3. Allow battery to charge for a minimum of 8 hours on the initial two charges. Subsequent charges require only 4 hours.
4. Charge will last approximately 15 minutes depending on terrain and driving style.
5. This power unit is intended to be correctly orientated in a vertical or floor mount position.

**IMPORTANT:** It is normal for the battery pack to become warm after charging and/or use. Be sure to allow the battery pack to cool before using or recharging. Recharging a warm battery pack will greatly reduce the battery life.

**Battery pack can be charged up to 1,000 times!**

### ATTENTION PARENTS:

- The Battery Charger & Battery Pack need to be periodically examined for potential hazards. Any potentially hazardous parts need to be repaired or replaced.

# Vehicle

## Battery Installation

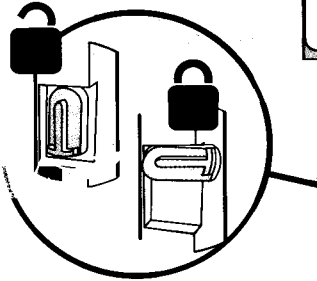
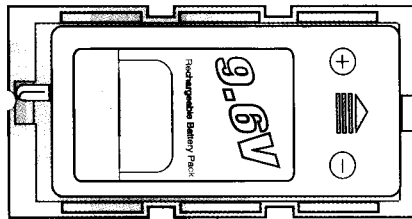
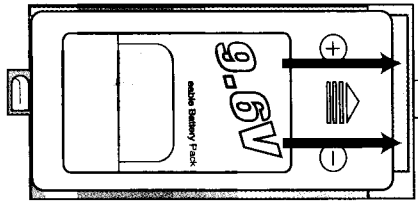
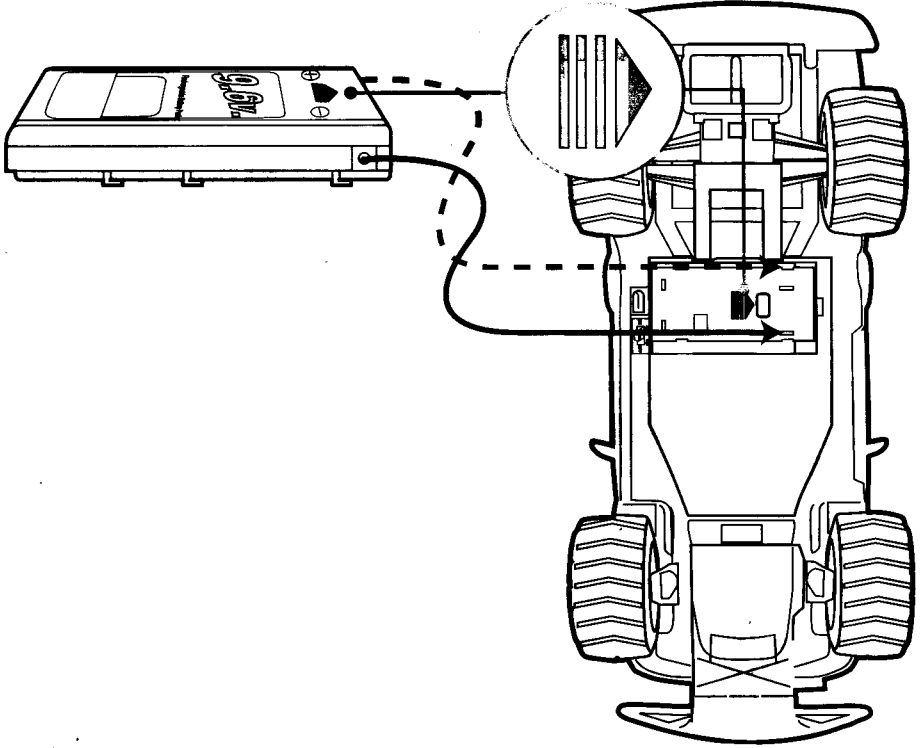

# Vehicle

## Features and Functions

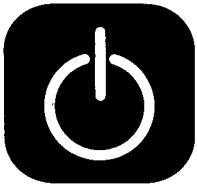
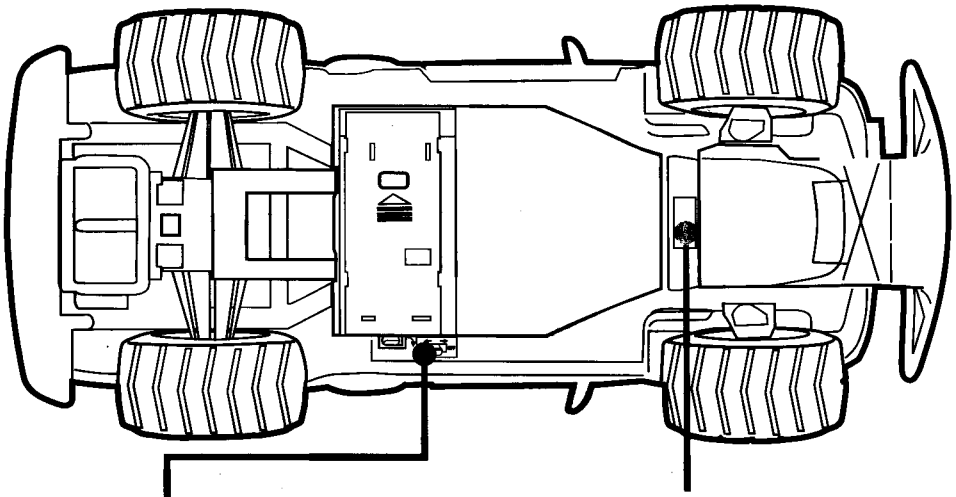

ON/OFF Switch

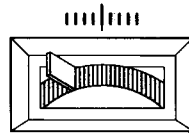

Trim Control

If vehicle pulls to the left or right during forward driving the Steering Trim may need to be adjusted. The Steering Trim is located on bottom of chassis between the front wheels.

# Antenna

## Antenna Placement

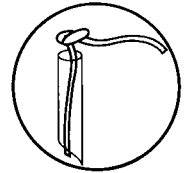
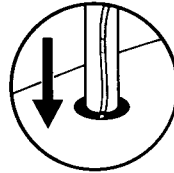
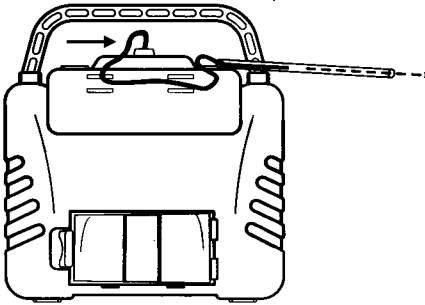
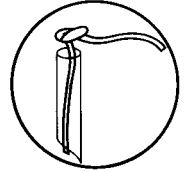
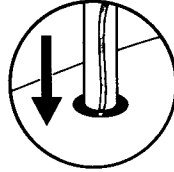
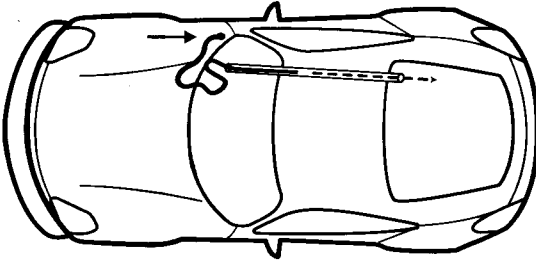

# Transmitter

## Battery Installation

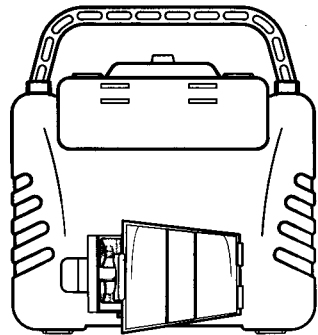
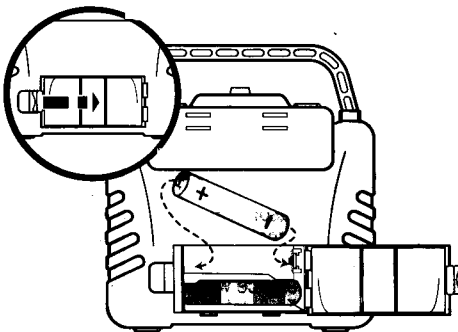

**Note:** When replacing Transmitter batteries:

Use alkaline batteries only.

Do not mix old and new batteries.

Do not mix alkaline, standard or rechargeable batteries.

# Transmitter

## Features and Functions

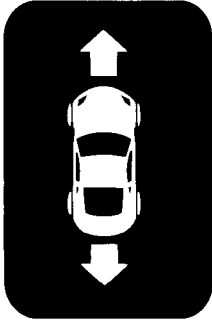

Forward/Reverse  
Drive

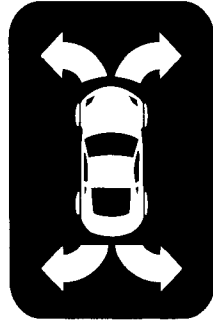

Left/Right  
Steering

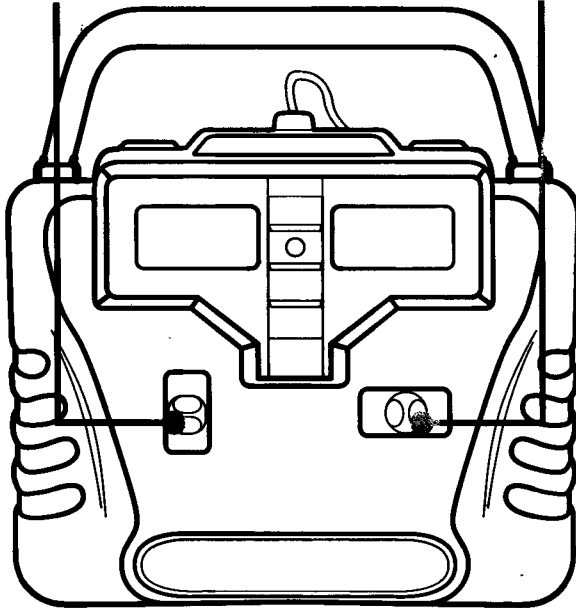

### FCC CAUTION:

The manufacturer is not responsible for radio interference caused by unauthorized frequency modification to this equipment. Such modifications could void the user's authority to operate the equipment.



# Proper Use

## Precautions and Care

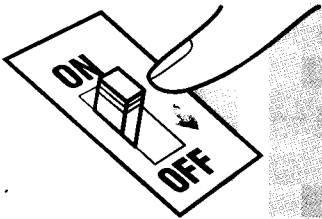

Switch vehicle OFF  
when not in use.

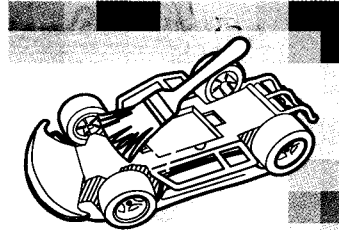

Brush areas where  
dirt gets trapped.

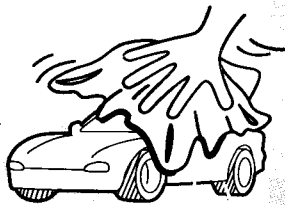

Wipe body with a  
soft rag or cloth.

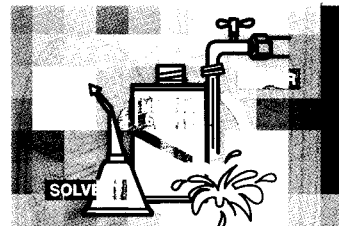

Do not use chemicals  
or water to clean.

## Trouble Shooting & Support

### **Problem - Vehicle does not move or moves slowly.**

- Make certain there are fresh alkaline batteries in the transmitter and that they have been installed in the correct position.
- Are the (+) and (-) markings on the alkaline batteries in the same position as the (+) and (-) markings in the Transmitter Battery Compartment?
- Has the Battery Pack been installed in the vehicle?
- Has the rechargeable Battery Pack been fully charged?
- Are the (+) and (-) markings on the Battery Pack in the same position as the (+) and (-) markings in the Battery Compartment?
- Are the metal contact tabs touching, rusty or dirty in the transmitter?
- Make certain that the vehicle ON/OFF switch is in the "ON" position.

### **Problem - Vehicle moves by itself or exhibits reduced range from the transmitter.**

- Make certain there is no outside radio interference in your area. The best way to test this is to take the vehicle as far away from radio towers, electrical lines or tall buildings as possible to ensure no further radio interference will occur.

**NOTE:** This equipment has been tested and found to comply with the limits for a Class B digital device, pursuant to Part 15 of the FCC Rules. These limits are designed to provide reasonable protection against harmful interference in a residential installation. This equipment generates, uses and can radiate radio frequency energy and, if not installed and used in accordance with the instructions, may cause harmful interference to radio communications. However, there is no guarantee that interference will not occur in a particular installation. If this equipment does cause harmful interference to radio or television reception, which can be determined by turning the equipment off and on, the user is encouraged to try to correct the interference by one or more of the following measures:

- Reorient or relocate the receiving antenna.
- Increase the separation between the equipment and receiver.
- Connect the equipment into an outlet on a circuit different from that to which the receiver is connected.
- Consult the dealer or an experienced radio/TV technician for help.

## Cautions

Do not recharge Battery Pack if it is hot or warm to the touch. Allow Battery Pack to cool before recharging. Recharging a hot or warm Battery Pack will shorten the life of the Pack.

Do not recharge a Battery Pack if it appears to be damaged or leaking.

Always unplug Charging Cradle when not in use.

Always remove Battery Pack from Battery Compartment when not in use.

Do not dispose batteries in fire. Leakage, explosion and personal injury may occur.

Dispose of NiCd Battery Pack properly.

Do not attempt to disassemble Battery Pack or Charger.

Do not use Battery Charger for any use other than instructed in this booklet.

Only an adult should charge Batteries.

Do not attempt jumps or tricks with this vehicle.

## Warranty Info

### USA and Canada 60-day Limited Warranty

New Bright Industries warrants to the original purchaser that this product will be free of defects in materials and workmanship for sixty (60) days from the date of purchase. New Bright will repair or replace the product, at our sole option, in the event of such a defect within the warranty period. This warranty does not cover damage resulting from unauthorized modifications, accident, misuse, or abuse.

In the event of a defect covered under this warranty, first, call the toll free number listed below. Many problems can be resolved in this manner. If necessary, you will be issued a return authorization (RA) number, and instructed on how to obtain a return form to be used to return the product to us, postage pre-paid and insured by the consumer to the address listed on the return form. When returning a defective product, please package the product, the return form with RA#, and a copy of the dated sales receipt as proof of purchase. If the product is returned without a dated sales receipt, it will be excluded from coverage under this warranty. Please allow 4 to 6 weeks for delivery of repaired or replacement vehicle depending on your location.

New Bright Industries liability for defects in material and workmanship under this warranty shall be limited to repair or replacement, at our sole option, and in no event shall we be responsible for incidental, consequential, or contingent damages (except in those states that do not allow this exclusion or limitation).

Valid only in U.S.A. and Canada

Contact New Bright Customer Service at  
Toll Free  
1-877-624-8697  
M-F 8:00AM to 5:00PM Eastern Time