

CAUTION-ELECTRICALLY OPERATED PRODUCT:
NOT RECOMMENDED FOR CHILDREN UNDER 8 YEARS OF AGE.
AS WITH ALL ELECTRIC PRODUCTS, PRECAUTIONS SHOULD BE
OBSERVED DURING HANDLING AND USE TO PREVENT ELECTRIC
SHOCK. INPUT: 120V AC 60Hz 6.5W. OUTPUT: 11.6V DC 165mA.

NEW BRIGHT

OWNER'S MANUAL

Please read and understand all precautions prior to use.

Thank you for choosing a premium New Bright product.

USA and Canada
30-day Limited Warranty

New Bright Industries warrants to the original purchaser that this product will be free of defects in materials and workmanship for thirty (30) days from the date of purchase. In the event of such a defect within the warranty period New Bright will repair or replace the product, at our sole discretion. This warranty does not cover damage resulting from unauthorized modifications, accident, misuse, or abuse.

Should your item have a defect covered under this warranty, first call the toll free number listed below. Most problems can be resolved in this manner. If necessary, you will be issued a return authorization (RA) number, and instructed on how to obtain a Product Return Form. The Product is to be used when returning product to us (postage pre-paid and insured by the consumer).

When returning a defective product, please package the product, the Product Return Form and a copy of the dated sales receipt as proof of purchase. Be sure to mark the RA number on the Product Return Form. If the product is returned without a dated sales receipt, it will be excluded from coverage under this warranty. Please allow 4 to 6 weeks for delivery of repaired or replacement vehicle (depending on your location).

New Bright Industries' liability for defects in material and workmanship under this warranty shall be limited to repair or replacement, at our sole discretion, and in no event shall we be responsible for incidental, consequential, or contingent damages (except in those states that do not allow this exclusion or limitation).

Valid only in U.S.A. and Canada

Contact New Bright Ind. Customer Service at
Toll Free
1-877-624-8697
M-F 8:00AM to 5:00PM Eastern Time

Transmitter

Features and Functions

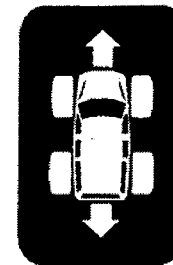

Forward/Reverse

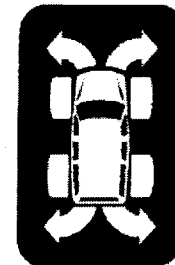

Left/Right Steering

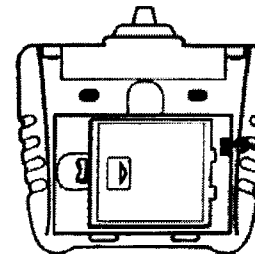
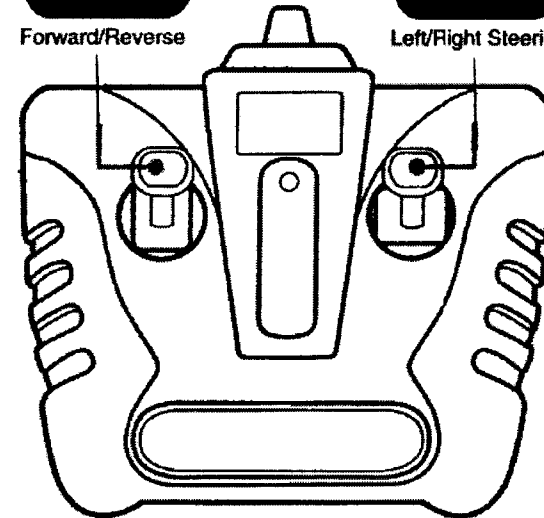

Demo Wire
Connection

This vehicle is shipped with a demo wire which runs from the transmitter to the vehicle chassis. The wire is for package demonstration only and should be removed and discarded.

New Bright

Table of Contents

1

- Section 1: Table of Contents
- Section 2: Component Checklist
- Section 3: Removing Demo Wire
- Section 4: Charging the Battery
- Section 5: Vehicle Battery Installation
- Section 6: Vehicle Features and Functions
- Section 7: Transmitter Battery Installation
- Section 8: Transmitter Features and Functions
- Section 9: Proper Use
Precautions and Care
- Section 10: Trouble Shooting and Support
- Section 11: Caution

New Bright

Component Checklist

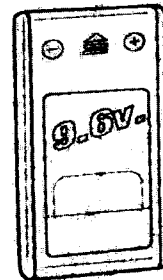
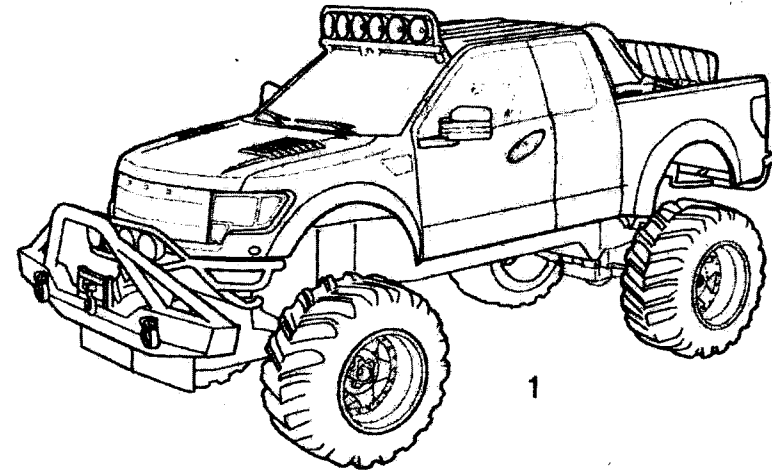

1

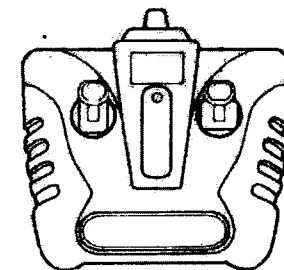
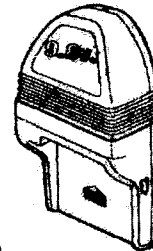

1

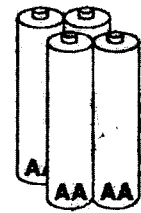

4

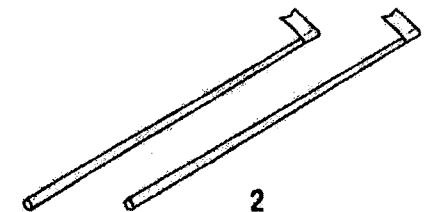

2

Battery

Charging the Battery

IMPORTANT

The included 9.6V NiMH battery pack is NOT charged prior to shipment and must be charged at least 8 hours before the first use.

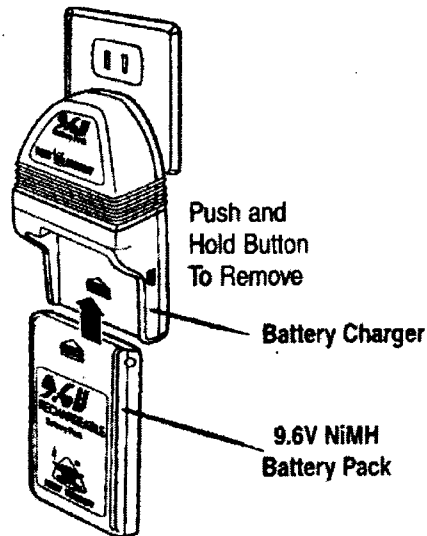

1. Plug the Charger into a standard indoor electrical outlet.
2. Insert the 9.6V NiMH rechargeable battery pack securely into the charging cradle (as shown above). Be sure the arrows are properly matched.
3. Allow battery to charge for a minimum of 8 hours on the initial two charges. Subsequent charges require only 4 hours.
4. Charge will last approximately 15 minutes depending on terrain and driving style.
5. This power unit is intended to be correctly orientated in a vertical or floor mount position.

IMPORTANT: It is normal for the battery pack to become warm after charging and/or use. Be sure to allow the battery pack to cool before using or recharging. Recharging a warm battery pack will greatly reduce the battery life.

Battery pack can be charged up to 1,000 times!

ATTENTION PARENTS:

- The Battery Charger & Battery Pack need to be periodically examined for potential hazards. Any potentially hazardous parts need to be repaired or replaced.

New Bright

Removing Demo Wire

This vehicle is shipped with a demo wire which runs from the transmitter to the vehicle chassis. The wire is for package demonstration only and should be removed and discarded as shown here.

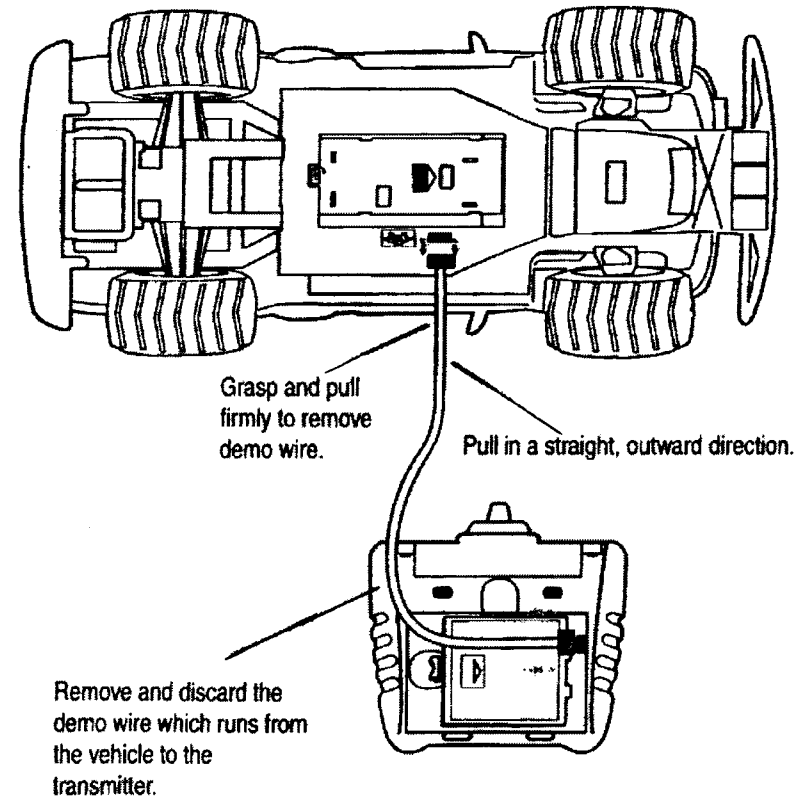

Vehicle

Features and Functions



ON/OFF
Switch

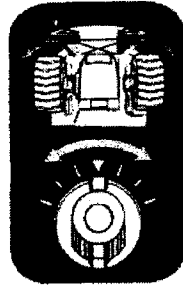

Wheel Alignment
(Steering Trim*)

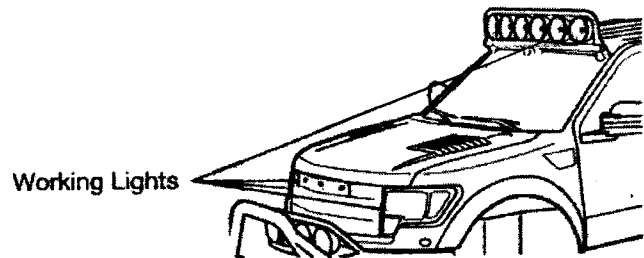
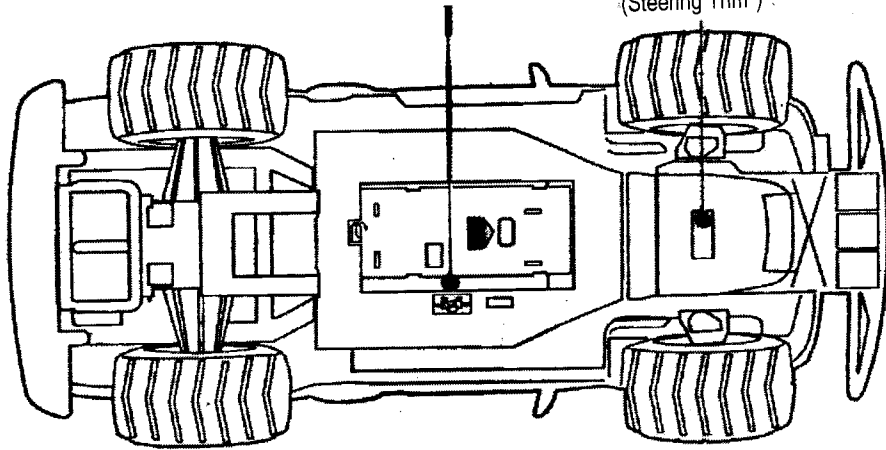

Working Lights

If vehicle pulls to the left or right during forward driving the Steering Trim may need to be adjusted. The Steering Trim is located on bottom of chassis between the front wheels.

Vehicle

Battery Installation

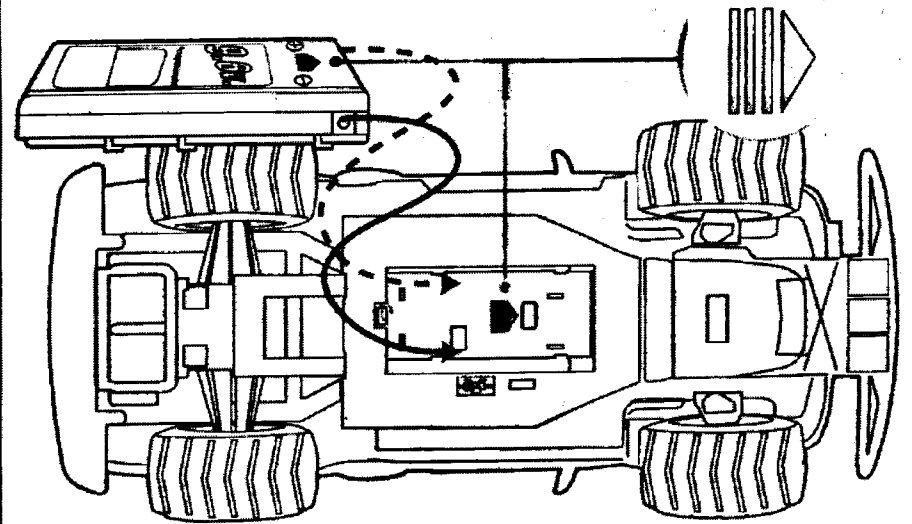

Locate and align arrow on battery pack with arrow inside battery compartment. Place battery pack in battery compartment and slide battery forward in direction of arrow. Once in place, turn locking tab to keep battery pack secure.

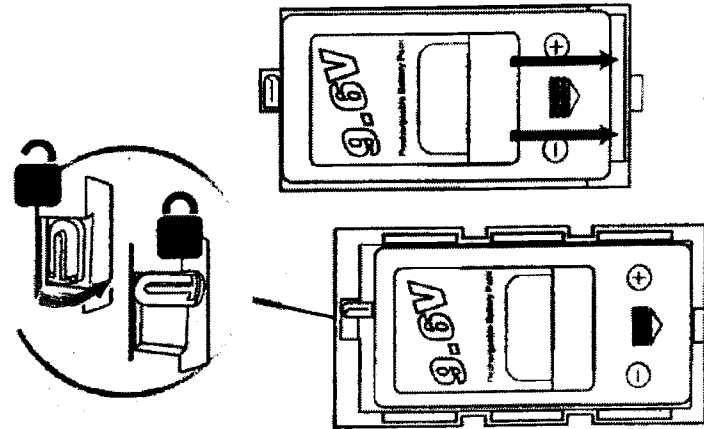

If battery pack is not completely in place locking tab will not fully turn.

Transmitter

Battery Installation

Press in TAB and pull back to open battery compartment cover.

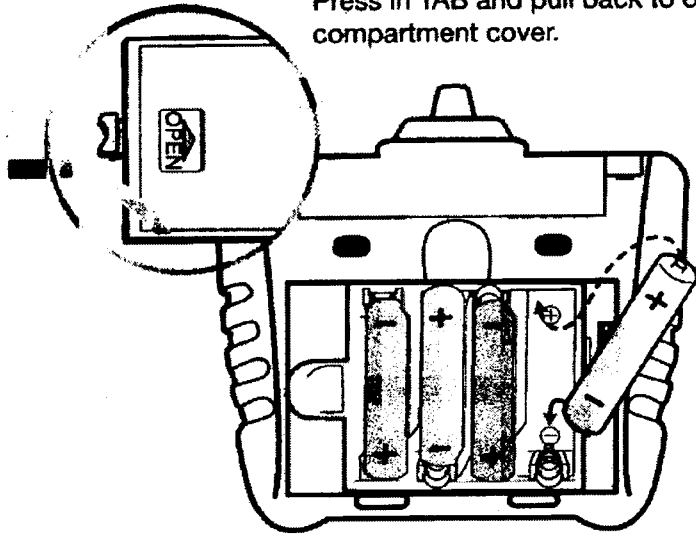

Install 4 "AA" batteries as shown, making sure (+) and (-) markings on batteries line up with the (+) and (-) markings in the battery compartment.

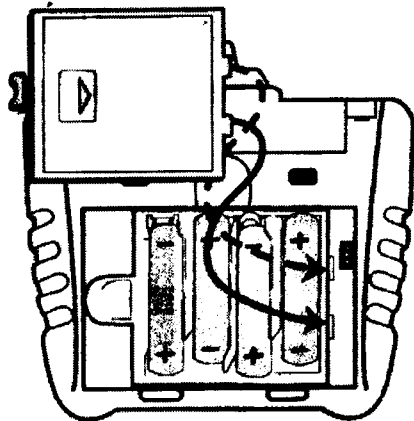

Close battery compartment cover. Cover should click when locked in place.

Proper Use

Precautions and Care

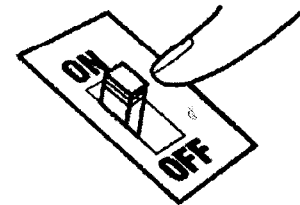
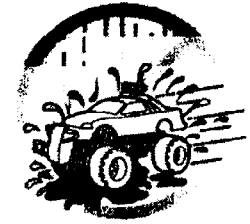
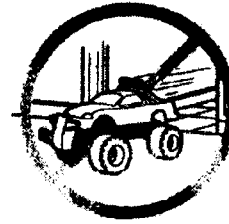
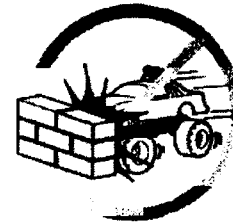
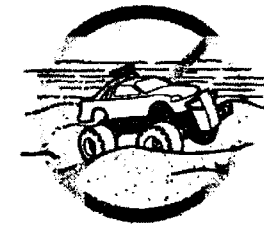
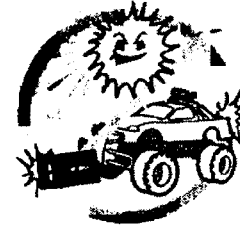

Switch vehicle OFF when not in use.

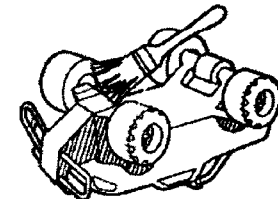

Brush areas where dirt gets trapped.

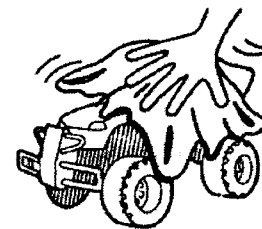

Wipe body with a soft rag or cloth.

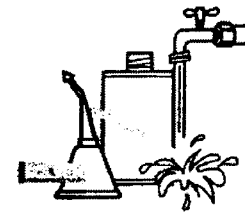

Do not use chemicals or water to clean

Support

Troubleshooting & Support

10

Problem - Vehicle does not move or moves slowly.

- Make certain there are fresh batteries in the transmitter and that they have been installed in the correct position.
- Are the (+) and (-) markings on the batteries in the same position as the (+) and (-) markings in the Transmitter Battery Compartment?
- Has the Battery Pack been installed in the vehicle?
- Has the rechargeable Battery Pack been fully charged?
- Are the (+) and (-) markings on the Battery Pack in the same position as the (+) and (-) markings in the Battery Compartment?
- Are the metal contact tabs touching, rusty or dirty in the transmitter?
- Make certain that the vehicle ON/OFF switch is in the "ON" position.

Problem - Vehicle moves by itself or exhibits reduced range from the transmitter.

- Make certain there is no outside radio interference in your area. The best way to test this is to take the vehicle as far away from radio towers, electrical lines or tall buildings as possible to ensure no further radio interference will occur.

FCC CAUTION:

The manufacturer is not responsible for radio interference caused by unauthorized frequency modification to this equipment. Such modifications could void the user's authority to operate the equipment.

NOTE: This equipment has been tested and found to comply with the limits for a Class B digital device, pursuant to Part 15 of the FCC Rules. These limits are designed to provide reasonable protection against harmful interference in a residential installation. This equipment generates, uses and can radiate radio frequency energy and, if not installed and used in accordance with the instructions, may cause harmful interference to radio communications. However, there is no guarantee that interference will not occur in a particular installation. If this equipment does cause harmful interference to radio or television reception, which can be determined by turning the equipment off and on, the user is encouraged to try to correct the interference by one or more of the following measures:

- Reorient or relocate the receiving antenna.
- Increase the separation between the equipment and receiver.
- Connect the equipment into an outlet on a circuit different from that to which the receiver is connected.
- Consult the dealer or an experienced radio/TV technician for help.

New Bright

Cautions

11

Do not recharge Battery Pack if it is hot or warm to the touch. Allow Battery Pack to cool before recharging. Recharging a hot or warm Battery Pack will shorten the life of the Pack.

Do not recharge a Battery Pack if it appears to be damaged or leaking.

Always unplug Charging Charger when not in use.

Always remove Battery Pack from Battery Compartment when not in use.

Do not dispose batteries in fire. Leakage, explosion and personal injury may occur.

Dispose of NiMH Battery Pack properly.

Do not attempt to disassemble Battery Pack or Charger.

Do not use Battery Charger for any use other than instructed in this booklet.

Only an adult should charge Batteries.

Do not attempt jumps or tricks with this vehicle.