



Radio Control Vehicle

OWNER'S MANUAL

Please read and understand all precautions prior to use.

Thank you for choosing a premium New Bright product.

USA & Canada
30-Day Limited Warranty

New Bright Industries warrants to the original purchaser that this product will be free of defects in materials and workmanship for thirty (30) days from the date of purchase. In the event of such defect within the warranty period, New Bright will repair or replace the product at our sole discretion. This warranty does not cover damage resulting from unauthorized modifications, accident, misuse or abuse.

Should your item have a defect covered under this warranty, first call the toll free number listed below. Most problems can be resolved in this manner. If necessary, you will be issued a Return Authorization number (RA) and instructions on how to obtain a Product Return Form. The Product Return Form is to be used when returning a product to us (postage pre-paid and insured by the consumer).

When returning a defective product, please package the product, the Product Return Form and a copy of the dated sales receipt as proof of purchase. Be sure to mark the RA number on the Product Return Form. If the product is returned without a dated sales receipt, it will be excluded from coverage under this warranty. Please allow 4 to 6 weeks for delivery of repaired or replacement vehicles (depending on your location).

New Bright Industries' liability for defects in materials and workmanship under this warranty shall be limited to repair or replacement at our sole discretion. In no event shall we be responsible for incidental, consequential or contingent damages (except in those states that do not allow this exclusion or limitation).

Valid only in the USA & Canada.

Contact New Bright Industries Customer Service Toll Free at:
1-877-NBI-TOYS
(1-877-624-8697)

Monday through Friday, 8:00 AM to 5:00 PM Eastern Time

L849101277/JN208-09

Table of Contents

- Page 1: Table of Contents**
- Page 2: Component Checklist**
- Page 3: Vehicle Battery Installation**
- Page 4: Vehicle Features
Vehicle Antenna Placement**
- Page 5: Transmitter Features**
- Page 6: Proper Use
Precautions and Care**
- Page 7: Trouble Shooting and Support**

Component Checklist

- **(1) Vehicle**
- **(1) Transmitter**
- **(2) Antenna Tube**

Vehicle

Battery Installation

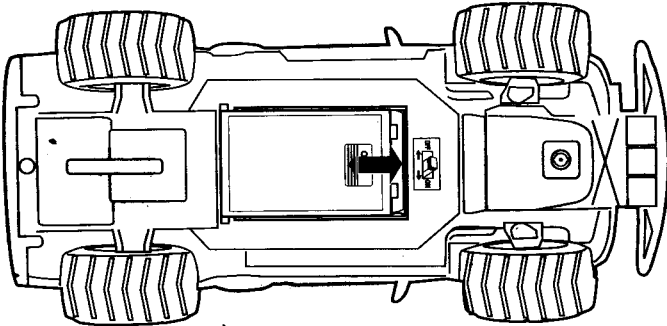
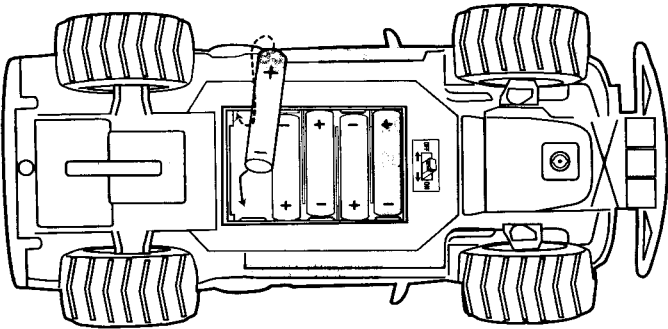
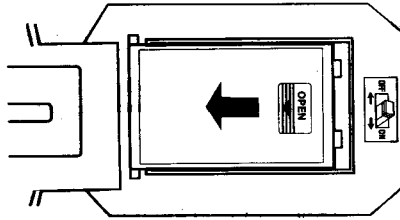

Note: When replacing batteries:
Use (alkaline) batteries only.
Do not mix old and new batteries.
Do not mix alkaline, standard or rechargeable batteries.

Vehicle

Features and Functions



ON/OFF Switch



Steering Trim*

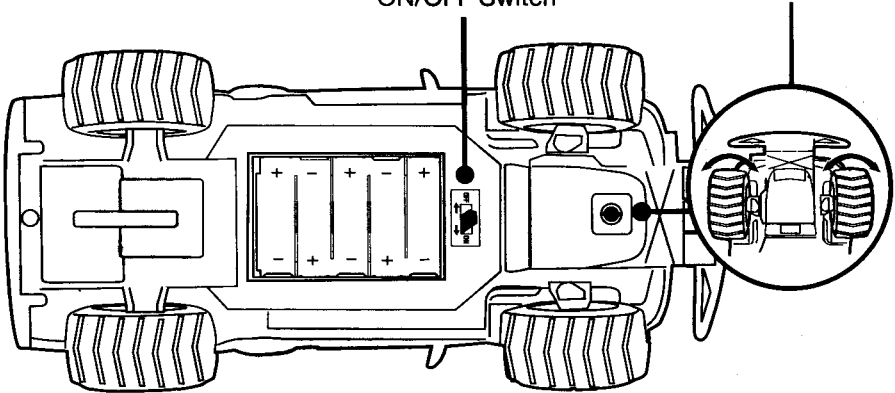

* If vehicle pulls to the left or right during forward driving the Steering Trim may need to be adjusted. The Steering Trim is located on bottom of chassis between the front wheels.

Vehicle

Antenna Placement

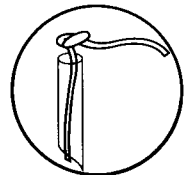
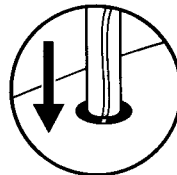
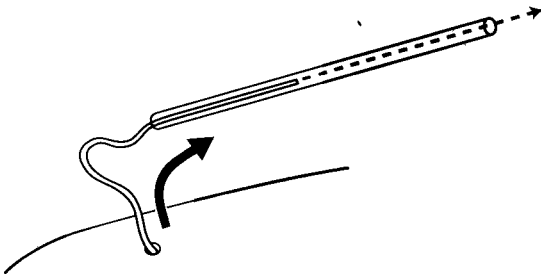

Features and Functions

1. Press “ ▲ “ button for forward drive.
2. Press “ ▼ “ button for backward drive.
3. Press “ ◀ “ button to turn left.
4. Press “ ▶ “ button to turn right.
5. When the controller is out of control, insert the plug of the recharging cable (on the vehicle) into the charging socket on the controller. Make sure 5 AA alkaline batteries are inserted into the battery compartment on the vehicle.

Proper Use

Precautions and Care

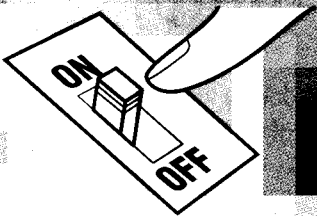
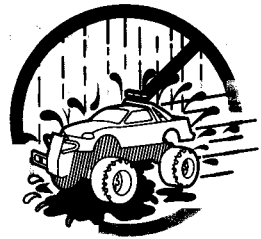
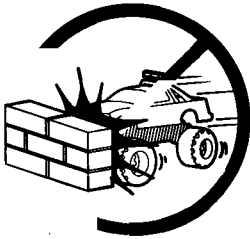
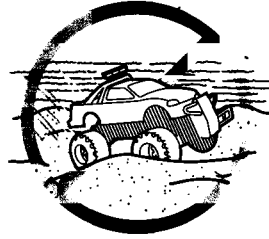

Switch vehicle OFF
when not in use.

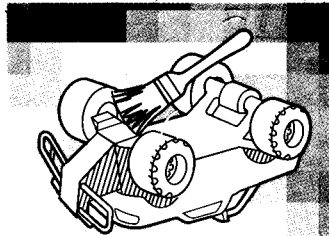

Brush areas where
dirt gets trapped.

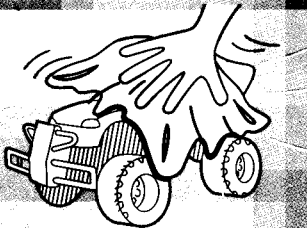

Wipe body with a
soft rag or tact cloth.

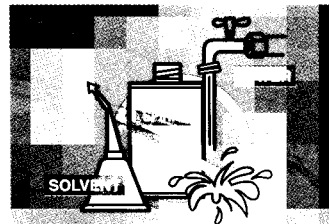

Do not use chemicals
or water to clean

Trouble Shooting

Problem - Vehicle does not move or moves slowly.

- Make certain there are fresh alkaline batteries in the transmitter and that they have been installed in the correct position.
- Are the (+) and (-) markings on the alkaline batteries in the same position as the (+) and (-) markings in the Transmitter Battery Compartment?
- Has the Batteries been installed in the vehicle?
- Are the metal contact tabs touching, rusty or dirty in the transmitter?
- Make certain that the vehicle ON/OFF switch is in the "ON" position.

Problem - Vehicle moves by itself or exhibits reduced range from the transmitter.

- Make certain there is no outside radio interference in your area. The best way to test this is to take the vehicle as far away from radio towers, electrical lines or tall buildings as possible to ensure no further radio interference will occur.

Always remove Batteries from Battery Compartment when not in use.

Do not dispose batteries in fire. Leakage, explosion and personal injury may occur.

Do not attempt jumps or tricks with this vehicle.

FCC CAUTION:

The manufacturer is not responsible for radio interference caused by unauthorized frequency modification to this equipment. Such modifications could void the user's authority to operate the equipment.

NOTE: This equipment has been tested and found to comply with the limits for a Class B digital device, pursuant to Part 15 of the FCC Rules. These limits are designed to provide reasonable protection against harmful interference in a residential installation. This equipment generates, uses and can radiate radio frequency energy and, if not installed and used in accordance with the instructions, may cause harmful interference to radio communications. However, there is no guarantee that interference will not occur in a particular installation. If this equipment does cause harmful interference to radio or television reception, which can be determined by turning the equipment off and on, the user is encouraged to try to correct the interference by one or more of the following measures:

- Reorient or relocate the receiving antenna.
- Increase the separation between the equipment and receiver.
- Connect the equipment into an outlet on a circuit different from that to which the receiver is connected.
- Consult the dealer or an experienced radio/TV technician for help.