

CAUTION-ELECTRICALLY OPERATED PRODUCT:
NOT RECOMMENDED FOR CHILDREN UNDER 8 YEARS OF AGE. AS WITH ALL ELECTRIC PRODUCTS, PRECAUTIONS SHOULD BE OBSERVED DURING HANDLING AND USE TO PREVENT ELECTRIC SHOCK.
INPUT: 120V AC 60Hz 10W. OUTPUT: 14.4V DC 500mA.

NEW BRIGHT

OWNER'S MANUAL

Please read and understand all precautions prior to use.

Model / Modèle No GF3725H (Remote), GF3725A (Car)

Thank you for choosing a premium New Bright product.

USA & Canada
30-Day Limited Warranty

New Bright Industries warrants to the original purchaser that this product will be free of defects in materials and workmanship for thirty (30) days from the date of purchase. In the event of such defect within the warranty period, New Bright will repair or replace the product at our sole discretion. This warranty does not cover damage resulting from unauthorized modifications, accident, misuse, or abuse.

Should your item have a defect covered under this warranty, first call the toll free number listed below. Most problems can be resolved in this manner. If necessary, you will be issued a Return Authorization (RA) number and instructions on how to obtain a Product Return Form. The Product Return Form is to be used when returning a product to us (postage pre-paid and insured by the consumer).

When returning a defective product, please package the product, the Product Return Form and a copy of the dated sales receipt as proof of purchase. Be sure to mark the RA number on the Product Return Form. If the product is returned without a dated sales receipt, it will be excluded from coverage under this warranty. Please allow 4 to 6 weeks for delivery of repaired or replacement vehicles (depending on your location).

New Bright Industries' liability for defects in materials and workmanship under this warranty shall be limited to repair or replacement at our sole discretion. In no event shall we be responsible for incidental, consequential or contingent damages (except in those states that do not allow this exclusion or limitation).

Valid only in the USA & Canada.

Contact New Bright Industries Customer Service Toll Free at:
1-877-NBI-TOYS
(1-877-624-8697)
Monday through Friday, 8:00 AM to 5:00 PM Eastern Time

L575112846/JN120-16

WHAT'S INCLUDED

Component Checklist

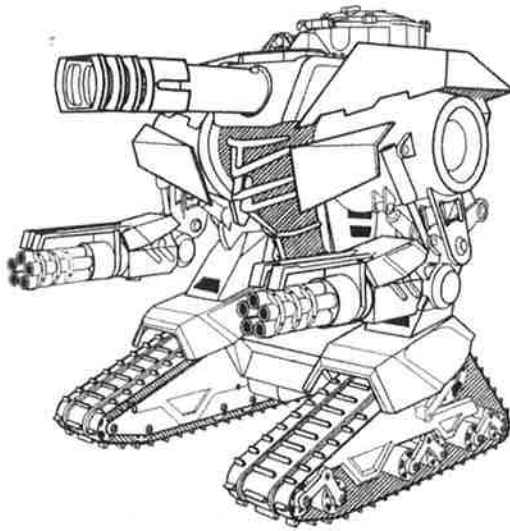

(1) R/C M.E.C.H. Robo Cannon

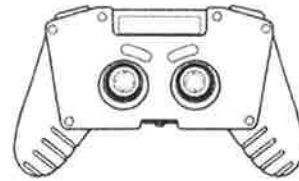

(1) Transmitter



(60) 1" Foam Balls



(1) 12.8V Battery Pack

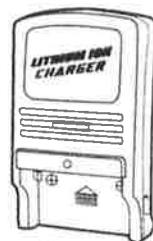

(1) Battery Charger



(2) "AA" Batteries

TRANSMITTER

Battery Installation

1. To open battery compartment cover on transmitter, slide in the direction indicated by the arrow.
2. Insert 2 "AA" size batteries.
Make sure the positive (+) and negative (-) markings on the batteries match up to the ones inside the Battery Compartment.

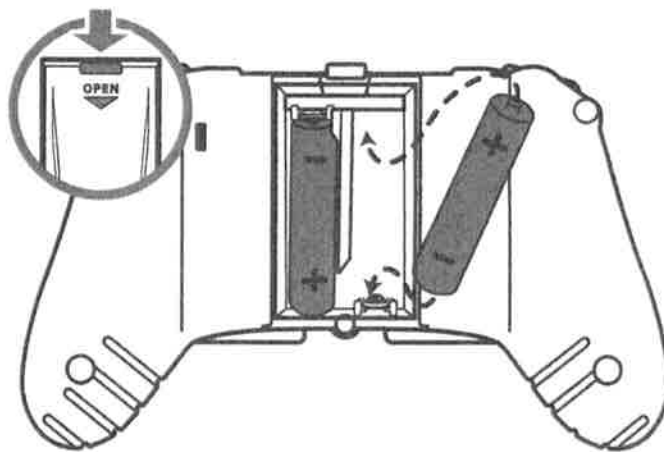

3. Replace the Battery Compartment Cover making certain that the Compartment tab has "snapped" into the locked position.



Note: When replacing Transmitter batteries:
Do not mix old and new batteries.
Do not mix alkaline, standard or rechargeable batteries.
Use alkaline batteries only.

TRANSMITTER

Functions

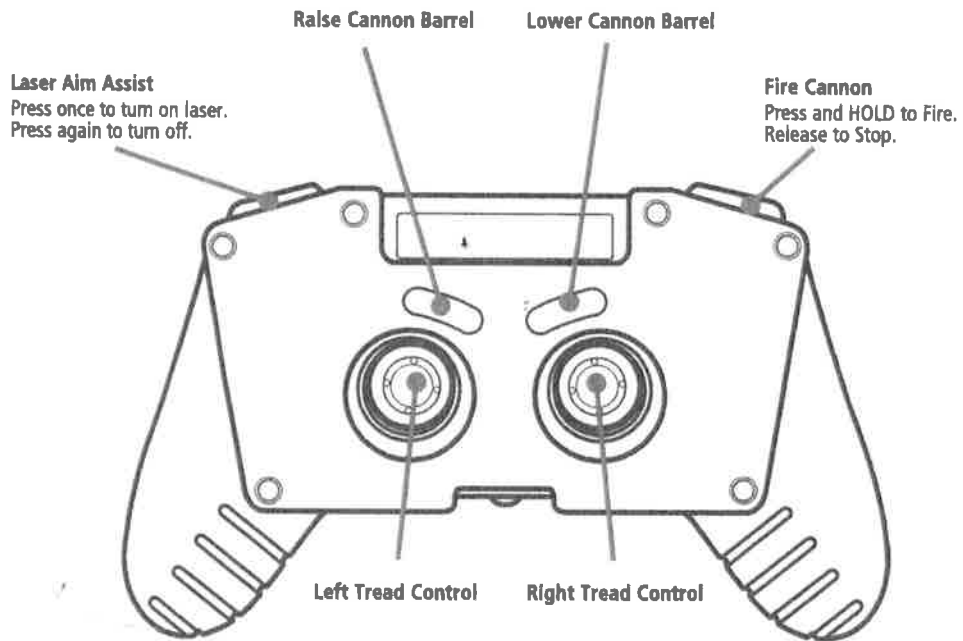

Syncing

This transmitter is equipped with 2.4GHz technology which allows up to 12 MECH vehicles to be used at the same time.

To sync transmitter and MECH vehicle, follow these steps:

1. Install batteries in Transmitter.
2. Install battery in MECH Vehicle.
3. Turn on MECH Vehicle.

Once the batteries are installed and the vehicle is turned on, the Transmitter will sync automatically with the vehicle.

HOW TO DRIVE

Using the Transmitter

FORWARD AND REVERSE DRIVING

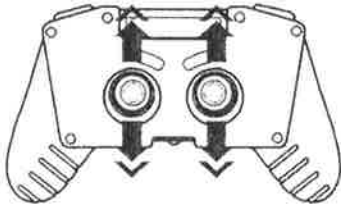

FORWARD DRIVING

Push **BOTH** joysticks forward for Forward Driving.



REVERSE DRIVING

Pull **BOTH** joysticks backward for Reverse Driving.

TURNING

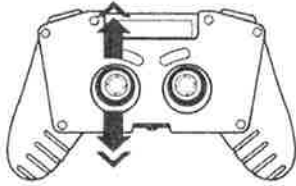

RIGHT TURNING

Push **RIGHT** joystick forward to turn left while driving forward. Pull **RIGHT** joystick back to turn left in reverse.

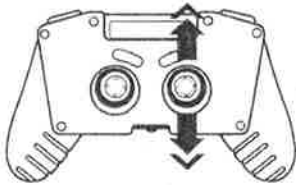

LEFT TURNING

Push **LEFT** joystick forward to turn right while driving forward. Pull **LEFT** joystick back to turn right in reverse.

SPINS

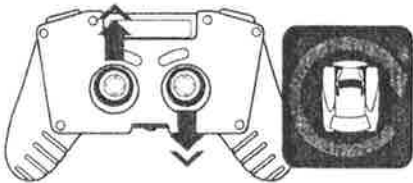

360° SPINS - Clockwise
Push joysticks as shown for Clockwise Spinning.

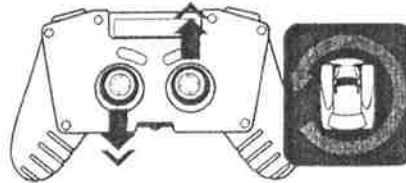

360° SPINS - Counter-Clockwise
Push joysticks as shown for Counter-Clockwise Spinning.

Battery Pack

Charging the Battery

IMPORTANT!

The included 12.8V Lithium Ion battery pack is only **PARTIALLY CHARGED** prior to shipment and it is recommended the battery be fully charged before first use.

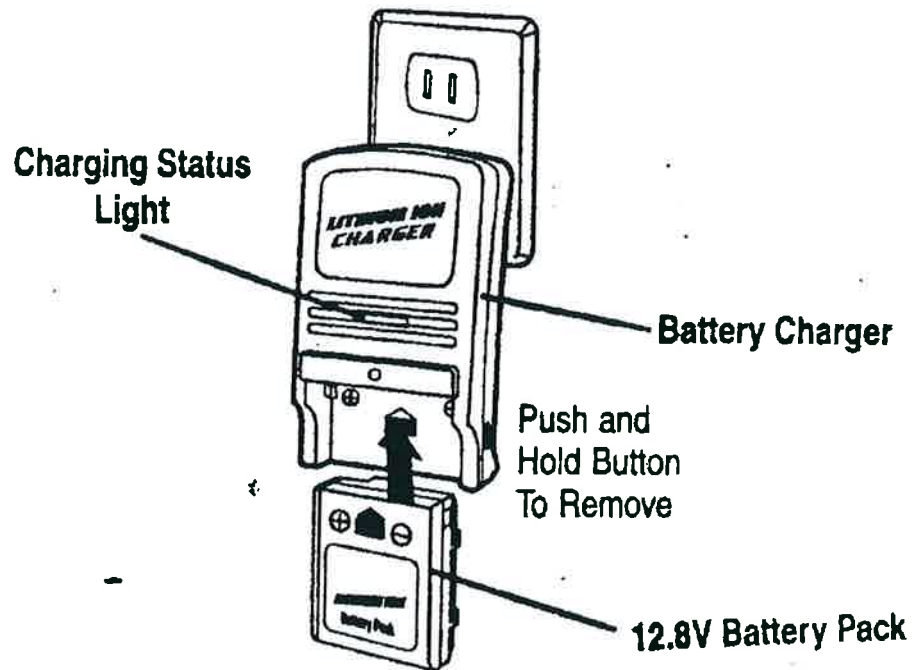

1. Insert the 12.8V Lithium Ion rechargeable battery pack securely into the charger and push up to lock. Be sure the arrows are properly matched (as shown above).
2. Plug the Charger into a standard indoor electrical outlet. This power unit is intended to be correctly orientated in a vertical or wall mount position.
3. *ALLOW battery to charge for 1 hour* Charging Status Light will be solid red while battery is charging. When charging is complete, light will blink green.
4. To remove the battery, press and hold the release button and slide battery down to unlock.
5. Charge will last approximately 12 minutes depending on terrain and driving style.

IMPORTANT: It is normal for the battery pack to become warm after charging and/or use. Be sure to allow the battery pack to cool before using or recharging. Recharging a warm battery pack will greatly reduce the battery life.

ATTENTION PARENTS:

- The Battery Charger & Battery Pack need to be periodically examined for potential hazards. Any potentially hazardous parts need to be repaired or replaced.

VEHICLE

Battery Installation

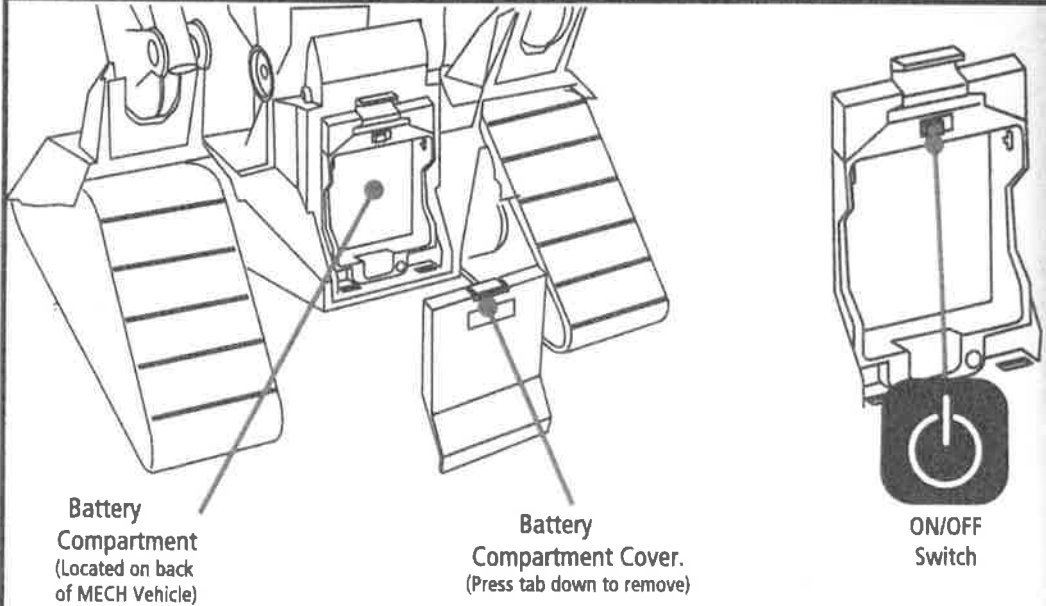

1. Locate the battery compartment on the back of MECH vehicle. Press the tab on the top of the compartment cover downward to remove.
2. Align arrow on battery pack with arrow inside battery compartment. Place battery pack in battery compartment and slide battery upward in direction of arrow. Once in place, turn locking tab to keep battery pack secure.



3. Replace the Battery Compartment Cover making certain that the tab has "snapped" into the locked position. Note: MECH vehicle can operate normally without the compartment cover.
4. Move the ON/OFF switch to the ON position for operation.

VEHICLE

Reloading the Hopper

Locate the hopper on the top of the MECH vehicle. Open lid as shown. To reload, place 2 foam balls into each slot in the hopper. A total of 20 balls can be loaded at once. Hopper lid must be fully closed to resume firing.

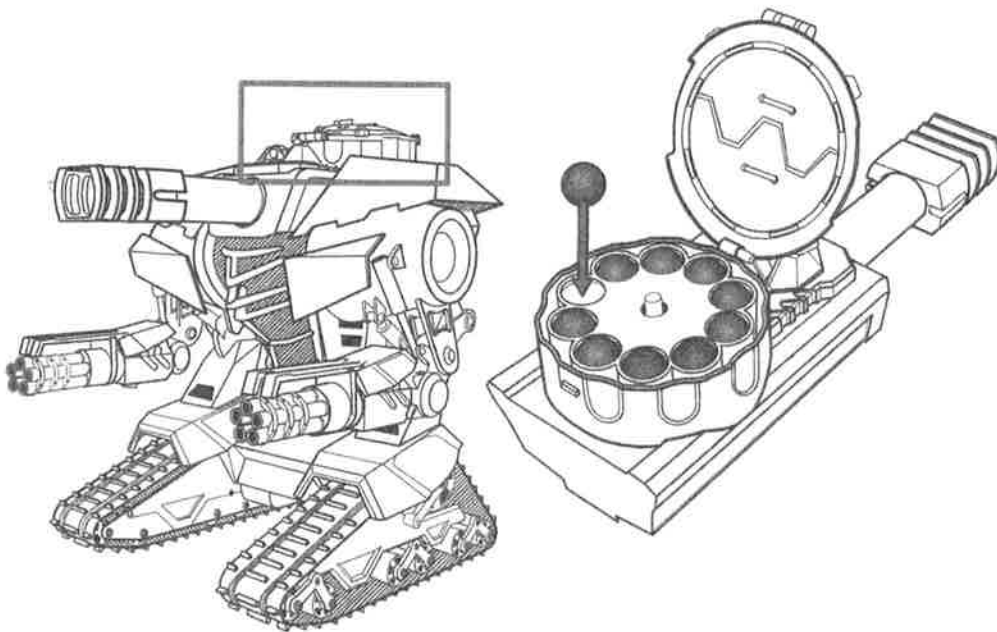

FOAM BALLS

Do not attempt to load objects into the hopper other than the supplied NEW BRIGHT foam balls.

Keep foam balls away from small childer to avoid the possibility of choking.

90% of all difficulties experienced with radio controlled vehicles are due to either weak batteries or batteries that have been installed incorrectly. When batteries become weak, the vehicle may not necessarily stop completely but may exhibit slow response, slow speed or erratic behavior.

Problem - Vehicle does not move or moves slowly.

- Make certain there are fresh alkaline batteries in the transmitter and that they have been installed in the correct position.
- Are the (+) and (-) markings on the alkaline batteries in the same position as the (+) and (-) markings in the Transmitter Battery Compartment?
- Has the Battery Pack been installed in the vehicle?
- Has the rechargeable Battery Pack been fully charged?
- Are the (+) and (-) markings on the Battery Pack in the same position as the (+) and (-) markings in the Battery Compartment?
- Are the metal contact tabs touching, rusty or dirty in the transmitter?
- Make certain that the vehicle ON/OFF switch is in the "ON" position.

Problem - Vehicle moves by itself or exhibits reduced range from the transmitter.

- Make certain there is no outside radio interference in your area. The best way to test this is to take the vehicle as far away from radio towers, electrical lines or tall buildings as possible to ensure no further radio interference will occur.

Do not recharge Battery Pack if it is hot or warm to the touch. Allow Battery Pack to cool before recharging. Recharging a hot or warm Battery Pack will shorten the life of the Pack.

Do not recharge a Battery Pack if it appears to be damaged or leaking.

Always unplug Charger when not in use.

Always remove Battery Pack from Battery Compartment when not in use.

Do not dispose batteries in fire. Leakage, explosion and personal injury may occur.

Dispose of Rechargeable Battery Pack properly.

Do not attempt to disassemble Battery Pack or Charger.

Do not use Battery Charger for any use other than instructed in this booklet.

Only an adult should charge Batteries.

Do not attempt jumps or tricks with this vehicle.

SAFETY

Before you Begin

THINK SAFETY FIRST!

- This product is recommended for ages 14 and up.
- Always point your MECH Robocannon in a safe direction.
- Keep foam balls away from small children.
- Keep radio control transmitter away from anyone under 14 years old.
- Wear proper eye protection when playing with MECH Robocannon as foam balls can bounce back at a high rate of speed.
- When using MECH Robocannon, make sure everyone within 100 feet is aware of what you are operating.

NOTE: This equipment has been tested and found to comply with the limits for a Class B digital device, pursuant to Part 15 of the FCC Rules. These limits are designed to provide reasonable protection against harmful interference in a residential installation. This equipment generates, uses and can radiate radio frequency energy and, if not installed and used in accordance with the instructions, may cause harmful interference to radio communications. However, there is no guarantee that interference will not occur in a particular installation. If this equipment does cause harmful interference to radio or television reception, which can be determined by turning the equipment off and on, the user is encouraged to try to correct the interference by one or more of the following measures:

- Reorient or relocate the receiving antenna.
- Increase the separation between the equipment and receiver.
- Connect the equipment into an outlet on a circuit different from that to which the receiver is connected.
- Consult the dealer or an experienced radio/TV technician for help.

FCC CAUTION:

Changes or modification not expressly approved by the party responsible for compliance could void the user's authority to operate the equipment.

FCC



RSS Statement

This device complies with Industry Canada licence-exempt RSS standard(s). Operation is subject to the following two conditions: (1) this device may not cause interference, and (2) this device must accept any interference, including interference that may cause undesired operation of the device.

Le présent appareil est conforme aux CNR d'Industrie Canada applicables aux appareils radio exempts de licence. L'exploitation est autorisée aux deux conditions suivantes : (1) l'appareil ne doit pas produire de brouillage, et (2) l'utilisateur de l'appareil doit accepter tout brouillage radioélectrique subi, même si le brouillage est susceptible d'en compromettre le fonctionnement.

Proper Use

Precautions and Care



Switch vehicle OFF
when not in use.

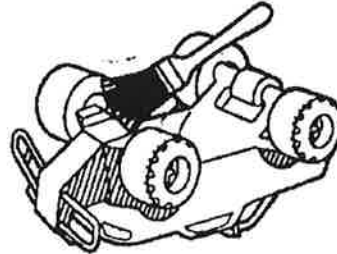

Brush areas where
dirt gets trapped.



Wipe body with a
soft rag or cloth.

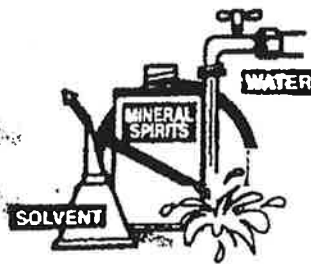

Do not use chemicals
or water to clean

Warranty Information**USA & Canada
30-Day Limited Warranty**

New Bright Industries warrants to the original purchaser that this product will be free of defects in materials and workmanship for thirty (30) days from the date of purchase. In the event of such defect within the warranty period, New Bright will repair or replace the product at our sole discretion. This warranty does not cover damage resulting from unauthorized modifications, accident, misuse or abuse.

Should your item have a defect covered under this warranty, first call the toll free number listed below. Most problems can be resolved in this manner. If necessary, you will be issued a Return Authorization number (RA) and instructions on how to obtain a Product Return Form. The Product Return Form is to be used when returning a product to us (postage pre-paid and insured by the consumer).

When returning a defective product, please package the product, the Product Return Form and a copy of the dated sales receipt as proof of purchase. Be sure to mark the RA number on the Product Return Form. If the product is returned without a dated sales receipt, it will be excluded from coverage under this warranty. Please allow 4 to 6 weeks for delivery of repaired or replacement vehicles (depending on your location).

New Bright Industries' liability for defects in materials and workmanship under this warranty shall be limited to repair or replacement at our sole discretion. In no event shall we be responsible for incidental, consequential or contingent damages (except in those states that do not allow this exclusion or limitation).

Valid only in the USA & Canada.

Contact New Bright Industries Customer Service Toll Free at:

1-877-NBI-TOYS

(1-877-624-8697)

Monday through Friday, 8:00 AM to 5:00 PM Eastern Time

FCC CAUTION:

Changes of modifications not expressly approved by the party responsible for compliance could void the user's authority to operate the equipment

NOTE: This equipment has been tested and found to comply with the limits for a Class B digital device, pursuant to Part 15 of the FCC Rules. These limits are designed to provide reasonable protection against harmful interference in a residential installation. This equipment generates, uses and can radiate radio frequency energy and, if not installed and used in accordance with the instructions, may cause harmful interference to radio communications. However, there is no guarantee that interference will not occur in a particular installation. If this equipment does cause harmful interference to radio or television reception, which can be determined by turning the equipment off and on, the user is encouraged to try to correct the interference by one or more of the following measures:

- Reorient or relocate the receiving antenna.
- Increase the separation between the equipment and receiver.
- Connect the equipment into an outlet on a circuit different from that to which the receiver is connected.
- Consult the dealer or an experienced radio/TV technician for help.