

THIS TOY SHOULD BE ASSEMBLED PROPERLY BY AN ADULT BEFORE USE

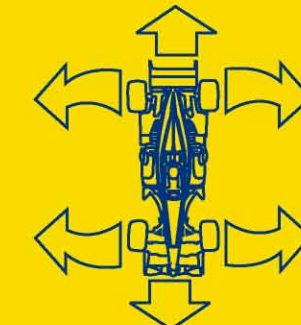

RENAULT F1 Team

RENAULT F1 Team

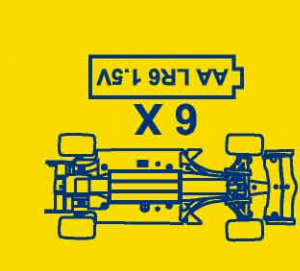
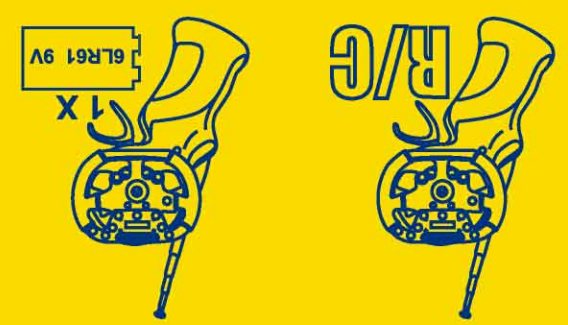
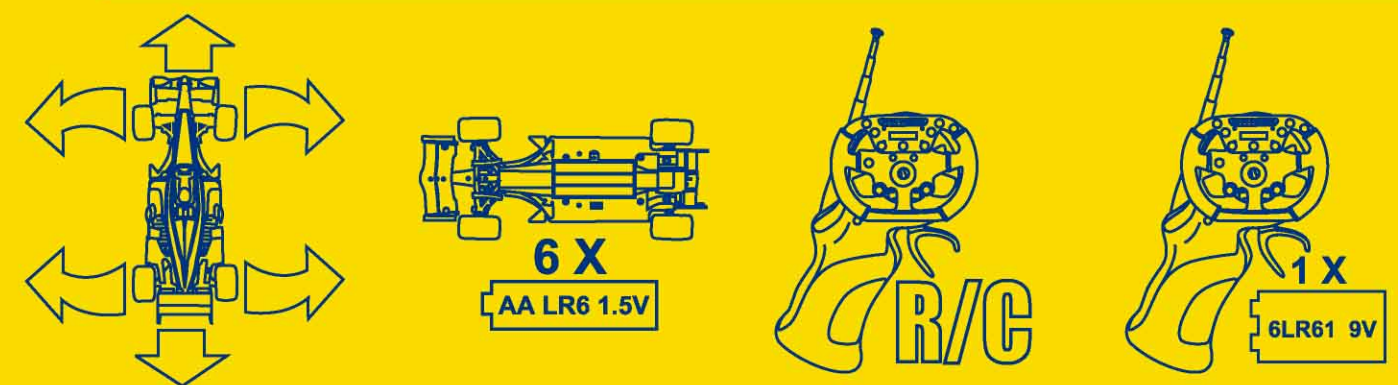
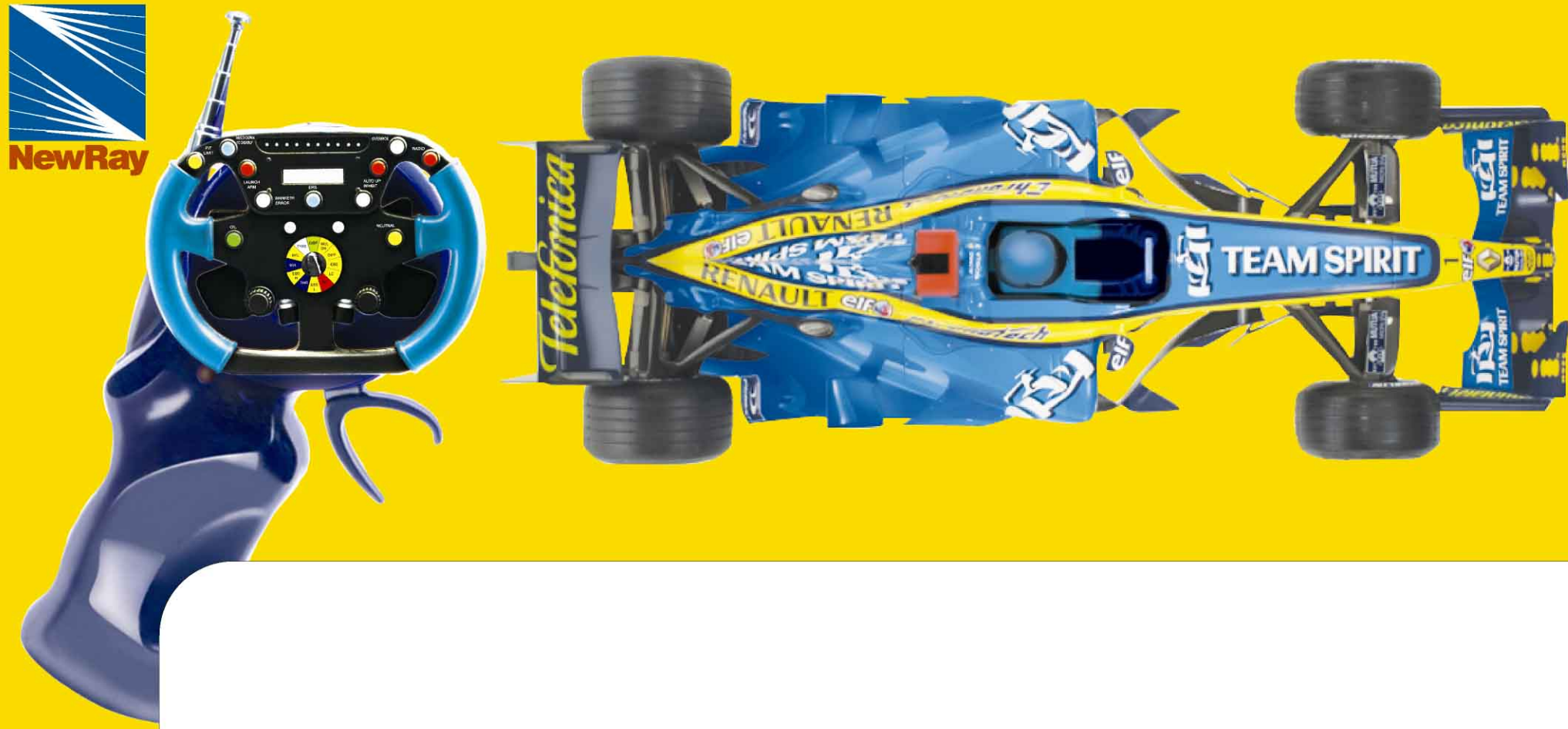

NewRay

NewRay



NewRay

RENAULT F1 Team

RENAULT F1 Team



1:12

RENAULT F1 Team

**WARNING:** **CHOKING HAZARD**-Small parts  
Not for children under 3 years

**ATTENTION:** **Risque de suffocation** si avalé,  
contient de petites pièces, détachables  
non adaptée a pour les enfants de moins de 3 ans.

NOT SUITABLE FOR CHILDREN UNDER 3 YEARS OLD DUE TO SMALL SIZE OF COMPONENTS  
NE CONVIENT PAS A UN ENFANT DE MOINS DE 36 MOIS: PRÉSENCE DE PETITS ÉLÉMENTS DÉTACHABLES PROUVANT ÊTRE AVALÉS  
NON ADATTO A BAMBINI INFERIORI AI 3 ANNI DI ETÀ PERCHÉ CONTIENE PICCOLE PARTI  
NIET GESCHIKT VOOR KINDEREN ONDER DE 3 JAAR WEGENS KLEINE ONDERDELEN  
NICHT VOOR KINDER ONTER 3 JAHREN WEGEN KLEINER BESTANDTEILE  
NO RECOMENDADO PARA NIÑOS MENORES DE 3 AÑOS DEBIDO A LOS COMPONENTES DE PEQUEÑO TAMAÑO  
NÃO RECOMENDAVEL A CRIANÇAS COM MENOS DE 3 ANOS DEVIDO AO TAMAÑO REDUZIDO DOS COMPONENTES  
HRS ANDEFALET TIL BRUG UNDER TRE ÅR PÅ GRUND AF KOMPONENTERNES LILLE STØRRELSE

THE PACKAGING HAS TO BE KEPT SINCE IT CONTAINS IMPORTANT INFORMATION. GARDEZ L'EMBALLAGE CAR IL CONTIENT D'IMPORTANTES INFORMATIONS.  
CONSERVARE LA CONFEZIONE PER FUTURE RIFERENZE.  
BEMERK DE VERPAKKING, WANT ZE BEVAT BELANGRIJKE INFORMATIE.  
DIE VERPAKKUNG SOLLTE AUFWAHRT WERDEN, DA SIE WICHTIGE INFORMATION ENHÄLT.  
GUARDE EL EMBALAJE QUE MANTIENE INFORMACIONES IMPORTANTES.  
A EMBALAGEM DEVE SER CONSERVADA POIS POSSUI INFORMAÇÕES IMPORTANTES  
INDIPAKNINGEN SKAL GEMMES, EFTERSOM DEN INDEHOLDER VIKTIGE OPLYSNINGER.

THE RIGHT IS RESERVED TO IMPROVE OR AMEND SPECIFICATION & COLOR  
LE DROIT DE CHANGER OU D'AMÉLIORER LES SPÉCIFICATIONS ET COULEURS EST RÉSERVÉ À LA FABRICANT  
DIRETTO DI RISERVARSI A MIGLIORARE O CAMBIARE COLORE E DESCRIZIONE DELL'ARTICOLO  
NIET RECHT IS VOORRESHOUDEN OM KLEUREN EN SPECIFICATIE TE VERBETTEREN OF TE WIJZIGEN.  
DEN HESTILLER BEHÅLT SIGE VOR, FARBE UND AUSSTATTUNG ZU VERBESSERN ODER ÄNDERN  
TODOS LOS DERECHOS ESTÁN RESERVADOS CON EL FIN DE MEJORAR O RECTIFICAR, AL IGUAL QUE LOS COLORES  
RESERVADO O DIREITO DE MELHORAR OU ALTERAR ESPECIFICAÇÕES E COR  
VI FÖRBEHÅLLER OS RÄTTEN TIL FÖRBEDE ELLER BETT. SPECIFIKATIONEN OG FARVE.

1:12 SCALE  
ECHELLE 1:12  
SCALA 1:12  
1:12 SCHAAL  
MASSSTAB 1:12  
ESCALA 1:12  
À ESCALA DE 1:12  
1:12 SKALA

MADE IN CHINA  
FABRIQUE EN CHINE  
FABBRICATO IN CHINA  
GEFABRICEDD IN CHINA  
HERGESTELLT IN CHINA  
FABRICADO NA CHINA  
FABRICADO NA CHINA  
FREMSTILLET I KINA

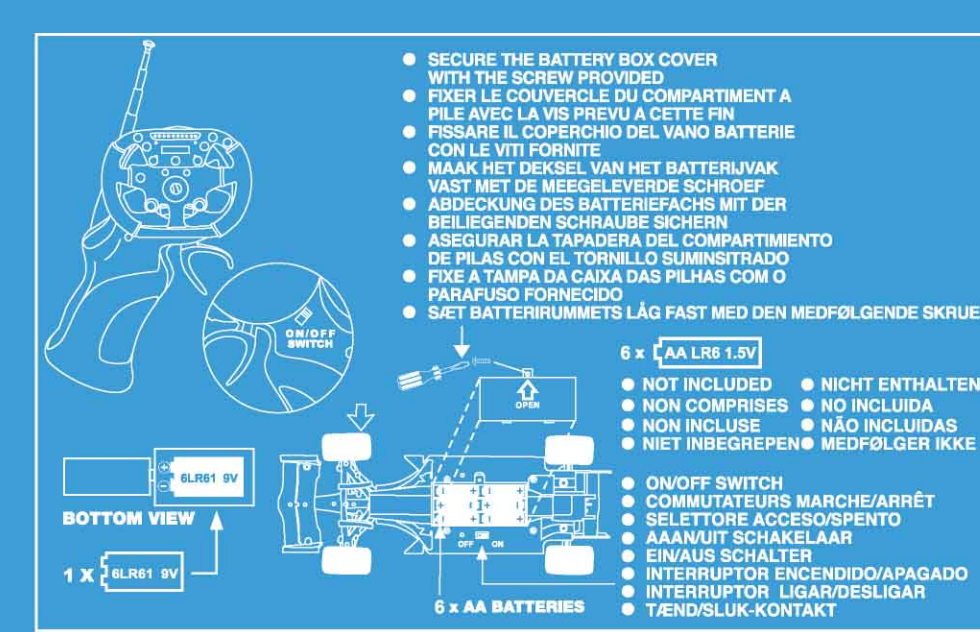

**Instructions for battery operated toys**  
1) Batteries should only be inserted or changed by an adult.  
2) Switch the toys to the "off" position before inserting batteries.  
3) Insert batteries correctly in the manner shown elsewhere on the toy or packaging.  
4) Only use the same type of battery—do not mix brands or types.  
5) Replace all batteries at the same time with new ones.  
6) Do not mix old and new batteries.  
7) Do not leave batteries in the toy for long periods of time when it is not in use.  
8) Do not use recharged batteries.  
9) Remove exhausted batteries from the toy.  
10) Dispose of used batteries safely—do not throw on a fire or attempt to open up the outer case.  
11) At all times keep small batteries which could be a choking hazard to children out of their reach.  
Batteries are harmful if swallowed.  
12) Seek medical advice if a small battery has been swallowed by a child.  
13) Non-rechargeable batteries are not to be recharged.  
14) The supply terminals are not to be short-circuited.

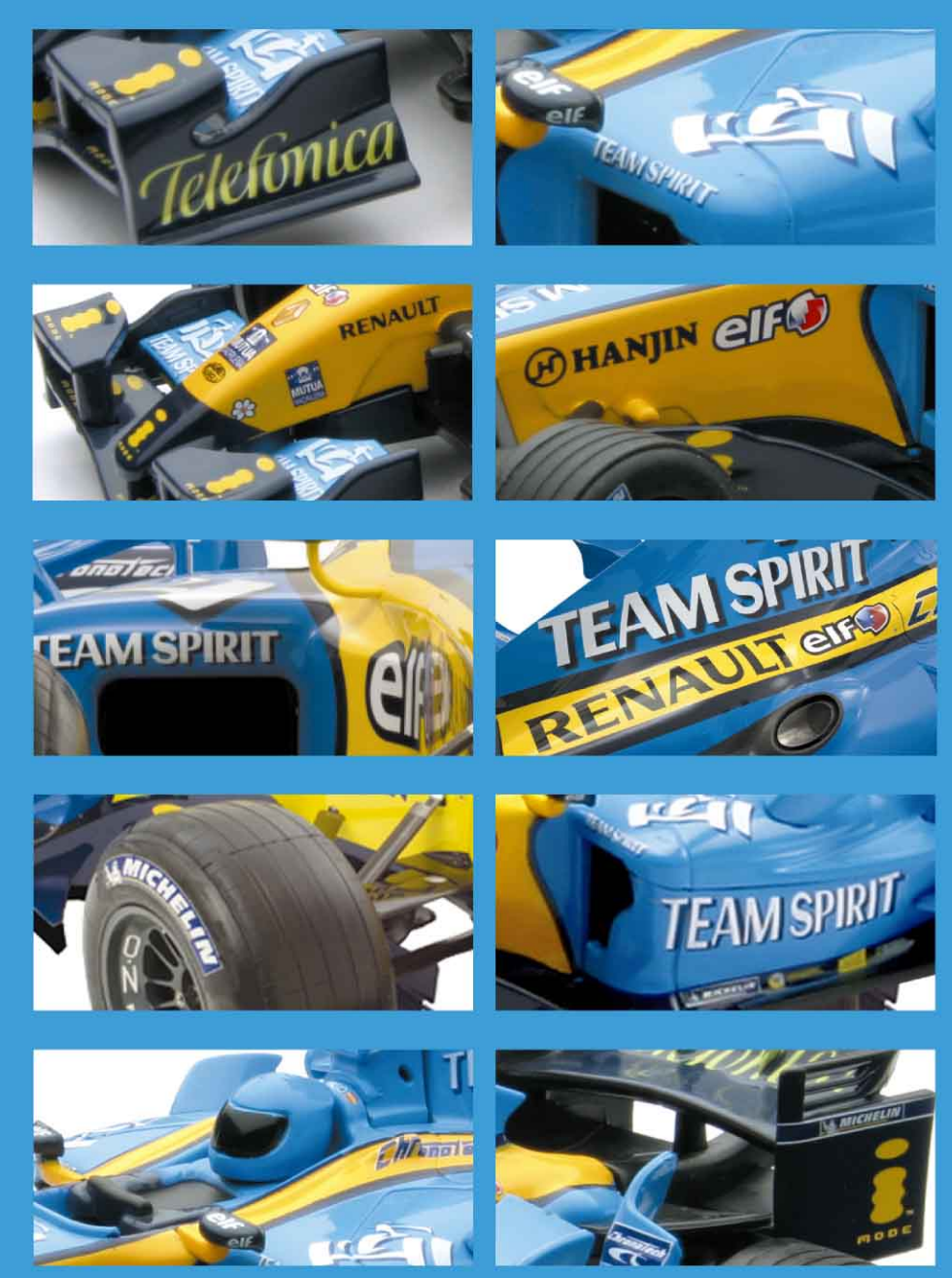

New-Ray Toys Co., Ltd.  
Unit 9, 12<sup>th</sup> Floor Houston Centre  
83 Mody Road, Tsinghsatui East  
Kowloon, Hong Kong  
www.new-ray.com

New-Ray S.r.l.  
Via E. Fermi 633  
21042 Caronno Pertusella (VA)  
New-Ray France Sarl  
Zone d'activité Les Levees  
38470 Vinay



ANR6189943