

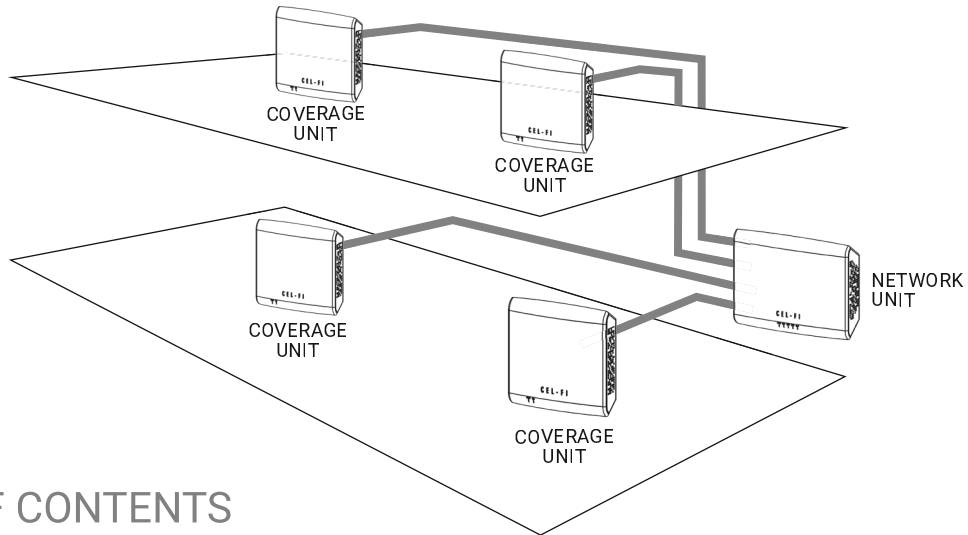

Cel-Fi QUATRA

Networked Smart Booster™



▶ TABLE OF CONTENTS

INTRODUCTION: Cel-Fi QUATRA	2
CONFIGURATIONS (Mode)	2
OVERVIEW	3
PLANNING	3
Decide on the System Configuration (Mode).....	3
NU Placement based upon System Configuration	4
CU Placements	5
Cabling.....	6
SYSTEM INSTALLATION.....	7
STEP 1 – Record QUATRA NU and CU serial numbers by location	7
STEP 2 – Mount QUATRA Hardware.....	7
STEP 3 – Route and connect all Cat 5e (or better) cables	8
STEP 4 – Power the Network Unit and Commission the System	9
TROUBLESHOOTING:	
QUATRA	11
Accessories	12
SPECIFICATIONS	12
TERMINOLOGY	13
REGULATORY	13
ADDITIONAL INFORMATION	13

▸ INTRODUCTION: Cel-Fi QUATRA

Cel-Fi QUATRA is a simple to install 3G/4G/LTE enterprise class Networked Smart Booster™. A single system is comprised of one Network Unit (NU) and up to four Coverage Units (CU). The NU accepts Donor signals from either the outside cellular network or a locally installed Small Cell, and passes that service over Cat 5e (or better) cabling to CUs mounted where cellular service is needed.

The CUs contain their own transmit amplifiers and are powered from the NU using Power over Ethernet (PoE). This allows for flexible placement of the CU's since AC power at the site of each CU is not required.

With four (4) Coverage Units, a combined in-building coverage range of up to 50,000 ft² per system can be achieved. For larger coverage areas, multiple QUATRA systems may be used.

Cel-Fi QUATRA systems are self-configuring and can be fully managed from Nextivity's WAVE Portal. Status notifications and alarms are fully customizable.

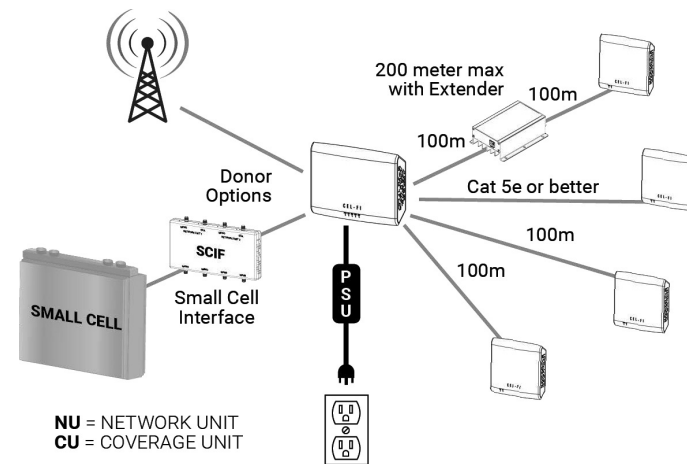

COVERAGE UNITS (CU)

- Up to four (4) per NU
- Power over Ethernet
- Built-in or External antennas
- Horizontal ceiling or vertical wall mountable
- Mounting Kit included

NETWORK UNIT (NU)

- Built-in or external donor antennas
- Accepts Small Cell donor inputs (to one or more QUATRA systems)
- Powers entire system
- Self-configuring
- Mounting Kit included
- Enterprise management

IMPORTANT

 We recommend watching the QUATRA videos on www.cel-fi.com/quatra as a quick way to learn about the system and how to install it.

▸ CONFIGURATIONS (Mode)

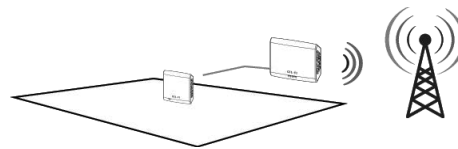
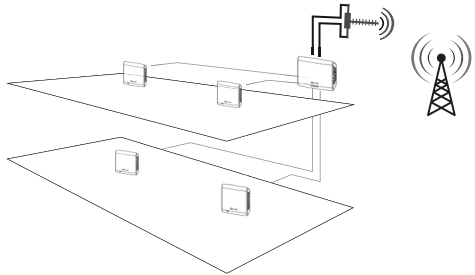
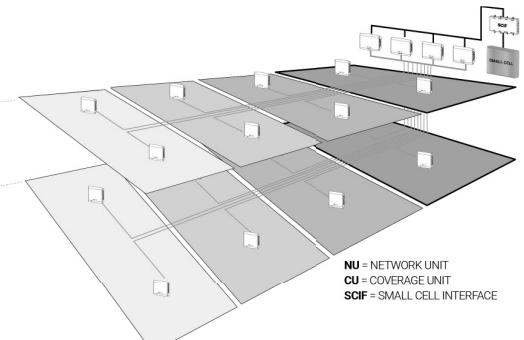
 <p>Off-Air Donor using Internal Antennas</p> <p>BEST FOR: Basic install if an excellent donor signal exists somewhere inside a rural building, and coverage is only needed for part of the building, or the building is smaller.</p>	 <p>Off-Air Donor using an External Antenna</p> <p>BEST FOR: Most off-air installations. This is the recommended use case of an off-air QUATRA system.</p>
<p>Small Cell Donor</p> <p>BEST FOR: Large scale deployments to add dedicated local capacity or to resolve interference issues. Use this configuration when connecting a small cell to one or more QUATRA systems.</p>	 <p>NU = NETWORK UNIT CU = COVERAGE UNIT SCIF = SMALL CELL INTERFACE</p>

▶ OVERVIEW



▶ PLANNING

Decide on your configuration and where QUATRA components will go, including NU to CU interconnect cables to make sure their lengths do not exceed 100 meters per CU (200m with QRE – QUATRA Range Extender).

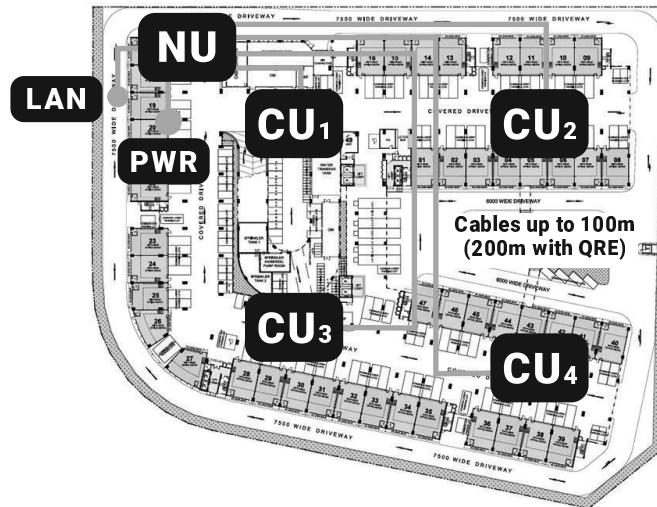

Decide on the System Configuration (Mode)

Use the table below to determine the recommended system configuration for your installation site. Off-Air refers to the use of a donor antenna to receive and redistribute the outdoor macro network service where you need it indoors. Small Cell refers to the use of a dedicated small cell donor device (usually available through your operator) as the network signal source.

	Existing Service using your phone (bars of signal)	
Coverage Need	Weak Cellular service (0-2 bars), reliable calls where signal exists.	Signal exists but calls unreliable, or available small cell does not cover all required areas.
≤ 13,000 ft ² open area	NU Internal Antenna (single CU)	NU External Antenna (single CU)
20,000 ft ² many walled rooms	NU External Antenna (multiple CUs)	NU Small Cell input (multiple CUs)
≤ 50,000 ft ² open area	NU External Antenna (multiple CUs)	NU Small Cell input (multiple CUs)
≥ 50,000 to 200,000 ft ²	Small Cell input to multiple QUATRAs	Small Cell input to multiple QUATRAs

Table 1 – Recommended Configuration

When amplifying the existing outdoor network, service is being shared with other users on the macro network (your outside cellular experience should become your inside cellular experience). When using a dedicated small cell input, capacity is being added to the operator's network at your install site which also helps resolve capacity or interference problems.

NU Placement based upon System Configuration

Off-Air Donor

For smaller rural building applications where an excellent indoor donor signal is available, the NU Mode may be set to Internal Antenna and a single CU may be used. For all other Off-Air applications, Mode must be set to External Antenna and up to four CUs may be used. To meet regulatory compliance and to assure optimum performance, an approved Cel-Fi External Antenna is required (refer to the Legal Insert for a list of approved antennas).

Donor antenna aiming is a simple guided process when commissioning the system.

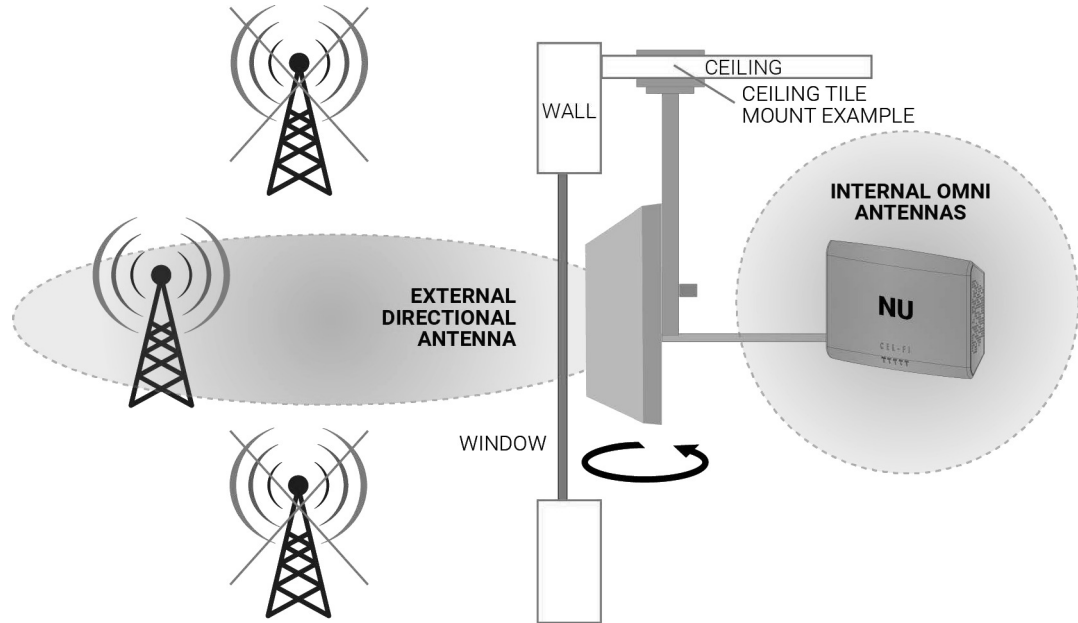

For best results, test donor signal locations during normal peak usage hours.

1. Determine best existing Off-Air signal location in the building (using phone signal bars), usually near windows.
 - a. Test results for LTE are preferred over 3G results.
 - b. OPTION: Run a few speed tests on a phone at each location. Higher data rates indicate better signal quality.
 - c. ADVANCED: Evaluate signal quality parameters (Smartphone apps such as Network Cell Info Lite show this information).

QUALITY INDICATORS	POOR	BEST(MAX)
LTE RSRQ dB	<-15	-3
LTE SINR dB	<0	+30
LTE CQI	0	15
WCDMA Ec/Io dB	<-16	-3
WCDMA CQI	0	30

2. If an antenna is to be mounted outdoors, the installer is responsible for proper lightning surge protection and cable weatherproofing (sold separately).

TIPS FOR NU PLACEMENT



- Plan to mount the NU within power supply reach of an AC outlet, or install an AC outlet near the NU.
- Plan cabling from the NU to the CUs (use existing unused LAN distribution cables from a central patch panel, or plan to run new cables).
- If using internal NU antennas, it is best to not run or coil the cabling immediately behind the NU to avoid effects of metal close to the antennas.

Small Cell Donor:

This configuration connects one or more NUs directly to a small cell through a Small Cell Interface (SCIF) for signal distribution. Plan to mount both the small cell, SCIF and NU next to each other, and where there is easy access to LAN cabling and routing (such as an IT closet with pre-existing LAN patch panels).

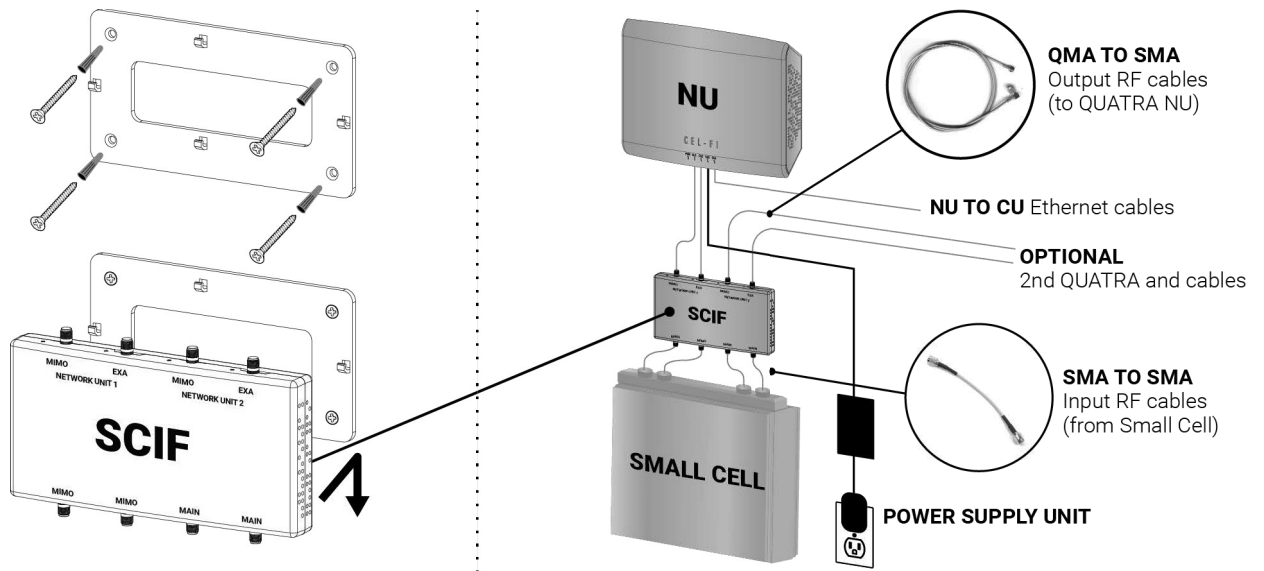

IMPORTANT



- To prevent damage or out of specification operation, a QUATRA Small Cell Interface (SCIF) must be used when connecting QUATRA systems to a small cell.
- More information about connecting a small cell and QUATRA is described in User Guide that comes with the SCIF.

Cabling Between the Small Cell and QUATRA

The QUATRA Small Cell Interface (SCIF) shown above contains the proper amount of signal attenuation and port isolation needed when connecting up to four (4) small cell RF ports to the RF ports of one or two QUATRA NUs. Choose the small cell to match the overall capacity you need and match the QUATRA system size to achieve the coverage you need. If more than two (2) QUATRA systems are to be used, contact your supplier or www.cel-fi.com/quatra for more information.

Installation Considerations for NUs and the SCIF:

- Plan to mount all NUs and the small cell in the same location so they may be properly interconnected using the SCIF.
- The SCIF should be mounted above the small cell within reach of the SCIF Input RF cables.
- Make sure there is a suitable power outlet within reach of the NU power supply.
- Make sure there is room to route CU, LAN, power, and RF cables.
- Allow adequate ventilation.
- Do not place the NU close to other transmitting antennas.
- NU Faceplate LEDs should be clearly visible.

CU Placements

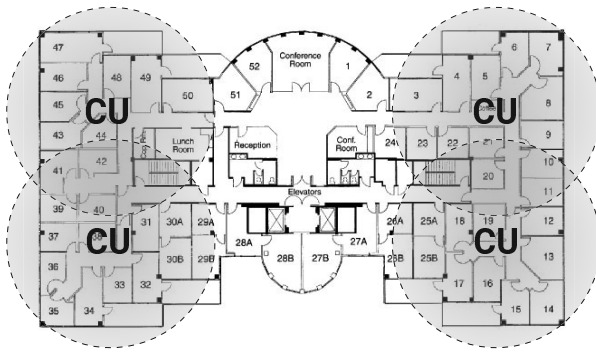

Off-Air Mode CU Placement

For Off-Air installs, mount Coverage Units where the macro network does not reach. Example, if a 100,000 ft² warehouse only lacks service in a few locations, then CUs only needed in those locations.

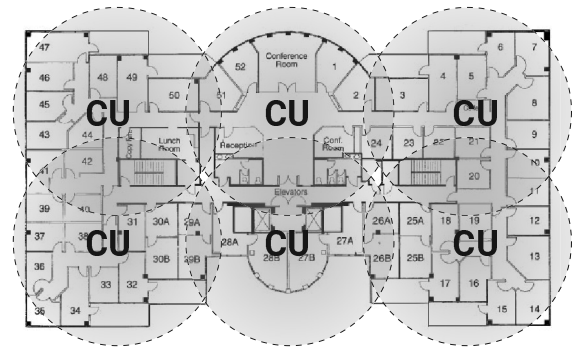

Small Cell Mode CU Placement

For Small Cell donor configurations, mount the CUs to create continual coverage to ensure all areas benefit from the added small cell capacity.

Approximate Service Area (Coverage Unit)	Approximate Coverage Radius (Isolated Coverage Unit)	Distance Between Coverage Units (Contiguous Coverage)
Open areas (warehouse, parking structure)	33 meters	50 meters
Open office plan (cubicles)	21 meters	32 meters
Closed office plan (framed walls)	14 meters	21 meters
Closed room plan (masonry walls)	11 meters	16 meters

Table 2 – General CU coverage estimates

TIPS FOR CU PLACEMENT



- Only a single CU is allowed if NU Mode is set to Internal Antenna. Otherwise up to four CUs are allowed.
- Do not mount a CU near the NU or NU antenna. Greater NU to CU isolation improves signal gain (if no walls separate the NU and a CU, the recommended minimum NU-CU distance for best performance should be 45 ft for Small Cell Mode, 100 ft for External Antenna Mode, and 150 ft for Internal Antenna Mode. Each separating wall may reduce this distance by an additional 30%.
- CUs should be placed at ever increasing distances from the NU.
- Begin CU planning with CUs furthest from the NU.
- For best performance, mount CUs in open areas near the ceiling.

OPTIONAL: CU External Antennas

CUs contain internal omnidirectional MIMO antennas, and they are also equipped with external antenna ports in the event that a directional MIMO antenna is desired, or if the signal needs to be split to feed multiple service antennas (splitter and cable losses will result in lower transmit power at the service antennas).

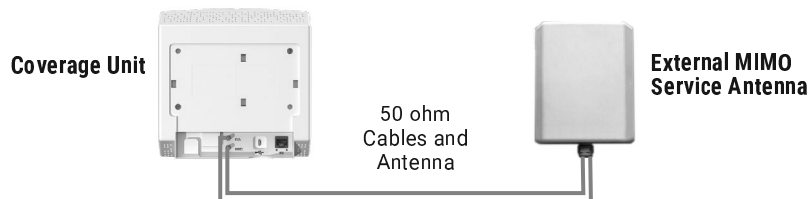

Cabling

QUATRA Cabling considerations

Once NU and CU locations are determined, have your IT professional or cable installer recommend cable routes and lengths (use a QRE for any CU cable length over 100m). Rather than running new cable, sometimes existing LAN cables may be re-purposed.

LAN

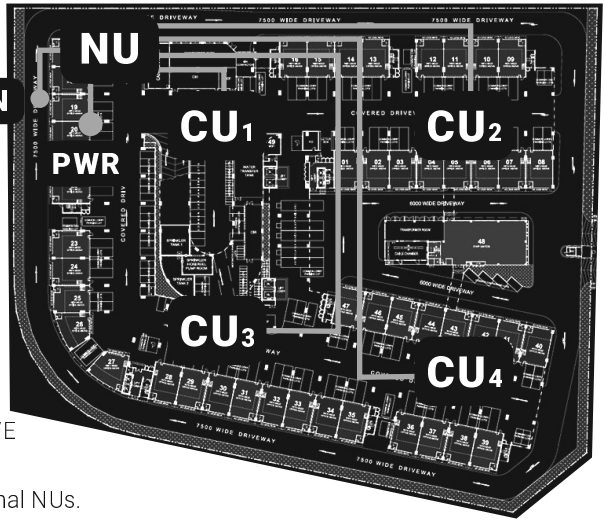

NU Power

- The NU should be located within reach of an AC power output.

NU LAN Management port (located on back of NU)

- The NU LAN port connects QUATRA to the WAVE Portal through your LAN/ISP.
- The LAN OUTPUT port is for daisy chaining additional NUs.

NU to CU cables

- Cat 5e (or better) must be used.
- Maximum NU to CU cable length is 100m for Cat5e, however longer CU cables may be used for Cat6 if cable performance meets qualification testing for 1000Base-T.
- If longer cabling is needed (Cat5e or Cat6), a QUATRA Range Extender (QRE) may be used for up to 200m total cable length.
- These cables must be dedicated to each CU.
- Passive cable interconnects may be used when routing the cables (such as a punch-down block or patch panel).
- Active Ethernet LAN hardware may not be used because QUATRA uses proprietary signaling.

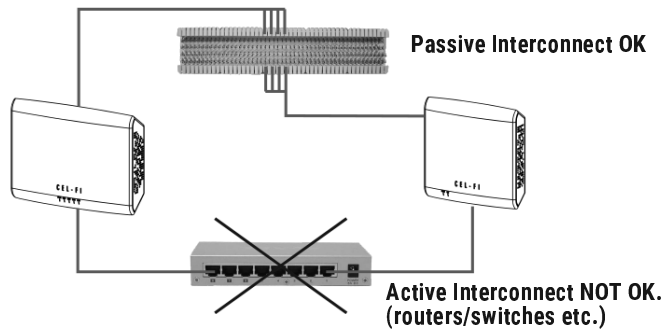

IMPORTANT



NU to CU Ethernet cables must be dedicated (proprietary data link)! The system will not function if common shared LAN resources are used (routers, switches etc).

OPTIONAL: QUATRA Range Extender (QRE)

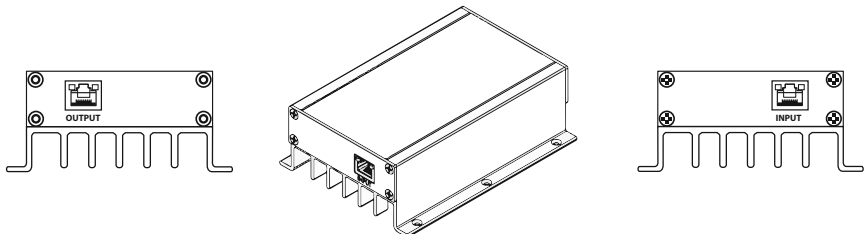

For NU to CU cable lengths up to 200m, use a QRE.

- Only one QRE may be used per CU.
- The QRE is powered by the cable from the NU (no local power source is needed).
- Install the QRE in accordance with the QRE User Manual.

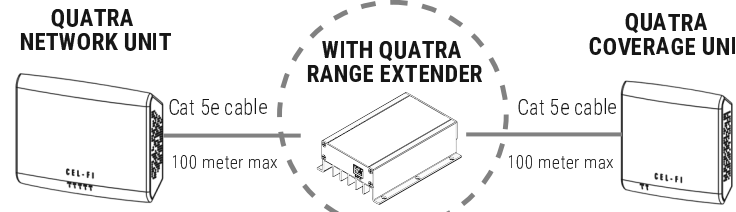

QUATRA NETWORK UNIT — Cat 5e cable (100 meter max) — **WITH QUATRA RANGE EXTENDER** — Cat 5e cable (100 meter max) — **QUATRA COVERAGE UNIT**

SYSTEM INSTALLATION

STEP 1: Record QUATRA NU and CU serial numbers by location

The QUATRA Management tools will reference the NUs and CUs by serial number during commissioning, and allow the assignment of personalized names to each unit.

STEP 2: Mount QUATRA Hardware

WALL MOUNT

Network Unit or Coverage Unit

Mark screw holes using plastic mount (A) onto wall. OPTIONAL: Trace rectangular area (B) if you are planning to run the cables through the wall.

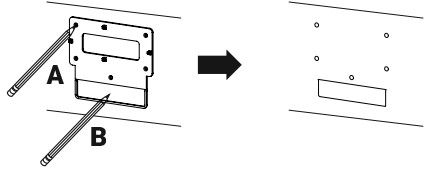

Drill holes into wall. Use a hammer to insert dry wall anchors. OPTIONAL: Cut rectangular area for cables with a dry wall saw.

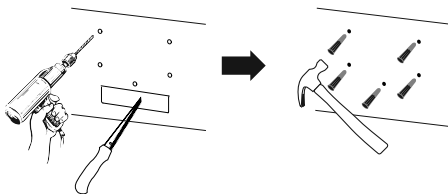

Attach the plastic mount to the wall with drywall screws. OPTIONAL: Route cables through wall cutout.

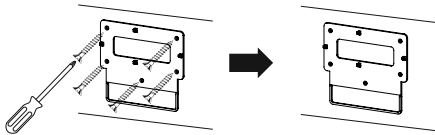

Plug cables into BACK side of unit and place BACK side of unit against plastic mount. Align the four holes over the four hooks and press downward until unit snaps into place.

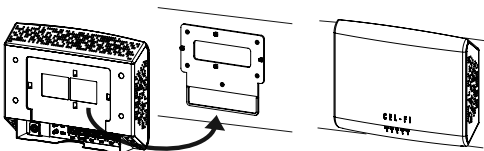

Network Unit Metal Stand-off Brackets

Temporarily attach metal brackets to plastic mount with machine screws. Mark screw holes on metal brackets onto wall.

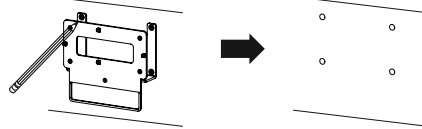

Drill holes into wall. Use a hammer to insert dry wall anchors.

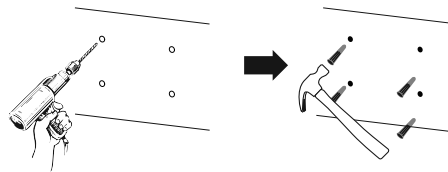

Attach the metal brackets to the wall with drywall screws.

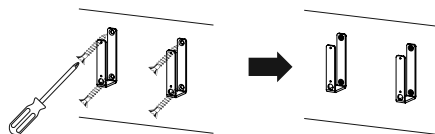

Attach the plastic mount to the metal brackets with machine screws.

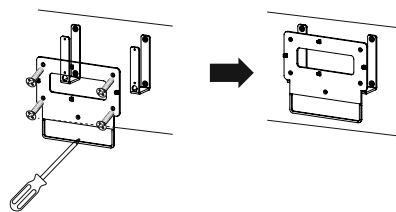

Plug cables into BACK side of unit and place BACK side of unit against plastic mount. Align the four holes over the four hooks and press downward until unit snaps into place.

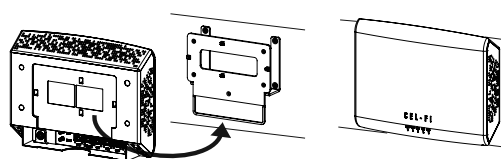

CEILING MOUNT

Coverage Unit Ceiling Tile Mount

Attach plastic mount on to the FRONT side of the ceiling tile with screws. The screw ends will be exposed on BACK side of ceiling tile. Attach metal plate on to the BACK side of the ceiling tile using the exposed screws.

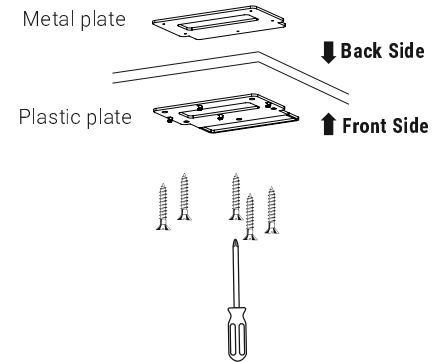

IMPORTANT



Do not overtighten the plastic mount screws.

Create a hole in the ceiling tile in the cutout area of the plastic mount to run the CU cable through.

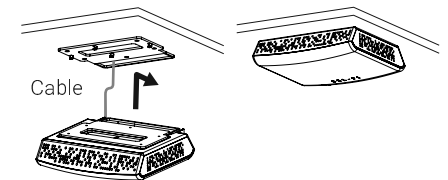

Plug cable into BACK side of unit and place BACK side of unit against plastic mount. Align the four holes over the four hooks and press downward until unit snaps into place.

Accessories

To install accessories, please refer to the installation instructions included with the accessory.

STEP 3: Route and connect all Cat 5e (or better) cables

NU to CU Cabling

Connect CUs in order CU1, CU2... (recommended)

If unsure of CU placement, leave extra cable to allow for CU relocating.

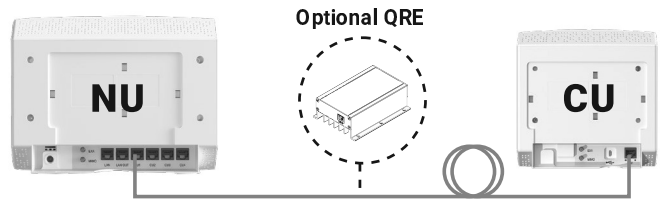

IMPORTANT

 **Do not power up the Network Unit at this time.**

LAN Cables are not provided with unit. End-use installer must choose correct LAN / PoE cables. The LAN cable must be as per requirements of CEC / NEC.

NU Management Connections

If multiple NUs are used at a Site, all LAN management ports should be connected to the same Subnet, or daisy chained using the LAN and LAN OUTPUT ports as shown.



IMPORTANT

 **Remember to set Mode when commissioning the system. Choices are: Internal Antenna, External Antenna, or Small Cell.**

STEP 4: Power the Network Unit and Commission the System

IMPORTANT

 1) QUATRA commissioning using QMT or the WAVE portal is required for operation.
2) Make sure that NU Mode is properly set to Internal Antenna, External Antenna, or Small Cell using QMT or the WAVE Portal (you can access your system record using the NU serial number).
3) If using a small cell, verify that the small cell is commissioned and transmitting before commissioning QUATRA.

- Once a donor signal is available to the NU and the CUs are connected, plug in the NU power supply.
- Download and launch the QUATRA Management Tool (QMT) app from Google Play or the Apple App Store (you can also find and commission your system using the WAVE portal).





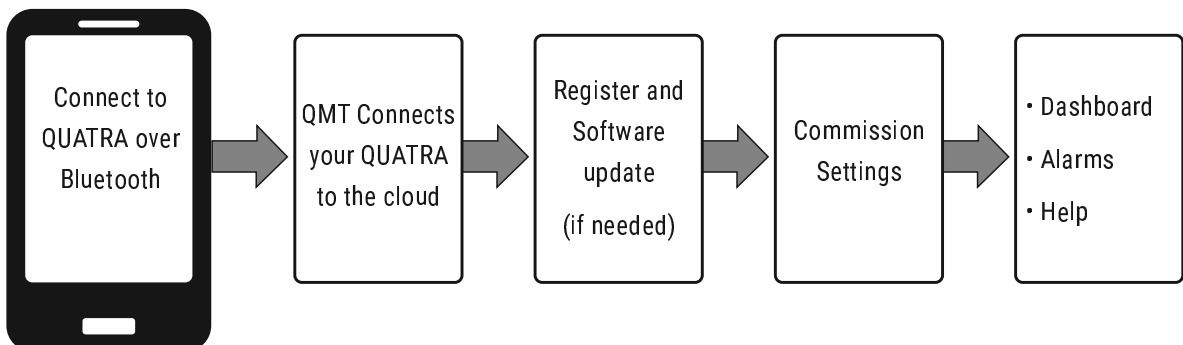

- Follow the on-screen prompts to connect to the QUATRA system over Bluetooth and complete the guided Commissioning steps (you must be within Bluetooth range of an NU or CU).
- If an NU External Antenna is used, you will be guided through Antenna Positioning (aiming) steps at this time.
- Once Commissioning is completed, your QUATRA system should be providing service (the NU and CU front panel LEDs should be solid Green). If an LED is blinking green, wait for setup to complete. If any red LED indications persist, see Troubleshooting.



IMPORTANT

For detailed diagnostics, use the QMT app or the WAVE Portal

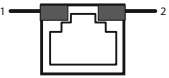

LED	ISSUE	TRY
 SOLID RED	Network Unit error.	Reset the Network Unit by unplugging the power supply, wait 5 seconds, then plug it back in. Verify Network Unit software is up to date (using QMT or cloud portal). If the problem persists, return Network Unit for service.
	Network Unit overheating.	Make sure that the vents (the small openings in the plastic housing) on the units are not blocked. Move the unit to a cooler area. The system will start working normally when it cools down. Reset the Coverage Unit by unplugging it and then plugging it back in. Verify Coverage Unit software is up to date (using QMT or cloud portal).
	Coverage Unit (CU) Error	Make sure that the LAN cabling to each Coverage Unit is dedicated (not combined with other active LAN hardware such as routers and switches). Passive connectors may be used (i.e. punch-down blocks) but the maximum cable distance may be reduced. If a QUATRA Range Extender is used to lengthen the 100 meter maximum Network Unit to Coverage Unit Ethernet distance, make sure only a single QUATRA Range Extender (QRE) is used per Coverage Unit. QRE is proprietary and other extenders will not work. See QRE Troubleshooting. Uninstall Coverage Unit and plug it into back of Network Unit with a short Ethernet cable that is known to work. If the Coverage Unit works properly, troubleshoot the original Ethernet cable (or QRE if used). If the problem persists, return Coverage Unit for service.
	Coverage Unit overheating.	Make sure that the vents (the small openings in the plastic housing) on the units are not blocked. Move the unit to a cooler area. The system will start working normally when it cools down.
 BLINKING RED	Problem with donor signal or Mode setting.	Insufficient Donor Signal. If internal antennas used for Network Unit, relocate Network Unit where signals exist or add and Enable external antennas in Settings. If external antennas or a small cell donor signal are used, check Mode setting, donor source, and cable connections to the NU RF ports.
	Registration required.	Product Registration is required for your system to operate (system is new or has been moved to a new address). Please follow the registration instructions using QMT or the WAVE portal.
	Check Mode and number of CUs.	If NU Mode is set to Internal Antenna, only one CU may be used. More connected CUs will result in system Disable. Disconnect additional CUs, or set NU Mode to External Antenna and connect an External Antenna.
	No CU connected.	Connect at least one CU to the NU.
	CU too close to NU.	A CU is too close to the NU. Move the closest CU further away from the NU.
	CU Disabled.	Use QMT or the WAVE portal to Enable the CU if it is Disabled.
	Input signal too strong.	The Network Unit is receiving too strong a donor signal and may operate with reduced gain (the signal source could be any Operator's cell tower if close enough, or it could be another indoor cellular solution in close proximity to the Network Unit donor antennas). If internal antennas used, move the Network Unit to another location. You might need to move your system to the other side of your building. If external antennas used, move or re-aim the external antennas away from the strong cellular signal source. If a Small Cell donor is used, make sure the coaxial connections to the Small Cell have the supplied attenuators installed.
Location Lock – Registration Required	Your system has been moved from its previous Registration location. Please reregister your system at its new location using QMT or the WAVE portal, or move the system back to its original location.	
 All RJ45 port LEDs flash off repeatedly	System disabled.	The system has been remotely disabled. Please check for a notification message and contact your Operator or Vendor.
	Port keeps resetting	A Coverage Unit LAN cable may be shorted. Unplug all Coverage Units, power cycle the system, and plug Coverage Unit cables back in one at a time to check where fault occurs (fault could be in cabling, a QUATRA Range Extender, or a Coverage Unit). If QUATRA Range Extenders are used, verify that LAN cable length on either side of the Extenders does not exceed 100 meters. If none of the above works, try another power supply. If none of the above works, try another Network Unit.
	Management Connection Error	Verify that a live LAN Ethernet cable is connected to the Network Unit LAN port (not the LAN OUT port which is used to daisy-chain to another Network Unit LAN port). Check LAN firewall settings to the cloud (contact your IT Administrator). The NU uses port 443 for management traffic. Verify system performance and WAVE cloud portal connectivity using QMT (QMT must have an active internet connection).
 BLINKING GREEN	Setup in progress	Wait. System is in a setup state. If a red error indication occurs on the NU, CU LEDs may stay in the setup state until the NU error is cleared.

SOLID GREEN

Phones have signal but can't make calls	If using a Small Cell donor, make sure the small cell is commissioned and transmitting. Make test calls using just the Small Cell signal to verify its operation (temporarily connect small cell antennas). Verify handset settings and compatibility against boosted channel bands and 3G/4G technologies.
Phone not seeing boosted signal.	Due to network resource balancing, a handset may be directed by the network to use an unrelayed channel if that channel is adequate. This is normal and should not cause a service interruption.
Slow software update.	Software updates using QMT may take an hour or more due to Bluetooth limitations. Connect your NU LAN (Management) port to the Internet for faster updates.

▸ TROUBLESHOOTING: Accessories

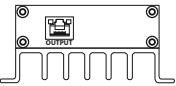
LED	ISSUE	TRY
QRE – ALL LEDs FLASHING		Unplug the INPUT cable, wait 5 seconds, and plug it back in. If the condition persists the unit needs to be replaced.
Any RJ45 green LED is off between NU/QRE/CU	Link is down	CU is not connected or cannot be seen. Check QRE to CU cable and/or CU. CU may be checked by plugging directly to back of NU or QRE Output with LAN test cable. Check NU – QRE – CU cables lengths (must not exceed 100 meters each, and use of patch panels may reduce maximum length).

▸ SPECIFICATIONS

Supported Bands	2, 4, 5, 13
WCDMA Bandwidth per Band	3.84, 5, 10, 15, 20 MHz contiguous UMTS/HSPA channels
LTE Bandwidth per Band	5, 10, 15, 20 MHz contiguous (up to band max)
Channel Selection	Full Auto with self-learn Scan
Downlink TX Power max (conducted)	10dBm/5MHz (16dBm per band per antenna, 19dBm per band)
Uplink TX Power max (conducted)	22dBm per band per antenna, 25dBm total per band
Max boost bandwidth (all channel)	75MHz
Maximum System Gain	100dB
System Gain dynamic range	0-100dB (real time echo controlled)
Internal MIMO antenna gains	0-2dBi (band dependent) V-H polarization
External RF connections	50 ohm QMA female Quick-Connect
Ethernet ports	Shielded Fast Ethernet ports (RJ45)
Maximum NU-CU cable length	100 meter (200 meter with QUATRA Range Extender accessory)
NU-CU LAN cabling	Cat 5e or better
Bluetooth (NU and CU)	Bluetooth Low Energy (BLE) v4.1.2
User Interface	Red/Green LEDs, QMT Smartphone App, WAVE Cloud Portal
Input Power (NU only)	54 VDC @ 2.22 Amp via external supply (51.3 to 56.7 VDC tolerance).
External Power Supply (NU only)	100 to 240 VAC, 47 – 63Hz.
Cooling	Natural convection
Network Unit dimensions	264mm (W) x 185mm (H) x 62mm (D)
Coverage Unit dimensions	225mm (W) x 185mm (H) x 36.5mm (D)
Network Unit weight	1.2 kg (40.8 oz.)
Coverage Unit weight	0.83 kg (29.2 oz.)
Operating temperature	0° to 40°C
Storage temperature	-25° to 60°C
Relative humidity	0% to 95%, noncondensing
IP Rating	IP20
Compliance	RoHS II 2011/65/EU 3GPP TS 25.143 Rel.10 3GPP TS 36.143 Rel.10 FCC Part 15, 20, 22, 24, 27 UL STD 62368-1 Bluetooth BQB

▸ TERMINOLOGY

Attenuator	An electronic device that reduces the amplitude of a signal.
Cel-Fi	An Operator specific Smart Signal Booster® that combines higher signal gain with network protection features.
Coverage Unit (CU)	The Cel-Fi unit that broadcasts cellular service where coverage is needed (Service signal).
Donor Antenna	Receives and transmits signals with the existing cellular network.
External Antenna	Antennas external to a device and connected with RF cables.
Gain, or System Gain	The amount of amplification that may be applied to the source signal.
iBwave	A solutions planner that allows you to perform complete RF distribution designs with hardware such as Cel-Fi products.
Interference	Locations usually between multiple cell sites that may be interfering with each other and reducing network capacity.
Isolation	Separating donor-service antennas to limit feedback potential.
MIMO	Multiple-Input Multiple-Output antenna scheme that improves capacity. QUATRA is a 2x2 MIMO system, using two antennas per NU or CU.
Network Unit (NU)	The Cel-Fi unit that connects to the existing cellular network (Donor signal).
Pilot Pollution	See Interference.
PoE (Power over Ethernet)	To pass electrical power along with data on Ethernet cabling.
QMA connector	A spring loaded quick connect small-size RF connector used to join coaxial cables.
QMT (QUATRA Management Tool)	A Smartphone App and cloud-based management system that allows local and remote management of QUATRA systems.
QRE (QUATRA Range Extender)	Allows QUATRA NU to CU interconnect cable lengths to 200m.
Service Antenna	Receives and transmits signals amongst local user devices (phones/tablets etc).
SMA Connector	A common small (Sub-Miniature A) 50 ohm RF cable connector.
Small Cell	Low-powered cellular radio access node.
Splitter (Divider/Combiner)	Splits a single coaxial cable to/from multiple cables.
WAVE	A cloud portal system for managing Cel-Fi systems.

▸ REGULATORY

FCC

(Applicable in the USA only)

This is a CONSUMER device.

BEFORE USE, you MUST REGISTER THIS DEVICE with your wireless provider and have your provider's consent. Most wireless providers consent to the use of signal boosters. Some providers may not consent to the use of this device on their network. If you are unsure, contact your provider.

You **MUST** operate this device with approved antennas and cables as specified by the manufacturer. Antennas **MUST** be installed at least 20 cm (8 inches) from any person.

You **MUST** cease operating this device immediately if requested by the **FCC** or a licensed wireless service provider.

WARNING. E911 location information may not be provided or may be inaccurate for calls served by using this device.

WARRANTY

For warranty information please visit us at www.Cel-Fi.com

▸ ADDITIONAL INFORMATION

To learn more about QUATRA and how to maximize performance in varying network situations, please visit our Tech Bulletin/White Paper section at <http://quatra.cel-fi.com>.