

RC Fighting Robot BATTLE ROBOT

Owner's Manual

- * Please read carefully before starting to operate.
- * Warning! Use under the direct supervision of an adult.
- * Keep the display box and the manual for future reference.

* The contents of the kit and specifications are subject to change without notice.

PRINTED IN CHINA

RDC-700000 BATTLE ROBOTS

CHARACTERISTICS

- ◇ 1-channel, 3 functions + 1 action
Forward motion/ Stop/ Pivot turn + Infrared beam shooting
- ◇ Equipped with realistic sound system
Infrared beam sounds/ sound of body being shot/
Step Memory Sound System to indicate the start and end of a program
- ◇ Besides playing against an opponent, the user can choose the Auto Mode when playing alone, or the Program Mode to move the robot according to a fixed program. The 3-mode system enables all users, from beginners to experts, to play according to his skill level.

BATTERY REQUIREMENTS

[For the robot and transmitter]

Robot: 4 AA-size batteries (1.5V) or 4 AA-size Ni-Cd batteries (1.2V)

Transmitter: 6F22(9V) battery x 1

NIKKO

NAMES OF THE PARTS

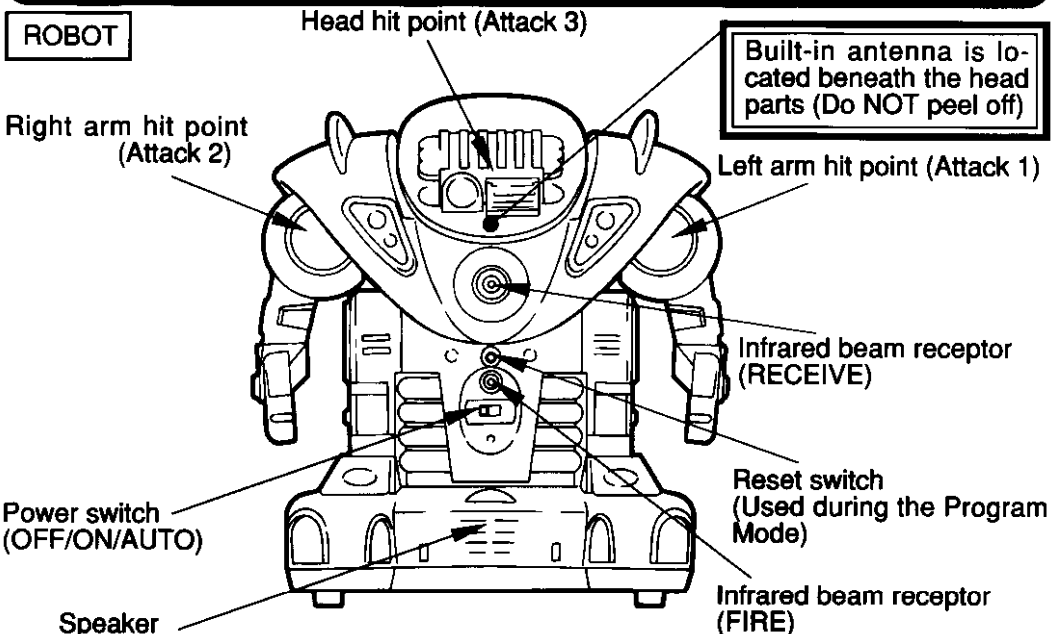

English

TRANSMITTER

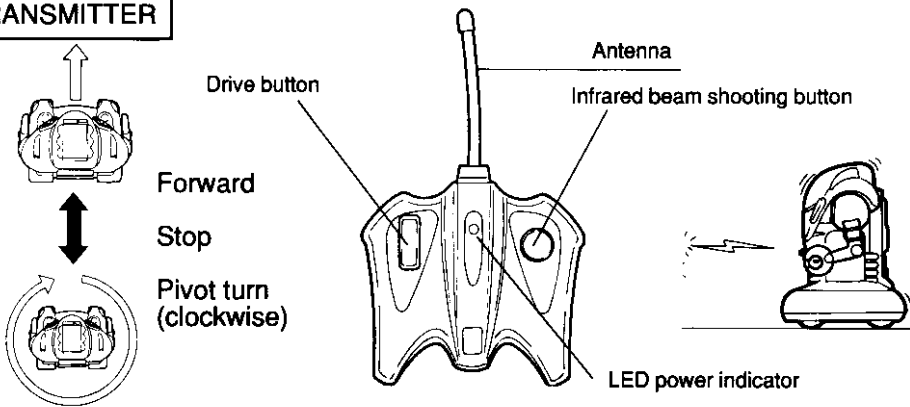

HOW TO INSTALL THE BATTERIES

TRANSMITTER

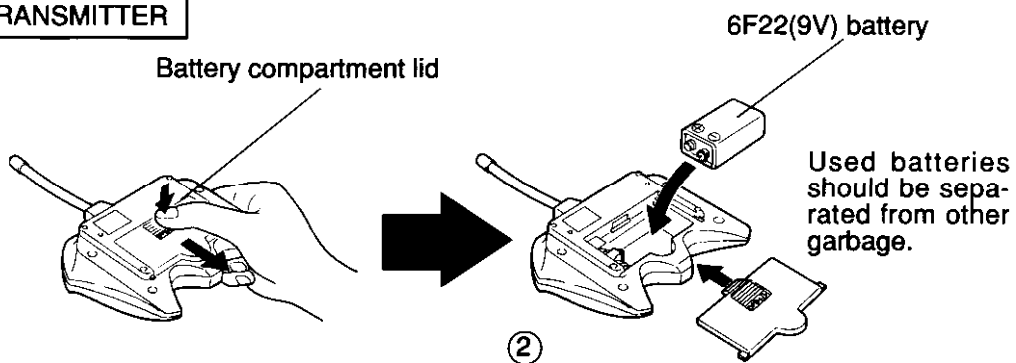

① To open the battery compartment lid, keep pressing the place marked [OPEN] and slide the lid off in the direction shown.

② Install the battery. Make sure that the poles (+,-) are positioned properly.

ROBOT

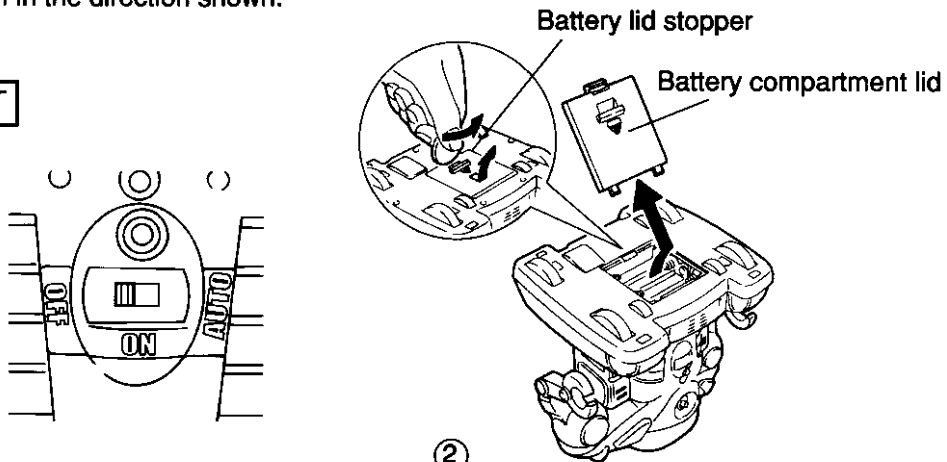

① CAUTION: Before installing the batteries, make sure that the power switch is turned [OFF].

② Use something like a coin to turn the battery lid stopper as shown.

Lift up the battery compartment lid.

2

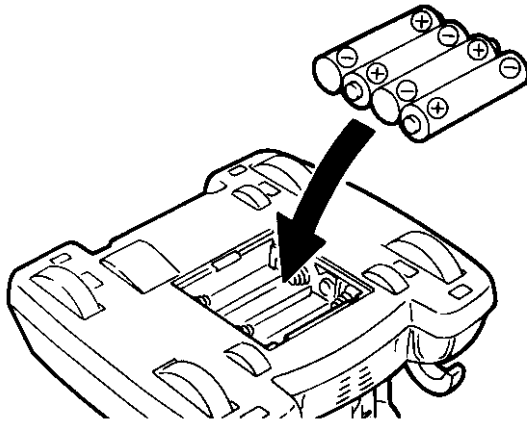

③

Install the batteries as shown in the diagram. Make sure that the + and - poles are positioned properly. Replace the battery compartment lid. (Push in the lid securely.)

CAUTION

- *Check the batteries regularly for leakage.
- *Remove empty batteries from the toy.
- *Never try to charge non-rechargeable batteries.
- *Rechargeable batteries may only be charged under the supervision of an adult.
- *When inserting the batteries take care not to reverse their polarity.
- *Never use batteries of different manufacturers, and do not mix old and new batteries.
- *Use only the recommended batteries or batteries of equal quality.
- *Never short-circuit the terminals.
- *Removable batteries which can be recharged must be removed from the toy prior to charging.

HOW TO PLAY

Three playing modes: R/C Mode (regular play mode against an opponent player), Auto Mode (for playing alone), Program Mode (for making the robot move according to a fixed program).

R/C MODE

In the R/C Mode, each of 2 players controls his own robot and tries to beat the other player by scoring higher.

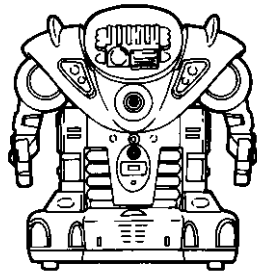

- ① Make sure that the head and arm parts are attached.

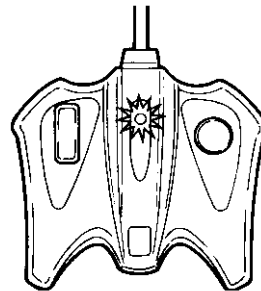

- ② Move the control stick of the transmitter. (The LED lamp will light up.)

AUTO POWER OFF TRANSMITTER

The transmitter power is automatically turned ON when the user operates the transmitter (and the red LED lamp light up to indicate that the power has been turned ON). About 15 seconds after the user stops operating the transmitter, the power is automatically turned OFF (and the red LED lamp goes out).

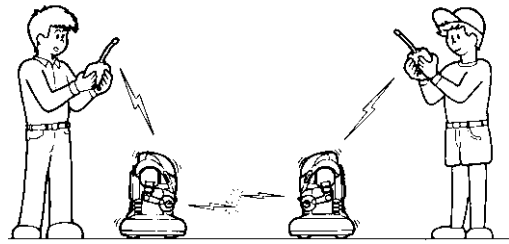
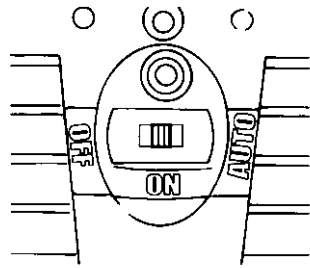

③ Turn ON the power switch of the robot.

④ Start operating.

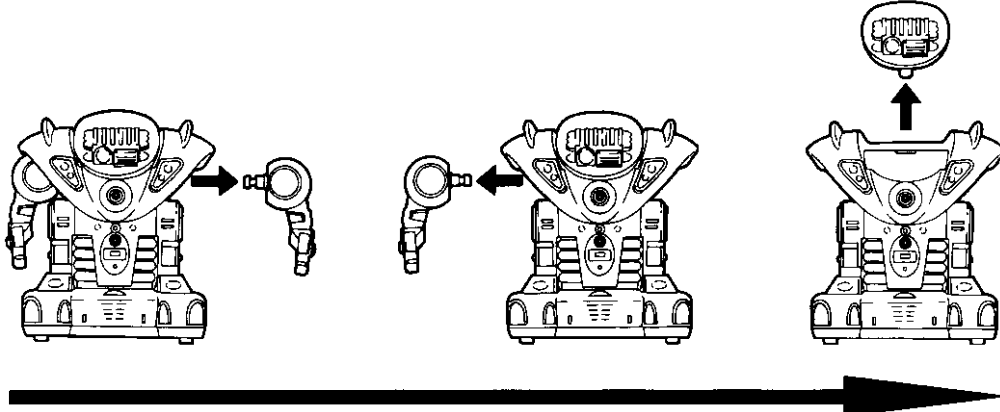

⑤ If either robot is shot in the left arm first, then the right arm, and lastly the head, he loses and the game is over.

⑥ **Replay:** The loser of the previous game should attach the head and arm parts. If the winner has been shot in the arm, press the reset button on the winner's robot. The game can now be started again. **CAUTION:** If the reset button is not pushed, the game will be over after the first or second beam hits.

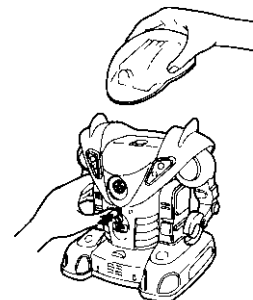

FOR ALL 3 MODES: After playing, turn the power switch of the robot off and remove all the batteries from the transmitter and robot.

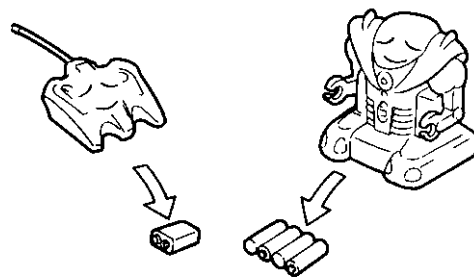

AUTO MODE

In the Auto Mode, the robot moves automatically according to the basic movements preset in the memory system. The contents of this preset program can be changed by using the Program Mode (to be explained later). Even if you change the program in the memory, the new program is deleted when the power switch is turned OFF. When the switch is turned ON again, the contents of the memory return to the basic movements of the Auto Mode.

Perform steps ①~② of the R/C Mode.

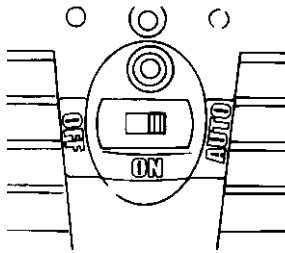

Choose the robot which you want to operate in the Auto Mode and set the power switch of that robot to the AUTO position.

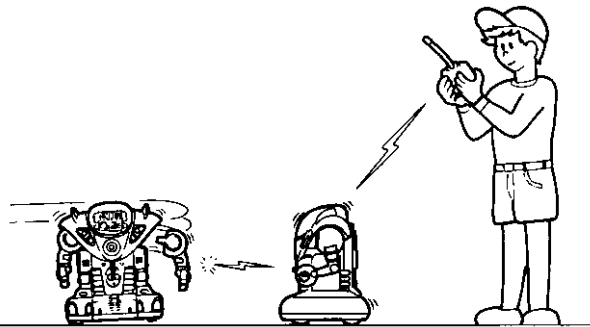

The following procedures are the same as the R/C Mode.

English

PROGRAM MODE

The following directions are a bit difficult, so ask an adult to explain them to you. Refer to this manual repeatedly until you master the operations.

In the Program Mode (Step Memory Method), you will be able to change the programmed actions of the Auto Mode as desired, and make the robot move according to your own original program.

The system uses a 36-step memory (memory input 1 step at a time). The recording/replay time can be set at 0.5 second or 1 second as desired.

Step (sec.)	Total recording time (sec.)
0.5	18
1	36

If several actions are performed during a single step, the last action performed just before step ends will be recorded.

Example 1

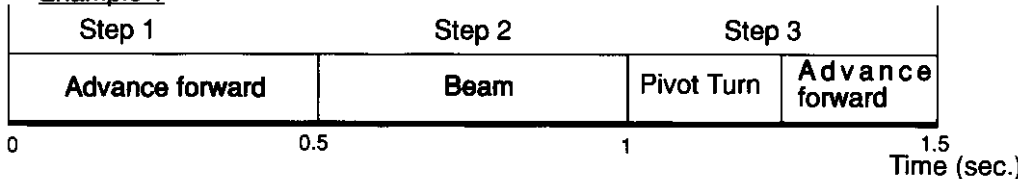

Example 1 shows an 18-second program in which step 1 (advance forward) and step 2 (beam) are recorded as desired, but the pivot turn in step 3 has been deleted and only the forward advance action is recorded in the memory.

PROCEDURES FOR THE 18-SECOND PROGRAM

1. Push the reset switch and detach the head.
2. Turn the power switch ON, with the head detached. (If the head is attached, the robot will be set to the R/C Mode)
3. Push the reset switch.
4. The <pipo> sound indicates that the robot is now set to the 18-second Program Mode.
5. The transmitter operations performed after the head is attached are recorded in the memory system.
6. The recorded movements can be stopped by pressing the reset switch or by waiting 18 seconds for the program to be completed. The <pipo> sound indicates the end of the programmed actions.
7. If you set the power switch to the AUTO position, the actions programmed in 5 will be repeated.

PROCEDURES FOR THE 36-SECOND PROGRAM

1. Press the reset switch and detach the head.
2. Turn the power switch ON, with the head detached. (If the head is attached, the robot will be set to the R/C Mode)
3. Push the reset switch.
4. The <pipo> sound indicates that the robot is not set to the 36-second Program Mode.
5. Turn the power switch ON.
6. The transmitter operations performed after the head is attached are recorded in the memory system.
7. The recorded movements can be stopped by pressing the reset switch or by waiting 36 seconds for the program to be completed. The <pipo> sound indicates the end of the programmed actions.
8. If you set the power switch to the AUTO position, the actions programmed in 6 will be repeated.

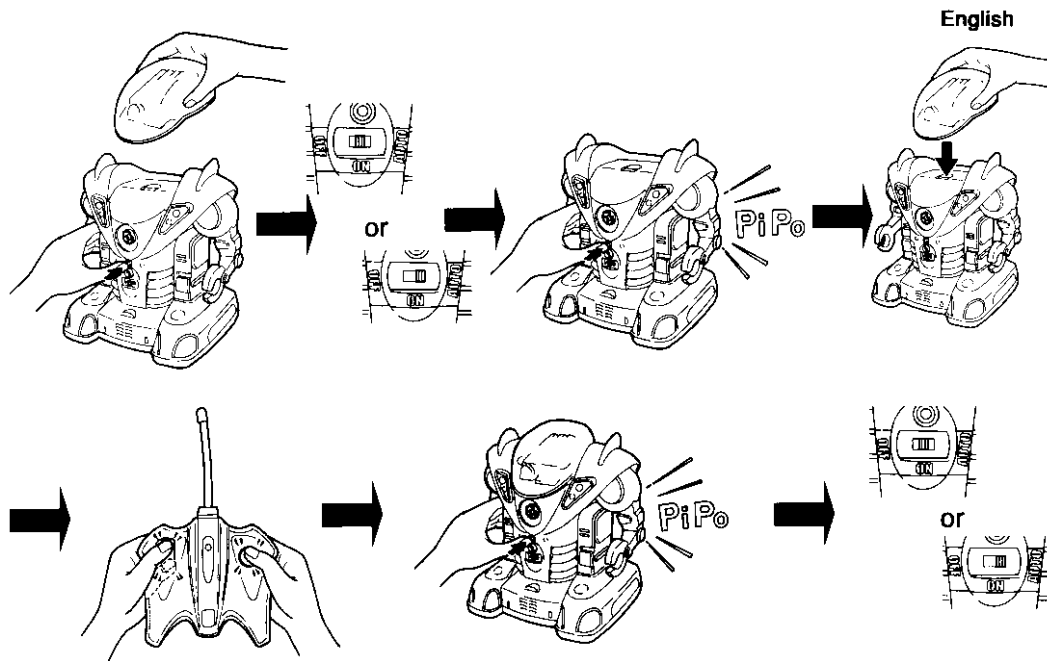

BATTLE ROBOT OPERATIONS AND ADDITIONAL INFORMATION

- * When playing with your Battle Robots, the infrared beam shots can rebound off a wall, etc., and hit the opponent even when the robots are not facing each other. Don't mistake this for a failure or defect.
- * When playing outdoors, the sunlight may hit the robot and make the shooting range of the infrared beam shots shorter than normal.
- * The robots have a filter circuit inside the infrared beam receptor IC to shut out external noise. However, very rarely, the robots can be hit by TV remote control waves, etc., and respond as if it were hit by the enemy robot's beams.
- * In either the Auto Mode or the Program Mode, if the head of one of the robots is blown off, the game is over. By attaching the arms and head of the loser robot, the game can be played over again. In this case, if the winner robot has been shot in the arm(s), press the reset button on that robot. This is because the winner's damage point(s) is recorded in the memory. If the reset switch is not pressed, the game will be over before the robot is shot in the head.
- * The robot will not move when the head is detached.
- * When you attach the head, the robot will move again.

> BATTLE ROBOT TECHNIQUES FOR ADVANCED USERS <

- * Fix the time length for a battle in which one player uses the R/C Mode and operates transmitter, while the opponent uses the Program Mode. Try to input a program that will outsmart the opponent!
- * Set up a maze and see if the robot can escape from the maze using the Program Mode. Consider the forward advance time, distance, and pivot angle when programming. If you succeed, you're an expert!
- * During a battle, the infrared beams can hit a wall, etc., and rebound in an unexpected direction. In such a case, the robot can be shot even when the opponent is facing away from your robot. Why not try making use of the wall rebound for an unexpected attack on the enemy robot?!
- * Basically, two robots face each other in a robot-to-robot battle. The one which pushes the beam button faster shoots the opponent. Don't miss a chance to hit the opponent. At the same time, use the pivot turn function to avoid receiving the enemy's beam at the hit point.
- * The robot makes a pivot turn in the clockwise direction only. Therefore, if you keep the enemy to your right, you will be able to turn toward the enemy and shoot him with a smaller turn. But watch out! If you miss, your enemy is going to be at an advantage...

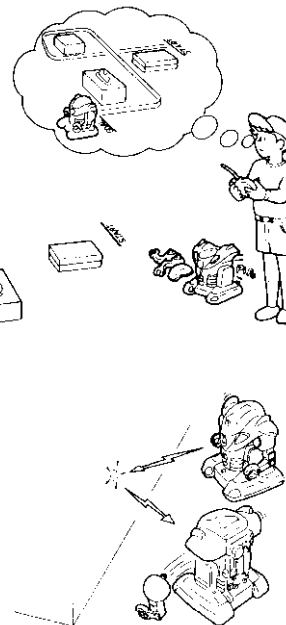

IMPORTANT POINTS TO NOTE WHEN PROGRAMMING!

- * If you push the drive button and beam button at the same time, the beam button gets the priority and the beam operation is recorded in the memory.
- * If the reset switch is pushed before the 18 or 36 second program is over, the remaining program is deleted so that the robot will repeat the operations prior to the pushing of the switch.
- * If several actions are performed during a single step, the last action performed just before changing to the next step will be recorded. This is because the actions are superscribed one after the other, and only the last action remains. After one step is over, the next step begins and you will be able to record another action in the memory. Refer to the explanations for the Program Mode.
- * When the power switch is turned OFF, the recorded memory is deleted and returns to the program originally recorded in the memory. The contents of the memory cannot be retained when the power is turned OFF.
- * If you finish playing in the Program Mode and want to return to the regular R/C Mode, turn the power switch OFF once and start over again.

DAMAGED? Wait a minute!

What's wrong?	Possible causes	What to do
Robot doesn't move	<ol style="list-style-type: none"> 1.The power switch of the robot is turned OFF. 2.The transmitter is too far away from the robot. 3.The batteries of either the robot or transmitter are positioned incorrectly (+ and – poles). 4.The metal tabs which should be touching the batteries are flattened and not touching the poles. 5.The metal tabs touching the battery poles are rusted. 6.Either the transmitter or robot batteries are used up or short of power. 	<ol style="list-style-type: none"> 1.Set the power switch of the robot to the ON or AUTO position. 2.Shorten the distance between the transmitter and robot. 3.Install the batteries in the proper position. 4. Lift up the metal tabs so that they are touching the battery poles. 5.Remove the rust from the metal tabs by using sandpaper. 6.Either replace the used up batteries with new ones,or recharge the Ni-Cd batteries.
Malfunctioning	<ol style="list-style-type: none"> 1.The robot is being jammed by interference waves. 2.There is a radio control vehicle nearby using the same frequency band. 3.Either the transmitter or robot batteries are used up or lack power. 4.When using outdoors, the robot is hit by direct sunlight and the infrared beam shooting range becomes shorter than normal. 5.When the TV remote controller is turned toward the robot, the robot reacts as if it were hit by infrared beams. 	<ol style="list-style-type: none"> 1.Play in a different place, or at a different time. 2.Play in a different place, or at a different time. 3.Either change the used up batteries with new ones, or recharge the Ni-Cd batteries. 4.Play indoors. 5.Don't turn the TV remote controller toward the robot.

The radio control robots are moved by electric waves. Avoid playing in places where the robots can be influenced by other radio signals and loose control or move erratically. If you encounter this type of behavior or loss of control, change to a different location or play later.

OPERATING SAFETY RULES

CAUTION

BE SURE TO READ THE FOLLOWING INSTRUCTIONS

- *DO NOT touch the wheels while playing because it is extremely dangerous!
- *DO NOT play outside in rainy weather or in wet places because the water may damage the robot.
- *DO NOT play where there is traffic or where there is a crowd. DO NOT play in dangerous places.
- *DO NOT play outside during a thunderstorm because it is extremely dangerous.
- *DO NOT play where there is a small child around.
- *DO NOT move the robot where there is sand or small dirt particles because the sand or dirt may damage the robot.
- *Be careful not to let your hair or clothes get caught in the wheels when they are in operation.

Caution:
Keep out of reach of small children under 36 months old as there is danger of getting hurt.



CHANGES OR MODIFICATIONS NOT EXPRESSLY APPROVED BY THE MANUFACTURER FOR COMPLIANCE COULD VOID THE USER'S AUTHORITY TO OPERATE THE EQUIPMENT.

MAINTENANCE AND CARE

If the robot becomes dirty, wipe off the dirt or filth with a slightly damp towel. Then wipe off the water with a dry towel. To clean small or intricate parts, try using a used toothbrush.

CAUTION: Read the following points well!

- * DO NOT use chemical agents when cleaning. The parts can melt or be damaged.
- * DO NOT expose the robots or transmitter to extremely hot or cold temperatures. Do not keep them in highly humid places. Such conditions can cause damage or failure. (For example, do not keep them in an automobile or under direct sunlight.)
- * When not using, be sure to remove all the batteries from the robots and transmitter.

RADIO INTERFERENCE: Sometimes erratic behavior or loss of control of vehicle is the result of interference caused by high tension wires, high voltage transformers, certain types of building, concrete walls or narrow places where RADIO SIGNALS sent from your transmitter MAY BE SCATTERED thus making it DIFFICULT for your vehicle to receive a GOOD RADIO SIGNAL. If you encounter this type of behavior or loss of control, CHANGE TO A DIFFERENT LOCATION.

You will encounter INTERFERENCE if ANOTHER radio controlled vehicle or CB radio is operating in the vicinity on your SAME FREQUENCY.

BATTLE ROBOT PROGRAMMING PROCEDURES (Flow Chart)

