

Nikon

En

The Nikon Guide to Digital Photography
with the

COOLPIX S7c

DIGITAL CAMERA



CE 

Trademark Information

Apple, the Apple logo, Macintosh, Mac OS, and QuickTime are registered trademarks of Apple Computer, Inc. Finder is trademark of Apple Computer, Inc. Microsoft and Windows are registered trademarks of Microsoft Corporation. Internet is a trademark of Digital Equipment Corporation. Adobe and Acrobat are registered trademarks of Adobe Systems Inc. The SD logo is a trademark of the SD Card Association. PictBridge is a trademark. Face-priority AF technology is provided by Identix[®]. Pictmotion is powered by muvee Technologies. ImageLink and the ImageLink print system logo are trademarks of Eastman Kodak Company. D-Lighting technology is provided by  Apical Limited. All other trade names mentioned in this manual or the other documentation provided with your Nikon product are trademarks or registered trademarks of their respective holders.

Apple Public Source License

This product includes Apple mDNS source code that is subject to the terms of the Apple Public Source License located at URL <http://developer.apple.com/darwin/>.

Portions Copyright (c) 1999-2004 Apple Computer, Inc. All Rights Reserved.

This file contains Original Code and/or Modifications of Original Code as defined in and that are subject to the Apple Public Source License Version 2.0 (the 'License'). You may not use this file except in compliance with the License.

Please obtain a copy of the License at <http://www.opensource.apple.com/aps/> and read it before using this file.

The Original Code and all software distributed under the License are distributed on an 'AS IS' basis, WITHOUT WARRANTY OF ANY KIND, EITHER EXPRESS OR IMPLIED, AND APPLE HEREBY DISCLAIMS ALL SUCH WARRANTIES, INCLUDING WITHOUT LIMITATION, ANY WARRANTIES OF MERCHANTABILITY, FITNESS FOR A PARTICULAR PURPOSE, QUIET ENJOYMENT OR NON-INFRINGEMENT. Please see the License for the specific language governing rights and limitations under the License.

Introduction

First Steps

**Basic Photography and
Playback: Auto Mode**

**Shooting Suited for the Scene - High-
sensitivity Shooting Mode, Scene Mode**

Anti-shake Mode

One-Touch Portrait Mode

More on Playback

Movies

Voice Recordings

**Connecting to Televisions,
Computers, and Printers**

**Shooting, Playback, and Setup
Menus**

Wireless Transfer Mode

Technical Notes

For Your Safety

To prevent damage to your Nikon product or injury to yourself or to others, read the following safety precautions in their entirety before using this equipment. Keep these safety instructions where all those who use the product will read them.

The consequences that could result from failure to observe the precautions listed in this section are indicated by the following symbol:



This icon marks warnings, information that should be read before using this Nikon product to prevent possible injury.

WARNINGS

Turn off in the event of malfunction

Should you notice smoke or an unusual smell coming from the camera or AC adapter, unplug the AC adapter and, remove the battery immediately, taking care to avoid burns. Continued operation could result in injury. After removing or disconnecting the power source, take the equipment to a Nikon-authorized service representative for inspection.

Do not disassemble

Touching the internal parts of the camera or AC adapter could result in injury. Repairs should be performed only by qualified technicians. Should the camera or AC adapter break open as the result of a fall or other accident, take the product to a Nikon-authorized service representative for inspection after unplugging the product and/or removing the battery.

Do not use the camera or AC adapter in the presence of flammable gas

Do not use electronic equipment in the presence of flammable gas, as this could result in explosion or fire.

Handle the camera strap with care

Never place the strap around the neck of an infant or child.

Keep out of reach of children

Particular care should be taken to prevent infants from putting the battery or other small parts into their mouths.

⚠ Observe caution when handling the battery

The battery may leak or explode if improperly handled. Observe the following precautions when handling the battery for use in this product:

- Before replacing the battery, turn the product off. If you are using the AC adapter, be sure it is unplugged.
- Only use a rechargeable Nikon EN-EL8 lithium-ion battery (supplied). Charge the battery either by inserting it in the camera and connecting the supplied EH-64 AC adapter, or by inserting it in an MH-62 battery charger (available separately).
- When inserting the battery, do not attempt to insert it upside down or backwards.
- Do not short or disassemble the battery or attempt to remove or break the battery insulation or casing.
- Do not expose the battery to flame or to excessive heat.
- Do not immerse in or expose to water.
- Replace the terminal cover when transporting the battery. Do not transport or store with metal objects such as necklaces or hair-pins.
- The battery is prone to leakage when fully discharged. To avoid damage to the product, be sure to remove the battery when no charge remains.

- Discontinue use immediately should you notice any change in the battery, such as discoloration or deformation.
- If liquid from the damaged battery comes in contact with clothing or skin, rinse immediately with plenty of water.

⚠ Observe the following precautions when handling the AC charger

- Keep dry. Failure to observe this precaution could result in fire or electric shock.
- Dust on or near the metal parts of the plug should be removed with a dry cloth. Continued use could result in fire.
- Do not handle the power cable or go near the battery charger during lightning storms. Failure to observe this precaution could result in electric shock.
- Do not damage, modify, forcibly tug or bend the power cable, place it under heavy objects, or expose it to heat or flame. Should the insulation be damaged and the wires become exposed, take it to a Nikon-authorized service representative for inspection. Failure to observe these precautions could result in fire or electric shock.

For Your Safety

- Do not handle the plug or battery charger with wet hands. Failure to observe this precaution could result in electric shock.

Use appropriate cables

When connecting cables to the input and output jacks, use only the cables provided or sold by Nikon for the purpose, to maintain compliance with product regulations.

Handle moving parts with care

Be careful that your fingers or other objects are not pinched by the lens cover or other moving parts.

CD-ROMs

The CD-ROMs supplied with this device should not be played back on audio CD equipment. Playing CD-ROMs on an audio CD player could cause hearing loss or damage the equipment.

Observe caution when using the flash

Using the flash close to your subject's eyes could cause temporary visual impairment. Particular care should be observed if photographing infants, when the flash should be no less than one meter (39 in.) from the subject.

Do not operate the flash with the flash window touching a person or object

Failure to observe this precaution could result in burns or fire.

Avoid contact with liquid crystal

Should the monitor break, care should be taken to avoid injury caused by broken glass and to prevent liquid crystal from the monitor touching the skin or entering the eyes or mouth.

Notices

This product, which contains encryption software developed in the United States, is controlled by the United States Export Administration Regulations and may not be exported or re-exported to any country to which the United States embargoes goods. As of November 2005 the following countries were subject to embargo: Cuba, Iran, North Korea, Libya, Sudan, and Syria.

Restrictions on Wireless Devices

The wireless transceiver included in this product conforms to wireless regulations in the country of sale and is not for use in other countries (products purchased in the EU or EFTA can be used anywhere within the EU and EFTA). Nikon does not accept liability for use in other countries. Users who are unsure as to the original country of sale should consult with their local Nikon service center or Nikon-authorized service representative.

This restriction applies to wireless operation only and not to any other use of the product.

Notice for customers in the U.S.A. and Canada

Federal Communications Commission (FCC) and Industry of Canada (IC)

Declaration of Conformity

This device complies with Part 15 of the FCC rules and RSS-Gen of IC rules. Operation of the device is subject to the following two conditions: (1) this device may not cause harmful interference, and (2) this device must accept any interference received, including interference that may cause undesired operation.

FCC/IC RF Exposure Statement

The available scientific evidence does not show that any health problems are associated with using low power wireless devices. There is no proof, however, that these low power wireless devices are absolutely safe. Low power wireless devices emit low levels of radio frequency energy (RF) in the microwave range while being used. Whereas high levels of RF can produce health effects (by heating tissue), exposure to low-level RF that does not produce heating effects causes no known adverse health effects. Many studies of low-level RF exposures have not found any biological effects. Some studies have suggested that some biological effects might occur, but such findings have not been confirmed by additional research. Wireless LAN Module (2143EB) has been tested and found to comply with FCC/IC radiation exposure limits set forth for an uncontrolled equipment and meets the FCC radio frequency (RF) Exposure Guidelines in Supplement C to OET65 and RSS-102 of the IC radio frequency (RF) Exposure rules. Please refer to the SAR test report that was uploaded at FCC website. This device should not be co-located or operated in conjunction with any other antenna or transmitter.

Notice for customers in the U.S.A.

FCC RF Interference Statement

This equipment has been tested and found to comply with the limits for a Class B digital device, pursuant to Part 15 of the FCC rules. These limits are designed to provide reasonable protection against harmful interference in a residential installation. This equipment generates, uses, and can radiate radio frequency energy and, if not installed and used in accordance with the instructions, may cause harmful interference to radio communications. However, there is no guarantee that interference will not occur in a particular installation. If this equipment does cause harmful interference to radio or television reception, which can be determined by turning the equipment off and on, the user is encouraged to try to correct the interference by one or more of the following measures:

- Reorient or relocate the receiving antenna.
- Increase the separation between the equipment and receiver.
- Connect the equipment into an outlet on a circuit different from that to which the receiver is connected.
- Consult the dealer or an experienced radio/television technician for help.

CAUTIONS

Modifications

The FCC requires the user to be notified that any changes or modifications made to this device that are not expressly approved by Nikon Corporation may void the user's authority to operate the equipment.

Interface Cables

Use the interface cables sold or provided by Nikon for your equipment. Using other interface cables may exceed the limits of Class B Part 15 of the FCC rules.

Notice for customers in the State of California

WARNING: Handling the cord on this product will expose you to lead, a chemical known to the State of California to cause birth defects or other reproductive harm. **Wash hands after handling.**

Nikon Inc.,
1300 Walt Whitman Road
Melville, New York 11747-3064
USA
Tel: 631-547-4200

Notice for customers in Canada

CAUTION

This Class B digital apparatus complies with Canadian ICES-003.

ATTENTION

Cet appareil numérique de la classe B est conforme à la norme NMB-003 du Canada.

Notice for customers in Europe

Hereby, Nikon, declares that this digital camera is in compliance with the essential requirements and other relevant provisions of Directive 1999/5/EC.

Notice for customers in France

Outdoor use of the wireless transceiver is prohibited in France.

Symbol for Separate Collection in European Countries



This symbol indicates that this product is to be collected separately.



The following apply only to users in European countries:

- This product is designated for separate collection at an appropriate collection point. Do not dispose of as household waste.
- For more information, contact the retailer or the local authorities in charge of waste management.

Table of Contents

Introduction	ii
For Your Safety.....	ii
WARNINGS	ii
Notices.....	v
About This Manual.....	1
Information and Precautions.....	2
Parts of the Camera.....	6
Attaching the Camera Strap	6
The Monitor.....	8
Shooting	8
Playback.....	9
Basic Operations.....	10
The  (shooting/playback) Button.....	10
The  (mode) Button.....	10
The MENU Button	11
The Rotary Multi Selector	12
Help Displays.....	13
First Steps.....	14
The COOL-STATION and AC Adapter	14
The COOL-STATION	14
The AC Adapter	15
Inserting the Battery	16
Removing the Battery	17
Turning On and Off the Camera.....	17
Charging the Battery.....	18
Setting Display Language, Date, and Time.....	20
Inserting Memory Cards.....	22
Removing Memory Cards	23







Basic Photography and Playback: Auto Mode	24
Step 1 Turn the Camera On and Select  (Auto) Mode	24
Indicators Displayed in  (Auto) Mode	25
Step 2 Frame a Picture	26
Using the Zoom.....	26
Electronic VR	27
Step 3 Focus and Shoot	28
Step 4 Viewing and Deleting Pictures	30
Full-Frame Playback	30
Deleting Pictures	30
Using the Flash	32
Taking Pictures with the Self-Timer	34
Macro Close-up Mode	35
<hr/>	
Shooting Suited for the Scene - High-sensitivity Shooting Mode, Scene Mode	36
High-sensitivity Shooting Mode	36
Assist Modes and Scene Modes	37
Assist Modes	38
Taking Pictures in Assist Modes	38
 Portrait Assist	39
 Landscape Assist	40
 Sports Assist	41
 Night Portrait Assist.....	42
Scene Modes	43
Taking Pictures in Scene Modes.....	43
Features	44
<hr/>	
Anti-shake Mode	49
Shooting in Anti-shake Mode.....	49
<hr/>	
One-Touch Portrait Mode	50
Taking Pictures in the One-Touch Portrait Mode.....	50
The One-Touch Portrait Menu.....	51

Table of Contents

More on Playback	52
Viewing Multiple Pictures: Thumbnail Playback	52
Taking a Closer Look: Playback Zoom	53
Editing Pictures	54
Creating a Cropped Copy: Crop	55
Enhancing Brightness and Contrast: D-Lighting	56
Compensating Blurred Images: Electronic VR	57
Resizing Pictures: Small Picture	58
Voice Memos: Recording and Playback	59
Viewing Pictures by Date	60
Pictmotion by muvee	65
<hr/>	
Movies	70
Recording Movies	70
The Movie Menu	71
Selecting Movie Options	72
Time-Lapse Movies	73
Stop-Motion Movies	74
Auto-Focus Mode	75
Electronic VR	75
Movie Playback	76
Deleting Movie Files	76
<hr/>	
Voice Recordings	77
Making Voice Recordings	77
Changing the Sound Quality	78
Sound Quality	78
Playing Voice Recordings	79
Copying Voice Recordings	81
<hr/>	
Connecting to Televisions, Computers, and Printers	82
Connecting to a TV	82
Connecting to a Computer	83
Before Connecting the Camera	83
Setting the USB Option	84
Transferring Pictures to a Computer	85
Connecting to a Printer	87
Connecting the Camera and Printer	88
Printing Pictures One at a Time	89
Printing Multiple Pictures	90
Creating a DPOF Print Order: Print Set	93

Connecting to a ImageLink-compatible Printer	95
Removing the Dock Insert.....	95
Shooting, Playback, and Setup Menus.....	96
Shooting Options: The Shooting Menu	96
Displaying the Shooting Menu and High-sensitivity Menu	97
Image Mode	97
White Balance.....	99
Exp. +/-.....	101
Continuous.....	102
Best Shot Selector (BSS)	104
ISO Sensitivity.....	105
Color Options.....	105
AF Area Mode.....	106
Electronic VR.....	106
Restrictions on Camera Settings	107
Playback Options: The Playback Menu	108
Print Set	109
Slide Show	110
Delete	111
Protect	111
Transfer Marking	112
Rotate Image	112
Copy.....	113
Basic Camera Setup: The Setup Menu.....	114
Displaying the Setup Menu.....	115
Menus.....	115
Quick Startup	116
Welcome Screen	116
Date.....	117
Monitor Settings.....	120
Date Imprint.....	121
AF Assist	123
Sound Settings.....	123
Record Orientation	124
Auto Off	124
Format Memory/Format Card	125
Language	126
Interface.....	126
Reset All.....	127
Firmware Version	129

Table of Contents

Wireless Transfer Mode	130
What is Wireless Transfer Mode?	130
Features of Wireless Transfer Mode	130
The Features Available in the Wireless Transfer Mode	132
For Connection via Home Wireless LAN	134
Configuration Procedure	134
Configuring the Camera	136
Settings for the Setup Utility	141
Transferring Pictures	143
Establishing a Wireless Connection	143
Uploading Pictures to COOLPIX CONNECT	145
Transferring Pictures to a Computer (PC Connection)	149
Transferring Pictures Not Yet Saved on a Computer - Easy Transfer	150
Transferring Pictures Taken on Selected Date - Shooting Date	151
Transferring Selected Pictures - Selected Images	152
Immediately Transferring Pictures Taken - Shoot & Transfer	153
Transferring Pictures Marked with the Transfer Icon - Marked Images.....	155
Transferring Pictures Using a Computer - PC Mode	156
Printing Pictures (Wireless Printing)	158
Technical Notes	159
Optional Accessories	159
Approved Memory Cards	159
Image File and Folder Names	160
Caring for the Camera	162
Cleaning	164
Storage	164
Error Messages	165
Troubleshooting	171
Supported Standards	177
Specifications	178
Index	182

About This Manual

Thank you for your purchase of a Nikon COOLPIX S7c digital camera. This manual has been written to help you enjoy taking pictures with your Nikon digital camera. Read this manual thoroughly before use, and keep it where all those who use the product will read it.

Symbols and Conventions

To make it easier to find the information you need, the following symbols and conventions are used:



This icon marks cautions, information that should be read before use to prevent damage to the camera.



This icon marks tips, additional information that may be helpful when using the camera.



This icon marks notes, information that should be read before using the camera.



This icon indicates that more information is available elsewhere in this manual or in the *Quick Start Guide*.

Notations

- A Secure Digital (SD) memory card is referred to as a “memory card.”
- The setting at the time of purchase is referred to as the “default setting.”
- Menu items, options, and messages displayed in the camera monitor are shown in brackets ([]).

Screen Samples

In this manual, images are sometimes omitted from monitor display samples so that monitor indicators can be more clearly shown.

Illustrations and Screen Display

Illustrations and text displays shown in this manual may differ from actual display.

Memory Cards

Pictures taken with this camera can be stored in the camera’s internal memory or on removable memory cards. If a memory card is inserted, all new pictures will be stored on the memory card and delete, playback, and format operations will apply only to the pictures on the memory card. The memory card must be removed before the internal memory can be formatted or used to store, delete, or view pictures.

Information and Precautions

Life-Long Learning

As part of Nikon's "Life-Long Learning" commitment to ongoing product support and education, continually updated information is available online at the following sites:

- For users in the U.S.A.: <http://www.nikonusa.com/>
- For users in Europe and Africa: <http://www.europe-nikon.com/support/>
- For users in Asia, Oceania, and the Middle East: <http://www.nikon-asia.com/>

Visit these sites to keep up-to-date with the latest product information, tips, answers to frequently asked questions (FAQs), and general advice on digital imaging and photography. Additional information may be available from the Nikon representative in your area. See the following URL for contact information: <http://nikonimaging.com/>

Use Only Nikon Brand Electronic Accessories

Nikon COOLPIX cameras are designed to the highest standards and include complex electronic circuitry. Only Nikon brand electronic accessories (including battery chargers, batteries, and AC chargers) certified by Nikon specifically for use with this Nikon digital camera are engineered and proven to operate within the operational and safety requirements of this electronic circuitry.

THE USE OF NON-NIKON ELECTRONIC ACCESSORIES COULD DAMAGE THE CAMERA AND MAY VOID YOUR NIKON WARRANTY.

For more information about Nikon brand accessories, contact a local authorized Nikon dealer.

- * **Holographic seal:** Identifies this device as an authentic Nikon product.



EN-EL8
rechargeable
battery

Before Taking Important Pictures

Before taking pictures on important occasions (such as at weddings or before taking the camera on a trip), take a test shot to ensure that the camera is functioning normally. Nikon will not be held liable for damages or lost profits that may result from product malfunction.

About the Manuals

- No part of the manuals included with this product may be reproduced, transmitted, transcribed, stored in a retrieval system, or translated into any language in any form, by any means, without Nikon's prior written permission.
- Nikon reserves the right to change the specifications of the hardware and software described in these manuals at any time and without prior notice.
- Nikon will not be held liable for any damages resulting from the use of this product.
- While every effort has been made to ensure that the information in these manuals is accurate and complete, we would appreciate it were you to bring any errors or omissions to the attention of the Nikon representative in your area (address provided separately).

Notice Concerning Prohibition of Copying or Reproduction

Note that simply being in possession of material that has been digitally copied or reproduced by means of a scanner, digital camera or other device may be punishable by law.

- **Items prohibited by law from being copied or reproduced**

Do not copy or reproduce paper money, coins, securities, government bonds, or local government bonds, even if such copies or reproductions are stamped "Sample."

The copying or reproduction of paper money, coins, or securities which are circulated in a foreign country is prohibited.

Unless the prior permission of the government has been obtained, the copying or reproduction of unused postage stamps or post cards issued by the government is prohibited.

The copying or reproduction of stamps issued by the government and of certified documents stipulated by law is prohibited.

- **Cautions on certain copies and reproductions**

The government has issued cautions on copies or reproductions of securities issued by private companies (shares, bills, checks, gift certificates, etc.), commuter passes, or coupon tickets, except when a minimum of necessary copies are to be provided for business use by a company. Also, do not copy or reproduce passports issued by the government, licenses issued by public agencies and private groups, ID cards, and tickets, such as passes and meal coupons.

- **Comply with copyright notices**

The copying or reproduction of copyrighted creative works such as books, music, paintings, woodcut prints, maps, drawings, movies, and photographs is governed by national and international copyright laws. Do not use this product for the purpose of making illegal copies or to infringe copyright laws.

Disposing of Data Storage Devices

Please note that deleting images or formatting data storage devices such as memory cards or built-in camera memory does not completely erase the original image data. Deleted files can sometimes be recovered from discarded storage devices using commercially available software, potentially resulting in the malicious use of personal image data. Ensuring the privacy of such data is the user's responsibility.

Before discarding a data storage device or transferring ownership to another person, erase all data using commercial deletion software, or format the device and then completely refill it with images containing no private information (for example, pictures of empty sky). Be sure to also replace any pictures selected for the welcome screen (📷 116). Care should be taken to avoid injury or damage to property when physically destroying data storage devices.

Information and Precautions

Note the following important points before using this product's wireless LAN function.

Restrictions of Use Under Radio Laws and Precautions when Using Radio Transmissions

- The wireless transceiver included in this product conforms to wireless regulations in the country of sale and is not for use in other countries (products purchased in the EU or EFTA can be used anywhere within the EU and EFTA).
- When using the LAN function of this product, the product will search for wireless networks automatically. At this time, the product may display wireless networks (SSID) for which you are not an authorized user. Use of such a wireless network may be regarded as unauthorized access. Never connect to an SSID that you are not authorized to use.
- Always keep in mind that radio transmission or reception of data is subject to interception by third parties.

Personal Information Management and Disclaimer

- User information registered and configured on the product, including wireless LAN connection settings and other personal information, is susceptible to alteration and loss resulting from operational error, static electricity, accident, malfunction, repair or other handling. Always keep separate copies of important information. Nikon is not responsible for any direct or indirect damages or lost profits resulting from alteration or loss of content that is not attributable to Nikon.
- Before discarding this product or transferring it to another owner, it is recommended that you use the included Wireless Camera Setup Utility to delete all user information registered and configured on the product, including wireless LAN connection settings and other personal information.
- Nikon is not responsible for any communication charges stemming from unauthorized access to a public wireless LAN by third parties, or any other damages resulting from theft of the product.
- Nikon is not responsible for any damages stemming from unauthorized use of e-mail addresses stored resulting from theft of the product.

Precautions and Limitations when Using the COOLPIX CONNECT Service

- Connection to a public wireless LAN for the COOLPIX CONNECT service (hereinafter referred to as Service) is not guaranteed or supported outside the United States. Nikon is not responsible for any direct or indirect damages or lost profits resulting from any connection made at your own responsibility.
- Use of this Service over a public wireless LAN connection requires a T-Mobile HotSpot subscription if the product was originally purchased in the United States.
- Make sure you specify the e-mail addresses of recipients correctly. An error will not be indicated if the recipient is wrong, nor will an error notification be sent to your e-mail address.
- Access to a COOLPIX CONNECT web site (site for viewing pictures) is not limited to this Service. A page can be browsed by anyone after the page's URL is provided to them or made public.
- Images uploaded to a COOLPIX CONNECT server are stored for up to two weeks.

- Nikon makes no guarantees whatsoever concerning the ability of this Service to store or safeguard images. Be sure to maintain separate back-up copies of all important images. Nikon is not responsible for any direct or indirect damages or lost profits resulting from alteration or loss of content that is not attributable to Nikon.
- Your use of the Service is completely at your own responsibility, and Nikon accepts no responsibility on your behalf.
- By using the Service, you agree not to upload, post, e-mail or otherwise transmit or communicate any material through the Service that is obscene, pornographic, unlawful, threatening, an invasion of any privacy or publicity rights of any party, defamatory, libelous, illegal or otherwise objectionable, or infringes any copyright, trademark, or other intellectual property or contractual right of any party.
- You hereby irrevocably and unconditionally waive, discharge and release Nikon, its affiliates and subsidiaries, and their respective officers, directors, employees, agents, legal representatives, successors and assigns (“Nikon Parties”) from and against any and all claims by or against you related to any material you post, e-mail or otherwise transmit or communicate through the Service.
- Furthermore, you agree to indemnify, defend, and hold harmless the Nikon Parties from and against any claims, damages, liabilities, costs and expenses (including reasonable attorneys’ and professionals’ fees and litigation costs) related to any material you post, e-mail or otherwise transmit or communicate through the Service.
- You understand that (i) your right to use the Service may be terminated by Nikon and/or (ii) the materials you post, e-mail or otherwise transmit or communicate through the Service may be deleted or removed by Nikon in the event you breach the foregoing, or any other terms and conditions that Nikon may require in connection with your use of the Service.
- This Service is subject to change, suspension, or termination without notice.
- Be sure to read Nikon’s “Privacy Management Policy” at the website located at the following URL: <http://www.nikon.co.jp/main/eng/privacy/index.htm>
- If you are in Europe, click on your country of residence at the website located at the following URL and follow the link <privacy policy>: <http://www.europe-nikon.com/support/>

Parts of the Camera

Zoom control (☒ 26)

See also:

- **W** (wide): ☒ 26
- **T** (tele): ☒ 26
- **☒** (thumbnail playback): ☒ 52
- **Q** (playback zoom): ☒ 53
- **?** (help): ☒ 13

☒ (one-touch portrait) button
(☒ 50)

☒ (D-Lighting) button (☒ 56)

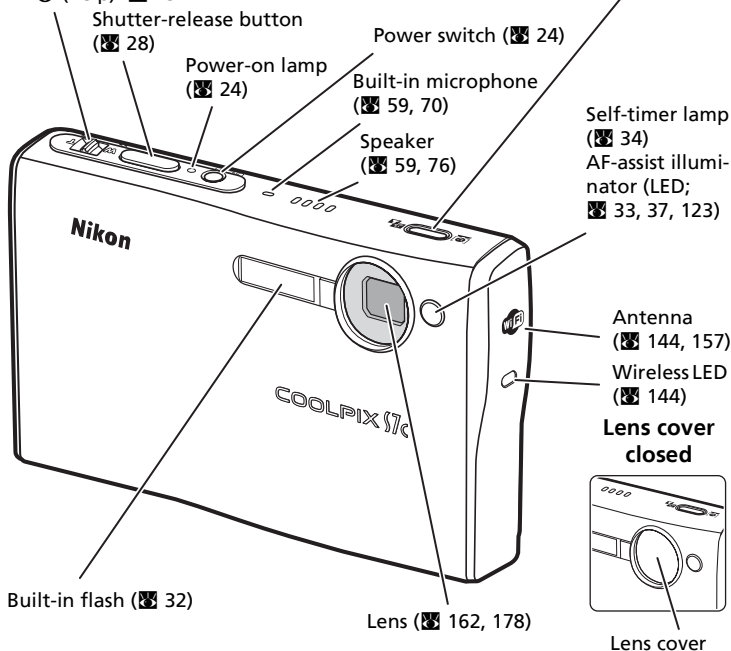

Attaching the Camera Strap

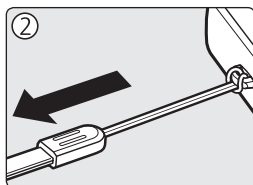
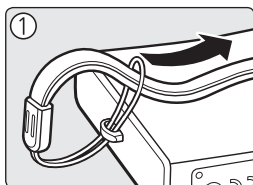

Rotary multi selector (12)

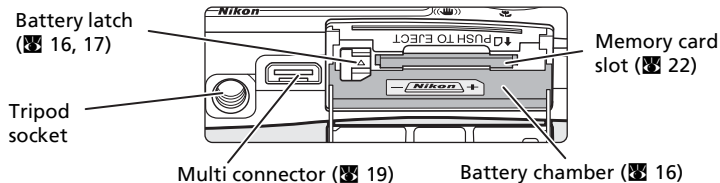
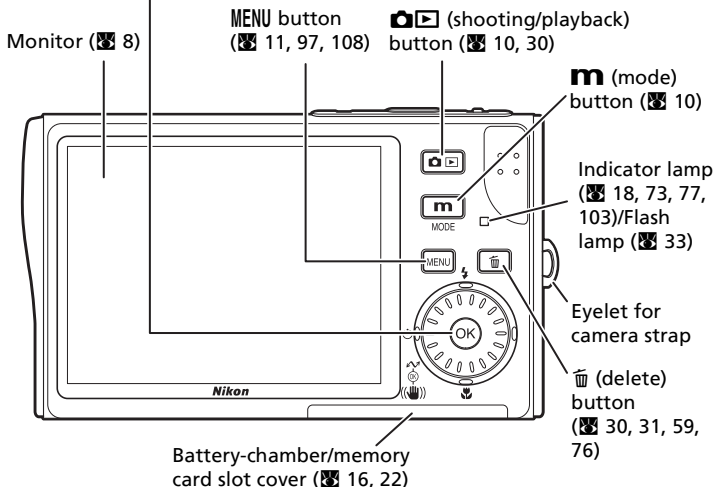
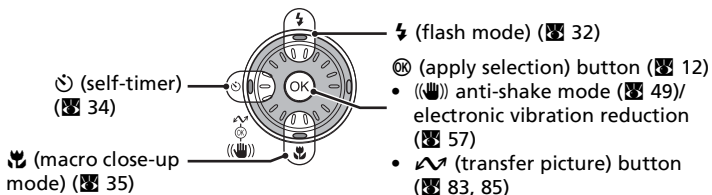

The Monitor

The following indicators may appear in the monitor during shooting and playback (actual display varies with current camera settings).

Shooting

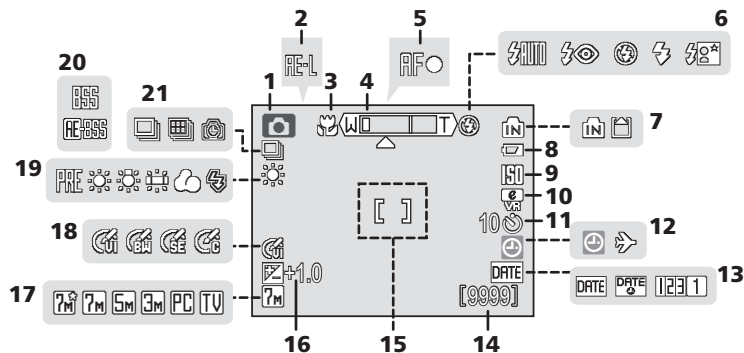

1	Shooting mode* 24, 36, 37, 49, 70, 77	12	"Date not set" indicator 165 Time zone indicator 117
2	Exposure lock 48	13	Date imprint 121
3	Macro close-up mode 35		Number of exposures remaining (still pictures) 24 Movie length 70
4	Zoom indicator 26, 35	14	Focus area 28, 106
5	Focus indicator 28	15	Exposure compensation value... 101
6	Flash mode 32	16	Image mode 97
7	Internal memory/memory card indicator 25	17	Color options 105
8	Battery level indicator 24	18	White balance mode 99
9	ISO sensitivity (ISO equivalent) 33	19	Best shot selector (BSS) 104
10	Vibration reduction icon 49	20	Continuous shooting mode 102
11	Self-timer indicator 34		

* Differs according to the current shooting mode. Refer to the sections on each mode for details.

Playback

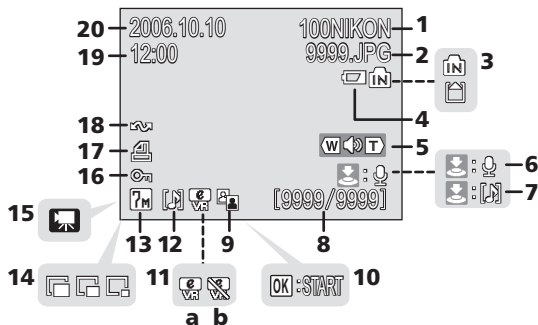



1	Current folder	160
2	File number and type.....	160
3	Internal memory/memory card indicator	25
4	Battery level indicator	24
5	Volume indicator.....	59, 76
6	Voice memo recording guide.....	59
7	Voice memo playback guide.....	59
8	Current frame number/total number of frames	30
	Movie length.....	76
9	D-Lighting icon	56
10	Movie playback indicator.....	76

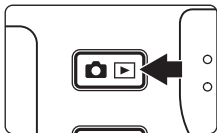

11	a Compensated image	57
	b Electronic VR not available.....	57
12	Voice memo icon.....	59
13	Image mode	97
14	Small picture	58
15	Movie indicator	76
16	Protect icon	111
17	Print-order icon	93
18	Transfer icon	86, 112
19	Time of recording	20
20	Date of recording	20

Basic Operations

The (shooting/playback) Button





Press  once in shooting mode to enter full-frame playback; press again to switch back to shooting mode.

If the camera is turned off, press  for about a second to turn the camera on in playback mode ( 30).

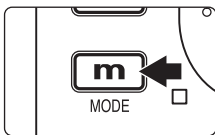
The (mode) Button



Press  during shooting or playback to display each mode-selection menu. Use the rotary multi selector ( 12) to choose the desired mode.

- Press  to switch between the mode-selection menus for shooting mode and playback mode.

Shooting Modes

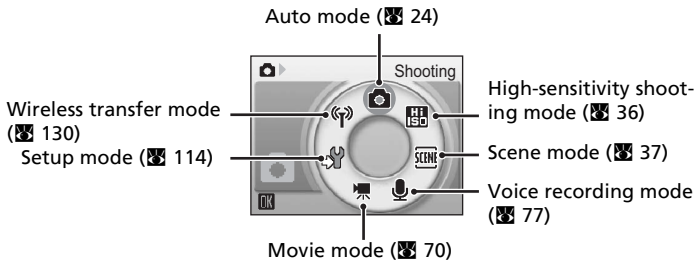

Playback Modes

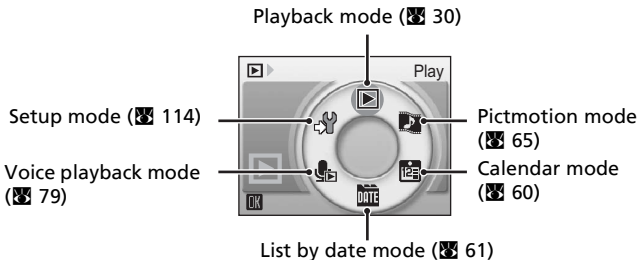

The MENU Button

Press **MENU** to display the menu for the selected mode. Use the rotary multi selector to navigate the menus (📷 12).

- 📷 Shooting menu (📷 96)
- 📷 High-sensitivity menu (📷 36)
- 📷 Scene menu (📷 37)
- 📷 Anti-shake menu*¹ (📷 49)
- 📷 One-touch portrait menu*² (📷 51)
- 📷 Movie menu (📷 71)
- ▶ Playback menu (📷 108)
- 📅 Calendar menu (📷 64)
- 📅 List-by-date menu (📷 64)
- 🖨️ Print menu (📷 90)
- ⚙️ Setup menu*³ (📷 114)
- 📶 Shoot-and-transfer menu (📷 154)

*¹ To display the anti-shake menu, enter anti-shake mode by pressing (📷) and then press **MENU**.

*² To display the one-touch portrait menu, enter one-touch portrait mode by pressing (📷) and then press **MENU**.

*³ To display the setup menu, choose ⚙️ in the mode-selection menu and then press OK (📷 114).



Displayed when there are one or more menu items to follow

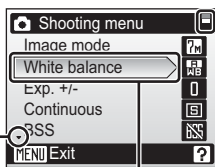

Displayed when the menu contains two or more pages

The selected option

Displayed when there are one or more previous menu items

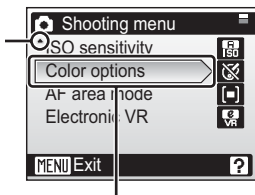

Press the rotary multi selector ▶ or OK to proceed to the next set of options.

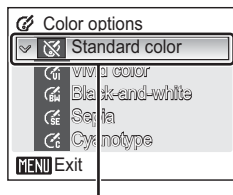

Press the rotary multi selector ▶ or OK to apply selection.

The Rotary Multi Selector

The rotary multi selector is made up of the outer ring, the rotating inner ring (between the outer ring and **OK** button), and the **OK** button. When selecting menus or pictures, you can either press the outer ring up, down, left, or right, or rotate the inner ring. When choosing from numerous menu items or pictures, it is recommended to rotate the inner ring for easy scrolling, and faster operation.

This section describes standard uses of the rotary multi selector to select modes, select menu options, and to apply selection.

For the Mode-selection Menu

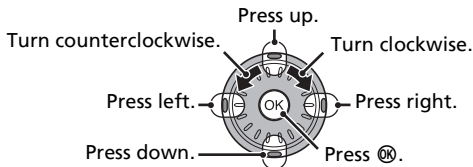



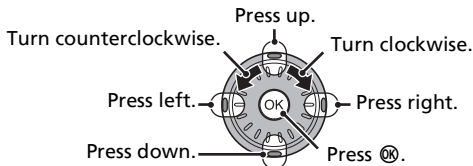
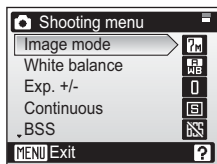

- To move the highlight clockwise, turn clockwise, press down or right.
- To move the highlight counterclockwise, turn counterclockwise, press up or left.
- To apply selection, press **OK**.

For the Menu Screen



- To move the highlight upward, turn counterclockwise, or press up.
- To move the highlight downward, turn clockwise, or press down.
- To apply selection, press right or **OK**.
- To cancel setting and return to the previous screen, press left.

Notes on the Rotary Multi Selector

- In many cases, you can choose how to use the rotary multi selector to perform an operation. For example, rotating the selector clockwise and pressing the selector right may produce the same results. Since the selector can be used in various ways, concrete descriptions such as “Press the rotary multi selector ” are included only in cases where necessary.
- In the manual, the button indicating up, down, left, and right of the rotary multi selector is shown as    .

Help Displays

Press the zoom control to **T** (🔍) to view a description of the currently selected menu option.

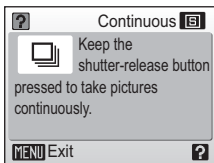
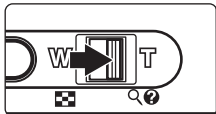

- Use the rotary multi selector to show the previous or next menu option.
- Press **OK** to display the shooting menu or setup menu for the selected menu option.
- To return to the original menu, press the zoom control to **T** (🔍) again.
- Press **MENU** to return to shooting or playback mode.

The COOL-STATION and AC Adapter

The COOL-STATION

The supplied MV-15 COOL-STATION can be used to:

- Charge the camera battery (when the camera is turned off) (📖 18)
- View pictures on a television (📖 82)
- Copy pictures to a computer (📖 83)
- Print pictures via direct USB connection (📖 87)

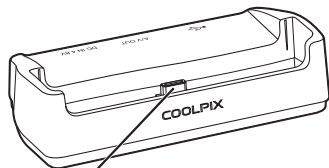

Camera connector

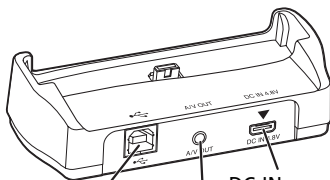

USB connector
(📖 85, 88)

DC-IN connector
(📖 15)
Audio / video connector
(📖 82)

Placing the Camera in the COOL-STATION

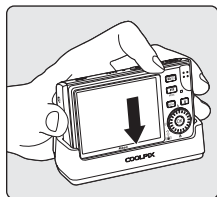

The multi connector should be fully inserted in the COOL-STATION camera connector as shown.

Removing the Camera

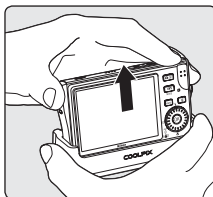

Remove the camera as shown.

📌 Note on the Power Cord Supplied for the Camera (📖 15)

Only use the power cord for the EH-64 AC adapter supplied for the COOLPIX S7c.

The AC Adapter

The supplied EH-64 AC adapter can:

- When the camera is turned on, power the camera from a power outlet.
- When the camera is turned off, charge the battery in the camera ( 18).

It can also be used to power the camera for playback, data transfer, or printing (recommended). *Do not use any other make or model of AC adapter; failure to observe this precaution could result in fire or product malfunction.*

Connecting the AC adapter

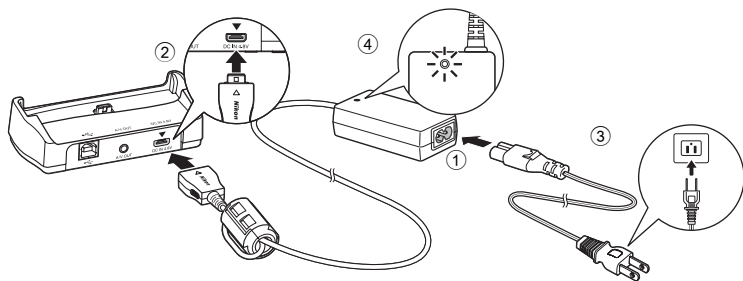

1 Connect the power cord. (①)

2 Plug the AC adapter into the COOL-STATION or camera. (②)

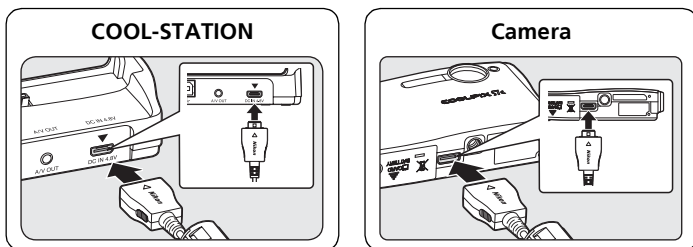

Make sure that the plugs are in the correct orientation. Inserting the plugs incorrectly may damage the COOL-STATION.

3 Plug the adapter in. (③)

When the adapter is connected correctly, the power on lamp will light. (④)

Inserting the Battery

The camera uses a rechargeable EN-EL8 lithium-ion battery (supplied). Charge the battery before first use or when the battery is running low (🔋 18).

- 1 Open the battery-chamber/memory card slot cover.

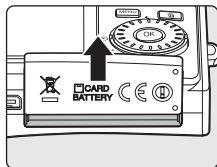

- 2 Insert the battery.

Confirm that the positive (+) and negative (-) terminals are oriented correctly as described on the label at the entrance of the battery chamber, and insert the battery.

The orange battery latch is pushed aside as the battery is inserted. The battery is fully inserted when the latch clicks back into place.

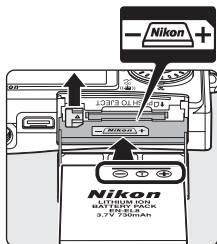

❑ Inserting the Battery

Inserting the battery upside down or backwards could damage the camera. Check to be sure the battery is in the correct orientation.

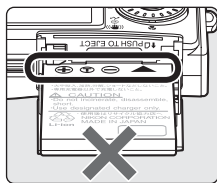

- 3 Close the battery-chamber/memory card slot cover.

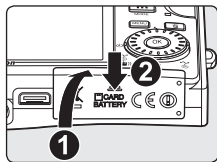

Removing the Battery

Turn the camera off before removing the battery. To eject the battery, open the battery-chamber/memory card slot cover and slide the battery latch in the direction shown (1). The battery can then be removed by hand (2).

- Note that the battery may become hot during use; observe due caution when removing the battery.

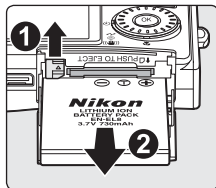

Turning On and Off the Camera

To turn on the camera, press the power switch. The power-on lamp will light and the monitor will turn on. To turn off the camera, press the power switch again.

If the camera is turned off, press for about a second to turn the camera on in playback mode (30).

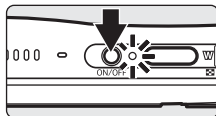

Note on the Battery

Be sure to read the warnings for the battery on page ii and “Caring for the Camera” (30) to make use of this camera.

Charging the Battery

Charge the battery before first use or when the battery is running low.

- 1** Connect the COOL-STATION and AC adapter, and plug the power cable into an outlet (🔌 15).

The AC adapter power-on lamp will light.

- 2** Turn the camera off.

If the power-on lamp is lit, press the power switch to turn off the camera. **You cannot charge the battery while the camera is turned on.**

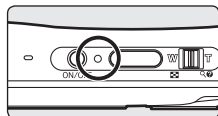

- 3** Place the camera in the COOL-STATION (🔌 14).

The multi connector should be fully inserted.

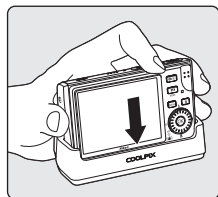

- 4** Charge the battery.

The indicator lamp next to the camera monitor will blink green as the battery charges. If the lamp flickers rapidly, the camera is not correctly inserted or the battery is faulty. Reinsert the camera or replace the battery.

A fully exhausted battery will recharge in about two hours.

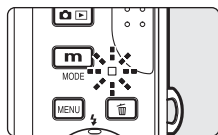

- 5** Charging is complete.

The indicator lamp stops blinking when charging is complete.

- 6** Remove the camera.

Make sure to unplug the power cable from the power outlet.

Charging Without the COOL-STATION

- Charging the battery is possible without using the COOL-STATION. Insert the battery into the camera, make sure that the camera is turned off, and connect the AC adapter to the multi connector of the camera directly (☒ 15).

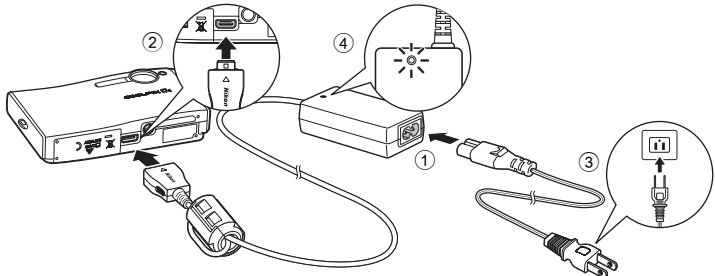

- The battery can also be charged using the optional MH-62 battery charger (☒ 159).

Setting Display Language, Date, and Time

A language-selection dialog is displayed the first time the camera is turned on.

- 1 Press the power switch to turn on the camera.

The power-on lamp (green) will light and the monitor will turn on.

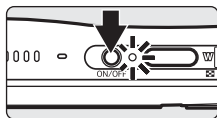

- 2 Use the rotary multi selector to choose the desired language and press **OK**.

For information on using the multi selector, see "The Rotary Multi Selector" (☒ 12).



- 3 Choose [Yes] and press **OK**.

If [No] is selected, the date and time will not be set.

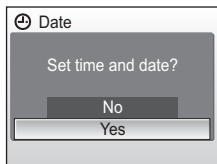

- 4 Press **OK**.

The home time zone menu is displayed.

If daylight saving time is in effect in the local time zone, see "Daylight Saving Time" on the next page.

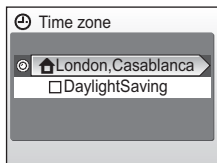

- 5 Select your home time zone and press **OK**.

The date menu is displayed.

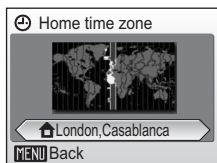

- 6** Edit the day ([D]) (order of the day, month, and year may differ in some areas) and press **OK**.

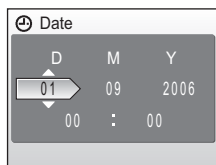

- 7** Edit the month ([M]) and press **OK**.

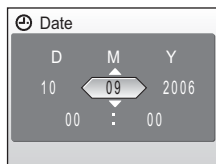

- 8** Repeat steps 6 and 7 to edit the year ([Y]), hour, and minutes. Press **OK** after setting each item.

The row for setting the order in which the date is displayed will blink.

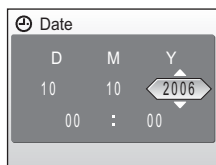

- 9** Choose the order in which the day, month, and year are displayed and press **OK**.

The settings are applied and monitor display returns to shooting mode.

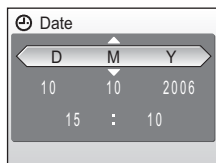

Daylight Saving Time

If daylight saving time is in effect, turn on [DaylightSaving] in the time zone menu in step 4 and set the date.

- 1 Use the rotary multi selector to choose [DaylightSaving].
- 2 Press **OK** to enable daylight saving time (✓).

The **OK** button toggles the daylight saving time option on and off.

- 3 Use the rotary multi selector to return to step 4 and proceed to step 5.

When daylight saving time ends, turn [DaylightSaving] off from the date menu (**OK** 117) in the setup menu. The camera's clock is automatically set back one hour.

Inserting Memory Cards

Pictures are stored in the camera's internal memory (14 MB) or on removable Secure Digital (SD) memory cards (available separately) (📷 159).

If a memory card is inserted in the camera, pictures are automatically stored on the memory card and only pictures recorded to the memory card can be played back, deleted, or transferred. Remove the memory card to store pictures in the internal memory, or play back or delete pictures from the internal memory.

- 1** Turn the camera off and open the battery-chamber/memory card slot cover.

If the power-on lamp is lit, press the power switch to turn off the camera.

Make sure that the camera is off (power-on lamp is off) before inserting or removing the memory card.

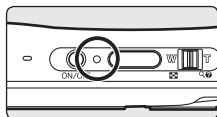

- 2** Insert the memory card.

Slide the memory card in until it clicks into place.

Close the battery-chamber/memory card slot cover.

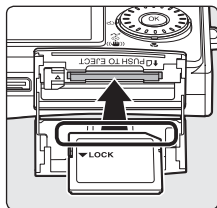

❑ Inserting Memory Cards

Inserting the memory card upside down or backwards could damage the camera or the memory card. Make sure that the memory card is correctly oriented when inserting.

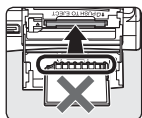

Removing Memory Cards

Before removing memory cards, **turn the camera off** and confirm that the power-on and indicator lamps are off. Open the battery-chamber/memory card slot cover and press the card in (1) to partially eject the card (2). The card can then be removed by hand.

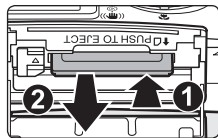

✓ Formatting Memory Cards

If the message at right is displayed, the memory card must be formatted before use (☒ 125). Note that **formatting permanently deletes all pictures** and other data on the memory card. Be sure to make copies of any pictures you wish to keep before formatting the memory card.

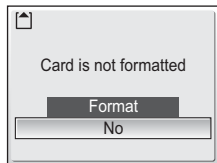

Use the rotary multi selector to choose [Format] and press (OK). The screen shown at right will be displayed. To start formatting, choose [Format] again and press (OK).

- **Do not turn the camera off or remove the battery or memory card until formatting is complete.**
- The first time you insert the memory cards used in other devices into the COOLPIX S7c, be sure to format them with [Format] (☒ 125).

✓ The Write Protect Switch

SD memory cards are equipped with a write protect switch. Pictures cannot be recorded or deleted and the memory card cannot be formatted when this switch is in the "lock" position. Unlock by sliding the switch to the "write" position.

Write protect switch

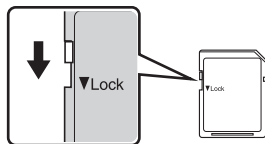

✓ Memory Cards

- Use only Secure Digital memory cards.
- Do not perform the following during formatting, while data are being written to or deleted from the memory card, or during data transfer to a computer. Failure to observe this precaution could result in the loss of data or in damage to the camera or memory card.
 - Eject the memory card
 - Remove the battery
 - Turn off the camera
 - Disconnect the AC adapter
- Do not disassemble or modify.
- Do not drop, bend, or expose to water or strong physical shocks.
- Do not touch the metal terminals with your fingers or metal objects.
- Do not affix labels or stickers to the memory card.
- Do not leave in direct sunlight, closed vehicles, or areas exposed to high temperatures.
- Do not expose to humidity or to corrosive gases.

Step 1 Turn the Camera On and Select (Auto) Mode

This section describes how to take pictures in  (auto) mode, an automatic, “point-and-shoot” mode recommended for first-time users of digital cameras.

1 Press the power switch.

The power-on lamp will light and the monitor will turn on.

Proceed to step 4 when  is displayed.

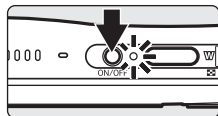

2 Press **m**.

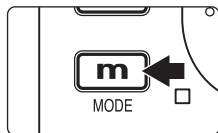

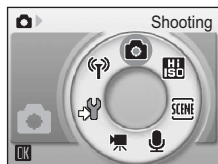

3 Use the rotary multi selector to choose and press **OK**.

The camera enters  (auto) mode.



4 Check the battery level and number of exposures remaining.

Battery level

Monitor	Description
NO INDICATOR	Battery fully charged.
	Battery low; charge or replace the battery.
Warning! Battery exhausted 	Battery exhausted. Recharge or replace with a fully charged battery.

Battery level indicator

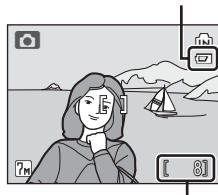



Number of exposures remaining

Number of exposures remaining

The number of pictures that can be stored depends on the capacity of the memory or memory card and image mode setting.

Indicators Displayed in (Auto) Mode

Shooting mode
 displayed in  (auto) mode

Internal memory/memory card

















	Pictures will be recorded to internal memory.
	Pictures will be recorded to memory card.



Image mode
 Choose from six options depending on how you plan to use the picture.
 The default setting is  Normal(3072 × 2304).

Available Functions in (Auto) Mode

In  (auto) mode, macro close-up mode ( 35) can be applied and pictures can be taken using the flash ( 32) and self-timer ( 34). Pressing **MENU** in  (auto) mode displays the shooting menu. This menu allows you to specify the image mode ( 97), white balance setting ( 99), and to apply exposure compensation ( 101), continuous shooting ( 102), BSS ( 104), ISO sensitivity ( 105), color options ( 105), AF area ( 106), and electronic VR ( 57) to suit shooting conditions or your own preferences.

Auto Power Off in (Auto) Mode (Standby Mode)

The monitor will dim to reduce the drain on the battery if no operations are performed for about five seconds. The monitor will brighten when camera controls are used. At default settings, the monitor will turn off altogether if no operations are performed for about a minute during shooting and playback. The camera will turn off automatically if no operations are performed for another three minutes ( 124).

Step 2 Frame a Picture

1 Ready the camera.

Hold the camera steadily in both hands, keeping your fingers and other objects away from the lens, flash, and self-timer lamp.

When taking pictures in “tall” orientation, turn the camera so that the built-in flash is above the lens.

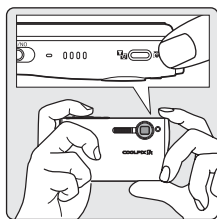

2 Frame the picture.

Position the main subject near the center of the monitor.



Using the Zoom

Use the zoom control to activate optical zoom. Press to **W** (📐) to zoom out, increasing the area visible in the frame, or to **T** (🔍) to zoom in so that the subject fills a larger area of the frame.

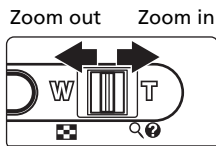

When the camera is zoomed in to the maximum magnification (3 \times), holding the zoom control down to **T** (🔍) triggers digital zoom. The subject is magnified up to 4 \times , for a total magnification of 12 \times .

A monitor indicator shows the current zoom ratio.



Zoom indicator displayed when the zoom control is pressed.



Optical zoom (up to 3 \times)



Zoom indicator turns yellow when digital zoom is in effect.

✓ Digital Zoom

Unlike optical zoom, data from the camera's image sensor are processed digitally with digital zoom. Details visible at maximum optical zoom are simply enlarged, producing a slightly “grainy” image.

Electronic VR

Electronic VR (📷 106) will be enabled in 📷 (auto) mode according to shooting conditions and may be applied to blurred pictures when they are recorded (📷 is displayed in the monitor when shooting).

Electronic VR can be set to [Off] in the [Electronic VR] option of the shooting menu (📷 96).

- [Electronic VR] is enabled in [Night portrait] and [Party/indoor] scene modes. Note that in these scene modes, [Electronic VR] cannot be set to [Off].
- [Electronic VR] can also be applied to pictures taken during playback (📷 57).



📷 High-sensitivity Shooting Mode

With high-sensitivity shooting mode (📷 36), a higher sensitivity is set and the shutter speed is faster than in 📷 (auto) mode, reducing blurred pictures resulting from subject movement. This mode is also suited for reducing the effects of camera shake when taking pictures in dark places.

📷 Anti-shake Mode

When anti-shake mode (📷 49) is used, [Electronic VR] (📷 106) and [BSS] (best shot selector) (📷 104) are enabled to reduce effects of camera shake and blurred subjects, producing clear images. With BSS enabled, the camera takes shots to a maximum of ten, they are compared, and the sharpest picture (picture with the highest level of detail) is saved. A higher sensitivity is set, and the shutter speed will be faster than in 📷 (auto) mode.

Step 3 Focus and Shoot

1 Press the shutter-release button halfway.

The camera focuses on the subject at the center of the frame.

When the subject is in focus, the focus indicator (AF●) is green.

When the camera is unable to focus, the focus indicator blinks red. Change the composition and try again.

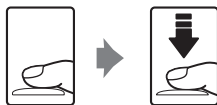

2 Press the shutter-release button the rest of the way down.

The picture will be recorded to the memory card or internal memory.

The flash may fire or the AF-assist illuminator may light if the subject is poorly lit.



Shutter-Release Button

The camera features a two-stage shutter-release button. To set focus and exposure, press the shutter-release button halfway, stopping when you feel resistance. Focus and exposure lock while the shutter-release button is held in this position. To release the shutter and take a picture, press the shutter-release button the rest of the way down. Do not use force when pressing the shutter-release button, as this may result in camera shake and blurred pictures.



✓ During Recording

While pictures are being recorded, the ⏸ (wait) icon will be displayed, and the 📄 (recording to memory card) or 📶 (recording to internal memory) icon will blink. Do not turn the camera off, eject the memory card, or remove or disconnect the power source while these icons are displayed. Cutting power or removing the memory card in these circumstances could result in loss of data or in damage to the camera or card.

📷 Focus Lock

To focus on off-center subjects when [Center] is selected for [AF area mode] (📷 106), use focus lock as described below. Focus lock is also effective to situations where focusing is difficult.*

- 1 Position the subject in the center of the frame.
- 2 Press the shutter-release button halfway.
 - Confirm that the focus indicator (AF●) is green.
- 3 Continue holding down the shutter-release button halfway and recompose the picture.
 - Be sure that the distance between the camera and the subject does not change.
- 4 Press the shutter-release button the rest of the way down.



* Focus lock is recommended in the following situations, where auto focus may not produce the desired results:

- Subject is very dark
- Objects of sharply differing brightness are included in the scene (e.g., the sun is behind the subject and is in deep shadow)
- No contrast between the subject and surroundings (e.g., when the subject is standing in front of a white wall, wearing a white shirt)
- Several objects are at different distances from the camera (e.g., the subject is inside a cage)
- Subject is moving rapidly

Step 4 Viewing and Deleting Pictures

Full-Frame Playback

Press .

The last picture taken will be displayed.

Use the rotary multi selector to view additional pictures. Rotate quickly to scroll rapidly to the desired picture.

Pictures taken in “tall” orientation will be rotated automatically (124). The rotating direction can be changed (112).

Pictures may be displayed briefly at low resolution while being read from the memory card or internal memory.

Press again to switch to shooting mode.

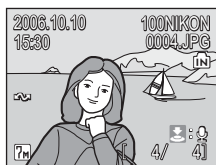
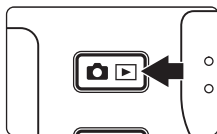

Deleting Pictures

- 1 Press to delete the picture currently displayed in the monitor.

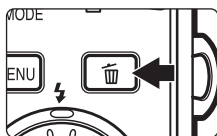





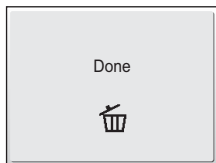
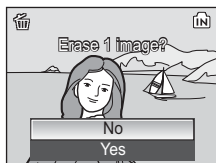



- 2 Use the rotary multi selector to select [Yes] and press .

To exit without deleting the picture, choose [No] and press .





Full-Frame Playback Mode

The following options are available in full-frame playback mode.

Option	Press	Description	
Playback zoom	Zoom control to T (Q)	Enlarge view of picture currently displayed in monitor up to about 10x.	53
View thumbnails	Zoom control to W ()	Display four, nine, sixteen or twenty-five picture thumbnails.	52
Record/play voice memo		Record or play back voice memos up to 20 seconds in length.	59
D-Lighting		Enhance brightness and contrast in dark portions of pictures.	56
Electronic VR		Press  while displaying a picture to compensate a blurred image.	57
Play back movies		Press  while displaying a movie to play back movies.	76
View playback menu	MENU	Display the playback menu.	108
View playback mode menu	m	Display the playback mode-selection menu.	10
Switch to shooting mode		Switch to the shooting mode selected last time.	30

Quick Playback Zoom

Pressing the zoom control to **T** (Q) during full-frame playback zooms the current picture in 3x, with the center of the picture displayed in the monitor (Quick Playback Zoom) ( 53).

Press  to return to full-frame playback.

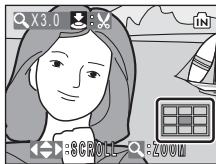

In Quick Playback Zoom, even pictures displayed in “tall” orientation will be displayed in “wide” orientation.



Viewing Pictures

- When the camera is off, pressing  for one second will turn the camera on in playback mode.
- Pictures stored in the internal memory can only be viewed if no memory card is inserted.

Deleting the Last Picture Taken

In shooting mode, press  to delete the last picture taken. The confirmation dialog shown at right will be displayed. Use the rotary multi selector to choose [Yes] and press .

- To exit without deleting the picture, choose [No] and press .

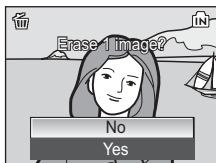



Using the Flash

The flash has a range of 0.3–7.5 m (1 ft.–24 ft.) when the camera is zoomed out all the way. With maximum optical zoom applied, the range is 0.3–4 m (1 ft.–13 ft.). The following flash modes are available:

 **Auto (default for  (auto) mode)**

Flash fires automatically when lighting is poor.

 **Auto with red-eye reduction**

Reduces “red-eye” in portraits ( 33).

 **Off**

Flash will not fire even when lighting is poor.

 **Fill flash**

Flash fires whenever a picture is taken. Use to “fill-in” (illuminate) shadows and back-lit subjects.

 **Slow sync**

Flash illuminates main subject; slow shutter speeds are used to capture background at night or under dim light.



1 Press (flash mode).

The flash menu is displayed.



2 Use the rotary multi selector to choose the desired flash mode and press .

The icon for the selected flash mode is displayed at the top of the monitor.

When [Monitor settings] ( 120) is set to [Auto info], the icon for the selected flash mode is only displayed for five seconds after the setting is applied. When set to [Show info], the  icon will only be displayed for five seconds after the setting is applied. All other icons will remain displayed.

The flash mode applied in  (auto) mode and high-sensitivity shooting mode is stored in the camera's memory even after the camera is turned off.

If a setting is not applied by pressing  within five seconds, the selection will be cancelled.

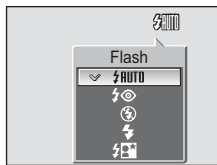

✔ The Ⓞ (Off) Indicator

Note the following when lighting is poor and the flash is off (Ⓞ).

- Place the camera on a flat, level surface or use a tripod (recommended).
- The **ISO** is displayed when the camera automatically increases sensitivity to minimize blur caused by slow shutter speed. Pictures taken when **ISO** is displayed may be slightly mottled.

✔ Note on Using the Flash

When using the flash at a wide-angle zoom position, reflections from dust particles in the air may appear as bright spots in pictures. To reduce these reflections, set the flash to Ⓞ (Off) or zoom in on the subject.

✍ The AF-assist Illuminator

If lighting is poor, the AF-assist illuminator may light to assist the focus operation when the shutter-release button is pressed halfway. The illuminator has a maximum range of about 1.9 m/6 ft. 2 in. (**W**) to 1.1 m/3 ft. 6 in. (**T**). The AF-assist illuminator can be turned off manually (Ⓞ 123), although in this case the camera may not focus when lighting is poor.

✍ The Flash Lamp

The flash lamp indicates flash status when the shutter-release button is pressed halfway.

- **On:** Flash will fire when picture is taken.
- **Blinks:** Flash charging. Wait a few seconds and try again.
- **Off:** Flash will not fire when picture is taken.

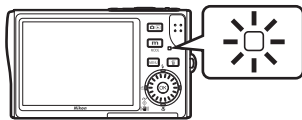

✍ Red-Eye Reduction

The COOLPIX S7c is equipped with an advanced red-eye reduction system. Pre-flashes are fired several times at low intensity before the main flash to reduce “red-eye.” If the camera detects “red-eye” after a picture is taken, Nikon’s own In-Camera Red-Eye Fix processes the image as it is recorded. Therefore, there is a slight delay before the shutter-release button operates normally to take another picture.

- Not recommended for when shutter-release timing is essential.
- Red-eye reduction may not always produce the desired results.
- In some rare cases, other portions of pictures may be affected.

Use flash modes other than auto with red-eye reduction in above cases.

Taking Pictures with the Self-Timer

The camera is equipped with a ten-second and three-second timer for self-portraits. When using the self-timer, mount the camera on a tripod (recommended) or rest it on a flat, level surface.

1 Press (self-timer).

The self-timer menu is displayed.

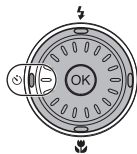

2 Use the rotary multi selector to choose [10s] or [3s] and press .

[10s] (10 seconds): suited for important occasions (such as weddings)

[3s] (3 seconds): suited for preventing camera shake

The mode selected for self-timer is displayed.

If a setting is not applied by pressing  within five seconds, the selection will be cancelled.

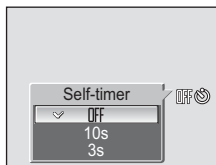

3 Frame the picture and press the shutter-release button halfway.

Focus and exposure will be set.

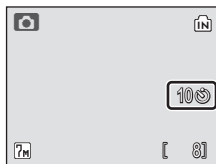

4 Press the shutter-release button fully.

The self-timer starts and the self-timer lamp will blink. The lamp stops blinking one second before the photograph is taken and remains lit until the shutter is released.

The number of seconds remaining before the shutter is released is displayed in the monitor.

To stop the timer before a picture is taken, press the shutter-release button again.

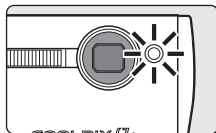
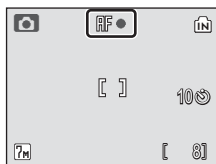

Macro Close-up Mode

Macro close-up mode is used for taking shots of pictures as close as 4 cm (1.6 in.). Note that the flash may be unable to light entire subject at distances of less than 30 cm (11.8 in.).

1 Press (macro mode).

The macro close-up menu is displayed.





2 Use the rotary multi selector to choose [ON] and press .

The macro close-up mode icon () is displayed.

The monitor will return to the normal display for the current mode if the setting is not applied by pressing  within five seconds.



3 Press the zoom control to **T** () or to **W** () to frame the picture.

The camera can focus at distances as close as 4 cm (1.6 in.). Zoom is available when  () is green.

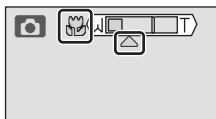

4 Press the shutter-release button fully.

The macro close-up mode applied in  (auto) mode is stored in the camera's memory even after the camera is turned off.

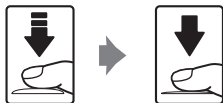



Macro Close-up Mode

In macro close-up mode, the camera focuses continuously, even when the shutter-release button is not pressed halfway.

High-sensitivity Shooting Mode

High-sensitivity shooting mode offers the following features:

- A higher sensitivity is set and the shutter speed will be faster than in  (auto) mode.
- Camera shake or blurred subjects will be avoided even in poorly-lit rooms, in sunset, or in night view scenes.
- This mode is suited for shooting in dark places compared with shooting in anti-shake mode ( 49).

- 1 Enter high-sensitivity shooting mode by pressing **m** in shooting mode, selecting  (use the rotary multi selector), and then pressing **OK**.

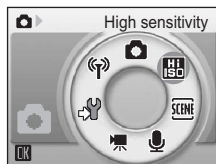

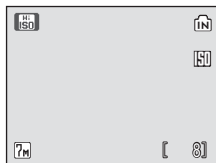

- 2 Frame the subject and take the picture.



Notes on High-sensitivity Shooting Mode

- This mode reduces effects of camera shake or blurred subjects even in dark places; use of a tripod is recommended when the shutter speed is low.
- Pictures taken in this mode may become somewhat grainy.
- Focus may not be precisely fixed in extremely dark places.

Menu for High-sensitivity Shooting

Press **MENU** in high-sensitivity shooting mode to display the high-sensitivity menu. The same menu items can be set as in the shooting menu ( 96) for  (auto) mode. [ISO sensitivity] and [Electronic VR] are not available in high-sensitivity shooting mode.

Assist Modes and Scene Modes

The camera offers a choice of fifteen “scene” options. Camera settings are automatically optimized for the selected subject type.

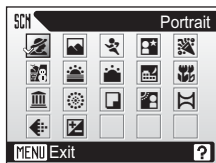

Assist Modes (Four Options)

The following modes offer framing assist options to help you compose your shots.



Portrait

Use for portraits. The main subject stands out clearly while the background details are softened, lending a sense of depth to the composition.



Landscape

Use for vivid landscape shots that enhance outlines, colors, and contrast in subjects such as skyscrapers and forests.



Sports

Fast shutter speeds freeze fast-moving subjects for dynamic sports scenes.



Night portrait

Use for a natural balance between the main subject and background lighting in portraits taken at night.

Scene Modes (Eleven Options)

The following modes allow you to take pictures optimized for a particular subject type by simply choosing a scene mode and pressing the shutter-release button.











 Party/indoor	 Night landscape	 Copy
 Beach/snow	 Close up	 Back light
 Sunset	 Museum	 Panorama assist
 Dusk/dawn	 Fireworks show	



Image Mode and Exposure Compensation

[ Image mode] ( 97) and [ Exp. +/-] ( 101) can be set in the scene menu and framing assist menu. Changes made to these settings apply to all shooting modes. Settings made for exposure compensation are reset when the camera is switched to another mode.

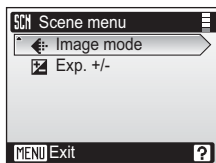

Assist Modes

Compose pictures with the help of framing guides displayed in the monitor.

Taking Pictures in Assist Modes

- 1 Enter scene mode by pressing **m** in shooting mode, selecting **SCENE** (use the rotary multi selector), and then pressing **OK**.



- 2 Press **MENU** to display the scene menu.

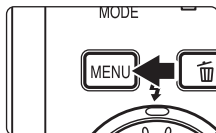

- 3 Choose an assist mode and press **OK**.
The framing assist menu is displayed.

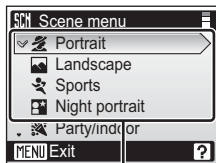

Assist modes

- 4 Choose the appropriate composition and press **OK**.

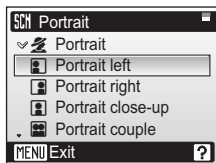

- 5 Position the subject in the framing guide and take the picture.

Framing guides are displayed if available.



Portrait Assist

Use this mode for portraits in which the main subject stands out clearly. Portrait subjects exhibit smooth, natural-looking skin tones.



Portrait

Camera focuses on subject in the center of the monitor. No guides are displayed in the monitor.



Portrait left

Compose shot with subject in left half of frame. Camera focuses on subject inside the framing guides.



Portrait right

Compose shot with subject in the right half of frame. Camera focuses on subject inside the framing guides.



Portrait close-up

Compose shot with subject's face in top half of frame. Camera focuses on face inside the framing guides.



Portrait couple

Compose shot with two subjects side-by-side. Camera focuses on subjects inside the framing guides.



Portrait figure



Compose shot in "tall" orientation. Camera focuses on subject inside the framing guides. Pictures taken in "tall" orientation are displayed in the same "tall" orientation in the monitor.



¹ Other settings can be selected.

² AF-assist illumination is automatically enabled for [Portrait].

(AF-Assist Illumination)

 stands for the AF-assist illumination, which has two options; [Auto] and [Off] ( 123). Even when set to [Auto], the  indicator will not be displayed in the monitor.

Landscape Assist

Use this mode for vivid landscapes, cityscapes, and portraits featuring a landmark in the background.



Landscape

Camera focuses at infinity. No guides are displayed in the monitor.



Scenic view

Use to photograph distant skylines. Camera focuses at infinity. Match top of skyline with wavy yellow guide.



Architecture

Use to photograph buildings. Camera focuses at infinity. A grid is displayed in the monitor to help keep verticals and horizontals aligned with the frame.



Group right

Use to compose portraits with portrait subjects to right and landmark or other objects in background at left of frame.



Group left

Use to compose portraits with portrait subjects to left and landmark or other objects in background at right of frame.



¹



Off²



Off



Off

¹ Flash is set to  for [Group left] and [Group right]. Other settings can be selected.

² Other settings can be selected.



Focusing at Infinity

The focus indicator ( 28) is always green when the shutter-release button is pressed half-way when [Landscape], [Scenic view], or [Architecture] is selected for landscape assist mode. Note, however, that objects in the foreground may not always be in focus.

Sports Assist

Use this mode for dynamic action shots that freeze the action in a single shot or record motion in a series of pictures. No framing guides are displayed.



Sports

Pictures are taken continuously while the shutter-release button is pressed. When the image mode is  Normal(3072), camera takes 7 shots at about 1.4 frames per second. Camera focuses continuously even when the shutter-release button is not pressed halfway.

Sport spectator

As above, except that camera focuses at ranges of about 4.5 m (14.8 ft.) to infinity at maximum wide-angle zoom position and about 6 m (19.7 ft.) to infinity at maximum telephoto position.

Sport composite

Each time shutter-release button is pressed, camera takes 16 shots in about 2.4 seconds and arranges them in four rows to form a single picture ( Normal (1600)). Camera focuses continuously even when the shutter-release button is not pressed halfway.

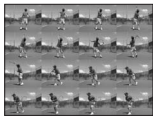

Sports Assist

When [Sports] or [Sport composite] is selected in sports assist mode, the camera focuses continuously on the center of the frame, even when the shutter-release button is not pressed halfway.

Night Portrait Assist

Use this mode to achieve a natural balance between the main subject and background lighting in portraits taken at night. This mode offers the same assist options as portrait assist mode ( 39).

- Electronic VR will be applied when shooting at slow shutter speeds ( 106).



¹ Fill flash with slow sync and red-eye reduction.

² Other settings can be selected.

³ AF-assist illumination is automatically enabled for [Night portrait].

: Use of a tripod is recommended.

: Noise reduction may be automatically applied as pictures taken are recorded; results in increased recording times.

Scene Modes

Taking Pictures in Scene Modes

- 1** Enter scene mode by pressing **m** in shooting mode, selecting **SCENE** (use the rotary multi selector), and then pressing **OK**.



- 2** Press **MENU**.

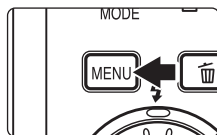

- 3** Choose a scene mode and press **OK**.

Three pages of scene modes are available, beginning with [Party/indoor] and ending with [Panorama assist].



Scene modes

- 4** Frame the subject and take the picture.

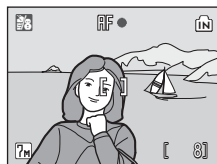

Features

 Party/indoor

Captures the effects of candlelight and other indoor background lighting.

- Camera focuses on subject in center of frame.
- Hold the camera steadily to prevent camera shake in dark places.
- Electronic VR ( 106) will be applied when flash mode is set to fill flash with slow sync and red-eye reduction, off, slow sync, or when shutter speed is slow.



¹ Fill flash with slow sync and red-eye reduction. Other settings can be selected.

² Other settings can be selected.

 Beach/snow

Captures the brightness of such subjects as snowfields, beaches, or sunlit expanses of water.

- Camera focuses on subject in center of frame.



¹ Other settings can be selected.

 Sunset

Preserves the deep hues seen in sunsets and sunrises.

- Camera focuses on the subject in the center of the frame.



¹ Other settings can be selected.

 Dusk/dawn

Preserves the colors seen in the weak natural light before sunrise or after sunset.

- Camera focuses at infinity. The AF indicator ( 28) always lights; however, focus may not be set for near subjects, while the camera focuses at infinity.



¹ Other settings can be selected.

Night landscape



Slow shutter speeds are used to produce stunning night landscapes.

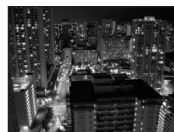

- Camera focuses at infinity. The AF indicator ( 28) always lights; however, focus may not be set for near subjects, while the camera focuses at infinity.



¹ Other settings can be selected.

Close up

Photograph flowers, insects, and other small objects at close range.

- The camera can focus at distances as close as 4 cm (1.6 in.). Zoom is available when  is green.
- Camera focuses continuously until shutter-release button is pressed halfway to lock focus.
- Macro close-up shooting ( 35) can be used for this option.
- Hold the camera steadily to prevent camera shake.



¹ Other settings can be selected.

Museum

Use indoors where flash photography is prohibited (for example, in museums and art galleries) or in other settings in which you do not want to use the flash.

- Camera focuses on subject in center of frame.
- BSS ( 104) turns on automatically.
- Hold the camera steadily to prevent camera shake.



¹ Other settings can be selected.

: Use of a tripod is recommended.

: Noise reduction may be automatically applied as pictures taken are recorded; results in increased recording times.

Scene Modes

Fireworks show

Slow shutter speeds are used to capture the expanding burst of light from a firework.

- Camera focuses at infinity. The AF indicator ( 28) always lights; however, focus may not be set for near subjects, while the camera focuses at infinity.
- [Exp +/-] cannot be applied.



Copy

Provides clear pictures of text or drawings on a white board or in print.

- Camera focuses on subject in center of frame.
- Use macro close-up mode ( 35) to focus at short ranges.
- Colored text and drawings may not show up well.

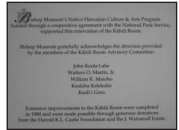

¹ Other settings can be selected.

Back light

Use when light is coming from behind your subject, throwing features or details into shadow. The flash fires automatically to “fill in” (illuminate) shadows.

- Camera focuses on subject in center of frame.



¹ Other settings can be selected.

☞ Panorama assist



Use when taking a series of pictures that will later be joined to form a single panorama using PictureProject.



¹ Other settings can be selected.

Taking Pictures for a Panorama

The camera focuses on the subject in the center of the frame. Use a tripod for best results.

- 1 Use the rotary multi selector to choose [☞ Panorama assist] in the scene menu and press **OK**.

The yellow panorama direction icon (☞) is displayed to show the direction in which pictures will be joined.

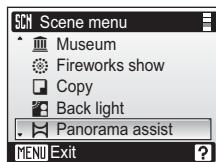

- 2 Choose the direction and press **OK**.

Select how pictures will be joined together in the completed panorama; right (☞), left (☜), up (☒), or down (☑). The panorama direction icon (☞) is displayed to the direction pressed, and changes to white when **OK** is pressed. Set the flash (🔆 32), self-timer (⌚ 34), and macro close-up mode (🌿 35) in this step, if necessary. Press **▶** to reselect the direction.



- 3 Take the first picture.

The first picture is displayed in the first third of the monitor.



4 Take the second picture.

Compose the next picture so that it overlaps the first picture.

Repeat until you have taken the necessary number of pictures to complete the scene.



5 Press the rotary multi selector ► when shooting is completed.

The camera returns to step 2.



Panorama Assist

Flash mode (32), self-timer (34), and macro close-up (35) cannot be adjusted after the first picture is taken. Pictures cannot be deleted, nor can zoom or image-mode setting (97) be adjusted until the series is finalized.

Exposure Lock

AE-L (white) is displayed to show that white balance and exposure have been locked at the values set with the first shot. All pictures taken in a panorama series have the same exposure and white-balance settings.



Shooting in Anti-shake Mode

Anti-shake mode offers the following features:

- This mode reduces effects of camera shake or blurred subjects, and produces clear images.
- [Electronic VR] (🔑 106) and [BSS] (best shot selector) are enabled. Electronic VR compensates blurred images. BSS is on, camera takes shots to a maximum of ten, they are compared and sharpest picture (picture with highest level of detail) is saved (🔑 104).
- The higher sensitivity is set and the shutter speed will be faster than in 📷 (auto) mode.
- Flash mode and self-timer are set to off.

1 Press **OK** (👉) (anti-shake).

The camera enters anti-shake mode. Press again to return to the shooting mode selected with the mode-selection menu.



2 Frame the subject and take the picture.

When vibration is detected during shooting, automatic compensation is activated.

When compensation is complete, new copy is stored. The 📄 icon (🔑 8) for the new copy is displayed when played back.

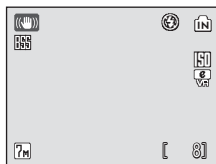



✔ Notes on Anti-shake Mode

- Shutter speed is limited to a certain value for dark subjects.
- Use of the high-sensitivity mode (🔑 36) is recommended for shooting subjects in dark places.
- Pictures taken in this mode may become somewhat grainy.
- Even if [Date imprint] (🔑 121) is enabled, the date will not be imprinted.

📷 Image Mode and Exposure Compensation in Anti-shake Mode

When **MENU** is pressed in anti-shake mode, the menu is displayed to enable set the image mode (🔑 97) or exposure compensation (🔑 101). Settings made for exposure compensation are reset when the camera is switched to another mode.

Taking Pictures in the One-Touch Portrait Mode

For portrait shots, press the  button when the camera is in  (auto) mode, high-sensitivity shooting mode, scene mode, movie mode, and anti-shake mode.

The following features are automatically activated:

- Portrait: The portrait subject stands out clearly.
- Face-priority AF: The camera automatically detects and focuses on faces.
- Advanced red-eye reduction: Reduces “red-eye” caused by the flash ( 33). Macro close-up is not available in one-touch portrait mode.

Press  again to return to the shooting mode selected with the mode-selection menu.

1 Press (one-touch portrait mode).

A yellow  guide is displayed.

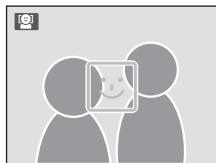

2 Frame a picture using the guide.

When the camera detects a face, the guide is displayed with a double yellow border.

When the camera detects more than one face, the closest face is framed by a double border and the rest by a single border. The camera focuses on the face framed by the double border. If the camera loses its ability to detect a face (for example, because the subject has looked away from the camera), borders are no longer displayed and monitor display returns to that shown in step 1.

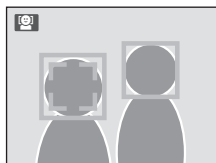

3 Press the shutter-release button halfway.

Focus and exposure are set, and the double border turns green.

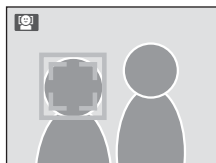

4 Press the shutter-release button the rest of the way down to take a picture.



The One-Touch Portrait Menu

Press **MENU** in one-touch portrait mode to display the one-touch portrait menu. In addition to image mode and exposure compensation, portrait effects (reducing vividness of skin tones, softening overall image) can be set.

Image mode¹

Choose an image size and quality ( 97).

Exp. +/-²

Adjust exposure for very bright or very dark subjects ( 101).

Portrait effect¹

Choose from [Normal], [Brighter] (reduces vividness of skin tones), and [Softer] (soft effect).

¹ The options chosen in this menu are stored until [Reset all] ( 127) is performed in the setup menu.

² The options chosen in this menu will be reset by switching to other shooting modes.

Face-Priority AF

- The camera's ability to detect faces depends on a variety of factors, including whether or not the subject is facing the camera.
- The camera focuses continuously until a face is detected.
- If the yellow double border blinks when the shutter-release button is pressed halfway, the camera was unable to focus. Release the button and try again.
- If no face is recognized when the shutter-release button is pressed halfway, the camera focuses on the center of the frame.
- The camera may be unable to detect faces in the following situations:
 - When faces are partially hidden by sunglasses or other obstructions
 - When faces take up too much or too little of the frame

Settings for One-Touch Portrait Mode

- Flash: Changeable
- Self-timer: Available
- Macro close-up: Off

Viewing Multiple Pictures: Thumbnail Playback

Press the zoom control to **W** (📐) in full-frame playback (📺 30) to display pictures in “contact sheets” of thumbnail images. The following operations can be performed while thumbnails are displayed:

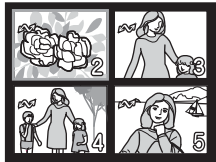

To	Press	Description	📺
Choose pictures		Use the rotary multi selector to choose pictures.	12
Change number of pictures displayed	w (📐) T (📏)	Display 4, 9, 16 or 25 picture thumbnails in the following order, when the zoom control is pressed to W (📐): 4→9→16→25 When the zoom control is pressed to T (📏), the number of picture thumbnails changes reversely.	–
Cancel thumbnail playback	OK	Cancel thumbnail playback and return to full-screen playback.	30
D-Lighting		Enhance brightness and contrast in dark portions of pictures.	56
Delete picture		Confirmation dialog will be displayed. Choose [Yes] and press OK to delete.	30
View playback menu	MENU	Display the playback menu.	108
View playback mode menu	m	Display the playback mode-selection menu.	10
Switch to shooting mode		Switch to the shooting mode selected last time.	30

Taking a Closer Look: Playback Zoom

Pressing the zoom control to **T** (Q) during full-frame playback (30) zooms the current picture in 3 \times , with the center of the picture displayed in the monitor (Quick Playback Zoom).

The guide in the lower right shows where the part of the picture is enlarged. The part of the picture displayed is changed by pressing the rotary multi selector **▲▼◀▶**.

With the zoom control in quick zoom playback, you can enlarge pictures in the desired magnification ratio. While image is zoomed in, the zoom ratio is displayed on the monitor. The following operations can be performed while pictures are zoomed in:

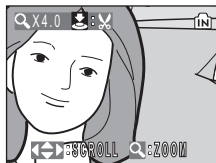
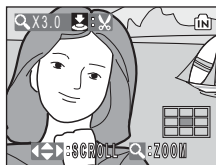

To	Press	Description	
Zoom in	Zoom control to T (Q)	Zoom increases each time the zoom control is pressed to T (Q), to a maximum of 10 \times .	–
Zoom out	Zoom control to W (Q)	Zoom decreases each time the zoom control is pressed to W (Q). When the magnification ratio reaches 1 \times , the display returns to full-frame playback.	–
View other areas of picture		Press the rotary multi selector ▲▼◀▶ to scroll to areas of the picture not visible in the monitor.	12
Crop picture		Crop current picture to contain only the portion visible in the monitor.	55
Switch to full-frame playback	OK	Cancel playback zoom and return to full-screen playback.	30
Delete picture		Confirmation dialog will be displayed. Choose [Yes] and press OK to select.	30
View playback menu	MENU	Display the playback menu.	108
View playback mode menu	m	Display the playback mode-selection menu.	10
Switch to shooting mode		Switch to the shooting mode selected last time.	30

Note on Enlarging Vertically Taken Images

Vertically taken images (124) cannot be rotated in quick playback zoom or zoom mode. Images can be displayed by pressing the zoom control to **T** (Q) in full-frame playback. Press again to **T** (Q) to display the image enlarged horizontally.

Editing Pictures

Use the COOLPIX S7c to edit pictures in-camera and store them as separate files (📷 160). The editing features described below are available.

Editing function	Description
Crop	Enlarge the image or refine the composition and create a copy containing only the portion visible in the monitor.
D-Lighting	Create a copy of the current picture with enhanced brightness and contrast, brightening dark portions of the picture.
Electronic VR	Sharpen blurred images digitally after they are taken. Corrected images are stored as new files.
Small picture	Create a small copy of pictures suitable for use on web pages or as e-mail attachments.

Picture Editing

- The COOLPIX S7c editing functions may not be available for pictures taken with non-COOLPIX S7c digital cameras.
- If a copy created using the COOLPIX S7c is viewed on a different digital camera, the picture may not be displayed or may not be transferred to a computer.
- Editing functions are not available when there is not enough free space in the internal memory or on the memory card.

Restrictions on Picture Editing

(✓: available, -: not available)

1st editing	2nd editing			
	Crop	D-Lighting	Electronic VR	Small picture
Crop	-	-	-	-
D-Lighting	✓	-	✓	✓
Electronic VR*	✓	✓	-	✓
Small picture	-	-	-	-

* Includes pictures taken in anti-shake mode.

- Pictures cannot be edited twice with the same editing function.
- The D-Lighting or electronic VR should be done first while the restricted use of combination exists.

Original Pictures and Edited

- Copies created with editing functions are not deleted if the original pictures are deleted. The original pictures are not deleted if copies created with editing functions are deleted.
- Edited copies are stored with the same recording date and time as the original.
- Edited copies have the same transfer marking (📷 112) as the original but are not marked for printing (📷 93) or protecting (📷 111).

Creating a Cropped Copy: Crop

This function is only available when  is displayed in the monitor with playback zoom ( 53) enabled. Cropped copies are stored as separate files.

- 1 Press the zoom control to **T** () to zoom in on the image.

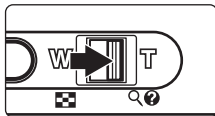

- 2 Refine copy composition.

Press the zoom control to **T** or **W** to adjust the zoom ratio.

Press the rotary multi selector  to scroll the picture until only the portion you want to copy is visible in the monitor.

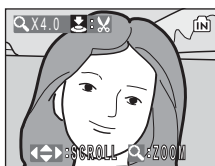

- 3 Press the shutter-release button.

The confirmation dialog will be displayed.







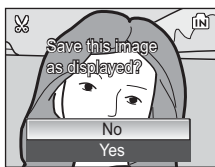



- 4 Use the rotary multi selector to choose [Yes] and press **OK**.

A new picture, containing only the portion visible in the monitor, is created.



Depending on the size of the original picture and the zoom ratio in effect at the time the copy was created, the camera will automatically select one of the following image-mode settings for cropped copies (unit: pixels).

-  2,592 × 1,944
-  2,288 × 1,712
-  2,048 × 1,536
-  1,600 × 1,200
-  1,280 × 960
-  1,024 × 768
-  640 × 480
-  320 × 240
-  160 × 120

Enhancing Brightness and Contrast: D-Lighting

D-Lighting can be used to create copies with enhanced brightness and contrast, brightening dark portions of a picture. Enhanced copies are stored as separate files.

- 1 Display the desired picture in full-frame (📺 30) or thumbnail (📺 52) playback and press  (👤).

The results of D-Lighting enhancement can be confirmed in the monitor.

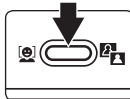

- 2 Use the rotary multi selector to choose [OK] and press .

A new copy with enhanced brightness and contrast is created.

To cancel D-Lighting, choose [Cancel] and press .

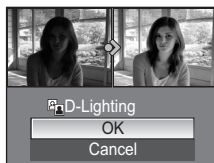

D-Lighting copies can be recognized by the  icon displayed during playback.



Compensating Blurred Images: Electronic VR

Vibration reduction is used to create a new image by compensating the blurred image. Created copies are stored as separated files.

1 Choose the desired image in full-frame playback (30).

When the  indicator is displayed, vibration reduction is not available.

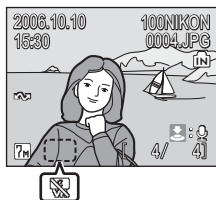

2 Press **OK** () (electronic VR).



3 Use the rotary multi selector to choose [OK] and press **OK**.

Compensated image is created.

To cancel vibration reduction, choose [Cancel] and press **OK**.

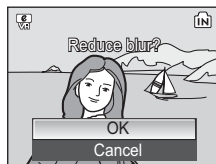

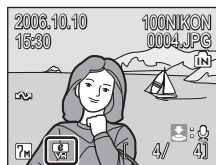

For compensated images, the  indicator is displayed in the monitor during playback.





Note on Electronic VR



In addition to the restrictions described in "Restrictions on Picture Editing" ( 54), electronic VR cannot be used for the following pictures:

- Pictures taken with Multi-shot 16 ( 102), with slow shutter speeds, or with other cameras.
- Pictures with date imprint ( 121).
- Pictures with minor blur, or pictures that are badly blurred.

Resizing Pictures: Small Picture

Create a small copy of the current picture. Small copies are stored as JPEG files with a compression ratio of 1:16. The following sizes are available.

 640×480	Suited to television playback.
 320×240	Suited to display on web pages.
 160×120	Suitable for e-mail attachments.

- 1 Display the desired picture in full-frame () 30) or thumbnail () 52) playback mode and press **MENU**.

The playback menu is displayed.

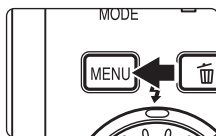

- 2 Use the rotary multi selector to choose [Small pic.] and press **OK**.

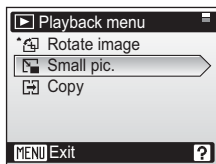

- 3 Choose the desired copy size and press **OK**.

A confirmation dialog will be displayed.

To cancel, press **MENU**.

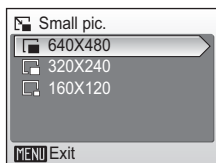

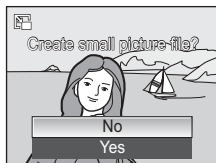

- 4 Choose [Yes] and press **OK**.

A new, smaller copy is created.





Voice Memos: Recording and Playback

Use the camera's built-in microphone to record voice memos for pictures marked with  in full-frame playback ( 30).

Recording Voice Memos

A voice memo will be recorded while the shutter-release button is held down.



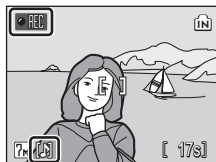

Recording ends after about 20 seconds or when the shutter-release button is released.

- Do not touch the built-in microphone during recording.
- During recording,  and  blink in the monitor display.





Playing Voice Memos

Press the shutter-release button while a picture is displayed in full-frame playback to play voice memo. Playback ends when the voice memo ends or the shutter-release button is pressed again.

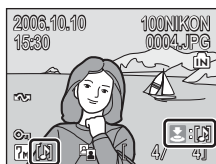
- Pictures with voice memos can be recognized by the  and  icons.
- Use the zoom control to adjust playback volume. Press to **W** () to lower volume, or to **T** () to raise volume.



Deleting Voice Memos

Select a picture with a voice memo and press . Use the rotary multi selector to choose  and press . Only the voice memo will be deleted.

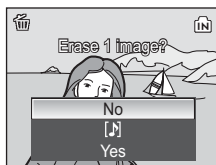
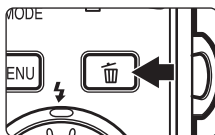

Voice Memos

- Voice memos are assigned the picture file name they are attached to with the three-letter extension ".WAV" (e.g., DSCN0015.WAV) ( 160).
- If a voice memo already exists for the current picture, it must be deleted before a new voice memo can be recorded.

Viewing Pictures by Date

Pictures taken on a specific date can be selected for viewing, deletion, printing, protection, and transfer.

The date can be selected from a calendar or a list.

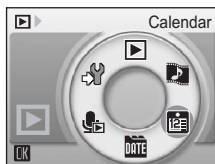

Selecting a Date in Calendar Mode

- 1 Enter calendar mode by pressing **m** in playback mode, selecting  (use the rotary multi-selector), and then pressing **OK**.



- 2 Choose a date and press **OK**.

Dates for which pictures exist are underlined in yellow.

Press the zoom control to **W** () to view previous month, press to **T** () to view following month.

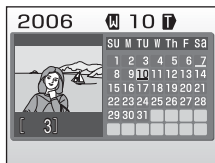

The first picture for that date will be displayed full-frame.

Press the zoom control in full-frame playback to **W** () to return to calendar mode.

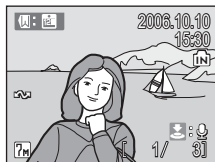

Selecting a Date in List-by-Date Mode

- 1** Enter list-by-date mode by pressing **m**, selecting **DATE** (use the rotary multi selector) in playback mode, and then pressing **OK**.

Dates for which pictures exist will be listed.



- 2** Choose date and press **OK**.

Camera lists up to 30 dates. If pictures exist for more than 30 dates, all pictures recorded earlier than most recent 29 dates will be listed together as [Others].

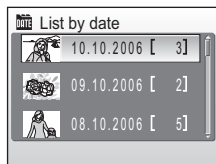





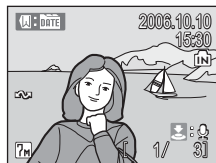





The first picture for that date will be displayed full-frame.

Press the zoom control in full-frame playback to **W** (📐) to return to the date list.













Using Calendar Mode and List-by-Date Mode

To	Press	Description	
Select date		Use the rotary multi selector to select a date.	–
Select month (calendar mode only)		Press to W () to view previous month, press to T () to view following month.	–
Switch to full-frame playback		Display the first picture taken on the selected date.	–
Delete picture		Press after selecting a date, and a confirmation dialog will be displayed. Choose [Yes] and press  to delete all pictures taken on the selected date.	30
View calendar or list-by-date menu	MENU	Display the calendar or list-by-date menu.	64
View playback mode menu		Display the playback mode-selection menu.	10
Switch to shooting mode		Switch to the shooting mode selected last time.	30

 Notes on Calendar Mode and List-by-date Mode

- Up to 9,000 pictures can be registered in calendar mode or in list-by-date mode. If more pictures exist, “*” is displayed next to the number.
- Pictures taken with no date stamp are not listed in these modes.

The following operations are available when in full-frame playback:

To	Press	Description	
View other pictures		Use the rotary multi selector to choose and view other pictures.	30
Zoom in	T (Q)	A maximum of 10× zoom in is available after using Quick Playback Zoom.	53
Switch to calendar/list-by-date mode playback	W ()	Switch to the calendar or list-by-date mode selected before viewing in full-frame playback.	–
Record/play voice memo		Record or play back voice memos up to 20 seconds in length.	59
D-Lighting		Enhance brightness and contrast in dark portions of pictures.	56
Electronic VR		Press  while displaying a picture to compensate a blurred image.	57
View movie		Movie playback will start.	76
Delete picture		Confirmation dialog will be displayed. Choose [Yes] and press  to delete.	30
View calendar or list-by-date menu	MENU	Display the calendar or list-by-date menu.	64
View playback mode menu	m	Display the playback mode-selection menu.	10
Switch to shooting mode		Switch to the shooting mode selected last time.	30

Calendar Mode and List-by-Date Mode Menus

Press **MENU** in either mode to display the following menu for only the pictures taken on the specified date.

Print set	 93
Slide show	 110
Delete	 111
Protect	 111
Transfer marking	 112
Rotate image*	 112
Small picture*	 58

* During full-frame playback only

The procedure for selecting pictures in calendar or date list playback differs from that in full-frame playback.

- In calendar or date list playback, the options apply to all pictures taken on the currently selected date.
- In full-frame playback, although the options apply only to the picture currently displayed full frame, other pictures taken on the same date can be selected.

Print Set and Transfer Marking

If [Print set] or [Transfer marking] is selected from the menu for the calendar or date list when print or transfer marking already exists for dates other than the specified date, a confirmation dialog [Save print marking for other dates?] or [Save transfer marking for other dates?] will be displayed. Select [Yes] to add to the existing print or transfer marking. Selecting [No] removes the existing print or transfer marking from all pictures in the internal memory or on the memory card, ensuring that only pictures taken on the specific date are selected for printing or transfer.

Full-Frame Playback

When pictures are displayed full frame in calendar or list-by-date mode, the respective icon is displayed in the top left corner, and the date and time of recording are displayed in place of the folder name and file number and type.

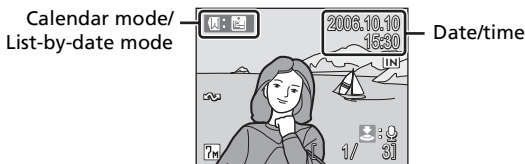

Pictmotion by muvee

Pictmotion* creates slide show movies with custom transitions and background music.

It is only available when a memory card is inserted in the camera.

* Pictmotion is powered by muvee Technologies.

Creating a Pictmotion Movie

This section describes the easiest way to create a Pictmotion movie.

- 1 Enter Pictmotion mode by pressing **m** in playback mode, selecting  (use the rotary multi selector), and then pressing **OK**.



- 2 Choose  and press **OK**.



- 3 Choose [All images] and press **OK**.

A Pictmotion movie using the ten most recent pictures (default setting) will be created.

After the created Pictmotion movie is automatically played back, a confirmation dialog will be displayed.

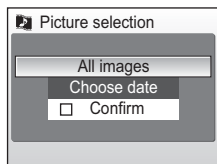

- 4 Choose [Yes] and press **OK**.

The Pictmotion movie is saved and the monitor display returns to that shown in step 2.

Settings for saved Pictmotion movies cannot be changed. If you wish to change the settings, delete the Pictmotion movie and create a new Pictmotion movie with the desired settings.

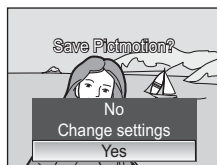

Creating a Custom Pictmotion Movie

- 1 Use the rotary multi selector to choose [Confirm] in the picture selection menu (▶ 65, step 3) and press **OK**.

The check box is selected (✓).

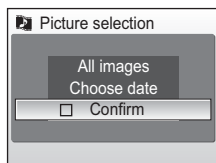

- 2 Choose [All images] or [Choose date] and press **OK**.

[All images]: Proceed to step 4

[Choose date]: Proceed to step 3

- 3 Select a date and press the shutter-release button.

Choose a date and press **OK** to mark (✓).

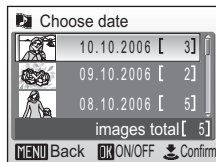

- 4 Select pictures and press the shutter-release button.

If [All images] is selected in step 2, all pictures will be displayed. If [Choose date] is selected, only pictures taken on the date selected in step 3 will be displayed.

Choose pictures and press **OK** to select (up to 30).

Press the zoom control to **T** (Q) to view selected picture full-frame; press to **W** (R) to return to thumbnail display.

After the created Pictmotion movie is automatically played back, a confirmation dialog will be displayed.

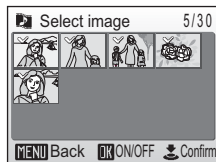

[Choose date]

- 5 Choose [Yes] and press **OK**.

The Pictmotion movie is saved.

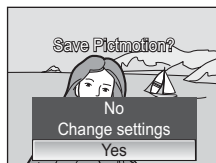



Notes on Pictmotion

- Pictmotion supports both still pictures and movie files; note, however, that in the case of movies only a small portion selected from the first 60 seconds of each movie will be included.
- If the current memory card holds 20 Pictmotion movies, no additional movies can be created until an existing movie has been deleted.
- The pictures in a Pictmotion movie are automatically protected when the movie is saved ( 111).

PictureProject (Windows only)

- The Windows version of the supplied PictureProject software can be used to transfer Pictmotion movies to a computer for viewing and to copy up to five three-minute custom sound tracks to a memory card inserted in the camera; see the *PictureProject Reference Manual* (on CD) for details.
- Pictmotion movies can also be transferred to a computer using the [Easy Transfer (PM)] or [PC mode] option of wireless transfer mode ( 130).

Deleting Pictmotion Movies

To delete a Pictmotion movie, choose the desired movie file in the Pictmotion menu ( 65, step 2), and press . Protection ( 111) is not removed when the Pictmotion is deleted.

Other Options for Pictmotion Movies

Pressing **MENU** in the Pictmotion screen (☒ 65, step 2) displays the Pictmotion settings menu, while pressing it in the save confirmation dialog (☒ 65, step 4) displays the change settings menu. The following options are available.

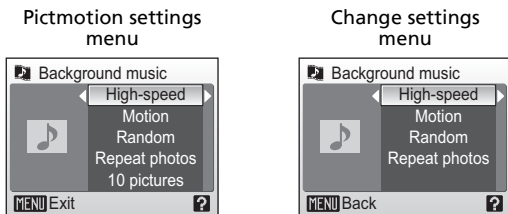

Background Music

Choose from five preset music tracks and five user-defined tracks. Preset music tracks include [High-speed], [Emotional], [Natural], [Up-tempo], and [Relaxed].

- Preset tracks can be played back by pressing the zoom control to **T** (Q). User-defined tracks cannot be played back.
- Music tracks from a computer will be added to the user-defined track list. Names of the tracks are displayed in the list only when transferred from a computer.

Effects

Choose from [Motion], [Moody], [Pro-slow], [Pro-fast], and [Classic].

- Press the zoom control to **T** (Q) to preview selected style on the left side of the monitor.

Playback Order

Random: Play back pictures in random order.
 Play in order: Play back pictures in order recorded.

Loop

Repeat music: Repeat background track until all pictures have been played at least once (some pictures may be repeated).
 Repeat photos: Play background track once, repeating or omitting pictures as necessary.

- In some cases, pictures may be shown repeatedly regardless of the setting.

Selected Images

This option can only be set from the Pictmotion settings menu.

Choose from 10, 20, 30 or [No auto select].

For example, if [20 pictures] is selected, the last 20 pictures are chosen for the Pictmotion movie. This number can be changed, however, when creating a customized Pictmotion movie. When [Confirm] is selected in picture selection screen (☒ 66, step 1), the number of pictures chosen in step 4 will be used.

Viewing Pictmotion Movies

- 1 Enter Pictmotion playback mode by pressing **m** in playback mode, selecting  (use the rotary multi selector), and then pressing **OK**.



- 2 Use the rotary multi selector to choose the desired Pictmotion movie and press **OK**.

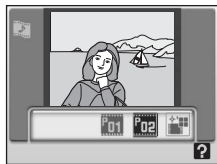

- 3 Choose **[Play]** and press **OK**.

Playback starts.

If **[Loop]** is selected, the movie will repeat automatically. To select or deselect **[Loop]**, choose **[Loop]** and press **OK**.

Zoom control controls volume.

To pause the movie, press **OK** during playback.

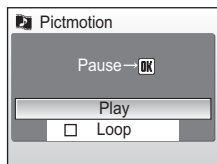

- 4 Choose **[End]** and press **OK**.

Monitor returns to that shown in step 2.

To resume playback, choose **[Restart]** and press **OK**.

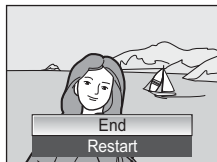

Recording Movies

To shoot movies with sound recorded via the built-in microphone, select shooting mode and follow the steps below.

- 1 Enter movie mode by pressing **m** in shooting mode, selecting  (use the rotary multi selector), and then pressing **OK**.

Exposure count display shows maximum total length of movie that can be recorded.

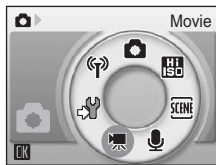

- 2 Press the shutter-release button fully to start recording.

A progress bar at the bottom of the monitor shows the amount of recording time remaining.





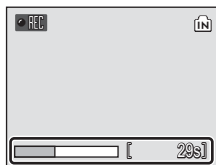

To end recording, press the shutter-release button all the way down a second time.



Recording will automatically stop if the internal memory or memory card becomes full.

Recording Movies







- The flash ( 32) can only be used for time-lapse and stop-motion movies. The self-timer ( 34) cannot be used, and exposure compensation ( 101) is not available. Macro mode ( 35), however, is available in all modes.
- Digital zoom (up to 2×) can be applied while movies are being recorded. Adjust optical zoom before beginning recording. Once recording begins, optical zoom cannot be adjusted.

Changing Movie Settings

70 Movie options, auto-focus mode, or electronic VR can be changed ( 71).









The Movie Menu

Press **MENU** in movie mode to display the movie menu.

- | | |
|---|---|
|  | Movie options  72 |
| | Choose type of movie that will be recorded. |
|  | Auto-focus mode  75 |
| | Choose how camera focuses in movie mode. |
|  | Electronic VR  75 |
| | Reduce effects of camera shake. |

Selecting Movie Options

The movie menu offers the options shown below.

Option	Description	Maximum movie length/ frames*	
		Internal memory (14 MB)	Memory card (256 MB)
 TV movie 640★	Movies are recorded at 30 frames per second. Each frame is 640 × 480 pixels in size.	12 sec.	3 min. 40 sec.
 Small size 320★	Movies are recorded at 30 frames per second. Each frame is 320 × 240 pixels in size.	25 sec.	7 min. 20 sec.
 Small size 320 (default)	Movies are recorded at 15 frames per second. Each frame is 320 × 240 pixels in size.	49 sec.	14 min. 30 sec.
 Pictmotion 320	Movies are recorded at 15 frames per second. Each frame is 320 × 240 pixels in size. Recording automatically stops after 60 seconds. Suited for Pictmotion movies ( 65).	49 sec.	1 min.
 Smaller size 160	Movies are recorded at 15 frames per second. Each frame is 160 × 120 pixels in size. Smaller size allows for recording of longer movies.	2 min. 44 sec.	48 min.
 Time-lapse movie★	The camera takes pictures at specified intervals and joins them into a silent movie. Each frame is 640 × 480 pixels in size. Playback frame rate is 30 fps.	149 frames	1,800 frames
 Stop-motion movie	Pictures can be taken at desired intervals and joined into a silent movie. Each frame is 640 × 480 pixels in size. Playback frame rate is 15 fps.	149 frames	1,800 frames

* Movies can be as long as free space in the internal memory or on the memory card allows. All figures are approximate. Maximum movie length or frames varies with make of memory card.

Time-Lapse Movies

Record flowers opening or butterflies emerging from cocoons. Charge the battery before shooting begins.

- 1 Use the rotary multi selector to choose [Movie options] and press **OK**.

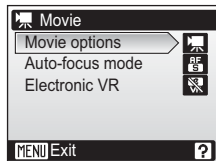

- 2 Choose [Time-lapse movie★] and press **OK**.

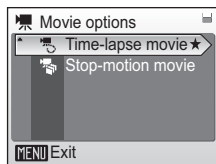

- 3 Choose the interval between shots and press **OK**.

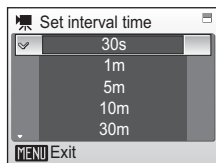

- 4 Press **MENU**.

The camera returns to shooting mode.

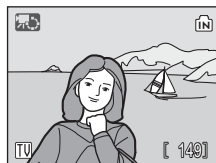

- 5 Press the shutter-release button all the way down to start recording.

Monitor turns off and indicator lamp blinks green between shots.

Monitor reactivates automatically for the next shot.

- 6 Press the shutter-release button all the way down a second time to end recording.

Recording will automatically stop if the internal memory or memory card becomes full, or when a maximum of 1,800 frames (up to 60 seconds) have been recorded.

Stop-Motion Movies

- 1 Use the rotary multi selector to choose [Movie options] > [Stop-motion movie] and press **OK**.

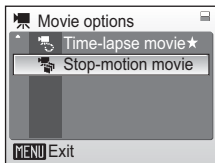

- 2 Press **MENU**.

The camera returns to shooting mode.

- 3 Press the shutter-release button to record the first frame.

The recorded picture will be superimposed on the view through the lens.

- 4 Press the shutter-release button to record the second frame.

The second frame will be superimposed on the first frame.

The monitor turns off automatically if no operations are performed for 30 minutes (auto off), and recording ends.

- 5 Press **OK** to end recording.



Recording automatically ends when 1,800 pictures are taken.

✓ Time-Lapse Movie and Stop-Motion Movie

To prevent the camera from turning off unexpectedly during recording, use a fully charged battery.

Auto-Focus Mode

Choose how the camera focuses in movie mode.

Option	Description
 Single AF (default)	Camera focuses when shutter-release button is pressed half-way and locks at this position during shooting.
 Full-time AF	Camera focuses continuously, even when shutter-release button is not pressed halfway. To prevent sound of camera focusing from interfering with recording, it is recommended to use [Single AF].

Electronic VR

Choose [On] to reduce the effects of camera shake in all movie modes except [Time-lapse movie ★] and [Stop-motion movie].

At settings other than [Off], an electronic VR indicator is displayed in the monitor ( 8).

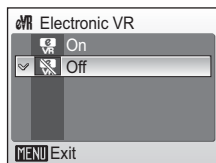

Movie File Names and Folder Names

See “Image File and Folder Names” ( 160).

Movie Playback

In full-frame playback (⏏ 30), movies are recognized by the 📺 icon. To play a movie, display it in full-frame playback and press ⏏.

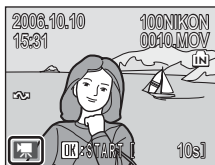

During playback

Use the zoom control to adjust playback volume. Press to **W** (📶) to lower volume, or to **T** (🔊) to raise volume.

Rotate the rotary multi selector to advance or rewind the movie at twice the normal speed.

Playback controls appear at the top of the monitor. Press the rotary multi selector ◀▶ to choose a control, then press ⏏ to perform the selected operation. The following operations are available:

Pausing

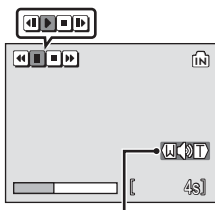

Volume indicator

To	Press	Description	
Rewind	⏮	Rewind movie. Playback resumes when ⏏ is released.	
Advance	⏭	Advance movie. Playback resumes when ⏏ is released.	
Pause	⏸	Pause playback. While paused, use the rotary multi selector to advance or rewind the movie. The following operations can be performed while playback is paused.	
		⏮	Rewind movie by one frame. Rewind continues while ⏏ is pressed.
		⏭	Advance movie by one frame. Advance continues while ⏏ is pressed.
		▶	Resume playback.
	⏪	End playback and return to full-frame playback.	
End	⏪	End playback and return to full-frame playback.	

Deleting Movie Files

Press 🗑 during movie playback or when displayed in full-frame (⏏ 30) or thumbnail (⏏ 52) playback mode. A confirmation dialog is displayed. Choose [Yes] and press ⏏ to delete the movie, or choose [No] and press ⏏ to return to the normal playback display without deleting the movie.

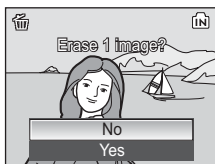

Making Voice Recordings

Audio voice recordings can be recorded over the built-in microphone and played back over the built-in speaker.

- 1 Enter voice recording mode by pressing **m** in shooting mode, selecting  (use the rotary multi selector), and then pressing **OK**.



The length of recording that can be made will be displayed.

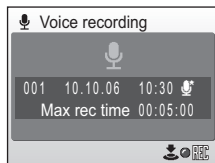

- 2 Press the shutter-release button fully to start recording.



Camera enters standby mode during recording. The monitor turns off and the indicator lamp turns green.





- 3 Press the shutter-release button fully a second time to end recording.

Recording will end automatically if the internal memory or memory card becomes full, or after five hours of recording on the memory card.

Operations During Recording

The following operations are available during recording. If the monitor has turned off, press   to reactivate.



To	Press	Description
Pause/resume recording		Press once to pause recording; self-timer and indicator lamps will blink.
Create index		During recording, press the rotary multi selector to create index. Camera can skip to any index during playback. Start of recording is index number 1; other numbers are assigned in ascending order, to a maximum of 98.
End recording		Press the shutter-release button fully a second time to end recording.

Changing the Sound Quality

Press **MENU** in voice recording mode to display the following sound quality options.

Sound Quality

Choose the sound quality for the recording.

Option	Description	Maximum movie length*	
		Internal memory	Memory card
		14 MB	256 MB
 Normal	Suited for longer recordings.	30 min. 36 sec.	5 hours
 High (default)	Record with high quality sound. Note that sound will not be heard while fast forwarding or rewinding.	11 min. 5 sec.	3 hours 14 min.

* Movies can be as long as free space in the internal memory or on the memory card allows (up to five hours). All figures are approximate. Maximum movie length varies with make of memory card.

Voice Recordings

- PictureProject cannot be used to transfer or play voice recordings. Select [Interface] > [Mass storage] for [USB], copy the files manually.
- The copied files can be played back using QuickTime or any other WAV-compatible audio player.
- Note that index points created with the camera cannot be used when voice recordings are played back on computers.

Playing Voice Recordings

- 1 Enter audio playback mode by pressing **m** in playback mode, selecting  (use the rotary multi selector), and then pressing **OK**.



- 2 Choose the desired file and press **OK**.

The selected file will be played back.

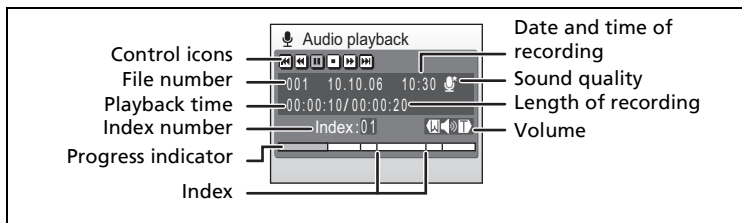
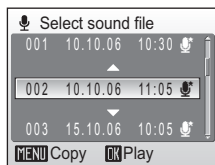

Operations During Playback

Use the zoom control to adjust playback volume. Press to **W** (☒) to lower volume, or to **T** (Q) to raise volume.

Rotate the rotary multi selector to advance or rewind the voice recording at twice the normal speed.

Playback controls appear at the top of the monitor. Press the rotary multi selector ◀▶ to choose a control, then press Ⓚ to perform the selected operation. The following operations are available:

To	Press	Description
Rewind	⏮	Rewind voice recording. Playback resumes when Ⓚ is released.
Advance	⏭	Advance voice recording. Playback resumes when Ⓚ is released.
Skip to previous index	⏮	Skip to previous index.
Skip to next index	⏭	Skip to next index.
Pause	⏸	Pause playback. The following operations can be performed while playback is paused.
	▶	Resume playback.
	⏹	End playback and return to full-frame playback.
End	⏹	End playback and return to full-frame playback.

Deleting Sound Files

Press  during playback or after selecting a sound file (use the rotary multi selector). A confirmation dialog will be displayed. To delete the file, choose [Yes] and press Ⓚ. To cancel deletion, choose [No] and press Ⓚ.

Copying Voice Recordings

Copy voice recordings between the internal memory and a memory card. This option is available only when a memory card is inserted.

- 1 Press **MENU** in the select sound file screen (79, step 2).

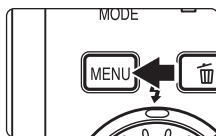

- 2 Use the rotary multi selector to choose the option and press **OK**.

→ : Copy recordings from internal memory to memory card

→ : Copy recordings from memory card to internal memory

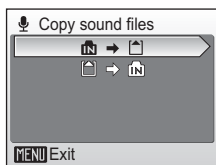

- 3 Choose the copy option and press **OK**.

[Selected files]: Proceed to step 4

[Copy all files]: Proceed to step 5

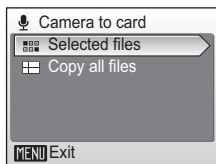

- 4 Choose the desired file and press **OK**.

Choose the desired file and press **▶** to mark.

A confirmation dialog will be displayed.

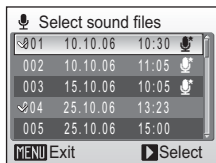

- 5 Choose [Yes] and press **OK**.

Copying starts.

Voice Recordings

The COOLPIX S7c may be unable to play or copy sound files created with other make of camera.

Connecting to a TV

Connect the camera to a television using the A/V cable to play back pictures on the television.

- 1 Turn off the camera.

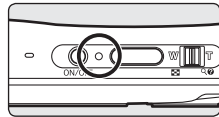

- 2 Connect the COOL-STATION to the TV using the supplied A/V cable.

Connect the yellow plug to the video-in jack on the TV, and the white plug to the audio-in jack.

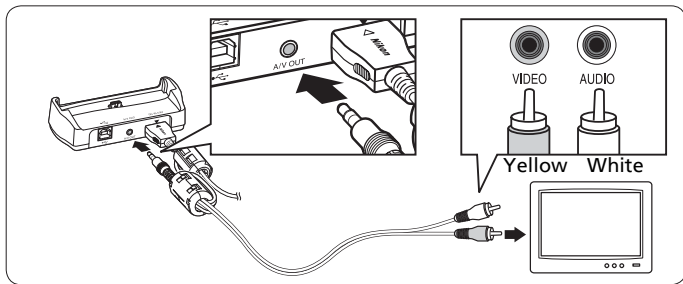

- 3 Tune the television to the video channel.

See the documentation provided with your television for details.

- 4 Place the camera in the COOL-STATION and press for more than one second to turn on the camera.

The camera enters playback mode, and the pictures taken will be displayed on the television.

While connected to the TV, the camera monitor will remain off.

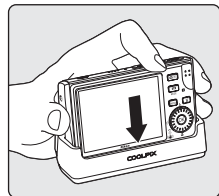

Connecting an A/V Cable

When connecting the A/V cable, be sure that the camera connector is oriented correctly. Do not use force when connecting the A/V cable to the camera. When disconnecting the A/V cable, do not pull the connector at an angle.

Video Mode

Be sure that the camera's video mode setting conforms to the standard used by your television. The video mode setting is an option set from setup menu (114) > [Interface] (126) > [Video mode].

Connecting to a Computer

Use the USB cable and PictureProject software supplied with your camera to copy (transfer) pictures to a computer.

- You can play back pictures on a computer transferred via wireless LAN. See “Wireless Transfer Mode” (📺 130) for more information.

Before Connecting the Camera

Installing PictureProject

Before transferring pictures or movies to a computer, PictureProject must be installed. For more information on installing and using PictureProject, see the *Quick Start Guide* or the *PictureProject Reference Manual* (on CD).

Confirming USB Option

The following two methods can be used to transfer pictures from the camera to a computer:

- Click [Transfer] in PictureProject.
- Press 📷 (📷) on the camera.

The method used will depend on your computer’s operating system and the USB option selected in the camera’s setup menu.

Operating system	USB mode ¹	
	Camera 📷 (📷) button ²	PictureProject Transfer button
Windows XP Home Edition Windows XP Professional	Choose [Mass storage] or [PTP].	
Windows 2000 Professional ³	Choose [Mass storage].	
Mac OS X 10.3.9 or later	Choose [PTP].	Choose [Mass storage] or [PTP].

¹ This camera supports the USB options, [Mass storage] and [PTP] (default setting). Choose [PTP] to transfer pictures stored in the internal memory. Pictures cannot be transferred when [Mass storage] is chosen.

² The camera’s 📷 (📷) button cannot be used to transfer pictures in the following cases. Use the [Transfer] button in PictureProject.

- When transferring pictures from the camera’s internal memory and [Mass storage] is selected in the USB menu.
- When the memory card write-protect switch is in the “lock” position. Unlock by sliding the switch to the “write” position before transferring pictures.

³ If your computer is running Windows 2000 Professional, be sure to set the USB option to [Mass storage]. If [PTP] is selected, the [Found New Hardware Wizard] will be displayed when the camera is connected to the computer. Select [Cancel], close the window, and disconnect the camera from the computer.

Setting the USB Option

Set the USB option in the setup menu (🔑 114) on the camera before connecting the camera to a computer or printer.

- 1 Display the setup menu by pressing **m**, selecting 🗑️ (use the rotary multi selector), and then pressing **OK**.



- 2 Choose [Interface] and press **OK**.

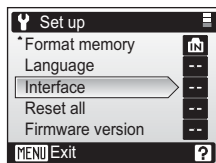

- 3 Choose [USB] and press **OK**.

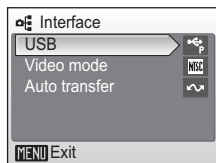

- 4 Choose [PTP] or [Mass storage] and press **OK** (🔑 83).

The setting is enabled.

Press **MENU** to exit setup menu.

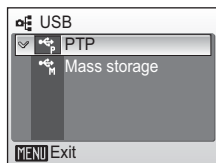

Transferring Pictures to a Computer

- 1 Start a computer to which PictureProject has been installed.
- 2 Turn off the camera.
- 3 Connect the COOL-STATION to the computer using the supplied USB cable.

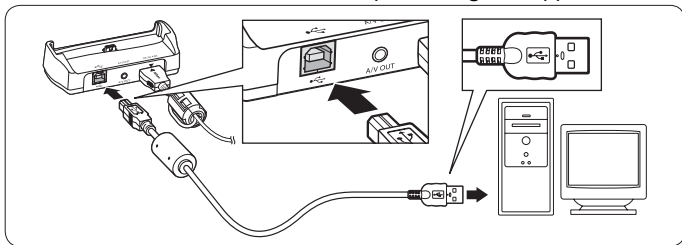

- 4 Turn the camera on after placing it in the COOL-STATION.

At default PictureProject settings, PictureProject Transfer is launched immediately with recognition of camera connection.

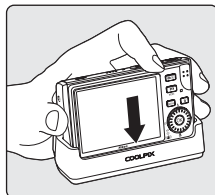



- 5 Transfer pictures.

Transfer using PictureProject

Click [Transfer] button in PictureProject Transfer.

All pictures and movies marked for transfer are copied to the computer. Once transfer is complete, pictures are displayed in PictureProject.

Transfer using the camera's () button

While PictureProject Transfer is launched, press  () to copy pictures marked for transfer ( 86) to the computer. The following messages are displayed in the camera monitor during transfer.

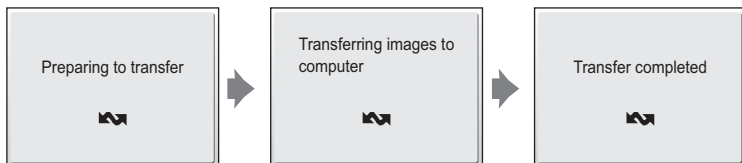

6 Disconnect the camera once transfer is complete.

If the USB option is set to [PTP]

Turn the camera off and disconnect the USB cable.

If the USB option is set to [Mass storage]

Remove the camera from the system as described below before turning the camera off and disconnecting the USB cable.

Windows XP Home Edition/Windows XP Professional

Click the [Safely Remove Hardware] icon in the taskbar and select [Safely remove USB Mass Storage Device] from the menu displayed.



Windows 2000 Professional

Click the [Unplug or Eject Hardware] icon in the taskbar and select [Stop USB Mass Storage Device] from the menu displayed.

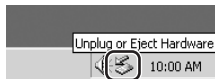

Macintosh

Drag the untitled camera volume ("NO_NAME") to the Trash.

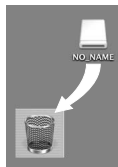

✓ Connecting the USB Cable

When connecting the USB cable, be sure that the connectors are oriented correctly. Do not use force when connecting the USB cable. When disconnecting the USB cable, do not pull the connector at an angle.

✍ Marking Pictures for Transfer

When **[M]** is pressed while the camera is connected to a computer, pictures marked with the **[M]** icon during playback will be transferred to the computer. As the default setting, all pictures are automatically marked for transfer. Two options control transfer marking:

- [Interface] > [Auto transfer] in the setup menu (**[M]** 126): Choose [On] to mark *all new pictures* for transfer (default setting).
- [Transfer marking] in the playback menu (**[M]** 112): Change marking for *existing pictures*.

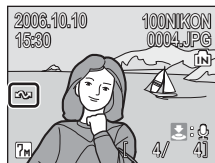

Connecting to a Printer

Users of PictBridge-compatible (📷 177) printers can connect the camera directly to the printer and print pictures without using a computer.

- To print pictures directly from the camera, configure the printer connected to the computer as a profile device for wireless transfer mode (📷 130). You can also use the optional PD-10 wireless printer adapter in wireless transfer mode (📷 158).

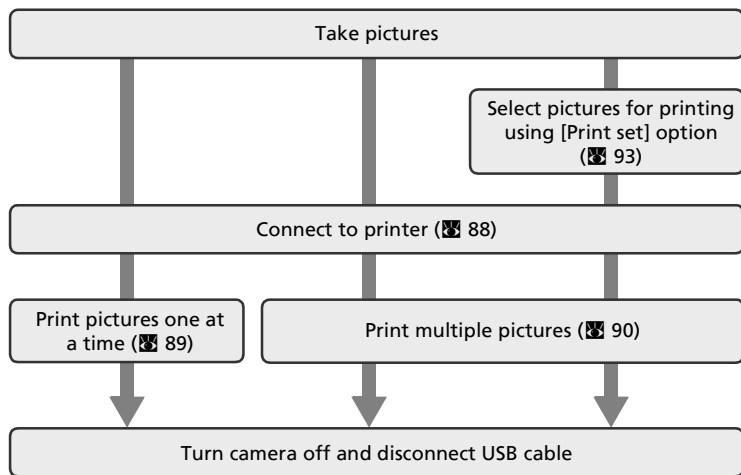

✔ Before Connecting the Camera

Use a fully charged battery or the supplied EH-64 AC adapter to prevent the camera from turning off unexpectedly while connected.

📷 Printing Pictures

In addition to printing pictures transferred to a computer from your personal printer and printing over a direct camera-to-printer connection, the following options are also available for printing pictures:

- Insert a memory card into a DPOF-compatible printer's card slot
- Take a memory card to a digital photo lab

For printing using these methods, specify the pictures and the number of prints each using your camera's print set menu (📷 93).

📷 ImageLink-compatible Printers

Users of ImageLink-compatible printers can connect the camera directly to the printer and print pictures without using a computer. See "Connecting to a ImageLink-compatible Printer" (📷 95) and the documentation provided with your printer for details.

Connecting the Camera and Printer

- 1 Set the USB option (84) to [PTP].

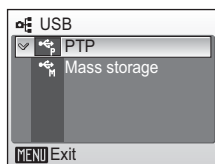

- 2 Turn off the camera.

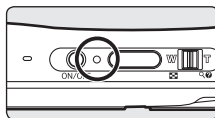

- 3 Turn on the printer.
Check printer settings.

- 4 Connect the COOL-STATION to the printer using the supplied USB cable.

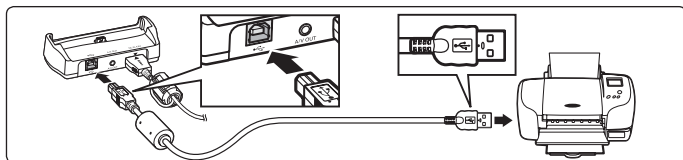

- 5 Turn the camera on after placing it in the COOL-STATION.

When connected correctly, the PictBridge start-up screen (1) will be displayed in the camera monitor. Then the picture will be displayed (2).

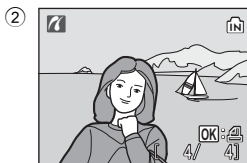
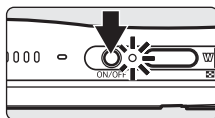

Connecting the USB Cable

When connecting the USB cable, be sure that the connectors are oriented correctly. Do not use force when connecting the USB cable. When disconnecting the USB cable, do not pull the connector at an angle.

Printing Pictures One at a Time

After connecting the camera to the printer correctly (❌ 88), print pictures by following the procedure below.

- 1 Use the rotary multi selector to choose a picture and press **OK**.

The PictBridge menu is displayed.

To choose a picture from a list of six thumbnails, press the zoom control to **W** (📷). Or, press to **T** (📺) to switch back to full-frame playback.



- 2 Choose [Copies] and press **OK**.

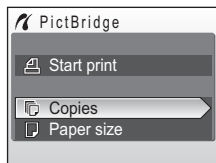

- 3 Choose number of copies (up to 9) and press **OK**.

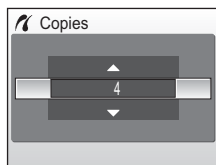

- 4 Choose [Paper size] and press **OK**.

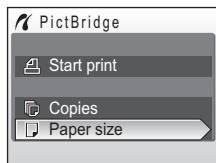

- 5 Choose the desired paper size and press **OK**.

To specify paper size using printer settings, choose [Default] in the paper size menu and press **OK**.

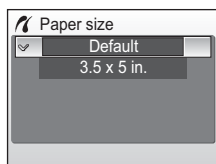

6 Choose [Start print] and press **OK**.

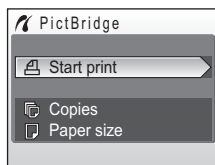

7 Printing starts.

Monitor display returns to that shown in step 1 when printing is complete.

To cancel before all copies have been printed, press **OK**.

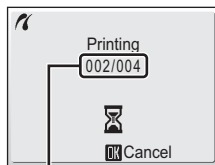

Current print/total number of prints

Printing Multiple Pictures

After connecting the camera to the printer correctly (88), print pictures by following the procedure below.

1 Press **MENU** when a picture is displayed.

The print menu is displayed.

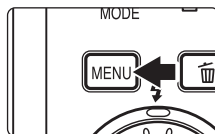

2 Use the rotary multi selector to choose [Paper size] and press **OK**.

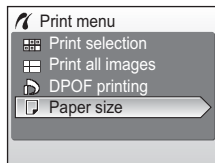

3 Choose the desired paper size and press **OK**.

To specify paper size using printer settings, choose [Default] in the paper size menu and press **OK**.

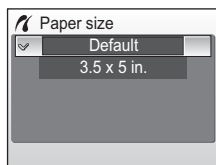

4 Choose [Print selection], [Print all images] or [DPOF printing] and press **OK**.

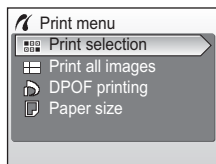

Print selection

Select pictures and specify the number of prints for each picture. Proceed to step 5.

Print all images

All pictures stored in the internal memory or memory card are printed. Proceed to step 7.



DPOF printing

Print pictures for which a print order has been created in [Print set] (93).

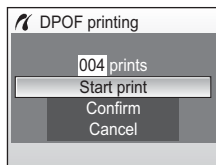
- The menu shown at right will be displayed.
- To print, choose [Start print] and press **OK**. Proceed to step 7.
- To view the current print order, choose [Confirm] and press **OK**. Proceed to step 6.



5 Choose the pictures and number of copies (up to 9) of each and press **OK**.

The current picture is shown at the center of the display. Select pictures and set the number of copies for each. Pictures selected for printing are recognized by the  icon and the number of copies to be printed.  is not displayed with pictures for which 0 copies have been specified and these pictures will not be printed.

Press **OK** when setting is complete.

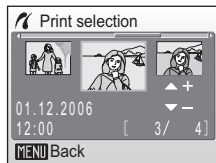

6 Check the selected pictures you wish to print and press **OK**.

To modify selection, press **MENU** to return to the previous screen.

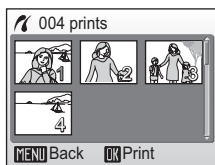

7 Printing starts.

Monitor display returns to the print menu (step 2) when printing is complete.

To cancel before all copies have been printed, press **OK**.



✓ Paper Size

The camera supports the following paper sizes: [Default] (the default paper size for the current printer), [3.5 × 5 in.], [5 × 7 in.], [Postcard], [100 × 150 mm], [4 × 6 in.], [8 × 10 in.], [Letter], [A3], and [A4]. Only sizes supported by the current printer will be displayed. To specify paper size using printer settings, choose [Default] in the paper size menu.

Creating a DPOF Print Order: Print Set

The [Print set] option in the playback menu is used to create digital “print orders” for printing on DPOF-compatible devices (☒ 177).

In addition to pictures themselves, shooting date and photo information (shutter speed, aperture, etc.) can also be printed.

When the camera is connected to a PictBridge-compatible printer, pictures can be printed from the printer according to the DPOF print order you have created for pictures on the memory card. If the memory card is removed from the camera, you can create the DPOF print order for pictures in the internal memory and print pictures according to the DPOF print order.

1 Press MENU in playback mode.

The playback menu is displayed.

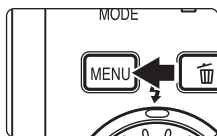

2 Use the rotary multi selector to choose [Print set] and press ☒.

The print set menu is displayed.

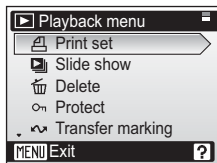

3 Choose [Print selected] and press ☒.

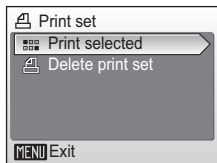

4 Choose the pictures and number of copies (up to 9) of each.

The current picture is shown at the center of the display. Press ◀▶ to select pictures and ▲▼ to set the number of copies for each.

Pictures selected for printing are recognized by the 🖨 icon and the number of copies to be printed. 🖨 is not displayed with pictures for which 0 copies have been specified and these pictures will not be printed.

Press ☒ when setting is complete.

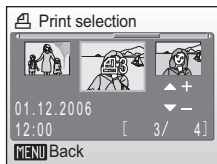



5 Choose whether or not to also print shooting date and photo information.

[Date]: Print date of recording on all pictures in the print order.

[Info]: Print shutter speed and aperture on all pictures in the print order. Note that this information is not printed with direct connection to a printer.

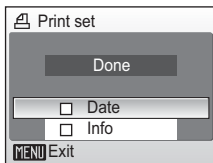
[Done]: Complete the print order and exit.



Pictures selected for printing are recognized by the  icon displayed with playback.

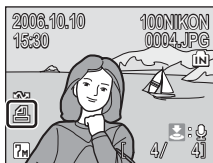

Print Set

[Date] and [Info] are reset each time the print set menu is displayed.

Deleting All Print Orders



Choose [Delete print set] in step 3 and press . Print orders for all pictures will be deleted.

Note on the Print Set [Date] Option

The date and time printed on pictures with DPOF printing when [Date] in the print set menu is enabled are those recorded with the picture when it was taken. Date and time printed using this option are not affected when the camera's date and time setting are changed from the setup menu after pictures are recorded.



Differences Between Print Set and Date Imprint

Date and time can only be printed on pictures using the [Date] option in the print set menu when pictures are printed from a DPOF-compatible printer ( 177). Use the [Date imprint] ( 121) option in the setup menu to print the date on pictures from a printer that does not support DPOF (position of the date is fixed). When the date option for both [Print set] and [Date imprint] is enabled, only the date from the [Date imprint] option is printed, even when a DPOF-compatible printer is used.

Connecting to a ImageLink-compatible Printer

See documentation provided with your printer for information on how to operate the printer.

- 1 Attach the supplied PV-11 dock insert to the printer.

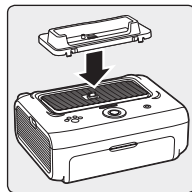

- 2 Set the USB option (F8 84) to [PTP].

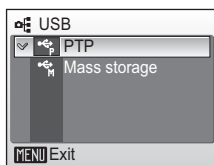

- 3 Turn the camera off and attach it to the dock insert.

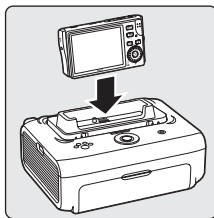

- 4 Print pictures.

Follow the procedures described in the printer manual.

Removing the Dock Insert

Place your thumbs where indicated, press, and lift.





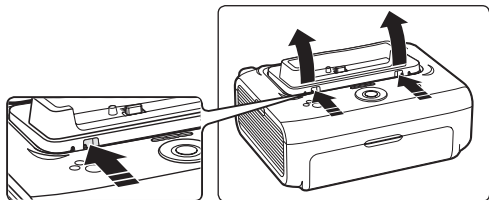













- ✓ **Note on Connecting to an ImageLink-compatible Printer**

The monitor will dim automatically if no operations are performed for about one minute while the camera is connected to an ImageLink printer. The camera will turn off if no operations are performed for another seven minutes.



Shooting Options: The Shooting Menu

The shooting menu and high-sensitivity menu contain the following options.

	Image mode  97
	Choose image size and quality.
	White balance ¹  99
	Match white balance to the light source.
	Exp. +/-  101
	Adjust exposure for very bright or very dark subjects.
	Continuous ¹  102
	Take pictures one at a time or in a sequence.
	BSS ¹  104
	Use the “best shot selector” to choose the sharpest picture.
	ISO sensitivity ²  105
	Control camera’s sensitivity to light.
	Color options ¹  105
	Apply color effects to pictures as they are recorded.
	AF area mode  106
	Choose where the camera focuses.
	Electronic VR ²  106
	Choose whether or not to apply electronic vibration reduction to reduce camera shake while taking pictures.

¹ See the information on restrictions that may apply to these settings ( 107).

² These settings cannot be set from the high-sensitivity menu.

Displaying the Shooting Menu and High-sensitivity Menu

Enter (auto) or high-sensitivity shooting mode by pressing **M** in shooting mode, selecting the (auto) or (high-sensitivity), and then pressing **OK**. Press **MENU** to display the shooting menu or high-sensitivity menu.

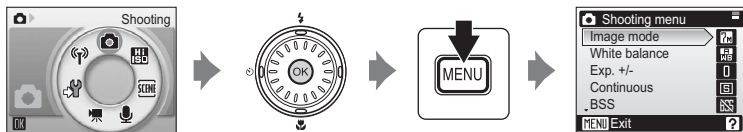

- Use the rotary multi selector (12) to choose and apply settings.
- To exit the shooting or high-sensitivity menu, press **MENU**.

Image Mode

Pictures taken with a digital camera are recorded as image files. The size of the files, and with it the number of images that can be recorded, depends on the size and quality of the images. Before shooting, choose an image mode according to how you plan to use the picture.

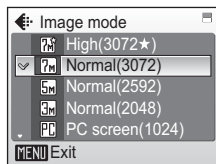







Options	Size (pixels)	Description
High(3072★)	3,072 × 2,304	Highest quality, suitable for enlargements or high-quality prints. The compression ratio is approximately 1/4.
Normal(3072)	3,072 × 2,304	Best choice in most situations. The compression ratio is approximately 1/8.
Normal(2592)	2,592 × 1,944	Smaller size allows more pictures to be stored. The compression ratio is approximately 1/8.
Normal(2048)	2,048 × 1,536	Smaller size allows more pictures to be stored. The compression ratio is approximately 1/8.
PC screen(1024)	1,024 × 768	Suited to display on computer monitor. The compression ratio is approximately 1/8.
TV screen(640)	640 × 480	Suited to full-screen display on a television or distribution by e-mail or the web. The compression ratio is approximately 1/8.

The icon for the current setting is displayed in the monitor in shooting and playback modes (8, 9).

Image Mode and the Number of Exposures Remaining

The following table lists the number of pictures that can be stored in internal memory and on a 256 MB memory card, together with the size of still pictures. Note that the number of pictures that can be stored will differ depending on the composition of the picture (due to JPEG compression). In addition, this number may differ depending on the make of memory card, even if the capacity for the memory card is the same.

Setting	Internal memory (14 MB)	256 MB memory card	Print size (printed at 300 dpi; cm/in.)
 High(3072★)	4	70	26 × 19.5 cm / 10.4 × 7.8 in.
 Normal(3072)	8	140	26 × 19.5 cm / 10.4 × 7.8 in.
 Normal(2592)	11	190	22 × 16.5 cm / 8.8 × 6.6 in.
 Normal(2048)	17	300	17 × 13 cm / 6.8 × 5.2 in.
 PC screen(1024)	59	1,040	9 × 7 cm / 3.6 × 2.8 in.
 TV screen(640)	112	1,960	5 × 4 cm / 2 × 1.6 in.

* All figures are approximate. If the number of exposures remaining is 10,000 or more, the number of exposure remaining display shows [9999].

Image Mode

The image mode setting can also be applied from the scene, anti-shake, and one-touch portrait menus. Changes made to the image mode setting from any of the three menus apply to all shooting modes.

WB White Balance

Adjust white balance based on the light source to give pictures the most realistic colors possible. Although the default setting, [Auto], can be used under most types of lighting, you can apply the white balance setting suited to a particular light source to achieve more accurate results.

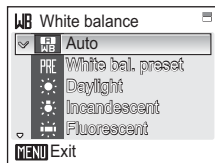

Auto

White balance automatically adjusted to suit lighting conditions. Best choice in most situations.

White bal. preset

Neutral-colored object used as reference to set white balance under unusual lighting conditions. See the next page for more information.

Daylight

White balance adjusted for direct sunlight.

Incandescent

Use under incandescent lighting.

Fluorescent

Use under most types of fluorescent lighting.

Cloudy

Use when taking pictures under overcast skies.

Flash

Use with the flash.

At settings other than [Auto], the icon for the current setting is displayed in the monitor ( 8).

Flash Mode

At white-balance settings other than [Auto] or [Flash], turn the flash off (  32).

PRE Preset White Balance

Preset white balance is used with mixed lighting or to compensate for light sources with a strong color cast (for example, to make pictures taken under a lamp with a red shade look as though they had been taken under white light).

1 Place a white or gray reference object under the lighting that will be used during shooting.

2 Use the rotary multi selector to choose [White bal. preset] in the white balance menu, and press **OK**.

The camera zooms in.

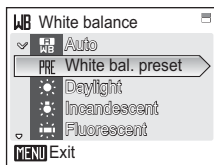

3 Choose [Measure].

To apply the most recently measured value for preset white balance, choose [Cancel] and press **OK**.

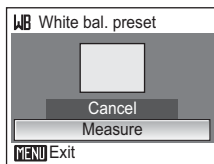

4 Frame the reference object.

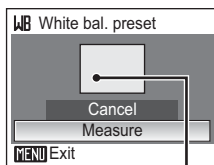

Reference object frame

5 Press **OK**.

The shutter is released and the new white balance value is set.
No pictures are recorded.

Note on Preset White Balance

Regardless of the flash mode selected, the flash will not fire when **OK** is pressed in step 5. Therefore, the camera cannot measure a value for preset white balance for when the flash is used.

☒ Exp. +/-

Exposure compensation is used to alter exposure from the value selected by the camera. Choose from values between -2.0 EV and $+2.0$ EV in increments of $\frac{1}{3}$ EV. Negative values produce darker pictures, positive values brighter pictures.

The icon for the current setting is displayed in the monitor (☒ 8).

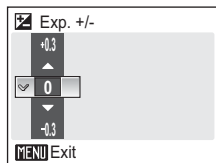

Continuous

Capture a fleeting expression on a portrait subject, photograph a subject that is moving unpredictably, or capture motion in a series of pictures. Focus, exposure, and white balance are fixed at the values for the first picture in each series.

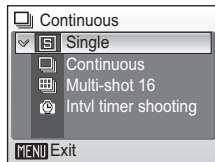

Single

One shot is taken each time shutter-release button is pressed.

Continuous

Pictures are taken continuously while the shutter-release button is pressed. When the image mode is  Normal(3072), camera takes 7 shots at about 1.4 frames per second.

Multi-shot 16

Each time shutter-release button is pressed, camera takes 16 shots at about 1.6 frames per second and arrange them in a single picture  Normal(2592) pixels as shown at right.

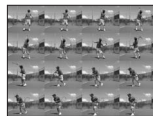

Intvl timer shooting

Camera takes pictures automatically at specified interval (up to 1,800 frames).

At settings other than [Single], the indicator for the current setting is displayed in the monitor ( 8).

Interval Timer Photography

Pictures are taken automatically at specified intervals. Choose from intervals between 30 seconds and 60 minutes. To prevent the camera from turning off unexpectedly during recording, use a fully charged battery.

- 1 Use the rotary multi selector to choose [Intvl timer shooting] in the continuous menu, and press .

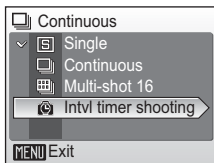

- 2 Choose interval between shots and press .

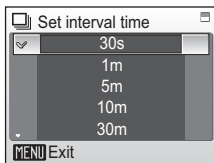

- 3 Press MENU.

The camera returns to shooting mode.

- 4 Press the shutter-release button fully to start recording.

Monitor turns off and indicator lamp blinks green between shots.

The monitor turns on automatically right before the next shot is taken.

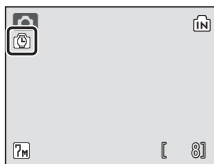

- 5 Press the shutter-release button fully a second time to end recording.

Recording will end automatically if the internal memory or memory card becomes full, or after 1,800 pictures are taken.

Best Shot Selector (BSS)

The “best shot selector” is recommended from situations in which inadvertent camera movement can result in blurred pictures, or when parts of the image are prone to under- or overexposure.

At [On] and [Exposure BSS] settings, the flash automatically turns off and focus, exposure, and white balance for all pictures are determined by the first picture in each series.

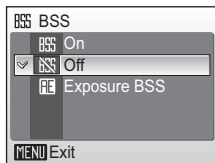

On

Recommended for taking pictures in poorly lit places, or in other situations where camera shake may occur. Camera takes shots while shutter-release button is pressed, to a maximum of ten. These images are then compared and the sharpest picture (picture with highest level of detail) is saved.

Off

Only one picture is taken.

Exposure BSS

Recommended for high-contrast subjects, when it is difficult to set exposure correctly.

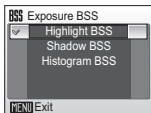

[Highlight BSS]: picture with smallest area of overexposure is selected.

[Shadow BSS]: picture with smallest area of underexposure is selected.

[Histogram BSS]: of pictures with least under- and over-exposure, camera chooses picture with overall exposure closest to optimum.

Camera takes five shots each time shutter-release button is pressed, but only the picture that best meets the selected criterion is saved.

The icon for the current setting is displayed in the monitor ( 8).

Note on Best Shot Selector

BSS may not produce the desired results if the subject moves or the composition changes while the shutter-release button is fully pressed.

ISO ISO Sensitivity

Sensitivity is a measure of how quickly the camera reacts to light. The higher the sensitivity, the less light needed to make an exposure. Although a high ISO rating is suited for taking pictures of subjects in action or in poor lighting, high sensitivity is often associated with “noise” -randomly spaced, brightly colored pixels concentrated in dark parts of the image.



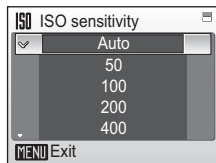

[Auto] is equivalent to ISO 50 under normal conditions; when lighting is poor and the flash is off, the camera compensates by raising sensitivity to a maximum of ISO 800 equivalent. Choose from values between ISO 50 and 1600 equivalent.

At settings other than [Auto], the current setting is displayed in the monitor (8). If [Auto] is selected and the sensitivity is raised above an ISO 50 equivalent, the **ISO** icon will be displayed (33).



Color Options

Make colors more vivid or record pictures in monochrome.

-  **Standard color**
Use for pictures exhibiting natural color.
-  **Vivid color**
Use to achieve a vivid, “photoprint” effect.
-  **Black-and-white**
Record pictures in black-and-white.
-  **Sepia**
Record pictures in sepia tones.
-  **Cyanotype**
Record pictures in cyan-blue monochrome.

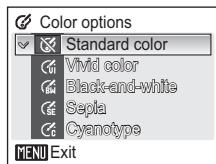

The effects of the selected option can be previewed in the monitor. At settings other than [Standard color], the icon for the current setting is displayed in the monitor (8).

[AF] AF Area Mode

Use this option to determine where the camera focuses.

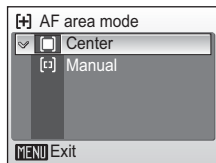

[■] Center

Camera focuses on subject in center of frame. Center focus area is used.

[□] Manual

Press the rotary multi selector ▲▼◀▶ to select from 99 focus areas in the frame. Pictures can be taken while focus area selection screen is displayed. To end focus area selection and adjust the flash, macro close-up, and self-timer settings, press Ⓞ. Press ▶ to change selection.

VR Electronic VR

When set to [Auto], the affects of camera shake and blurred subjects are reduced while pictures are taken under the following conditions:

- Flash mode is set to Ⓞ or Ⓞ
- Shutter speed is slow
- [Single] is selected in the continuous shooting menu

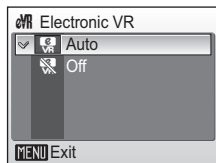

At settings other than [Off], the icon for the current setting is displayed in the monitor (8).

Notes on Electronic VR

- The electronic VR may not work properly immediately after the camera is turned on or reactivated from standby mode.
- The electronic VR does not work when the exposure time is faster than a certain value.
- The electronic VR is less effective for when pictures are considerably blurred.
- Blurred subjects cannot be compensated.

Restrictions on Camera Settings

Restrictions apply to the following settings in  (auto) mode:

Flash mode

Flash turns off at [Continuous] settings of [Continuous] or [Multi-shot 16], or when [BSS] is on. Applied setting is restored when [Single] or [Intvl timer shooting] is selected, or [BSS] is turned off.

Self-timer

If self-timer is on, only one shot will be taken when shutter is released, regardless of settings chosen for [Continuous] and [BSS]. Applied [Continuous] and [BSS] settings are restored when picture is taken or self-timer is turned off.

Continuous

Selecting [Continuous], [Multi-shot 16], or [Intvl timer shooting] turns [BSS] off. Applied [BSS] setting is *not* restored when [Single] is selected.

BSS

















[Continuous] is automatically set to [Single] when [On] or [Exposure BSS] is selected for [BSS]. Applied setting is *not* restored when [BSS] is turned off.

White balance

White balance is automatically set to [Auto] and cannot be adjusted when [Black-and-white], [Sepia], or [Cyanotype] is selected for [Color options]. Applied white balance setting is restored when [Standard color] or [Vivid color] is selected.

Playback Options: The Playback Menu

The playback menu contains the following options.

 Print set  109	Select pictures to print and the number of copies for each.
 Slide show  110	View pictures stored in the internal memory or on a memory card in an automatic slide show.
 Delete  111	Delete all or selected pictures.
 Protect  111	Protect selected pictures from accidental deletion.
 Transfer marking  112	Mark existing pictures to transfer to a computer.
 Rotate image  112	Change the orientation of an existing picture.
 Small pic.  58	Create a small copy of the current picture.
 Copy  113	Copy files between memory card and internal memory.

Displaying the Playback Menu

Display the playback menu by pressing  and pressing **MENU**.

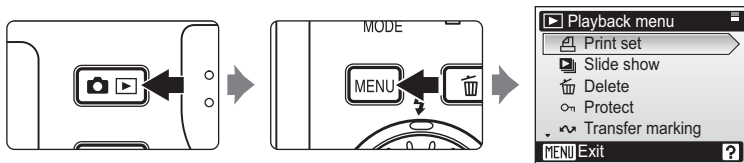

- Use the rotary multi selector to choose and apply settings. ( 12)
- To exit the playback menu, press **MENU**.

Selecting Multiple Pictures

Follow the steps below to select multiple pictures for a print set (📄 93), deletion (🗑️ 111), protection from deletion (🔒 111), transfer (📁 112), rotate (🔄 112), copying between internal memory and the memory card (📄 113), or for the welcome screen (👤 116). When pictures are selected, the screen at right is displayed. The process for protecting multiple pictures is shown here as example.

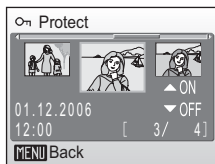

1 Use the rotary multi selector to choose a desired picture.

The current picture is displayed at the center of the monitor.

Only one picture can be selected for [Rotate image] and [Welcome screen]. Proceed to step 3.

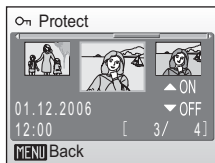

2 Press ▲▼ to select [ON] or [OFF] (or the number of copies).

When [ON] is selected, the indicator for the specified function is displayed in the center of the current picture. Repeat steps 1 and 2 to select additional pictures.

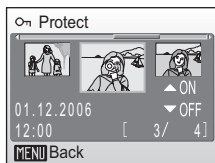

3 Press Ⓞ.

The setting is enabled.

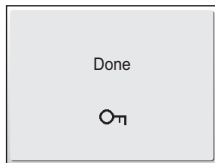

📄 Print Set

Create digital “print orders” for PictBridge printers (📄 177) and DPOF-compatible devices (📄 93).

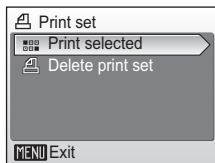

Slide Show

Play back pictures stored in the internal memory or on a memory card in an automated “slide show”.

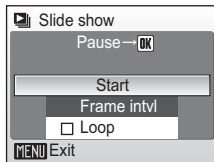

- 1 Display the slide show menu; use the rotary multi selector to choose [Start] and press **OK**.

To change the interval between pictures, choose [Frame interval], select the desired interval time, and press **OK** before choosing [Start].

To repeat the slide show automatically, enable [Loop] and press **OK** before choosing [Start]. **✓** will be added to the loop option when enabled.

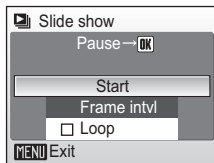

- 2 The slide show begins.

While the slide show is in progress, the following operations can be performed:

- Use the rotary multi selector to switch pictures. Continue rotating in either direction to fast forward (clockwise) or rewind (counterclockwise).
- Press **OK** to pause the slide show.

The menu shown at right is displayed when the slide show ends or is paused. Choose [Restart] and press **OK** to play the slide show again, or choose [End] to stop the slide show and return to the playback menu.

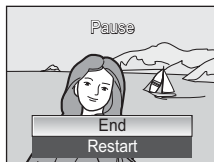

Notes on Slide Show

- Only the first frame of movies (**76**) included in slide shows is displayed.
- Even if [Loop] is selected, the monitor will turn off automatically if no operations are performed for 30 minutes. The camera will turn off automatically if no operations are performed for another three minutes.

Delete

The delete menu contains the options shown below.

If no memory card is inserted in the camera, pictures in the internal memory will be deleted.

If a memory card is inserted, pictures on the memory card will be deleted.

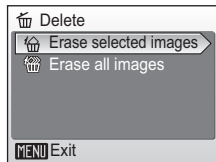



Erase selected images

Delete selected pictures ( 109).

Erase all images

Delete all pictures stored in the internal memory or on the memory card.

- Choose [Yes] and press  in the confirmation dialog to delete all pictures.
- To exit without deleting pictures, choose [No] and press .

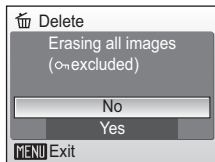

Notes on Deletion



- Once deleted, pictures cannot be recovered. Transfer important images to a computer before deletion.
- Pictures marked with the  icon are protected and cannot be deleted.

Protect

Protect selected pictures from accidental deletion.

Note, however, that formatting will delete protected files ( 125).

See “Selecting Multiple Pictures” ( 109) for more information on using this function.

Protected pictures are recognized by the  icon ( 9) displayed during playback.

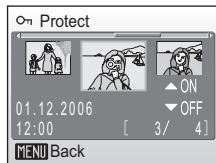

Transfer Marking

Change transfer marking (🌀) for existing pictures. When the camera is connected to a computer with PictureProject installed via the supplied USB cable, pressing **OK** transfers only the pictures marked with a 🌀 icon (📷 85, 155). At the default setting, all pictures are marked for transfer.

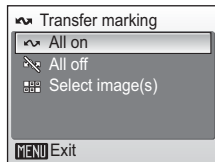

- 🌀 **All on**
 Mark all images for transfer.
- 📷 **All off**
 Remove transfer marking from all images.
- 📷📷 **Select Image(s)**
 Mark selected pictures for transfer in the picture selection screen (📷 109).

Pictures selected for transfer are recognized by the 🌀 icon (📷 9).

Rotate Image

Record pictures rotated 90° clockwise or counterclockwise.

Choose a file to be rotated in the picture selection screen (📷 109). To select the direction to rotate the chosen picture, rotate the rotary multi selector clockwise (or press **▶**) or counterclockwise (or press **◀**) in the rotate image screen.

When [Record orientation] (📷 124) is set to [Auto] (default setting), you can rotate (up to 180°) pictures taken in “tall” orientation by rotating the rotary multi selector either clockwise or counterclockwise.

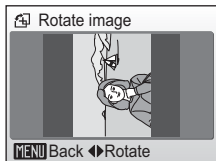
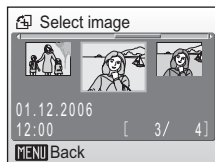

Rotate 90°
counterclockwise

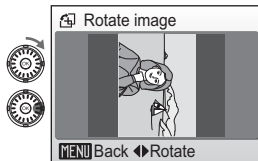
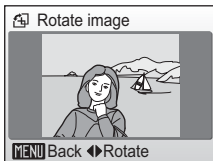

Rotate 90°
clockwise

Press **OK** to record the orientation for the picture as shown in the rotate image screen.

Copy

Copy pictures between the internal memory and a memory card.

First, select from the following options.

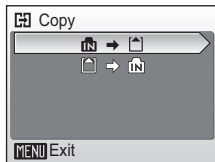

Copy pictures from internal memory to memory card.



Copy pictures from memory card to internal memory.

Then, select the desired copy option.

Choose [Selected images] ( 109) to copy specific pictures in the internal memory or memory card. To copy all pictures, choose [All images].

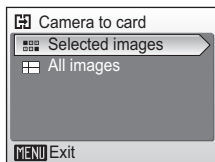



Notes on Copying Pictures

- If there is not enough space in the memory or on the memory card to receive the copy, an error message will be displayed. Delete unwanted pictures or insert a new memory card (if using a memory card) before trying again.
- The file format of images that can be copied is JPEG, MOV, or WAV.
- Pictures taken with another make of camera or that have been modified on a computer cannot be copied.

File Names of Copied Pictures



















- When pictures are copied using the [Selected images] option, the newly copied pictures are numbered consecutively from the largest number existing between the two memory sources. Ex: when the last number in the source memory is 32 (DSCN0032.JPG) and the last number in the destination memory is 18 (DSCN0018.JPG), the copied pictures are assigned numbers starting from DSCN0033.
- When pictures are copied using the [All images] option, all the pictures in the folder are copied with the same file numbers. New folder numbers are assigned in ascending order starting from the largest folder number available. If a new folder cannot be created, the folder is not copied and an error message will be displayed.

Copies

Edited copies have the same protection marking ( 111) as the original but are not marked for printing ( 93) or transfer ( 112).

Basic Camera Setup: The Setup Menu

The setup menu contains the following options.

	Menus  115
	Choose how menus are displayed.
	Quick startup  116
	Enable or disable welcome screen and start-up sound.
	Welcome screen  116
	Select screen displayed when camera is turned on.
	Date  117
	Set camera clock and choose home and destination time zones.
	Monitor settings  120
	Adjust monitor brightness and choose display style.
	Date imprint  121
	Imprint date or date counter on pictures.
	AF assist  123
	Enable or disable AF assist illumination.
	Sound settings  123
	Adjust sound and volume settings.
	Record orientation  124
	Choose whether or not to record the orientation of a picture taken.
	Auto off  124
	Set time before camera enters standby mode to save power.
	Format memory/Format card  125
	Format internal memory or memory card.
	Language  126
	Choose language for camera menus and messages.
	Interface  126
	Adjust settings for connection to television or computer.
	Reset all  127
	Restore camera settings to default values.
	Firmware version  129
	Display camera firmware version.





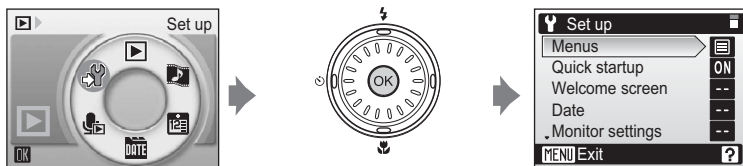



Displaying the Setup Menu

First, display the mode-selection menu by pressing **m**. Then select  (use the rotary multi selector), press **OK**.



- Use the rotary multi selector to choose and apply settings. ( 12)
- To exit the setup menu, press **MENU**.

MENU Menu

Choose whether the initial menu displayed for the shooting menu ( 96), high-sensitivity ( 97), scene menu ( 37), movie menu ( 71), one-touch portrait menu ( 51), anti-shake menu ( 49), playback menu ( 108), and setup menu (displayed when **MENU** is pressed) ( 114) use text or icons.

When [Icons] is selected, all menu items can be displayed in a single page and the highlighted menu name appears at the top of the monitor.

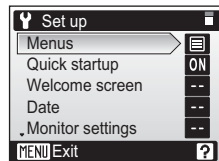
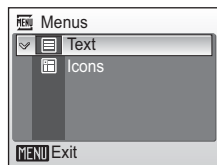

[Text]

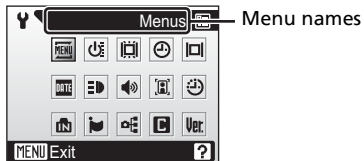

[Icons]

Quick Startup

Choose [On] to disable the welcome screen and start-up sound. The camera will be ready for shooting as soon as it is turned on.

Set to [Off] when enabling the welcome screen.

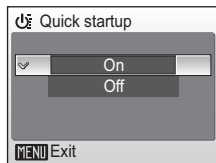

Welcome Screen

You can select the welcome screen to be displayed when the camera is turned on.

To set the welcome screen, [Quick startup] must be set to [Off].

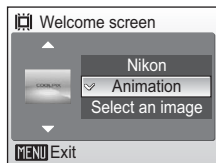

Nikon

Displays a welcome screen when the camera is turned on.

Animation (default)

Displays a short animation when the camera is turned on.

Select an image

Select a picture in the internal memory or on the memory card for the welcome screen. The image used in the welcome screen is a copy of the selected picture and, therefore, is not affected if the original picture is deleted or the memory card is removed.

- 1 Choose a picture in the picture selection screen.
 - See “Selecting Multiple Pictures” (109) for more information.
- 2 Press .

When [Select an image] is Selected

If you have already selected a welcome screen picture, you can select a new one by following the confirmation dialog.

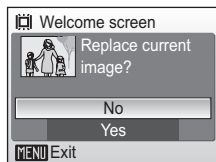

Date

Set the camera clock and choose home and travel destination time zones.

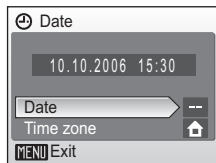

Date

Set camera clock to current date and time.

See "Setting Display Language, Date, and Time" (📖 20-21) for more information.

Time zone

Useful when travelling. When ➔ (destination time zone) is selected, the time difference (📖 119) is automatically calculated and the date and time in the selected region are displayed.

Setting Travel Destination Time Zone

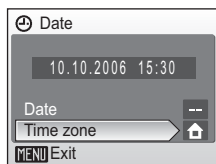

- 1 Use the rotary multi selector to choose [Time zone] and press .

The time zone menu is displayed.



- 2 Choose ➔ and press .

The date and time displayed on the monitor changes according to the region currently selected.

If daylight saving time is in effect, use the rotary multi selector to choose [DaylightSaving] press  and then press . The time is automatically advanced one hour.

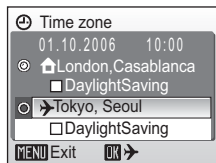

- 3 Press .

The new city time zone menu is displayed.

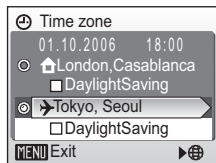

4 Choose the travel destination time zone and press **OK**.

The setting is enabled.

Press **MENU** to return to shooting or playback mode.

While the travel destination time zone is selected, the **➔** icon will be displayed in the monitor when the camera is in shooting mode.

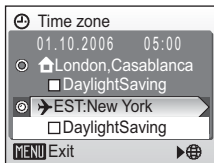
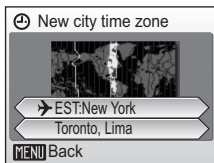

✓ The Clock Battery

The clock battery charges when the main battery is installed or an AC adapter is connected, and can provide several days of backup power after about 10 hours of charging.

✍ **🏠 (Home Time Zone)**

- To switch to the home time zone, choose **🏠** in step 2.
- To change the home time zone, choose **🏠** in step 2 and perform the following steps for the home time zone.

✍ **🕒 Daylight Saving Time**

To disable daylight saving time, turn [DaylightSaving] off (**✓**) in the time zone menu.

- 1 Use the rotary multi selector to choose **🏠** (home time zone) or **➔** (destination time zone) and press **OK**.
- 2 Choose [DaylightSaving].
- 3 Press **OK** to turn off the check box (**✓**).
 - The camera clock is automatically set back one hour.
 - Press **OK** again to turn on the check box (**✓**).
- 4 Press **MENU**.
 - The setting is enabled and the camera returns to shooting or playback mode.

Time Zones (📷 20)

The camera supports the time zones listed below. Increments of less than one hour are not supported; when travelling to or from destinations at half- or quarter-hour increments from Greenwich Mean Time (GMT), such as Afghanistan, Central Australia, India, Iran, Nepal, or Newfoundland, set the camera clock to local time (📷 20, 117).

GMT +/-	Location	GMT +/-	Location
-11	Midway, Samoa	+1	Madrid, Paris, Berlin
-10	Hawaii, Tahiti	+2	Athens, Helsinki
-9	Alaska, Anchorage	+3	Moscow, Nairobi
-8	PST (PDT): Los Angeles, Seattle, Vancouver	+4	Abu Dhabi, Dubai
-7	MST (MDT): Denver, Phoenix, La Paz	+5	Islamabad, Karachi
-6	CST (CDT): Chicago, Houston, Mexico City	+6	Colombo, Dhaka
-5	EST (EDT): New York, Toronto, Lima	+7	Bangkok, Jakarta
-4	Caracas, Manaus	+8	Beijing, Hong Kong, Singapore
-3	Buenos Aires, São Paulo	+9	Tokyo, Seoul
-2	Fernando de Noronha	+10	Sydney, Guam
-1	Azores	+11	New Caledonia
±0	London, Casablanca	+12	Auckland, Fiji

Monitor Settings

Choose whether or not to display information in the monitor, and set the monitor brightness.

Photo info

Choose information displayed in monitor during shooting and playback mode.

Brightness

Choose from five settings for monitor brightness.

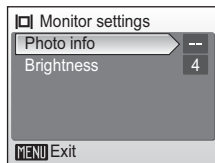

Photo Info

The following display options are available.

See “The Monitor” (📷 8) for information on indicators in the monitor.

	Shooting mode	Playback mode
Show info		
Auto info	The current settings or operation guide is displayed for five seconds as in [Show info] above. After five seconds, display will be the same as [Hide info].	
Hide info		
Framing grid	 In 📷 (auto) mode, a framing grid is displayed to help frame pictures; other current settings or operation guide is displayed for five seconds as in [Auto info] above. In other shooting modes, the current settings or operation guide is displayed as in [Show info] above.	 The current settings or operation guide is displayed as in [Show info] above.

DATE Date Imprint

Date and time of recording can be imprinted on pictures for printing this information from printers that are not DPOF-compatible (📷 168).

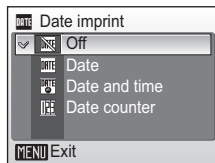

Date

Date is imprinted on the bottom right corner of pictures taken while this option is in effect.

Date and time

Date and time are imprinted on the bottom right corner of pictures taken while this option is in effect.

Date counter

Time stamp shows number of days between date of recording and selected date.

At settings other than [Off], the icon for the current setting is displayed in the monitor (📷 8).

✔ Date Imprint

- Imprinted dates form a permanent part of image data and cannot be deleted.
- When [Date imprint] is set, [Electronic VR] will automatically be disabled even if set to [Auto] (📷 106). In 📷 (auto) and scene modes, vibration reduction will not function even for conditions where it is normally applied. Note that enabling [Electronic VR] again will disable [Date imprint].
- Even if [Date imprint] is enabled, the date will not be imprinted on pictures taken in anti-shake mode (📷 49).
- Dates imprinted at an image-mode setting of [TV screen(640)] (📷 97) may be difficult to read. Choose [PC screen(1024)] or larger when using date imprint.
- The date is recorded using the format selected in the setup menu's [Date] item (📷 20, 117).

📷 Date Imprint and Print Set

When using DPOF-compatible devices, shooting date or photo information will be printed if [Date] or [Info] is selected in the print set menu (📷 93). See "Differences Between Print Set and Date Imprint" (📷 94) for more information on the difference between [Date imprint] and [Print set].

Date Counter

Pictures taken while this option is in effect are imprinted with the number of days remaining until, or the number of days elapsed since a specified date. Use it to track the growth of a child or count down the days until a birthday or wedding.

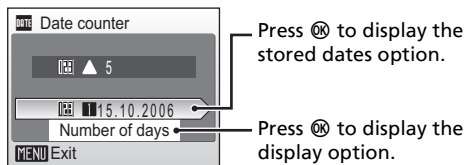

Stored dates

Up to three dates can be stored. To set, choose an option, press the rotary multi selector **▶**, enter a date (**20**), and press **OK**. To select a different date, choose an option and press **OK**.

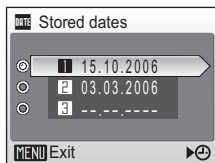

Display options

Choose [Number of days], [Years and days], or [Yrs, mnths, days] and press **OK**.

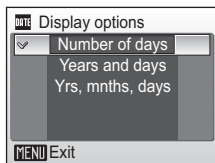

Sample date counter time stamps are shown below.



Two days remaining



Two days elapsed

☰ AF Assist

If [Auto] is selected, AF-assist illumination will be used to assist the focus operation when the subject is poorly lit.

Note that for some modes, AF-assist illumination turns off automatically.

To disable this function, choose [Off]. When set to [Off], the camera may be unable to focus if lighting is poor.

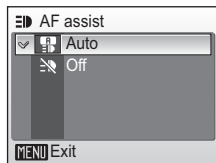

🔊 Sound Settings

Adjust the following sound settings.

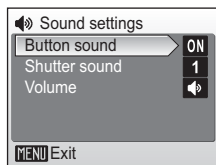

Button sound

When [On] is selected, beep will sound once when operations are completed successfully, three times when error is detected.

Shutter sound

Choose shutter sound from [1], [2], [3], and [Off].

Volume

Choose volume of shutter sound from [Loud], [Normal], and [Off].

Record Orientation

Choose whether or not to record the orientation of pictures taken in “tall” orientation.

Choose [Auto] to record the picture’s orientation detected by the camera’s sensor. The taken picture will be automatically rotated when played back on the camera monitor or with PictureProject. When [Off] is selected, the picture will be displayed in the same orientation as it was taken.

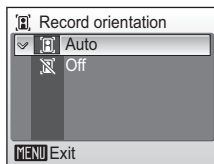

Auto Off

Choose the time allowed to elapse before the camera enters standby mode to save power ( 25). The time options are 30 seconds, one minute, five minutes, and 30 minutes. The power-on lamp flashes in standby mode. If no operations are performed for another three minutes, the camera turns off.

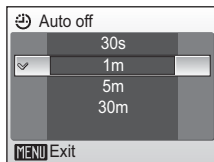

Notes on Auto Off

The monitor will remain on for a minimum of:

- Three minutes when menus are displayed
- Thirty minutes during continuous playback for slide shows and Pictmotion movies, or when the AC adapter is connected

Format Memory/ Format Card

Format the internal memory or a memory card.

Formatting the Internal Memory

If no memory card is inserted, this option is labeled [Format memory] and formats internal memory. Remove the memory card from the camera to format the internal memory.

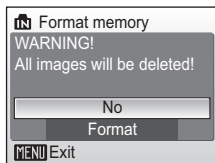

Formatting a Memory Card

If a memory card is inserted, the option is labeled [Format card] and formats the memory card.

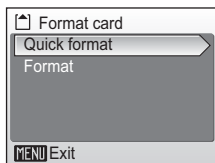

Quick format

Formats only portions of the memory card containing data.

Format

Formats the entire memory card including portions with no recorded data. [Format] takes longer than [Quick format].

Formatting Internal Memory and Memory Cards

- Formatting the internal memory or memory cards permanently deletes all data. Be sure to transfer important pictures to a computer before formatting.
- Do not turn the camera off, disconnect the AC charger, or remove the battery or memory card during formatting.
- The first time you insert the memory cards used in other devices into the COOLPIX S7c, format them with [Format]. Repeated recording and deleting of pictures without regular formatting reduces memory card performance.
- Regular formatting of memory cards is recommended to maintain maximum performance.
- [Format] is not available when the battery is low.

🗨 Language

Choose one of 20 languages for display of camera menus and messages.

Čeština	Italiano	Svenska
Dansk	Nederlands	中文简体
Deutsch	Norsk	中文繁體
English	Polski	日本語
Español	Português	한국
Français	Русский	ภาษาไทย
Indonesia	Suomi	

Čeština	Czech
Dansk	Danish
Deutsch	German
English	(default)
Español	Spanish
Français	French
Indonesia	Indonesian
Italiano	Italian
Nederlands	Dutch
Norsk	Norwegian

Polski	Polish
Português	Portuguese
Русский	Russian
Suomi	Finnish
Svenska	Swedish
中文简体	Simplified Chinese
中文繁體	Traditional Chinese
日本語	Japanese
한국	Korean
ภาษาไทย	Thai

🔌 Interface

Adjust settings for connection to a computer or television.

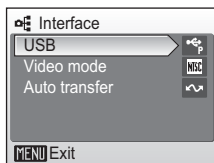

USB

Select [Mass storage] or [PTP] for connection to computer (🔑 83) or printer (🖨 88).

Video mode

Choose from [NTSC] and [PAL].

Auto transfer



Choose [On] to mark all new pictures for transfer to computer (🔑 86).

Reset All

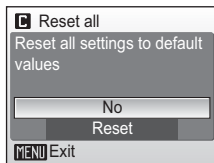



This option restores the following settings to their default values:



Pop-up menu

Flash mode ( 32)	Auto
Self-timer ( 34)	Off
Macro close-up ( 35)	Off



Scene mode

Scene mode ( 37)	Portrait
Portrait assist ( 39)	Portrait
Landscape assist ( 40)	Landscape
Sports assist ( 41)	Sports
Night portrait assist ( 42)	Night portrait





One-touch portrait menu

Portrait effect ( 51)	Normal
---	--------

Movie menu

Movie options ( 72)	Small size 320
Auto-focus mode ( 75)	Single AF
Electronic VR ( 75)	Off

Pictmotion menu

Background music ( 68)	High-speed
Effects ( 68)	Motion
Playback order ( 68)	Random
Loop ( 68)	Repeat photos
Selected images ( 68)	10 pictures

Shooting menu

Image mode (📷 97)	Normal(3072)
White balance (📷 99)	Auto
Exposure compensation (📷 101)	0
Continuous (📷 102)	Single
BSS (📷 104)	Off
ISO sensitivity (📷 105)	Auto
Color options (📷 105)	Standard color
AF area mode (📷 106)	Center
Electronic VR (📷 106)	Auto

Setup menu

Menus (📷 115)	Text
Quick startup (📷 116)	On
Welcome screen (📷 116)	Animation
Photo info (📷 120)	Auto info
Brightness (📷 120)	4
Date imprint (📷 121)	Off
AF assist (📷 123)	Auto
Button sound (📷 123)	On
Shutter sound (📷 123)	1
Volume (📷 123)	Normal
Record orientation (📷 124)	Auto
Auto off (📷 124)	1m
Auto transfer (📷 126)	On

Others

Sound quality (📷 78)	High
Paper size (📷 89, 90)	Default

Wireless Transfer Menu

Confirm Transfer (📷 154)	Off
Save Images (📷 154)	Off

- Choosing [Reset all] also clears the current file number (🔑 160) from the memory. Numbering will continue from the lowest number available. To reset file numbering to “0001”, delete all pictures (🔑 111) before selecting [Reset all].
- Settings for [Date] (🔑 117), [Date counter] (🔑 122), [Language] (🔑 126), [USB] (🔑 126), and [Video mode] (🔑 126) will remain unaffected even if [Reset all] is performed.

Ver: Firmware Version

View the current camera firmware version.

The 12-digit number displayed below the firmware version is the camera’s MAC address.



MAC address

What is Wireless Transfer Mode?

COOLPIX S7c is equipped with a wireless transfer mode, which is based on the IEEE 802.11b/g standard. This section describes how the wireless transfer mode works using the wireless LAN communication feature, and also describes the configuration necessary for wireless transfer mode.

Features of Wireless Transfer Mode

COOLPIX CONNECT

Pictures stored in the camera's internal memory or on a memory card can be viewed by your family and friends via e-mail and webpage. For more information on the COOLPIX CONNECT service, refer to "Uploading Pictures to COOLPIX CONNECT" (📖 145).

PC Connection

- Pictures stored in the camera's internal memory or on a memory card can be transferred to a computer via home wireless LAN.
- Just-taken pictures can be immediately transferred to a computer wirelessly connected.

Wireless Printing

- Pictures can be printed with a printer connected to a computer that is wirelessly connected via home wireless LAN.
- Pictures can be directly transferred to a PictBridge-compatible printer and printed using the optional wireless printer adapter PD-10.



Note on Screen Images

Screen images in monitor may differ from the actual display.



Note on Wireless LAN Configuration

For more information on wireless LAN configuration, contact the manufacturer of the wireless LAN adapter or access point, or see other commercially available references.

Home Wireless LAN

- This refers to wireless LAN networks connected via ad-hoc mode or infrastructure mode at home or at the office.
- If Internet connection is possible from the home wireless LAN (Infrastructure mode), you can use the COOLPIX CONNECT service. However, if the home wireless LAN uses a proxy server to connect to the Internet, the COOLPIX CONNECT service is not available.

Ad-hoc Mode and Infrastructure Mode

- Ad-hoc mode establishes a peer-to-peer (one-to-one) connection with a wireless LAN-capable device. With the COOLPIX S7c's wireless transfer mode, a peer-to-peer connection is established between the camera and computer.
- Infrastructure mode connects a wireless LAN-capable device to a wireless LAN network via an access point. With the COOLPIX S7c's wireless transfer mode, this mode connects the camera and computer via a wireless LAN access point.

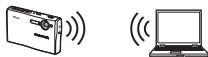

The Wireless Camera Setup Utility

- To use wireless transfer mode (for configuration and transferring pictures), the Wireless Camera Setup Utility 2.0 (Setup Utility hereafter) is necessary. Use the supplied Wireless Camera Setup Utility/PictureProject Software CD to install the Setup Utility.
- The Setup Utility is used for configuring profiles, and must be installed to the computer used for PC connection (☞ 130, 150). Also, the Setup Utility is used for renaming or deleting profiles, changing the destination folder when transferring pictures to the computer, and switching the printer used for wireless printing.
- See the *Quick Start Guide* for more information on installing the Setup Utility.

The Features Available in the Wireless Transfer Mode

The features below are available in the COOLPIX S7c's wireless transfer mode.

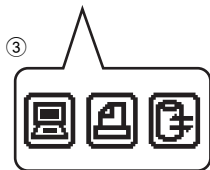
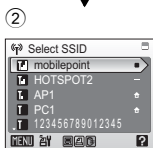
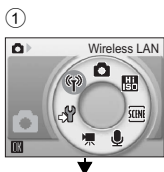

When wireless transfer mode is selected in the mode menu (①), after required configurations are made, the list of network names (SSID) detected by the camera is displayed (②).

When selecting the desired SSID, the features available with that SSID are displayed by icon (③) (actual display varies with current settings).

Features

COOLPIX CONNECT

COOLPIX CONNECT (via home wireless LAN)
COOLPIX CONNECT can be used by connecting the camera directly to the Internet via home wireless LAN.

PC Connection

Easy Transfer (including Pictmotion movies)
Transfer pictures and Pictmotion movies not yet saved in the computer.

Easy Transfer (excluding Pictmotion movies)
Transfer pictures not yet saved in the computer (excluding Pictmotion movies).

Shooting Date
Transfer all pictures taken on a specific recording date.

Selected Images
Transfer only selected pictures.

Shoot & Transfer
Immediately transfer taken pictures.

Marked Images
Transfer pictures with the transfer icon (📁).

PC Mode
After connecting the camera and the computer wirelessly, transfer pictures by operating the computer.

Wireless Printing

Wireless Printing
Print pictures wirelessly from the camera via a computer.

Wireless Printing
Print pictures wirelessly from the camera directly via an optional PD-10 wireless printer adapter connected with a printer.

The Features Available in the Wireless Transfer Mode

Requirements	Configuring	Operating
<ul style="list-style-type: none"> Internet-capable wireless LAN (☒ 134) Wireless LAN-capable computer with the Setup Utility. 	☒ 134	☒ 145
<ul style="list-style-type: none"> Home wireless LAN (Ad-hoc mode or Infrastructure mode) Wireless LAN-capable computer with the Setup Utility. 	☒ 134	<ul style="list-style-type: none"> ☒ 150 ☒ 150 ☒ 151 ☒ 152 ☒ 153 ☒ 155 ☒ 156
<ul style="list-style-type: none"> Printer connected with computer is needed in addition to the requirements for PC connection above. 	☒ 134	☒ 158
<ul style="list-style-type: none"> Optional PD-10 wireless printer adapter Connection setup for the camera and the PD-10. 	☒ 158	Refer to the PD-10 instruction manual.

For Connection via Home Wireless LAN

Connect to a home wireless LAN wirelessly and make necessary configurations for connecting to COOLPIX CONNECT (via home wireless LAN), connecting to a computer wirelessly, and for wireless printing.

Configuration Procedure

This section gives a brief description about the procedure for creating a wireless connection. See “Configuring the Camera” ( 136) for details.

- 1** Prepare a wireless LAN-capable computer.
 - 2** Install the Setup Utility to the computer.
 - 3** Check that the USB setting is correctly selected in the camera and the battery is not exhausted, and turn off the camera.
 - 4** Connect the computer and camera using the USB cable.
 - 5** Start the Setup Utility.
 - 6** Choose the action [Add profiles].
 - 7** Choose the profile type [Add Profile at Home Wireless LAN].
- 

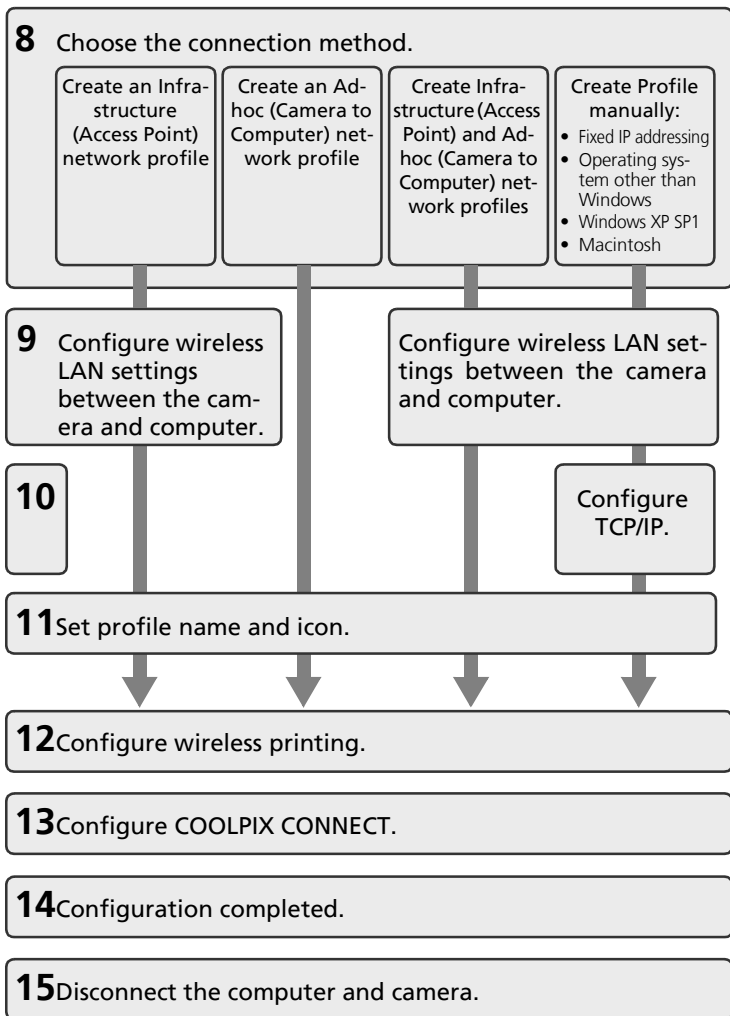

Configuring the Camera

This section describes the “Configuration Procedure” (☒ 134) in detail.

- To display more information on each step, click [Help]. To cancel configuring a profile device, click [Cancel].

1 Prepare a wireless LAN-capable computer.

2 Install the Setup Utility to the computer.

Check whether the Setup Utility (☒ 131) is installed on the computer used for configuring.

3 Check that the USB setting is correctly selected in the camera and the battery is not exhausted, and turn off the camera.

Check the following before starting the Setup Utility on the computer. After checking is complete, turn off the camera.

- [Interface] > [USB] (☒ 126) is set to [PTP].
- The battery is fully charged or the supplied AC adapter is connected. If the battery runs out while configuring a profile, settings will not be entered correctly.

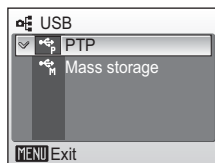

4 Connect the computer and camera using the USB cable.

Place the camera in the COOL-STATION and connect to the computer using the supplied USB cable. Then, turn on the camera.

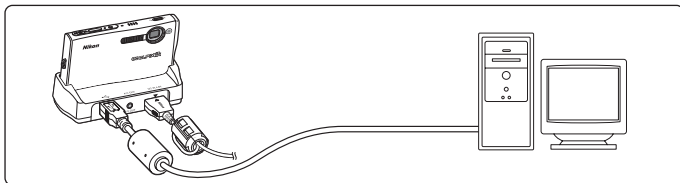

5 Start the Setup Utility.

For the initial installation run, the Setup Utility will launch automatically when installation is complete.

From the second time, start the Setup Utility by following the procedure below:

Windows: Start the computer and select [Start] > [All programs] > [Wireless Camera Setup Utility] > [Wireless Camera Setup Utility].

Macintosh: Start the computer and open [Applications] > [Nikon Software] > [Wireless Camera Setup Utility] folder. Then double-click the [NkWirelessSetup] icon.

- Click [Next] after checking the contents shown in the screen at right.



6 Choose the action [Add profiles].



7 Choose the profile type [Add Profile at Home Wireless LAN].

You can start configuration of infrastructure mode or ad-hoc mode for the computer connected to the wireless LAN.

Set up for Public Wireless LAN is available only for T-Mobile HotSpot in United States.



8 Choose the connection method.

Available profile types (see the list below) for your wireless LAN will be displayed on screen. Select the desired profile type and click [Next].

When selecting [Create an Ad-hoc (Camera to Computer) network profile], proceed to step 11 (139).

If multiple wireless LAN devices are connected to the computer, choose a device from the pop-up menu. Select the desired configuration type from the options listed. Options displayed will differ depending on the selected wireless device.



Type of Profile	Descriptions
Infrastructure (Access Point) network profile	For use when connecting the camera and computer via an infrastructure network. An infrastructure network must be configured beforehand.
Ad-hoc (Camera to Computer) network profile	For use when establishing a one-to-one connection (when a wireless LAN access point is not available) between the camera and computer.
Infrastructure (Access Point) and Ad-hoc (Camera to Computer) network profiles	Recommended for users of multiple wireless network profiles.
Create Profile manually	For use with manual settings. Only [Create Profile manually] is available when: <ul style="list-style-type: none"> - configuration for wireless LAN network is not performed using the wireless network setting function (Zero Config) for Windows XP - using a Windows XP SP1 or Mac OS X operating system - your computer has a fixed IP address

✔ Note on Choosing [Create an Ad-hoc (Camera to Computer) network profile] on Windows XP

- When configuring a profile device using an ad-hoc network between the camera and computer, the computer's fixed IP address (manually entered IP address) will be automatically set to "169.254.x.x". When adding an infrastructure network later, set the computer to automatically obtain an IP address. For the added network profiles, configure wireless settings between the camera and computer again.
- [Create an Ad-hoc (Camera to Computer) network profile] cannot be selected if an infrastructure network has already been set up in your computer, or the fixed IP address is not "169.254.x.x".

9 Enter network settings.

Enter the settings for connecting the camera and computer via a wireless network.

When selecting [Create an Infrastructure (Access Point) network profile] or [Create Infrastructure (Access Point) and Ad-hoc (Camera to Computer) network profiles] in step 8, select a network name from the [Network Name (SSID)] list. This name will be used when connecting the camera and computer.

When selecting [Create Profile manually] in step 8, manually enter the same values set in the computer for all items except those that are automatically provided. See “Settings for the Setup Utility” for reference (☞ 141).

When settings are complete, click [Next].



10 Configure TCP/IP.

When selecting [Create Profile manually] in step 8, or if the screen in step 8 does not appear, manually enter the address type and IP address, referring to those used in “Settings for the Setup Utility” (☞ 141).

When settings are complete, click [Next].

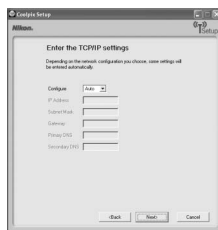

11 Set profile name and icon.

Enter a profile name (up to 16 single-byte alphanumeric characters).

The entered profile name will appear in the selection list for the profile device (☞ 144). We recommend selecting a name that will let you easily tell devices apart, such as “Desktop-Home”.

When settings are complete, click [Next].



12 Configure wireless printing.

If a printer is connected to the computer, check [Create Wireless Printing Profile] and select the printer to be used for wireless printing (☒ 158).

Enter a profile name (up to 16 single-byte alphanumeric characters), select a printer, and click [Next].

If no printers are connected to the computer, click [Next] without selecting a printer.

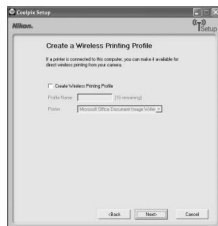

13 Configure COOLPIX CONNECT.

If using COOLPIX CONNECT, enter the profile name for COOLPIX CONNECT.

- Check [Create a COOLPIX CONNECT Profile] and enter a profile name (up to 16 single byte alphanumeric characters) and click [Next].



14 Settings are complete.

Select [Finish wizard] and click [Next].

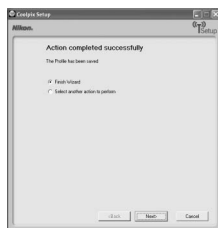

15 Disconnect the computer and camera.

Turn off the camera before removing it from the COOL-STATION.

Settings for the Setup Utility

When configuring a profile using the Setup Utility, refer to the description for each item listed below. Settings are the same for Windows and Macintosh.

* Mandatory items

Settings	Descriptions										
Network name (SSID)*	Enter the network ID for the computer. Choose a value displayed. If multiple values are displayed, select one.										
Network type*	Select [Ad-hoc] or [Infrastructure]. The camera and computer must be set to the same configuration. <ul style="list-style-type: none"> • Ad-hoc mode: This mode establishes a peer-to-peer (one-to-one) connection between the camera and computer. • Infrastructure mode: This mode connects the camera and computer via a wireless LAN access point. 										
Channel	Mandatory if [Ad-hoc] is selected for [Network type]. Select the same channel (1 to 11) set in the computer.										
Authentication	Select [Open System], [Shared Key], [WPA-PSK]* or [WPA2-PSK]* (* [Infrastructure] only). Select the same method set in the computer or access point.										
Encryption	Available methods for the camera differ depending on the selected authentication method (see below). Select the same method set in the computer or access point.										
	<table border="1"> <thead> <tr> <th>Selected authentication method</th> <th>Available security method(s) for the camera</th> </tr> </thead> <tbody> <tr> <td>[Open System]</td> <td>[None], [WEP]</td> </tr> <tr> <td>[Shared Key]</td> <td>[WEP]</td> </tr> <tr> <td>[WPA-PSK]</td> <td>[TKIP]</td> </tr> <tr> <td>[WPA2-PSK]</td> <td>[AES]</td> </tr> </tbody> </table>	Selected authentication method	Available security method(s) for the camera	[Open System]	[None], [WEP]	[Shared Key]	[WEP]	[WPA-PSK]	[TKIP]	[WPA2-PSK]	[AES]
	Selected authentication method	Available security method(s) for the camera									
	[Open System]	[None], [WEP]									
	[Shared Key]	[WEP]									
[WPA-PSK]	[TKIP]										
[WPA2-PSK]	[AES]										
Encryption key	Enter the security key set in the computer or access point (unnecessary when [Encryption] is set to [None]).										
Key index	When [Encryption] is set to [WEP], and infrastructure mode is used, select the same key index set in the computer or access point (unnecessary when [Encryption] is set to [None], [TKIP] or [AES]). The default setting is [1].										

Settings	Descriptions
Configure*	Select [Auto] (default setting) or [Manual] for the method of setting the camera IP address.
IP Address	When [Configure] is set to [Manual], enter the IP address for the camera.

Wireless LAN Channels

Wireless LAN channels for the COOLPIX S7c are from 1 to 11. Make sure that the channel for your computer's wireless LAN device is set to a channel between 1 and 11 (inclusive).

MAC Address Filtering

When MAC address filtering is enabled, only devices with an authorized MAC address can access the wireless LAN. Check the camera's MAC address in [Firmware Version] of the setup menu (▶ 129) and add it to the authorized list.

Port Number

For wireless communication, the UDP port number is "5353" and the TCP port number is "15740". If the computer or access point has a firewall, the firewall settings may need to be changed.

Notes on Profile Devices

- Configure profiles for each computer using the Setup Utility and install the Setup Utility to each computer to transfer (receive) pictures from the camera remotely.
- You can configure a maximum of nine profile devices (computers, printers connected to a computer, the optional PD-10 wireless printer adapter, etc.) in the camera. If nine have already been configured and you want to add a new one, delete an unneeded profile device using the Setup Utility.
- Start the Setup Utility while the camera is connected to a computer via USB cable, and you can rename or delete profiles. Choose [Rename/Delete profiles] in the action selection screen of the Setup Utility and click [Next]. Then choose a profile you wish to rename or delete and click [Rename] or [Delete]. You can also confirm the details of a profile by clicking [View Profile]. Choose [Reset camera] in the action selection screen to delete all profiles (all address book contents are also deleted).

Transferring Pictures

Establishing a Wireless Connection

- 1 Enter wireless transfer mode by pressing **m** in shooting mode, selecting  (use the rotary multi selector), and then pressing **OK**.

The wireless LAN start-up screen will be displayed and the camera will search for available SSIDs.

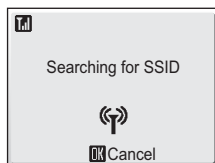

- 2 Choose the SSID and press **OK**.

The SSIDs are listed in order of radio field strength.

Wireless connection has not yet been established.

The left icon of each SSID is indicated in red when outside the network area.

The right icon indicates the type of the profile registered to each SSID:

- 🏠 (profiles with home wireless LAN information),
- (profiles with no information)

Connection is attempted with the selected network (SSID) when picture transfer is attempted.

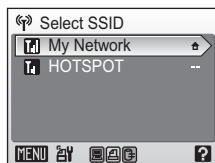

- 3 Choose the desired transfer or printing method and press **OK**.

When selecting [COOLPIX CONNECT], see "Uploading Pictures to COOLPIX CONNECT" (145).

When selecting [Wireless Printing], see "Printing Pictures (Wireless Printing)" (158).

When selecting other options, see "Transferring Pictures to a Computer (PC Connection)" (149).

If no operations are performed about three minutes, auto power off will take effect and the monitor turns off. Although auto power off will also take effect during wireless transfer mode, transfer will continue.

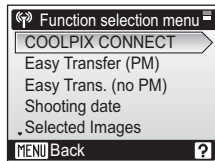

When Transfer is Complete

The message shown at right is displayed when the transfer is complete.

- To repeat the transfer, press **OK**.
- To exit wireless transfer mode, press **m** and choose another mode, or turn off the camera.

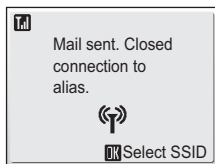

Wireless Transfer LED

The wireless transfer LED (**6**) is located on the side of the camera (inside the antenna). The camera is searching for profiles when the LED blinks, a wireless connection is established when the LED is lit, and the camera is disconnected from a wireless LAN when the LED is off. If transfer is not performed for a while, the LED may blink to save power.

Note on Wireless Transfer Mode

The camera strap eyelet may become hot during wireless communication (i.e., when the wireless transfer LED is lit or is blinking). Observe due caution when handling the camera.

The Memory Card Write-Protect Switch

When the memory card write-protect switch is in the “lock” position, transfer cannot be performed. Unlock by sliding the switch to the “write” position before transferring pictures.

When the Transfer is Unsuccessful

When transfer is unsuccessful, the next time you attempt transfer, the confirmation dialog shown at right will be displayed. If necessary, you can change profiles from the confirmation dialog. Complete transfer, making sure that it was successful.

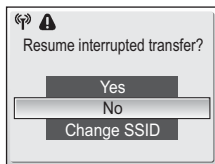

Selecting a Computer or Printer

When the selected SSID has multiple computers or printers registered, the screen shown at right will be displayed after step 3 (**143**). Select the desired computer or printer.

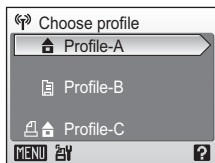

Checking SSID Contents

Pressing the zoom control to **T** (**143**) in the SSID selection screen displays the information for the selected profile including the network name (SSID), type of computer and printer.

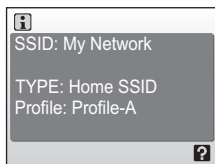

Uploading Pictures to COOLPIX CONNECT

To use COOLPIX CONNECT, perform the following procedures.

- 1 Choose [COOLPIX CONNECT] in step 3 of "Establishing a Wireless Connection" (143) and press **OK**.

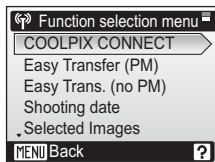

- 2 Enter your e-mail address correctly.

Choose [Input] in the sender information entry screen and press **OK**.

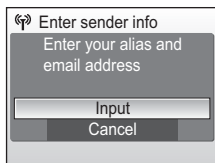

Enter your e-mail correctly in the address screen and press the shutter-release button. Then enter your (sender) name for the notification e-mail to recipients and press the shutter-release button. For information on how to enter characters, see "Entering Characters on the Camera" (148).

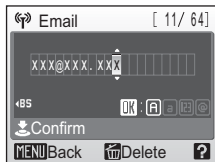

3 Choose [All images] or [Choose date] and press **OK**.

When choosing [All images], select the desired pictures (up to 30) and press **OK** to mark. Then press the shutter-release button to apply selection.

When choosing [Choose date], select the shooting date and press **OK** to mark. Then press the shutter-release button.

Select the desired pictures (up to 30) and press **OK** to mark. Then press the shutter-release button to apply selection.

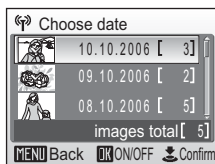
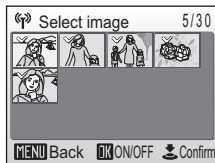
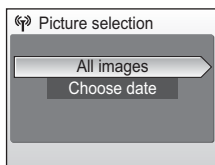

4 Choose the size for the pictures to be transferred and press the shutter release button.

Choose the size for the pictures to upload and press **OK** to mark.

Photoprint	1,600 × 1,200 pixels
PC size	1,024 × 768 pixels
TV size	640 × 480 pixels

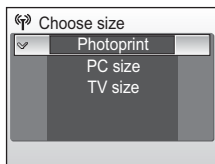

5 Choose recipient e-mail address and press the shutter-release button.

Choose e-mail address and press **OK** to mark.

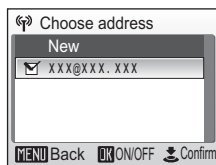

Choose [New] and press **OK** to add recipients. Enter e-mail address correctly in the address screen and press the shutter-release button. For information on how to enter characters, see "Entering Characters on the Camera" (p. 148).

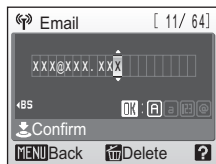

6 Choose [Yes] and press **OK**.

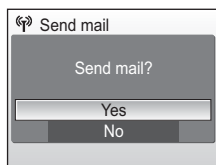

The screens for connecting to the access point and connecting to the wireless LAN will be displayed in order. To cancel transfer, press **OK**.

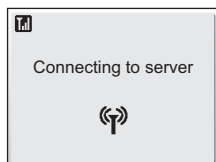
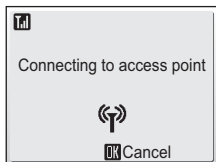

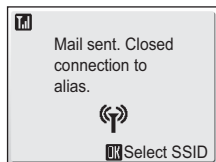

When the transfer is complete, the message shown at right will be displayed.



✓ Entering Characters on the Camera

When using COOLPIX CONNECT service, you can set profiles with the camera, without using the Setup Utility. From the camera you can enter characters for information such as the e-mail address (up to 64) and its (sender) name (up to 16), user ID and password.

- Rotate the rotary multi selector clockwise to enter characters (A to Z) in alphabetical order, or counterclockwise to enter in reverse order.
- Press the rotary multi selector ► to move the cursor right.
- Press the rotary multi selector ◀ to move the cursor left. Press  to delete all the characters entered up to the cursor.
- Press  to change the character type in the following order: uppercase characters → lowercase characters → numbers → symbols → uppercase characters, and so on.
- Press the shutter-release button to apply selection and return to the previous screen.
- Press the zoom control to **T** (🔍) to preview the entered characters. Press **MENU** to return to the previous screen.

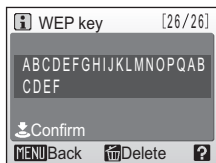
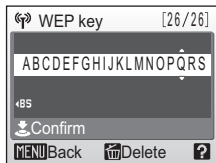

🔍 Editing Recipient's E-mail Address

- Using the Setup Utility to enter or edit e-mail addresses is easier. You can also enter or edit a nickname for an e-mail address using the Setup Utility, making it easier to choose destinations on the camera.
- To edit nicknames and e-mail addresses, connect the computer and camera, turn on the camera, and start the Setup Utility. Then, choose [Edit address book] in the action selection screen, and click [Next].
- Choose [Reset camera] in the action selection screen to clear all address book contents (all profiles are also deleted).

Transferring Pictures to a Computer (PC Connection)

The following transfer method can be selected in step 3 of “Establishing a Wireless Connection” (📷 143):

- Highlight an option and press **OK**. The message “Connecting to (profile name)” will be displayed while the camera connects.
- To exit before a connection is established, press **OK** again.

Function selection menu	Description
Easy Transfer (PM)	Transfer pictures and Pictmotion movies not yet saved in the computer. Pictmotion movies take time to transfer and cannot be transferred from a Macintosh.
Easy Trans. (no PM)	Transfer pictures not yet saved in the computer. Pictmotion movies cannot be transferred.
Shooting date	Transfer all pictures taken on a specific recording date.
Selected Images	Transfer only selected pictures.
Shoot & Transfer	Immediately transfer taken pictures.
Marked images	Transfer pictures with a 📷 (transfer) icon (📷 112).
PC mode	Transfer pictures to a profile device using a computer.

Transferring Pictures Not Yet Saved on a Computer - Easy Transfer

- 1 Use the rotary multi selector to choose [Easy Transfer (PM)] or [Easy Trans. (no PM)] in step 3 of “Establishing a Wireless Connection” (143) and press **OK**.

When multiple computers are set as profiles for the infrastructure network, the profile selection screen is displayed. Choose a profile and press **OK**.

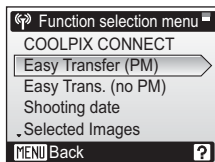

- 2 Transfer pictures.

Pictures not yet saved on the computer will be transferred after the camera and computer are connected.

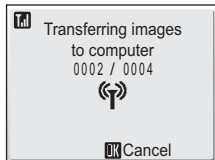
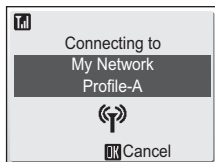

- 3 When transfer is complete, press **OK** to return to the SSID selection menu.

To end wireless transfer mode, see “When Transfer is Complete” (144).

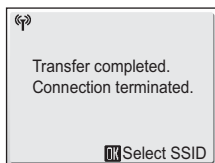

Transferring Pictures Taken on Selected Date - Shooting Date

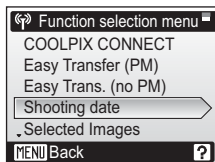

- 1** Use the rotary multi selector to choose [Shooting date] in step 3 of “Establishing a Wireless Connection” (143) and press **OK**.

When multiple computers are set as profiles for the infrastructure network, the profile selection screen is displayed. Choose a profile and press **OK**.



- 2** Select the shooting date.

The shooting date menu will be displayed.

- Select the desired shooting date and press **▶** to apply selection. Multiple shooting dates can be selected.
- The selected shooting date will be marked with the  (wireless transfer) icon. Press **▶** again to cancel the selection (the  icon will disappear).
- Press **OK** to complete selection.

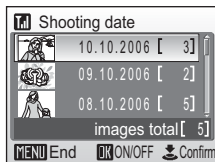

- 3** Transfer pictures taken on the selected dates.

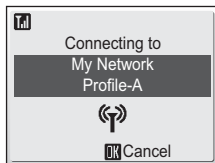

- 4** When transfer is complete, press **OK** to return to the SSID selection menu.

To end wireless transfer mode, see “When Transfer is Complete” (144).

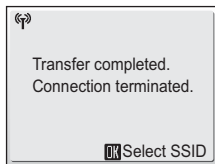

✔ Note on Transferring Pictures with [Shooting Date]

Pictures taken without the date and time set (120, 117) cannot be chosen for transfer with [Shooting date].

Transferring Selected Pictures - Selected Images

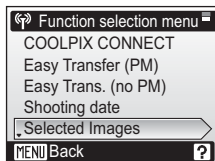

- 1 Use the rotary multi selector to choose [Selected Images] in step 3 of "Establishing a Wireless Connection" (143) and press **OK**.

When multiple computers are set as profiles for the infrastructure network, the profile selection screen is displayed. Choose a profile and press **OK**.



- 2 Select the pictures to transfer.

The selected images menu will be displayed.

- Select the pictures to transfer and press **▲** to apply selection. Multiple pictures can be selected.
- The selected picture will be marked with the  icon. Press **▼** to cancel the selection (the  icon will disappear).
- Press **OK** to complete selection.

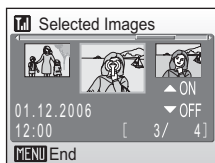

- 3 Transfer the selected pictures.

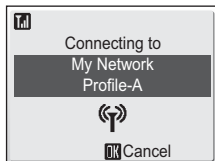

- 4 When transfer is complete, press **OK** to return to the SSID selection menu.

To end wireless transfer mode, see "When Transfer is Complete" (144).

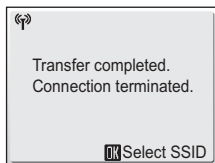

Note on the icon

The  icon displayed in step 2 will disappear once transfer is complete (picture selection is cleared each time transfer is completed).

Immediately Transferring Pictures Taken - Shoot & Transfer

- 1 Use the rotary multi selector to choose [Shoot & Transfer] in step 3 of "Establishing a Wireless Connection" (143) and press **OK**.

When multiple computers are set as profiles for the infrastructure network, the profile selection screen is displayed. Choose a profile and press **OK**.

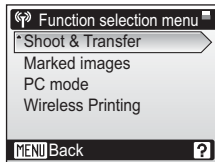

- 2 Enter shooting mode.

The shooting screen will be displayed.

- The camera enters **Auto** mode automatically.
- Press **MENU** in the shooting screen, and the shoot and transfer menu will be displayed.



- 3 Take a picture.

The just-taken picture will be transferred to the computer. The camera returns to shooting mode (screen in step 2) after transfer is complete. Note that pictures cannot be taken while pictures are being transferred.

- If a confirmation dialog is displayed, select [Yes] to transfer the picture. To cancel the transfer, select [No].

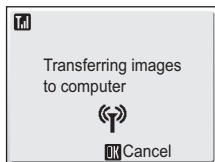





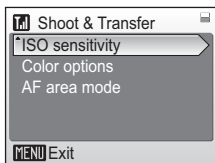
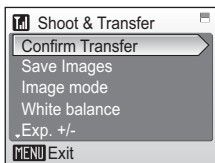

Transferring Pictures

Changing Settings for Shoot and Transfer

Press **MENU** in the shooting screen (for shoot and transfer) and the shoot and transfer menu will be displayed.



Confirm Transfer	Off (default)	Immediately transfers pictures taken to the computer.
	On	Displays a confirmation dialog prompting whether to transfer pictures taken to the computer each time a picture is taken.
Save Images	Off (default)	Saves the picture taken only on the computer and not to the internal memory or on the memory card.
	On	Saves the picture taken to the internal memory or on the memory card.
Image Mode	 97	
White Balance	 99	
Exp. +/-	 101	
ISO Sensitivity	 105	
Color Options	 105	
AF Area Mode	 106	

Saving Pictures

If a communication error occurs while performing [Shoot & Transfer] with [Save Images] set to [Off], pictures taken are not saved. When taking pictures for important occasions, setting [Save Images] to [On] is recommended.

Transferring Pictures Marked with the Transfer Icon - Marked Images

- 1 Use the rotary multi selector to choose [Marked images] in step 3 of "Establishing a Wireless Connection" (☒ 143) and press **OK**.

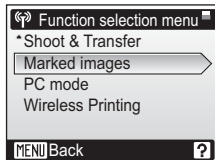

- 2 Transfer pictures.

Pictures marked with the  (transfer) icon (☒ 112) will be transferred.



- 3 When transfer is complete, press **OK** to return to the SSID selection menu.

To end wireless transfer mode, see "When Transfer is Complete" (☒ 144).

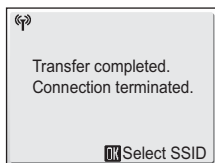

Transferring Pictures Using a Computer - PC Mode

- 1 Use the rotary multi selector to choose [PC mode] in step 3 of “Establishing a Wireless Connection” (143) and press **OK**.

When multiple computers are set as profiles for the infrastructure network, the profile selection screen is displayed. Choose a profile and press **OK**.

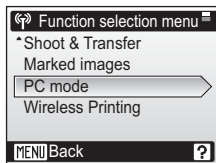

- 2 Connect the camera to a computer.

The camera and computer will be connected.

- When the selected computer has PictureProject installed, it will be launched automatically. To transfer pictures, click the [Transfer] button in PictureProject Transfer. See the *PictureProject Reference Manual* (on CD) for details.
- When the selected computer does not have PictureProject installed, drag and drop pictures from the camera displayed on the computer.
- Pictmotion movies can be transferred (Windows only).

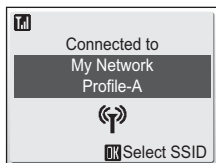

✔ Message Displayed During Transfer

The message shown at right is displayed in the monitor during picture transfer. The antenna icon indicates signal strength (5-levels). The icon changes to red when outside the network area. When signal strength is poor, remove any obstacles between the camera antenna and computer (or access point). To cancel the current transfer, press **OK**.

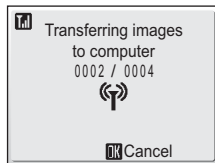

✔ Note on the Camera's **OK** (Antenna) Button

Pictures marked with the  icon cannot be transferred in wireless transfer mode using the camera's **OK** (Antenna) button.

📁 Save Location of Transferred Images

- Pictures transferred to the computer are saved to the following location.
Windows XP: [Wireless Transfer] folder in [My Pictures] folder
Macintosh: [Wireless Transfer] folder in [Picture] folder
- A destination folder can be changed using the Setup Utility. Choose [Select destination folder] in the screen in step 6 ( 137) and choose a destination folder. Connection between the camera and a computer is not necessary for this operation.
- When pictures are transferred wirelessly to a computer that has PictureProject installed, in modes other than [PC mode], PictureProject automatically starts and the transferred pictures will be displayed. Note that the save location can be changed.
- For computers without PictureProject installed, Explorer (for Windows) or Finder (for Macintosh) starts and the save location will be displayed. Note that the save location cannot be changed.
- If the camera is connected to a computer in [PC mode] without PictureProject installed, drag and drop pictures from the camera icon or drive displayed on the computer to the desired save location.

Printing Pictures (Wireless Printing)

After selecting a profile or selecting [Function selection menu] > [Wireless Printing], press **OK**. The wireless printing menu is displayed.

To select multiple pictures and print, perform the same procedures as for direct printing (**90**).

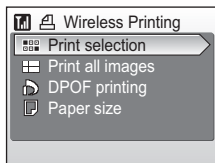

Switching the Printer

When using multiple printers, the printer can be switched by using the Setup Utility. Start the Setup Utility and choose [Select printer] in the action selection screen. Connecting the computer and camera is not necessary for switching the printer.

The PD-10 Wireless Printer Adapter

To print pictures without connecting the printer to a computer, connect the PD-10 wireless printer adapter (available separately) (**133**) to any PictBridge-compatible printer with a type A (flat) USB connector.

When printing pictures via the PD-10 for the first time, display the profile list by following the procedures in “Establishing a Wireless Connection” (**143**), and then follow the steps below:

1. Connect the PD-10 to the printer, turn on the printer and press the START button on the PD-10.
2. Make sure that the LINK lamp on the PD-10 has turned greenish-yellow.
3. Press the camera's **MENU** button. The message “Connecting to wireless printer adapter” will be displayed. Set up profiles on the camera and PD-10 as described in the PD-10 instruction manual, starting from step 3.

Once the profile is stored in the camera, pictures can be printed directly by selecting the PD-10 in the profile list and pressing **OK**.

For more information, consult the PD-10 instruction manual.

Optional Accessories

Rechargeable battery	Nikon EN-EL8 rechargeable lithium-ion battery
Battery charger	MH-62 battery charger
AC adapter	EH-64 AC adapter
Cradle	MV-15 COOL-STATION
ImageLink-compatible printer adapter	PV-11 dock insert
USB cable	UC-E10 USB cable
A/V cable	EG-E5000 audio/video cable
Wireless printer adapter	PD-10 wireless printer adapter

Approved Memory Cards

The following memory cards have been tested and approved for use in the COOLPIX S7c:

SanDisk	64 MB, 128 MB, 256 MB, 512 MB, 1 GB, 256 MB*, 512 MB*, 1 GB*
Toshiba	64 MB, 128 MB, 256 MB, 512 MB, 1 GB, 128 MB*, 256 MB*, 512 MB*
Panasonic	64 MB, 128 MB, 256 MB, 512 MB, 1 GB, 256 MB*, 512 MB*, 1 GB*
Nikon	1GB*



* Cards rated for 10 MB/s (high speed)

Other cards have not been tested. For more details on the memory cards listed above, please contact the manufacturer.

Image File and Folder Names

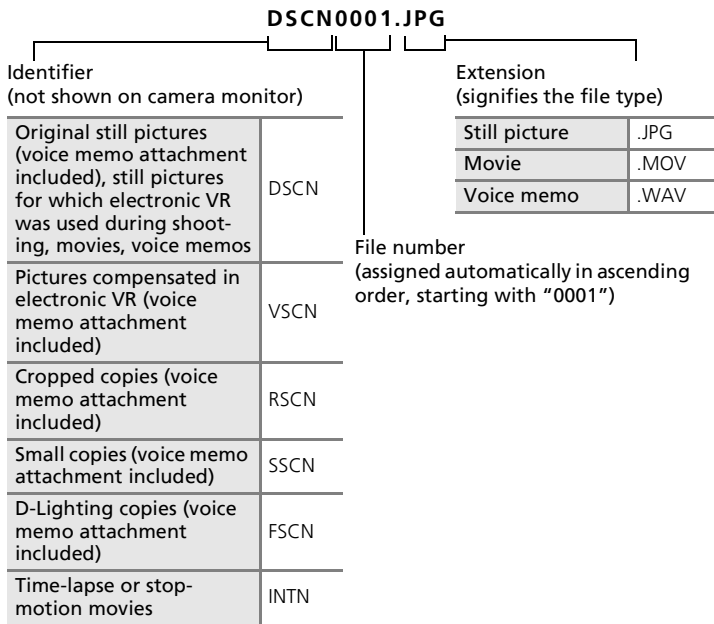
Pictures, movies, and voice memos are assigned file names as follows:



- Files are stored in folders named with a folder number followed by a five-character identifier: "P_" plus a three-digit sequence number for pictures taken using panorama assist (e.g., "101P_001";  47), "INTVL" for interval timer photography (e.g., "101INTVL";  103), "SOUND" or "SOUNE" for voice recordings (e.g., "101SOUND";  77), and "NIKON" for all other pictures (e.g., "100NIKON"). When the number of files within a folder reaches 9999, a new folder will be created. File numbers will be assigned automatically starting with "0001".

- Files copied using [Copy] > [Selected images] or [Copy sound files] > [Selected files] are copied to the current folder, where they are assigned new file numbers in ascending order starting from the largest file number in memory. [Copy] > [All images] and [Copy sound files] > [Selected files] copy all folders from the source medium; file names do not change but new folder numbers are assigned in ascending order starting from the largest folder number on the destination medium (📷 113).
- Pictmotion movies (📷 65) are stored under the “NKSS” folder in folders named with a three-digit folder number followed by “PRJCT” (e.g., “101PRJCT”). Each folder contains the picture and sound files for a single Pictmotion movie.
- Folders can hold up to 200 pictures; if a picture is taken when the current folder contains 200 pictures, a new folder will be created by adding one to the current folder number. If a picture is taken when the current folder is numbered 999 and contains 200 pictures or a picture numbered 9999, no further pictures can be taken until the medium is formatted (📷 125) or a new memory card inserted.
- Files for pictures taken when [Off] is selected for [Shoot & Transfer] (📷 153) > [Save Images] in wireless transfer mode are named with the four-digit identifier “STCN” and four-sequence numbers (e.g., “STCN0001.JPG”).

Caring for the Camera

To ensure continued enjoyment of this Nikon product, observe the following precautions when using or storing the device.

Keep dry

The device will be damaged if immersed in water or subjected to high humidity.

Do not drop

The product may malfunction if subjected to strong shock or vibration.

Handle the lens and all moving parts with care

Do not apply force to the lens, lens cover, monitor, memory card slot, or battery chamber. These parts are easily damaged. Applying force to the lens cover could result in camera malfunction or damage to the lens. Should the monitor break, care should be taken to avoid injury caused by broken glass and to prevent the liquid crystal from the display touching the skin or entering the eyes or mouth.

Do not point the lens at strong light sources for extended periods

Avoid pointing the lens at the sun or other strong light sources for extended periods when using or storing the camera. Intense light may cause deterioration of the CCD image sensor, producing a white blur effect in photographs.

Keep away from strong magnetic fields

Do not use or store this device in the vicinity of equipment that generates strong electromagnetic radiation or magnetic fields. Strong static charges or the magnetic fields produced by equipment such as radio transmitters could interfere with the monitor, damage data stored on the memory card, or affect the product's internal circuitry.

Avoid sudden changes in temperature

Sudden changes in temperature, such as occur when entering or leaving a heated building on a cold day, can cause condensation to form inside the device. To prevent condensation, place the device in a carrying case or a plastic bag before exposing it to sudden changes in temperature.

Turn the product off before removing or disconnecting the power source

Do not remove the battery while the product is on, or while images are being recorded or deleted. Forcibly cutting power in these circumstances could result in loss of data or in damage to product memory or internal circuitry.

The AF-Assist Illuminator LED

The light-emitting diode (LED;  6, 123) used in the AF-assist illuminator conforms to the following IEC standard:



The Battery

- Check the battery level when taking the camera out and charge the battery if necessary ( 18). Do not continue charging once the battery is fully charged, as this will result in reduced battery performance. If possible, carry a fully charged spare battery when taking pictures on important occasions.
- Do not use the battery at ambient temperatures below 0 °C (32 °F) or above 40 °C (104 °F). During charging, the temperature should be in the vicinity of 5 to 35 °C (41 to 95 °F). Note that the battery may become hot during use; wait for the battery to cool before charging. Failure to observe these precautions could damage the battery, impair its performance, or prevent it from charging normally.
- On cold days, the capacity of batteries tends to decrease. Be sure that the battery is fully charged before heading outside to take pictures in cold weather. Keep spare batteries in a warm place and exchange as necessary. Once warmed, a cold battery may recover some of its charge.
- Dirt on the battery terminals can prevent the camera from functioning.
- When the battery is not in use, remove it from the camera or battery charger and replace the terminal cover. The camera and battery charger draw minute amounts of current even when off; if left in place, the battery could be drained to the point that it no longer functions. Turning the camera on or off while the battery is exhausted can result in reduced battery life. If the battery will not be used for an extended period, store it in a cool (15 to 25 °C / 59 to 77 °F), dry place. Recharge it at least once a year and run it flat before returning it to storage.
- Replace the battery when it no longer holds a charge. Used batteries are a valuable resource. Please recycle used batteries in accordance with local regulations.

Cleaning

Lens	Avoid touching glass parts with your fingers. Remove dust or lint with a blower (typically a small device with a rubber bulb attached to one end that is pumped to produce a stream of air out the other end). To remove fingerprints or other stains that cannot be removed with a blower, wipe the lens with a soft cloth, using a spiral motion that starts at the center of the lens and working toward the edges. If this fails, clean the lens using a cloth lightly dampened with commercial lens cleaner.
Monitor	Remove dust or lint with a blower. To remove fingerprints and other stains, clean the monitor with a soft, dry cloth, being careful not to apply pressure.
Body	Use a blower to remove dust, dirt, or sand then wipe gently with a soft, dry cloth. After using the camera at the beach or seaside, wipe off any sand or salt with a dry cloth lightly dampened with fresh water, then dry thoroughly. Note that foreign matter inside the camera could cause damage not covered by the warranty.

Do not use alcohol, thinner, or other volatile chemicals.

Storage

Turn the camera off when not in use. Check that the power-on lamp is off before putting the camera away. Remove the battery if the camera will not be used for an extended period. Do not store the camera with naphtha or camphor moth balls or in locations that:

- are next to equipment that produces strong electromagnetic fields, such as televisions or radios
- are exposed to temperatures below -10°C (14°F) or above 50°C (122°F)
- are poorly ventilated or subject to humidities of over 60%











To prevent mold or mildew, take the camera out of storage at least once a month. Turn the camera on and release the shutter a few times before putting the camera away again.

Notes on the Monitor









- The monitor may contain a few pixels that are always lit or that do not light. This is a characteristic common to all TFT LCD displays, and does not indicate a malfunction. Images recorded using the product will not be affected.
- When framing bright subjects, vertical comet-like streaks that whiten toward either end may appear in the display. This phenomenon, known as “smear,” does not appear in the final photograph and does not indicate a malfunction. Some smear may appear in movies.
- Images in the monitor may be difficult to see under bright lighting.
- The monitor is lit by an LED backlight. Should the monitor begin to dim or flicker, contact your Nikon service representative.







Error Messages

The following table lists the error messages and other warnings displayed in the monitor, as well as the solutions for dealing with them.







Display	Problem	Solution	
 (blinks)	Clock not set.	Set clock.	117
	Battery running low.	Prepare to charge or change battery.	14
Warning! Battery exhausted 	Battery exhausted.	Charge or change battery.	14
 ● (● blinks red)	Camera cannot focus.	<ul style="list-style-type: none"> • Refocus. • Use focus lock. 	28, 29, 106
Warning!! please wait for the camera to finish recording 	Camera cannot perform other operations until recording is complete.	Message clears from display automatically when recording is complete.	–
Memory card is write protected. 	Write-protect switch is in “lock” position.	Slide write-protect to “write” position.	23
No card present	Pictmotion mode selected when no memory card is inserted.	Insert memory card.	22
This card cannot be used 	Error accessing memory card.	<ul style="list-style-type: none"> • Use approved card. • Check that connectors are clean. • Confirm that memory card is correctly inserted. 	159
Warning! This card cannot be read 			22
Card is not formatted  Format No	Memory card has not been formatted for use in camera.	Choose [Format] and press  to format card, or turn camera off and replace card.	23

Error Messages

Display	Problem	Solution	
Out of memory  or 	Memory card is full.	<ul style="list-style-type: none"> • Choose smaller image size. • Delete pictures or sound files. • Insert new memory card. • Remove memory card and use internal memory. 	97 23, 76, 80 22 23
Image cannot be saved  or 	Error occurred while recording picture.	Format internal memory or memory card.	125
	Camera has run out of file numbers.	<ul style="list-style-type: none"> • Insert new memory card. • Format internal memory or memory card. 	22 125
	Cannot edit selected picture.	Select picture that supports crop D-Lighting or small picture.	54
	Picture cannot be used for welcome screen.	Choose picture 640 × 480 pixels or larger.	–
	Cannot copy picture.	Delete pictures from destination.	111
Sound file cannot be saved  or 	Camera has run out of file numbers.	Select [Reset all] after either inserting new memory card or formatting internal memory or memory card.	22, 125, 127
Image has already been modified. D-Lighting cannot be used. 	Image cannot be enhanced using D-Lighting.	Copies from D-Lighting, crop, or small picture option cannot be adjusted using D-Lighting.	56
Cannot record movie.	Time out error while recording movie.	Choose memory card with faster write speed.	159
Memory contains no images 	No pictures available for playback.	–	–
No sound file.	No sound file available for playback.	–	–

Display	Problem	Solution	
File contains no image data 	File not created with COOLPIX S7c.	View file on computer or other device.	–
This file cannot be played back.			
All images are hidden	Date and time are not set for pictures to be displayed by calendar mode or list-by-date mode.	–	–
Pictmotion cannot be created.	Error occurred when creating Pictmotion movie.	Start creating Pictmotion movie from the beginning.	65
Pictmotion cannot be played back.	Pictmotion files have been deleted or moved.	Delete affected Pictmotion movie.	67
This image cannot be deleted 	Picture is protected.	Disable protection.	111
New city is in the current time zone 	Destination in same time zone as home.	–	119
Initializing lens. Cannot focus. 	Camera cannot focus.	Wait until message has cleared from display and camera has zoomed all the way out.	–
Lens error 	Lens error.	Turn camera off and then on again. If error persists, contact retailer or Nikon representative.	24
Lens cover error	Finger or other obstruction prevents lens cover from opening.	Turn camera off and remove obstruction.	4, 162
Cannot reduce blur.	Image cannot be enhanced by vibration reduction.	<ul style="list-style-type: none"> • Picture is considerably blurred • Shutter speed too slow • Picture was taken with a different camera, with Multi-shot 16, or with date imprint • Picture was taken immediately after the camera was turned on or reactivated from standby mode 	57

Error Messages

Display	Problem	Solution	
This image has been retouched. Cannot retouch to reduce blur.	Image cannot be compensated using vibration reduction.	Copies from small picture, crop, or vibration reduction option cannot be adjusted using vibration reduction.	57
Communications error 	USB cable disconnected during transfer or printing.	If PictureProject displays error, click [OK] to exit. Resume operation after turning camera off and reconnecting cable.	83, 88
	[USB] option incorrect.	Choose correct [USB] option.	83, 84
	PictureProject did not start.	–	–
No images are marked for transfer 	No pictures selected for transfer.	Select pictures for transfer in the playback menu and try again.	86, 112
Transfer error 	Transfer error.	<ul style="list-style-type: none"> • Check battery level. • Check that USB cable is connected. 	24 83
System error 	Error has occurred in camera's internal circuitry.	Turn camera off, remove and reinsert battery, and turn camera on. If error persists, contact retailer or Nikon representative.	17, 24
Printer error check printer status 	Running out of ink or printer error.	Check printer. After checking the ink or solving the problem, select [Resume] and press  to resume printing. (Depending on the error, [Resume] may not be available.)	–

Wireless Transfer Mode

Display	Problem	Solution	
Transfer error	Error during image transfer.	Check signal strength. Move the camera closer to the profile device or remove obstruction between the camera and device.	–
Profile not registered. Set up profile.	No profile devices are configured for wireless transfer.	Configure profile devices using Wireless Camera Setup Utility or PD-10 wireless printer adapter.	134, 158
Battery exhausted. Transfer terminated.	Battery ran out during image transfer.	Recharge battery, turn camera on again and set it to wireless transfer mode.	18
Failed to connect to (SSID/profile device)	Selected profile cannot be used.	<ul style="list-style-type: none"> • IP address saved in the camera may be incorrect. Confirm settings using Wireless Camera Setup Utility. • Change firewall settings. 	134, 158

Error Messages

Display	Problem	Solution	
Connection error.	Wireless connection to the profile was terminated.	Check signal strength. Move the camera closer to the profile device or remove obstruction between the camera and device.	–
User information incorrect	Camera is not certified to connect to the wireless network.	Start Wireless Camera Setup Utility, connect camera and computer, and reconfigure to connect to the network.	134
Mailbox is full	The online album is full.	Delete unnecessary pictures.	–
Service not available	Cannot use COOLPIX CONNECT network service.	Start Wireless Camera Setup Utility, connect camera and computer, and reconfigure to connect to the network.	134





Troubleshooting

If the camera fails to function as expected, check the list of common problems below before consulting your retailer or Nikon representative. Refer to the page numbers in the right-most column for more information.

Display, Settings and Power Supply

Problem	Cause/Solution	
Monitor is blank	<ul style="list-style-type: none">• Camera is off.• Battery is exhausted.• Standby mode for saving power: press the shutter-release button halfway.• Flash lamp blinks red: wait until flash has charged.• USB cable is connected.• A/V cable is connected.• Time lapse or interval timer photography in progress.	24 24 25, 28 33 83 82
Monitor is hard to read	<ul style="list-style-type: none">• Adjust monitor brightness.• Monitor is dirty. Clean monitor.• Monitor has dimmed to save power. Monitor brightens when controls are used.	120 164 25
Camera turns off without warning	<ul style="list-style-type: none">• Battery is low.• Camera has turned off automatically to save power.• Battery is cold.	24 163
[Format memory] > [Format] option not available	Battery is low.	24, 125
Camera clock is not correct	<ul style="list-style-type: none">• Clock battery exhausted: recharge clock battery. Pictures recorded before clock has been set will have time stamp of "00.00.0000 00:00"; movies will be dated "01.09.2006 00:00."• Check camera clock regularly against more accurate timepieces and reset as required.	20 117
No indicators displayed in monitor	[Hide info] is selected for [Photo info]. Select [Show info].	120
[Date imprint] not available	Camera clock has not been set.	20, 117



Troubleshooting





Problem	Cause/Solution	
Date not appearing on pictures even when [Date imprint] is enabled	Date does not appear on movies or on pictures taken using  ,  ,  , [Continuous], or when option other than [Off] is selected for [BSS].	41, 45, 47, 70, 102, 104
Camera settings reset	Backup battery is exhausted; all settings were restored to their default values.	118

Electronically Controlled Cameras







In extremely rare instances, unusual characters may appear in the monitor and the camera may stop functioning. In most cases, this phenomenon is caused by a strong external static charge. Turn the camera off, remove and replace the battery, and then turn the camera on again. In the event of continued malfunction, contact your retailer or Nikon representative. Note that disconnecting the power source as described above may result in the loss of any data not recorded to internal memory or the memory card at the time the problem occurred. Data already recorded will not be affected.

Shooting

Problem	Cause/Solution	
No picture taken when shutter-release button is pressed	• Camera is in playback mode: press   .	30
	• Menus are displayed: press MENU .	11
	• Battery is exhausted.	24
	• Flash lamp blinks: flash is charging.	33
Camera cannot focus	• Subject is low in contrast, dominated by repeating geometric patterns, covers too small an area of the frame, or contains many fine details, objects of sharply differing brightness, or objects at different distances from the camera. Use focus lock to focus on another subject at same distance.	29
	• Focus error. Turn camera off and then on again.	24



Problem	Cause/Solution	
Pictures are blurred	<ul style="list-style-type: none"> • Use flash. • Use anti-shake mode. • Use BSS. • Use tripod and self-timer. 	32 49 104 34
Bright specks appear in pictures taken with flash	Flash is reflecting off particles in air. Turn flash off.	33
Flash does not fire	Flash is off. Note that flash turns off automatically in  modes other than [Time-lapse movie ] and [Stop-motion movie], some scene modes, when [Continuous] or [Multi-shot 16] is selected for [Continuous], or when option other than [Off] is selected for [BSS].	32, 37, 70, 102, 104
Optical zoom cannot be used	Optical zoom cannot be used while recording movies.	70
Digital zoom cannot be used	Digital zoom is not available in assist modes, or when [Multi-shot 16] is selected for [Continuous].	37, 102
[Image mode] not available	[Image mode] cannot be adjusted when [Multi-shot 16] is selected for [Continuous].	102
No sound when shutter is released	<ul style="list-style-type: none"> • [Off] is selected for [Sound settings] > [Shutter sound] in setup menu. •  or  mode is selected, option other than [Single] is selected for [Continuous], or option other than [Off] is selected for [BSS]. 	123 41, 70, 102, 104
AF-assist illuminator does not light	<ul style="list-style-type: none"> • [Off] is selected for AF assist option in camera setup menu. • AF-assist illuminator turns off automatically in some modes. 	123 37
Pictures appear smeared	Lens is dirty. Clean lens.	164
Colors are unnatural	White balance does not match light source.	99
Randomly spaced bright pixels ("noise") appear in image	Shutter speed too slow. Noise can be reduced by: <ul style="list-style-type: none"> • Using flash • Fixing the sensitivity • Choosing scene mode with noise reduction 	32 105 39-47

Troubleshooting



Problem	Cause/Solution	
Pictures are too dark (underexposed)	<ul style="list-style-type: none"> Flash is off. Flash window is blocked. Subject is beyond flash range. Adjust exposure compensation. Subject is backlit. Select  ([Back light] scene mode) or use fill flash. 	32 26 32 101 32, 46
Pictures are too bright (overexposed)	Adjust exposure compensation.	101
Unexpected results when flash set to  (auto with red-eye reduction)	In-Camera Red-Eye Fix may, in very rare cases, be applied to areas not affected by red-eye. Set flash to  (auto) or  (fill-flash) and try again. Note that red-eye reduction is the default setting for one-touch portrait,  , and  modes.	32, 39, 42, 50

Playback

Problem	Cause/Solution	
File cannot be played back	<ul style="list-style-type: none"> File has been overwritten or renamed by computer or other make of camera. Time lapse or interval timer photography in progress: pictures cannot be played back until recording is complete. 	–
Cannot zoom in on picture	Playback zoom cannot be used with movies, small pictures, or pictures that have been cropped to below 320 × 240.	–
Cannot record voice memo	Voice memos cannot be appended to movies.	76
Cannot use crop, D-Lighting, or small picture options	These options cannot be used with movies and may not be available with pictures created with other cameras. Select picture that supports crop, D-Lighting, or small picture.	76, 54
Cannot create new Pictmotion movie	Camera may be unable to create Pictmotion movies using pictures recorded with other cameras. Other cameras may be unable to play Pictmotion movies created with COOLPIX S7c.	–

Problem	Cause/Solution	8
Custom Pictmotion background music tracks are not listed	Memory card contains no background tracks. If background tracks were deleted when memory card was formatted, copy tracks to card again.	68
Pictures not displayed on television	<ul style="list-style-type: none"> • Choose correct video mode. • A/V cable and USB cable are both connected to the COOL-STATION: disconnect USB cable. 	126 –
PictureProject does not start when camera is connected	<ul style="list-style-type: none"> • Camera is off. • Battery is exhausted. • USB cable is not correctly connected. • Appropriate [USB] option is not selected. • Camera is not recognized by the computer. • Computer is not set to launch PictureProject automatically. <p>See the supplied <i>PictureProject Reference Manual</i> (on CD) (silver) for more information on PictureProject.</p>	24 24 83 84 – –
Cannot mark pictures for transfer	No more than 1,000 pictures can be marked for transfer. Use the [Transfer] button in PictureProject to transfer pictures.	85
Transfer marking does not appear	Pictures were marked for transfer using another model of camera. Mark pictures for transfer using COOLPIX S7c.	86, 112
Cannot transfer pictures	 cannot be used to transfer pictures from internal memory when [Mass storage] is selected for [USB] or if memory card is locked. Transfer pictures using the [Transfer] button in PictureProject.	23, 126
Cannot transfer Pictmotion movies	<ul style="list-style-type: none"> • Pictmotion movies cannot be transferred to Mac OS. •  cannot be used to transfer Pictmotion movies. Use the [Transfer] button in PictureProject. 	– –

Wireless Transfer

Problem	Cause/Solution	
The camera is not detected by the Wireless Camera Setup Utility.	<ul style="list-style-type: none"> • Set the camera to  (auto) mode. • Select [PTP] for [Interface] > [USB] in the setup menu. 	24, 126
SSID is not displayed.	<ul style="list-style-type: none"> • Configure a profile device. • SSID is set to hide. • Signal strength is poor. • Move the camera closer to the access point or computer. • Remove obstruction between the camera and profile device. • Adjust the direction of the camera so it can receive a better signal. 	134
Connection to the access point or server failed.	<ul style="list-style-type: none"> • A profile for home wireless LAN is set in the procedure for public wireless LAN. • Connect the computer and camera and start the Wireless Camera Setup Utility. Then choose the action [Rename/Delete profiles], choose the profile from the list, and click [View Profile] to confirm the information. 	142
Wireless transfer was terminated during image transfer, and transfer failed.	<ul style="list-style-type: none"> • Turn the camera off and on again, and try again. • Battery is running out. 	17, 18
Pictmotion movies were not wirelessly transferred.	<ul style="list-style-type: none"> • [Easy Trans. (no PM)] is selected in wireless transfer menu. • Pictmotion movies cannot be transferred from a Macintosh. 	150

Supported Standards

- **DCF:** Design Rule for Camera File System is a standard widely used in the digital camera industry to ensure compatibility among different makes of camera.
- **DPOF:** Digital Print Order Format is an industry-wide standard that allows pictures to be printed from print orders stored on the memory card.
- **Exif version 2.2:** This camera supports Exif (Exchangeable Image File Format for Digital Still Cameras) version 2.2, a standard that allows information stored with photographs to be used for optimal color reproduction when images are output from Exif-compliant printers.
- **PictBridge:** A standard developed cooperatively by the digital camera and printer industries, allowing photographs to be output directly to a printer without connecting the camera to a computer.
- **ImageLink:** The ImageLink standard allows pictures taken with a digital camera to be printed directly on a household printer, without using a computer. The camera can be connected directly to any ImageLink-compatible printer for one-touch picture printing.

Specifications

Nikon COOLPIX S7c Digital Camera

Type	Compact digital camera
Effective pixels	7.1 million
CCD	$1/2.5$ -in. CCD; total pixels: 7.41 million
Image size (pixels)	<ul style="list-style-type: none">• 3,072 × 2,304 [High(3072★)/Normal(3072)]• 2,592 × 1,944 [Normal(2592)]• 2,048 × 1,536 [Normal(2048)]• 1,024 × 768 [PC screen(1024)]• 640 × 480 [TV screen(640)]
Lens	3× Zoom-Nikkor ED lens
Focal length	F=5.8–17.4 mm (35-mm [135] camera-format equivalent: 35–105mm)
f/-number	F2.8–F5.0
Construction	12 elements in 10 groups
Digital zoom	Up to 4× (35-mm [135] camera-format equivalent: 420 mm)
Autofocus (AF)	Contrast-detect AF
Focus range (from lens)	<ul style="list-style-type: none">• 30 cm (1 ft.)–∞• Macro close-up mode: 4 cm (1.6 in.)–∞ (wide zoom position)
Focus-area selection	Center, manual (99 focus area)
AF-assist illumination	Class 1 LED product (IEC 60825-1 Edition 1.2 ²⁰⁰¹); max. output: 1,600 μW
Vibration reduction	Electronic
Monitor	3.0 in., 230,000-dot, wide viewing-angle low-temperature polysilicon TFT LCD with 5-level brightness adjustment
Frame coverage (shooting mode)	Approximately 97% horizontal and 97% vertical
Frame coverage (playback mode)	Approximately 100% horizontal and 100% vertical
Storage	
Media	Internal memory (14 MB); Secure Digital (SD) memory cards
File system	DCF, Exif 2.2, and DPOF compliant
File formats	Compressed: JPEG-baseline-compliant Movies: QuickTime Audio files: WAV

Exposure	
Metering	256-segment matrix, center-weighted, spot, spot AF area
Exposure control	Programmed auto exposure with exposure compensation (-2.0 to +2.0 EV in steps of $\frac{1}{3}$ EV)
Range	W: 0.0 to +15.9 EV T: +1.6 to +17.6 EV
Shutter	Mechanical and charge-coupled electronic shutter
Speed	2– $\frac{1}{500}$ s
Aperture	Electronically controlled ND filter selection
Range	2 steps (f/2.8 and f/7.9 [W])
ISO sensitivity	ISO 50, 100, 200, 400, 800, 1600, Auto (auto gain to ISO 50–800 equivalent)
Self-timer	10 seconds, 3 seconds
Built-in flash	
Range	W: 0.3–7.5 m / 12 in.–24 ft. 6 in. T: 0.3–4.0 m / 12 in.–13 ft.
Flash control	Sensor flash system
Interface	USB
Video output	Can be selected from NTSC and PAL
I/O terminals	Multi connector (supports ImageLink)
Wireless	
Standards	IEEE 802.11b/g (standard wireless LAN protocol), ARIB STD-T66 (standard for low power data communications systems)
Communications protocols	IEEE 802.11g: OFDM IEEE 802.11b: DBPSK, DQPSK, CCK
Range (line of sight)	Approximately 20 m/67 ft. (varies with location)
Operating frequency	2412–2462 MHz (11 channels)
Data rates*	IEEE 802.11g: 6, 9, 12, 18, 24, 36, 48, and 54 Mbps IEEE 802.11b: 1, 2, 5.5, and 11 Mbps
Security	TKIP, 128/64-bit (104/40-bit) WEP
Access protocols	Infrastructure/ad-hoc
Supported languages	Czech, Danish, German, English, Spanish, French, Indonesian, Italian, Dutch, Norwegian, Polish, Portuguese, Russian, Finnish, Swedish, Chinese (Simplified and Traditional), Japanese, Korean, Thai
Power sources	<ul style="list-style-type: none"> • One rechargeable Nikon EN-EL8 lithium-ion battery (supplied) • EH-64 AC adapter (supplied)

Specifications

Charging time	Approximately 2 hours
Battery life	Approximately 200 shots (EN-EL8)*
Dimensions	100.5 × 60 × 21 mm/3.9 × 2.4 × 0.8 in. (W × H × D, excluding projections)
Weight	140 g (4.9 oz) without battery or memory card
Operating environment	
Temperature	0 to +40 °C (+32 to 104 °F)
Humidity	Less than 85% (no condensation)

* Based on Camera and Imaging Products Association (CIPA) standards for measuring the life of camera batteries. Measured at 25 °C (77 °F); zoom adjusted with each shot, flash fired with every other shot, image mode set to Normal. Number of shots may differ depending on conditions such as the interval between shots, menu display time or image playback time.

- Unless otherwise stated, all figures are for a camera with fully-charged EN-EL8 battery operated at an ambient temperature of 25 °C (77 °F).

MV-15 COOL-STATION

Interface	USB
I/O terminals	DC in, digital terminal (USB), audio-video out, camera connector
Operating temperature	0–40 °C (32–104 °F)
Approximate dimensions	111.5 × 28 × 50.5 mm/4.4 × 1.1 × 2.0 in. (W × H × D, excluding projections)
Approximate weight	52 g (1.8 oz)

PV-11 Dock Insert

Approximate dimensions	135.5 × 22.5 × 63 mm/5.3 × 0.9 × 2.5 in. (W × H × D, excluding projections)
Approximate weight	32 g (1.1 oz)

EH-64 AC Adapter

Rated input	100–240 V AC, 50/60 Hz, 0.18–0.1 A
Rated capacity	18–22 VA
Rated output	DC 4.8 V/1.5 A
Operating temperature	0–40 °C (32–104 °F)
Approximate dimensions	41 × 23.5 × 79 mm /1.6 × 0.9 × 3.1 in. (W × H × D, excluding projections)
Length of cord	Approximately 1.7 m (5 ft. 7 in.)
Approximate weight	110 g (3.9 oz), excluding power cable

EN-EL8 Rechargeable Li-ion Battery

























Type	Rechargeable lithium-ion battery
Rated capacity	3.7 V/730 mAh
Operating temperature	0–40 °C (32–104 °F)
Approximate dimensions	35 × 47 × 5 mm/1.4 × 1.9 × 0.2 in. (W × H × D, excluding projections)
Approximate weight	17 g (0.6 oz), excluding terminal cover

✓ Specifications

Nikon will not be held liable for any errors this manual may contain. The appearance of this product and its specifications are subject to change without notice.

Index

Symbols



-  Anti-shake mode 49
-  Anti-shake mode/electronic vibration mode 7, 49, 57
-  Apply selection button 7
-  Auto mode 24–31
-  Calendar mode 60
-  Delete button 11, 30, 53
-  D-Lighting button 6, 56
-  Help 13
-  High-sensitivity shooting mode 36
-  List-by-date mode 61
- MENU** Menu button 11
- m** Mode button 7, 10
-  Movie mode 10, 11, 70, 71
-  One-touch portrait button 6, 50
-  Pictmotion mode 65
-  Playback mode 10, 11, 31
-  Playback zoom 53, 55
-  Scene mode 11, 37–42
-  Shooting/playback button 11, 30, 55
-  Thumbnail playback 52, 55
-  Transfer button 83, 85, 112
-  Voice playback mode 79
-  Voice recording mode 10, 77, 115
-  Wait icon 165
-  Wireless transfer mode 130
-  Zoom control 6, 26, 35, 76, 79, 89

A



- A/V cable 82
- A/V-out connect 82
- AC adapter 15
- Accessories 159
- Ad-hoc mode 131
- AE-L 48
- AF area mode 106
- AF assist 123
- Anti-shake mode 49

- Assist modes 37, 38–42
- Auto off 124
- Auto transfer 126
- Auto-focus mode 75

B

- Back light () 46
- Backlit subjects 32, 46
- Battery 16
- Battery level indicator 165
- Battery-chamber/memory card slot cover 7
- Beach/snow () 44
- Best shot selector 45, 104
- Blur 173
- Brightness 120
- BSS 107

C

- Cable connector 85, 88
- Cleaning
 - Body 164
 - Lens 164
 - Monitor 164
- Close up () 45
- Close-up 35, 45
- Color options 105, 107
- Computer 82–86, 126
 - copying pictures to 82–85
- Confirm Transfer 154
- Continuous 102, 107
- COOLPIX CONNECT 130, 145
- COOL-STATION 14
- Copy 113
- Copy () 46
- Crop 55
- Cyanotype 105

D

- Date 20–21, 117, 121
 - printing 94
- Date counter 122

Date imprint 121
Daylight saving time 117
DCF 177
DC-IN connector 14
Delete 111
Design rule for Camera File System 177
Digital Print Order Format 93–94, 177
D-Lighting 56
Dock insert 95
DPOF 177
DSCN 160
Dusk/dawn (🌄) 44

E

Easy Transfer 150
Electronic VR 57, 75, 106
E-mail 97
Entering characters 148
Error messages 165–168
Exif version 2.2 177
Exposure compensation 101
Extension 160

F

Face-priority AF 51
File names 160
Fill flash 32
Fireworks show (🎆) 46
Firmware version 129
Flash 32, 127
 lamp 7, 33
 mode 32
Flash mode 107
Focus 8, 28
 area 8, 28
 face-priority 50
Folder names 160
Format 23, 125
Framing 26
 assist 37–42
 guides 38–42
FSCN 160

Function selection menu 143

H

High-sensitivity shooting mode 36
Home wireless LAN 131

I

Image mode 37, 97
ImageLink-compatible printer 95
Infrastructure mode 131
Interface 82–88, 126
Internal memory 8–9, 22, 98, 125
 capacity 98
 formatting 125
ISO sensitivity 105

J

JPEG 178
JPG 160

L

Landscape (🌄) 40
Language 20, 126
Lens 6, 164

M

Macro close-up 35
Marked images 155
Memory card 8–9, 22, 98, 159
 approved 159
 capacity of 98
 formatting 125
 Inserting and removing 22
 slot 22
Menus 115
Monitor 7, 8–9, 24, 120, 164
 brightness 120
 indicators in 8–9
Monitor settings 120
MOV 160
Movie menu 71
Movie mode 70
Movie options 72
 maximum movie length 72

- Pictmotion 72
 - small size 72
 - smaller size 72
- Stop-motion movie 72
- Time-lapse movie 72
- TV movie 72

- Movies 70, 76
 - deleting 76
 - playback 76
 - recording 70

- Multi connector 7

- Museum (🏛️) 45

N

- Night landscape (🌃) 45

- Night portrait (👤) 37

O

- One-touch portrait mode 50
 - menu 51
 - taking pictures 50

P

- Panorama 47–48

- Panorama assist (👤) 47

- Party/indoor (🎉) 44

- PC mode 156

- PictBridge 87–93, 177

- Pictmotion by muvee 65

- Playback 30, 52–58

 - menu 108–113

 - thumbnail 52

 - zoom 53

- Playback menu 108–113

- Portrait (👤) 39

- Power switch 6

- Power-on lamp 6, 24

- Print set 93, 108

- Print size 98

- Protect 111

Q

- Quick startup 116

R

- Record orientation 124

- Red-eye reduction 33

- Reset all 127

- Rotary multi selector 7, 12

- Rotate image 112

- RSCN 160

S

- Save Images 154

- Scene modes 37

- Selected Image 152

- Self timer 34, 107

- Self-timer lamp 6, 34

- Setup menu 114–129

- Shoot & Transfer 153

- Shooting date 151

- Shooting menu 96–105

- Shutter-release button 6

- Slide show 110

- Small picture 58

- Smear 164

- Sound settings 123

- Sports (🏃) 41

- SSCN 160

- SSID 132, 141, 143

- Strap, Camera 6

- Sunset (🌇) 44

- Support information 2

T

- Television 82

 - connecting to 82

- Thumbnail playback 52

- Time zone 20–21, 117, 119

- Transfer 85

 - mark 86, 112, 126

- Transfer marking 112

 - pictures for 112, 126

- Tripod 7

U

- USB 126
 - cable 85, 88
 - connection 83–84, 126

V

- Video mode 126
- Voice Memos 59
- Voice recordings
 - Copying 81
 - making 77
 - menu 78
 - Playing 79

W

- WAV 160
- Welcome screen 114
- White balance 99, 107
 - preset 100
- Wireless Camera Setup Utility 131
- Wireless LED 6
- Wireless Printer Adapter PD-10 158
- Wireless Printing 158
- Wireless transfer mode 130

Z

- Zoom 26
 - control 6
 - indicator 8
 - playback 53

Nikon

No reproduction in any form of this manual, in whole or in part (except for brief quotation in critical articles or reviews), may be made without written authorization from NIKON CORPORATION.

NIKON CORPORATION
Fuji Bldg., 2-3 Marunouchi 3-chome,
Chiyoda-ku, Tokyo 100-8331, Japan

Printed in Japan
TR6H03(11)
6MA22311--