

The **Nikon** Guide to Digital Photography
with the
COOLPIX880
DIGITAL CAMERA



Product Documentation

The documentation for this product includes the manuals listed below. Please be sure to read all instructions thoroughly to get the most from your camera.

Fast Track Guide/For Your Safety

In addition to taking first-time users step-by-step through the process of setting up and using the camera, the *Fast Track Guide* provides a quick overview of camera settings. *For Your Safety*, printed on the reverse of the *Fast Track Guide*, lists warnings and cautions that should be observed when using and storing your camera, together with legal information. Please keep this document where all those who use the product will read it.

Menu Guide

This reference is your guide to camera menus. Keep it handy when you use the camera.

Guide to Digital Photography (this manual)

This manual provides complete operating instructions for your camera.

Contents

Overview:About This Manual	1
----------------------------------	---

Tutorial

3

Getting to Know the COOLPIX 880:The Parts of the Camera and Their Functions	4
Using the Camera Menus	12

First Steps:

Getting Ready to Use Your Camera	15
Inserting the Battery	15
Inserting the Memory Card	18
Choosing a Language	20
Setting the Time and Date	21

Taking Photographs:The Basics

23

Getting the Camera Ready for Use (AUTO Mode)	23
Framing Photographs	26
Focus and Shoot	28
Assisted Creative Photography: Scene Mode .	32
Review and Deletion: Quick Review	39
Putting the Camera Away	44

Where Do I Go from Here? **45**

Getting the Most from Digital Images:Your Camera and Your Computer	46
Viewing Photos on TV	48
Ordering Prints: Digital Print Order Format (DPOF)	48
Taking Photographs for E-Mail and the Web ...	49
Taking Photographs for Printing	50

Reference

51

Beyond Point and Shoot:

Shooting Controls for All Modes	52
Framing Photographs: Optical and Digital Zoom	52
Throwing Light on Your Subject: The Flash Button	55
Focusing Near and Far: The Focus-Mode Button	58
Delaying Shutter Release: Self-Timer Mode	62
Bright, Dark, and High-Contrast Subjects: Exposure Compensation	64
Choosing a Focus Area: Manual Focus-Area Selection	66

Advanced Photography: P,A, M, and CSM	68	Playing Images Back: Playback Mode	111
Choosing a Mode: P,A, M, or CSM?	69	Basic Playback	112
Adjusting Exposure: A and M Modes	70	Single-Image Playback	113
Reacting Faster to Light: Sensitivity (ISO Equivalency)	74	Viewing Multiple Images: Thumbnail Playback	118
Focusing at a Preset Distance: Manual Focus ..	76	Deleting Individual Photographs	119
The Shooting Menu	78	The Playback Menu	120
Keeping Colors True: The White-Balance Menu	81	Deleting Photographs: The Delete Menu ...	122
Measuring Light: The Metering Menu	85	Selecting a Folder for Playback: The Folders Menu	126
Making Movies and Taking Photographs in a Sequence: The Continuous Menu	88	Automated Playback: The Slide-Show Menu	127
Getting Sharper Photographs: The BSS Menu	92	Safeguarding Valuable Images: The Protect Menu	130
Contrast, Brightness, and Image Type: The Image Adjustment Menu	94	Hiding Images During Playback: The Hide-Image Menu	131
Making Edges More Distinct: The Image Sharpening Menu	96	Preparing Photographs for Printing: The Print-Set Menu	132
Modifying Sensitivity from a Menu: The ISO Menu	98		
Exposure Options	98		
Focus Options	103		
Settings for Optional Lens Converters	106		
Restoring Default Shooting Settings: The Reset Menus	109		

Camera Setup: The Setup Menu	134	Connections: Connecting Your Camera to a Computer, TV, or VCR	162
Controlling the (File) Size of Photographs:		Connecting to a Television or VCR	162
Image Quality and Size	137	Connecting to a Computer	164
Organizing Your Photographs:		Using Nikon View Software	164
The Folders Menu	142	Connecting Your Camera to a Computer	166
Monitor Options	149	Reading Photographs from Memory Cards	168
The Auto Off Menu	151		
File Numbering: The Seq. Numbers Menu ...	153	Technical Notes	170
Formatting Memory Cards:		Caring for Your Camera	170
CF Card Format	154	Optional Accessories	172
Storing Camera Settings:		Troubleshooting	174
The Controls Menu	155	Specifications	181
Shutter Release Confirmation and Photo Information	156		
The Date Menu	158		
The Video Mode Menu	158		
The Language Menu	159		
The Distance Units Menu	159		
Restoring Default Settings:			
The Reset All Menu	160		

Thank you for your purchase of a COOLPIX 880 digital camera. This manual has been written to help you enjoy taking digital photographs with your COOLPIX 880. As you read through it, you will find explanations not only of how the camera works but also of why certain features have been included, and how they may be used to take photographs in many different situations.

The “Tutorial” section gives you enough information for simple “point-and-shoot” photography when you first start using your camera. This section may be all you need to read if you want to take advantage of the simplicity and immediacy of digital photography.

Once you have taken a few photographs, “Where Do I Go from Here” outlines how to view them on a computer or television set and order prints using digital “print orders” that you create with the camera. It also provides some tips on how to take photographs for electronic distribution and for printing on a personal color printer.

Finally, the “Reference” section provides a comprehensive guide to all aspects of digital photography with the COOLPIX 880, including manual control of exposure, tone, sharpness, taking movies, caring for your camera, and troubleshooting, together with a list of optional accessories.

To make it easier to find the information you need, the following symbols and conventions are used:



This icon marks cautions, information that you should read before use to prevent damage to your camera.



This icon marks notes, information that you should read before using your camera.



This icon marks tips, additional information you may find helpful when using your camera.



This icon indicates that more information is available elsewhere in this manual or in other documentation.



This icon marks cross-references to the *Guide to Digital Photography* (this manual). The number next to the icon gives the page on which more information may be found.



This icon marks cross-references to the *Fast Track Guide*.



This icon marks cross-references to *For Your Safety*.



This icon marks cross-references to the *Menu Guide*.



Life-Long Learning

As part of Nikon's "Life-Long Learning" commitment to ongoing product support and education, continually-updated information is available on-line at www.nikon-euro.com. Visit this site to keep up-to-date with the latest product information, tips, answers to frequently-asked questions (FAQs), and general advice on digital imaging and photography.

Tutorial

Parts of the COOLPIX 880



Using the Menus



First Steps/Taking Photographs

1

This section:

- Introduces you to the parts of the COOLPIX 880 and the camera menus
- Takes you step-by-step through the process of setting up your camera
- Outlines the steps involved in taking photographs and playing them back

Getting to Know the COOLPIX 880

The Parts of the Camera and Their Functions

Take a few moments to familiarize yourself with camera controls, displays, and menus.

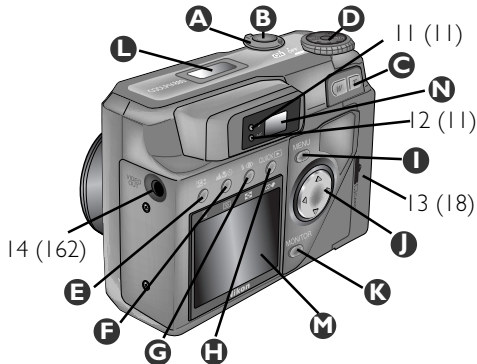
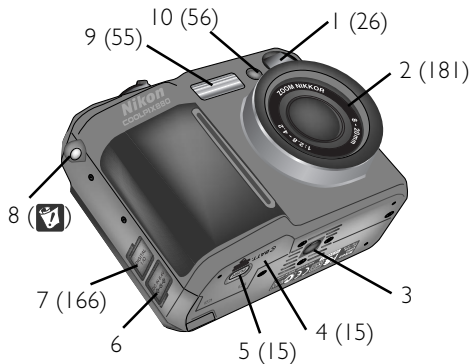

* Refer to the page numbers in parentheses for more information.

1 Viewfinder window

2 Lens

3 Tripod socket

4 Battery-chamber cover

5 Battery-chamber latch

6 DC-IN connector

7 USB/serial connector

8 Eyelet for camera strap

9 Flash

10 Red-eye reduction lamp

11 Flash-ready lamp

12 Autofocus lamp

13 Memory-card slot

14 VIDEO OUT connector

A The Power Switch



The power switch is used to turn the camera on and off.

  23–24

B The Shutter-Release Button



The COOLPIX 880 has a two-stage shutter-release button.

Press the shutter-release button halfway to focus. Focus will remain fixed while the button is held in this position (focus lock).

Press the shutter-release button all the way down to take a picture.

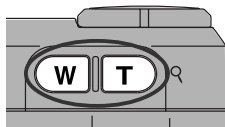

  28–30

C The Zoom Buttons



Use the zoom buttons to frame photographs. The **W** button zooms the camera out, increasing the area visible in the final photograph. The **T** button zooms the camera in, enlarging small or distant objects to fill the frame.

When an image is played back full screen, the **T** (Q) button is used to zoom in on the image displayed in the monitor. Press the **W** button to cancel zoom.

  52–54, 116



D The Mode Dial



Use the mode dial to select the operating mode.



Mode	Description	
 Auto	An automatic mode for simple, “point-and-shoot” photography	 23–31
 Scene	This mode offers a choice of settings for specific scenes, such as sunsets and portraits	 32–38
P Programmed auto	This mode puts the camera in charge of exposure, while leaving you in control of all other settings	 68–69
A Aperture-priority auto	The camera sets the shutter speed while you control aperture and other settings	 68–71
M Manual	You control all camera settings, including shutter speed and aperture	 68–73
CSM Custom	Puts you in complete control of all settings, including exposure mode	 68–73
 Playback	Use this mode to play back and delete photographs	 111 –133





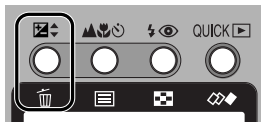







Novice

Expert

E The Button









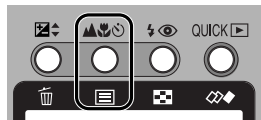

The functions controlled by the    button depend on the operating mode and on the combination of buttons used.

Function	Mode	Operation	
Exposure compensation	AUTO, SCENE, P, A, CSM (exposure mode P, A)	 + 	 64–65
Shutter speed/aperture	A, M, CSM (exposure mode A, M)	 + 	 71–72
Sensitivity (ISO equivalency)	P, A, M, CSM	 + 	 74–75
Single-image deletion			 Press  119

F The Button









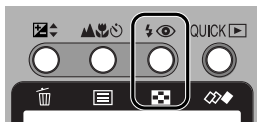

The    button controls the functions shown at right.

Function	Mode	Operation	
Focus mode	AUTO, SCENE, P, A, M, CSM	 Press	 58–61
Manual focus distance	P, A, M, CSM	 + 	 76–77
Photo-information display		 Press	 114

The Button



The    button controls:



Function	Mode	Operation	
Flash mode	AUTO, SCENE, P,A, M, CSM	 Press	 55–57
Thumbnail display		 Press	 118

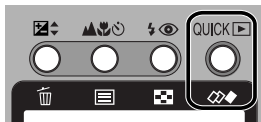

The QUICK Button



The QUICK    button is used to review photographs while shooting. In playback mode, its function is to start and stop movie playback.

  39–43, 117

The MENU Button

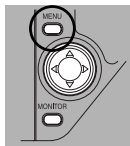

Press the MENU button to display or hide the menu for the current operating mode, or to display the second page of a two-page menu.

  12

The Multi Selector

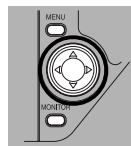

Use the multi selector to select items from the camera menus, or to scroll through the images in memory in quick-review or playback modes.

  13–14

K The MONITOR Button

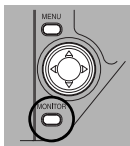

The MONITOR button controls the monitor in AUTO, P, A, M, CSM, and  modes.

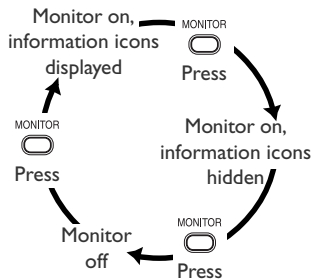

The monitor can not be turned off in SCENE and SETUP modes.

L The Control Panel

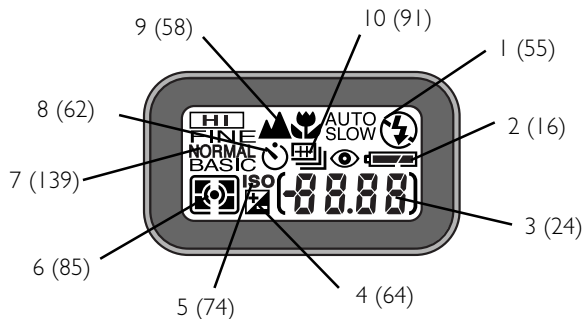

* Refer to the page numbers in parentheses for more information.

- | | |
|---|---|
| 1 Flash mode | 5 Sensitivity (ISO equivalency) indicator |
| 2 Battery indicator | 6 Metering method |
| 3 Exposure-count display (shows numbers of exposures remaining) | 7 Image quality |
| 4 Exposure-compensation indicator | 8 Self-timer indicator |
| | 9 Focus mode |
| | 10 Continuous setting |

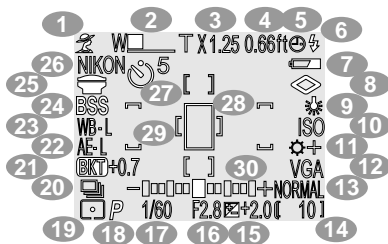

* Refer to the page numbers in parentheses for more information.

- | | | |
|---|---|---|
| 1 Scene indicator (33) | 11 Image adjustment (95) | 22 Auto-exposure lock (99) |
| 2 Zoom indicator (53) | 12 Image size (141) | 23 White-balance lock (99) |
| 3 Digital-zoom factor (53) | 13 Image quality (139) | 24 Best-shot selection (93) |
| 4 Focus mode/manual focus distance (58) | 14 Number of exposures remaining at current settings (24) | 25 Lens-converter setting (108) |
| 5 "Date not set" icon (22) | 15 Exposure compensation (64) | 26 Current folder (148) |
| 6 Flash mode (55) | 16 Aperture (f number) (71) | 27 Self-timer indicator (62) |
| 7 Battery indicator (16) | 17 Shutter speed (72) | 28 Auto-exposure target (spot metering) (87) |
| 8 Sharpening (97) | 18 Exposure mode (71) | 29 Focus areas (66) |
| 9 White balance (84) | 19 Metering method (86) | 30 Exposure display (manual exposure mode) (72) |
| 10 Sensitivity (ISO equivalency) (74) | 20 Continuous setting (91) | |
| | 21 Exposure-bracketing indicator (100) | |

N The Viewfinder

Focus target (Auto/Scene)
Center focus area for manual or
automatic AF-area selection
(P•A•M/CSM)

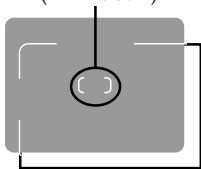

Use this area to frame photographs at ranges of less than 90 cm (1 yd)

The flash lamp (red) and autofocus (AF) lamp (green) next to the viewfinder provide a visual guide to camera status.



	Lamp	Meaning
Flash Lamp (Red)	Glows steadily	Flash will fire when photograph is taken
	Blinks	Flash charging (📷 55)
	Off	Flash not required or flash set to “off”
AF Lamp (Green)	Glows steadily	Subject in focus
	Flashes rapidly	Camera unable to focus using autofocus. Use focus lock (📷 29) or manual focus (📷 76).
	Blinks	Camera recording image(s) to memory card. Do not eject card or remove or disconnect power source while lamp is blinking.
	Blinks slowly	Digital zoom (📷 52) in effect; frame photographs in monitor



Using the Camera Menus

Changes to some settings can be made with the help of menus that appear in the monitor. Separate menus are available for scene, P•A•M, CSM, playback, and setup modes (no menu is available in AUTO mode).

Mode	Menu	Function
SETUP	SET-UP	Basic camera setup (e.g., formatting memory cards, setting the time and date); image quality and size settings for AUTO and SCENE modes
P•A•M CSM	SHOOTING	Advanced shooting options (e.g., white balance, metering). Two menus are available, one for P, A, and M modes, the other for CSM mode. Changes to settings in one menu do not affect the other.
SCENE	SCENE	Scene selection
	PLAY BACK	Playback options

Viewing the menus

When the camera is on, the menu for the current operating mode can be displayed by pressing the MENU button.



Press

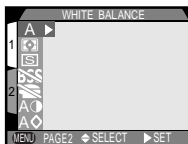

Menu for current mode displayed

If MENU PAGE2 is displayed in the lower left corner of the menu screen, pressing the MENU button a second time will display the second page of the menu. Pressing the MENU button when MENU OFF is displayed clears the menu from the monitor.

Making a selection

Use the multi selector to make a selection.

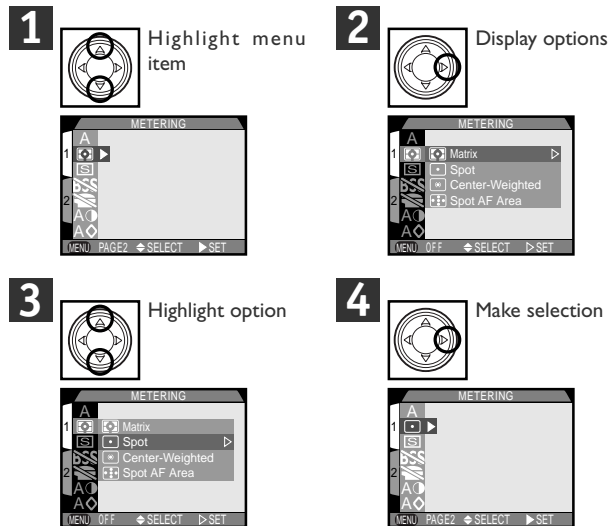

- To go back one step, press the multi selector to the left.
- The selection for some menu options is made from a sub-menu. Repeat steps 3 and 4 to select the desired setting from the sub-menu.
- Changes to settings apply as soon as the selection is made.
- In SCENE, P•A•M, and CSM modes, the view through the lens is visible behind the menu. To take a photograph while the menu is displayed, press the shutter-release button.



Pg. For more information on:



— Camera menus

Multi-page menus

To move between pages of a multi-page menu.

- 1** Position cursor in main menu

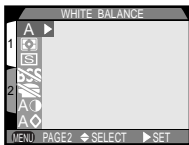

- 2** Highlight page tab

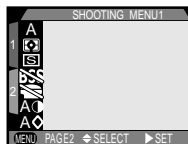

- 3** Highlight page number

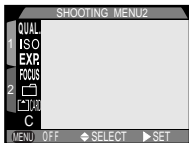

- 4** Display selected page



- You can also go from the first to the second page of a multi-page menu by pressing the MENU button once.

First Steps

Getting Ready to Use Your Camera

Before using your camera for the first time, you will need to:

- Check the contents of the package (see the packing list included in the “Open Me First” envelope)
- Attach the camera strap and lens-cap string as described in *For Your Safety* 
- Put the battery in the camera
- Insert the memory card
- Choose a language for the camera menus and messages
- Set the time and date

Inserting the Battery

1 Turn the camera off

If the camera is on a tripod, remove the tripod before proceeding to the next step.

2 Open the battery-chamber cover

Pressing the battery-chamber latch (1), slide the battery-chamber cover out (2) and flip it open (3).

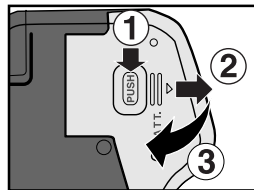

1

3 Insert the battery

Insert a 2CR5 (DL245) lithium battery or a rechargeable Nikon EN-EL1 lithium-ion battery (available separately) as shown at right.

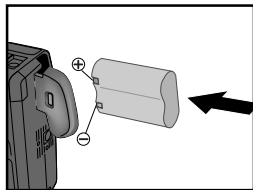

4 Close the battery-chamber cover

To prevent the battery from falling out of the camera during operation, be sure the battery chamber is latched.

5 Check the battery level

After removing the lens cap (📷 23), turn the camera on and check the battery level in the control panel.

1



Battery fully charged



Low battery

Replace the battery as soon as possible.



Battery exhausted

No photographs can be taken until the battery has been replaced.

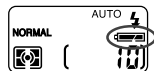

The battery-level indicator may briefly show  (battery fully charged) after an exhausted 2CR5 (DL245) battery is re-inserted in the camera.



Read and follow all warnings and instructions supplied by the battery manufacturer.



The battery can be removed without affecting photographs stored on the camera's memory card. All settings other than date and language will, however, be reset.

The clock-calendar is powered by a separate, rechargeable battery, which is charged as necessary when the main battery is installed. If the camera has been stored for a long period of time with the main battery removed, the clock may need to be reset. Once the main battery has been re-inserted, the clock battery will recharge in several hours, during which time the main battery should be left in the camera.



Alternative Power Sources

Although the COOLPIX 880 can be used with non-rechargeable 2CR5 (DL245) lithium batteries, available at a wide variety of retail outlets, we recommend the rechargeable Nikon EN-EL1 Li-ion battery, available separately from Nikon. This lithium-ion battery, for use exclusively with the COOLPIX 880, can be recharged with the EH-21 AC adapter/battery charger, which doubles as an AC adapter. While the battery recharges, you can connect the camera to the EH-21 and use an AC power source for shooting or playback.

Inserting the Memory Card

- 1 Turn the camera off
- 2 Insert the memory card
Slide the card-slot cover out (1) and flip it open (2). Slide the card in (3) until it is firmly in place and the eject button pops up.

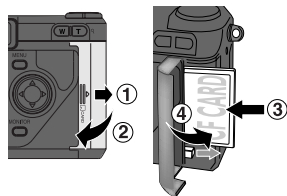

- 3 Close the card-slot cover (4)

1



Removing memory cards

Memory cards can be removed without loss of data when the camera is off. To remove memory cards, turn the camera off and open the card-slot cover (5). Press the eject button to partially eject the card (6) and then remove the card by hand.



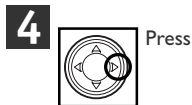

Formatting Memory Cards

Format memory cards before first use.



Confirmation dialog displayed. Press multi selector down to highlight **Format**, then press to right to format card. Do not turn camera off or remove card until “**FORMATTING**” message has disappeared from display. All data on card will be permanently deleted.

Pg. For more information on:

-  — Safe handling of memory cards
-  173 Approved memory cards

Choosing a Language

Camera menus and messages can be displayed in English, French, German, and Japanese.

1



Turn camera on and select SETUP

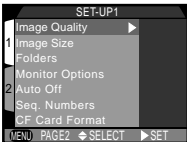

2



Press to display second page of SET-UP menu

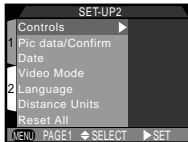

3



Highlight Language

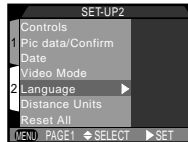

1

4



Press

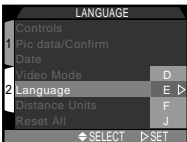

5



Highlight option

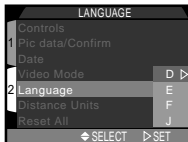

6



Press

Setting the Time and Date

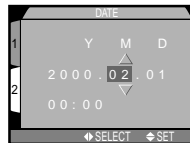
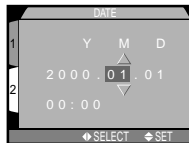
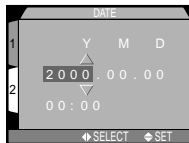
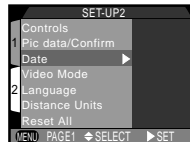
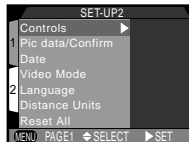

7

To change order in which year, month, and date are displayed, press multi selector to right until **Y M D** is highlighted, then press multi selector up or down

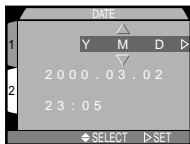

Camera cycles through settings as shown below:

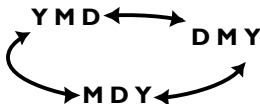
**8**

To save changes to settings, highlight **Y M D** and press multi selector to right

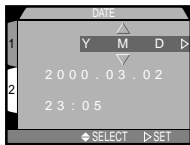
**1**

Any photographs taken before the time and date have been set will have a time stamp of "2000/01/01 0:00." Until you have set the time and date, a flashing clock icon will be displayed in the top right corner of the monitor when the camera is in shooting mode.

This chapter describes the basic steps involved in taking photographs in AUTO and SCENE modes. In these automatic, “point-and-shoot” modes, the majority of settings are controlled by the camera in response to lighting conditions and focus distance, producing the best possible results.

Getting the Camera Ready for Use (AUTO Mode)

1 Remove the lens cap

If you turn the camera on with the lens cap in place and the mode dial set to AUTO, SCENE, P, A, M, or CSM, an error message will appear in the monitor. To clear the message from the display, turn the camera off and remove the lens cap.



2 Turn the mode dial to AUTO

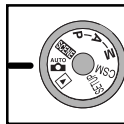

3 Turn the camera on

After a short pause, current settings will be displayed in the monitor and control panel.

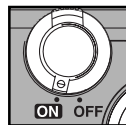
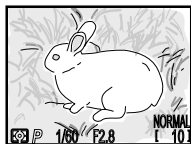

4 Check the number of exposures remaining



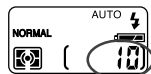
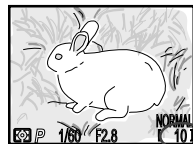



The monitor and control panel show the number of exposures remaining at current settings. When this number reaches zero, you will need to insert a new memory card or delete some pictures (I 22) before you will be able to take more photographs. It may be possible to record more photographs at a different image quality or size (I 37).



Number of exposures remaining

5 Adjust camera settings (optional)

In AUTO mode, you can use the buttons or menus listed below to control flash setting, focus mode, image quality, and image size. The first time you turn the camera on, these settings will be set to the default values shown. These settings are adequate for most situations, and the description in this section assumes that the default settings are used. For information on changing these settings, refer to the page numbers given below.

Setting	Default	Description	Control	
Flash mode	Auto	Flash fires automatically when lighting is poor		 55–57
Focus mode/ self-timer	Autofocus	Camera focuses automatically at distances over 40 cm (16"); self-timer off		 58–61
Image quality	NORMAL	Photographs compressed for best balance between file size and image quality	SETUP menu	 138
Image size	FULL	Photographs are 2048 × 1536 pixels in size. When image quality is set to NORMAL, about ten full-size images can be stored on one 8 MB memory card.	SETUP menu	 140

Framing Photographs

1 Ready the camera

To reduce blurring caused by camera shake, hold the camera steadily in both hands. Photographs can be framed in the monitor (A) or the viewfinder (B).

Frame photographs in the monitor when:

- you are using macro close-up (📷 59)
- you are using digital zoom (📷 52)
- you are using a lens converter (📷 106)
- you want direct confirmation of camera settings or the view through the lens

Frame photographs in the viewfinder when:

- you want to save power by turning the monitor off (📷 9)
- bright ambient lighting conditions make it difficult to see the display in the monitor

A**B****1**

Keep your fingers and other objects away from the lens and flash window when framing photographs.

2 Select your subject

Frame the photograph using the zoom buttons. Press the **W** button to zoom out from your subject, increasing the area visible in the frame. Press the **T** button to zoom in on your subject, decreasing the area visible in the frame.

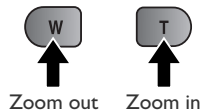

Indicator in LCD monitor displays amount of zoom while either button is pressed

1



When framing photographs in the viewfinder at ranges of 90 cm (1 yd) or less, use the smaller of the two frames in the viewfinder display (the shaded area in the illustration at right).



Focus and Shoot

1 Focus

In AUTO mode, the camera focuses on the subject in the center of the frame, shown by the focus target in the viewfinder. Before taking a photograph, press the shutter-release button halfway to initiate autofocus, and check the status of the autofocus (AF) lamp (green) and the flash lamp (red) next to the viewfinder:



	Lamp	Meaning
Flash Lamp (Red)	Glows steadily	Flash will fire when photograph is taken
	Blinks	Flash charging. Remove finger briefly from shutter-release button, then try again.
	Off	Flash not required or flash set to “off”
AF Lamp (Green)	Glows steadily	Subject in focus
	Flashes rapidly	Camera unable to focus using autofocus. Use focus lock to focus on another subject at the same distance, then recompose photograph.



Pg. For more information on:



66 Manual focus-area selection

Focusing on an Off-Center Subject: Focus Lock

In AUTO and in all SCENE modes except **Portrait** and **Close Up** (📷 32), the camera automatically focuses on the subject at the center of the frame. If your subject is not located at the center of the frame when the shutter-release button is pressed halfway, the camera will focus on the background. Focus lock allows you to first focus on your subject, then adjust the composition before taking the photograph.

a Focus the camera

Position the subject in the center focus area (shown by the focus target in the viewfinder) and press the shutter-release button halfway.

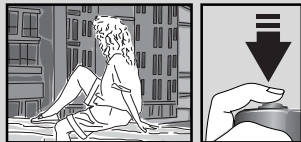

b Check the AF lamp

With the shutter-release button held halfway down, check that the green AF lamp next to the viewfinder glows steadily, indicating that the subject is in focus. Focus will remain locked while the shutter-release button is held halfway down.



c Recompose the photograph and shoot

Keeping the shutter-release button held halfway down, re-compose your photograph. Press the shutter-release button the rest of the way down to shoot.

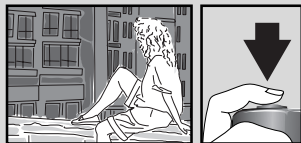

Do not change the distance between the camera and the subject while focus lock is in effect. If your subject moves, remove your finger from the shutter-release button and focus again at the new distance.

2 Take the photograph

To take a photograph, press the shutter-release button all the way down.

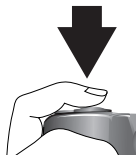





3 Check the results

After a photograph has been taken, the green autofocus lamp will blink while the photograph is recorded. Before the photograph is transferred to the memory card, it will be displayed briefly in the monitor. The following operations can be performed while the photograph is being displayed:



1

Button	Operation	Function
	Press	<p>Delete dialog is displayed. Press multi selector up or down to highlight option, press to right to select.</p> <ul style="list-style-type: none">• Select Yes to delete photograph• Select No to save photograph and return to shooting mode

Button	Operation	Function
II (▲▲🌱🕒)	Press	Press to pause display for 20 s. Press again to record photograph, or press  () to delete as described above. Photograph recorded automatically after 20 s.
Shutter release	Press halfway	Record photograph and return to shooting mode
Shutter release	Full press	Take new photograph while saving photograph displayed in monitor to memory card. While photograph is being saved, any new photographs will be stored in temporary memory buffer before being saved to card. New photographs can be taken until buffer is full (buffer can hold about five full-sized, normal-quality images). When buffer is full, hourglass icon () will be displayed and shutter release disabled. New photographs can be taken as soon as enough memory is available in buffer and  icon is no longer displayed.



While photographs are recorded to the memory card, the green autofocus lamp will blink. Do not eject the memory card, remove the battery, or unplug the AC adapter (available separately) until the lamp has stopped blinking. Removing the card or cutting power in these circumstances could result in loss of data.

Assisted Creative Photography: Scene Mode

While the default settings in AUTO mode are suited to a wide variety of situations, some compositions call for special combinations of settings. In SCENE mode, you select the scene from a menu of creative shooting situations, and the camera automatically adjusts settings to produce the best possible results.

This section outlines how to take photographs in SCENE mode.

1 Ready the camera

Turn the camera on and check the number of exposures remaining as described above under “Getting the Camera Ready for Use (AUTO Mode)” ( 23).

1



Do not use SCENE mode when taking photographs that will later be retouched on a computer.



Depending on the subject, SCENE-mode settings may not always produce the desired results. If you are unsatisfied with photographs taken in SCENE mode, try setting the mode dial to AUTO.



Pg. For more information on:



12 Using the menus

2 Choose the scene

After identifying the shooting situation (see following pages), select the appropriate composition type from the SCENE-mode menu.

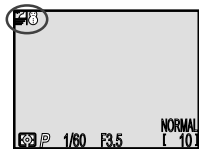

SCENE-mode icon displayed in monitor

When the MENU button is pressed to display the SCENE-mode menu, the most recently selected setting will be highlighted. Pressing the MENU button a second time clears the menu from the monitor.

3 Adjust camera settings

Depending on the scene selected, you may be able to adjust flash and focus-mode settings as described in Step 5 of “Getting the Camera Ready for Use (AUTO Mode)” (📖 23). Restrictions apply to the selection of flash and focus modes in some cases (see following pages). Image quality and size can be adjusted from the SET-UP menu (📖 137).

4 Focus and shoot

Focus the camera and shoot as described above under “Focus and Shoot” (📖 28). Depending on the scene selected, you may be able to select the focus area manually, allowing you to focus on an off-center subject without using focus lock (see following pages).

1



Camera Shake

The “camera shake” ratings on the following pages indicate settings at which caution is advised to prevent blurring caused by camera shake. While the use of a tripod is recommended in such cases, the other methods available to prevent camera shake are reflected in the number of stars:

- ★ Support the camera steadily in both hands with your elbows held against your torso
- ★★ Steady the camera by placing it on a flat, level surface such as a wall or table
- ★★★ Use a tripod to steady the camera

The SCENE-mode Menu

The SCENE-mode menu contains two pages of options. The types of composition available are described below.

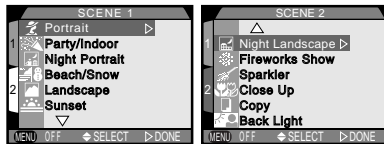

Portrait (👤)

Use to obtain portrait photographs in which the main subject stands out clearly and background details are softened, lending the composition a sense of depth.



Flash mode: No restrictions

Focus mode: Can be chosen from autofocus and autofocus + self-timer

Notes: AF-area mode is set to **Manual**, allowing the focus target to be chosen using the multi-selector (👤 66). The degree to which background details are softened depends on the amount of light available.

Party/Indoor (🎉)

Use at parties and other indoor events for atmospheric photographs that include details of the background behind the subject.



Flash mode: Auto with Red-Eye Reduction/Slow Synch

Focus mode: Can be chosen from autofocus and autofocus + self-timer

Camera shake: ☆

1

Night Portrait (📷)

Use for photographs that provide a natural balance between the main subject and the background when taking portraits against a backdrop of nighttime scenery.



Flash mode: Auto with Red-Eye Reduction/Slow Synch

Focus mode: Can be chosen from autofocus and autofocus + self-timer

Camera shake: ☆

1

Beach/Snow (🌊)

Use for photographs that vividly capture the brightness of such subjects as snowfields, beaches, or sunlit oceans and lakes.



Flash mode: No restrictions

Focus mode: No restrictions

Landscape (🏞️)

Use for vivid landscape photographs that enhance outlines, colors, and contrast in subjects such as skyscapes and forests.



Flash mode: Flash Cancel (off)

Focus mode: Infinity

Sunset (🌅)

Use for photographs that capture the beautiful reds in sunsets or sunrises exactly as you see them.



Flash mode: Flash Cancel (off)

Focus mode: Can be chosen from autofocus, autofocus + self-timer, and infinity

Night Landscape (🌃)

Use for photographs that employ slow shutter speeds to produce stunning night landscapes.

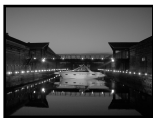

Flash mode: Flash Cancel (off)

Focus mode: Infinity

Camera shake: ★★

Fireworks Show (🎆)

Use when photographing firework displays. The camera responds more rapidly to the shutter-release button, ensuring that you won't miss the chance to take the perfect shot.



Flash mode: Flash Cancel (off)

Focus mode: Infinity

Camera shake: ★★★

Notes: Follow the firework as it ascends and press the shutter-release button just as the firework explodes.

Sparkler (🎇)

Use when taking atmospheric shots of sparklers with your family and friends.



Flash mode: Auto with Red Eye Reduction/Slow Synch

Focus mode: Can be chosen from autofocus and autofocus + self-timer

Camera shake: ★

Notes: Position the sparkler in the center of the frame for the best results.

Close Up (🌸)

Use to capture vivid colors in close-up shots of flowers, insects, and other small objects that catch your eye.



Flash mode: Flash Cancel (off)

Focus mode: Can be chosen from macro close-up and macro close-up + self-timer

Camera shake: ☆

Notes: AF-area mode is set to **Manual**, allowing the focus target to be chosen using the multi-selector (📷 66).

1

Copy (📄)

Use to obtain clear pictures of text or drawings on a white board, business card, or in printed matter.



Flash mode: No restrictions

Focus mode: No restrictions

Notes: If the subject is colored, text or drawings may be faint and hard to distinguish in the final photograph.

Back Light (🌞)

Use when light is coming from behind your subject, throwing their features into shadow, or when your subject is in the shade but the background is brightly lit.



The flash will fire automatically to illuminate (“fill in”) shadows.

Flash mode: Anytime Flash (fill flash)

Focus mode: Can be chosen from autofocus and autofocus + self-timer

Review and Deletion: Quick Review

In AUTO, SCENE, P,A, M, and CSM modes, you can use the QUICK  button to play back photographs stored on the memory card. Press the button to cycle through shooting and review modes as shown below.



Shooting Mode
(AUTO, SCENE,
P,A, M, or CSM)



Quick Review

Photographs stored on memory card are displayed in top left corner of monitor, allowing you to view results of previous photographs while setting up your next shot.

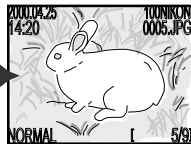



Full-Screen Review

Photographs stored on memory card are displayed full screen or in thumbnail menus of four or nine images. You can zoom in on photographs, view photo information, and delete individual images.

Quick Review

When you press the QUICK  button in AUTO, SCENE, P, A, M, and CSM modes, the most recent photograph in memory will be displayed at the top left corner of the monitor. The following operations can be performed in quick-review mode:



Button	Operation	Function
	Press	View other photographs in current folder. Press up or left to view photographs recorded before current photo, down or right to view images recorded after current photo. Hold down to scroll rapidly to desired frame number.
Shutter release	Press halfway	Return to shooting mode and focus
Shutter release	Full press	Return to shooting mode and take photograph
QUICK 	Press	Enter full-screen review mode with current photograph displayed full screen

All other camera controls function as they do in shooting mode.



Pg. For more information on:









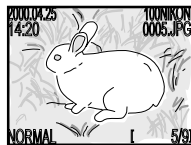

142 Using folders

Full-Screen Review

From quick-review mode, press the QUICK  button to enter full-screen review mode. The photograph displayed in quick-review mode will be displayed full screen. The following operations can be performed in full-screen review mode:





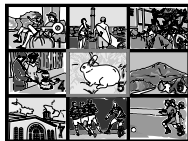

Button	Operation	Function
	Press	View other photographs in current folder. Press up or left to view photographs recorded before current photo, down or right to view images recorded after current photo. Hold down to scroll rapidly to desired frame number.
	Press	Zoom in on current photograph (use multi selector to view other areas of image)
	Press	Cancel zoom
	Press	Select current photograph for deletion
	Press	Display menu of nine thumbnail images (see overleaf)
	Press	Display next page of photo information ( 1 4)
QUICK 	Press	Return to shooting mode

Thumbnail Review

Pressing the  button in full-screen review brings up a menu of nine thumbnail images. The following operations can be performed while thumbnails are displayed:





Button	Operation	Function
	Press	Press once to display menu of four thumbnail images, twice to view highlighted thumbnail at full size
	Press	Highlight thumbnail. Use  button to view highlighted thumbnail at full size
	Press	Select highlighted thumbnail for deletion
QUICK 	Press	Return to shooting mode

1



Playback Mode

When the mode dial is set to  (playback), you can perform any of the operations covered in this section under “Full-Screen Review,” “Thumbnail Playback,” and “Deleting Photographs.” In addition, you can play back movies using the QUICK  button, and have access to a menu of playback options where you can delete multiple photographs, choose the folder for playback, protect and hide images, and prepare digital “print orders” for printing images directly from the memory card. For more information, see “Reference: Playing Images Back” ( | | |).

Deleting Photographs

In full-screen or thumbnail review, pressing the  button selects the current image for deletion.

**Full-screen
review**

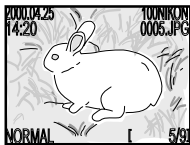

**Thumbnail
review**

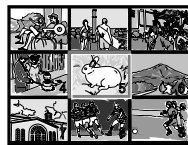

Press  button



Delete dialog is displayed. Press multi selector up or down to highlight option, press right to select.

- Select **Yes** to delete photograph
- Select **No** to save photograph and return to shooting mode

Putting the Camera Away

When you have finished using the camera, follow these steps before putting the camera away.

1 Turn the camera off

To avoid wasting batteries, check that the camera is off before putting it away.

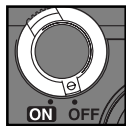

2 Replace the lens cap



Where Do I Go from Here?

This section:

When they have finished shooting, users of conventional film cameras typically take the film to be developed. But what do you do with photographs you have taken with a digital camera? This section lists some of the options available, including:

- viewing photographs on a computer or television
- ordering prints using digital “print orders”

This section also outlines how to adjust camera settings to produce photographs suitable for:

- sending by e-mail or posting on a website
- output on a color printer

A detailed explanation of the concepts used here may be found in the “Reference” section.

Getting the Most from Digital Images: Your Camera and Your Computer 164

As the name would indicate, digital cameras produce digital images. As digital data, digital images can be readily copied to a computer, where they can then be stored, viewed or edited using imaging software, sent to your acquaintances via e-mail, or saved to removable media (for example, a floppy or Zip disk) for delivery to a photofinisher.

There are two ways to copy data to your computer from the COOLPIX 880:

- **Direct USB or serial connection using Nikon View software**

If you have Nikon View installed on your computer, you can connect your camera to the computer using the UC-E1 Universal Serial Bus (USB) cable included with your camera. Optional serial cables (the SC-EW3 for PC computers and SC-EM3 for Macintosh computers) are also available.

Once the camera is connected, a camera icon will appear in the My Computer window (Windows computers) or on the desktop (Macintosh computers). Double-click the icon to view the contents of the camera's memory card. Nikon View shows the images stored on the memory card as icons or thumbnails (small previews) that can be dragged and dropped into another folder for storage, or directly into an application for immediate use (note that images can not be saved to the camera from the computer).

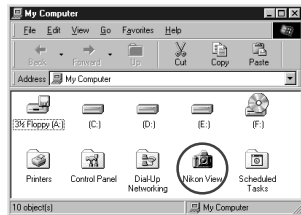

Camera icon (Windows)

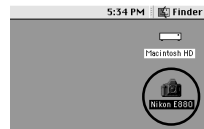

Camera icon (Macintosh)

- **PC card adapter or PC-card reader**

If your computer is equipped with a PC-card reader, or if you have a computer with a PC-card slot and a PC-card adapter, you can remove the memory card from your camera and insert it in the computer's card slot or card drive, where it will function as another disk drive.

Viewing Photos on TV 162

The COOLPIX 880 can be connected to a television or VCR using the EG-900 video cable provided with your camera. While the camera is connected, the television will show the same image as the camera's monitor.

Ordering Prints: Digital Print Order Format (DPOF) 132

The  mode menu contains an option for creating digital "print orders" that are stored on the camera's memory card in Digital Print Order Format (DPOF). Once you have prepared a print order using this option, the card can be removed from the camera, inserted in a DPOF-compatible device—whether your personal photo printer or a photofinisher's print system—and photographs printed directly from the card.

Taking Photographs for E-Mail and the Web

Your camera stores images in TIFF and JPEG formats, which can be viewed with a wide variety of imaging software. JPEG images can even be displayed in web browsers such as *Netscape Navigator* and *Internet Explorer*. This makes them ideal for transmission by e-mail or for use on a web page. Be aware, however, that when displayed on a monitor with a resolution of 1024 by 768 pixels, only VGA and QVGA images (📷 89) are small enough to fit in the browser window. It is also important to remember that at default settings your camera produces high-resolution images about 800 KB in size, while TIFF images taken at an image quality setting of **HI** can reach sizes of approximately 9 MB. Larger file sizes mean longer data transfer times—even an 800 KB file takes about five minutes to upload or download over a 28.8 Kbps connection—making file size the single most important consideration when taking photographs for electronic distribution. The following settings are recommended for images destined for distribution by e-mail or on the web:

Image Quality (📷 138)	Image Size (📷 140)	Approx. File Size	Approx. Transfer Time (28.8 Kbps Connection)
BASIC	XGA (1024 × 768 pixels)	100 KB	50 seconds
NORMAL	VGA (640 × 480 pixels)	90 KB	35 seconds
BASIC	VGA (640 × 480 pixels)	50 KB	20 seconds

Taking Photographs for Printing

When taking photographs that are to be reproduced on a personal color printer, two factors need to be kept in mind: image size and contrast.

Image size ( 140) determines the maximum size at which the image can be printed. If the print size is too large, the individual pixels will be visible to the naked eye, giving the image a rough, uneven appearance. A typical target resolution for an ink-jet printer is about 200 pixels per inch. At this resolution, a VGA photograph will be output at a size of 3.2 × 2.4 inches (8.1 × 6.1 cm), a full-size image at a size of about 10.2 × 7.7 inches (26.0 × 19.5 cm).

The second consideration is contrast. You may find that the colors in the images produced by your printer are indistinct, or “muddy,” as compared to the photograph viewed on the camera monitor. In this case, you can try raising contrast by setting the camera to P, A, M, or CSM and using an IMAGE ADJUSTMENT setting of **More Contrast** when taking photographs destined for output on a color printer ( 94).

Reference

Camera Controls



The Shooting Menu



Playback



Camera Setup

SETUP

This section:

This section details the settings available in shooting, playback, and setup modes. It also describes how to connect your camera to external devices such as computers and television sets, and explains how to care for your camera and what to do when it does not function as expected. Camera specifications and a list of the optional accessories available for the COOLPIX 880 are included in the final section.



Pg. For more information on:



— Camera menus

This chapter covers operations that can be performed in AUTO and SCENE modes. In these modes, the majority of camera settings are made automatically by the camera to produce the best results. By means of the buttons on the back of the camera, the user controls the following settings directly (restrictions may apply in SCENE mode depending on the scene selected):

- optical and digital zoom
- flash settings
- focus-mode and self-timer settings
- exposure compensation
- focus-area selection (**Portrait, Close Up, P, A, M,** and CSM modes only)

Framing Photographs: Optical and Digital Zoom



The COOLPIX 880 is equipped with two kinds of zoom: *optical zoom*, in which the camera's telescoping lens can be used to enlarge the subject by up to 2.5x, and *digital zoom*, in which images are processed digitally to further enlarge the image by up to 4.0x.



Optical vs. Digital Zoom

In digital zoom, data from the camera's image sensor are processed digitally, enlarging the center portion of the image to fill the frame. Unlike optical zoom, digital zoom does not increase the amount of detail visible in the photograph. Instead, details visible at maximum optical zoom are enlarged, producing a slightly "grainy" image. Digital zoom also differs from optical zoom in that the effects of digital zoom are visible only in the monitor, not in the viewfinder, meaning that the monitor must be on before digital zoom can be used.

Optical Zoom

Photos can be framed in the viewfinder or monitor using the zoom buttons.



Zoom out



Zoom in



Indicator in monitor displays amount of zoom while either button is pressed

Digital Zoom

At the maximum optical zoom position, holding the **T** button down for two seconds triggers digital zoom.



Maximum optical zoom position



Hold for two seconds

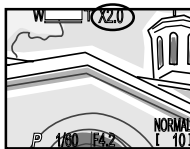

Zoom factor displayed in monitor



AF lamp blinks slowly to show that photos can not be accurately framed in viewfinder

While digital zoom is in effect, the zoom factor increases each time the **T** button is pressed, to a maximum of 4.0x. Pressing the **W** button decreases the zoom factor. To cancel digital zoom, press the **W** button until the zoom indicator disappears.



Digital zoom enlarges the center portion of the image to fill the frame. Because only the center portion of the image appears in the final photograph, center-weighted metering (📖 86) is used, and the center focus area is automatically selected.

Digital zoom is only available when the monitor is on or the camera is connected to a television set. It can not be used when:

- image-quality is set to **HI** (📖 138)
- a setting of **Black & White** is chosen in the IMAGE ADJUSTMENT sub-menu (📖 94)
- **Ultra HS** or **Movie** is chosen in the CONTINUOUS sub-menu (📖 88)
- the **Digital Zoom** item in the CONTROLS sub-menu is not checked (📖 155)



Pg. For more information on:



66 Focus-area selection

Throwing Light on Your Subject: The Flash Button





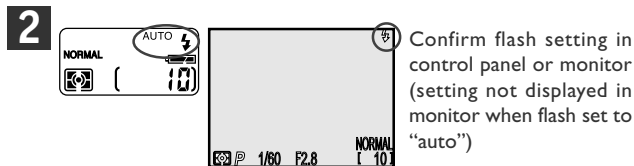
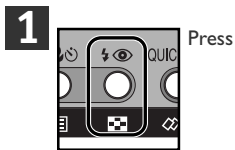

The flash can be adjusted for a variety of shooting situations, as described on the following pages.

To change the flash setting, press the  button, located above the monitor on the back of the camera.



A short pause is required between exposures for the flash system to charge. While the flash is charging, the red flash lamp next to the viewfinder will blink when the shutter-release button is pressed halfway. Try again after briefly removing your finger from the shutter-release button.

The following flash settings are available (restrictions may apply in SCENE mode depending on the scene selected):

Setting	How It Works	When to Use It
 Auto	Flash fires when lighting is poor	Best choice in most circumstances
 Flash Cancel (off)	Flash will not fire even when lighting is poor	Use where subject is outside range of flash or to capture natural lighting under dim light
 Auto with red-eye reduction	Pre-flash lamp fires before main flash to minimize “red-eye” effect caused by flash reflecting from retina	Use for portraits (works best when subjects are well within range of flash and are looking directly at pre-flash)
 Anytime Flash (fill flash)	Flash fires whenever photo is taken	Use to “fill in” (illuminate) shadows and backlit subjects
 Slow synchronized	Auto flash combined with slow shutter speed	Use to capture both subject and background at night or under dim light



Keep your fingers and other objects away from the flash window when using the flash.



When lighting is poor and the flash is set to “Off” (🔌) or “Slow Sync” (SLOW ⚡), shutter speeds slow and photos may be blurred. If possible, use a tripod when lighting is poor. At speeds of below $1/4$ s, the shutter-speed indicator in the monitor turns yellow. Mottling (“noise”) may appear in photographs taken at speeds slower than this value. To increase the shutter speed, try zooming the camera out (📖 53), raising sensitivity (ISO equivalency; 📖 74), or setting the exposure mode to aperture-priority auto and choosing the larger of the two aperture settings (smallest f number; 📖 71).

The built-in flash will automatically be set to “Off” (🔌) when:

- you use autofocus with a setting of “Infinity” (▲; 📖 59)
- **Landscape, Sunset, Night Landscape, Fireworks Show, or Close Up** is selected in SCENE mode (📖 32)
- you choose a CONTINUOUS setting of **Continuous, Multi-shot I6, VGA Sequence, Ultra HS, or Movie** (📖 88)
- you use best-shot selection (BSS; 📖 92)
- you use lens-converter (LENS) settings (📖 106)
- the **AE Lock** option in the EXPOSURE OPTIONS sub-menu is on (📖 99)



Pg. For more information on:



— Safe flash use

Focusing Near and Far: The Focus-Mode Button



By default, the camera adjusts focus automatically for subjects 40 cm (16") or more from the lens, which is ideal for snapshots. Under some circumstances, however, you may want to force the camera to focus on distant objects rather than on the closest object visible in the focus area—for example, when shooting a distant landscape through a screen of branches or when taking a shot through a window. Alternatively, you may want the camera to focus on something closer than 40 cm—a close-up shot of a flower, plant, or business card. The COOLPIX 880 offers focus modes for just these situations. Some of these modes can be combined with a self-timer to delay shutter release to reduce camera shake or allow you to appear in your own photographs.

To select the focus mode, press the  button.

1

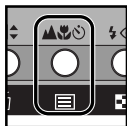

Press

2

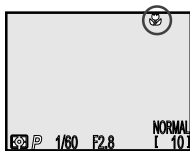

Confirm focus-mode setting in control panel or monitor







Macro close-up

It is recommended that you frame photographs in the monitor when using macro close-up.

While the flash can be used in macro close-up mode, it may sometimes be unable to light the entire subject. Take a test picture and verify the results in the monitor.

The following focus modes are available (restrictions may apply in SCENE mode depending on the scene selected):

Setting	How It Works	When to Use It
 NO ICON Autofocus	Camera automatically adjusts focus according to distance to subject	Use with subjects 40 cm (16") or more from lens
 Autofocus + self-timer	Delay shutter release by 10 s or 3 s in autofocus mode	Use for self-portraits or to reduce camera shake
 Infinity	Focus is fixed at infinity. Flash is disabled.	Use for photographing distant scenes through foreground objects, e.g., through window (manual-focus setting of "Inf" is available for use with flash)
 Macro close-up	Focus adjusted automatically for subjects 4 cm (1.6") or more from lens; optical zoom restricted to range between middle and maximum positions	Use for close-ups
 Macro close-up + self-timer	Delay shutter release by 10 s or 3 s in macro close-up mode	Use to reduce camera shake when taking close-ups

Autofocus Mode

The autofocus system operates in one of two modes:

AF Mode	How It Works	Pros and Cons
Continuous	Camera adjusts focus continuously	PRO Minimizes time required to focus CON Photos can be taken even when camera is not in focus—check AF lamp before shooting
Single	Camera focuses when shutter-release button pressed halfway	PROS Photographs can be taken only when camera is in focus Saves batteries CON Slight delay before camera focuses

In AUTO mode, autofocus mode is determined by whether the monitor is on or off: continuous AF is used when the monitor is on, single AF when it is off. P, A, M, and CSM modes offer additional settings that give greater control over autofocus mode ( 104).





Autofocus performs best when:

- There is contrast between the subject and the background. For example, autofocus may not perform well on subjects that are the same color as the background.
- The subject is evenly lit.

Autofocus does not perform well when:

- The focus area contains objects at different distances from the camera. For example, autofocus may not perform well when photographing an object inside a cage, as the bars of the cage will be closer to the camera than the main subject.
- The subject is very dark (the subject should not, however, be too much brighter than the background).
- The subject is moving rapidly.

If the camera is unable to focus using autofocus, use focus lock ( 29) to focus on another subject at the same distance, or measure the distance to your subject and use manual focus ( 66).

Delaying Shutter Release: Self-Timer Mode



The COOLPIX 880 is equipped with an automatic timer with two settings: three seconds (good for reducing camera shake) and ten seconds (ideal for self-portraits). To use the self-timer, follow these steps:

1 Position the camera

Mount the camera on a tripod (recommended) or rest it on a flat, stable surface.

2 Select a self-timer mode

Press the button until either (autofocus + self-timer; for photographs at ranges of 40 cm/16" or more) or (macro close-up + self-timer; for photographs at ranges of 4 cm/1.6" or more) appears in the control panel or monitor.

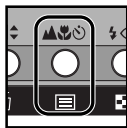

Press

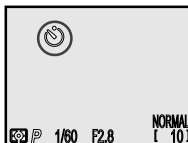

Self-timer icon displayed in control panel and monitor

3 Compose the photograph

4 Start the timer

Fully depress the shutter-release button to activate the timer. Press the shutter-release button once for a ten-second delay, twice for a three-second delay. To stop the timer, press the shutter-release button a third time.



Full press

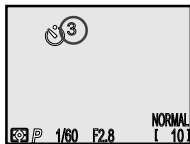

Count-down timer in monitor shows number of seconds remaining until shutter is released

The red-eye reduction lamp next to the flash window will start to blink when the shutter-release button is pressed, and continue to blink until one second before the shutter is released. The red-eye reduction lamp will stay lit during the final second to warn that the shutter is about to be released.

Bright, Dark, and High-Contrast Subjects: Exposure Compensation



To obtain the desired result with certain subject compositions (for example, when large areas of the frame are very bright, very dark, or contain areas of strong contrast), it may be necessary to alter exposure from the value suggested by the camera. This can be done using exposure compensation.

Exposure compensation can be set to values between +2.0 EV (overexposure) and -2.0 EV (underexposure) in increments of $\frac{1}{3}$ EV. Press the multi selector up or down while holding the  button.

1



Press multi selector up to increase exposure value, down to decrease exposure value

2

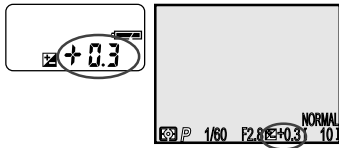

Confirm exposure value in control panel or monitor. Effects of compensation are visible in monitor; adjust until desired result is achieved.

3





 icon displayed in control panel after  button is released



Exposure compensation is not available in manual exposure mode, when the user adjusts exposure directly by adjusting shutter speed and aperture ( 72).



By default, exposure compensation returns to ± 0.0 EV when the mode dial is turned to a new setting or the camera is turned off. If desired, the camera can be set to “remember” the exposure-compensation value ( 155), restoring it the next time the mode dial is set to AUTO, SCENE, P, A, or CSM (exposure mode P or A).

Exposure compensation can also be set using the EXPOSURE OPTIONS > **Exp. +/-** item in the SHOOTING menu ( 102).

Choosing a Focus Area: Manual Focus-Area Selection

In AUTO mode, the camera automatically focuses on the subject in the center focus area, shown by the focus target in the viewfinder. At SCENE-mode settings of **Portrait** and **Close Up** (📷 32), or when **Manual** is selected in the FOCUS OPTIONS > **AF Area Mode** sub-menu for P, A, M, or CSM mode (📷 103), the focus target can be chosen from one of five focus areas. This makes it possible to focus on an off-center subject without using focus lock.

The focus area can be selected using the multi selector:

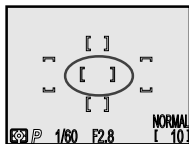

Center focus area selected



Use multi selector to select new focus area

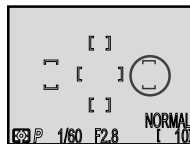

Right focus area selected

Manual focus-area selection is not available when the monitor is off or digital zoom is in effect (📷 53). In these cases, the center focus area is used.

Focus-area selection can be used in combination with focus lock if the subject would not fall in any of the focus areas in the final composition. In P,A, M, and CSM modes, it can also be used in combination with spot AF-area metering ( 86) to lock the spot metering point to the selected focus area.



When **Auto** (the default setting) is selected in the FOCUS OPTIONS > **AF Area Mode** sub-menu for P,A, M, or CSM mode ( 103), the camera automatically selects the focus area containing the subject closest to the camera. No focus area indicators appear in the monitor until the shutter-release button is pressed halfway, when the active focus area is shown in red. Focus-area selection can be deactivated in P,A, M, and CSM modes by selecting **Off** in the FOCUS OPTIONS > **AF Area Mode** sub-menu. In this case, the center focus area is used.

This chapter details settings available only in P, A, M, and CSM modes. In addition to the settings discussed in the previous chapter, in these modes the user can control the following settings by means of the mode dial and the buttons on the back of the camera:

- exposure mode
- sensitivity (ISO equivalency)
- focus distance (manual focus)

Menus in these modes also give the user control over:

- white balance
- metering
- frame-advance rate
- best-shot selection
- contrast, brightness, and image type
- image sharpening
- exposure and autofocus options
- settings for optional lens converters

Choosing a Mode: P,A, M, or CSM?



Because P,A, M, and CSM share many settings in common, you may have difficulty knowing which mode to choose for a particular task. The first consideration is how much control you want to have over camera settings:

- If you want to adjust white balance and metering, for example, but don't want to have to worry about getting the correct exposure, choose a mode setting of P or turn the mode dial to CSM and choose **P** as the exposure mode (📷 98).
- If you want to adjust aperture to soften background details or bring both background and subject into focus, but don't want to have to worry about the photograph being over- or under-exposed, choose a mode setting of A or turn the mode dial to CSM and choose **A** as the exposure mode.
- If you want to adjust the shutter speed to freeze action or to suggest motion by blurring moving objects, or if you want to modify exposure from the value suggested by the camera, choose a mode setting of M or turn the mode dial to CSM and choose **M** as the exposure mode.

Another factor to consider is that menu settings for P,A, and M modes are stored separately from settings for CSM mode. If there is a particular combination of settings you use frequently, you can turn the mode dial to CSM and set the camera to these settings. The camera will “remember” this combination of settings even after being turned off, and will automatically restore the settings the next time you select CSM mode. You can create a different combination of settings for P,A, and M modes and switch instantly from one combination of settings to the other simply by turning the mode dial from CSM to P,A, or M.



Exposure Modes

Exposure mode can be chosen by setting the mode dial to P, A, or M, or by turning the mode dial to CSM and choosing the exposure mode from the EXPOSURE OPTIONS > **Exposure Mode** sub-menu (📷 98). The following modes are available:

Operating Mode/ Exposure Mode (CSM)	How It Works	When to Use It
P Programmed auto	Camera sets shutter speed and aperture for best exposure	Best for general use and snapshots
A Aperture-priority auto	User chooses aperture from maximum and minimum settings; camera sets shutter speed for best exposure	Large aperture (small f number) softens background details and lets more light into camera, increasing range of flash and making photos less susceptible to blurring; small aperture (large f number) increases depth of field, bringing both main subject and background into focus
M Manual	User sets shutter speed and chooses aperture from maximum and minimum settings	Use when you want complete control over exposure. Choose high shutter speeds to freeze action, low shutter speeds to suggest movement by blurring moving objects. Aperture is set as above.

The exposure mode is displayed in the monitor.

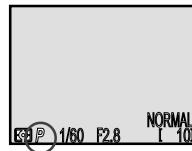

Choosing an Aperture

In aperture-priority auto and manual-exposure modes, aperture is chosen by pressing the multi selector to the left or right while holding down the  button.

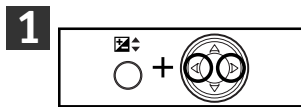

Press multi selector to left for maximum aperture (small f number), to right for minimum aperture (large f number)

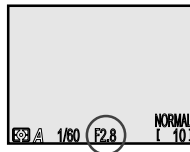

Confirm aperture setting in control panel and monitor

In aperture-priority auto, the camera automatically selects a shutter speed that will produce the best exposure. If the aperture you have selected would result in the photograph being over- or under-exposed, the aperture value displayed in the control panel and monitor will flash when the shutter-release button is pressed halfway.

Choosing a Shutter Speed

In manual mode, shutter speed is chosen by pressing the multi selector up or down while holding the  button. Options range from 8 s to $1/1000$ s in increments equivalent to 1 EV (one step). In addition, a shutter speed of "bulb" is available for long-time exposures (see tip on following page).

1

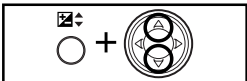

Press multi selector up for slower shutter speeds, down for faster shutter speeds

2

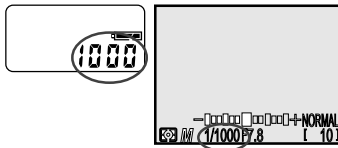

Confirm shutter speed in control panel and monitor

In manual mode, the amount the photograph would be over- or under-exposed at the selected combination of aperture and shutter speed is displayed in the monitor:

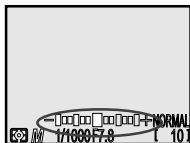

Display shows values between -2 and $+2$ EV in increments of $1/3$ EV

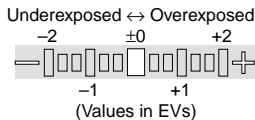





Long-time exposure

When the shutter speed is set to **bulb** (manual-exposure mode only), the shutter will remain open while the shutter-release button is pressed (maximum exposure 60 s). To reduce blurring caused by camera shake, we recommend that you use a remote shutter release (the MC-EU1 remote cord, available separately, functions as a remote shutter-release cable) and a tripod.



Shutter-speed limitations

At a CONTINUOUS setting of **Ultra HS** ( 89), the lowest available shutter speed is $\frac{1}{30}$ s. At a setting of **Movie** ( 89), shutter speed can not be set to a value slower than $\frac{1}{15}$ s. **bulb** is only available at a setting of **Single** ( 88).

Note that if the shutter is open for more than $\frac{1}{4}$ s at any setting, mottling (noise) may appear in the final photograph. At speeds of $\frac{1}{4}$ s or slower, the shutter-speed indicator in the monitor turns yellow.



What Is “Sensitivity”?



“Sensitivity” is a measure of how quickly your camera reacts to light. The higher the sensitivity, the less light needed to make an exposure, allowing the same exposure to be achieved with higher shutter speeds or smaller apertures. In a film camera, sensitivity is a characteristic of the film, not the camera. The ISO ratings you see on packages of film are a measure of their sensitivity—the higher the ISO rating, the more sensitive the film. Higher sensitivity is achieved by altering the chemical composition of the film, causing a random pattern, called “grain,” to appear in the final photograph. In a digital camera, increased sensitivity has a similar effect: higher sensitivities allow higher shutter speeds, at the expense of mottling, or “noise” (the digital equivalent of film “grain”) appearing in the final image.

Adjusting Sensitivity

In AUTO mode, the camera sets sensitivity automatically in response to lighting conditions. When the mode dial is set to P, A, M, or CSM, you can choose a fixed value for sensitivity from three possible settings. Sensitivity is set by pressing the zoom buttons while holding down the  button.

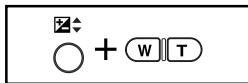
1



Press  for increased sensitivity,  for decreased sensitivity. At setting of 400, press  to select setting of AUTO.

2

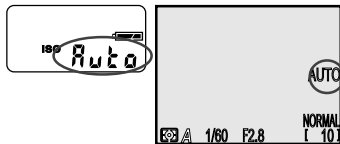

Sensitivity displayed in monitor, and in control panel while  and zoom buttons are pressed. After zoom buttons are released, ISO icon in control panel indicates that sensitivity is raised above 100.

The following settings are available:

Setting	Description
AUTO (default)	Equivalent to setting of 100 under normal conditions; when lighting is poor, however, camera automatically raises sensitivity to compensate. ISO icon appears in control panel and monitor only when sensitivity raised above 100.
100	Approximately equivalent to ISO rating of 100
200	Approximately equivalent to ISO rating of 200
400	Approximately equivalent to ISO rating of 400



Sensitivity can also be set using the **ISO** item in the shooting menu ( 98).



A slight amount of mottling (“noise”) may appear in photographs taken at settings other than 100.

If sensitivity is set to AUTO in manual exposure mode ( 72), sensitivity will be fixed at ISO 100 equivalent and will not vary with lighting conditions, ensuring that the exposure specified by the user will be achieved.

Changes to sensitivity have no effect in AUTO or SCENE operating modes.

Focusing at a Preset Distance: Manual Focus



In P, A, M, and CSM modes, manual focus can be used in place of autofocus for situations in which you know the distance to your subject. Focus distance can be selected from forty-eight preset distances, ranging from 0.04 m (0.13') to infinity, by pressing the zoom buttons while holding down the button.

1

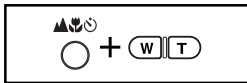

Press **W** to increase the focus distance to maximum of infinity (Inf), **T** to decrease

2



Focus distance is displayed in monitor, and in control panel while button is pressed. After zoom buttons are released, flashing and/or icons in control panel indicate that manual focus is in effect.





The focus distances available depend on the focus-mode setting (58). Focus distances of 0.04–0.4 m (0.13'–1.3') are only available at settings of (macro close-up) and (macro close-up + self-timer).

The value displayed for manual focus-distance is the approximate distance from the front of the lens. The actual focus distance may differ slightly from the value shown; check focus in the monitor before shooting.

Manual focus can be cancelled by pressing the  button.



To use the self-timer in combination with manual focus, select a focus mode of  (autofocus + self-timer) or  (macro close-up + self-timer) before choosing the focus distance.

The flash can be used while manual focus is in effect. This makes it possible to combine the flash with a focus setting of infinity.

The units used for manual focus can be chosen from meters or feet using the **Distance Units** sub-menu in the setup-mode menu ( 159).

The Shooting Menu

MENU



In P, A, M, and CSM modes, many adjustments to camera settings are made from the shooting menu. There are two shooting menus, one for P, A, and M modes, the other for CSM mode. Save where noted on the following pages, the contents of these menus are identical. Menu settings for P, A, and M modes are, however, stored separately from the settings for CSM mode. If there is a particular combination of settings you use frequently, you can turn the mode dial to P, A, or M and set the camera to these settings. The camera will “remember” this combination of settings even after being turned off, and will automatically restore the settings the next time you select any of P, A, and M modes. You can create a second combination of settings for CSM mode and switch instantly from one combination of settings to the other simply by turning the mode dial from CSM to P, A, or M.

S

To display the shooting menu:

1



Select P, A, or M (P•A•M shooting menu) or CSM (CSM shooting menu)

2



Press

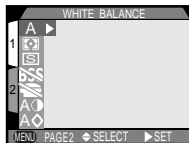

The shooting menu contains two pages of options:



Shooting Menu, Page 1



White Balance

Set white balance according to light source



81

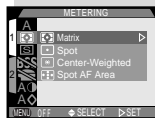

Metering

Control how camera sets exposure



85

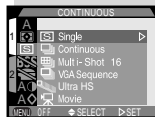

Continuous

Set camera to take photographs in sequence or make movies



88



BSS

Compensate for blurring caused by camera shake



92



Lens

Choose settings for optional lens converters



106



Image Adjustment

Modify contrast and brightness of photos; take photos in black-and-white



94

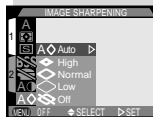

Image Sharpening

Make outlines more distinct



96



Pg. For more information on:



12 Using the menus



Shooting Menu, Page 2



Image Quality & Size

Set image quality and size for all modes

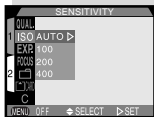

Sensitivity

Adjust sensitivity setting for current mode (mirrors setting made with button)



Exposure Options

Modify auto-exposure from the value set by the camera

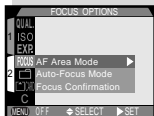

Focus Options

Autofocus options

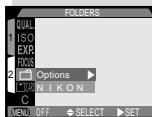

Folders

Choose folder for storing images or for playback; create, rename, and delete folders

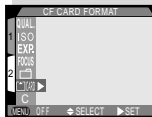

CF Card Format

Format memory card for use in COOLPIX 880



Reset Shooting Options

Reset menu settings for current mode to default values



Keeping Colors True: The White-Balance Menu





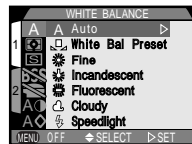

What Is “White Balance”?

The color of the light reflected by an object depends on the color of the light source. The human brain is able to detect and compensate for such changes in color, with the result that a white object will look white to humans whether viewed in sunlight, under overcast skies, or indoors under incandescent or fluorescent lighting. To a camera, however, the “whites” produced by these different sources of light vary in color, some being slightly blue and others yellow or red. A digital camera can adjust colors according to lighting so that colors that appear white to the human eye also appear white when viewed in the final photograph. This adjustment is called “white balance.”



Choosing a White-Balance Setting

In P, A, M, or CSM modes, white balance can be chosen from the WHITE BALANCE sub-menu. The following options are available:

Option	Description
 Auto	White balance automatically adjusted to suit lighting conditions. Best setting in most circumstances.
 White Bal Preset	White or neutral gray object used as reference to set white balance under unusual lighting conditions
 Fine	White balance set for direct sunlight
 Incandescent	Use when taking photographs indoors under incandescent light
 Fluorescent	Use when taking photographs indoors under fluorescent light
 Cloudy	Use when taking photographs under overcast skies
 Speedlight	White balance set to match light produced by flash

Fine-Tuning White Balance

At settings other than **A** (auto) and **▣** (preset), white balance can be “fine-tuned” by highlighting the desired setting and selecting an adjustment from a sub-menu. Adjustments can be made in the range of +3 to -3 or, in the case of **☀** (fluorescent), by selecting the type of bulb from the following sub-menu:

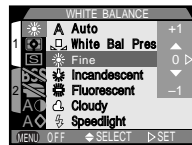

Option	Description
FL1	W (default)
FL2	N
FL3	D

Raising white-balance gives images a blue, “cold” cast; lowering white balance makes photos appear “warmer”—that is, slightly yellow or red. After selecting the desired adjustment, press the multi selector to the right to put your choice into effect.

Preset White Balance

When  (preset) is selected, the camera will zoom in and the preset white-balance menu will appear in the monitor:

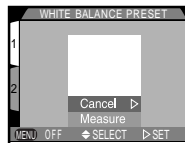

Option	Description
Cancel	Recalls the most recent value for preset white balance from memory and sets white balance to this value
Measure	Camera measures white balance, using object displayed in center of monitor as reference. To use this option, first place white or neutral gray object under lighting that will be used in final photograph, then aim camera at object and press multi selector to right (camera will zoom out, but no photograph will be taken).

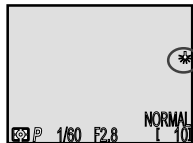

At settings other than **A** (auto), the current white-balance setting is indicated by an icon in the monitor:





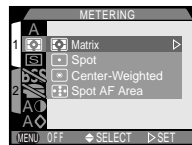



Measuring Light: The Metering Menu

The “metering method” is the method your camera uses to measure light when determining exposure. In P, A, M, and CSM modes, the METERING menu offers a choice of four metering methods:



Method	How It Works	When to Use It
 Matrix	Exposure calculated by comparing measurements from 256 areas of frame with library of typical compositions, producing best possible setting for entire frame	Best choice in most circumstances
 Spot	Camera measures light in area in center of frame occupying roughly $1/32$ of total, shown by square in center of monitor	Ensures that subject in metering target will be correctly exposed even when background very light or very dark. Can be used in combination with AE hold ( 87).

Continued overleaf

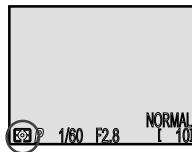
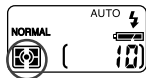

Method	How It Works	When to Use It
 Center-Weighted	Camera measures light in entire frame but assigns weight of 80% to area in center of frame occupying roughly $1/4$ of total	Classic meter for portraits; preserves background details while letting lighting conditions at center of frame determine exposure. Selected automatically when digital zoom ( 52) is used. Can be used in combination with AE hold ( 87).
 Spot AF Area	Camera measures light in current focus area only	Use to link spot metering to currently selected focus area when manual or auto focus-area selection is in effect. Equivalent to “Matrix” when focus-area selection ( 103) is off; equivalent to “Spot” when manual focus ( 76) is used.

The metering method is shown by icons in the control panel and monitor. When **Spot AF Area** is chosen, a spot-metering icon () appears in the control panel.



Auto-Exposure Hold

Spot or center-weighted metering sets exposure for the subject in the center focus area (shown by the focus target in the viewfinder) when the shutter-release button is pressed halfway. If your subject is not in the center focus area, exposure will be set for an object in the background, with the result that your main subject may be over- or under-exposed. Using AE hold, you can meter your main subject and then adjust the composition before taking the photograph.

- 1 Set metering to  (spot) or  (center-weighted)
- 2 Position the subject in the center of the frame and press the shutter-release button halfway to lock focus ( 29) and exposure.
- 3 Keeping the shutter-release button held halfway, recompose your photograph. Press the shutter-release button the rest of the way down to shoot.









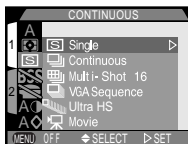

Spot AF Area metering can be used in combination with focus-area selection ( 66) to measure lighting in one of five focus areas, allowing you to meter an off-center subject without using auto-exposure hold.

Making Movies and Taking Photographs in a Sequence: The Continuous Menu

Using the CONTINUOUS menu, you can set the camera to take photographs one at a time, shoot multiple photographs in sequence, or even record short movies.



Option	Description
 Single	Camera records one photograph each time shutter-release button is fully pressed
 Continuous	Camera records photographs at rate of about three photographs every two seconds while shutter-release button is held down. Not available at image-quality setting of HI ( 38).
 Multi-Shot 16	Camera takes sixteen consecutive “thumbnail” images and combines them into collage. This option is only available at image-size setting of FULL ( 40).
 VGA Sequence	Camera takes series of photographs 640 × 480 pixels in size. Image quality ( 38) is set to NORMAL , allowing photographs to be taken at approximately two frames per second while shutter-release button is held down.

Option	Description
 <p data-bbox="147 221 263 246">Ultra HS</p>	<p data-bbox="321 107 1330 325">Camera takes seventy photographs 320 × 240 pixels in size (QVGA) each time shutter-release button is pressed. Image quality (📷 I38) is set to NORMAL, allowing photos to be taken at approximately thirty frames per second. Each sequence of photographs is saved in separate folder automatically created by camera. Folder name is composed of “N_” followed by three-digit number assigned in ascending order by camera.</p>
 <p data-bbox="165 422 241 447">Movie</p>	<p data-bbox="321 350 1330 491">Camera begins recording movie when shutter-release button is fully pressed. Movie ends after forty seconds, or when next shutter-release button is fully pressed. Movie is stored in QuickTime format (DOS file extension “.MOV”). Each frame has image quality of NORMAL and is 320 × 240 pixels in size (QVGA).</p>



At settings other than **Single**, the flash is set to “Off” (📷) and will not fire even when lighting is poor (📷 55).

At settings other than **Single** and **Movie**, the focus, exposure, and white-balance settings used for the first image apply to all other images in the same series.

Settings of **Movie** and **Ultra HS** only take effect when the monitor is on. If the monitor is turned off, the camera will revert to a setting of **Single** until the monitor is turned on. If the camera is connected to a video device at a video-mode setting of **PAL** (📷 I58), video output will be suspended while recording is in progress. Normal output will resume when recording ends.



The camera is equipped with a memory buffer for temporary storage of photos during shooting, allowing you to take several photographs in succession without waiting for the images to be transferred to the memory card. The number of images that can be stored in the buffer depends on the quality and size of the images. When the buffer becomes full, an hourglass icon (🕒) will be displayed in the monitor until enough data have been transferred to the card to allow more photographs to be taken. More photographs can be taken as soon as enough memory becomes available in the buffer. At settings of **Continuous** and **VGA Sequence**, you can continue to take photographs as long as the shutter-release button is held down, although the rate at which photographs are taken will drop when the buffer fills up.



While images are being transferred from the buffer to the memory card for permanent storage, the green AF lamp next to the viewfinder will blink. *Do not remove the memory card from the camera while the AF lamp is blinking.* Doing so could result in loss of data or in damage to the camera or the card. Be sure that the camera is off before you remove the memory card.



When battery power is low, ten is the maximum number of shots that can be taken in a single sequence at settings of **Continuous** and **VGA Sequence**.



The CONTINUOUS setting is shown by icons in the control panel and monitor.

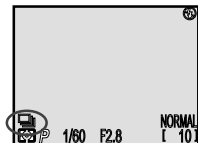

Continuous

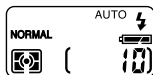

Single



Multi-shot 16



VGA sequence



Ultra HS (exposure-count display shows number of seventy-exposure sequences remaining)



Movie (exposure-count display shows number of seconds that can be recorded)



Getting Sharper Photographs: The BSS Menu

“Best-shot selection” (BSS) compensates for camera movement. It is most effective in situations in which inadvertent camera movement may affect the outcome of the photograph, for example when:

- the camera is zoomed in or you are using a teleconverter lens attachment
- you are using macro close-up
- shutter speed is low

BSS may not produce the desired results with a moving subject or if you change the composition during shooting.

The options in the BSS sub-menu are:



Option	Description
Off	BSS off; one photo taken each time shutter-release button is fully pressed
On	Camera shoots photos as long as shutter-release button is held down (maximum 10). These images are then compared and sharpest photo (photo with highest level of detail) saved to memory card.



When BSS is on, a BSS icon is displayed in the monitor.

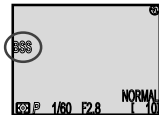

When photographs are taken with BSS on, the focus, exposure, and white-balance settings used for the first photograph apply to all images in the same sequence.

The flash is set to “Off” (🔌) when BSS is on (📷 55).

BSS is not available at:

- CONTINUOUS settings other than **Single** (📷 88)
- an image-quality setting of **HI** (📷 138)





Selecting any of the above options automatically cancels BSS. BSS can not be selected while the above options are in effect.





Contrast, Brightness, and Image Type: The Image Adjustment Menu

When you take a photograph, the camera automatically performs image compensation for optimal brightness and contrast before recording the photograph to the memory card. The image-adjustment sub-menu gives you control over this image compensation operation, allowing you to control not only brightness and contrast, but also to produce monochrome images. The following options are available:



Option	Description
 Auto	Camera adjusts brightness and contrast for optimal results; adjustment performed differs from image to image (this setting is automatically selected in AUTO mode)
 Normal	Camera performs same standard brightness and contrast adjustment on all images (default setting). This setting is recommended for images that will later be re-touched on a computer.
 More Contrast	Image processed to increase difference between light and dark areas
 Less Contrast	Image processed to reduce difference between light and dark areas
 Lighten Image	Increases brightness of mid-tones in image, without affecting detail in highlights or shadows. This setting can be used on images that will be output on computer monitor or printer if device tends to produce images that are too dark.

Option	Description
 Darken Image	Decreases brightness of mid-tones in image, without affecting detail in highlights or shadows. This setting can be used on images that will be output on computer monitor or printer if device tends to produce images that are too bright.
 Black & White	Image converted to black and white. Black-and-white images require same amount of memory as color images, but show higher level of detail. When this option is in effect, view through lens shown in monitor is in black and white. White-balance settings (📷 81) and digital zoom (📷 52) can not be used while this option is in effect.



An image-adjustment icon appears in the monitor at settings other than **Normal** and **Auto**.

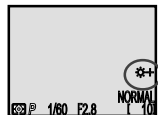





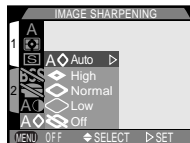

Only one image adjustment setting can be used at a time. Selecting a new image-adjustment option cancels the previous setting.

The effects of adjustments to brightness and contrast are not visible in the monitor.

Making Edges More Distinct: The Image Sharpening Menu

When you take a photograph, the camera automatically outlines edges, making the image appear sharper. The image-sharpening sub-menu gives you control over the amount of sharpening performed. The following options are available:



Option	Description
 Auto	Camera sharpens edges for optimal results; adjustment performed differs from image to image
 High	Image processed to increase sharpness, making edges more distinct
 Normal	Camera performs same standard sharpening on all images
 Low	Amount of sharpening reduced below normal level
 Off	No sharpening performed





The effects of sharpening are not visible in the monitor.

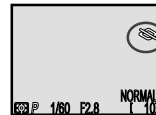

A sharpening icon appears in the monitor at settings other than **Normal**.



Modifying Sensitivity from a Menu: The ISO Menu

The ISO menu mirrors the sensitivity (ISO equivalency) value set with the  button in combination with the zoom buttons ( 74). As with the  button, sensitivity can be set to AUTO, 100, 200, or 400. Choosing a new sensitivity value from the **ISO** sub-menu changes the value selected with the  and zoom buttons, while changing the sensitivity value with the  button changes the value selected in the **ISO** sub-menu.

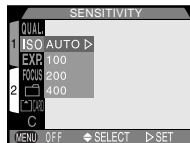

S

Exposure Options

The exposure options sub-menu provides control over exposure.

Exposure Mode (CSM)

When the mode dial is set to CSM, you can choose the exposure mode from the **Exposure Mode** sub-menu. For more information on exposure mode, see "Choosing a Mode" ( 69).

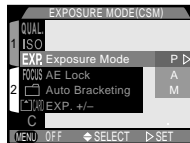
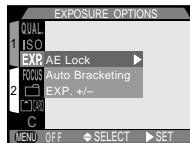

Taking Multiple Photographs with the Same Exposure: AE Lock

When taking a series of photographs that you will later join into a single image (for example, when taking shots that will later be joined to form a panorama or a 360° virtual-reality image), you will need to use the same exposure, sensitivity, and white-balance settings for each of the images in the series. This is possible using the AE-lock menu.

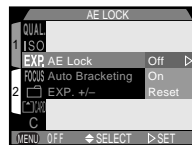

Option	Description
On	First photograph taken after On is selected sets exposure for all subsequent photographs. If white balance is set to A (auto), white balance for first photograph applies to all other photographs in series. While AE lock is in effect, flash will be set to “Off” (⚡).
Off	Restores normal exposure, sensitivity, and white balance
Reset	Clears existing exposure, sensitivity, and white-balance settings. First photograph taken after this option is selected sets exposure, sensitivity, and auto white balance for all subsequent photographs.



While AE lock is in effect, **AE-L** (AE Lock) and **WB-L** (White-Balance Lock) icons appear in the monitor. If **Reset** is chosen or white balance, focus mode, shutter speed, or aperture adjusted, these icons will turn yellow to indicate that exposure will be reset with the next shot.

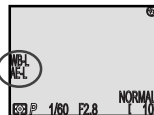

Varying Exposure over a Series of Photographs: Auto-Exposure Bracketing

When using exposure compensation (☰ 64), you may be unsure of the appropriate exposure-compensation value for your subject, and yet not have time to check the results and change the compensation value after each shot. Auto-exposure bracketing allows you to vary exposure by $\frac{1}{3}$ EV over a series of five photographs without the need to adjust exposure compensation manually.

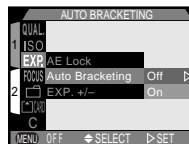

Option	Description
Off	Restores normal auto exposure
On	Camera varies shutter speed to modify exposure in order $+\frac{2}{3}$ EV, $+\frac{1}{3}$ EV, ± 0 EV, $-\frac{1}{3}$ EV, $-\frac{2}{3}$ EV with each photograph taken after On is selected. Values are added to normal exposure-compensation value.



While bracketing is in effect, the exposure modification appears with a **BKT** icon in the monitor, and the ☑ icon in the control panel flashes.

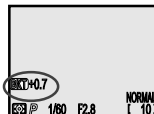



At settings of **Continuous** and **VGA Sequence** (📷 88), shooting pauses after each series of five photographs has been taken.

When the flash is set to "Auto" (📷 56), the flash setting for the first photograph in each sequence of five photographs applies to the remaining four. If the flash is used for the first photograph, it will be used for the next four; if it is not used for the first photograph, it will not be used for the next four.

If sensitivity is set to AUTO (📷 74), the sensitivity value used for the first photograph in each series of five photographs applies to the remaining four.

Auto-exposure bracketing starts over from $+2/3$ EV when changes are made to any of the following:

- the flash setting (📷 55)
- sensitivity (📷 74)
- exposure compensation (📷 64)

Auto-exposure bracketing can not be used in combination with:

- CONTINUOUS settings of **Multi-Shot 16**, **Ultra HS**, or **Movie** (📷 88)
- best-shot selection (📷 92)
- the **AE Lock** option in the EXPOSURE OPTIONS sub-menu (📷 99)





Choosing any of the above options cancels auto-exposure bracketing.

Auto-exposure bracketing can also be cancelled by:

- selecting **Off** from the **Auto Bracketing** sub-menu
- turning the camera off



Modifying Exposure Compensation from a Menu: Exp. +/-

The **Exp. +/-** item in the EXPOSURE OPTIONS menu mirrors the exposure-compensation value set with the  button and multi-selector ( 64). As with the  button, exposure compensation can be set to values between +2.0 EV and -2.0 EV in increments of $\frac{1}{3}$ EV. Choosing a new exposure compensation value from the **Exp. +/-** sub-menu changes the value selected with the  button, while changing exposure compensation with the  button changes the value selected in the **Exp. +/-** sub-menu.

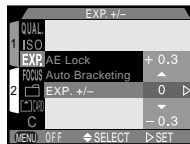

Focus Options

The focus options sub-menu provides control over focus settings.

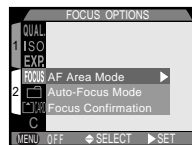

Focus-Area Selection: AF Area Mode

This setting determines how the camera will choose the focus area in P•A•M or CSM modes. The following options take effect while the monitor is on (when the monitor is off, AF-area mode is automatically set to **Off**):

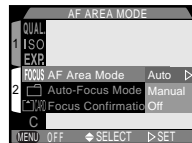

Option	Description
Auto	Camera automatically selects focus area containing subject closest to camera. Active focus area displayed in red when shutter-release button pressed halfway. This setting is useful when you have little time to compose photographs.
Manual	User selects focus area manually (📷 66). This option can be used in place of focus lock when subject is not at center of final composition.
Off	Center focus area (shown by focus target in viewfinder) is used. No focus areas appear in monitor. This option can be used in combination with focus lock to focus on off-center subject (📷 29).

Autofocus Mode

In P•A•M and CSM modes, you can choose the autofocus mode used when the monitor is on (when the monitor is off, single autofocus is used, regardless of the setting in the autofocus mode sub-menu). See “Beyond Point and Shoot: Focusing Near and Far” for more information on autofocus (📖 58).

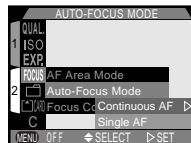

Option	Description
Continuous AF	Camera adjusts focus continuously; focus is locked when shutter-release button is pressed halfway and remains locked as long as shutter-release button is held in this position (📖 29)
Single AF	Camera focuses when shutter-release button is pressed halfway; focus is locked as long as shutter-release button is held in this position. Choose this option to save batteries.

Focus Confirmation

Use focus confirmation when you want to know exactly what areas of the frame will be in focus before you take the final photograph. Focus confirmation affects only the view through the lens shown in the monitor; no indicators of focus appear in the final photograph.

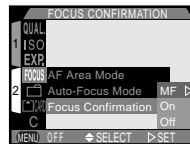







Option	Description
MF (Manual Focus)	Objects that are in focus will be sharply outlined in monitor when manual focus is used (📷 76)
ON	Objects that are in focus will be sharply outlined in monitor in all focus modes
OFF	No indication of focus is given

Settings for Optional Lens Converters

When the UR-E2 step down ring lens adapter (available separately) is attached to the camera lens, optional lens converters for wide-angle, telephoto, and fisheye photography can be used with the COOLPIX 880. An adapter for taking photographs of film positives is also available. Each of these converters is adapted to a particular combination of settings, including focus mode, zoom position, and metering method. Using the lens sub-menu, you can select combinations of settings suited to particular lens converters.



Option	Description
 Normal	No modifications are made to settings. Use this option when no lens converter is attached.
 Wide Adapter (for WC-E24 and WC-E63 wideangle converters)	<ul style="list-style-type: none">• Camera zooms out to widest angle (📷 52)• Flash disabled (📷 55)
 Telefoto I (for TC-E2 2× telephoto converter)	<ul style="list-style-type: none">• Camera zooms in to maximum optical-zoom position (📷 52)• Optical zoom (📷 52) adjustable between maximum position (24 mm) and third step in monitor zoom display (14 mm)• Flash disabled (📷 55)

Option	Description
 Telefoto2 (for TC-E3ED 3× telephoto converter)	<ul style="list-style-type: none"> • Zoom fixed at maximum optical zoom position (📷 52) • Flash disabled (📷 55)
 Fisheye I (for FC-E8 fisheye converter)	<ul style="list-style-type: none"> • Zoom fixed at maximum optical zoom position (📷 52) • Focus fixed at infinity (📷 58) • Metering method fixed at center-weighted (📷 85) • Flash disabled (📷 55) • Four corners of frame blacked out to create circular frame
 Fisheye2 (for FC-E8 fisheye converter)	<ul style="list-style-type: none"> • Zoom fixed at maximum optical zoom position (📷 52) • Flash disabled (📷 55) • Image fills entire frame
 Slide Copy Adptr (for ES-E28 slide-copying adapter)	<ul style="list-style-type: none"> • Optical zoom (📷 52) adjustable between maximum position (24 mm) and third step in monitor zoom display (14 mm) • Focus mode fixed at macro close-up (📷 58) • Flash disabled (📷 55)

For details of use and handling, refer to the documentation provided with your lens converter.



A lens converter icon appears in the monitor at settings other than **Normal**.

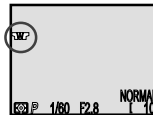

Restoring Default Shooting Settings: The Reset Menu

In P, A, M and CSM modes, a reset option is available to restore settings in the P•A•M and CSM SHOOTING menus to their default values. Only settings in the selected menu are affected; the reset option in the P•A•M menu clears shooting settings for P, A, and M modes but has no effect on CSM settings, while the reset option in the CSM menu clears settings in the CSM SHOOTING menu without changing settings in the P•A•M menu.

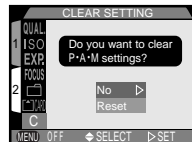

To reset shooting options in either the P•A•M or CSM menus, select **C** (clear settings) from the menu for the appropriate mode. Both menus contain the following options:

Option	Description
No	Exit menu leaving settings unchanged
Reset	Restore settings to default values

Choosing **Reset** in the P•A•M or CSM menus restores the following options to their default values:

Setting	Default
White Balance	Auto
Metering	Matrix
Continuous	Single
BSS	Off
Lens	Normal
Image Adjustment	Normal
Image Sharpening	Auto
Sensitivity	Auto

Setting	Default
Exposure Mode (CSM only)	P
AE Lock	Off
Auto Bracketing	Off
Exp. +/-	±0
AF Area Mode	Auto
Autofocus Mode	Continuous AF
Focus Confirm	MF

Settings common to all modes (image quality and size and the folder selected for recording or playback) are not affected. To reset settings for all modes to their default values, select **Reset All** from the SETUP-mode menu (📷 | 60). All the settings listed above for both P•A•M and CSM will be reset, as will folder settings, image quality, image size, and other settings in the SET-UP mode menu.

This chapter details the operations that can be performed when the mode dial is set to . These include:

- playback of photographs stored on the memory card, either singly or in “contact sheets” of nine or four thumbnail images
- display of detailed photo information
- zooming in on images to view fine details
- deleting individual photographs

The above operations can be performed using the buttons on the back of the camera. In addition, the following operations can be performed from the playback menu:

- deleting multiple photographs
- “slide shows,” or automated sequential display of the photographs in memory
- protecting photographs from deletion
- hiding photographs
- creating electronic print orders in Digital Print Order Format (DPOF)



Basic Playback

When the mode dial is turned to , the camera enters playback mode with the most recent photograph displayed in the monitor. This section covers the operations that can be performed in playback mode using the buttons on the rear of the camera.

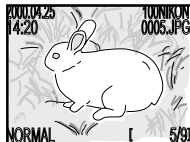
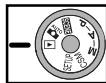

Only photographs in the current folder are displayed. If there are no photographs in the current folder, the message “CARD CONTAINS NO IMAGE DATA” will be displayed in the monitor. To select another folder for playback, or to view photographs in all folders, use the **Folders** item in the playback menu.

In single-image playback, photographs are displayed briefly at low resolution while being read from memory. This makes it possible to scroll rapidly through the photographs in memory without waiting for each image to be displayed at full resolution.



Pg. For more information on:





126 Selecting a folder for playback

Single-Image Playback

Selecting a Photograph

Use the multi selector to page through the photographs in memory one at a time.





Operation	Function
 Press up or left	View photograph recorded before current photograph
 Press down or right	View photograph recorded after current photograph





To scroll quickly to a particular frame number without viewing intervening photos, press and hold the multi selector in one of the four directions. The photograph displayed will not change, but the frame number at the bottom right corner of the monitor will increase or decrease rapidly. Release the selector when the desired frame number is reached.

The first and last photographs in memory are linked. Pressing the multi selector up or to the left while the first photo in memory is displayed takes you to the last photo. Pressing the multi selector down or to the right while the last photo is displayed takes you to the first photo.

Viewing Photo Information (

Photo information is superimposed on photographs displayed in single-image playback. There is a total of five pages of information for each photo. Press the  (  ) button to cycle through photo information as follows: Page 1 ⇒ Page 2 ⇒ Page 3 ⇒ Page 4 ⇒ Page 5 ⇒ Page 1.

Page 1

1	0000.04.25	100NIKON	5
2	14:20	0005.JPG	6
3	VGA		7
4	NORMAL	 5/5	8
			9

- 1 Date of recording
- 2 Time of recording
- 3 Image size
- 4 Image quality
- 5 Folder
- 6 File number and type
- 7 Print-order icon
- 8 Protect icon
- 9 Frame number/total number of frames visible in current folder

Page 2

CAMERA	:	E990
FIRMVER	:	E990 V1.0
METERING	:	MATRIX
MODE	:	P
SHUTTER	:	1/60
APERTURE	:	F2.7
EXP +/-	:	0.0
FOCAL LENGTH	:	8.2mm
FOCUS	:	AF

- Camera type
- Firmware version
- Metering method
- Exposure mode
- Shutter speed
- Aperture
- Exposure compensation
- Focal length
- Focus mode or manual focus distance

Page 3

SPEED LIGHT	:	OFF
IMG ADJUST	:	AUTO
SENSITIVITY	:	100
WHITEBAL	:	AUTO
SHARPNESS	:	AUTO
DIGITAL TELE	:	X1.0
CONVERTER	:	OFF
FILE SIZE	:	673KB

- Flash status
- Image adjustment
- Sensitivity (ISO equivalency)
- White balance
- Sharpening
- Digital zoom
- Lens-converter status
- File size (kilobytes)

Page 4 (histogram)

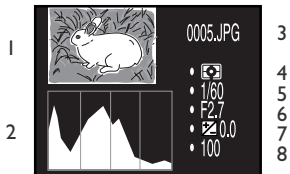

- 1 Thumbnail preview (flashing border marks image highlights, or brightest areas of image)
- 2 Histogram (shows distribution of tones in image: horizontal axis gives pixel brightness, with dark tones to left and bright tones to right, while vertical axis shows number of pixels of each brightness in image)
- 3 File number and type
- 4 Metering method
- 5 Shutter speed
- 6 Aperture
- 7 Exposure compensation
- 8 Sensitivity (ISO equivalency)

Page 5 (focus confirmation)

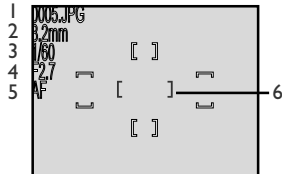



- 1 File number and type
- 2 Focal length
- 3 Aperture
- 4 Shutter speed
- 5 Focus mode or manual focus-distance
- 6 Focus confirmation (portions of image in focus sharply outlined; active focus area shown in red)

Zoom Q (T)

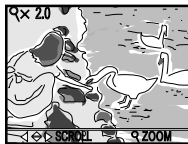
Use the Q (T) button to zoom in on photographs displayed in single-image playback.





Operation	Function
 Press	Zoom photograph in. Zoom increases each time button is pressed, to maximum of 4.0x. While image is zoomed in, Q indicator and zoom factor are displayed in monitor.
 Press	Cancel zoom
Press up, left, down, or right	Scroll to another area of image





To use the multi selector to view other photographs in memory, first cancel zoom by pressing the  button.

Movie Playback (QUICK)

In single-image playback, movie files are indicated by a  icon in the lower left corner of the display. Movie playback is controlled by the  (QUICK ) button.





Operation	Function
 Press	Start movie. While movie is in progress, press to pause movie; press again to resume movie playback.
 Press up or left	While movie is in progress: end playback and display previous photo While movie is paused: go back one frame
 Press down, or right	While movie is in progress: end playback and display next photo While movie is paused: go forward one frame



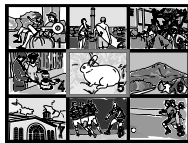

Viewing Multiple Images: Thumbnail Playback (⚡👁)

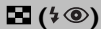
The thumbnail menu can be used to select photographs or movies for viewing.



Operation	Function
 Press	Press once to display nine thumbnail images, or twice to display four thumbnail images. Press again to view highlighted thumbnail at full size.
 Press up, left, down, or right	Highlight thumbnail (press up/left when first thumbnail highlighted to view last page of thumbnails, down/right when last thumbnail highlighted to view first page of thumbnails)
 Press	Select highlighted thumbnail for deletion

Deleting Individual Photographs ()

To delete the photograph or movie currently on display in single-image playback, or to delete the currently selected thumbnail, press the  () button.

Full-screen
review

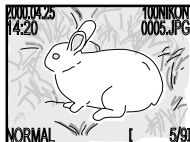

Press  ()
button



Thumbnail
review

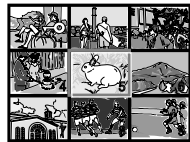

Delete dialog is displayed. Press multi selector up or down to highlight option, press to right to select.

- Select **Yes** to delete photograph
- Select **No** to save photograph and return to shooting mode

The Playback Menu

MENU



The playback menu contains options for deleting images, folders, and print-order files, for protecting images from deletion or hiding images during playback, and for playing photographs back one after the other in automatic "slide shows." You can also create digital "print orders" for printing photographs on a device compatible with the Digital Print Order Format (DPOF), and set the length of time before the monitor turns off automatically in playback mode.

To display the playback menu:

1

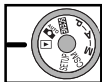

Select

2



Press

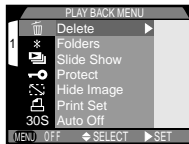

Pg. For more information on:



12 Using the menus

The playback menu contains the following options:

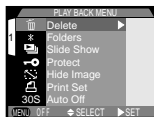

Playback Menu

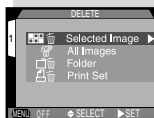

Delete

Delete all or selected photos; delete folders and print orders

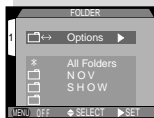

Folders

Select folder from which photos will be played back; create, rename, and delete folders



Slide Show

Automated playback of photos in current folder



Protect

Protect images from deletion



Hide Image

Hide images during playback

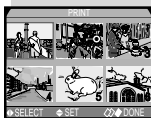

Print Set

Create digital print-order files



Auto Off

Set time limit before monitor turns off automatically in playback mode



Deleting Photographs: The Delete Menu

Using the **Delete** option in the playback menu, you can:

- delete selected photographs
- delete all photographs
- delete folders
- delete print-order files created with the **Print Set** option

Note that, once deleted, photographs can not be recovered. Be sure to back up any photographs you want to keep.



Deleting Selected Photographs

To delete selected photographs, choose **Selected Images** from the **Delete** sub-menu.



1



Highlight
Selected Images



2



Press to right to
display menu of
thumbnail images

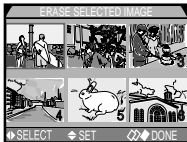

3



Press to left or
right to highlight
desired thumbnail

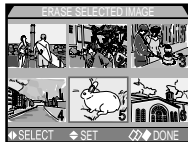

Pg. For more information on:



132 Deleting print-order files

4

Press up or down to select image for deletion (selected images marked by  icon). Repeat steps 3 and 4 to select more images for deletion. To deselect thumbnail, highlight and press multi selector up or down.

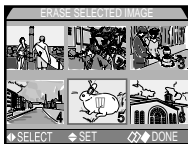
**5**

Press



Confirmation dialog displayed:

- Select **Yes** to delete all selected images
- Select **No** to return to playback menu without deleting images



Photos hidden with the **Hide Image** option are not displayed in the thumbnail menu and can not be deleted. Thumbnails marked with a  icon are protected and can not be selected for deletion.

Deleting All Photographs

To delete all photographs on the memory card:

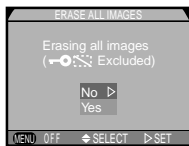

Confirmation dialog displayed:

- Select **Yes** to delete all images on memory card (images that are hidden or protected will not be deleted)
- Select **No** to return to playback menu without deleting images

Deleting Folders

To delete a folder and all images it contains:

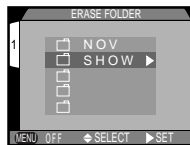
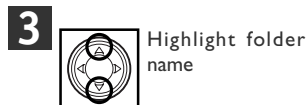
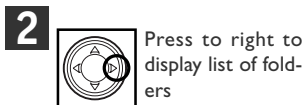
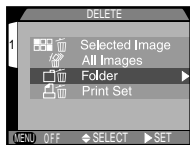

4

Press to right

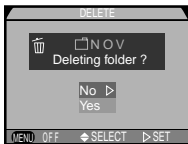

Confirmation dialog displayed:

- Select **Yes** to delete selected folder
- Select **No** to return to playback menu without deleting folder



Folder NIKON can not be selected for deletion.

If the selected folder contains hidden or protected images, the folder will not be deleted. Any images it contains that are neither hidden nor protected will, however, be deleted.



Each series of seventy photographs taken at a setting of **Ultra HS** is stored in a separate folder with a name consisting of "N_" followed by a three-digit number assigned by the camera. The **Delete Folder** item can be used to delete the entire series at once.

Selecting a Folder for Playback: The Folders Menu

The **Folders** item in the playback menu can be used to select images in all folders for playback, or images in a selected folder:

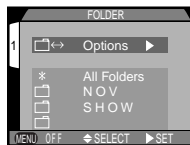

1



Highlight desired folder. To view images in all folders, select **All Folders**.

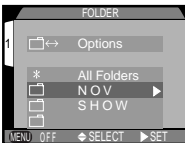

2



Press to right

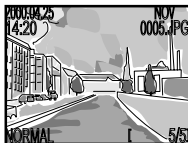

Most recent photograph in selected folder is displayed



Each series of seventy photographs taken at a setting of **Ultra HS** is stored in a separate folder with a name consisting of "N_" followed by a three-digit number assigned by the camera. To view photographs taken at this setting, select the appropriate folder from the **Folders** menu.



Pg. For more information on:



142 Folder options

Automated Playback: The Slide-Show Menu

The slide-show option in the playback menu allows unattended sequential playback. All images in the current folder that have not been hidden using **Hide Image** will be played back one after the other, with a pause between each image.

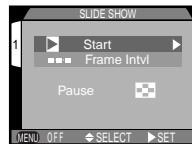

Starting a Slide Show

1



Highlight **Start**

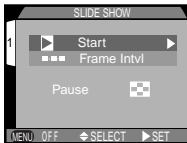

2



Press to right





Photographs displayed one-by-one in order recorded, starting from oldest photo. Photos hidden using **Hide Image** option will not be displayed.



Any movies in the slide show will be played back as still images showing the movie's first frame.

The following operations can be performed while a slide show is in progress:

Operation	Function
 Press	Pause slide show
MENU  Press	End slide show and return to single-image playback

Restarting a Slide Show

Once the slide show comes to an end, or while the slide show is paused, the dialog shown at right will be displayed. Select **Restart** to restart, or **Frame Intvl** to change the length of time each image is displayed. Press the MENU button to end the slide show and return to single-image playback.

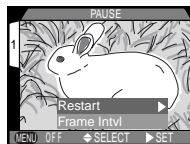

If no operations are performed during the slide show, the monitor will turn off after thirty minutes.

Changing the Display Interval

When **Frame Intvl** is selected, either from the slide-show sub-menu or the pause screen, a menu of interval settings appears. To change the length of time each image is displayed, highlight the desired setting and press the multi selector to the right.

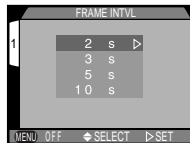

Owing to differences in the file size of the images in the slide show and the speed at which they can be read from the memory card, the actual interval may differ from the value shown in the interval menu.

Safeguarding Valuable Images: The Protect Menu

The **Protect** option in the playback menu is used to protect images from accidental deletion. Protected files can not be deleted in single-image playback or from the **Delete** sub-menu. Note that even protected files will be deleted when the memory card is formatted.

1



Press to left or right to highlight desired thumbnail

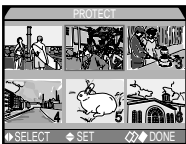

2



Press up or down to select image for protection

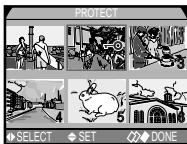

Selected images are marked by  icon. Repeat steps 1 and 2 to select more images. To deselect, highlight and press multi selector up or down.

3



Press to complete operation



To exit without changing protect status of images, press MENU button

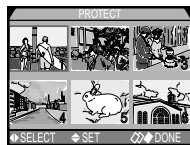

Hiding Images During Playback: The Hide-Image Menu

When creating a slide show or showing photographs to an audience, you may want to use the **Hide Image** option to hide some of the photographs in the current folder. Hidden images are only visible in the **Hide Image** menu. They can not be deleted in single-image playback or from the **Delete** sub-menu.

1



Press to left or right to highlight desired thumbnail

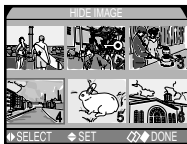

2



Press up or down to select image to be hidden

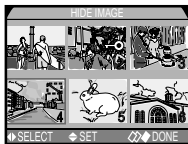

Selected images are marked by  icon. Repeat steps 1 and 2 to select more images. To deselect, highlight and press multi selector up or down.

3



Press to complete operation

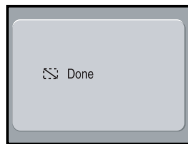

To exit without changing hidden status of images, press MENU button

Preparing Photographs for Printing: The Print-Set Menu

The **Print Set** option in the playback menu is used to create digital “print orders” that specify the photographs to be printed, the number of prints, and the information to be included with each print. This information is stored on the memory card in Digital Print Order Format (DPOF). The card can then be removed from the camera and inserted in a DPOF-compatible device—whether your personal photo printer or a photofinisher’s print system—and the selected images printed directly from the card.

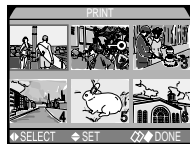

1



Press to left or right to highlight desired thumbnail

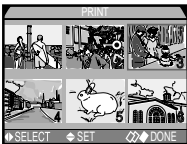

2



Press up to select image for printing. Selected images are marked by  icon.

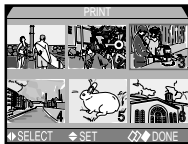

To delete print-order files when they are no longer needed, select **Print Set** from the **Delete** sub-menu.

3

Use multi selector to change number of prints. Press up to increase (maximum of 9), down to decrease. To deselect, press multi selector down when number of prints is 1. Repeat steps 1–3 to select more images.

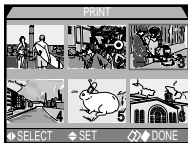
**4**

Press

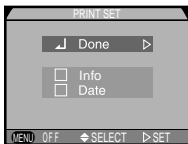

Menu of print options displayed

- To print shutter speed and aperture on all selected photographs, highlight **Info** and press multi selector to right to check item
- To print date of recording on all selected photographs, highlight **Date** and press multi selector to right to check item
- To deselect checked options, highlight and press multi selector to right
- To complete print order and return to playback, highlight **Done** and press multi selector to right. To exit without altering print order, press MENU button.



Only one print-order file can be stored on a single memory card.

Camera Setup

The Setup Menu

This chapter details the options available in the SETUP-mode menu, where you make changes to basic camera settings, and perform such tasks as formatting memory cards. The SET-UP menu can also be used to set image quality and size and choose a folder for storing images and for playback. Some of the options in the setup menu can also be accessed from the P•A•M, CSM, and playback menus.

The SET-UP menu is displayed automatically when the mode dial is turned to SETUP.

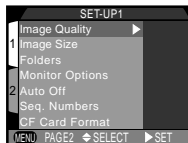
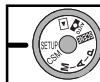

SETUP



Pg. For more information on:



12 Using the menus

The setup menu contains two pages of options:

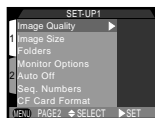

Setup Menu, Page 1



Image Quality

Choose image-quality setting for all modes



Image Size

Choose image size for all modes



Folders

Select folder for storing images or for playback; create, rename, and delete folders



Monitor Options

Turn review and preview on or off; adjust monitor brightness and hue

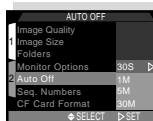

Auto Off

Set time limit before monitor turns off automatically in shooting mode

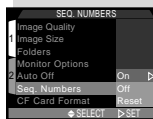

Seq. Numbers

Control automatic file naming



CF Card Format

Format memory cards for use in COOLPIX 880



Setup Menu, Page 2

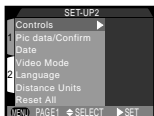

Controls

Specify what settings are restored when camera turned on



155



Pic Data/Confirm

Save photo information in text format; control visual shutter-release confirmation



156



Date

Set date and time



158

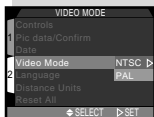

Video Mode

Choose standard used for video output from NTSC and PAL



158

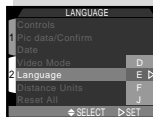

Language

Choose language for menus and messages



159

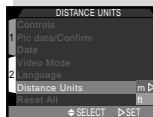

Distance Units

Choose units used for manual focus from meters and feet



159

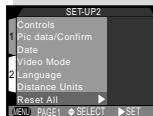

Reset All

Reset menu settings for all modes to default values



160

Controlling the (File) Size of Photographs: Image Quality and Size

Image quality and size together determine the file size of photographs taken with the camera. This in turn determines how many photographs can be stored on a single memory card. The number of images that can be stored on 8 MB, 16 MB, 64 MB, and 96 MB cards at different combinations of image quality and size is illustrated in the following table:

Quality	Size											
	FULL				XGA				VGA			
	8 ^{MB}	16 ^{MB}	64 ^{MB}	96 ^{MB}	8 ^{MB}	16 ^{MB}	64 ^{MB}	96 ^{MB}	8 ^{MB}	16 ^{MB}	64 ^{MB}	96 ^{MB}
HI	0	1	6	10	—	—	—	—	—	—	—	—
FINE	5	10	40	61	19	40	159	239	48	100	392	588
NORMAL	10	20	81	121	38	79	311	446	91	187	734	1101
BASIC	19	40	159	239	73	151	590	885	161	333	1302	1952

The Image-Quality Menu

To reduce memory requirements, images are compressed using JPEG compression. JPEG compression analyzes images in blocks of 8×8 pixels and selectively reduces detail within each block. At higher compression ratios the block pattern becomes more visible and there may be noticeable loss of detail. The actual effect depends on the size of the image when reproduced on a monitor or printer and on the type of subject.

You can control the amount of compression using the image-quality sub-menu. Image-quality settings can be accessed from the SETUP-mode menu and the **Image Size & Quality** sub-menu in the P•A•M and CSM SHOOTING menus (📷 78). Changes to image quality in any of these menus apply to all modes. Note, however, that an image-quality setting of **HI** becomes **FINE** in AUTO and SCENE modes, reverting to **HI** when the mode dial is turned to P, A, M, or CSM.



The following image-quality settings are available:

Option	File Format	Description
HI	TIFF	No compression, maximum quality
FINE	JPEG	File size reduced to roughly $\frac{1}{4}$ of original
NORMAL	JPEG	File size reduced to roughly $\frac{1}{8}$ of original
BASIC	JPEG	File size reduced to roughly $\frac{1}{16}$ of original

While a setting of **NORMAL** represents the best trade-off between file size and image quality in most cases, a setting of **BASIC** can be used to save memory or create smaller files suitable for electronic distribution. Settings of **HI** or **FINE** are suitable for photographs that will be enlarged or printed at high resolution.



The current image-quality setting is displayed in the control panel and monitor.

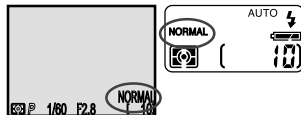

The Image Size Menu

The image-size menu controls the physical dimensions of the image, measured in pixels. Image size can be adjusted from the SETUP-mode menu and the **Image Size & Quality** sub-menu in the P•A•M and CSM SHOOTING menus (📄 78). Changes to image size in any of these menus apply to all modes.

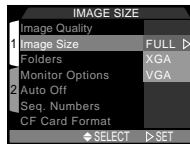

The following image sizes are available:

Option	Size (Pixels)	Notes
FULL	2048 × 1536	—
XGA	1024 × 768	Not available at image quality of HI
VGA	640 × 480	Not available at image quality of HI





At settings of **XGA** and **VGA**, the current image size is displayed in the monitor and the image-quality indicator in the control panel flashes.

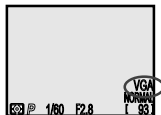
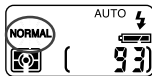

Organizing Your Photographs: The Folders Menu

By default, photographs are stored on the memory card in a folder labeled NIKON. To make it easier to locate photographs during playback, you can create additional folders and organize photographs by theme. The **Folders** sub-menu is used to create, rename, and delete folders, and to select the folder in which subsequent photographs will be stored or from which photographs are played back.

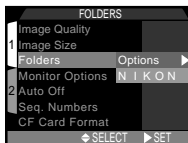



The camera file system conforms to the Design Rule for Camera File Systems (DCF). Under this system, folder names consist of a three-digit folder number followed by the folder name (e.g., "100NIKON"). Each folder can hold a maximum of 200 images (it may hold less, depending on the size of the memory card and other factors). Should a folder fill up, another folder will automatically be created with the same name but a different folder number (e.g., "101NIKON"). For most purposes, the folder number can be ignored—when viewed from the camera, folders with the same name but different folder numbers are the same folder. For example, the camera shows the folders "100NIKON" and "101NIKON" as the single folder "NIKON" with no folder number. When the memory card is viewed on a computer, however, folders with the same name but different folder numbers will be treated as separate folders (see the *Nikon View Reference Manual* for details). If you have trouble locating a photo on a computer, you can play it back on the camera, where the folder number and name are shown in the photo-information display.

Creating, Renaming, and Deleting Folders: The Folder Options Menu

The folder options menu can be used to create, rename, or delete folders.

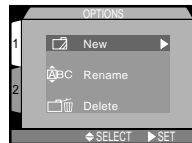

Creating New Folders

1



Highlight **New**

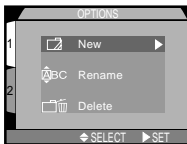

2



Press to right

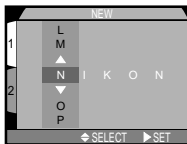

3



Press to left or right to highlight letter

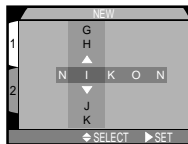

4



Press up or down to edit selected letter

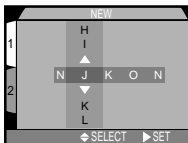

Folder name can include uppercase letters (“A”–“Z”), numbers, and spaces. Repeat steps 3 and 4 to create new five-letter folder name.

5

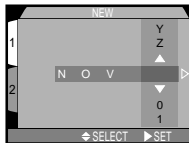

Highlight last letter and press multi selector to right to create new folder. Press MENU button to exit without creating folder.

Until a different folder is selected from the **Folders** menu, all subsequent photographs will be stored in the new folder.

Renaming Existing Folders

1



Highlight **Rename**

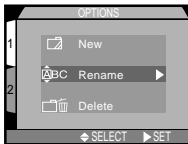

2



Press to right to display list of folders

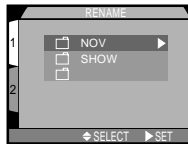

3



Highlight folder name

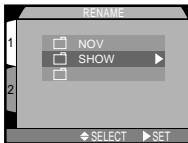

4



Press to right

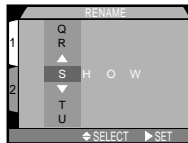

Edit name as described in steps 3–5 of “Creating New Folders” on preceding pages

Deleting Folders

1 Highlight **Delete**

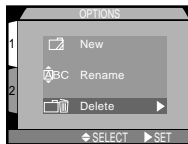

2 Press to right to display list of folders

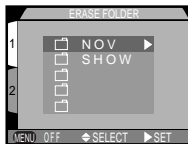

3 Highlight folder name (folder NIKON not available for deletion)



4 Press to right

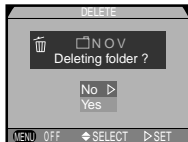

- Select **Yes** to delete selected folder
- Select **No** to return to playback menu without deleting folder

SETUP



If the selected folder contains hidden or protected images, the folder will not be deleted. Any images it contains that are neither hidden nor protected will, however, be deleted.

Choosing a Folder

Once additional folders have been created, you can select the folder that will be used for playback or to store photographs in all modes. The folder can be chosen using the **Folders** item in the playback menu or from the **Folders** sub-menu in SETUP, P, A, M, and CSM modes. Until a new folder is selected, all subsequent images will be stored in this folder; which will also be used for playback.

1



Highlight folder name



2



Press to right

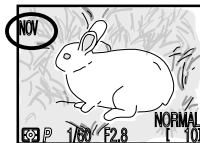

Folder name shown in monitor (no folder name displayed when NIKON is selected)

SETUP



Each series of seventy photographs taken at a setting of **Ultra HS** is stored in a separate folder with a name consisting of "N_" followed by a three-digit number assigned by the camera. The **Folders** menu can be used to select the folder for playback or to delete the entire folder and all images it contains. Note, however, that such folders can not be used to store photographs taken after the folder was created.

Monitor Options

The **Monitor Options** sub-menu is used to specify when the monitor will turn on automatically and to set monitor brightness and hue (tone).

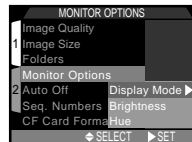

Controlling the Monitor: The Display Mode Menu

This option is used to specify the conditions under which the monitor will turn on automatically, and to specify whether or not photographs are displayed in the monitor after shooting.

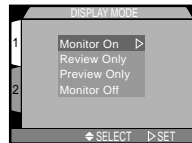

Option	Description
Monitor On	Monitor turns on at start-up; photographs are displayed in monitor after shooting
Review Only	Monitor turns on only to display photographs immediately after shooting. Choose this option to save batteries.
Preview Only	Monitor turns on at start-up, but photographs are not displayed in monitor after shooting
Monitor Off	Monitor remains off at all times. This option is the most effective for saving batteries.

Adjusting Monitor Brightness: The Brightness Menu

This option controls monitor brightness. Press the multi selector up or down to increase or decrease the brightness of the monitor by moving the arrow at the right side of the display up or down. Once you have adjusted brightness to your satisfaction, press the multi selector to the right to put the change into effect.

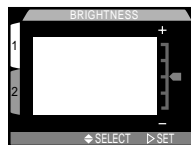

Adjusting Monitor Tone: The Hue Menu

This option controls the hue (tone) of the monitor. Press the multi selector up or down to alter the hue by moving the arrow at the right side of the display up or down. Once you have adjusted hue to your satisfaction, press the multi selector to the right to put the change into effect.



SETUP



Increasing monitor brightness also increases the brightness of images output on a television set when the camera is connected to a television or VCR. Under normal viewing conditions, this may make the image on the television slightly too bright.

The Auto Off Menu

When operated on battery power, the camera enters sleep mode if no operations are performed for thirty seconds (three minutes when menus are displayed). The time limit for sleep mode can be chosen from the **Auto Off** menu.

Changes to the time limit for recording modes (AUTO, SCENE, P,A, M, and CSM modes) are made from the setup-mode menu. The time limit for playback is independent of the time limit for recording mode, and is set by choosing **Auto Off** from the playback menu. To set the time limit for playback to the value used in recording mode, select **As REC mode** from the playback **Auto Off** menu.

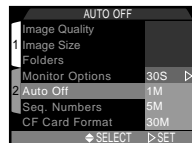

Setup mode

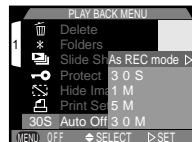

Playback mode



When powered by a six-volt lithium battery (2CR5/DL245), the camera may become hot if left on for an extended period. We recommend that you set **Auto Off** to five minutes or less when using a 2CR5 (DL245) lithium battery.



In sleep mode, all camera functions are deactivated and the camera itself is effectively off, consuming almost no power. The camera can be reactivated by pressing the MONITOR or MENU button or by pressing the shutter-release button halfway.

While the camera is being powered by the EH-21 AC adapter/battery charger (available separately), the camera will remain on for thirty minutes if no operations are performed, regardless of the setting in the **Auto Off** menu. If the camera is connected to a television set, video output will continue indefinitely after the monitor has turned off.

File Numbering: The Seq. Numbers Menu

The photographs and movies your camera creates are stored as image files. Each file is assigned a name consisting of "DSCN" followed by a four-digit number assigned automatically by the camera. Although all photographs in any given folder will have different names, photographs in different folders may share the same name, causing confusion when the files are copied to a computer. This can be prevented using the options in the **Seq. Numbers** menu.

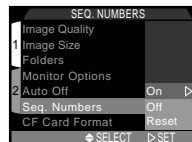

Option	Description
On	When new folder is created, numbering continues from last number used. All files will have unique names.
Off	When new folder is created, numbering begins from 0001. Files in different folders may have the same name.
Reset	Resets sequential numbering to lowest number available on card

Formatting Memory Cards: CF Card Format

To format memory cards for use in the COOLPIX 880, select **CF Card Format** from the setup-mode menu or the SHOOTING menu for P•A•M and CSM modes.

To format a memory card:



1



Highlight **CF Card Format**



2



Press



Confirmation dialog displayed

- Select **Format** to format card (see Step 3)
- Select **No** to return to previous menu without formatting card

3

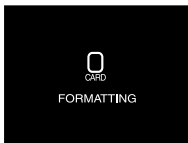

Formatting begins as soon as multi selector is pressed to right to select **Format** in **CF Card Format** menu. Do not remove card from camera until formatting is complete. All data on card will be permanently deleted.

Storing Camera Settings: The Controls Menu

The first three items in the **Controls** menu determine what camera settings remain in effect when the camera is turned off. If an item is checked, the setting in effect at the time the camera was turned off will be restored the next time the camera is turned on. Any items that are not checked will be restored to default settings when the camera is turned off.



Option	Setting Affected	Default
save	Flash setting	Auto
save	Focus mode	Autofocus
save	Exposure compensation	± 0

The fourth item, **Digital Zoom**, is used to turn digital zoom on and off. If it is checked, digital zoom functions normally (52). If this item is not checked, digital zoom can not be used, and pressing the **T** button at the maximum optical-zoom position has no effect.

To check an item, or remove the check mark from an item that has already been checked, highlight the item and press the multi selector to the right. Highlight **Done** and press the multi selector to the right to put the changes into effect.

Shutter Release Confirmation and Photo Information

The **Pic Data/Confirm** sub-menu contains options for confirming shutter release and storing photo information in text format.

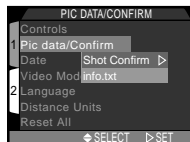

Confirming Shutter Release: The Shot Confirm Lamp Menu

If desired, the red-eye reduction lamp next to the viewfinder window can be used to let your subjects know that the shutter has been released. This can be useful when taking portraits without the flash. Shot confirmation can be turned on or off in the **Shot Confirm Lamp** sub-menu.

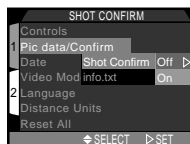

SETUP

Option	Description
Off	Red-eye reduction lamp does not fire when shutter is released (default)
On	Red-eye reduction lamp fires when shutter is released

Recording Photo Information: The Info.txt Menu

When **On** is selected in the **info.txt** sub-menu, a text file (“info.txt”) will be created to store photo information for all subsequent images. When the contents of the memory card are viewed from a computer, this file, which may be found in the folder where the images are stored, can be read with a text browser such as SimpleText or Notepad. The default setting for **info.txt** is **Off**.

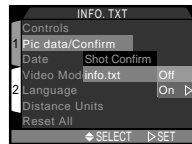

Option	Description
Off	Text-format photo information not recorded (does not affect playback photo-information display)
On	Photo information recorded in text format



The info.txt file gives the following information for each image in the folder:

- File number and type
- Camera type and firmware version
- Metering mode
- Exposure mode
- Shutter speed
- Aperture
- Exposure compensation
- Focal length and digital zoom factor
- Image adjustment
- Sensitivity (ISO equivalency)
- White balance
- Sharpening
- Date of recording
- Image size and quality

Images are listed in the order recorded, separated by a blank line.

The Date Menu

The **Date** option is used to set the date and time. For more information, see “First Steps: Setting the Time and Date” (📖 21).

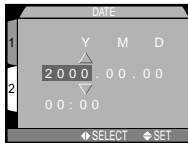

The Video Mode Menu

The **Video Mode** sub-menu sets the standard used for video output. Adjust this setting to match the standard used in any video device to which you connect the camera (📖 162).

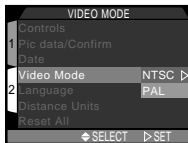

Option	Description
NTSC	Use when connecting to NTSC devices
PAL	Use when connecting to PAL devices

The Language Menu

Use the **Language** sub-menu to choose the language used in menus and messages displayed by the camera. For more information, see “First Steps: Choosing a Language” (📖 20).

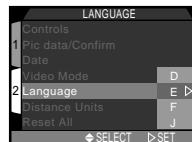

The Distance Units Menu

In this sub-menu, you can choose the units used when displaying manual focus distance (📖 76). The options available are meters (m) or feet (ft).

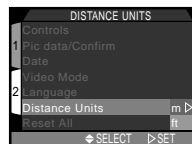

Restoring Default Settings: The Reset All Menu

The **Reset All** option in the SETUP-mode menu is used to restore settings for all modes to their default values.

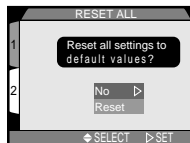

The **Reset All** menu contains the following options:

Option	Description
No	Exit menu leaving settings unchanged
Reset	Restore settings to default values

Choosing **Reset** restores shooting settings for both P•A•M and CSM modes to their default values (for a list of the settings affected and their default values, see  I 10). In addition, the following settings are restored to default values:

Setting	Default
SCENE mode	Portrait
Image Quality (all modes)	Normal
Image Size (all modes)	Full
Folders (all modes)	NIKON
Display Mode	On
Brightness	3
Hue	6

All other settings are unaffected.

Setting	Default
Auto Off (all modes)	30 s
Seq. Numbers	On; numbering reset to lowest number available on card
Controls	All options on
Shot Confirm Lamp	Off
Info.txt	Off
Frame Intvl (Slide Show)	3 s

Connections

Connecting Your Camera to a Computer, TV, or VCR

This chapter provides information on connecting your camera to a computer and to a television or videocassette recorder (VCR).

Connecting to a Television or VCR

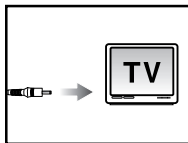
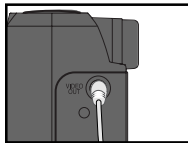

Using the EG-900 video cable provided with your camera, you can connect the COOLPIX 880 to a television or VCR. The video device will mirror the image displayed in the camera monitor.

- 1** Insert the black plug on the EG-900 into the camera's VIDEO OUT connector.
- 2** Connect the yellow plug to the video-in jack on the television or VCR.
- 3** Tune the television to the video channel.
- 4** Turn the camera on. The television will mirror the image displayed in the camera monitor.





Connect the EH-21 AC adapter/battery charger (available separately) if you want the television to continue displaying images after the camera has entered sleep mode and the monitor has turned off. Camera settings and photo info will not be displayed on the television screen when the monitor is off.

The **Video Mode** item in the SETUP-mode menu ( 158) offers a choice of NTSC and PAL standards for video output. Select a standard that matches that used in your television set. Note that when the PAL video standard is selected, the monitor will turn off when the camera is connected to a video device (while recording is taking place at CONTINUOUS settings of **Ultra HS** or **Movie** ( 89), however, the monitor will be used for display and video output will be suspended).

Connecting to a Computer

Using a computer, you can view the images stored in the camera's memory card, retouch them in your favorite imaging application, send them to your acquaintances via e-mail, or save them to disk. You can connect your camera directly to your computer via the UC-E1 Universal Serial Bus (USB) cable or optional SC-EW3/SC-EM3 serial cables, and browse the contents of the memory card using the Nikon View software provided with your camera. Alternatively, you can insert the memory card in a card slot or card drive, where it will function as an additional disk.

Using Nikon View Software

Before You Start

Before using Nikon View, read the documentation provided. The manuals for Nikon View are divided into two parts, both on the reference CD provided with your camera.

Quick Start Guide (HTML)

This installation guide can be viewed in Internet Explorer version 3.0 or later, or in Netscape Navigator version 3.0 or later. To view:

- Insert the reference CD into the CD-ROM drive
- Double-click the **QKSTART.html** icon in the root directory of the CD



If you are unable to view the *Quick Start Guide*, refer to the README.txt text file in the root directory of the reference CD. This file provides system requirements and basic installation instructions.

Reference Manual (PDF)

The reference CD includes separate reference manuals for Macintosh and Windows versions of Nikon View. These manuals provide complete operating instructions. Before they can be viewed, you will need to install Adobe Acrobat Reader version 4.0 or later. Installers in a number of language versions may be found on the reference CD; to install, open the folder for the language of your choice and double-click the installer icon. Once installation is complete, you can view the on-line documentation by clicking the **INDEX.pdf** icon in the root directory of the reference CD.

After reading the documentation, install Nikon View as directed in the *Quick Start Guide*. You are now ready to connect the camera to your computer.



The COOLPIX 880 requires Nikon View Ver.3 (Version 3.1) or later.



The SC-EW3 serial cable (available separately) for PC computers is for connection to a male nine-pin serial connector; standard on many IBM compatibles. Your PC may, however, use a different type of serial connector, in which case you will need to buy an adapter before you can connect the camera.

Connecting Your Camera to a Computer

The COOLPIX 880 can be connected using USB or serial cables.

1

USB

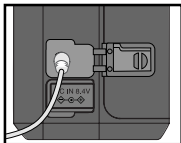

Connect UC-E1
USB cable to
camera USB/serial
connector

1

Serial (PC)

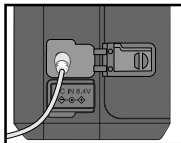

Connect optional
SC-EW3 serial cable
to camera USB/
serial connector

1

Serial (Macintosh)

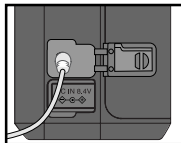

Connect optional
SC-EM3 serial cable
to camera USB/
serial connector

2

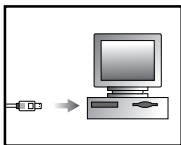

Connect cable to
computer USB
connector

2

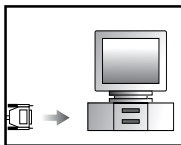

Connect cable to
computer serial
port

2

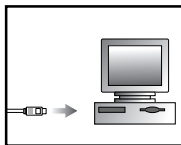

Connect cable to
computer modem
or printer port

3

Turn camera on. Borders of exposure-count display in control panel will light up ([: : :]). Monitor, and all indicators apart from battery indicator, will be off, and all camera functions will be disabled. Normal functioning will be restored when USB or serial cable is disconnected.

For information on the operations that can be performed while the camera is connected to your computer, see the *Nikon View Reference Manual* for your platform.



While the camera is connected to the computer by a USB cable, or while data are being transferred between the computer and camera over a serial cable, the borders of the exposure-count display in the control panel will flash on and off in sequence to form a “marching ants” marquee ([: : :]). Do not unplug the serial or USB cables while data transfer is in progress. If you are using a USB cable, check the progress indicator displayed on the computer to verify that data transfer is complete.

Do not use Nikon View with the camera while battery power is low or the battery is exhausted. If the battery indicator changes to low or starts to flash while the camera and computer are connected, wait for the borders of the number display to stop flashing, then disconnect the camera and replace the battery or connect the EH-21 AC adapter/battery charger (sold separately).



Both the camera and the computer can be on when the cables are connected or disconnected, but do not disconnect the cable while data transfer is in progress.

Reading Photographs from Memory Cards

To read photographs from the camera's memory card, you will need:

- a PC or Macintosh computer; and
- either a CF-card reader or, if your computer is equipped with a PCMCIA Type II or Type III card slot, an ED-ADI PC-card adapter (available separately from Nikon)

Using a CF-Card Reader

The steps involved in connecting a CF-card reader and inserting memory cards are covered in the documentation provided with your card reader. Once the card has been inserted, it will function as a disk, as described in Step 3 of "Using a PCMCIA Card Slot," below.

Using a PCMCIA Card Slot

1 Insert the memory card into the PC-card adapter.



2 Insert the adapter into your computer's PC-card slot as instructed in the documentation provided with your computer or PC-card drive.

3 The card will now function as a disk. Photographs may be found in the folder DCIM in the root directory, stored in the folder shown in the playback-mode information display. Photos (files with the extensions ".JPG" or ".TIF") can be viewed in any application that supports JPEG and TIFF formats. Movies (".MOV") can be played back in any application that supports QuickTime.



The COOLPIX 880 can play back only images that conform to the format used by the COOLPIX 990, 950, 900s, 900, 800, and 700 digital cameras. It may not be able to display files created on a computer or by another make of camera. It may also not be able to display files that have been renamed or moved to a different folder on the memory card using a computer.



You may need to install an ATA RAM-card driver before you will be able to read memory cards on a computer running Windows 3.1

Nikon View can be used to browse photographs on memory cards. See the *Nikon View Reference Manual* for details.

Technical Notes

This chapter covers:

- Camera care and storage
- Camera accessories
- Troubleshooting hints and tips
- Product specifications

Caring for Your Camera

Cleaning

Lens/ Viewfinder	Use blower to remove dirt or dust. Wipe carefully with soft cloth to remove fingerprints and other stains. Do not touch with fingers.
Monitor	Clean with soft, dry cloth
Body	Clean with damp cloth; dry immediately

Do not use alcohol, thinner, or other volatile cleaners

Storage

If you are not going to use the camera for an extended period, remove the battery before putting the camera away. Do not store your camera in locations that:

- are poorly ventilated or damp
- are next to equipment that produces strong magnetic fields, such as televisions or radios
- are hotter than 50°C (122°F) or colder than -10°C (14°F)
- are subject to humidities of over 60%

Optional Accessories

At the time of writing, the following optional accessories were available for the COOLPIX 880. Contact your retailer or local Nikon representative for details.

AC adapter/battery charger

- EH-21 AC adapter/battery charger

Rechargeable battery

- EN-EL1 rechargeable Li-ion battery (requires EH-21 AC adapter/battery recharger)

Lens adapter

- UR-E2 step down ring lens adapter

Lens converters (UR-E2 step down ring lens adapter required)

- ES-E28 slide-copying adapter
- FC-E8 fisheye lens converter (F 8 mm, view angle approximately 183°)
- WC-E24/WC-E63 wide-angle lens converters (shortens focal length to 24–60 mm/24–60 mm)
- TC-E2 2× telephoto lens converter (doubles focal length to 132–190 mm)
- TC-E3ED 3× telephoto lens converter (uses two ED glass elements; triples focal length to 285 mm)

* Focal lengths converted to 35 mm (135) format.

Remote release cable

- MC-EU1 remote cord

Carrying case

- CS-E880 Soft Case

CompactFlash memory cards and adapters

- 64 MB and 96 MB Nikon CF memory cards
- EC-AD1 PC-card adapter

Serial cables

- SC-EW3 serial cable for PC/AT computers
- SC-EM3 serial cable for Macintosh computers



In addition to Nikon 64 MB and 96 MB CompactFlash memory cards, the following cards have been tested and approved for use in the COOLPIX 880:



- SanDisk SDCFB series 48 MB, 64 MB, and 96 MB
- Lexar Media 4x USB series 8 MB, 16 MB, 32 MB, 48 MB, 64 MB
- Lexar Media 8x USB series 16 MB, 32 MB, 48 MB, 64 MB, 80 MB
- Lexar Media 10x USB series 128 MB, 160 MB



Operation is not guaranteed with other cards. For more details on the above cards, please contact the manufacturer.

Troubleshooting

Should you encounter problems with your camera, check the list below before consulting your retailer or Nikon representative. The page numbers in the rightmost column give cross-references to sections of this manual that provide more information on the problems listed in the table below.

Problem	Possible Cause	
Control panel display is blank	• Camera is in sleep mode. Press MONITOR button.	9
	• Camera is off	24
	• Battery is not correctly inserted or battery-chamber cover is not fully closed	15
	• Battery is dead	16
	• EH-21 AC adapter/battery charger (available separately) is not properly connected	—
Monitor is blank	• Monitor is off. Press MONITOR button.	9
	• Monitor Off is selected in Monitor Options > Display Mode sub-menu (setup mode)	149
No indicators appear in monitor	• Indicators are hidden. Press MONITOR button until indicators are displayed	9
	• Slide show is in progress	127
Monitor is hard to read	• Display options require adjustment	149
	• Monitor is dirty	170



Problem	Possible Cause	
No photo is taken when shutter-release button is fully pressed	<ul style="list-style-type: none"> • Mode dial is set to  or SETUP • Battery is exhausted • AF lamp flickers: camera is unable to focus • Flash lamp flickers: flash is charging • Number of exposures remaining is zero: not enough memory remaining • Message “CARD IS NOT FORMATTED” appears in monitor: card has not been formatted for use in COOLPIX 880 • Message “NO CARD PRESENT” appears in monitor: no memory card has been inserted in camera 	<p>6</p> <p>16</p> <p>28</p> <p>28</p> <p>24</p> <p>179</p> <p>179</p>
Photos are over- or under-exposed	<ul style="list-style-type: none"> • Shutter-speed indicator in monitor blinks: shutter speed too low or too high • Aperture indicator in monitor blinks: aperture too large or too small • Subject outside range of flash • Exposure compensation too high or too low 	<p>72</p> <p>71</p> <p>186</p> <p>64</p>
Photos not in focus	<ul style="list-style-type: none"> • Subject is not in focus area • AF lamp flickers: camera is unable to focus • Manual focus distance does not match distance to subject 	<p>29</p> <p>28</p> <p>76</p>







Problem	Possible Cause	
Flash does not fire	<ul style="list-style-type: none"> Flash indicator in control panel and monitor shows : flash is off 	55
	<ul style="list-style-type: none"> Battery level is low 	16
	<ul style="list-style-type: none"> Focus mode of  (infinity) selected 	59
	<ul style="list-style-type: none"> Setting other than Single selected in CONTINUOUS sub-menu 	88
	<ul style="list-style-type: none"> Best-shot selection is on 	92
	<ul style="list-style-type: none"> Setting other than Normal selected in LENS sub-menu 	106
	<ul style="list-style-type: none"> AE Lock option in EXPOSURE OPTIONS sub-menu is on 	99
Television does not mirror image in monitor	<ul style="list-style-type: none"> Video cable is not correctly connected 	162
	<ul style="list-style-type: none"> Television not tuned to video channel 	162
	<ul style="list-style-type: none"> Setting in Video Mode menu does not match television video standard 	158
Photos can not be played back	<ul style="list-style-type: none"> Photo has been overwritten or renamed by computer 	169
Computer can not read files on memory card	<ul style="list-style-type: none"> Card not correctly inserted in card reader or adapter, or adapter not correctly inserted in computer 	168
	<ul style="list-style-type: none"> Application does not support JPEG, TIFF, or QuickTime 	183
	<ul style="list-style-type: none"> ATA RAM-drivers not installed (Windows 3.1) 	169

Problem	Possible Cause	
Nikon View displays communications error	<ul style="list-style-type: none"> • USB or serial cable not correctly connected • Modem or COM port speed too high • Camera not registered in Device Manager (Windows). Reinstall driver from root directory of Nikon View CD. • FIFO buffer size too large (Windows) • Another application is using COM or modem port • Virus-checking, disk-doubling, or RAM-doubling software is interfering with operation of Nikon View 	166 — — — — —

Error Messages

The following table lists the error messages that appear in the monitor and how to deal with them.

Message	Problem	Solution	
WARNING!! Remove Lens Cap!	Camera turned on with lens cap in place	Turn camera off and remove lens cap	23
WARNING!! Mode dial is not in the proper position	Mode dial is positioned between two modes	Adjust mode dial to select desired mode	6
WARNING!! No menu in AUTO mode Please use another mode	Menu button pressed in AUTO mode	Turn mode dial to SETUP to adjust AUTO-mode menu settings	134
 WARNING!! Please wait for camera to finish recording	Camera turned off or new mode selected while images are being recorded to memory card	Message clears from display automatically when camera finishes writing data to card	—

Message	Problem	Solution	
 NO CARD PRESENT	Camera can not detect memory card	Turn camera off and confirm that memory card is correctly inserted	18
 THIS CARD CANNOT BE USED	Error accessing memory card	Use approved memory card	173
	Card has not been formatted for use in COOLPIX 880	Using multi selector, highlight FORMAT and press multi selector to right to format card, or turn camera off and replace card	18
 OUT OF MEMORY	Insufficient memory to record further photographs at current settings	<ul style="list-style-type: none"> • Reduce image quality or size • Delete photographs • Insert new card 	137 122 18
 IMAGE CANNOT BE SAVED	<ul style="list-style-type: none"> • Error encountered while saving photo • Camera has run out of folder or file numbers 	<ul style="list-style-type: none"> • Create new folder • Turn Seq. Numbers option off • Reformat memory card 	142 153 154

Message	Problem	Solution	
CARD CONTAINS NO IMAGES	Folder selected in playback mode contains no images	Select folder containing images from playback Folders menu	126
ALL IMAGES ARE HIDDEN	All images in current folder are hidden	Select another folder or use Hide Image to change hidden status of images in current folder	131
FILE CONTAINS NO IMAGE DATA	File created by computer or different make of camera	<ul style="list-style-type: none"> • Delete file • Reformat memory card 	122 154
THE FOLDER CANNOT BE DELETED	Folder contains hidden or protected photos	Folder can only be deleted if all images it contains are neither hidden nor protected photos	142
SYSTEM ERROR	Error has occurred in camera's internal circuitry	Turn camera off, unplug optional AC adapter (if using), remove and re-insert battery, and turn camera on. If error persists, contact retailer or Nikon representative.	15

Specifications

Type	Digital camera
CCD	<ul style="list-style-type: none">• $\frac{1}{1.8}$" high-density CCD• Total number of pixels: 3.34 million
Image size	Selectable from: <ul style="list-style-type: none">• 2048×1536 pixels• XGA (1024×768 pixels)• VGA (640×480 pixels)
Lens	<ul style="list-style-type: none">• $2.5 \times$ Zoom-Nikkor• $F = 8 - 20$ mm [35 mm (135) format equivalent to 38 – 95 mm]/ f 2.8 – 4.2 with macro• Nine elements in seven groups, all elements made of environmentally-friendly glass• Nikon Super Integrated Coating (SIC) applied
Digital zoom	Use zoom buttons to zoom in up to $4 \times$ in steps of $0.2 \times$
Autofocus	<ul style="list-style-type: none">• Contrast-detect through-the-lens (TTL) AF• Five-area multi AF and spot AF available

Focus modes	<ul style="list-style-type: none"> • Continuous autofocus (when monitor is on) • Single autofocus (monitor off and/or single autofocus selected in P•A•M or CSM modes) • Manual (forty-eight steps from 4 cm/1.6" – ∞ with Focus Confirmation indication)
Shooting distance	<ul style="list-style-type: none"> • 40 cm (1.3') – ∞ • Macro mode: 4 cm (1.6") – ∞
Optical viewfinder	Real-image zoom viewfinder with LED indication
Magnification	0.4 – 1.0 ×
Frame coverage	Approximately 80%
Monitor	1.8", 110,000-dot, low-temperature polysilicon TFT LCD with brightness and hue adjustment
Frame coverage	Approximately 97% (through/freeze image)
Auto-off mode	30 s; can also be set manually (1/5/30 min)



The monitor may contain a few pixels that are always lit or that do not light. This is common to all LCD displays and does not indicate a malfunction. The monitor is lit by a fluorescent backlight. Should the display begin to dim or flicker, contact your Nikon service representative.

Storage	
System	Digitally stored (uncompressed TIFF or compressed JPEG; QuickTime Movie)
Media	CompactFlash (CF) card
Shooting modes	<ul style="list-style-type: none"> • Full auto (AUTO) • Scene mode (SCENE) with eleven scenes (Portrait, Party/Indoor, Night Portrait, Beach/Snow, Landscape, Sunset, Night Landscape, Fireworks Show, Sparkler, Close Up, Copy, Back Light) • Programmed auto (P) • Aperture-priority auto (A) • Manual (M) • Custom (CSM)
Shooting menu	<ul style="list-style-type: none"> • White balance • Continuous • Lens Converters • Image Adjustment (Auto, Normal, More Contrast, Less Contrast, Lighten, Darken, Black & White) • Image Sharpening • Sensitivity • Focus options • CF card format • Exposure metering • Best-Shot Selector (BSS) • Image Size/quality • Exposure options • Folder options

Capture modes	<ul style="list-style-type: none"> • Single • Continuous • Multi-Shot 16 (sixteen frames $1/16$ in size) • VGA Sequence • Ultra HS (seventy QVGA images at approximately 30 fps) • Movie (up to 40 s of QVGA frames at 15 fps)
Exposure metering	Four-mode TTL metering
Modes	<ul style="list-style-type: none"> • 256-segment Matrix • Center-Weighted • Spot • AF Spot
Shutter	Mechanical and charge-coupled electronic shutter
Speed	8 – $1/1000$ s, Bulb
Aperture	Electronically controlled preset aperture
Range	Two stops (f 2.8 and f 7.8 [W], f 4.2 and f 11.3 [T])

Exposure	
Exposure control	<ul style="list-style-type: none"> • Exposure modes: <ul style="list-style-type: none"> - Programmed Auto - Aperture-Priority Auto - Manual • Exposure Compensation (± 2.0 EV in steps of $\frac{1}{3}$ EV) • Auto-Exposure Bracketing (five steps within $\pm \frac{2}{3}$ EV)
Range (ISO 100 equivalent)	<ul style="list-style-type: none"> • EV 0 to +16 (W) • EV 1.2 to +17.2 (T)
Sensitivity	ISO equivalent 100, 200, 400, Auto; can be set in any exposure mode
White balance	<ul style="list-style-type: none"> • Matrix Auto White Balance with TTL control • Five-mode Manual with fine tuning (Fine, Incandescent, Fluorescent, Cloudy, Speedlight) • Preset
Self-timer	10 s or 3 s duration

Built-in Speedlight

Shooting range

0.4 – 2.5 m/1'4" – 8'2" (T), 0.4 – 3.7 m/1'4" – 12'2" (W)
Macro mode: 0.2 – 2.5 m/8" – 8'2" (T)

Flash control

Sensor flash system

Flash modes

- Auto Flash
- Flash Cancel (off)
- Anytime Flash (fill flash)
- Slow Sync
- Red-Eye Reduction

Playback

Playback modes

- Single frame
- Movie
- Thumbnail (four or nine images)
- Slide show
- Zoom playback (up to 4 ×)
- Histogram indication/highlight point display
- Focus confirmation indication

Delete function

Deletes all or selected frames

Attributes

Hide and protect attributes can be set for each image

Interface	USB or serial interface (Windows: 115 Kbps; Macintosh: 230 Kbps)	
	Platform	
	Windows	Macintosh
USB	<p>OS Windows 98/98SE, Windows 2000 or later pre-installed model</p> <p>CPU MMX Pentium or later</p>	<p>OS Mac OS 8.6 or later. Only built-in USB ports supported</p> <p>Models iMac, iBook, Power Macintosh G3 (Blue/White) or Power Mac G4 or later, PowerBook G3 (with built-in USB port) or later</p>
Serial	<p>OS Windows 95/98/98SE, Windows NT 4.0, Windows 2000 or later pre-installed model (optional SC-EW3 serial cable required)</p>	<p>OS Mac OS 8.1 or later (optional SC-EM3 serial cable required). Only built-in serial ports supported.</p>
Video output	NTSC or PAL (selectable)	
I/O terminals	<ul style="list-style-type: none"> • Power input • Video output • Digital output terminal (USB/Serial) 	

Power requirements	<ul style="list-style-type: none"> • One 6 V 2CR5 (DL245) lithium battery or rechargeable Nikon EN-EL1 lithium-ion battery (optional) • EH-21 AC adapter/battery charger (optional)
Battery life	Approximately 90 minutes (rechargeable lithium-ion battery) or 110 minutes (2CR5/DL245 lithium battery) when using monitor at 20°C (68°F)
Operating environment	<ul style="list-style-type: none"> • Temperature: 0 – 40°C (32 – 104°F) • Humidity: under 85% (no condensation)
Dimensions (W × H × D)	Approximately 99.5 × 75 × 53.2 mm (3.9" × 3.0" × 2.1")
Weight	Approximately 275 g (9.7 oz) without battery

Trademark Information

Apple, the Apple logo, Macintosh, Mac OS, Power Macintosh, PowerBook, and QuickTime are registered trademarks of Apple Computer, Inc. Finder, Macintosh PC Exchange, Power Mac, iMac, and iBook are trademarks of Apple Computer, Inc. IBM and IBM PC/AT are registered trademarks of International Business Machines Corporation. PowerPC is a trademark of International Business Machines Corporation, used under license. Microsoft is a registered trademark, and Windows, MS-Windows and Windows NT trademarks, of Microsoft Corporation. Internet Explorer is a product of Microsoft Corporation. Pentium and i486 are trademarks of Intel Corporation. Internet is a trademark of Digital Equipment Corporation. Netscape and Netscape Navigator are registered trademarks of Netscape Communications Corporation. CompactFlash is a trademark of SanDisk Corporation. Lexar Media is a trademark of Lexar Media Corporation. Adobe and Acrobat are registered trademarks of Adobe Systems Inc. Zip is a registered trademark of Iomega Corporation in the U.S. and other countries. All other trade names mentioned in this manual or the other documentation provided with your Nikon product are trademarks or registered trademarks of their respective holders.