

Nikon

DIGITAL CAMERA

COOLPIX P340

Reference Manual

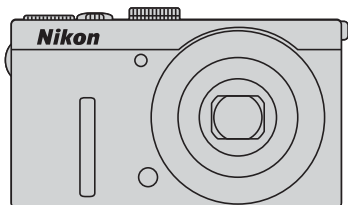

En

Introduction	
Parts of the Camera and Main Functions	
The Basics of Shooting and Playback	
Shooting Features	
Playback Features	
Recording and Playing Back Movies	
General Camera Setup	
Using the Wi-Fi (Wireless LAN) Function	
Connecting the Camera to a TV, Computer, or Printer	
Reference Section	
Technical Notes and Index	

Introduction

Read This First

Thank you for purchasing the Nikon COOLPIX P340 digital camera. Before using the camera, please read the information in "For Your Safety" (📖vii-ix) and familiarize yourself with the information provided in this manual. After reading, please keep this manual handy and refer to it to enhance your enjoyment of your new camera.





About This Manual

If you want to start using the camera right away, see “The Basics of Shooting and Playback” (📖16).

To learn about the parts of the camera and information that is displayed in the monitor, see “Parts of the Camera and Main Functions” (📖1).

Other Information

- Symbols and Conventions
To make it easier to find the information you need, the following symbols and conventions are used in this manual:

Symbol	Description
	This icon indicates cautions and information that should be read before using the camera.
	This icon indicates notes and information that should be read before using the camera.
	These icons indicate other pages containing relevant information;  : “Reference Section”,  : “Technical Notes and Index.”

- SD and SDHC/SDXC memory cards are referred to as “memory cards” in this manual.
- The setting at the time of purchase is referred to as the “default setting.”
- The names of menu items displayed in the camera monitor, and the names of buttons or messages displayed on a computer monitor appear in bold.
- In this manual, images are sometimes omitted from monitor display samples so that monitor indicators can be more clearly shown.
- Illustrations and monitor content shown in this manual may differ from the actual product.

Information and Precautions

Life-Long Learning

As part of Nikon's "Life-Long Learning" commitment to ongoing product support and education, continually updated information is available online at the following sites:

- For users in the U.S.A.: <http://www.nikonusa.com/>
- For users in Europe and Africa: <http://www.europe-nikon.com/support/>
- For users in Asia, Oceania, and the Middle East: <http://www.nikon-asia.com/>

Visit these sites to keep up-to-date with the latest product information, tips, answers to frequently asked questions (FAQs), and general advice on digital imaging and photography. Additional information may be available from the Nikon representative in your area. Visit the site below for contact information:

<http://imaging.nikon.com/>

Use Only Nikon Brand Electronic Accessories

Nikon COOLPIX cameras are designed to the highest standards and include complex electronic circuitry. Only Nikon brand electronic accessories (including battery chargers, batteries, charging AC adapter, AC adapters and cables) certified by Nikon specifically for use with this Nikon digital camera are engineered and proven to operate within the operational and safety requirements of this electronic circuitry.

THE USE OF NON-NIKON ELECTRONIC ACCESSORIES COULD DAMAGE THE CAMERA AND MAY VOID YOUR NIKON WARRANTY.

The use of third-party rechargeable Li-ion batteries not bearing the Nikon holographic seal could interfere with normal operation of the camera or result in the batteries overheating, igniting, rupturing, or leaking.

For more information about Nikon brand accessories, contact a local authorized Nikon dealer.

Holographic seal: Identifies this device as an authentic Nikon product.



Before Taking Important Pictures

Before taking pictures on important occasions (such as at weddings or before taking the camera on a trip), take a test shot to ensure that the camera is functioning normally. Nikon will not be held liable for damages or lost profits that may result from product malfunction.

About the Manuals

- No part of the manuals included with this product may be reproduced, transmitted, transcribed, stored in a retrieval system, or translated into any language in any form, by any means, without Nikon's prior written permission.
- Nikon reserves the right to change the specifications of the hardware and software described in these manuals at any time and without prior notice.
- Nikon will not be held liable for any damages resulting from the use of this product.
- While every effort was made to ensure that the information in these manuals is accurate and complete, we would appreciate it were you to bring any errors or omissions to the attention of the Nikon representative in your area (address provided separately).

Notice Concerning Prohibition of Copying or Reproduction

Note that simply being in possession of material that was digitally copied or reproduced by means of a scanner, digital camera or other device may be punishable by law.

• Items prohibited by law from being copied or reproduced

Do not copy or reproduce paper money, coins, securities, government bonds or local government bonds, even if such copies or reproductions are stamped "Sample." The copying or reproduction of paper money, coins, or securities which are circulated in a foreign country is prohibited. Unless the prior permission of the government was obtained, the copying or reproduction of unused postage stamps or post cards issued by the government is prohibited.

The copying or reproduction of stamps issued by the government and of certified documents stipulated by law is prohibited.

• Cautions on certain copies and reproductions

The government has issued cautions on copies or reproductions of securities issued by private companies (shares, bills, checks, gift certificates, etc.), commuter passes, or coupon tickets, except when a minimum of necessary copies are to be provided for business use by a company. Also, do not copy or reproduce passports issued by the government, licenses issued by public agencies and private groups, ID cards and tickets, such as passes and meal coupons.

• Comply with copyright notices

The copying or reproduction of copyrighted creative works such as books, music, paintings, woodcut prints, maps, drawings, movies, and photographs is governed by national and international copyright laws. Do not use this product for the purpose of making illegal copies or to infringe copyright laws.

Disposing of Data Storage Devices

Please note that deleting images or formatting data storage devices such as memory cards or built-in camera memory does not completely erase the original image data. Deleted files can sometimes be recovered from discarded storage devices using commercially available software, potentially resulting in the malicious use of personal image data. Ensuring the privacy of such data is the user's responsibility.

Before discarding a data storage device or transferring ownership to another person, erase all data using commercial deletion software, or format the device and then completely refill it with images containing no private information (for example, pictures of empty sky). Be sure to also replace any pictures selected for the **Select an image** option in the **Welcome screen** setting (📖92). Care should be taken to avoid injury or damage to property when physically destroying data storage devices. You can clear the Wi-Fi settings using **Restore default settings** in the Wi-Fi options menu (🔌63).

For Your Safety

To prevent damage to your Nikon product or injury to yourself or to others, read the following safety precautions in their entirety before using this equipment. Keep these safety instructions where all those who use the product will read them.

The consequences that could result from failure to observe the precautions listed in this section are indicated by the following symbol:



This icon marks warnings, information that should be read before using this Nikon product, to prevent possible injury.

WARNINGS

Turn off in the event of malfunction

Should you notice smoke or an unusual smell coming from the camera or charging AC adapter, unplug the charging AC adapter and remove the battery immediately, taking care to avoid burns. Continued operation could result in injury. After removing or disconnecting the power source, take the equipment to a Nikon-authorized service representative for inspection.

Do not disassemble

Touching the internal parts of the camera or charging AC adapter could result in injury. Repairs should be performed only by qualified technicians. Should the camera or charging AC adapter break open as the result of a fall or other accident, take the product to a Nikon-authorized service representative for inspection, after unplugging the product and/or removing the battery.

Do not use the camera or charging AC adapter in the presence of flammable gas

Do not use electronic equipment in the presence of flammable gas, as this could result in explosion or fire.

Handle the camera strap with care

Never place the strap around the neck of an infant or child.

Keep out of reach of children

Particular care should be taken to prevent infants from putting the battery or other small parts into their mouths.

Do not remain in contact with the camera, charging AC adapter, or AC adapter for extended periods while the devices are on or in use

Parts of the devices become hot. Leaving the devices in direct contact with the skin for extended periods may result in low-temperature burns.

⚠ Do not leave the product where it will be exposed to extremely high temperatures, such as in an enclosed automobile or in direct sunlight

Failure to observe this precaution could cause damage or fire.

⚠ Use the appropriate power supply (battery, charging AC adapter, AC adapter, USB cable)

Using a power supply other than those provided or sold by Nikon could result in damage or malfunction.

⚠ Observe caution when handling the battery

The battery may leak, overheat, or explode if improperly handled. Observe the following precautions when handling the battery for use in this product:

- Before replacing the battery, turn the product off. If you are using the charging AC adapter/AC adapter, be sure it is unplugged.
- Use only a Rechargeable Li-ion Battery EN-EL12 (included). Charge the battery by using a camera that supports battery charging. To perform this operation, use the Charging AC Adapter EH-71P (included) and USB Cable UC-E21 (included). The Battery Charger MH-65 (available separately) is also available to charge the battery without using a camera.
- When inserting the battery, do not attempt to insert it upside down or backwards.
- Do not short or disassemble the battery or attempt to remove or

break the battery insulation or casing.

- Do not expose the battery to flame or to excessive heat.
- Do not immerse in or expose to water.
- Put the battery in a plastic bag, etc. to insulate the terminal before transporting it. Do not transport or store with metal objects such as necklaces or hairpins.
- The battery is prone to leakage when fully discharged. To avoid damage to the product, be sure to remove the battery when no charge remains.
- Discontinue use immediately should you notice any change in the battery, such as discoloration or deformation.
- If liquid from the damaged battery comes in contact with clothing or skin, rinse immediately with plenty of water.

⚠ Observe the following precautions when handling the charging AC adapter

- Keep dry. Failure to observe this precaution could result in fire or electric shock.
- Dust on or near the metal parts of the plug should be removed with a dry cloth. Continued use could result in fire.
- Do not handle the plug or go near the charging AC adapter during lightning storms. Failure to observe this precaution could result in electric shock.
- Do not damage, modify, forcibly tug or bend the USB cable, place it under heavy objects, or expose it to heat or flames. Should the insulation be damaged and the

wires become exposed, take it to a Nikon-authorized service representative for inspection. Failure to observe these precautions could result in fire or electric shock.

- Do not handle the plug or charging AC adapter with wet hands. Failure to observe this precaution could result in electric shock.
- Do not use with travel converters or adapters designed to convert from one voltage to another or with DC-to-AC inverters. Failure to observe this precaution could damage the product or cause overheating or fire.

Use appropriate cables

When connecting cables to the input and output jacks, use only the cables provided or sold by Nikon for the purpose, to maintain compliance with product regulations.

Handle moving parts with care

Be careful that your fingers or other objects are not pinched by the lens cover or other moving parts.

CD-ROMs

The CD-ROMs included with this device should not be played back on audio CD equipment. Playing CD-ROMs on an audio CD player could cause hearing loss or damage the equipment.

Using the flash close to your subject's eyes could cause temporary visual impairment

The flash should be no less than 1 m (3 ft 4 in.) from the subject.

Particular care should be observed when photographing infants.

Do not operate the flash with the flash window touching a person or object

Failure to observe this precaution could result in burns or fire.

Avoid contact with liquid crystal

Should the monitor break, care should be taken to avoid injury caused by broken glass and to prevent liquid crystal from the monitor touching the skin or entering the eyes or mouth.

Turn the power off when using inside an airplane or the hospital

Turn the power off while inside the airplane during take off or landing. Do not use wireless network functions while in the air.

Follow the instructions of the hospital when using while in a hospital.

The electromagnetic waves emitted by this camera may disrupt the electronic systems of the airplane or the instruments of the hospital.

If you are using an Eye-Fi card, remove it from the camera before boarding an aircraft or entering a hospital.

Notices

Notices for Customers in the U.S.A.

IMPORTANT SAFETY INSTRUCTIONS -

SAVE THESE INSTRUCTIONS.

DANGER - TO REDUCE THE RISK OF FIRE OR ELECTRIC SHOCK, CAREFULLY FOLLOW THESE INSTRUCTIONS

For connection to a supply not in the U.S.A., use an attachment plug adapter of the proper configuration for the power outlet if needed.

The power supply unit is intended to be correctly orientated in a vertical or floor mount position.

Federal Communications Commission (FCC) Radio Frequency Interference Statement

This equipment has been tested and found to comply with the limits for a Class B digital device, pursuant to Part 15 of the FCC Rules. These limits are designed to provide reasonable protection against harmful interference in a residential installation. This equipment generates, uses, and can radiate radio frequency energy and, if not installed and used in accordance with the instructions, may cause harmful interference to radio communications. However, there is no guarantee that interference will

not occur in a particular installation. If this equipment does cause harmful interference to radio or television reception, which can be determined by turning the equipment off and on, the user is encouraged to try to correct the interference by one or more of the following measures:

- Reorient or relocate the receiving antenna.
- Increase the separation between the equipment and receiver.
- Connect the equipment into an outlet on a circuit different from that to which the receiver is connected.
- Consult the dealer or an experienced radio/TV technician for help.



Nikon

COOLPIX P340

CAUTIONS

Modifications

The FCC requires the user to be notified that any changes or modifications made to this device that are not expressly approved by Nikon Corporation may void the user's authority to operate the equipment.

Interface Cables

Use the interface cables sold or provided by Nikon for your equipment. Using other interface cables may exceed the limits of Class B Part 15 of the FCC Rules.

Notice for Customers in the State of California

WARNING

Handling the cord on this product will expose you to lead, a chemical known to the State of California to cause birth defects or other reproductive harm.

Wash hands after handling.

Nikon Inc.,
1300 Walt Whitman Road,
Melville, New York 11747-3064
USA
Tel: 631-547-4200

Notice for Customers in Canada

CAN ICES-3 B / NMB-3 B

Notices for Customers in Europe

CAUTIONS

RISK OF EXPLOSION IF BATTERY IS REPLACED BY AN INCORRECT TYPE.

DISPOSE OF USED BATTERIES ACCORDING TO THE INSTRUCTIONS.

This symbol indicates that electrical and electronic equipment is to be collected separately.



The following apply only to users in European countries:

- This product is designated for separate collection at an appropriate collection point. Do not dispose of as household waste.
- Separate collection and recycling helps conserve natural resources and prevent negative consequences for human health and the environment that might result from incorrect disposal.
- For more information, contact the retailer or the local authorities in charge of waste management.

This symbol on the battery indicates that the battery is to be collected separately.



The following apply only to users in European countries:

- All batteries, whether marked with this symbol or not, are designated for separate collection at an appropriate collection point. Do not dispose of as household waste.
- For more information, contact the retailer or the local authorities in charge of waste management.

Wi-Fi (Wireless LAN Network)

This product is controlled by the United States Export Administration Regulations, and you are required to obtain permission from the United States government if you export or re-export this product to any country to which the United States embargoes goods. The following countries were subject to embargo: Cuba, Iran, North Korea, Sudan, and Syria. Since the target countries are subject to change, please contact the United States Department of Commerce for the latest information.

Restrictions on Wireless Devices

The wireless transceiver included in this product conforms to wireless regulations in the country of sale and is not for use in other countries (products purchased in the EU or EFTA can be used anywhere within the EU and EFTA). Nikon does not accept liability for use in other countries. Users who are unsure as to the original country of sale should consult with their local Nikon service center or Nikon-authorized service representative. This restriction applies to wireless operation only and not to any other use of the product.

Notice for Customers in the U.S.A. and Canada

Federal Communications Commission (FCC) and Industry of Canada (IC)

Declaration of Conformity

This device complies with Part 15 of FCC Rules and Industry Canada licence-exempt RSS standard(s). Operation is subject to the following two conditions: (1) this device may not cause interference, and (2) this device must accept any interference, including interference that may cause undesired operation of this device.

FCC/IC RF Exposure Statement

This transmitter must not be co-located or operated in conjunction with any other antenna or transmitter.

The available scientific evidence does not show that any health problems are associated with using low power wireless devices. There is no proof, however, that these low power wireless devices are absolutely safe. Low power wireless devices emit low levels of radio frequency energy (RF) in the microwave range while being used. Whereas high levels of RF can produce health effects (by heating tissue), exposure to low-level RF that does not produce heating effects causes no known adverse health effects. Many studies of low-level RF exposures have not found any biological effects. Some studies have suggested that some biological effects might occur, but such findings have not been confirmed by additional research.

COOLPIX P340, which is equipped with a LBWA1ZZYM6 (FCC ID:VPYLBYM / IC ID:772C-LBYM) Wireless LAN Module, has been tested and found to comply with FCC/IC radiation exposure limits set forth for an uncontrolled environment

and meets the FCC radio frequency (RF) Exposure Guidelines in Supplement C to OET65 and RSS-102 of the IC radio frequency (RF) Exposure rules. Please refer to the SAR test report that was uploaded to FCC website.

Declaration of Conformity (Europe)

Hereby, Nikon Corporation, declares that COOLPIX P340 is in compliance with the essential requirements and other relevant provisions of Directive 1999/5/EC. The declaration of conformity may be consulted at http://imaging.nikon.com/support/pdf/DoC_P340.pdf.

הודעה ללקוחות במדינת ישראל

ההתקן תואם לתקנות תדרי רדיו.

יש לנהוג באמצעי זהירות בעת השימוש באפשרויות התקשורת

- א. נקודות הגישה תהיה מיועדת אך ורק לחיבור משתמש תמצוי בחצרים מתוחמים (דוגמת בית, בית עסק, מתחם שדה תעופה, קמפוס אוניברסיטאי וכיו
- ב. לצורך גישה לאינטרנט, נקודת הגישה תקושר מחוץ לחצרים אך ורק אל בעל רשיון למתן שירות גישה לאינטרנט (ISP, להלן-ספק אינטרנט). הקישור לספק אינטרנט יהיה אך ורק באמצעות קו תקשורת נתונים המסופק בידי בעל רשיון למתן שירותי תקשורת נתונים;
- ג. קישור נקודת הגישה מחוץ לחצרים לצורך תקשורת נתונים ייעשה באמצעות תשתיות של בעל רשיון מתאים ובלבד שלא ייעשה שימוש בקישור כאמור לצורך העברת קול (VOICE)
- ד. לצורך שרות לצד ג' נדרש רשיון נוסף מאגף הנדסה ורישוי (משרד התקשורת).

Precautions when Using Radio Transmissions

Always keep in mind that radio transmission or reception of data is subject to interception by third parties. Note that Nikon is not responsible for data or information leaks that may occur during data transfer.

Personal Information Management and Disclaimer















































- User information registered and configured on the product, including wireless LAN connection settings and other personal information, is susceptible to alteration and loss resulting from operational error, static electricity, accident, malfunction, repair or other handling. Always keep separate copies of important information. Nikon is not responsible for any direct or indirect damages or lost profits resulting from alteration or loss of content that is not attributable to Nikon.
- Before discarding this product or transferring it to another owner, perform **Reset all** in the setup menu (📖93) to delete all user information registered and configured with the product, including Wi-Fi options and other personal information.

























Table of Contents

Introduction	ii
Read This First	ii
About This Manual	iii
Information and Precautions	iv
For Your Safety	vii
WARNINGS	vii
Notices	x
Wi-Fi (Wireless LAN Network)	xii
<hr/>	
Parts of the Camera and Main Functions	1
The Camera Body	1
Principle Functions of the Controls	3
Attaching the Camera Strap	7
Using Menus (the MENU Button)	8
The Monitor	10
<hr/>	
The Basics of Shooting and Playback	16
Preparation 1 Insert the Battery	16
Preparation 2 Charge the Battery	18
Preparation 3 Insert a Memory Card	20
Internal Memory and Memory Cards	21
Approved Memory Cards	21
Step 1 Turn the Camera On	22
Setting the Display Language, Date, and Time	24
Step 2 Select a Shooting Mode	26
Available Shooting Modes	27
Step 3 Frame a Picture	28
Using the Zoom	29
Step 4 Focus and Shoot	30
Step 5 Play Back Images	32
Step 6 Delete Images	33
<hr/>	
Shooting Features	35
📷 (Auto) Mode	35
Scene Mode (Shooting Suited to Scenes)	36
Tips and Notes	37











Special Effects Mode (Applying Effects When Shooting).....	44
P, S, A, M Modes (Setting the Exposure for Shooting).....	46
The Control Range of the Shutter Speed.....	50
U (User Settings) Mode.....	51
Saving Settings in U Mode (Save User Settings).....	52
Functions That Can Be Set Using the Multi Selector.....	53
Using the Flash.....	54
Using the Self-timer.....	57
Shooting Smiling Faces Automatically (Smile Timer).....	58
Using Focus Mode.....	59
Taking Images with Manual Focus.....	61
Adjusting Brightness (Exposure Compensation).....	63
Default Settings.....	64
Functions That Can Be Set with the MENU Button (Shooting Menu).....	66
Common Options.....	66
For P, S, A, M, U modes.....	66
Functions That Can Be Set with the Control Ring.....	69
Using the Control Ring in  (Auto), P, S, A, M, U Modes.....	70
Functions That Can Be Set with the Fn (Function) Button.....	71
Functions That Cannot Be Used Simultaneously.....	72
Focusing.....	77
Using the Target Finding AF.....	77
Using Face Detection.....	78
Using Skin Softening.....	79
Subjects Not Suitable for Autofocus.....	79
Focus Lock.....	80
<hr/>	
Playback Features.....	81
Playback Zoom.....	81
Thumbnail Display, Calendar Display.....	82
Functions That Can Be Set with the MENU Button (Playback Menu).....	83
Using the Screen for Selecting Images.....	85
<hr/>	
Recording and Playing Back Movies.....	86
Recording Movies.....	86
Functions That Can Be Set with the MENU Button (Movie Menu).....	90
Playing Back Movies.....	90
<hr/>	
General Camera Setup.....	92
Functions That Can Be Set with the MENU Button (Setup Menu).....	92

Using the Wi-Fi (Wireless LAN) Function	94
Functions That Can Be Performed Using Wi-Fi.....	94
Take Photos	94
View Photos.....	94
Installing the Software on the Smart Device	94
Connecting the Smart Device to the Camera.....	95
Connecting the Camera to a TV, Computer, or Printer.....	97
Connection Methods.....	97
Using ViewNX 2	99
Installing ViewNX 2	99
Transferring Images to the Computer	101
Viewing Images.....	102
<hr/>	
Reference Section	01
<hr/>	
Using Easy Panorama (Shooting and Playback)	02
Shooting with Easy Panorama.....	02
Viewing Images Captured with Easy Panorama.....	04
Viewing and Deleting Images Captured Continuously (Sequence).....	05
Viewing Images in a Sequence	05
Deleting Images in a Sequence	06
Editing Still Images.....	07
Before Editing Images.....	07
🔍 Quick Retouch: Enhancing Contrast and Saturation	08
📷 D-Lighting: Enhancing Brightness and Contrast	08
😊 Skin Softening: Softening Skin Tones.....	09
🌀 Filter Effects: Applying Digital Filter Effects	10
🖼️ Small Picture: Reducing the Size of an Image	11
NRW RAW (NRW) Processing: Creating JPEG Images from NRW Images....	12
✂️ Crop: Creating a Cropped Copy	14
Connecting the Camera to a TV (Viewing Images on a TV).....	15
Connecting the Camera to a Printer (Direct Print).....	16
Connecting the Camera to a Printer.....	16
Printing Individual Images.....	17
Printing Multiple Images.....	19
Editing Movies	21
Extracting Only the Desired Portion of a Movie.....	21

Saving a Frame from a Movie as a Still Image	 22
The Shooting Menu (P, S, A or M Mode)	 23
Image Quality	 23
Image Size	 25
Picture Control (COOLPIX Picture Control)	
(Changing the Settings for Image Recording).....	 26
Custom Picture Control	
(COOLPIX Custom Picture Control)	 30
White Balance (Adjusting Hue)	 31
Metering	 34
Continuous Shooting	 35
ISO Sensitivity	 39
Exposure Bracketing.....	 40
AF Area Mode.....	 41
Autofocus Mode.....	 44
Flash Exp. Comp.	 44
Noise Reduction Filter	 45
Built-in ND Filter.....	 46
Active D-Lighting	 47
Multiple Exposure	 48
Zoom Memory.....	 50
Startup Zoom Position.....	 51
M Exposure Preview	 51
The Playback Menu	 52
 Print Order (Creating a DPOF Print Order)	 52
 Slide Show	 54
 Protect.....	 55
 Rotate Image	 55
 Voice Memo.....	 56
 Copy (Copy Between Internal Memory and Memory Card).....	 57
 Sequence Display Options	 58
 Choose Key Picture	 58
The Movie Menu	 59
Movie Options.....	 59
Autofocus Mode.....	 62
Frame Rate	 62
The Wi-Fi Options Menu.....	 63
Operating the Text Input Keyboard	 64
The Setup Menu	 65
Welcome Screen.....	 65

Time Zone and Date	 66
Monitor Settings.....	 68
Print Date (Imprinting Date and Time on Images).....	 70
Vibration Reduction.....	 71
Motion Detection.....	 72
AF Assist	 72
Digital Zoom.....	 73
Control Ring Options	 73
Sound Settings.....	 74
Auto Off	 74
Format Memory/Format Card.....	 75
Language	 75
TV Settings.....	 76
Charge by Computer.....	 77
Toggle Av/Tv Selection	 78
Reset File Numbering	 78
Blink Warning.....	 79
Eye-Fi Upload.....	 80
Peaking.....	 81
Reset All	 81
Firmware Version	 81
Error Messages.....	82
File Names	86
Optional Accessories	87

Technical Notes and Index..... 1

Caring for the Products.....	2
The Camera.....	 2
The Battery	 3
Charging AC Adapter	 4
Memory Cards.....	 5
Caring for the Camera	6
Cleaning.....	 6
Storage	 7
Troubleshooting	8
Specifications	16
Index.....	22





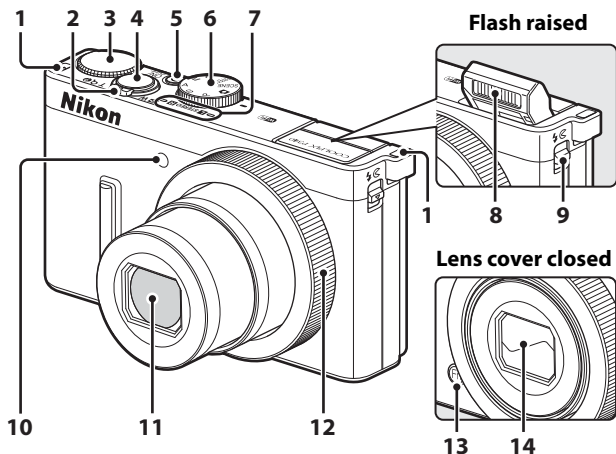

A series of horizontal dashed lines spanning the width of the page, intended for handwriting practice.

Parts of the Camera and Main Functions

The Camera Body



1	Eyelet for camera strap.....	7	Microphone (stereo).....	83, 86	
2	Zoom control.....	29	8	Flash.....	54
	W : wide-angle.....	29	9	 (flash pop-up) control.....	54
	T : telephoto.....	29	10	Self-timer lamp.....	57
	 : thumbnail playback.....	82		AF-assist illuminator.....	92
	 : playback zoom.....	81	11	Lens	
 : help.....	36	12	Control ring.....	69	
3	Command dial.....	3, 5, 46, 48	13	Fn (function) button.....	4
4	Shutter-release button.....	4, 30	14	Lens cover	
5	Power switch/power-on lamp....	22			
6	Mode dial.....	26			

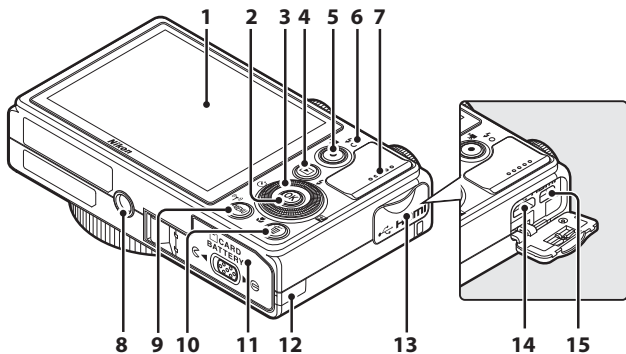





1	Monitor.....	10
2	OK (apply selection) button	3, 5, 8
3	Rotary multi selector (multi selector)*.....	3, 5, 53
4	▶ (playback) button.....	32
5	● (movie-record) button	86
6	Charge lamp.....	18
	Flash lamp.....	55
7	Speaker.....	83, 90, 92
8	Tripod socket	







9	MENU (menu) button	8, 66, 83, 90, 92
10	🗑 (delete) button.....	33, 91
11	Battery-chamber/memory card slot cover.....	16, 20
12	Power connector cover (for optional AC adapter).....	87
13	Connector cover.....	97
14	Micro-USB connector.....	97
15	HDMI micro connector (Type D).....	97

* Also referred to as the "multi selector" in this manual.

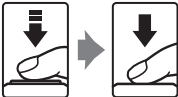









Principle Functions of the Controls









For Shooting

Control	Main Function	
 <p>Mode dial</p>	Change the shooting mode.	26
 <p>Zoom control</p>	Move toward T (Q) (telephoto) to zoom in closer to the subject, and move toward W (wide-angle) to zoom out and view a larger area.	29
 <p>Multi selector</p>	<ul style="list-style-type: none"> While the shooting screen is displayed: Display the following setting screens by pressing: <ul style="list-style-type: none"> Up (▲): ⚡ (flash mode) Left (◀): ⌚ (self-timer/smile timer) Down (▼): 📷 (focus mode) Right (▶): ☒ (exposure compensation) When the shooting mode is A or M: Rotate the multi selector to set the aperture value. While the setting screen is displayed: Select an item using ▲▼◀▶ or by rotating the multi selector; apply the selection by pressing the OK button. 	53 46, 48 8
 <p>Command dial</p>	<ul style="list-style-type: none"> When the shooting mode is P: Set the flexible program. When the shooting mode is S or M: Set the shutter speed. While the setting screen is displayed: Select an item. 	46, 48 46, 48 8
 <p>MENU (menu) button</p>	Display and hide the menu.	8, 66, 83, 90, 92

Control	Main Function	
 <p>Shutter-release button</p>	<p>When pressed halfway (i.e., if you stop pressing when you feel resistance slightly): Set focus and exposure. When pressed all the way (i.e., if you press the button all the way down): Release the shutter.</p>	30, 31
 <p>● (▶ movie-record) button</p>	Start and stop movie recording.	86
 <p>Control ring</p>	Change the settings such as zoom position and exposure.	69
 <p>Fn (function) button</p>	<p>When the shooting mode is P, S, A, M or U: Display or close the setting menus such as Continuous or Vibration reduction.</p>	71
 <p>▶ (playback) button</p>	Play back images.	32
 <p>🗑️ (delete) button</p>	Delete the last image that was saved.	33

For Playback

Control	Main Function	
  (playback) button	<ul style="list-style-type: none"> When the camera is turned off, press and hold this button to turn the camera on in playback mode. Return to shooting mode. 	32 32
 Zoom control	<ul style="list-style-type: none"> Move toward T (Q) to zoom in on the image, and move toward W (R) to display images as thumbnails or the calendar. Adjust the volume for voice memo and movie playback. 	81, 82 83, 90
 Multi selector	<ul style="list-style-type: none"> While the playback screen is displayed: Change the displayed image using up (▲), left (◀), down (▼), right (▶), or by rotating the multi selector. While the setting screen is displayed: Select an item using ▲▼◀▶ or by rotating the multi selector. While an enlarged image is displayed: Move the display area. 	32 8 81
  (apply selection) button	<ul style="list-style-type: none"> Display a histogram, tone level and shooting information or return to full-frame playback mode. Display individual images of a sequence in full-frame playback mode. Scroll an image shot with Easy panorama. Play back movies. Switch from thumbnail playback or zoomed image display to full-frame playback. While the setting screen is displayed, apply the selection. 	32 84,  5 42,  4 90 81, 82 8
 Command dial	Switch the magnification of an enlarged image.	81

Control	Main Function	
 MENU (menu) button	Display and hide the menu.	8, 83
  (delete) button	Delete images.	33
  Shutter-release button	Return to shooting mode.	-
   (movie-record) button		

Attaching the Camera Strap

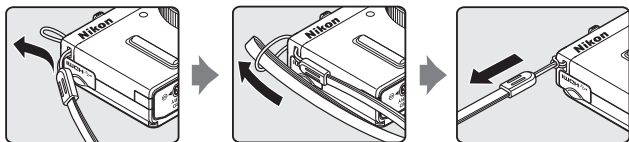

* Pass the strap through either the left or right strap eyelet and attach the strap.

Using Menus (the MENU Button)

Use the multi selector and **OK** button to navigate the menus.

1 Press the **MENU** button.

- The menu that matches the status of the camera, such as shooting or playback menu, is displayed. Unavailable menu items are displayed in gray and cannot be selected.

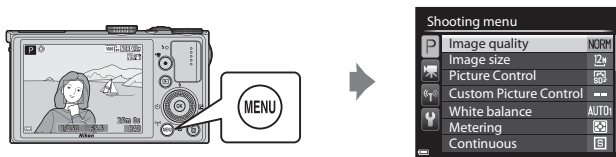

2 Use the multi selector to select a menu item.

- ▲▼ or rotation: Select an item above or below.
- ◀▶: Select an item on the left or right, or move between menu levels.
- OK**: Apply a selection. Pressing ▶ also applies a selection.
- See [book 9](#) for more information on how to switch tabs.



3 After completing the settings, press the **MENU** button or shutter-release button.

- Press the shutter-release button to display the shooting screen.

Notes About the Command Dial Operation When a Menu is Displayed

Rotating the command dial when a menu is displayed allows you to select an item.

Switching Among Menu Tabs

To display a different menu, such as the setup menu (📖92), use the multi-selector to switch to another tab.

Tabs

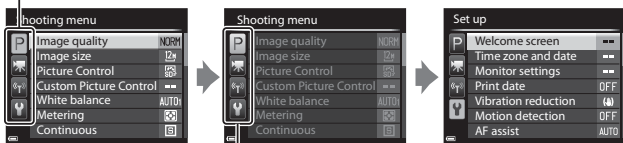

Use ◀ to move to the tabs.

Use ▲▼ to select a tab, and press the Ⓞ button or ▶ to apply the selection.

Tab Types

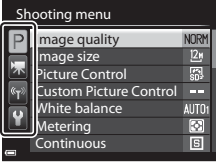
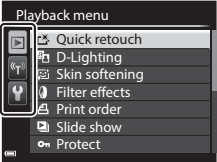

For Shooting	For Playback
 <p>Shooting menu</p> <ul style="list-style-type: none"> Image quality NORM Image size 12M Picture Control SD3 Custom Picture Control -- White balance AUTO Metering Continuous 	 <p>Playback menu</p> <ul style="list-style-type: none"> Quick retouch D-Lighting Skin softening Filter effects Print order Slide show Protect
<p>P tab: Displays the settings available for the current shooting mode (📖27). Depending on the current shooting mode, the tab icon that is displayed will be different.</p> <p>📺 tab: Displays movie recording settings.</p> <p>📶 tab: Displays the settings for Wi-Fi options.</p> <p>🔑 tab: Displays the setup menu, where you can change general settings.</p>	<p>▶ tab: Displays the settings available for the playback mode.</p>

The Monitor

The information that is displayed in the monitor during shooting and playback changes depending on the camera's settings and state of use. In the default setting, information is displayed when the camera is turned on and when you operate the camera, and turns off after a few seconds (when **Photo info** in **Monitor settings** (📖92) is set to **Auto info**).

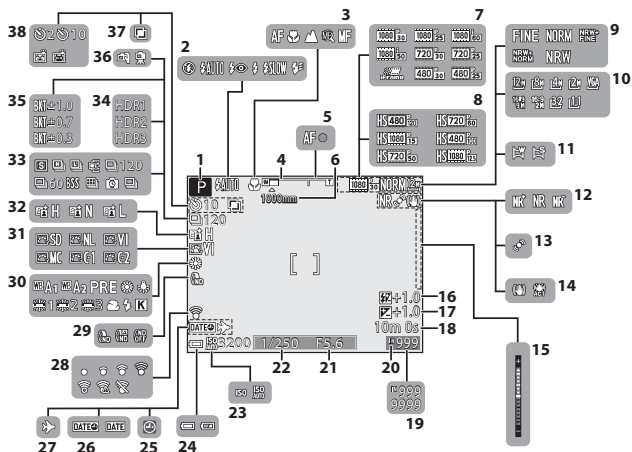
For Shooting



1	Shooting mode	26, 27	27	Travel destination icon	92
2	Flash mode	54	28	Eye-Fi communication indicator	93,  80
3	Focus mode	59	29	Built-in ND filter	67
4	Zoom indicator	29, 60	30	White balance	66
5	Focus indicator	30	31	COOLPIX Picture Control	66
6	Zoom memory	68	32	Active D-Lighting	67
7	Movie options (normal speed movies)	90	33	Continuous shooting mode	43, 67
8	Movie options (HS movies)	90	34	Backlighting (HDR)	41
9	Image quality	66	35	Exposure bracketing	67
10	Image size	66	36	Hand-held/tripod	39
11	Easy panorama	42	37	Multiple exposure	68
12	Noise reduction filter	67		Self-timer indicator	57
13	Motion detection icon	92	38	Smile timer	58
14	Vibration reduction icon	92		Pet portrait auto release	43
15	Exposure indicator	48			
16	Flash exp. comp.	67			
17	Exposure compensation value	63			
18	Movie recording time remaining	86, 87			
19	Number of exposures remaining (still images)	22,  24			
20	Internal memory indicator	22			
21	Aperture value	46			
22	Shutter speed	46			
23	ISO sensitivity	67			
24	Battery level indicator	22			
25	"Date not set" indicator	24, 92			
26	Print date	92			

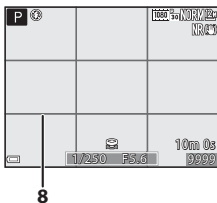
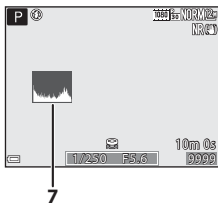
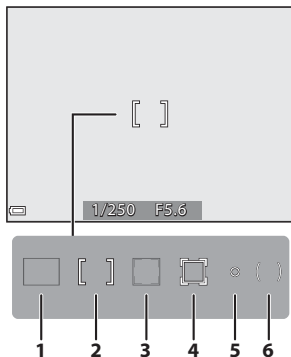

- 1** Focus area (target finding AF)67, 71, 77
- 2** Focus area (center/manual)36, 44, 67, 71, 80
- 3** Focus area (face detection, pet detection)43, 58, 67, 71, 78
- 4** Focus area (subject tracking)67, 71, 43

- 5** Spot metering area.....67
- 6** Center-weighted area.....67
- 7** View/hide histograms63, 92, 68
- 8** View/hide framing grid92, 68

For Playback

Full-frame playback (📖32)

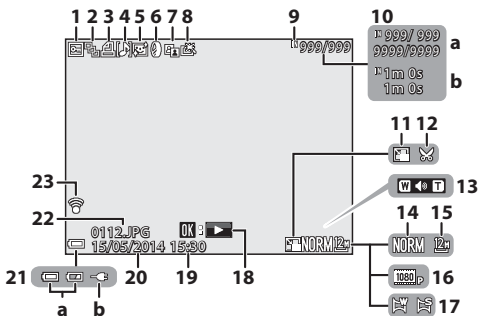

1	Protect icon.....	83
2	Sequence display (when Individual pictures is selected).....	84, 📖58
3	Print order icon.....	83
4	Voice memo indicator.....	83
5	Skin softening icon.....	83
6	Filter effects icon.....	83
7	D-Lighting icon.....	83
8	Quick retouch icon.....	83
9	Internal memory indicator.....	21
10	(a) Current image number/ total number of images (b) Movie length	
11	Small picture icon.....	83
12	Crop icon.....	81
13	Volume indicator.....	83, 90
14	Image quality.....	66
15	Image size.....	66
16	Movie options.....	90
17	Easy panorama indicator.....	42
	Easy panorama playback guide	5, 42, 📖4
18	Sequence playback guide	5, 34, 📖5
	Movie playback guide.....	90
19	Time of recording.....	24
20	Date of recording.....	24
	(a) Battery level indicator.....	22
21	(b) Charging AC adapter connection indicator	
22	File number and type.....	📖86
23	Eye-Fi communication indicator.....	93, 📖80

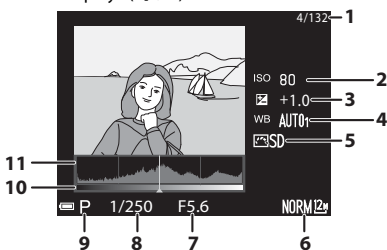
Tone level information display¹ (📖32)

1	Current image number/ total number of images	6	Image quality/Image size 66
2	ISO sensitivity 67	7	Aperture value 46
3	Exposure compensation value... 63	8	Shutter speed 46
4	White balance 66	9	Shooting mode 27
5	COOLPIX Picture Control 66	10	Tone level ²
		11	Histogram ³

¹ You can check for loss of contrast detail in highlights and shadows from the histogram that is displayed, or the flashing display for each tone level. These provide guidelines when adjusting the image brightness with functions such as exposure compensation.

² The tone level indicates the brightness level. When the tone level to check is selected using the multi selector ◀▶, the area of the image that corresponds to the selected tone level flashes.

³ A histogram is a graph showing the distribution of tones in the image. The horizontal axis corresponds to pixel brightness, with dark tones to the left and bright tones to the right. The vertical axis shows the number of pixels.



A series of horizontal dashed lines spanning the width of the page, intended for handwriting practice.

The Basics of Shooting and Playback

Preparation 1 Insert the Battery

- 1** Open the battery-chamber/
memory card slot cover.

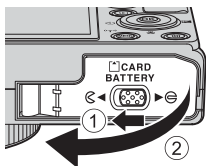

- 2** Insert the battery.

- Push the orange battery latch in the direction indicated by the arrow (1), and fully insert the battery (2).
- The battery locks into place when inserted correctly.

Battery latch

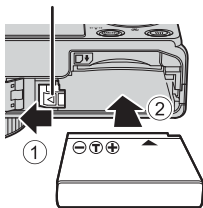

- ✓ Be Careful to Insert the Battery in Correct Direction**

Inserting the battery upside down or backwards could damage the camera.



- 3** Close the battery-chamber/
memory card slot cover.

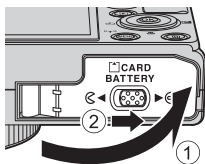

Removing the Battery

Turn the camera off and make sure that the power-on lamp and the monitor have turned off, and then open the battery-chamber/memory card slot cover.

Move the battery latch in the direction indicated by the arrow (①) to eject the battery (②).

High Temperature Caution

The camera, battery, and memory card may be hot immediately after using the camera.

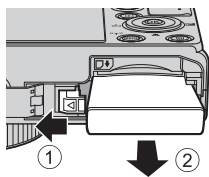

Preparation 2 Charge the Battery

1 Prepare the included charging AC adapter.

If a plug adapter* is included with your camera, attach the plug adapter to the plug on the charging AC adapter. Push the plug adapter firmly until it is securely held in place. Once the two are connected, attempting to forcibly remove the plug adapter could damage the product.

* The shape of the plug adapter varies according to the country or region in which the camera was purchased.

This step can be omitted if the plug adapter comes permanently bonded to the charging AC adapter.

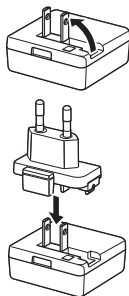

2 Make sure the battery is inserted in the camera, and then connect the camera to the charging AC adapter in order of ① to ③.

- Keep the camera turned off.
- Make sure that the plugs are properly oriented. Do not insert or remove the plugs at an angle when connecting or disconnecting them.

✓ Notes

Do not use a USB cable other than the UC-E21. Using a USB cable other than the UC-E21 could result in overheating, fire or electric shock.

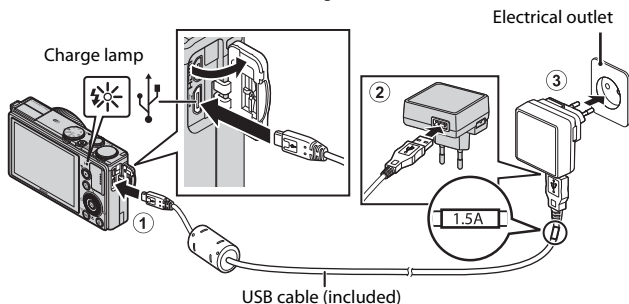

- The charge lamp slowly flashes green to indicate that the battery is charging.

The charge lamp	Description
Flashes slowly (green)	The battery is charging.
Off	When charging is complete, the charge lamp stops flashing green and turns off. About 1 hour and 50 minutes are required to charge a fully exhausted battery.
Flashes quickly (green)	<ul style="list-style-type: none"> The ambient temperature is not suited to charging. Charge the battery indoors with an ambient temperature of 5°C to 35°C (41°F to 95°F). The USB cable or charging AC adapter is not properly connected, or there is a problem with the battery. Disconnect the USB cable or unplug the charging AC adapter and correctly connect it again, or change the battery.

3 Disconnect the charging AC adapter from the electrical outlet and then disconnect the USB cable.



Notes About Charging

Do not, under any circumstances, use another make or model of AC adapter other than Charging AC Adapter EH-71P, and do not use a commercially available USB-AC adapter or a battery charger for a mobile phone. Failure to observe this precaution could result in overheating or in damage to the camera.

Turning On the Camera While the Battery is Charging

The camera does not turn on while the charging AC adapter is connected to it even when you press the power switch. Press and hold the  (playback) button to turn on the camera in playback mode and play back images. Shooting is not possible.

Charging Using a Computer or Battery Charger

- You can also charge the battery by connecting the camera to a computer ( 93, 97).
- You can use the Battery Charger MH-65 (available separately;  87) to charge the battery without using the camera.

Preparation 3 Insert a Memory Card

- 1 Turn off the camera and open the battery-chamber/memory card slot cover.

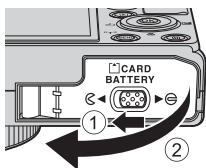

- 2 Insert the memory card.

- Slide the memory card in until it clicks into place.

Memory card slot

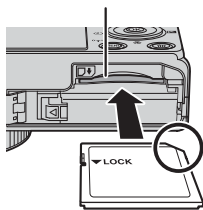

- Be Careful to Insert the Memory Card in Correct Direction**

Inserting the memory card upside down or backwards could damage the camera and the memory card.



- 3 Close the battery-chamber/memory card slot cover.

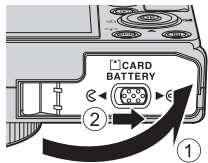

- Formatting Memory Cards**

The first time you insert a memory card that has been used in another device into this camera, make sure to format it with this camera. Insert the card into the camera, press the **MENU** button, and select **Format card** in the setup menu.

Removing Memory Cards

Turn the camera off and make sure that the power-on lamp and the monitor have turned off, and then open the battery-chamber/memory card slot cover.

Gently push the memory card into the camera (①) to partially eject the card (②).

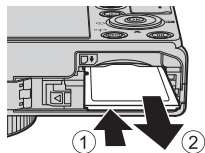

High Temperature Caution

The camera, battery, and memory card may be hot immediately after using the camera.

Internal Memory and Memory Cards

Camera data, including images and movies, can be saved either in the camera's internal memory or on a memory card. To use the camera's internal memory, first remove the memory card.

Approved Memory Cards

The following Secure Digital (SD) memory cards have been tested and approved for use in this camera.

- Memory cards with an SD Speed Class rating of 6 or faster are recommended for recording movies. When using a memory card with a lower Speed Class rating, movie recording may stop unexpectedly.

	SD memory cards	SDHC memory cards ²	SDXC memory cards ³
SanDisk	2 GB ¹	4 GB, 8 GB, 16 GB, 32 GB	64 GB, 128 GB
TOSHIBA	-	4 GB, 8 GB, 16 GB, 32 GB	64 GB
Panasonic	2 GB ¹	4 GB, 8 GB, 16 GB, 32 GB	64 GB
Lexar	-	4 GB, 8 GB, 16 GB, 32 GB	64 GB, 128 GB

¹ If the memory card will be used with a card reader or similar device, make sure that the device supports 2 GB cards.

² SDHC-compliant. If the memory card will be used with a card reader or similar device, make sure that the device supports SDHC.

³ SDXC-compliant. If the memory card will be used with a card reader or similar device, make sure that the device supports SDXC.



- Contact the manufacturer for details on the above cards. We cannot guarantee camera performance when using memory cards made by other manufacturers.

Step 1 Turn the Camera On

1 Press the power switch.

- **If you are turning the camera on for the first time, see “Setting the Display Language, Date, and Time”** (📖24).
- The monitor turns on.
- To turn the camera off, press the power switch again.

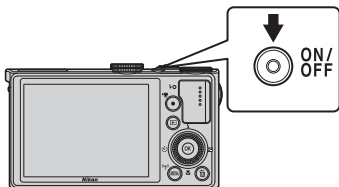

2 Check the battery level indicator and the number of exposures remaining.

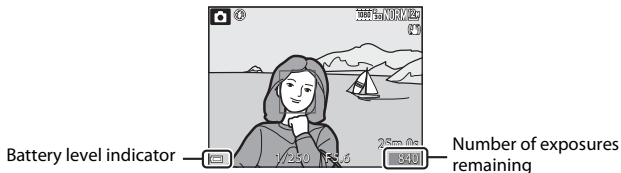

Battery level indicator

Display	Description
	The battery level is high.
	The battery level is low.
Battery exhausted.	The camera cannot capture images. Recharge the battery.



Number of Exposures Remaining

The number of images that can be taken is displayed.

- is displayed when no memory card is inserted in the camera, and images are saved in the internal memory.

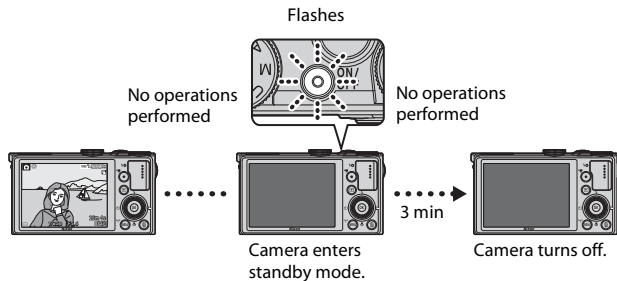
The Auto Off Function





- The time that elapses before the camera enters standby mode is about 1 minute. The time can be changed using the **Auto off** setting in the setup menu ( 92).
- While the camera is in standby mode, the monitor turns back on if you perform any of the following operations:
 - Press the power switch, shutter-release button,  button, or  (movie-record) button.
 - Rotate the mode dial.

Setting the Display Language, Date, and Time

When the camera is turned on for the first time, the language-selection screen and the date and time setting screen for the camera clock are displayed.

- If you exit without setting the date and time,  will flash when the shooting screen is displayed.

- 1** Use the multi selector   to select the desired language and press the  button.

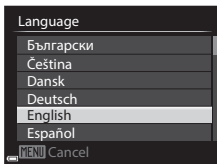

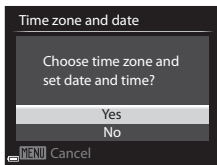

- 2** Select **Yes** and press the  button.

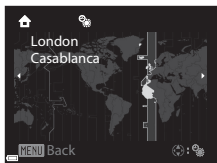

- 3** Select your home time zone and press the  button.



- To enable daylight saving time, press . When the daylight saving time function is enabled,  is displayed above the map.

To turn off the daylight saving time function, press .

- 4** Select the date format and press the  button.

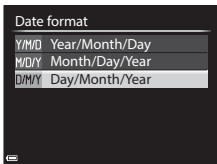

5 Set the date and time, and press the **OK** button.

- Select a field: Press **◀▶** (changes between **D**, **M**, **Y**, **h**, and **m**).
- Edit the date and time: Press **▲▼**.
Date and time can also be changed by rotating the multi selector or command dial.
- Confirm the setting: Select the **m** field and press the **OK** button.

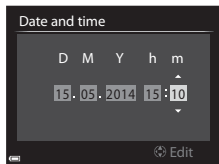

6 Select **Yes** and press the **OK** button.

- When settings are finished, the lens extends and the camera switches to shooting mode.

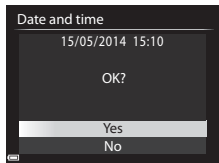

Changing the Language Setting and the Date and Time Setting

- You can change these settings using the **Language** and **Time zone and date** settings in the **Y** setup menu (📖92).
- You can enable or disable daylight saving time in the **Y** setup menu by selecting **Time zone and date** followed by **Time zone**. Enabling day light saving time moves the clock forward one hour, and disabling it moves the clock back one hour.

The Clock Battery

- The camera's clock is powered by a built-in backup battery.
The backup battery charges when the main battery is inserted into the camera or when the camera is connected to an optional AC adapter, and it can run the clock for several days after about 10 hours of charging.
- If the camera's backup battery becomes exhausted, the date and time setting screen is displayed when the camera is turned on. Set the date and time again. See step 2 of "Setting the Display Language, Date, and Time" (📖24) for more information.

Imprinting the Shooting Date on Printed Images

- You can permanently imprint the shooting date on images as they are captured by setting **Print date** in the setup menu.
- If you want the shooting date to be printed without using the **Print date** setting, print using the ViewNX 2 software (📖99).

Step 2 Select a Shooting Mode

Rotate the mode dial to select a shooting mode.

-  (auto) mode is used in this example. Rotate the mode dial to .

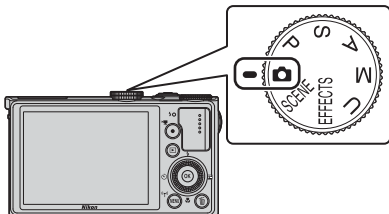

Notes About the Flash

In situations where a flash is needed, such as in dark locations or when the subject is backlit, make sure to raise the flash ( 54).

Available Shooting Modes



Auto mode

(35)

Used for general shooting.

SCENE (Scene) mode

(36)

Camera settings are optimized according to the scene that you select. When using scene auto selector, the camera automatically selects the optimum scene mode when you frame an image, making it even easier to take images using settings that suit the scene.

EFFECTS (Special effects) mode

(44)

Effects can be applied to images during shooting.

P, S, A, M modes

(46)

Select these modes for greater control over shutter speed and aperture value.

U (User settings) mode

(51)

Setting combinations that are frequently used for shooting can be saved. The saved settings can be immediately retrieved for shooting simply by rotating the mode dial to **U**.

Step 3 Frame a Picture

1 Hold the camera steady.

- Keep fingers and other objects away from the lens, flash, AF-assist illuminator, microphone, and speaker.
- When taking pictures in portrait ("tall") orientation, turn the camera so that the flash is above the lens.

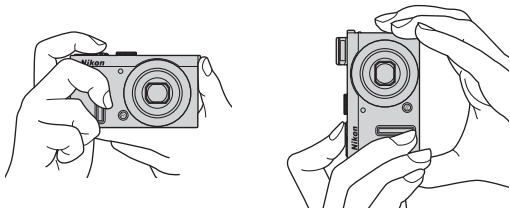

2 Frame the picture.



When Using a Tripod

- We recommend using a tripod to stabilize the camera in the following situations.
 - When shooting in dim lighting with the flash lowered, or in a shooting mode in which the flash is disabled
 - When using the telephoto setting
- When using a tripod to stabilize the camera during shooting, set **Vibration reduction** (📖92) to **Off** in the setup menu to prevent potential errors caused by this function.

Using the Zoom

When you move the zoom control, the zoom lens position changes.

- To zoom in closer to the subject: Move toward **T** (telephoto)
 - To zoom out and view a larger area: Move toward **W** (wide-angle)
 - Rotating the zoom control all the way in either direction adjusts the zoom quickly.
- A zoom indicator is displayed at the top of the monitor when the zoom control is moved.
 - Digital zoom, which allows you to further magnify the subject up to approximately 4x the maximum optical zoom ratio, can be activated by moving and holding the zoom control toward **T** when the camera is zoomed in to the maximum optical zoom position.

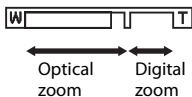
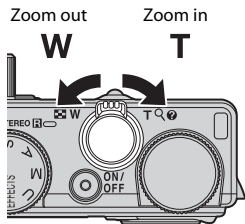

Notes About Digital Zoom

The zoom indicator turns blue when the digital zoom is activated, and it turns yellow when the zoom magnification is increased further.

- Zoom indicator is blue: Image quality is not noticeably reduced by using the Dynamic Fine Zoom.
- Zoom indicator is yellow: Image quality is noticeably reduced.
- The indicator remains blue across a wider area when the image size is smaller.
- The zoom indicator may not turn blue depending on the continuous shooting setting, etc.

Step 4 Focus and Shoot

1 Press the shutter-release button halfway.

- When the subject is in focus, the focus area that includes the subject or focus indicator (📖 10) glows green (multiple focus areas can glow green).
- When you are using digital zoom, the camera focuses on the subject in the center of the frame and the focus area is not displayed. When the camera has focused, the focus indicator glows green.
- If the focus area or focus indicator flashes red, the camera is unable to focus. Modify the composition and try pressing the shutter-release button halfway again.

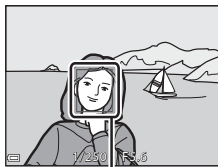
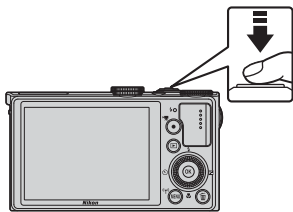



Focus area

2 Without lifting your finger, press the shutter-release button the rest of the way down.



The Shutter-release Button

<p>Press halfway</p>		<p>To set focus and exposure (shutter speed and aperture value), press the shutter-release button lightly until you feel a slight resistance. Focus and exposure remain locked while the shutter-release button is pressed halfway.</p>
<p>Press all the way</p>		<p>Press the shutter-release button all the way to release the shutter and take an image. Do not use force when pressing the shutter-release button, as this may result in camera shake and blurred images. Press the button gently.</p>

Notes About Saving Images and Recording Movies

The indicator showing the number of exposures remaining or the indicator showing the maximum movie length flashes while images are being saved or while a movie is being recorded. **Do not open the battery-chamber/memory card slot cover or remove the battery or memory card** while an indicator is flashing. Doing this could result in loss of data, or in damage to the camera or the memory card.



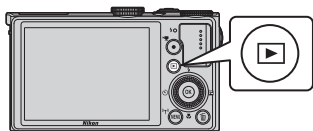

Step 5 Play Back Images

1 Press the (playback) button.

- If you press and hold down the  (playback) button while the camera is turned off, the camera turns on in playback mode.



2 Use the multi selector to select an image to display.

- Press and hold down    to scroll through the images quickly.
- Images can also be selected by rotating the multi selector.
- To return to shooting mode, press the  button or shutter-release button.

Display the previous image

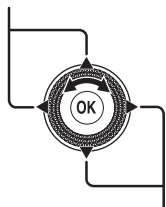



Display the next image



Current image number/
Total number of images

Displaying Shooting Information

Press the  button in full-frame playback mode to display the tone level and shooting information (14).

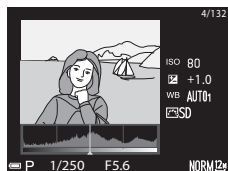

Press the  button again to return to full-frame playback mode.

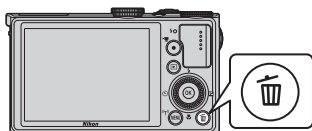

Step 6 Delete Images

- 1 Press the  button to delete the image currently displayed in the monitor.



- 2 Use the multi selector   to select the desired deletion method and press the  button.

- To exit without deleting, press the **MENU** button.
- See "Operating the Erase Selected Images Screen" (📖34) for more information.

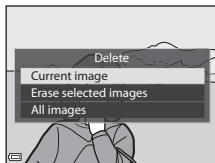

- 3 Select **Yes** and press the  button.

- Deleted images cannot be recovered.
- To cancel, select **No** and press the  button.

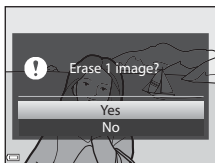

Operating the Erase Selected Images Screen

1 Use the multi selector ◀▶ to select an image to be deleted, and then use ▲ to display ✓.

- To undo the selection, press ▼ to remove ✓.
- Move the zoom control (📖29) toward T (Q) to switch to full-frame playback or W (📖) to switch to thumbnail playback.



2 Add ✓ to all images that you want to delete and then press the OK button to confirm the selection.

- A confirmation dialog is displayed. Follow the instructions displayed in the monitor.

✓ Notes About RAW and JPEG Images Saved at the Same Time

Note that when images taken with an **Image quality** (🔑23) setting of **RAW (NRW) + Fine** or **RAW (NRW) + Normal** are deleted on this camera, both the RAW (NRW) and JPEG images that were saved at the same time are deleted. It is not possible to delete only RAW (NRW) or JPEG images.

✓ Deleting Images in a Sequence

- If you press the 🗑️ button and delete a key picture while only key pictures are displayed for sequences of images (📖84), all images in the sequence, including the key picture, are deleted.
- To delete individual images in a sequence, press the OK button to display them one at a time and press the 🗑️ button.

📎 Deleting the Last Image Captured While in Shooting Mode

When using shooting mode, press the 🗑️ button to delete the last image that was saved.

Shooting Features

(Auto) Mode

Used for general shooting.

- The camera detects the main subject and focuses on it. If a human face is detected, the camera automatically sets focus priority on it.
- See “Focusing” (📖77) for more information.

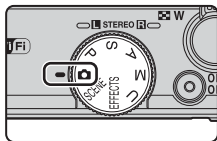

Functions Available in (Auto) Mode

- Flash mode (📖54)
- Self-timer (📖57)
- Smile timer (📖58)
- Focus mode (📖59)
- Exposure compensation (📖63)
- Shooting menu (📖66)
- Control ring (📖69)

Scene Mode (Shooting Suited to Scenes)

When a scene is selected, camera settings are automatically optimized for the selected scene.

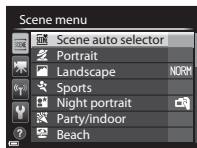
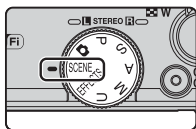

Press the **MENU** button to display the scene menu and select one of the following scenes using the multi selector.

Scene auto selector (default setting) (📖37)	Night landscape (📖39) ^{1, 2}
Portrait	Close-up (📖40)
Landscape ^{1, 2}	Food (📖40)
Sports (📖38) ¹	Museum (📖40) ¹
Night portrait(📖39)	Fireworks show (📖41) ^{2, 3}
Party/indoor (📖39) ¹	Black and white copy (📖41) ¹
Beach ¹	Backlighting (📖41) ¹
Snow ¹	Easy panorama (📖42) ¹
Sunset ^{1, 2, 3}	Pet portrait (📖43)
Dusk/dawn ^{1, 2, 3}	

¹ The camera focuses on the area in the center of the frame. The position of the area cannot be moved.

² The camera focuses at infinity.

³ Use of a tripod is recommended, because the shutter speed is slow. Set **Vibration reduction** (📖92) to **Off** in the setup menu when using a tripod to stabilize the camera during shooting.

Notes About the Command Dial Operation When the Shooting Screen is Displayed

Rotating the mode dial to **SCENE** and then rotating the command dial also allows you to select a scene.













To View a Description (Help Display) of Each Scene



Select a scene and move the zoom control (📖1) toward **T** (🔍) to view a description of that scene. To return to the original screen, move the zoom control toward **T** (🔍) again.

Tips and Notes

Scene auto selector

- When you point the camera at the subject, the camera automatically selects the optimum scene mode from the list below and adjusts the shooting settings accordingly.

	Portrait (close-up image of one to two persons)
	Portrait (shooting an image of three or more persons or shooting a composition with a large background area)
	Landscape
	Night portrait (close-up image of one to two persons)
	Night portrait (shooting an image of three or more persons or shooting a composition with a large background area)
	Night landscape <ul style="list-style-type: none">The camera shoots images continuously and combines and saves them as one image in the same way as when Hand-held in  (night landscape) (39) is selected.
	Close-up
	Backlighting (shooting non-human subjects)
	Backlighting (shooting human subjects)
	Other shooting scenes

- Depending upon shooting conditions, the camera may not select the desired scene mode. Should this occur, switch to  (auto) mode (26) or select the optimum scene mode for the subject manually.





 Landscape

- From the screen displayed after **Landscape** is selected, select **Noise reduction burst** or **Single shot**.
- **Noise reduction burst**: This enables you to shoot a sharp landscape with a minimum of noise.
 - Press the shutter-release button all the way to capture a series of images which are combined into a single image and saved.
 - Once the shutter-release button is pressed all the way, hold the camera still until a still image is displayed. After taking an image, do not turn the camera off before the monitor switches to the shooting screen.
 - The angle of view (i.e., the area visible in the frame) seen in the saved image is narrower than that seen in the monitor at the time of shooting.
- **Single shot** (default setting): Saves images with emphasized outlines and contrast.
 - One image is captured when the shutter-release button is pressed all the way.

 Sports

- While the shutter-release button is held all the way down, the camera shoots up to about 10 images continuously at a rate of about 10 fps (when image quality is set to **Normal** and image size is set to  **4000x3000**).
- The frame rate for continuous shooting may become slow depending upon the current image quality setting, image size setting, the memory card used, or shooting condition.
- Focus, exposure, and hue are fixed at the values determined with the first image in each series.





Night portrait

- From the screen displayed after **Night portrait** is selected, select  **Hand-held** or  **Tripod**.
- One image is captured at a slow shutter speed. Compared to using  **Tripod**, when  **Hand-held** is selected, the camera sets a slightly faster shutter speed in accordance with the shooting conditions to prevent camera shake.
- Vibration reduction is disabled regardless of the **Vibration reduction** ( 92) setting in the setup menu.
- The flash always fires. Raise the flash before shooting.

Party/indoor





- To avoid the effects of camera shake, hold the camera steady. Set **Vibration reduction** ( 92) to **Off** in the setup menu when using a tripod to stabilize the camera during shooting.

Night landscape







- From the screen displayed after **Night landscape** is selected, select  **Hand-held** or  **Tripod**.
-  **Hand-held** (default setting):
 - Press the shutter-release button all the way to capture a series of images which are combined into a single image and saved.
 - Once the shutter-release button is pressed all the way, hold the camera still until a still image is displayed. After taking an image, do not turn the camera off before the monitor switches to the shooting screen.
 - The angle of view (i.e., the area visible in the frame) seen in the saved image is narrower than that seen in the monitor at the time of shooting.
-  **Tripod**:
 - One image is captured at a slow shutter speed when the shutter-release button is pressed all the way.
 - Vibration reduction is disabled regardless of the **Vibration reduction** ( 92) setting in the setup menu.

Close-up

From the screen displayed after  **Close-up** is selected, select **Noise reduction burst** or **Single shot**.

- **Noise reduction burst:** This enables you to shoot a sharp image with a minimum of noise.
 - Press the shutter-release button all the way to capture a series of images which are combined into a single image and saved.
 - Once the shutter-release button is pressed all the way, hold the camera still until a still image is displayed. After taking an image, do not turn the camera off before the monitor switches to the shooting screen.
 - If the subject moves or there is a significant camera shake during continuous shooting, the image may be distorted, overlapped, or blurred.
 - The angle of view (i.e., the area visible in the frame) seen in the saved image is narrower than that seen in the monitor at the time of shooting.
- **Single shot** (default setting): Saves images with emphasized outlines and contrast.
 - One image is captured when the shutter-release button is pressed all the way.
- The focus mode () setting is changed to  (macro close-up) and the camera automatically zooms to the closest position at which it can focus.
- You can move the focus area. Press the  button, use the multi selector  or rotate it to move the focus area, and press the  button to apply the setting.

Food

- The focus mode () setting is changed to  (macro close-up) and the camera automatically zooms to the closest position at which it can focus.
- You can adjust hue by using the control ring () (69). The hue setting is saved in the camera's memory even after the camera is turned off.
- You can move the focus area. Press the  button, use the multi selector  or rotate it to move the focus area, and press the  button to apply the setting.

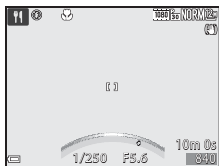



Museum

- The camera captures a series of up to 10 images while the shutter-release button is held all the way down, and the sharpest image in the series is automatically selected and saved (BSS (Best Shot Selector)).
- The flash does not fire.

Fireworks show

- The shutter speed is fixed at about 4 seconds.



Black and white copy

- Use together with  (macro close-up) focus mode (59) when shooting subjects that are close to the camera.



Backlighting

- From the screen displayed after  **Backlighting** is selected, HDR (high dynamic range) composition can be set.
- **Off** (default setting): The flash fires to prevent the subject from being hidden in shadow. Shoot images with the flash raised.
- **Level 1-Level 3**: Use when taking images with very bright and dark areas in the same frame. Select **Level 1** when there is less difference between bright and dark areas, and **Level 3** when there is more difference between bright and dark areas.

Notes About HDR

- Use of a tripod is recommended. Set **Vibration reduction** (92) in the setup menu to **Off** when using a tripod to stabilize the camera.
- The angle of view (i.e., the area visible in the frame) seen in the saved image is narrower than that seen in the monitor at the time of shooting.
- When the shutter-release button is pressed all the way, the camera shoots images continuously and saves the following two images.
 - A non-HDR composite image
 - An HDR composite image in which the loss of details in highlights or shadows is minimized
- If there is only enough memory to save one image, an image processed by D-Lighting (83) at the time of shooting, in which dark areas of the image are corrected, is the only image saved.
- Once the shutter-release button is pressed all the way, hold the camera still until a still image is displayed. After taking an image, do not turn the camera off before the monitor switches to the shooting screen.
- Depending on the shooting conditions, dark shadows may appear around bright subjects and bright areas may appear around dark subjects. You can compensate by lowering the level setting.

Easy panorama

- From the screen displayed after  **Easy panorama** is selected, select the shooting range from **Normal (180°)** (default setting) or **Wide (360°)**.
 - The zoom position is fixed at wide-angle.
 - Press the shutter-release button all the way down, remove your finger from the button, and then slowly pan the camera horizontally. Shooting ends when the camera captures the specified shooting range.
 - Focus and exposure are locked when shooting starts.
 - If you press the  button when a captured image is displayed in full-frame playback mode, the image scrolls automatically.
 - The images cannot be edited on this camera.
- See "Using Easy Panorama (Shooting and Playback)" (2) for more information.



Notes About Printing Panorama Images

The entire image may not be able to be printed depending on the printer's settings. Additionally, printing may not be possible depending on the printer.

Pet portrait

- When you point the camera at a dog or cat, the camera detects the pet's face and focuses on it. By default, the shutter is automatically released when a dog or cat face is detected (pet portrait auto release).
- From the screen displayed after  **Pet portrait** is selected, select **Single** or **Continuous**.
 - **Single**: Whenever a dog or cat face is detected, the camera captures 1 image.
 - **Continuous**: Whenever a dog or cat face is detected, the camera captures 3 images continuously.

Pet Portrait Auto Release

- Press the multi selector  to change the **Pet portrait auto release** settings.
 - : The camera automatically releases the shutter when it detects a dog or cat face.
 - **Off**: The camera does not release the shutter automatically, even if a dog or cat face is detected. Press the shutter-release button. The camera also detects human faces when **Off** is selected.
- **Pet portrait auto release** is set to **Off** after 5 bursts have been taken.
- Shooting is also possible by pressing the shutter-release button, regardless of the **Pet portrait auto release** setting. When **Continuous** is selected, you can take images continuously while holding down the shutter-release button all the way.

Focus Area

- When the camera detects a face, the face is displayed inside a yellow border. When the camera acquires focus on a face displayed inside a double border (focus area), the double border turns green. If no faces are detected, the camera focuses on the area in the center of the frame.
- In some shooting conditions, the pet face may not be detected and other subjects may be displayed inside a border.

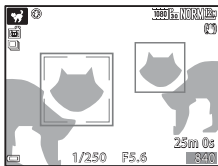

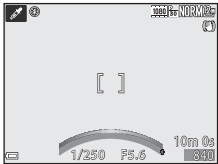
Option	Description
Painting*	Gives the image a painting-like appearance.
High key	Gives the entire image a bright tone.
Low key	Gives the entire image a dark tone.
Selective color	<p>Keeps only a selected color and makes other colors black-and-white.</p> <ul style="list-style-type: none"> Select a color that you want to retain by using the control ring. 
High ISO monochrome	<p>Creates monotone (black-and-white) images by intentionally taking images with high ISO sensitivity. This setting is effective when shooting subjects in low lighting conditions.</p> <ul style="list-style-type: none"> The images taken may contain noise (randomly-spaced bright pixels, spots or lines). You can perform fine adjustment of contrast by using the control ring.
Cross process	<p>Creates images with an unusual hue by converting a positive color image into negative or negative color image into positive.</p> <ul style="list-style-type: none"> You can perform fine adjustment of hue by using the control ring.

* Some effects cannot be selected depending on the setting of **Movie options** (p.90).

Functions Available in Special Effects Mode

- Flash mode (p.54)
- Self-timer (p.57)
- Focus mode (p.59)
- Exposure compensation (p.63)
- Shooting menu (p.66)

P, S, A, M Modes (Setting the Exposure for Shooting)

Images can be shot with greater control by setting the shooting menu (📖66) items in addition to setting the shutter speed or aperture value manually according to shooting conditions and requirements.

- The focus area for autofocus differs depending on the setting of **AF area mode** (📖67).
- When **AF area mode** is set to **Target finding AF** (default setting), the camera detects the main subject and focuses on it.

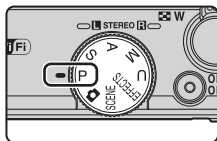

Rotate the command dial or multi selector to set the shutter speed and aperture value.

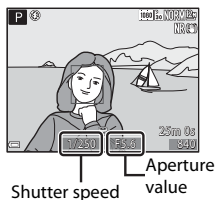
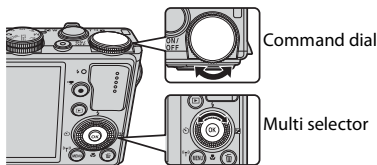

Exposure mode	Shutter speed (📖50)	Aperture value (📖47)
P Programmed auto (📖48)	Automatically adjusted (flexible program is enabled by the command dial).	
S Shutter-priority auto (📖48)	Adjusted by the command dial.	Automatically adjusted.
A Aperture-priority auto (📖48)	Automatically adjusted.	Adjusted by the multi selector.
M Manual (📖48)	Adjusted by the command dial.	Adjusted by the multi selector.

More Information

See "Toggle Av/Tv selection" (📖93) for more information.

Exposure

The procedure for shooting images at the desired brightness (exposure) by adjusting the shutter speed or aperture value is called “determine exposure.” The sense of dynamism and amount of background defocus in images to be shot vary depending on the combinations of shutter speed and aperture value even if the exposure is the same.

Adjusting the Shutter Speed

In **S** mode, the range is from a maximum of 1/2000 to 15 seconds.

In **M** mode, the range is from a maximum of 1/2000 to 60 seconds.

See “The Control Range of the Shutter Speed” (📖 50) for more information.



Faster 1/1000 s



Slower 1/30 s

Adjusting the Aperture Value

In **A** and **M** modes, the range is from f/1.8 to 8 (wide-angle position) and from f/5.6 to 8 (telephoto zoom position).



Larger aperture (Small f-number)
f/1.8



Smaller aperture (Large f-number)
f/8

Aperture Value (F-number) and Zoom

Large apertures (expressed by small f-numbers) let more light into the camera, and small apertures (large f-numbers) let less light.

The aperture value of the zoom lens of this camera changes depending on the zoom position. When zooming to the wide-angle position and telephoto zoom position, the aperture values are f/1.8 and f/5.6, respectively.

P (Programmed auto)

Use for automatic control of the exposure by the camera.

- Different combinations of shutter speed and aperture value can be selected without changing the exposure by rotating the command dial ("flexible program"). While flexible program is in effect, a flexible program mark (**⌘**) is displayed next to the mode indicator (**P**) in the upper left of the monitor.
- To cancel flexible program, rotate the command dial until the flexible program mark (**⌘**) is no longer displayed. Selecting another shooting mode, or turning off the camera, also cancels flexible program.

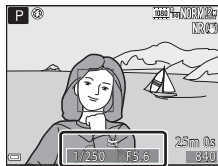

S (Shutter-priority auto)

Use to shoot fast-moving subjects at a fast shutter speed, or use to emphasize the movements of a moving subject at a slow shutter speed.

- The shutter speed can be adjusted by rotating the command dial.

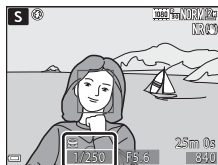

A (Aperture-priority auto)

Use to bring subjects including both the foreground and background into focus or blur the subject's background intentionally.

- The aperture value can be adjusted by rotating the multi selector.

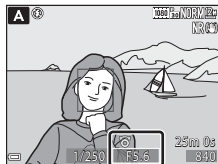

M (Manual)

Use to control the exposure according to shooting requirements.

- When adjusting the aperture value or shutter speed, the degree of deviation from the exposure value measured by the camera is displayed in the exposure indicator of the monitor. The degree of deviation in the exposure indicator is displayed in EVs (-2 to +2 EV in increments of 1/3 EV).
- The shutter speed can be adjusted by rotating the command dial and the aperture value can be adjusted by rotating the multi selector.

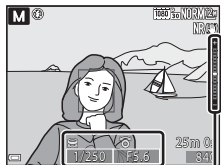

Exposure indicator

✓ Notes About Shooting

- When zooming is performed after the exposure is set, exposure combinations or aperture value may be changed.
- When the subject is too dark or too bright, it may not be possible to obtain the appropriate exposure. In such cases, the shutter speed indicator or aperture value indicator flashes when the shutter-release button is pressed halfway (except when the **M** mode is used). Change the shutter speed setting or aperture value.

✓ Notes About ISO Sensitivity

When **ISO sensitivity** (📖67) is set to **Auto** (default setting) or **Fixed range auto**, the ISO sensitivity in **M** mode is fixed at ISO 80.

📎 Built-in ND Filter



When the subject is too bright, set **Built-in ND filter** in the shooting menu (📖66) to reduce the light and shoot.

Functions Available in P, S, A, M Modes

- Flash mode (📖54)
- Self-timer (📖57)
- Smile timer (📖58)
- Focus mode (📖59)
- Exposure compensation (📖63)
- Shooting menu (📖66)
- Control ring (📖69)
- Functions That Can Be Set Using the **Fn** (Function) Button (📖71)
- Setup menu (📖92)

The Control Range of the Shutter Speed

The control range of the shutter speed differs depending on the aperture value or the ISO sensitivity setting. Additionally, the control range changes in the following continuous shooting settings.

Setting		Control range
ISO sensitivity ( 67) ¹	Auto ² , Fixed range auto ²	1/2000 - 1 s (P, S, A modes) 1/2000 - 60 s (M mode)
	ISO 80, 100	1/2000 - 15 s (P, S, A modes) 1/2000 - 60 s (M mode)
	ISO 200	1/2000 - 8 s (P, S, A modes) 1/2000 - 60 s (M mode)
	ISO 400	1/2000 - 4 s (P, S, A modes) 1/2000 - 60 s (M mode)
	ISO 800	1/2000 - 2 s (P, S, A modes) 1/2000 - 30 s (M mode)
	ISO 1600	1/2000 - 1 s (P, S, A modes) 1/2000 - 15 s (M mode)
	ISO 3200	1/2000 - 1/2 s (P, S, A modes) 1/2000 - 8 s (M mode)
	ISO 6400	1/2000 - 1/4 s (P, S, A modes) 1/2000 - 2 s (M mode)
	Hi 1	1/2000 - 1/8 s (P, S, A modes) 1/2000 - 2 s (M mode)
	Continuous ( 67)	Continuous H, Continuous L, BSS
Pre-shooting cache, Multi-shot 16		1/4000 - 1/30 s
Continuous H: 120 fps		1/4000 - 1/125 s
Continuous H: 60 fps		1/4000 - 1/60 s
Intvl timer shooting		Same as when Single is set

¹ The ISO sensitivity setting is restricted depending on the continuous shooting setting (72).

² In **M** mode, the ISO sensitivity is fixed at ISO 80.

U (User Settings) Mode

Setting combinations that are frequently used for shooting (User settings) can be saved in **U**. Shooting is possible in **P** (programmed auto), **S** (shutter-priority auto), **A** (aperture-priority auto) or **M** (manual).

Rotate the mode dial to **U** to retrieve the settings saved in **Save user settings**.

- Frame the subject and shoot with these settings, or change the settings as required.
- The setting combinations that are retrieved when the mode dial is rotated to **U** can be changed as many times as you want in **Save user settings**.

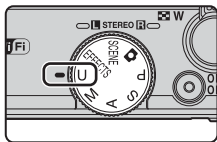

The following settings can be saved.

General Settings

- Shooting modes **P, S, A, M** (📖46)
- Focus mode (📖59)
- Zoom position (📖29)
- Exposure compensation (📖63)
- Flash mode (📖54)
- Fn button (📖71)
- Self-timer (📖57)

Shooting menu

- Image quality (📖66)
- Image size (📖66)
- Picture Control (📖66)
- Custom Picture Control (📖66)
- White balance (📖66)
- Metering (📖67)
- Continuous (📖67)
- ISO sensitivity (📖67)
- Exposure bracketing (📖67)
- AF area mode (📖67)
- Autofocus mode (📖67)
- Flash exp. comp. (📖67)
- Noise reduction filter (📖67)
- Built-in ND filter (📖67)
- Active D-Lighting (📖67)
- Multiple exposure (📖68)
- Zoom memory (📖68)
- Startup zoom position (📖68)
- M exposure preview (📖68)

Saving Settings in U Mode (Save User Settings)

The frequently used settings for shooting can be changed and saved in **U**.

1 Rotate the mode dial to the original shooting mode.

- Rotate the mode dial to **P**, **S**, **A** or **M** (📖46). The flexible program (when set to **P**), shutter speed (when set to **S** or **M**) or aperture value (when set to **A** or **M**) will also be saved.
- Settings can also be saved by rotating the mode dial to **U** (the default settings for the shooting mode **P** are saved at the time of purchase).

2 Change to a frequently used combination of shooting settings.

- See 📖51 for settings details.

3 Press the MENU button to display the shooting menu.

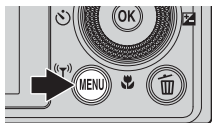

4 Use the multi selector ▲▼ to select **Save user settings**, and press the OK button.

- The current settings are saved.

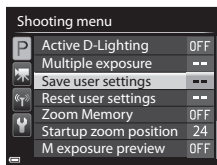

✓ The Clock Battery

If the internal clock battery (📖25) is exhausted, the settings saved in **U** will be reset. Writing down any important setting is recommended.

🔧 Resetting U (User Settings) Mode

If **Reset user settings** is selected in the shooting menu, the settings that are saved in the user settings are restored to their default values. The shooting mode is set to **P**.

Functions That Can Be Set Using the Multi Selector

The functions that are available vary with the shooting mode, as shown below.

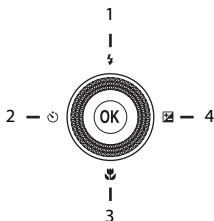

Function		SCENE	EFFECTS	P, S, A, M, U
1 Flash mode (📖54)	✓	1	1	✓
2 Self-timer (📖57)	✓		✓	✓
Smile timer (📖58)	✓		-	✓
3 Focus mode (📖59)	✓		✓	✓
4 Exposure compensation (📖63)	✓		✓	✓ ²

¹ Availability depends on the setting. See "Default Settings" (📖64) for more information.

² When the shooting mode is **M**, exposure compensation cannot be used.

Using the Flash

You can shoot images with a flash by raising the built-in flash. You can set the flash mode to match the shooting conditions.

1 Lower the ⚡🔒 (flash pop-up) control to raise the flash.

- When the flash is lowered, flash operation is disabled and 🔒 is displayed.

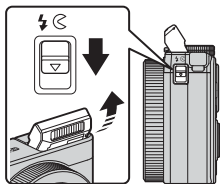

2 Press the multi selector ▲ (⚡).



3 Select the desired flash mode (📖55) and press the Ⓞ button.

- If a setting is not applied by pressing the Ⓞ button within a few seconds, the selection will be canceled.

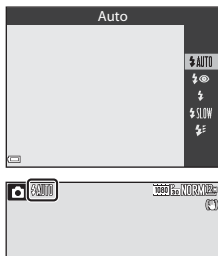

✓ The Flash Lamp

The status of the flash can be confirmed by pressing the shutter-release button halfway.

- On: The flash fires when you press the shutter-release button all the way down.
- Flashing: The flash is charging. The camera cannot shoot images.
- Off: The flash does not fire when an image is taken.

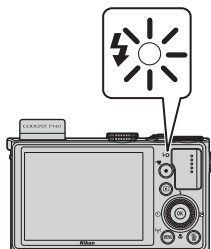

Available Flash Modes

⚡AUTO Auto

The flash fires when necessary, such as in dim lighting.

- The flash mode indicator is only displayed immediately after setting in the shooting screen.

⚡👁️ Auto with red-eye reduction/Red-eye reduction

Reduce red-eye in portraits caused by the flash (📖56).

- When **Red-eye reduction** is selected, the flash fires whenever an image is taken.

⚡ Fill flash/Standard flash

The flash fires whenever an image is taken.

⚡SLOW Slow sync







Suited to evening and night portraits that include background scenery. Fill flash fires to illuminate the main subject; slow shutter speeds are used to capture background at night or under dim lighting.

⚡🕒 Rear-curtain sync



Fill flash fires just before the shutter closes, creating the effect of a stream of light behind moving subjects.

The Flash Mode Setting

- The available flash modes differ depending on the shooting mode.

Flash mode		SCENE	EFFECTS	P	S	A	M
 AUTO Auto	✓			-	-	-	-
 Auto with red-eye reduction	✓			-	-	-	-
Red-eye reduction	-	*	*	✓	✓	✓	✓
 Fill flash	✓			-	-	-	-
Standard flash	-			✓	✓	✓	✓
 SLOW Slow sync	✓			✓	-	✓	-
 Rear-curtain sync	✓			✓	✓	✓	✓

* Availability depends on the setting. See "Default Settings" (📖64) for more information.

- The setting applied in the following situations is saved in the camera's memory even after the camera is turned off.
 - When shooting mode **P**, **S**, **A** or **M** is used
 - When  (auto with red-eye reduction) is selected in  (auto) mode

Lowering the Flash

When not using the flash, gently push to lower the flash until it clicks shut.

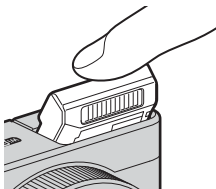

Auto with Red-eye Reduction/Red-eye Reduction

If the camera detects red-eye while saving an image, the affected area is processed to reduce red-eye before the image is saved.

Note the following when shooting:

- More time than usual is required to save images.
- Red-eye reduction may not produce the desired results in all situations.
- In some cases, red-eye reduction may be applied to areas of an image unnecessarily. In these cases, select another flash mode and take the image again.

Using the Self-timer

The camera is equipped with a self-timer that releases the shutter about 10 seconds or 2 seconds after you press the shutter-release button. Set **Vibration reduction** (📖92) to **Off** in the setup menu when using a tripod to stabilize the camera during shooting.

- 1 Press the multi selector ◀ (🕒).

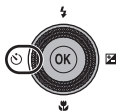

- 2 Select 🕒10s (or 🕒2s), and press the OK button.

- 🕒10s (10 seconds): Use on important occasions, such as weddings.
- 🕒2s (2 seconds): Use to prevent camera shake.
- If a setting is not applied by pressing the OK button within a few seconds, the selection will be canceled.
- When the shooting mode is **Pet portrait** scene mode, 🐾 (pet portrait auto release) is displayed (📖43). The self-timer cannot be used.

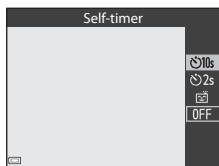

- 3 Frame the picture and press the shutter-release button halfway.

- Focus and exposure are set.

- 4 Press the shutter-release button the rest of the way down.

- Countdown starts. The self-timer lamp flashes and then glows steadily about one second before the shutter is released.
- When the shutter is released, the self-timer is set to **OFF**.
- To stop the countdown, press the shutter-release button again.

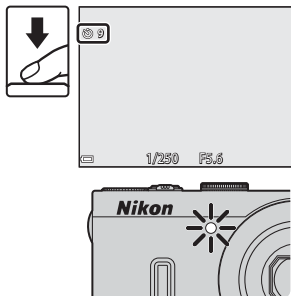

Shooting Smiling Faces Automatically (Smile Timer)

When the camera detects a smiling face, you can take an image automatically without pressing the shutter-release button.

- This function can be used when the shooting mode is **☑** (auto), **P**, **S**, **A**, **M** or **U**, or **Portrait** or **Night portrait** scene mode.

1 Press the multi selector ◀ (☺).

- Change any flash mode, exposure, or shooting menu settings before pressing ◀.



2 Select (smile timer), and press the **OK** button.

- If a setting is not applied by pressing the **OK** button within a few seconds, the selection will be canceled.

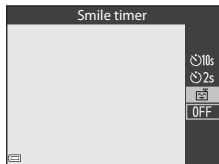

3 Frame the picture and wait for the subject to smile without pressing the shutter-release button.

- Point the camera at a human face.
- If the camera detects that the face framed by the double border is smiling, the shutter is automatically released.
- Whenever the camera detects a smiling face, it automatically releases the shutter.

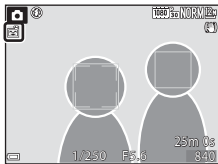

4 End automatic shooting.

- To end automatic shooting with smile timer, return to step 1 and select **OFF**.

Notes About Smile Timer

Under some shooting conditions, the camera may be unable to detect faces or detect smiles (📖78). The shutter-release button can also be used for shooting.

When the Self-timer Lamp Flashes

When using smile timer, the self-timer lamp flashes when the camera detects a face and flashes quickly immediately after the shutter is released.

Using Focus Mode

Set the focus mode according to the distance to the subject.

- 1 Press the multi selector ▼ (👉).



- 2 Select the desired focus mode and press the **OK** button.

- If a setting is not applied by pressing the **OK** button within a few seconds, the selection will be canceled.

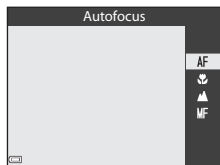

Available Focus Modes

AF

Autofocus



The camera automatically adjusts the focus according to the distance to the subject. Use when the distance from the subject to the lens is 30 cm (1 ft) or more, or 50 cm (1 ft 8 in.) or more at the maximum telephoto zoom position.

- The focus mode icon on the shooting screen is displayed only immediately after the setting is made.



Macro close-up

Set when taking close-up images.

When the zoom ratio is set to a position where  and the zoom indicator glow green, the camera can focus on subjects as close as approximately 10 cm (4 in.) from the lens. When the zoom is at the position where  is displayed, the camera can focus on subjects as close as approximately 2 cm (0.8 in.) from the lens.



Infinity

Use when shooting distant scenes through window glass or when shooting landscapes.

The camera automatically adjusts the focus near infinity.

- The camera may not be able to focus on nearby objects.
- The flash mode is set to  (off).

MF

Manual focus

The focus can be adjusted on any subject at a distance from approximately 2 cm (0.8 in.) to infinity from the lens ( 61). The closest distance at which the camera can focus varies depending on the zoom position.



Notes About Shooting with the Flash

The flash may be unable to light the entire subject at distances of less than 50 cm (1 ft 8 in.).



Focus Mode Setting

- The setting may not be available with some shooting modes.
- For shooting modes **P**, **S**, **A** and **M**, the setting is saved in the camera's memory even after the camera is turned off.



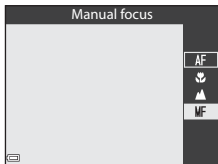
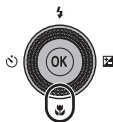

Taking Images with Manual Focus

Available when the shooting mode is **P**, **S**, **A**, **M** or **U**, special effects mode or **Sports** scene mode.

- 1 Press the multi selector , select **MF** (manual focus), and then press the **OK** button.



- 2 Use the multi selector to adjust the focus while checking the enlarged view.

- An enlarged view of the center area of the image is displayed. Press  to switch the view between 2x and 4x.
- Rotate the multi selector clockwise to focus on near subjects, or counterclockwise to focus on far subjects. The focus can be adjusted in higher detail by rotating the multi selector slowly or rotating the command dial.
- When  is pressed, the camera focuses on the subject in the center of the frame with autofocus. First the camera focuses with autofocus, and then the manual focus can be operated.
- Focusing is assisted by highlighting areas that are in focus in white (peaking) (62). Press  to adjust the peaking level.
- Press the shutter-release button halfway to frame the picture. Press the shutter-release button all the way to take the image.

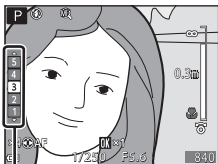

Peaking level

- 3 Press the **OK** button.

- The set focus is locked.
- Press the shutter-release button all the way to take the image.
- To readjust the focus, press the **OK** button to display the screen in step 2.

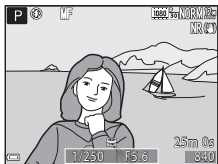

MF (Manual Focus)

- The digits displayed for the gauge on the right of the monitor in step 2 serve as a guideline for the distance to a subject that is in focus when the gauge is near the center.
- The actual range at which the subject can be in focus varies depending on the aperture value and zoom position. To see whether the subject is in focus, check the image after shooting.
- Manual focus operations can also be assigned to the control ring (69).

Notes About Peaking

- The range of the contrast level considered to be in focus can be changed by adjusting the peaking level. It is effective to set the level low for high contrast subjects, and high for low contrast subjects.
- Peaking highlights high contrast areas of the image in white. Depending on the shooting conditions, highlighting may not work properly or areas that are not in focus may be highlighted.
- You can disable the peaking display using **Peaking** in the setup menu (93).

Adjusting Brightness (Exposure Compensation)

You can adjust overall image brightness.

- 1 Press the multi selector ► (⊕).



- 2 Select a compensation value and press the **OK** button.

- To brighten the image, set a positive (+) value.
- To darken the image, set a negative (-) value.
- The compensation value is applied, even without pressing the **OK** button.

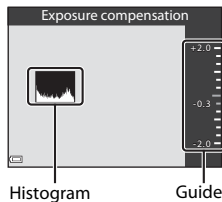

Exposure Compensation Value

- The value applied in **P**, **S** or **A** mode is saved in the camera's memory even after the camera is turned off.
- When the shooting mode is **Fireworks show** scene mode (📖41) or **M** (manual) (📖48), exposure compensation cannot be used.
- When the exposure compensation is set while using a flash, the compensation is applied to both the background exposure and to the flash output.





















Using the Histogram









A histogram is a graph showing the distribution of tones in the image. Use as a guide when using exposure compensation and shooting without the flash.

- The horizontal axis corresponds to pixel brightness, with dark tones to the left and bright tones to the right. The vertical axis shows the number of pixels.
- Increasing exposure compensation value shifts tone distribution to the right, and decreasing it shifts tone distribution to the left.

Default Settings

The default settings for each shooting mode are described below.

Shooting mode	Flash mode ( 54)	Self-timer ( 57)	Focus mode ( 59)	Exposure compensation ( 63)
 (auto)	 AUTO	OFF ¹	AF ²	0.0
EFFECTS (special effects)	 ³	OFF	AF	0.0
P, S, A, M		OFF ¹	AF	0.0
U (user settings)		OFF ¹	AF	0.0
Scene				
 (scene auto selector)	 AUTO ⁴	OFF	AF ⁵	0.0
 (portrait)	 	OFF ¹	AF ⁵	0.0
 (landscape)	 ⁵	OFF	 ⁵	0.0
 (sports)	 ⁵	OFF ⁵	AF ⁶	0.0
 (night portrait)	  ⁷	OFF ¹	AF ⁵	0.0
 (party/indoor)	  ⁸	OFF	AF ⁵	0.0
 (beach)	 AUTO	OFF	AF ⁹	0.0
 (snow)	 AUTO	OFF	AF ⁹	0.0
 (sunset)	 ⁵	OFF	 ⁵	0.0
 (dusk/dawn)	 ⁵	OFF	 ⁵	0.0
 (night landscape)	 ⁵	OFF	 ⁵	0.0
 (close-up)	 ¹⁰	OFF	 ⁵	0.0
 (food)	 ⁵	OFF	 ⁵	0.0
 (museum)	 ⁵	OFF	AF ⁹	0.0
 (fireworks show)	 ⁵	OFF ⁵	 ⁵	0.0 ⁵
 (black and white copy)	 ⁵	OFF	AF ⁹	0.0
 (backlighting)	  ¹¹	OFF	AF ⁵	0.0

Shooting mode	Flash mode ( 54)	Self-timer ( 57)	Focus mode ( 59)	Exposure compensation ( 63)
 (easy panorama)	 ⁵	OFF ⁵	AF ⁵	0.0
 (pet portrait)	 ⁵	 ¹²	AF ⁹	0.0

¹ Smile timer can also be selected.

² MF (manual focus) cannot be selected.

³ The flash is fixed at  (off) when High ISO monochrome is selected.

⁴ The setting cannot be changed. The camera automatically selects the flash mode appropriate for the scene it has selected.

⁵ The setting cannot be changed.



⁶ AF (autofocus) or MF (manual focus) can be selected.

⁷ The setting cannot be changed. The flash mode setting is fixed at fill flash with slow sync and red-eye reduction.

⁸ May switch to slow sync with red-eye reduction flash mode.

⁹ AF (autofocus) or  (macro close-up) can be selected.

¹⁰ The flash is fixed at  (off) when using **Noise reduction burst**.

¹¹ When HDR is set to **Off**, the flash mode is fixed at  (fill flash). When HDR is set to any setting other than **Off**, the flash mode is fixed at  (off).

¹² Pet portrait auto release (43) can be set to on or off. Self-timer cannot be used.

Functions That Can Be Set with the MENU Button (Shooting Menu)

The settings listed below can be changed by pressing the **MENU** button during shooting.

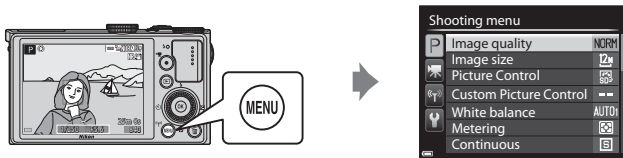

















Common Options

Option	Description	
Image quality	Allows you to set the image quality (compression ratio) of images to be saved. • Default setting: Normal	23
Image size	Allows you to set the image size of images to be saved. • Default setting: 4000x3000	25

For P, S, A, M, U modes

Option	Description	
Picture Control (COOLPIX Picture Control)	Allows you to change the settings for image recording according to the shooting scene or your preferences. • Default setting: Standard	26
Custom Picture Control (COOLPIX Custom Picture Control)	Allows you to customize the settings of COOLPIX Picture Control and register them in Custom 1 or Custom 2 of Picture Control .	30
White balance	Allows you to adjust white balance to suit the weather conditions or light source in order to make the colors in images match what you see with your eyes. • Default setting: Auto (normal)	31

Option	Description	
Metering	Allows you to set the method that the camera uses to measure the brightness of the subject. • Default setting: Matrix	 34
Continuous	Allows you to select single or continuous shooting. • Default setting: Single	 35
ISO sensitivity	Allows you to control the camera's sensitivity to light. • Default setting: Auto When Auto is selected, ISO is displayed in the monitor while shooting if ISO sensitivity increases. • In M (manual) mode, when set to Auto or Fixed range auto , the ISO sensitivity is fixed at ISO 80.	 39
Exposure bracketing	The exposure (brightness) can be changed automatically during continuous shooting. • Default setting: Off	 40
AF area mode	Allows you to change the method of how the camera selects the focus area for autofocus. • Default setting: Target finding AF	 41
Autofocus mode	Allows you to select either Single AF , which focuses only when the shutter-release button is pressed halfway, or Full-time AF , which continues focusing even when the shutter-release button is not pressed halfway. • Default setting: Single AF	 44
Flash exp. comp.	Allows you to adjust the flash output. • Default setting: 0.0	 44
Noise reduction filter	Allows you to set the strength of the noise reduction function that is normally performed when saving images. • Default setting: Normal	 45
Built-in ND filter	Allows you to select On , Auto or Off for the built-in ND filter. • Default setting: Off	 46
Active D-Lighting	Allows you to prevent loss of contrast details in highlights and shadows and well reproduce the natural contrast that is seen with the naked eye when shooting images. • Default setting: Off	 47

Option	Description	
Multiple exposure	<p>Allows you to combine two to three images and save them as a single image.</p> <ul style="list-style-type: none"> • Default setting: <ul style="list-style-type: none"> - Multiple exposure mode: Off - Auto gain: On 	 48
Save user settings	Allows you to save the current settings in mode dial U ( 51).	52
Reset user settings	Allows you to reset the settings saved to mode dial U .	52
Zoom memory	<p>When the zoom control is moved, the zoom position (equivalent to focal length/angle of view in 35mm [135] format) is switched to the positions that have been selected by setting the check box to on in this menu option.</p> <ul style="list-style-type: none"> • Default setting: Off 	 50
Startup zoom position	<p>Allows you to set the zoom position (equivalent to focal length/angle of view in 35mm [135] format) for when the camera is turned on.</p> <ul style="list-style-type: none"> • Default setting: 24 mm 	 51
M exposure preview	<p>Allows you to set whether or not to reflect the brightness to the shooting screen when the exposure is changed in M (manual) mode.</p> <ul style="list-style-type: none"> • Default setting: Off 	 51

Functions That Can Be Set with the Control Ring

The following functions can be also set or adjusted by rotating the control ring. The functions that can be changed vary depending on the shooting mode.

- The control ring cannot be used while recording movies.

Function		P	S	A	M	SCENE (Food)	EFFECTS
Standard (default setting)	Zoom memory ¹	Flexible program	Shutter speed	Aperture	Aperture	2	3
Exposure +/- (📖63)	✓	✓	✓	✓	-	-	-
ISO sensitivity (📖67)	-	✓	✓	✓	✓	-	-
Fine-tune white balance (A (amber) to B (blue) direction) (🔍31)	-	✓	✓	✓	✓	-	-
Fine-tune white balance (G (green) to M (magenta) direction) (🔍31)	-	✓	✓	✓	✓	-	-
Manual focus (📖61)	-	✓	✓	✓	✓	-	-
Zoom memory (🔍50)	✓ ¹	✓	✓	✓	✓	-	-
Shutter speed (📖46)	-	-	✓	-	✓	-	-
Aperture (📖46)	-	-	-	✓	✓	-	-



1 The zoom position is switched to all the positions that can be selected for **Zoom memory** in the shooting menu.

2 The hue setting in **Food** scene mode (📖40)

3 Adjusting effects (📖44)



Using the Control Ring in (Auto), P, S, A, M, U Modes

1 Rotate the control ring when the shooting screen is displayed.

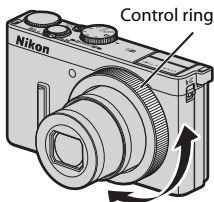
- The **Standard** setting for each shooting mode (69) or the last used function is adjusted.
- The function to be assigned to the control ring can be set with **Control ring options** in the setup menu (92).



2 Use the multi selector to select the option to be set.

- 1 **STD** Standard
- 2  Exposure +/-
- 3 **ISO** ISO sensitivity
- 4  **A-B** Fine-tune white balance (A-B)
- 5  **G-M** Fine-tune white balance (G-M)
- 6 **MF** Manual focus
- 7 **ZOOM** Zoom memory
- 8 **Tv** Shutter speed
- 9 **Av** Aperture

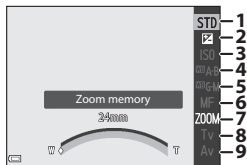

3 Use the control ring to adjust the setting.

- Press the shutter-release button to take the image.
- The control ring operation screen ends by pressing the  button, or when no operations are performed for a few seconds.

When Operating Manual Focus by Using the Control Ring

- The focus mode is set to **MF** (manual focus) when the focus is adjusted manually by using the control ring. Set the focus mode again to change back to autofocus (59).
- The peaking level cannot be adjusted.

When Operating Zoom Memory by Using the Control Ring

When zoom memory is operated by using the control ring in **P, S, A, M** or **U** shooting mode, **Zoom memory** in the shooting menu (66) is set to **On**. To move the zoom position to any position, including the positions that can be set with **On**, reset **Zoom memory** to **Off**.

Functions That Can Be Set with the Fn (Function) Button

The following functions can be also set by pressing the **Fn** (function) button instead of displaying the corresponding menu by pressing the **MENU** button.

- This function can be used when the shooting mode is **P**, **S**, **A**, **M** or **U**.

Image quality (📖66)	Continuous (📖67)
Image size (📖66)	ISO sensitivity (📖67)
Picture Control (📖66)	AF area mode (📖67)
White balance (📖66)	Vibration reduction (📖92)
Metering (📖67)	Built-in ND filter (📖67)

1 Press the **Fn** (function) button when the shooting screen is displayed.

- The **Fn** button function menu or the setting items of the function (default setting is **Continuous**) that was last assigned to the **Fn** (function) button can be selected.

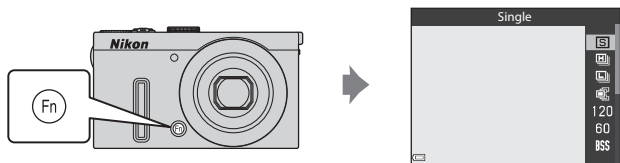

2 Use the multi selector to select a menu item.

- To assign another function, select the **Fn** button function menu and press the **OK** button. Then, select the desired function from the displayed menu.















3 After you finish assigning the function, press the **OK** button or **Fn** (function) button.

- The camera returns to the shooting screen.













Functions That Cannot Be Used Simultaneously

Some functions cannot be used with other menu settings.

Restricted function	Setting	Description
Flash mode	Focus mode (📖59)	When ▲ (infinity) is selected, the flash is not available.
	Image quality (📖66)	When RAW (NRW) images are saved, red-eye reduction processing is not performed even if ⚡👁️ (auto with red-eye reduction) is set (including JPEG images when both RAW (NRW) and JPEG images were saved at the same time).
	Continuous (📖67)	The flash is not available (except for interval timer shooting).
	Exposure bracketing (📖67)	The flash is not available.
Self-timer/ Smile timer	AF area mode (📖67)	When Subject tracking is selected, the self-timer/smile timer is not available.
Focus mode	Smile timer (📖58)	When smile timer is selected, the focus mode is fixed at AF (autofocus).
	AF area mode (📖67)	When Subject tracking is selected, MF (manual focus) is not available.
Image quality	Continuous (📖67)	<ul style="list-style-type: none"> When Pre-shooting cache is selected, Image quality is fixed at Normal. When Continuous H: 120 fps, Continuous H: 60 fps, BSS or Multi-shot 16 is selected, RAW (NRW), RAW (NRW) + Fine and RAW (NRW) + Normal are not available.
	Multiple exposure (📖68)	RAW (NRW) , RAW (NRW) + Fine and RAW (NRW) + Normal are not available when Multiple exposure is set to On .

Restricted function	Setting	Description
Image size	Image quality ( 66)	<ul style="list-style-type: none"> When Image quality is set to RAW (NRW), Image size is fixed at  4000×3000. When RAW (NRW) + Fine or RAW (NRW) + Normal is selected, Image size of the JPEG image can be set. Note, however, that  3968×2232,  1920×1080,  3984×2656 and  3000×3000 cannot be selected.
	Continuous ( 67)	<ul style="list-style-type: none"> When Pre-shooting cache is selected, Image size is fixed at  (2048 × 1536 pixels). When Continuous H: 120 fps or Continuous H: 60 fps is selected, Image size is fixed at  (1280 × 960 pixels). When Multi-shot 16 is selected, Image size is fixed at  (2560 × 1920 pixels).
Picture Control	Active D-Lighting ( 67)	When using Active D-Lighting , Contrast in manual adjustment cannot be adjusted.
White balance	Picture Control ( 66)	When Monochrome is selected, White balance is fixed at Auto (normal) .
Metering	Active D-Lighting ( 67)	When Active D-Lighting is set to any mode other than Off , Metering is reset to Matrix .

Restricted function	Setting	Description
Continuous/ Exposure bracketing	Continuous (📖67)/ Exposure bracketing (📖67)	Continuous and Exposure bracketing are not available simultaneously.
	Self-timer (📖57)	When self-timer is used, a single image is shot even if Continuous H , Continuous L , Pre-shooting cache , or BSS has been set.
	Smile timer (📖58)	When the camera detects smiling faces and the shutter is released, only one image is shot. If Intvl timer shooting is set, shooting finishes automatically after one image is shot.
	Image quality (📖66)	Pre-shooting cache , Continuous H: 120 fps , Continuous H: 60 fps , BSS and Multi-shot 16 are not available when Image quality is set to RAW (NRW) , RAW (NRW) + Fine or RAW (NRW) + Normal .
	Picture Control (📖66)	When Monochrome is selected, Exposure bracketing is not available.
	Multiple exposure (📖68)	Not available simultaneously.
ISO sensitivity	Continuous (📖67)	When Pre-shooting cache , Multi-shot 16 , Continuous H: 120 fps or Continuous H: 60 fps is selected, ISO sensitivity is fixed at Auto .

Restricted function	Setting	Description
AF area mode	Smile timer ( 58)	The camera captures images using face detection regardless of the applied AF area mode option.
	Focus mode ( 59)	<ul style="list-style-type: none"> When a setting other than Subject tracking is selected and  (infinity) is selected as the focus mode for shooting, the camera focuses at infinity regardless of the applied AF area mode option. When set to MF (manual focus), the AF area mode cannot be set.
	Picture Control ( 66)	When Target finding AF is selected and Picture Control is set to Monochrome , the camera focuses on a face or selects one or more of the 9 focus areas containing the subject closest to the camera.
	White balance ( 66)	When Target finding AF is selected, and if the white balance is set to Preset manual , Incandescent , Fluorescent FL3 or Choose color temp. , or fine adjustment of white balance is performed, the camera focuses on a face or selects one or more of the 9 focus areas containing the subject closest to the camera.
Autofocus mode	Smile timer ( 58)	Autofocus mode option cannot be changed when the smile timer is selected.
	Focus mode ( 59)	When the focus mode is set to  (infinity), the autofocus mode operates using the Single AF setting.
	AF area mode ( 67)	When AF area mode is set to Face priority , Subject tracking or Target finding AF , Single AF is automatically selected.
Multiple exposure	Image quality ( 66)	Multiple exposure is not available when Image quality is set to RAW (NRW) , RAW (NRW) + Fine or RAW (NRW) + Normal .
	Continuous ( 67)	Not available simultaneously.
	Exposure bracketing ( 67)	Not available simultaneously.

Restricted function	Setting	Description
Print date	Image quality (66)	When Image quality is set to RAW (NRW) , RAW (NRW) + Fine or RAW (NRW) + Normal , date cannot be imprinted on images.
	Continuous (67)	When Pre-shooting cache, Continuous H: 120 fps or Continuous H: 60 fps is selected, date cannot be imprinted on images.
Digital zoom	Smile timer (58)	When the smile timer is selected, digital zoom is not available.
	Image quality (66)	When Image quality is set to RAW (NRW) , RAW (NRW) + Fine or RAW (NRW) + Normal , digital zoom is not available.
	Continuous (67)	When Multi-shot 16 is selected, digital zoom is not available.
	AF area mode (67)	When Subject tracking is selected, digital zoom is not available.
	Zoom memory (68)	When Zoom memory is set to On , digital zoom is not available.
Sound settings	Continuous (67)	When Continuous H, Continuous L, Pre-shooting cache, Continuous H: 120 fps, Continuous H: 60 fps, BSS, or Multi-shot 16 is selected, shutter sound is disabled.
	Exposure bracketing (67)	Shutter sound is disabled.
Blink warning	Smile timer (58)	When the smile timer is selected, blink warning is not available.
	Continuous (67)	When an option other than Single is selected, blink warning is not available.
	Exposure bracketing (67)	When an option other than Off is selected, blink warning is not available.
	Multiple exposure (68)	When Multiple exposure mode is set to On , blink warning is not available.

Notes About Digital Zoom

- Depending on the shooting mode or the current settings, digital zoom may not be available (73).
- When digital zoom is in effect, selectable options for AF area mode or metering mode are restricted.

Focusing

The focus area varies depending on the shooting mode.

Using the Target Finding AF

In  (auto) mode, or when **AF area mode** ( 67) in **P, S, A, M** or **U** mode is set to **Target finding AF**, the camera focuses in the manner described below when you press the shutter-release button halfway.

- The camera detects the main subject and focuses on it. When the subject is in focus, the focus area glows green.
If a human face is detected, the camera automatically sets focus priority on it.

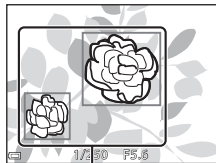

Focus areas

- If no main subject is detected, the camera automatically selects one or more of the 9 focus areas containing the subject closest to the camera. When the subject is in focus, the focus areas that are in focus glow green.

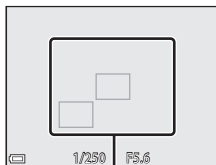

Focus areas

Notes About Target Finding AF

- Depending on shooting conditions, the subject that the camera determines to be the main subject may vary.
- The main subject may not be detected when using certain **White balance** or **Picture Control** settings.
- The camera may not detect the main subject appropriately in the following situations:
 - When the subject is very dark or bright
 - When the main subject lacks clearly defined colors
 - When the shot is framed so that the main subject is on the edge of the monitor
 - When the main subject is composed of a repeating pattern

Using Face Detection

In the following settings, the camera uses face detection to automatically focus on human faces.

- **Scene auto selector, Portrait, or Night portrait** scene mode (📖36)
- 📷 (smile timer) (📖58)
- When **AF area mode** (📖67) is set to **Face priority**

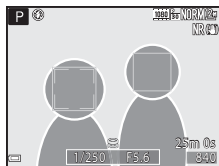

If the camera detects more than one face, a double border is displayed around the face that the camera focuses on, and single borders are displayed around the other faces.

If the shutter-release button is pressed halfway when no faces are detected:

- When **Scene auto selector** is selected, the focus area changes depending on the scene.
- In **Portrait** and **Night portrait** scene modes, the camera focuses on the area in the center of the frame.
- When 📷 (smile timer) is selected, the camera focuses on the subject in the center of the frame.
- When **AF area mode** is set to **Face priority**, the camera selects the focus area containing the subject closest to the camera.

✓ Notes About Face Detection

- The camera's ability to detect faces depends on a variety of factors, including the direction in which the faces are looking.
- The camera may be unable to detect faces in the following situations:
 - When faces are partially hidden by sunglasses or otherwise obstructed
 - When faces take up too much or too little of the frame

📷 Viewing Images Taken Using Face Detection

During playback, the camera automatically rotates images according to the orientation of the faces that were detected at the time of shooting (except for images taken using **Continuous** (📖67) or **Exposure bracketing** (📖67)).

Using Skin Softening

When the shutter is released while using one of the shooting modes listed below, the camera detects human faces and processes the image to soften facial skin tones (up to 3 faces).

- **Scene auto selector, Portrait, or Night portrait** scene mode (📖36)
- Skin softening can also be applied to saved images (📖83).

✔ Notes About Skin Softening

- It may take more time than usual to save images after shooting.
- Under some shooting conditions, the desired skin softening results may not be achieved, and skin softening may be applied to areas of the image where there are no faces.

Subjects Not Suitable for Autofocus

The camera may not focus as expected in the following situations. In some rare cases, the subject may not be in focus despite the fact that the focus area or focus indicator glows green:

- Subject is very dark
- Objects of sharply differing brightness are included in the scene (e.g. the sun behind the subject makes that subject appear very dark)
- No contrast between the subject and surroundings (e.g. a portrait subject wearing a white shirt is standing in front of a white wall)
- Several objects are at different distances from the camera (e.g. the subject is inside a cage)
- Subjects with repeating patterns (window blinds, buildings with multiple rows of similarly shaped windows, etc.)
- Subject is moving rapidly

In the situations noted above, try pressing the shutter-release button halfway to refocus several times, or focus on another subject positioned at the same distance from the camera as the actual desired subject, and use focus lock (📖80).

The camera can also focus using manual focus (📖59, 61).

Focus Lock

Use focus lock to capture creative compositions even when the focus area is set to the center of the frame.

- 1 Position the subject in the center of the frame and press the shutter-release button halfway.

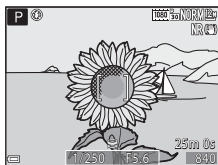

- Confirm that the focus area glows green.
- Focus and exposure are locked.

- 2 Without lifting your finger, recompose the picture.

- Make sure to maintain the same distance between the camera and the subject.

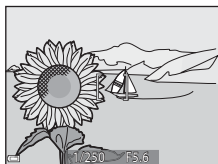

- 3 Press the shutter-release button the rest of the way down to take the picture.



Moving the Focus Area to the Desired Position

In **P**, **S**, **A** or **M** shooting mode, the focus area can be moved using the multi-selector by setting **AF area mode** in the shooting menu (66) to one of the manual options.

Playback Features

Playback Zoom

Moving the zoom control toward **T** (Q) in full-frame playback mode (📄32) zooms in on the image.

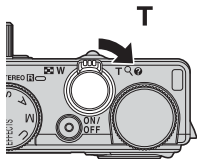

Image is displayed full-frame.



Image is zoomed in.

Displayed area guide

- You can change the zoom ratio by moving the zoom control toward **W** (📐) or **T** (Q). The zoom can also be adjusted by rotating the command dial.
- To view a different area of the image, press the multi selector ▲▼◀▶.
- If you are viewing an image that was captured using face detection or pet detection, the camera zooms in on the face detected at the time of shooting (except images captured using **Continuous** or **Exposure bracketing**). To zoom in on an area of the image where there are no faces, adjust the zoom ratio and then press ▲▼◀▶.
- When a zoomed image is displayed, press the **OK** button to return to full-frame playback mode.

Cropping Images

When a zoomed image is displayed, you can press the **MENU** button to crop the image to include only the visible portion and save it as a separate file (📄14).

Thumbnail Display, Calendar Display

Moving the zoom control toward **W** (📐) in full-frame playback mode (📖32) displays images as thumbnails.

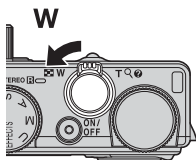

- You can change the number of thumbnails displayed by moving the zoom control toward **W** (📐) or **T** (📄).
- While using thumbnail playback mode, use the multi selector ▲▼◀▶ or rotate it to select an image, and then press the **OK** button to display that image full-frame.
- While using calendar display mode, use the multi selector ▲▼◀▶ or rotate it to select a date, and then press the **OK** button to display the images captured on that day.

✓ Calendar Display







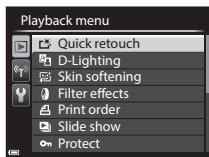



Images captured when the camera's date is not set are treated as images captured on January 1, 2014.

Functions That Can Be Set with the MENU Button (Playback Menu)

When viewing images in full-frame playback mode or thumbnail playback mode, you can configure the playback menu settings listed below by pressing the **MENU** button (📖8).



Option	Description	📖
🔍 Quick retouch ¹	Allows you to create retouched copies in which contrast and saturation have been enhanced.	🔑8
🔦 D-Lighting ¹	Allows you to create copies with enhanced brightness and contrast, brightening dark portions of an image.	🔑8
👤 Skin softening ¹	Detects faces in images and creates a copy with softer facial skin tones.	🔑9
🎛️ Filter effects ¹	Allows you to apply a variety of effects using digital filters. The available effects are Soft portrait, Selective color, Cross screen, Fisheye, Miniature effect, Painting, Vignette, Photo illustration and Portrait (color + B&W) .	🔑10
🖨️ Print order ²	Allows you to select which images are printed, and how many copies of each image are printed, prior to printing.	🔑52
📺 Slide show	Allows you to view images in an automatic slide show.	🔑54
🔒 Protect ²	Protects selected images and movies from accidental deletion.	🔑55
🔄 Rotate image ²	Allows you to rotate the displayed image to portrait or landscape orientation.	🔑55
🖼️ Small picture ¹	Creates a small copy of images.	🔑11
🗣️ Voice memo	Allows you to use the camera's microphone to record voice memos and attach them to images.	🔑56

Option	Description	
 Copy ²	Allows you to copy images between the internal memory and a memory card. This function can also be used to copy movies.	 57
NRW RAW (NRW) processing ^{1, 2}	Creates JPEG-format copies by performing RAW processing within the camera for RAW (NRW) images without having to use a computer.	 12
 Sequence display options	Allows you to select whether to display only the key picture for a sequence of images captured continuously or to display the sequence as individual images. <ul style="list-style-type: none"> When only the key picture is displayed for a sequence, press the  button to display each image in the sequence. Press the multi selector  to return to the key picture display. 	 58
 Choose key picture ²	Allows you to change the key picture for images captured in sequence.	 58

¹ Edited images are saved as separate files. Some images may not be edited.

² Select an image on the image selection screen. See “Using the Screen for Selecting Images” (85) for more information.

Using the Screen for Selecting Images

When an image selection screen such as the one shown on the right is displayed while operating the camera, follow the procedures described below to select the images.



1 Use the multi selector ◀▶ or rotate it to select the desired image.

- Move the zoom control (1) toward **T** (Q) to switch to full-frame playback, or **W** (R) to switch to thumbnail playback.
- Only one image can be selected for **Rotate image**, **Choose key picture**, and **Welcome screen**. Proceed to step 3.

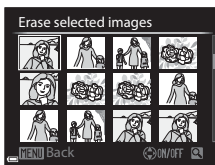

2 Use ▲▼ to select **ON** or **OFF** (or the number of copies).

- When **ON** is selected, a check mark (✓) is displayed with the image. Repeat steps 1 and 2 to select additional images.



3 Press the **OK** button to apply the image selection.

- When a confirmation dialog is displayed, follow the on-screen instructions.

Recording and Playing Back Movies

Recording Movies



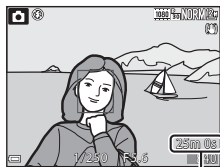

1 Display the shooting screen.

- Check the remaining amount of movie recording time.
- If **Photo info** in the **Monitor settings** (p.92) in the setup menu is set to **Movie frame+auto info**, the area that will be visible in the movie can be confirmed before movie recording starts.



Movie recording time remaining

2 Press the movie-record) button to start movie recording.

- The camera focuses on the subject in the center of the frame.
- Press the multi selector  to pause recording, and press  again to resume recording (except when  **iFrame 720/30p** or  **iFrame 720/25p**, or an HS movie option is selected in **Movie options**). Recording automatically ends if it remains paused for about five minutes.



3 Press the movie-record) button again to end recording.

✓ Maximum Movie Length

Individual movie files cannot exceed 4 GB in size or 29 minutes in length, even when there is sufficient free space on the memory card for longer recording.

- The maximum movie length for a single movie is displayed on the shooting screen.
- Recording may end before either limit is reached if camera temperature becomes elevated.
- The actual movie length may vary depending on the movie content, subject movement, or type of memory card.

✓ Notes About Saving Images and Recording Movies

The indicator showing the number of exposures remaining or the indicator showing the maximum movie length flashes while images are being saved or while a movie is being recorded. **Do not open the battery-chamber/memory card slot cover or remove the battery or memory card** while an indicator is flashing. Doing this could result in loss of data, or in damage to the camera or the memory card.

✓ Notes About Movie Recording

- Memory cards with an SD Speed Class rating of 6 or faster are recommended when recording movies (📖21). Movie recording may stop unexpectedly when a memory card with a lower Speed Class rating is used.
- When using the camera's internal memory, saving movies may take some time.
- Depending on the file size of a movie, it may not be possible to save the movie in the internal memory or copy it from a memory card to the internal memory.
- The sounds of zoom control operation, zoom, autofocus lens drive movement, vibration reduction, and aperture operation when brightness changes may be recorded.
- The following phenomena may be seen in the monitor while recording movies. These phenomena are saved in the recorded movies.
 - Banding may occur in images under fluorescent, mercury-vapor, or sodium-vapor lighting.
 - Subjects that move quickly from one side of the frame to the other, such as a moving train or car, may appear skewed.
 - The entire movie image may be skewed when the camera is panned.
 - Lighting or other bright areas may leave residual images when the camera is moved.
- Depending on the distance to the subject or the amount of zoom applied, subjects with repeating patterns (fabrics, lattice windows, etc.) may have colored stripes (interference patterns, moire, etc.) in them during movie recording and playback. This occurs when the pattern in the subject and the layout of the image sensor interfere with each other; it is not a malfunction.

✓ Notes About Using Zoom During Movie Recording

- The zoom indicator is not displayed during movie recording.
- There may be some degradation in image quality when digital zoom is used. If you zoom in on the subject while recording a movie, the zoom motion temporarily stops at the position where optical zoom is changed to digital zoom.

✓ Camera Temperature





- The camera may become warm when recording movies for an extended period of time or when the camera is used in a hot area.
- If the inside of the camera becomes extremely hot when recording movies, the camera will automatically stop recording. The amount of time remaining until the camera stops recording (🕒10s) is displayed. After the camera stops recording, it turns itself off.
Leave the camera off until the inside of the camera has cooled.

Focusing and Exposure Locking During Movie Recording

- The focus can be adjusted during movie recording in the following manner in accordance with the **Autofocus mode** (📖90) setting of the movie menu.
 - **AF-S Single AF** (default setting): The focus is locked when movie recording starts. To perform the autofocus function during movie recording, press the multi selector ◀.
 - **AF-F Full-time AF**: The focus is adjusted repeatedly even during movie recording.
- When the multi selector ▶ is pressed during movie recording, the exposure is locked. To unlock, press ▶ again.
- When the focus mode (📖59) is **MF** (manual focus), adjust the focus manually. The focus can be adjusted while recording movies by rotating the multi selector counterclockwise to focus on far subjects or clockwise to focus on near subjects.
- Autofocus may not perform as expected (📖79). Should this occur, try **MF** (manual focus) (📖59, 61) or set **Autofocus mode** in the movie menu to **AF-S Single AF** (default setting) and then use focus lock (📖80) to record.



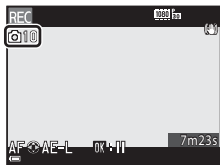

Saving Still Images While Recording Movies

If the shutter-release button is pressed all the way while recording a movie, one frame is saved as a still image (JPEG image). Movie recording continues while the still image is being saved.

- The maximum number of still images that can be saved during a movie recording (10 images) and  are displayed at the top left of the monitor. When  is displayed, a still image cannot be saved.
- The image quality of the still pictures to be saved is the same as that set for **Image quality** (23). When **Image quality** is set to **RAW (NRW)**, still pictures are saved with **Fine** as the image quality.
- The image size of the still images to be saved is set to  (3968 × 2232 pixels).



Notes About Saving Still Images During Movie Recording





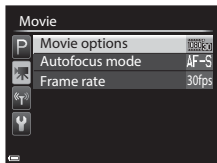

- Still images cannot be saved during movie recording in the following situations.
 - When movie recording is paused
 - When a movie is recorded to the internal memory
 - When the remaining movie length is less than 10 seconds
 - When **Movie options** (90) is set to  **1080/60i**,  **1080/50i**,  **480/30p**,  **480/25p** or HS movie
- Frames of a movie that were recorded when a still image was being taken may not be played back in a seamless manner.
- The sounds of operating the shutter-release button when saving a still image may be heard in the recorded movie.
- If the camera moves when the shutter-release button is pressed, the image may be blurred.

Functions That Can Be Set with the MENU Button (Movie Menu)



Enter shooting mode → Press the **MENU** button →  (movie) tab 

The settings of the menu options listed below can be configured.



Option	Description	
Movie options	Select the movie type. Select normal speed to record movies at normal speed, or HS (high speed) to record movies that play in slow or fast motion. • Default setting:  1080/30p or  1080/25p	 59
Autofocus mode	Select either Single AF , which locks focus when movie recording begins, or Full-time AF , which continues focusing during movie recording. • Default setting: Single AF	 62
Frame rate	Select the frame rate used when recording movies.	 62

Playing Back Movies

Press the  button to enter playback mode.
Movies are indicated by the movie options icon (59).

Press the  button to play back movies.

- To adjust the volume, move the zoom control (1).

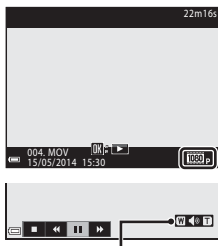

Volume indicator

Functions Available During Playback

Rotate the multi selector or the command dial to advance or rewind.

Playback controls are displayed at the bottom of the monitor.

The operations listed below can be performed by using the multi selector ◀▶ to select a control and then pressing the **OK** button.

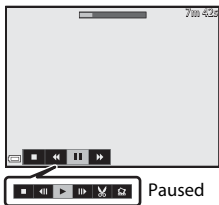

Function	Icon	Description
Rewind	◀◀	Hold down the OK button to rewind the movie.
Advance	▶▶	Hold down the OK button to advance the movie.
Pause		Pause playback. The operations listed below can be performed while paused.
		◀ Rewind the movie one frame. Hold down the OK button for continuous rewinding.*
		▶ Advance the movie one frame. Hold down the OK button for continuous advancing.*
		▶ Resume playback.
		✂ Extract the desired portion of a movie and save it as a separate file.
	🖼 Extract a single frame of a movie and save it as a still image.	
End	■	Return to full-frame playback mode.

* The movie can also be advanced or rewound by one frame by rotating the multi selector or command dial.

Deleting Movies

To delete a movie, select the desired movie in full-frame playback mode (📖32) or thumbnail playback mode (📖82) and press the **🗑** button (📖33).









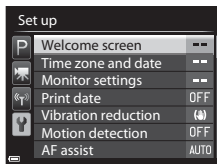

General Camera Setup













Functions That Can Be Set with the MENU Button (Setup Menu)

Press the MENU button → Y (setup) tab (📖9)

The settings of the menu options listed below can be configured.



Option	Description	
Welcome screen	Allows you to select whether or not the welcome screen is displayed when the camera is turned on.	 65
Time zone and date	Allows you to set the camera clock.	 66
Monitor settings	Allows you to adjust post-shooting image review, monitor brightness, and photo information display settings.	 68
Print date	Allows you to imprint the shooting date and time on images.	 70
Vibration reduction	Allows you to select the vibration reduction setting used when shooting.	 71
Motion detection	Allows you to set whether or not the camera automatically increases the shutter speed to reduce blurring caused by camera shake if motion is detected when shooting still images.	 72
AF assist	Allows you to enable or disable the AF-assist illuminator.	 72
Digital zoom	Allows you to set the operation of digital zoom.	 73
Control ring options	Allows you to assign a function to the control ring.	 73
Sound settings	Allows you to adjust sound settings.	 74

Option	Description	
Auto off	Allows you to set the amount of time that passes before the monitor turns off to save power.	 74
Format memory/ Format card	Allows you to format the internal memory or the memory card.	 75
Language	Allows you to change the camera's display language.	 75
TV settings	Allows you to adjust TV-connection settings.	 76
Charge by computer	Allows you to set whether or not the battery in the camera is charged when the camera is connected to a computer.	 77
Toggle Av/Tv selection	Allows you to switch the method for setting the flexible program, shutter speed or aperture value.	 78
Reset file numbering	Allows you to reset the sequential numbering of file numbers when Yes is selected.	 78
Blink warning	Allows you to set whether or not closed eyes are detected when taking images of people using face detection.	 79
Eye-Fi upload	Allows you to set whether or not to enable the function for sending images to a computer using a commercially available Eye-Fi card.	 80
Peaking	Allows you to set whether or not to highlight areas that are in focus in white on the image displayed in the monitor when operating manual focus.	 81
Reset all	Allows you to reset the camera's settings to their default values.	 81
Firmware version	View the current camera firmware version.	 81

Using the Wi-Fi (Wireless LAN) Function

Functions That Can Be Performed Using Wi-Fi

You can perform the following functions if you install the dedicated software “Wireless Mobile Utility” on your smart device that runs on Android OS or iOS, and connect it to the camera.

Take Photos

You can use a smart device to remotely release the camera shutter and save images to the smart device.

- Operations cannot be performed on the camera during remote control operation.
- The shooting mode is set to  (auto) mode and the focus area is set to the center of the frame, regardless of the camera's settings.

View Photos

You can copy the images saved in the camera's memory card and display them on your smart device.

Installing the Software on the Smart Device



1 Use your smart device to connect to Google Play Store, App Store or other online apps marketplace and search for “Wireless Mobile Utility.”

- Check the user's manual provided with your smart device for further details.

2 Check the description and other information and install the software.

- For more information about how to operate the software, download the user's manual from the website below.
 - Android OS: <http://nikonimglib.com/ManDL/WMAU/>
 - iOS: <http://nikonimglib.com/ManDL/WMAU-ios/>

Connecting the Smart Device to the Camera

Press the MENU button →  (Wi-Fi options) tab →  button

1 Use the multi selector ▲▼ to select **Connect to smart device** and press the button.

- See “Notes About Wi-Fi Connection” (📖96) when **Connect to smart device** cannot be selected.
- When the Wi-Fi function is turned on, the SSID and password are displayed.
- If no connection confirmation is received from the smart device within 3 minutes, the message “No access.” is displayed and the camera returns to the Wi-Fi options screen.

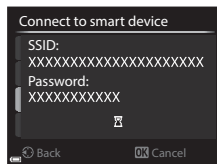
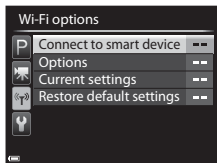

2 Set the Wi-Fi setting on the smart device to On.

- Check the user’s manual provided with your smart device for further details.
- After the network name (SSID) that can be used for the smart device is displayed, select the SSID displayed on the camera.
- When the message for entering a password is displayed, enter the password that is displayed on the camera.
- When the camera is successfully connected to a Wi-Fi network, the camera monitor turns off and the power-on lamp turns on.

3 Start the “Wireless Mobile Utility” installed on the smart device.

- The screen for selecting “Take photos” or “View photos” is displayed.
- When the message “Cannot connect to camera.” is displayed, return to step 1 and retry the procedure.

To Terminate the Wi-Fi Connection

- Turn off the camera.
- Set the Wi-Fi setting on the smart device to Off.

Notes About Wi-Fi Connection

- **Connect to smart device** cannot be selected in the following situations:
 - When no memory card is inserted in the camera.
 - When an Eye-Fi card (E80) is inserted in the camera.
 - When the camera is connected to a TV, computer, or printer.
 - When the battery level indicator in the monitor indicates . In addition, if the battery level indicator becomes low when Wi-Fi is connected, the connection is terminated.
- Terminate the Wi-Fi connection in a place where the use of radio waves is prohibited.
- When Wi-Fi is connected, **Auto off** is disabled.
- When Wi-Fi is connected, the battery drains faster than normal.
- It may take some time until the SSID is displayed on the smart device after **Connect to smart device** is performed.

Notes About Security Settings

If the camera is installed with the Wi-Fi function without proper security settings (encryption and password), unauthorized third parties may access the network and cause harm. We strongly recommend performing the required security settings before using the Wi-Fi function.

Use **Options** in the Wi-Fi options menu (E63) to perform the security settings.

Connecting the Camera to a TV, Computer, or Printer

Connection Methods

You can enhance your enjoyment of images and movies by connecting the camera to a TV, computer, or printer.

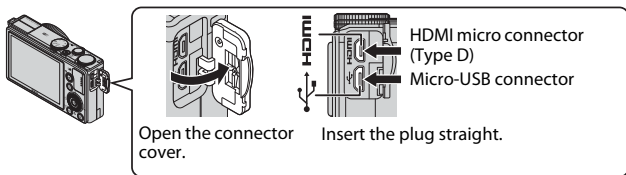

- Before connecting the camera to an external device, make sure the remaining battery level is sufficient and turn the camera off. Before disconnecting, make sure to turn the camera off.
- If the AC Adapter EH-62F (available separately) is used, this camera can be powered from an electrical outlet. Do not use any other make or model of AC adapter as it may cause the camera to heat up or malfunction.
- For information about the connection methods and subsequent operations, refer to the documentation included with the device in addition to this document.
- A USB cable and an HDMI cable cannot be connected to the camera simultaneously.

Viewing images on a TV 15

Images and movies captured with the camera can be viewed on a TV.

Connection method: Connect a commercially available HDMI cable to the TV's HDMI input jack.

Viewing and organizing images on a computer 99

You can transfer images to a computer to perform simple retouching and manage image data.

Connection method: Connect the camera to the computer's USB port with the included USB cable.

- Before connecting to a computer, install ViewNX 2 on the computer ( 99).
- If any USB devices that draw power from the computer are connected, disconnect them from the computer before you connect the camera to it. Connecting the camera and other USB-powered devices to the same computer simultaneously may cause a camera malfunction or excessive power supply from the computer, which could damage the camera or memory card.

Printing images without using a computer 16

If you connect the camera to a PictBridge-compatible printer, you can print images without using a computer.

Connection method: Connect the camera directly to the printer's USB port with the included USB cable.

Using ViewNX 2

ViewNX 2 is an all-in-one software package which enables you to transfer, view, edit and share images. Install ViewNX 2 using the included ViewNX 2 CD-ROM.

Your Imaging Toolbox

ViewNX 2™



Installing ViewNX 2

Compatible Operating Systems

Windows

Windows 8.1, Windows 7, Windows Vista, Windows XP

Mac

OS X 10.9, 10.8, 10.7

Refer to the Nikon website for details on system requirements, including the latest information on operating system compatibility.

1 Start the computer and insert the ViewNX 2 CD-ROM into the CD-ROM drive.

- Windows: If instructions for operating the CD-ROM are displayed in the window, follow the instructions to proceed to the installation window.
- Mac: When the **ViewNX 2** window is displayed, double-click the **Welcome** icon.

2 Select a language in the language selection dialog to open the installation window.

- If the desired language is not available, click **Region Selection** to choose a different region and then choose the desired language (the **Region Selection** button is not available in the European release).
- Click **Next** to display the installation window.



3 Start the installer.

- We recommend clicking **Installation Guide** in the installation window to check the installation help information and system requirements before installing ViewNX 2.
- Click **Typical Installation (Recommended)** in the installation window.
- Follow the on-screen instructions to install the software.

4 Exit the installer when the installation completion screen is displayed.

- Windows: Click **Yes**.
- Mac: Click **OK**.

The following software is installed:

- ViewNX 2 (consisting of the three modules below)
 - Nikon Transfer 2: For transferring images to the computer
 - ViewNX 2: For viewing, editing, and printing transferred images
 - Nikon Movie Editor: For basic editing of transferred movies
- Panorama Maker (for creating a single panorama image of a landscape, etc. from a series of images that each capture a separate portion of the subject)

5 Remove the ViewNX 2 CD-ROM from the CD-ROM drive.

Transferring Images to the Computer

1 Choose how images will be copied to the computer.

Choose one of the following methods:

- **Direct USB connection:** Turn the camera off and ensure that the memory card is inserted in the camera. Connect the camera to the computer using the USB cable. The camera automatically turns on.
To transfer images that are saved in the camera's internal memory, remove the memory card from the camera before connecting it to the computer.

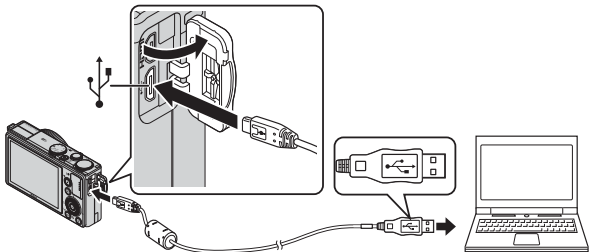

- **SD card slot:** If your computer is equipped with an SD card slot, the card can be inserted directly in the slot.
- **SD card reader:** Connect a card reader (available separately from third-party suppliers) to the computer and insert the memory card.

If a message is displayed prompting you to choose a program, select Nikon Transfer 2.

• When using Windows 7

If the dialog shown at right is displayed, follow the steps below to select Nikon Transfer 2.

- 1 Under **Import pictures and videos**, click **Change program**. A program selection dialog will be displayed; select **Import File using Nikon Transfer 2** and click **OK**.
- 2 Double-click **Import File**.



If the memory card contains a large number of images, it may take a while for Nikon Transfer 2 to start. Wait until Nikon Transfer 2 starts.

✓ Connecting the USB Cable

The connection may not be recognized if the camera is connected to the computer via a USB hub.

2 Transfer images to the computer.

- Click **Start Transfer**.

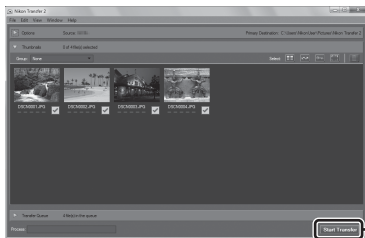

Start Transfer

- At default settings, all the images on the memory card will be copied to the computer.

3 Terminate the connection.

- If the camera is connected to the computer, turn the camera off and disconnect the USB cable.
- If you are using a card reader or card slot, choose the appropriate option in the computer operating system to eject the removable disk corresponding to the memory card and then remove the card from the card reader or card slot.

Viewing Images

Start ViewNX 2.

- Images are displayed in ViewNX 2 when transfer is complete.
- Consult online help for more information on using ViewNX 2.

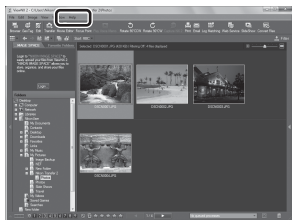

Starting ViewNX 2 Manually

- **Windows:** Double-click the **ViewNX 2** shortcut on the desktop.
- **Mac:** Click the **ViewNX 2** icon in the Dock.



Reference Section

The Reference Section provides detailed information and hints about using the camera.

Shooting

Using Easy Panorama (Shooting and Playback) 2

Playback

Viewing and Deleting Images Captured Continuously
(Sequence) 5
Editing Still Images 7
Connecting the Camera to a TV (Viewing Images on a TV) 15
Connecting the Camera to a Printer (Direct Print) 16
Editing Movies 21

Menu

The Shooting Menu (P, S, A or M Mode) 23
The Playback Menu 52
The Movie Menu 59
The Wi-Fi Options Menu 63
The Setup Menu 65



Additional Information



Error Messages 82
File Names 86
Optional Accessories 87

Using Easy Panorama (Shooting and Playback)

Shooting with Easy Panorama

Rotate the mode dial to SCENE → MENU button →  Easy panorama

- 1** Select  **Normal (180°)** or  **Wide (360°)** as the shooting range and press the  button.

- When the camera is readied in the horizontal position, the image size (width × height) is as follows.
 -  **Normal (180°)**:
4800 × 920 when moved horizontally,
1536 × 4800 when moved vertically
 -  **Wide (360°)**:
9600 × 920 when moved horizontally,
1536 × 9600 when moved vertically

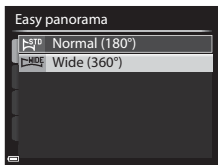



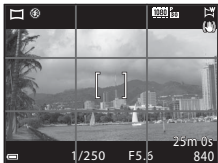

- 2** Frame the first edge of the panorama scene, and then press the shutter-release button halfway to focus.

- The zoom position is fixed at wide-angle.
- The camera focuses on the area in the center of the frame.



- 3** Press the shutter-release button all the way, and then remove your finger from the shutter-release button.

-     are displayed to indicate the direction of camera movement.



4 Move the camera in one of the four directions until the guide indicator reaches the end.

- When the camera detects which direction it is moving in, shooting begins.



Guide

Example of Camera Movement

- Using your body as the axis of rotation, move the camera slowly in an arc, in the direction of the marking (△▽◀▶).
- Shooting stops if the guide does not reach the edge within about 15 seconds (when **STD Normal (180°)** is selected) or within about 30 seconds (when **WIDE Wide (360°)** is selected) after shooting starts.



✓ Notes About Easy Panorama Shooting

- The range of the image seen in the saved image is narrower than that seen in the monitor at the time of shooting.
- If the camera is moved too quickly or shaken too much, or if the subject is too uniform (e.g. walls or darkness), an error may occur.
- If shooting is stopped before the camera reaches the half-way point in the panorama range, a panorama image is not saved.
- If more than half of the panorama range is captured but shooting ends before reaching the edge of the range, the range not captured is recorded and displayed in gray.

Viewing Images Captured with Easy Panorama

Switch to playback mode (📖32), display an image captured using easy panorama in full-frame playback mode, and then press the **OK** button to scroll the image in the direction that was used when shooting.

- Rotate the multi selector to scroll forward or backward quickly.

Playback controls are displayed at the bottom of the monitor during playback.

Use the multi selector **◀▶** to select a control, and then press the **OK** button to perform the following operations.



Function	Icon	Description
Rewind	⏮	Hold down the OK button to scroll backward quickly.*
Advance	⏭	Hold down the OK button to scroll forward quickly.*
Pause	⏸	Pause playback. The operations listed below can be performed while paused.
		⏮ OK Hold down the OK button to rewind.*
		⏭ OK Hold down the OK button to scroll.*
		▶ OK Resume automatic scrolling.
End	⏹	Switch to full-frame playback mode.

* These operations can also be performed by rotating the multi selector.

✓ Notes About Scroll Playback

This camera may not be able to scroll the playback of, or zoom in on, easy panorama images captured with another make or model of digital camera.

Viewing and Deleting Images Captured Continuously (Sequence)

Viewing Images in a Sequence

Images captured continuously are saved as a sequence.

The first image of a sequence is used as the key picture to represent the sequence when displayed in full-frame playback mode or thumbnail playback mode (default setting).

To display each image in the sequence individually, press the **OK** button.



After pressing the **OK** button, the operations listed below are available.

- To display the previous or next image, rotate the multi selector or press **◀▶**.
- To display images that are not included in the sequence, press **▲** to return to the key picture display.
- To display images in a sequence as thumbnails, or to play them back in a slide show, set **Sequence display options to Individual pictures** in the playback menu (**58**).



✓ Sequence Display Options

Images captured continuously with cameras other than this camera cannot be displayed as a sequence.

📎 Playback Menu Options Available When Using Sequence

- When images in a sequence are displayed in full-frame playback mode, press the **MENU** button to select functions in playback menu (**83**).
- If you press the **MENU** button when a key picture is displayed, the following settings can be applied to all images in the sequence:
 - Print order, Protect, Copy

Deleting Images in a Sequence

When the  button is pressed for images in a sequence, the images that are deleted vary depending on how the sequences are displayed.

- When the key picture is displayed:
 - **Current image:** All images in the displayed sequence are deleted.
 - **Erase selected images:** When a key picture is selected on the erase selected images screen (34), all images in that sequence are deleted.
 - **All images:** All images in the internal memory or on the memory card are deleted.
- When images in a sequence are displayed in full-frame playback mode:
 - **Current image:** The image currently displayed is deleted.
 - **Erase selected images:** Images that are selected in the sequence are deleted.
 - **Entire sequence:** All images in the displayed sequence are deleted.

Editing Still Images

Before Editing Images

You can easily edit images on this camera. Edited copies are saved as separate files.

Edited copies are saved with the same shooting date and time as the original.



Restrictions on Image Editing

An image can be edited up to ten times.

Quick Retouch: Enhancing Contrast and Saturation

Select an image (📖32) → MENU button (📖8) →  Quick retouch

Use the multi selector ▲▼ to select the desired effect level and press the **OK** button.

- The edited version is displayed on the right.
- To exit without saving the copy, press ◀.

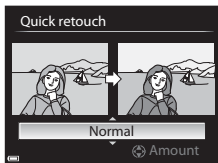

D-Lighting: Enhancing Brightness and Contrast

Select an image (📖32) → MENU button (📖8) →  D-Lighting

Use the multi selector ▲▼ to select the desired effect level and press the **OK** button.

- The edited version is displayed on the right.
- To exit without saving the copy, press ◀.

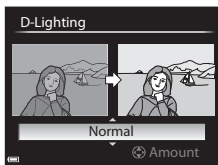



Skin Softening: Softening Skin Tones

Select an image (📖32) → MENU button (📖8) →  Skin softening

- 1 Use the multi selector ▲▼ to select the desired effect level and press the  button.

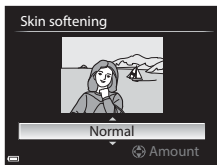
- To exit without saving the copy, press ◀.



- 2 Preview the result and press the  button.

- The edited face is zoomed in.
- When more than one face has been edited, press ◀▶ to switch the face that is displayed.
- To change the effect level, press the MENU button and return to step 1.
- An edited copy is created.



Notes About Skin Softening

- Up to 12 faces, in order of proximity to the center of the frame, can be enhanced.
- Depending upon the direction in which faces are looking, or the brightness of faces, the camera may be unable to accurately detect faces, or the skin softening function may not perform as expected.
- If no faces are detected, a warning is displayed and the screen returns to the playback menu.

Filter Effects: Applying Digital Filter Effects

Select an image (📖32) → MENU button (📖8) → 🎛️ Filter effects

Option	Description
Soft portrait	Blurs the background of human subjects. When no human subjects are detected, keeps the area in the center of the frame in focus and blurs the surrounding area.
Selective color	Keeps only a selected image color and makes other colors black-and-white.
Cross screen	Produces star-like rays of light that radiate outward from bright objects such as sunlight reflections and city lights. Suitable for night scenes.
Fisheye	Creates images that look like they were shot with a fisheye lens. Suitable for images shot in macro mode.
Miniature effect	Creates images that look like close-up photos of a diorama. Suitable for images shot while looking down from a high location, with the main subject near the center of the frame.
Painting	Creates images with the ambience of paintings.
Vignette	Lowers the peripheral light intensity from the center to the edges of an image.
Photo illustration	Emphasizes outlines and reduces the number of colors to create images with the ambience of illustrations.
Portrait (color + B&W)	Makes colors of the background of human subjects black-and-white. When no human subjects are detected, keeps colors of the area in the center of the frame and makes the surrounding area black-and-white.

1 Use the multi selector ▲▼ to select the desired filter effect and press the **OK** button.

- When effects other than **Selective color** are selected, proceed to step 3.

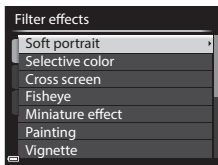

- 2 Use ▲▼ to select the color to keep and press the **OK** button.

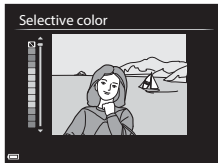

- 3 Preview the result and press the **OK** button.

- An edited copy is created.
- To exit without saving the copy, press ◀.



Small Picture: Reducing the Size of an Image

Select an image (📖32) → MENU button (📖8) →  Small picture

- 1 Use the multi selector ▲▼ to select the desired copy size and press the **OK** button.

- When the aspect ratio of the image is 16:9, only **640×360** can be selected.
- When the aspect ratio of the image is 3:2 or 1:1, the image cannot be edited.

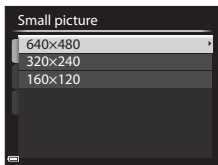

- 2 Select **Yes** and press the **OK** button.

- An edited copy is created (compression ratio of approximately 1:16).

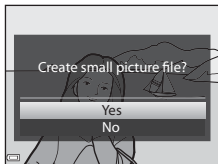

NRW RAW (NRW) Processing: Creating JPEG Images from NRW Images

Press the button (playback mode) → MENU button (8) → NRW RAW (NRW) processing

- 1 Use the multi selector to select the image to be RAW processed and press the button.

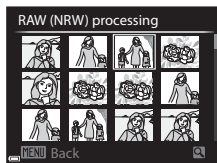

- 2 Set the RAW (NRW) processing parameters.

- Apply the settings below while checking the image by moving the zoom control toward **T** (). Move toward **T** () again to return to the setting screen.
 - **White balance** (31)
 - **Exp. +/-** (63)
 - **Picture Control** (26)
 - **Image quality** (23)
 - **Image size** (25)
 - **D-Lighting** (8)
- Press the button to change back to the default settings.
- Select **EXE** when all settings have been adjusted.

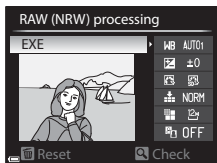

- 3 Select **Yes** and press the button.

- A JPEG image is created.

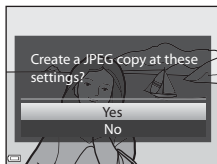

Notes About RAW (NRW) Processing

- This camera can only create JPEG-format copies of RAW (NRW) images taken with this camera.
- **Preset manual** of **White balance** can only be selected for images taken with **White balance** set to **Preset manual**.
- The **Noise reduction filter** (45) that was set for shooting images is applied to the JPEG images to be created.





More Information

See "Printing Images of Size 1:1" (25) for more information.

Crop: Creating a Cropped Copy

1 Move the zoom control to enlarge the image (81).

2 Refine copy composition and press the **MENU** button.

- Move the zoom control toward **T** () or **W** () to adjust the zoom ratio. Set a zoom ratio at which **MENU**  is displayed.
- Use the multi selector  to scroll the image so that only the portion to be copied is visible in the monitor.



3 Select **Yes** and press the **OK** button.

- An edited copy is created.



Image Size

When the image size of the cropped copy is 320 × 240 or smaller, the image is displayed at a smaller size during playback.

Cropping the Image in Its Current “Tall” Orientation

Use the **Rotate image** option (55) to rotate the image so that it is displayed in landscape orientation. After cropping the image, rotate the cropped image back to “tall” orientation.

Connecting the Camera to a TV (Viewing Images on a TV)

1 Turn off the camera and connect it to the TV.

- Make sure that the plugs are properly oriented. Do not insert or remove the plugs at an angle when connecting or disconnecting them.

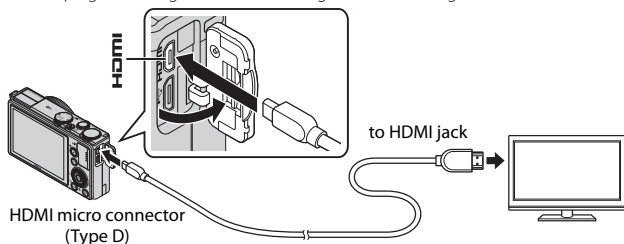

2 Set the TV's input to external input.

- See the documentation provided with your TV for details.

3 Press and hold down the button to turn on the camera.

- Images are displayed on the TV.
- The camera monitor does not turn on.

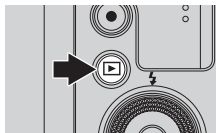

Using a TV Remote Control (HDMI Device Control)

The remote control of an HDMI-CEC-compatible TV can be used to select images, start and pause movie playback, switch between full-screen playback mode and four-image thumbnail display, etc.

- Set **HDMI device control** ( 76) of **TV settings** to **On** (default setting) in the setup menu, and then connect the camera and TV using an HDMI cable.
- Aim the remote control at the TV when operating it.

Connecting the Camera to a Printer (Direct Print)

Users of PictBridge-compatible printers can connect the camera directly to the printer and print images without using a computer.

Connecting the Camera to a Printer

- 1 Turn off the camera.
- 2 Turn on the printer.
 - Check printer settings.
- 3 Connect the camera to the printer using the included USB cable.
 - Make sure that the plugs are properly oriented. Do not insert or remove the plugs at an angle when connecting or disconnecting them.

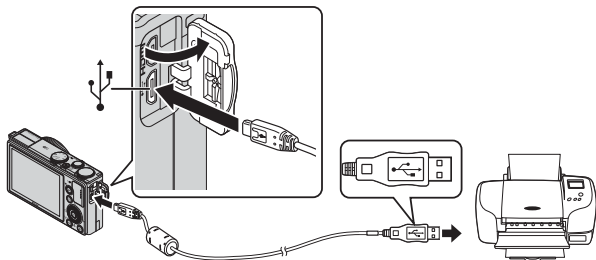

4 The camera is automatically turned on.

- The **PictBridge** startup screen (①) is displayed in the camera monitor, followed by the **Print selection** screen (②).

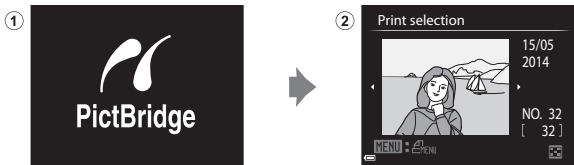

✓ If the PictBridge Startup Screen Is not Displayed

When **Auto** is selected for **Charge by computer** (77), it may be impossible to print images with direct connection of the camera to some printers.

If the PictBridge startup screen is not displayed after the camera is turned on, turn the camera off and disconnect the USB cable. Set **Charge by computer** to **Off** and reconnect the camera to the printer.

📎 More Information

See "Printing Images of Size 1:1" (25) for more information.

Printing Individual Images

1 Use the multi selector ▲▼◀▶ to select the desired image and press the **OK** button.

- Move the zoom control toward **W** (📐) to switch to thumbnail playback or **T** (📄) to switch to full-frame playback.

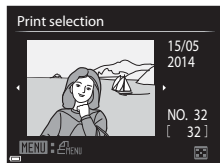

2 Use ▲▼ to select **Copies** and press the **OK** button.

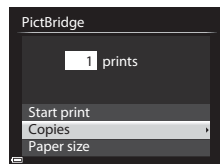

- 3** Select the desired number of copies (up to 9) and press the **OK** button.



- 4** Select **Paper size** and press the **OK** button.

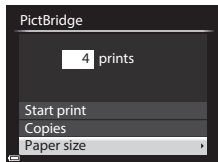

- 5** Select the desired paper size and press the **OK** button.

- To apply the paper size setting configured on the printer, select **Default** as the paper size option.
- The paper size options available on the camera vary depending on the printer that you use.

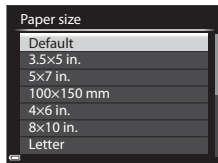

- 6** Select **Start print** and press the **OK** button.

- Printing starts.
- To cancel printing, press the **OK** button.

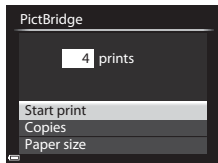

Printing Multiple Images

- 1 When the **Print selection** screen is displayed, press the **MENU** button.

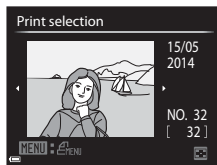

- 2 Use the multi selector ▲▼ to select **Paper size** and press the **OK** button.
 - To exit the print menu, press the **MENU** button.

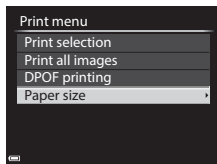

- 3 Select the desired paper size and press the **OK** button.
 - To apply the paper size setting configured on the printer, select **Default** as the paper size option.
 - The paper size options available on the camera vary depending on the printer that you use.

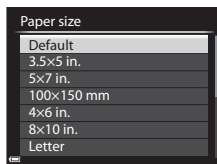

- 4 Select **Print selection**, **Print all images**, or **DPOF printing** and press the **OK** button.

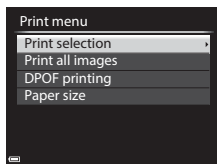

Print selection

Select images (up to 99) and the number of copies (up to 9) of each.

- Use the multi selector ◀▶ to select images, and use ▲▼ to specify the number of copies to be printed.
- Images selected for printing are indicated by the check mark icon and the numeral indicating the number of copies to be printed. If no copies have been specified for images, the selection is canceled.
- Move the zoom control toward **T** (Q) to switch to full-frame playback or **W** (R) to switch to thumbnail playback.
- Press the **OK** button when setting is complete.
- When the screen shown on the right is displayed, select **Start print** and press the **OK** button to start printing.

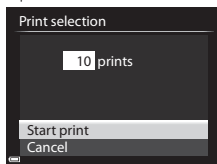

Print all images

One copy each of all images saved in the internal memory, or on the memory card, is printed.

- When the screen shown on the right is displayed, select **Start print** and press the **OK** button to start printing.

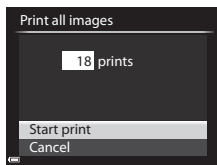

DPOF printing

Print images for which a print order was created using the **Print order** option (52).



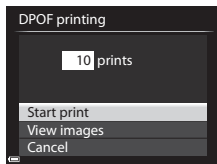

- When the screen shown on the right is displayed, select **Start print** and press the **OK** button to start printing.
To view the current print order, select **View images** and press the **OK** button. To print images, press the **OK** button again.



Editing Movies

When editing movies, use a sufficiently charged battery to prevent the camera from turning off during editing. When the battery level indicator is , movie editing is not possible.



Restrictions on Movie Editing

Movies recorded with  1080/60i or  1080/50i, or  iFrame 720/30p or  iFrame 720/25p cannot be edited.



Extracting Only the Desired Portion of a Movie

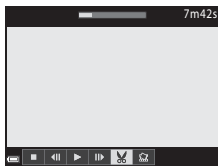

The desired portion of a recorded movie can be saved as a separate file.

1 Play back the desired movie and pause at the start point of the portion that is to be extracted (91).



2 Use the multi selector  to select the  control, and then press the  button.





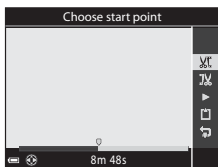

3 Use  to select the  control (Choose start point).

- Use  or rotate the command dial to move the start point.
- To cancel editing, select  (Back), and press the  button.



4 Use  to select  (Choose end point).

- Use  or rotate the command dial to move the end point.
- To preview the specified portion, use  to select  and then press the  button. Press the  button again to stop previewing.

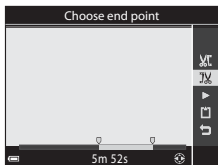

5 Use ▲▼ to select (Save) and press the button.

- Follow the instructions on the screen to save the movie.

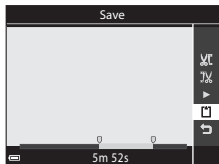





Notes About Movie Extracting



- A movie that was created by editing a recorded movie cannot be edited again.
- The actual trimmed portion of a movie may differ slightly from the portion selected using the start and end points.
- Movies cannot be trimmed so that they are less than two seconds long.

Saving a Frame from a Movie as a Still Image

The desired frame of a recorded movie can be extracted and saved as a still image.

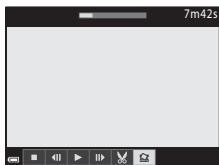
- Pause a movie and display the frame to be extracted (91).
- Use the multi selector  to select the  control and press the  button.



- Select **Yes** when a confirmation dialog is displayed, and press the  button to save the image.
- The still image is saved with **Normal** as the image quality. The image size is determined by the type (image size) (59) of the original movie.

For example, a still image saved from a movie

recorded with  **1080/30p** (or  **1080/25p**) is  (1920 × 1080 pixels).

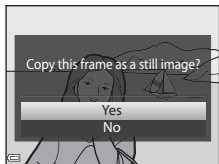

The Shooting Menu (P, S, A or M Mode)

Image Quality

Enter shooting mode → MENU button → P, S, A, M or U tab (📖9) → Image quality

Set the image quality (compression ratio) used when saving images. Lower compression ratios result in higher quality images, but the number of images that can be saved is reduced.

Option		Description
FINE	Fine	Finer image quality than Normal . Compression ratio of about 1:4
NORM	Normal (default setting)	Normal image quality, suitable for most applications. Compression ratio of about 1:8
NRW+ FINE	RAW (NRW) + Fine	Two images are saved at the same time: one RAW (NRW) image and one fine-quality JPEG image.
NRW+ NORM	RAW (NRW) + Normal	Two images are saved at the same time: one RAW (NRW) image and one normal-quality JPEG image.
NRW	RAW (NRW)	Raw data from the image sensor are saved. Create JPEG image files after shooting using RAW (NRW) processing (🔧12) in the playback menu. <ul style="list-style-type: none">When RAW (NRW) is selected, Image size is reset to 4000×3000. File format: RAW (NRW), Nikon's own format



RAW (NRW) Images of This Camera

- To print or edit RAW (NRW) images, use JPEG images created from the RAW (NRW) images using **RAW (NRW) processing** (🔧12). RAW (NRW) images cannot be printed or edited.
- ViewNX 2 (📖99) needs to be installed on the computer to be able to view RAW (NRW) images on the computer.



Image Quality Setting

- The image quality can be set in any shooting mode. The setting is also applied to other shooting modes (except shooting mode **U** and **Easy panorama** scene mode).
- RAW (NRW) images cannot be saved in the following shooting modes.
 - Scene mode
 - Special effects mode

If you change the shooting mode to either of the above shooting modes when a RAW (NRW) image quality has been selected, the image quality will change to **Fine** or **Normal**.

- Digital zoom cannot be used when **Image quality** is set to **RAW (NRW)**, **RAW (NRW) + Fine** or **RAW (NRW) + Normal**.
- The setting may not be changed when using certain settings of other functions.

Saving of RAW (NRW) and JPEG Images at the Same Time

- The RAW (NRW) image and the JPEG image that are saved at the same time have the same file number but with their own file extensions, “.NRW” and “.JPG” (86).
- When playing back on the camera, only the JPEG image is displayed.
- Note that when the JPEG image is deleted by pressing the  button, the RAW (NRW) image that was saved at the same time is also deleted.

Number of Images That Can Be Saved

- The approximate number of images that can be saved can be checked in the monitor when shooting (22).
- Note that due to JPEG compression, the number of images that can be saved may vary greatly depending on the image content, even when using memory cards with the same capacity and the same image quality and image size settings. In addition, the number of images that can be saved may vary depending on the make of the memory card.
- If the number of exposures remaining is 10,000 or more, the number of exposures remaining display shows “9999.”

Image Size

Enter shooting mode → MENU button → P, S, A, M or U tab (📖9) → Image size

Set the image size (number of pixels) used when saving JPEG images. The larger the image size, the larger the size at which it can be printed, but the number of images that can be saved is reduced.













Option	Aspect ratio (horizontal to vertical)
 4000×3000 (default setting)	4:3
 3264×2448	4:3
 2272×1704	4:3
 1600×1200	4:3
 640×480	4:3
 3968×2232	16:9
 1920×1080	16:9
 3984×2656	3:2
 3000×3000	1:1



Image Size Setting

- The image size can be set in any shooting mode. The setting is also applied to other shooting modes (except shooting mode **U** and **Easy panorama** scene mode).
- The size of JPEG images can be selected when you create JPEG images from RAW (NRW) images using **RAW (NRW) processing** (📖12) (up to a maximum of 4000 × 3000 pixels).
- **Image size** for the JPEG image can be set when **RAW (NRW) + Fine** or **RAW (NRW) + Normal** is selected. However, note that  **3968×2232**,  **1920×1080**,  **3984×2656** and  **3000×3000** cannot be selected.
- The setting may not be changed when using certain settings of other functions.









Printing Images of Size 1:1

Change the printer setting to “Border” when printing images with the size set to 1:1. The images may not be printed in 1:1 ratio depending on the printer.

Picture Control (COOLPIX Picture Control) (Changing the Settings for Image Recording)

Rotate the mode dial to **P, S, A, M** or **U** → **MENU** button → **P, S, A, M** or **U** tab (📖9) → **Picture Control**

Change the settings for image recording according to the shooting scene or your preferences. Sharpness, contrast and saturation can be adjusted in detail.

Option	Description
 Standard (default setting)	Standard processing for balanced results. Recommended for most situations.
 Neutral	Minimal processing for natural results. Select for images that will later be processed or retouched.
 Vivid	Images are enhanced for a vivid, photoprint effect. Select for images that emphasize primary colors, such as blue, red, and green.
 Monochrome	Shoots monochrome photographs such as in black-and-white or sepia.
 Custom 1 *	Changes to the setting of Custom 1 in COOLPIX Custom Picture Control.
 Custom 2 *	Changes to the setting of Custom 2 in COOLPIX Custom Picture Control.

* Only displayed when the setting customized in **Custom Picture Control** (📖30) has been registered.

COOLPIX Picture Control

- The COOLPIX Picture Control function of this camera cannot be used with other makes of cameras, Capture NX, Capture NX 2 and ViewNX 2 Picture Control function.
- The setting may not be changed when using certain settings of other functions.

Customizing Existing COOLPIX Picture Controls: Quick Adjust and Manual Adjust

COOLPIX Picture Control can be customized using Quick adjust, which allows for balanced adjustment of sharpness, contrast, saturation and other image editing components, or manual adjust, which allows for detailed adjustment of the components individually.

- 1 Use the multi selector ▲▼ to select the desired type of COOLPIX Picture Control and press the OK button.

- Items can also be selected by rotating the multi selector.

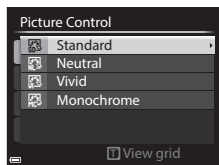

- 2 Use ▲▼ to highlight the desired option (0-28) and use ◀▶ to select a value.

- Press the OK button to set the value.
- When COOLPIX Picture Controls are modified from the default settings, an asterisk (*) is displayed after the options in the Picture Control setting menu.
- To change the adjusted values to the default setting, select **Reset** and press the OK button.

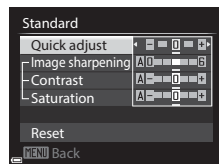

View Grid of COOLPIX Picture Control

When the zoom control is moved toward T (Q) on the screen shown in step 1, the current and default settings are displayed on a square grid so that you can see their relations with the other COOLPIX Picture Controls.

The vertical axis indicates the level of contrast, and the horizontal axis indicates the level of saturation. To return to the setting screen, move the zoom control toward T (Q) again.

- Rotate the multi selector to change to other COOLPIX Picture Controls.
- Press the OK button to display the COOLPIX Picture Control setting screen (step 2 above).
- For **Monochrome**, the grid is displayed for contrast only.
- The grid is also displayed when adjusting **Contrast** or **Saturation** with manual adjustment.

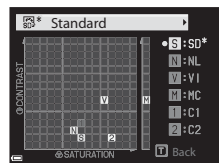

Types of Quick Adjust and Manual Adjust

Option	Description
Quick adjust ¹	<p>Adjusts the sharpness, contrast and saturation levels automatically.</p> <p>Setting to the – side reduces the effect of the selected COOLPIX Picture Control, and setting to the + side emphasizes its effect.</p> <ul style="list-style-type: none">• Default setting: 0
Image sharpening	<p>Controls how much outlines are sharpened during shooting. The higher the number, the sharper the image, and the lower the number, the softer the image.</p> <p>Select A (auto) for automatic adjustment.</p> <ul style="list-style-type: none">• Default setting: 3 for Standard or Monochrome, 2 for Neutral and 4 for Vivid
Contrast	<p>Controls the contrast.</p> <p>Setting to the – side gives the image a softer appearance, and setting to the + side gives it a harder appearance. Select lower values to prevent highlights in portrait subjects from being “washed out” in direct sunlight, higher values to preserve detail in misty landscapes and other low contrast subjects.</p> <p>Select A (auto) for automatic adjustment.</p> <ul style="list-style-type: none">• Default setting: 0
Saturation ²	<p>Controls the vividness of colors.</p> <p>Setting to the – side reduces the vividness, and setting to the + side increases the vividness.</p> <p>Select A (auto) for automatic adjustment.</p> <ul style="list-style-type: none">• Default setting: 0
Filter effects ³	<p>Simulates the effect of color filters on monochrome photographs.</p> <ul style="list-style-type: none">• OFF: Filter effects are not used.• Y (yellow), O (orange), R (red): Enhance contrast. Can be used to tone down the brightness of the sky in landscape photographs. The contrast is strengthened in the order Y → O → R.• G (green): Softens skin tones. Suitable for portraits.• Default setting: OFF

Option	Description
Toning ³	<p>Controls the tint used in monochrome photographs from B&W (black-and-white), Sepia, and Cyanotype (blue-tinted monochrome).</p> <p>Pressing the multi selector ▼ when Sepia or Cyanotype is selected enables you to select a saturation level. Press ◀▶ to adjust the saturation.</p> <ul style="list-style-type: none"> • Default setting: B&W (black-and-white)

¹ Quick adjust is not available in **Neutral**, **Monochrome**, **Custom 1** and **Custom 2**. The values set manually are disabled if quick adjust is used after manual setting.

² Not displayed for **Monochrome**.

³ Only displayed for **Monochrome**.

Notes About Image Sharpening

The effects of **Image sharpening** cannot be previewed in the monitor during shooting. Check the results in playback mode.

Contrast, Saturation and A (Auto)

- Results for contrast and saturation vary with the exposure, and the position and size of the subject in the frame.
- The setting for a COOLPIX Picture Control which has **A** (auto) selected for either **Contrast** or **Saturation** is displayed in green in the COOLPIX Picture Control grid.

Custom Picture Control (COOLPIX Custom Picture Control)

Rotate the mode dial to P, S, A, M or U → MENU button → P, S, A, M or U tab (📖9) → Custom Picture Control

Customize the settings of COOLPIX Picture Control (🔧27) and register them in **Custom 1** or **Custom 2** of **Picture Control**.

Creating COOLPIX Custom Picture Controls

1 Use the multi selector ▲▼ to select **Edit and save**, and press the Ⓞ button.

- Select **Delete** to delete a registered COOLPIX Custom Picture Control.

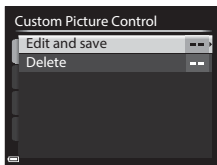

2 Select the original COOLPIX Picture Control (🔧27) to be edited, and press the Ⓞ button.

3 Use ▲▼ or highlight the desired option and use ◀▶ to select a value (🔧27).

- The options are the same as those for adjusting the COOLPIX Picture Control.
- Press the Ⓞ button when you finish adjustment.
- To change the adjusted values to the default setting, select **Reset** and press the Ⓞ button.

4 Select the registration destination and press the Ⓞ button.

- **Custom 1** or **Custom 2** becomes selectable in **Picture Control** or **Custom Picture Control**.
- To change the adjusted values, select **Custom 1** or **Custom 2** in **Picture Control** or **Custom Picture Control**.

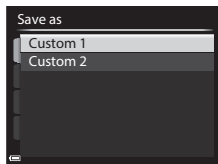

White Balance (Adjusting Hue)

Rotate the mode dial to **P, S, A, M** or **U** → MENU button → **P, S, A, M** or **U** tab (📖9) → White balance

Adjust white balance to suit the light source or weather conditions in order to make the colors in images match what you see with your eyes.

- Use **Auto (normal)** under most conditions. Change the setting when you want to adjust the hue of the image you are taking. You can also perform fine adjustment of white balance after selecting its type (🔍32).

	Option	Description
AUTO1	Auto (normal) (default setting)	White balance is automatically adjusted to suit lighting conditions. When set to Auto (warm lighting) , the images are preserved with warm colors if they are shot under an incandescent light source. When using the flash, white balance is adjusted according to the flash lighting condition.
AUTO2	Auto (warm lighting)	
PRE	Preset manual	Use when the desired result is not achieved with Auto (normal) , Auto (warm lighting) , Incandescent , etc. (🔍33).
☀️	Daylight	White balance is adjusted for direct sunlight.
💡	Incandescent	Use under incandescent lighting.
💡1 💡2 💡3	Fluorescent FL1 Fluorescent FL2 Fluorescent FL3	Select one of Fluorescent FL1 (cool-white fluorescent), Fluorescent FL2 (day white fluorescent) and Fluorescent FL3 (daylight fluorescent).
☁️	Cloudy	Use when taking images under overcast skies.
🔦	Flash	Use with the flash.
🔠	Choose color temp.	Use to directly specify color temperature (🔍32).

✓ Notes About White Balance

- Lower the flash when white balance is set to any setting other than **Auto (normal)**, **Auto (warm lighting)** or **Flash** (📖54).
- The setting may not be changed when using certain settings of other functions.

Fine Adjustment of White Balance

To perform fine adjustment of white balance, select the type of white balance and press the **OK** button.

Use the multi selector **▲▼◀▶** to configure settings.

- "A" represents amber, "B" blue, "G" green, and "M" magenta.
- Press the  button to reset.
- Press the **MENU** button to return to the previous screen.

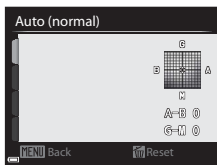

The color displayed in the fine-tune screen represents the approximate color in the color temperature direction. A fine-tuned color may not be exactly the same as that in the image. For example, when the white balance is set to **Incandescent**, the image will not have a strong blue color even if fine adjustment is performed in the B (blue) direction.

Color Temperature

Color temperature is an objective measure of colors of light sources which are expressed in the unit of absolute temperature (K: Kelvin). Light sources with lower color temperatures appear more reddish, while light sources with higher color temperatures appear more bluish.

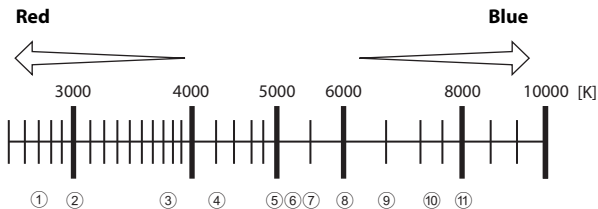

- | | |
|--|-----------------------------------|
| ① Sodium-vapor lamps: 2700K | ⑦ Flash: 5400K |
| ② Incandescent/
Warm-white fluorescent: 3000K | ⑧ Cloudy: 6000K |
| ③ White fluorescent: 3700K | ⑨ Daylight fluorescent: 6500K |
| ④ Cool-white fluorescent: 4200K | ⑩ High temp. mercury-vapor: 7200K |
| ⑤ Day white fluorescent: 5000K | ⑪ Shade: 8000K |
| ⑥ Direct sunlight: 5200K | |

Using Preset Manual

Use the procedure below to measure the white balance value under the lighting used during shooting.

1 Place a white or gray reference object under the lighting that will be used during shooting.

2 Use the multi selector ▲▼ to select **Preset manual**, and press the **OK** button.

- The lens extends to the zoom position for measurement.

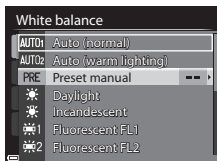

3 Select **Measure**.

- To apply the last measured value, select **Cancel**.

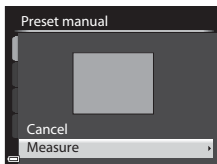

4 Frame the white or gray reference object in the measuring window, and press the **OK** button to measure the value.

- The shutter is released and measurement is complete (no image is saved).

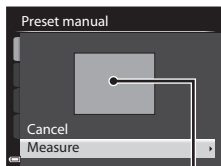

Measuring window

5 Perform fine adjustment of the measured white balance value (0-32), and press the **OK** button.

✓ Notes About Preset Manual



A white balance value for flash lighting cannot be measured with **Preset manual**. When shooting using the flash, set **White balance** to **Auto (normal)**, **Auto (warm lighting)** or **Flash**.

Metering

Rotate the mode dial to **P, S, A, M** or **U** → **MENU** button → **P, S, A, M** or **U** tab (📖9) → Metering

The process of measuring the brightness of the subject to determine the exposure is known as “metering.”

Use this option to set the method of how the camera meters exposure.

Option	Description
 Matrix (default setting)	The camera uses a wide area of the screen for metering. Recommended for typical shooting.
 Center-weighted	The camera meters the entire frame but assigns greatest weight to the subject in the center of the frame. The classic metering for portraits; it preserves background details while letting lighting conditions in the center of the frame determine exposure.*
 Spot	The camera meters the area shown by the circle in the center of the frame. This can be used when the subject is much lighter or darker than the background. Ensure that the subject is within the area shown by the circle when shooting.*

* To set focus and exposure for off-center subjects, change **AF area mode** to manual and set the focus area to the center of the frame, and then use focus lock (📖80).

Notes About Metering









- When digital zoom is in effect, **Center-weighted** or **Spot** is selected depending on the magnification of an enlargement.
- The setting may not be changed when using certain settings of other functions.







Display on the Shooting Screen

When **Center-weighted** or **Spot** is selected, the metering range guide (📖12) is displayed (except when digital zoom is used).

Continuous Shooting

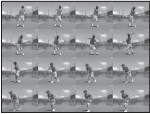
Rotate the mode dial to **P, S, A, M** or **U** → **MENU** button → **P, S, A, M** or **U** tab (📖9) → Continuous

Option	Description
 Single (default setting)	One image is captured each time the shutter-release button is pressed.
 Continuous H	While the shutter-release button is held all the way down, images are captured continuously. <ul style="list-style-type: none">The frame rate for continuous shooting is about 10 fps and the maximum number of continuous shots is about 10 (when image quality is set to Normal and image size is set to  4000×3000).
 Continuous L	While the shutter-release button is held all the way down, images are captured continuously. <ul style="list-style-type: none">The frame rate for continuous shooting is about 1 fps and the maximum number of continuous shots is about 200 (when image quality is set to Normal and image size is set to  4000×3000).
 Pre-shooting cache	Pre-shooting cache shooting begins when the shutter-release button is pressed halfway. When the shutter-release button is pressed the rest of the way down, the camera saves the current image as well as the images captured immediately before the button is pressed (🔧37). Pre-shooting cache makes it easy to capture perfect moments. <ul style="list-style-type: none">The frame rate for continuous shooting is about 15 fps and the maximum number of continuous shots is 20 (including a maximum of 5 frames captured in the pre-shooting cache).The image quality is fixed at Normal and the image size is fixed at  (2048 × 1536 pixels).
120 Continuous H: 120 fps	Each time the shutter-release button is pressed all the way, images are captured at a high speed rate. <ul style="list-style-type: none">The frame rate for continuous shooting is about 120 fps and the maximum number of continuous shots is 60.Image size is fixed at  (1280 × 960 pixels).

Option	Description
60 Continuous H: 60 fps	Each time the shutter-release button is pressed all the way, images are captured at a high speed rate. <ul style="list-style-type: none"> • The frame rate for continuous shooting is about 60 fps and the maximum number of continuous shots is 60. • Image size is fixed at  (1280 × 960 pixels).
BSS BSS (Best Shot Selector)	While the shutter-release button is held all the way down, the camera captures a series of up to 10 images and automatically saves the sharpest image. Use when shooting a stationary subject in a place where flash photography is prohibited and camera shake is likely to occur.
 Multi-shot 16	Each time the shutter-release button is pressed all the way, the camera captures a series of 16 images and saves it as a single image.  <ul style="list-style-type: none"> • The frame rate for continuous shooting is about 30 fps. • Image size is fixed at  (2560 × 1920 pixels). • Digital zoom is not available.
 Intvl timer shooting	The camera shoots still images automatically at the specified interval ( 37).

Notes About Continuous Shooting

- Focus, exposure and white balance are fixed at the values determined with the first shot in each series.
- It may take some time to save the images after shooting.
- When ISO sensitivity increases, noise may appear in captured images.
- The frame rate may become slower depending on the image quality, image size, memory card type or shooting conditions (such as when saving RAW images).
- When using **Multi-shot 16**, **Continuous H: 120 fps** or **Continuous H: 60 fps**, banding or variance in brightness or hue may occur in images that were captured under lighting that flashes quickly at high speeds, such as fluorescent, mercury-vapor, or sodium-vapor lighting.
- The setting may not be changed when using certain settings of other functions.

Pre-shooting Cache

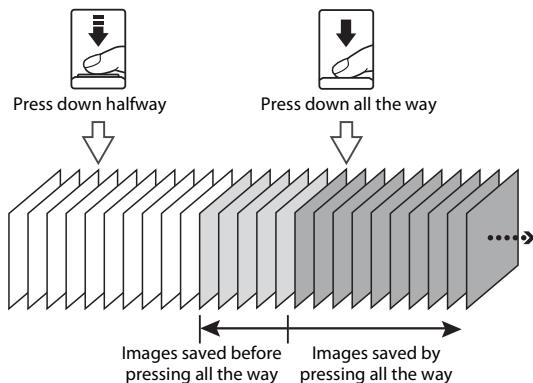

When the shutter-release button is pressed halfway or all the way down, images are saved in the manner described below.



- The pre-shooting cache icon () in the monitor glows green while the shutter-release button is pressed halfway.

Interval Timer Shooting

Rotate the mode dial to P, S, A, M or U → MENU button → P, S, A, M or U tab () → Continuous

- 1 Use the multi selector  to select  **Intvl timer shooting**, and then press the  button.

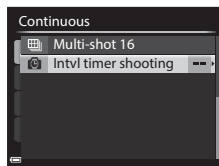

2 Set the desired interval between each shot.

- Use ◀▶ to select an item, and use ▲▼ to set the time.
- Press the **OK** button when setting is complete.

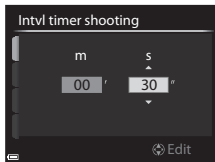

3 Press the **MENU** button to display the shooting screen.

4 Press the shutter-release button to shoot the first image.

- The shutter is automatically released at the specified interval to shoot subsequent images.
- The monitor turns off and the power-on lamp flashes during the intervals between shots (when the battery is used).

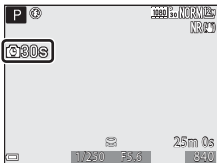

5 When the desired number of images have been taken, press the shutter-release button.

- Shooting ends.
- Shooting ends automatically when the internal memory or memory card becomes full.

✓ Notes About Interval Timer Shooting

- To prevent the camera from turning off unexpectedly during shooting, use a fully charged battery.
- If the AC Adapter EH-62F (available separately; ) is used, this camera can be powered from an electrical outlet. Do not, under any circumstances, use an AC adapter other than the EH-62F. Failure to observe this precaution could result in overheating or damage to the camera.
- Do not rotate the mode dial to a different setting while performing interval timer shooting.
- If the shutter speed is slow and saving an image takes time compared to the specified interval, some of the shots during interval timer shooting may be canceled.

ISO Sensitivity

Rotate the mode dial to **P, S, A, M** or **U** → **MENU** button → **P, S, A, M** or **U** tab (📖9) → ISO sensitivity

Higher ISO sensitivity allows darker subjects to be captured. Additionally, even with subjects of similar brightness, images can be taken at faster shutter speeds, and blurring caused by camera shake and subject movement can be reduced.

- When higher ISO sensitivity is set, images may contain noise.

Option	Description
ISO sensitivity	<ul style="list-style-type: none">• Auto (default setting): ISO sensitivity is automatically adjusted within a range from ISO 80 to 3200.• Fixed range auto: The range in which the camera automatically adjusts ISO sensitivity can be selected from ISO 400 ISO 80-400, ISO 800 ISO 80-800 or ISO 1600 ISO 80-1600.• 80 to 6400, Hi 1 (equivalent to ISO 12800): ISO sensitivity is fixed at the specified value.
Minimum shutter speed	<p>Set the shutter speed at which ISO sensitivity starts to be automatically adjusted when the shooting mode is P or A. If the exposure is insufficient with the shutter speed that is set here, the ISO sensitivity is increased automatically to obtain the correct exposure.</p> <ul style="list-style-type: none">• The setting is enabled when ISO sensitivity is set to Auto or Fixed range auto.• If the exposure is still insufficient even after ISO sensitivity is increased, the shutter speed slows down.• Default setting: None

ISO Sensitivity Display on the Shooting Screen

- When **Auto** is selected, **ISO** is displayed if the ISO sensitivity automatically increases.
- When **ISO 80-400**, **ISO 80-800**, or **ISO 80-1600** is selected, the maximum value for ISO sensitivity is displayed.

Notes About ISO Sensitivity

- In **M** (manual) mode, when set to **Auto**, **ISO 80-400**, **ISO 80-800**, or **ISO 80-1600**, the ISO sensitivity is fixed at ISO 80.
- The setting may not be changed when using certain settings of other functions.

Exposure Bracketing

Rotate the mode dial to **P**, **S** or **A** → MENU button → **P**, **S** or **A** tab (📖9)
→ Exposure bracketing

The exposure (brightness) can be changed automatically during continuous shooting. This is effective for shooting when it is difficult to adjust the picture brightness.

Option	Description
Off (default setting)	Exposure bracketing is not performed.
±0.3	When the shutter-release button is pressed all the way, three shots are taken in sequence and the camera varies exposure by 0, -0.3, and +0.3 over the shots.
±0.7	When the shutter-release button is pressed all the way, three shots are taken in sequence and the camera varies exposure by 0, -0.7, and +0.7 over the shots.
±1.0	When the shutter-release button is pressed all the way, three shots are taken in sequence and the camera varies exposure by 0, -1.0, and +1.0 over the shots.

✓ Notes About Exposure Bracketing



- **Exposure bracketing** is not available in **M** (manual) mode.
- When exposure compensation (📖63) and **±0.3**, **±0.7** or **±1.0** in **Exposure bracketing** are set simultaneously, the combined exposure compensation values are applied.
- The setting may not be changed when using certain settings of other functions.

AF Area Mode

Rotate the mode dial to **P, S, A, M** or **U** → **MENU** button → **P, S, A, M** or **U** tab (📖9) → AF area mode

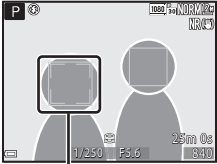
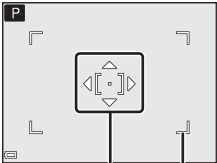
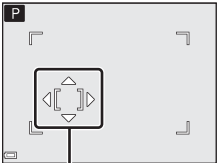
Change the method of how the camera selects the focus area for autofocus.

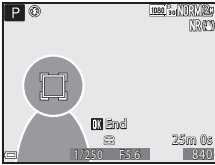
Option	Description
 Face priority	<p>When the camera detects a human face, it focuses on that face. See “Using Face Detection” (📖78) for more information.</p> <p>When framing a composition with no human subjects or detected faces, the camera automatically selects one or more of the 9 focus areas containing the subject closest to the camera.</p>  <p style="text-align: center;">Focus area</p>
<p>[] Manual (spot)</p> <p>[] Manual (normal)</p> <p>[] Manual (wide)</p>	<p>Use the multi selector ▲▼◀▶ or rotate it to move the focus area to where you want to focus.</p> <p>To set ⚡, ⏰, 🔄 or ☑ using the multi selector (📖53), press the OK button to apply the focus area. To move the focus area again, press the OK button again.</p>  <p style="text-align: center;">Focus area (center) Scope of movable focus area</p>  <p style="text-align: center;">Focus area (moved)</p>

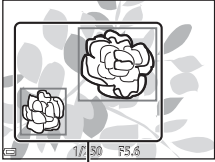
Option	Description
 Subject tracking	<p>Use this function to take images of moving subjects. Register the subject on which the camera focuses. The focus area automatically moves to track the subject. See “Using Subject Tracking” (📖43) for more information.</p> 
 Target finding AF (default setting)	<p>When the camera detects the main subject, it focuses on that subject. See “Using the Target Finding AF” (📖77).</p>  <p style="text-align: center;">Focus areas</p>

Notes About AF Area Mode

- When digital zoom is in effect, the camera focuses on the area in the center of the frame regardless of the **AF area mode** setting.
- The setting may not be changed when using certain settings of other functions.

Using Subject Tracking

Rotate the mode dial to **P, S, A, M** or **U** → **MENU** button → **P, S, A, M** or **U** tab (📖9) → **AF area mode**

- 1 Use the multi selector ▲▼ to select **Subject tracking**, and press the **OK** button.

- Press the **MENU** button after changing the settings and return to the shooting screen.

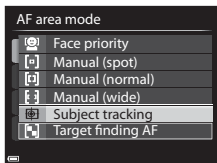

- 2 Register a subject.

- Align the subject that you want to track with the border in the center of the monitor and press the **OK** button.
- When the subject is registered, a yellow border (focus area) is displayed around that subject and the camera begins tracking that subject.
- If the subject cannot be registered, the border glows red. Change the composition and try registering the subject again.
- To cancel subject registration, press the **OK** button.
- If the camera can no longer track the registered subject, the focus area disappears. Register the subject again.

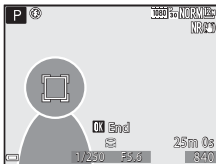

- 3 Press the shutter-release button fully to take the picture.

- If the shutter-release button is pressed while the focus area is not displayed, the camera focuses on the area in the center of the frame.



Notes About Subject Tracking

- If you perform operations such as zooming while the camera is tracking the subject, the registration is canceled.
- Subject tracking may not be possible in certain shooting conditions.

Autofocus Mode

Rotate the mode dial to **P, S, A, M** or **U** → **MENU** button → **P, S, A, M** or **U** tab (📖9) → Autofocus mode

Select how the camera focuses when shooting still images.

Option	Description
AF-S Single AF (default setting)	The camera focuses only when the shutter-release button is pressed halfway.
AF-F Full-time AF	The camera continues focusing even when the shutter-release button is not pressed halfway. The sound of lens drive movement is heard while the camera focuses.

✓ Notes About Autofocus Mode

The setting may not be changed when using certain settings of other functions.

📎 Autofocus Mode for Movie Recording

Autofocus mode for movie recording can be set with **Autofocus mode** (📷62) in the movie menu.

Flash Exp. Comp.

Rotate the mode dial to **P, S, A, M** or **U** → **MENU** button → **P, S, A, M** or **U** tab (📖9) → Flash exp. comp.

Adjust the flash output.

Use this option when the flash is too bright or too dark.

Option	Description
+0.3 to +2.0	The flash output is increased from +0.3 to +2.0 EV, in increments of 1/3 EV, to make the main subject of the frame appear brighter.
0.0 (default setting)	The flash output is not adjusted.
-0.3 to -2.0	The flash output is reduced from -0.3 to -2.0 EV, in increments of 1/3 EV, to prevent unwanted highlights or reflections.

Noise Reduction Filter

Rotate the mode dial to **P, S, A, M** or **U** → **MENU** button → **P, S, A, M** or **U** tab (📖9) → Noise reduction filter



Set the strength of the noise reduction function that is normally performed when saving images.

Option	Description
NR High	Performs noise reduction at a level higher than the standard strength.
NR Normal (default setting)	Performs noise reduction at the standard strength.
NR Low	Performs noise reduction at a level lower than the standard strength.

Built-in ND Filter

Rotate the mode dial to **P**, **S**, **A**, **M** or **U** → MENU button → **P**, **S**, **A**, **M** or **U** tab (📖9) → Built-in ND filter

When the camera's built-in ND filter is used, the amount of light that enters the camera can be reduced to about one-eighth (equivalent to three steps lower in terms of the exposure value) while shooting. Use in situations such as when overexposure results from the subject being too bright.

Option	Description
 On	Use the ND filter to reduce the light.
 Auto	In mode P (programmed auto), reduce the light automatically with the ND filter according to the brightness of the subject. <ul style="list-style-type: none">In shooting modes S, A and M, the ND filter becomes Off even if this option is selected.
OFF Off (default setting)	The ND filter is not used.

Effects of the Built-in ND Filter



Using the filter may enable the shooting of subjects that are too bright without overexposing the image. It can also be used in situations such as when you want to slow down the shutter speed at a small aperture value.

For example, at a shutter speed of 1/2000 second with the correct exposure, if the ND filter is used to reduce the light by three steps, the speed can be changed to 1/250 second without changing the aperture value.

Active D-Lighting

Rotate the mode dial to **P, S, A, M** or **U** → **MENU** button → **P, S, A, M** or **U** tab (📖9) → Active D-Lighting

Details in highlights and shadows are preserved, and the natural contrast that is seen with the naked eye is well reproduced in the image taken. This is particularly effective for shooting scenes with high contrast, such as brightly lit outdoor scenery from a dark room or shaded subjects at a sunny seaside.

Option	Description
 High  Normal  Low	Set the effect level.
OFF Off (default setting)	Active D-Lighting is not applied.

Notes About Active D-Lighting

- Additional time is required to save images after shooting.
- The setting may not be changed when using certain settings of other functions.

Active D-Lighting Versus D-Lighting

The **Active D-Lighting** option in the shooting menu reduces exposure before shooting to adjust the dynamic range properly. The **D-Lighting** (📖8) option in the playback menu readjusts the dynamic range properly in images captured.

Multiple Exposure

Rotate the mode dial to **P, S, A, M** or **U** → MENU button → **P, S, A, M** or **U** tab (📖9) → Multiple exposure

The camera combines two to three images and saves them as a single image.

Option	Description
Multiple exposure mode	Shoots images in multiple exposure mode when set to On . <ul style="list-style-type: none">• Individual images are also saved.• Default setting: Off
Auto gain	Set whether or not to automatically adjust the brightness of the image when combining images. <ul style="list-style-type: none">• Default setting: On

✓ Notes About Multiple Exposure

- It may take some time to combine images.
- Multiple exposure is terminated if the auto off function (📖93) triggers the standby mode during shooting. When shooting with a long interval between shots, setting a longer time for the auto off function is recommended.
- The setting may not be changed when using certain settings of other functions.

Multiple Exposure Shooting

Rotate the mode dial to **P, S, A, M** or **U** → MENU button → **P, S, A, M** or **U** tab (📖9) → Multiple exposure

- 1 Use the multi selector ▲▼ to select **Multiple exposure mode**, and then press the **OK** button.

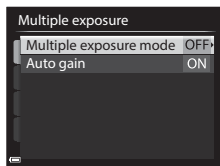

- 2 Select **On**, and then press the **OK** button.

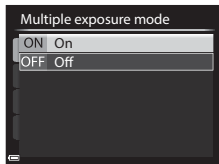

- 3 Press the **MENU** button to display the shooting screen.

- 4 Press the shutter-release button to shoot the first image.

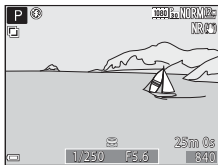

- 5 Press the shutter-release button to shoot the second image.

- Frame the picture while looking at the first image displayed translucently.
- When shooting the second image, the combined image of the first and second images is saved, and displayed translucently.
- To end multiple exposure at the second image, set **Multiple exposure mode** to **Off** or change the mode dial to any mode other than **P**, **S**, **A**, **M** or **U**.

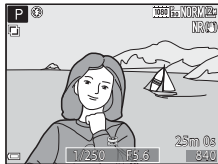

- 6 Press the shutter-release button to shoot the third image.

- The combined image of the first to third images is saved and multiple exposure ends.
- It may take some time until the third image is shot.

Zoom Memory

Rotate the mode dial to **P, S, A, M** or **U** → **MENU** button → **P, S, A, M** or **U** tab (📖9) → Zoom memory

Option	Description
On	<p>When the zoom control is moved, the zoom position (equivalent to focal length/angle of view in 35mm [135] format) is switched to the positions that have been selected by setting the check box to on in this menu option. The following settings are available: 24 mm, 28 mm, 35 mm, 50 mm, 85 mm, 105 mm, 120 mm.</p> <ul style="list-style-type: none">• Choose the focal length with the multi selector, and then press the OK button to set the check box to on [✓] or off.• The default setting is on [✓] for all the check boxes.• To finish setting, press the multi selector ►.• The zoom position set in the Startup zoom position is automatically set to on [✓].
Off (default setting)	<p>The zoom position can be moved to any position, including the positions that can be set with On.</p>

✓ Notes About Zoom Operation

- When more than one focal length has been set, move the zoom control to switch to the focal length closest to that before the operation. To switch to a different focal length, release the zoom control and then move it again.
- Set **Zoom memory** to **Off** when using the digital zoom.

Startup Zoom Position

Rotate the mode dial to **P, S, A, M** or **U** → MENU button → **P, S, A, M** or **U** tab (📖9) → Startup zoom position

Set the zoom position (equivalent to focal length/angle of view in 35mm [135] format) for when the camera is turned on.

The following settings are available: **24 mm** (default setting), **28 mm**, **35 mm**, **50 mm**, **85 mm**, **105 mm** and **120 mm**.

M Exposure Preview

Rotate the mode dial to **P, S, A, M** or **U** → MENU button → **P, S, A, M** or **U** tab (📖9) → M exposure preview

Set whether or not to reflect the brightness to the shooting screen when the exposure is changed in **M** (manual) mode.

Option	Description
On	Reflects the brightness to the shooting screen.
Off (default setting)	Does not reflect the brightness to the shooting screen.

The Playback Menu

See “Editing Still Images” (📷7) for information about image editing functions.

🖨️ Print Order (Creating a DPOF Print Order)

Press the ▶️ button (playback mode) → MENU button (📖8) → 🖨️ Print order

If you configure print order settings in advance, you can use them with the printing methods listed below.

- Taking the memory card to a digital photo lab that supports DPOF (Digital Print Order Format) printing.
- Inserting the memory card into a DPOF-compatible printer’s card slot.
- Connecting the camera to a PictBridge-compatible printer (📷16).

- 1** Use the multi selector ▲▼ to select **Select images**, and press the Ⓞ button.

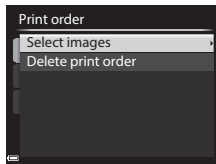

- 2** Select images (up to 99) and the number of copies (up to 9) of each.

- Use the multi selector ◀▶ or rotate it to select images, and use ▲▼ to specify the number of copies to be printed.
- Images selected for printing are indicated by the check mark icon and the numeral indicating the number of copies to be printed. If no copies have been specified for images, the selection is canceled.
- Move the zoom control toward **T** (📄) to switch to full-frame playback or **W** (🖼️) to switch to thumbnail playback.
- Press the Ⓞ button when setting is complete.



3 Select whether or not to print shooting date and shooting information.

- Select **Date** and press the **OK** button to print the shooting date on all images.
- Select **Info** and press the **OK** button to print the shutter speed and aperture value on all images.
- Lastly, select **Done** and press the **OK** button to complete the print order.

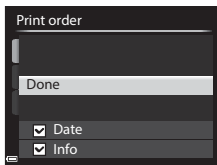

✓ **Notes About Printing Shooting Date and Shooting Information**

- Some printers may not be able to print the shooting date and shooting information.
- Shooting information is not printed when the camera is connected to a printer.
- The **Date** and **Info** settings are reset each time the **Print order** option is displayed.
- The date printed is that saved when the image was captured.
- For images taken with the **Print date** (🔗70) option enabled, only the date imprinted at the time of shooting are printed, even if the **Print order** date option is enabled for the images.

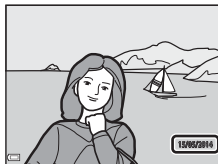

✓ **Notes About Print Order**

RAW (NRW) images cannot be set for print order. Create a JPEG image with **RAW (NRW) processing** (🔗12), and then set the JPEG image for print order.



📄 **Canceling Existing Print Order**

Select **Delete print order** in step 1 of print order (🔗52).

📄 **More Information**



See "Printing Images of Size 1:1" (🔗25) for more information.

Slide Show

Press the  button (playback mode) → MENU button (8) →  Slide show



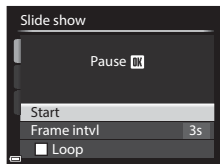

Play back images one by one in an automated “slide show.” When movie files (90) are played back in the slide show, only the first frame of each movie is displayed.

1 Use the multi selector ▲▼ to select **Start** and press the button.

- The slide show begins.
- To change the interval between images, select **Frame intvl**, press the  button, and specify the desired interval time before selecting **Start**.
- To repeat the slide show automatically, select **Loop** and press the  button before selecting **Start**.
- The maximum playback time is up to about 30 minutes even if **Loop** is enabled.





2 Select End or Restart.



- The screen shown on the right is displayed after the slide show ends or is paused. To exit the show, select  and then press the  button. To resume the slide show, select  and then press the  button.



Operations During Playback

- Use  to display the previous/next image. Press and hold to rewind/fast forward.
- Press the  button to pause or end the slide show.

Protect



Press the  button (playback mode) → MENU button () →  Protect

The camera protects selected images from accidental deletion.

Select images to protect or cancel protection for previously protected images from the image selection screen (85).



Note that formatting the camera's internal memory or the memory card (75) permanently deletes protected files.

Rotate Image

Press the  button (playback mode) → MENU button () →  Rotate image

Specify the orientation in which saved images are displayed during playback. Still images can be rotated 90 degrees clockwise or 90 degrees counterclockwise.

Images that were saved in the "tall" orientation can be rotated up to 180 degrees in either direction.

Select an image from the image selection screen (85). When the Rotate image screen is displayed, use the multi selector  or rotate it to rotate the image 90 degrees.

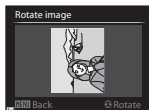

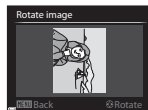

Rotate 90 degrees
counterclockwise



Rotate 90 degrees
clockwise





Press the  button to finalize display orientation, and save orientation information with the image.

Voice Memo

Press the  button (playback mode) → select an image → **MENU** button (8) →  Voice memo

Voice memos can be recorded and attached to images.



Recording Voice Memos

- Press and hold the  button to record (up to about 20 seconds).
- Do not touch the microphone.
- During recording, **REC** and  flash in the monitor.
- The voice memo playback screen is displayed after recording ends. Press the  button to play back the voice memo.
- Delete the current voice memo before recording a new voice memo.
-  is displayed for images with a voice memo when in full-frame playback mode.
- Press the multi selector  before or after recording a voice memo to return to the playback menu.







Playing Voice Memos

Select an image with  displayed before pressing the **MENU** button.

- Press the  button to play the voice memo. Press the button again to stop playback.
- Move the zoom control during playback to adjust playback volume.
- Press  before or after playing a voice memo to return to the playback menu.



Deleting Voice Memos

Press the  button on the voice memo playback screen. Use   to select **Yes** and press the  button.

- To delete a voice memo for a protected image, the **Protect** setting must first be disabled.

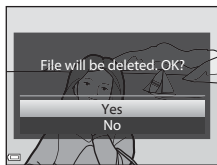



Copy (Copy Between Internal Memory and Memory Card)

Press the  button (playback mode) → MENU button () →  Copy

Copy images or movies between the internal memory and a memory card.

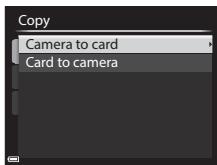
- 1 Use the multi selector ▲▼ to select a destination option to which images are copied and press the  button.



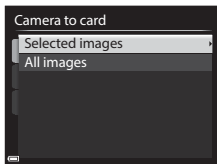

- 2 Select a copy option and press the  button.

- If you choose the **Selected images** option, use the image selection screen to specify images (85).



Notes About Copying Images

- Only files in formats that this camera can save can be copied.
- When images saved with an **Image quality** ()23) setting of **RAW (NRW) + Fine** or **RAW (NRW) + Normal** are selected, the RAW (NRW) and JPEG images are copied at the same time.
- Operation is not guaranteed with images captured with another make of camera or that have been modified on a computer.
- The **Print order** ()52) settings configured for images are not copied.



Notes About Copying Images in a Sequence

- If you select a key picture of a sequence in **Selected images**, all images in the sequence are copied.
- If you press the MENU button while images in a sequence are displayed, only the **Card to camera** copy option is available. All images in the sequence are copied if you select **Current sequence**.

Copying to a Memory Card That Contains No Images

When the camera is switched to playback mode, **Memory contains no images**. is displayed. Press the MENU button to select **Copy**.

Sequence Display Options



Press the  button (playback mode) → MENU button (8) →  Sequence display options

Select the method used to display images in the sequence (5).

Option	Description
Individual pictures	Displays each image in a sequence individually.  is displayed on the playback screen.
Key picture only (default setting)	Displays only the key picture for images in a sequence.

Settings are applied to all sequences, and the setting is saved in the camera's memory even if the camera is turned off.

Choose Key Picture

Press the  button (playback mode) → display a sequence for which you want to change the key picture → MENU button (8) →  Choose key picture

Specify a different image in the sequence as the key picture.

- When the key picture selection screen is displayed, select an image (85).

The Movie Menu

Movie Options









Enter shooting mode → MENU button →  (movie) tab () → Movie options

Select the desired movie option to record.

Select normal speed movie options to record at normal speed, or HS movie options () to record in slow or fast motion.

- Memory cards (Class 6 or higher) are recommended for recording movies ()21).

Normal Speed Movie Options

	Option (Image size/ Frame rate, File format) ^{1,2}	Image size	Aspect ratio (horizontal to vertical)
	1080/30p	1920 × 1080	16:9
	1080/25p (default setting)		
	1080/60i	1920 × 1080	16:9
	1080/50i		
	720/30p	1280 × 720	16:9
	720/25p		
	iFrame 720/30p ³ iFrame 720/25p ³	1280 × 720	16:9
	480/30p	640 × 480	4:3
	480/25p		

¹ The items and frame rate that can be set vary depending on the settings of **Frame rate** ()2).



²  **1080/60i** and  **1080/50i** use interlace system for recording, while other settings use progressive scanning system for recording.

³ iFrame is a format supported by Apple Inc. The movie editing functions cannot be used ()21).

HS Movie Options

Recorded movies are played back in fast or slow motion.

See “Playing Back in Slow Motion and Fast Motion” (6061) for more information.

Option	Image size Aspect ratio (horizontal to vertical)	Description
 HS 480/4x	640 × 480 4:3	1/4-speed slow motion movies • Max. recording time: 7 minutes 15 seconds (playback time: 29 minutes)
 HS 720/2x	1280 × 720 16:9	1/2-speed slow motion movies • Max. recording time: 14 minutes 30 seconds (playback time: 29 minutes)
 HS 1080/ 0.5x	1920 × 1080 16:9	2x speed fast motion movies • Max. recording time: 29 minutes (playback time: 14 minutes 30 seconds)



Notes About HS Movie

- Sound is not recorded.
- Zoom position, focus, exposure, and white balance are locked when movie recording starts.
- Some options for **Movie options** cannot be selected depending on the type of the effect selected in special effects.



Playing Back in Slow Motion and Fast Motion

When recording at normal speed:

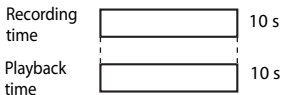

When recording at $\frac{480p}{120}$ / $\frac{480p}{100}$ HS 480/4x:

Movies are recorded at 4x normal speed.

They are played back in slow motion at 4x slower speed.

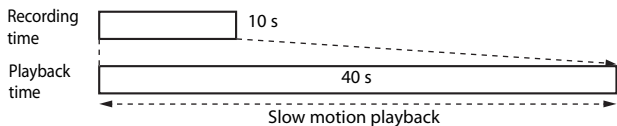

When recording at $\frac{1080p}{15}$ / $\frac{1080p}{25}$ HS 1080/0.5x:

Movies are recorded at 1/2 normal speed.

They are played back in fast motion at 2x faster speed.

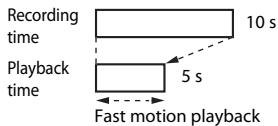

Autofocus Mode

Enter shooting mode → MENU button →  (movie) tab (📖9) → Autofocus mode

Set how the camera focuses when recording movies.

Option	Description
AF-S Single AF (default setting)	Focus is locked when movie recording starts. Select this option when the distance between the camera and the subject will remain fairly consistent.
AF-F Full-time AF	The camera focuses continuously. Select this option when the distance between the camera and subject will change significantly during recording. The sound of the camera focusing may be heard in the recorded movie. Use of Single AF is recommended to prevent the sound of the camera focusing from interfering with recording.



Notes About Autofocus Mode

- When an HS movie option is selected in **Movie options**, the setting is fixed at **Single AF**.
- The setting may not be changed when using certain settings of other functions.



Frame Rate

Enter shooting mode → MENU button →  (movie) tab (📖9) → Frame rate

Select the frame rate used when recording movies. The available frame rates for movies in **Movie options** (59) change depending on the setting of the frame rate.

- Movies recorded in **30 fps (30p/60i)** are suited for playback on an NTSC standard TV, and movies recorded in **25 fps (25p/50i)** are suited for playback on a PAL standard TV.

The Wi-Fi Options Menu

MENU button →  (Wi-Fi options) tab  9

Configure the Wi-Fi (wireless LAN) settings to connect the camera and a smart device.

Option	Description
Connect to smart device	When wirelessly connecting the camera and a smart device, select Connect to smart device . See “Using the Wi-Fi (Wireless LAN) Function”  94 for more information.
Options	SSID: Change the SSID. The SSID configured here is displayed on the smart device. Set a 1- to 24-character alphanumeric SSID. Auth./encryp.: Select whether or not to encrypt the communications between the camera and the connected smart device. Communications are not encrypted when Open (default setting) is selected. Password: Set an 8- to 16-character alphanumeric password. Channel: Select the channel used for wireless connections.
Current settings	Display the current settings.
Restore default settings	Restore the Wi-Fi settings to their default values.

Operating the Text Input Keyboard

- Use the multi selector ▲▼◀▶ or rotate it to select alphanumeric characters. Press the **OK** button to enter the selected character in the text field and move the cursor to the next space.
- To move the cursor in the text field, select ← or → on the keyboard, and press the **OK** button.
- To delete one character, press the **🗑** button.
- To apply the setting, select ↵ on the keyboard and press the **OK** button.

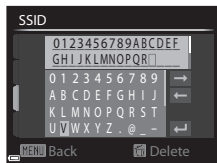

The Setup Menu

Welcome Screen

Press the **MENU** button → **Y** tab (📖9) → Welcome screen

Configure the welcome screen that is displayed when you turn on the camera.

Option	Description
None (default setting)	Does not display the welcome screen.
COOLPIX	Displays a welcome screen with the COOLPIX logo.
Select an image	Displays an image selected for the welcome screen. <ul style="list-style-type: none">• The image selection screen is displayed. Select an image (📖85) and press the OK button.• Because a copy of the selected image is saved in the camera, it will be displayed when the camera is turned on, even if the original image is deleted.• An image cannot be selected if its aspect ratio is different from that of the screen, or if the image size is extremely small after the small picture or crop function is applied.

Time Zone and Date

Press the **MENU** button → **Y** tab (📖9) → Time zone and date

Set the camera clock.

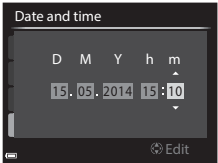
Option	Description
Date and time	<ul style="list-style-type: none">• Select an item: Press the multi selector ◀▶ (changes between D, M, Y, h, and m).• Edit the date and time: Press ▲▼. Date and time can also be changed by rotating the multi selector or command dial.• Apply the setting: Select the m setting and press the OK button or ▶. 
Date format	Select Year/Month/Day , Month/Day/Year , or Day/Month/Year .
Time zone	Set time zone and daylight saving time. <ul style="list-style-type: none">• When Travel destination (📍) is set after having set the home time zone (🏠), the time difference between the travel destination and the home time zone is automatically calculated, and the date and time are saved for the selected region.

Setting the Time Zone

- 1 Use the multi selector ▲▼ to select **Time zone** and press the **OK** button.

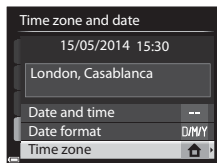

- 2 Select **Home time zone** or **Travel destination** and press the **OK** button.
 - The date and time displayed in the monitor changes depending on whether the home time zone or travel destination is selected.

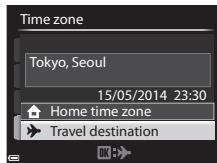

- 3 Press **▶**.

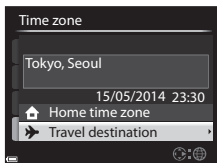

- 4 Use **◀▶** to select the time zone.
 - The time difference between home and the travel destination is displayed.
 - Press **▲** to enable daylight saving time function, and  is displayed. Press **▼** to disable the daylight saving time function.
 - Press the **OK** button to apply the time zone.
 - If the correct time is not displayed for the home or travel destination time zone setting, set the appropriate time in **Date and time**.

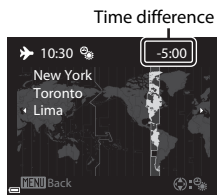

Monitor Settings

Press the MENU button → Y tab (📖9) → Monitor settings



Option	Description
Photo info	Set the information to be displayed in the monitor during shooting and playback.
Image review	On (default setting): The captured image is displayed in the monitor immediately after shooting and the monitor display returns to the shooting screen. Off : The captured image is not displayed immediately after shooting.
Brightness	Set the monitor brightness to one of 6 levels. • Default setting: 3
View/hide histograms	On : Displays a graph that shows the brightness distribution in the image (📖63). Off (default setting): Does not display a graph.





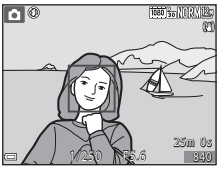

✓ Notes About View/Hide Histograms

Histograms are not displayed in the following situations.

- When recording a movie
- When the enlarged center of the image is displayed in **MF** (manual focus)
- When the flash mode, self-timer or focus mode menu is displayed

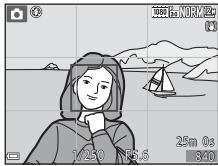
Photo Info

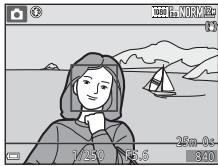
	Shooting mode	Playback mode
Show info	 A camera viewfinder showing a woman's portrait in the foreground and a sailboat on the water in the background. The top right corner displays '1000 F11 NORM 25'. The bottom right corner displays '25m 0s' and '890'. The bottom left corner displays '1/250' and '5.6'.	 A camera viewfinder showing the same scene as the shooting mode. The top right corner displays '4/132'. The bottom left corner displays '0004.JPG' and '16705206 1430'. The bottom right corner displays 'NORM 1/25'.
Auto info (default setting)	Current settings and operation guide are displayed as in Show info . If no operations are performed for a few seconds, the information is hidden as in Hide info . Information is displayed again when the next operation is performed.	

	Shooting mode	Playback mode
Hide info		
Framing grid+auto info	 <p>In addition to information shown with Auto info, a framing grid is displayed to help frame images.</p>	 <p>The current settings or operation guide is displayed as in Auto info.</p>
Movie frame+auto info	 <p>In addition to information shown with Auto info, a frame is displayed before recording begins that represents the area that will be captured when recording movies.</p>	 <p>The current settings or operation guide is displayed as in Auto info.</p>

✓ Notes About View/Hide Framing Grid

The framing grid is not displayed in the following situations.

- When the enlarged center of the image is displayed in **MF** (manual focus)

Print Date (Imprinting Date and Time on Images)

Press the MENU button → Y tab (📖9) → Print date

The shooting date and time can be imprinted on the images when shooting, allowing the information to be printed even from printers that do not support date printing (📷53).



Option	Description
DATE Date	Date is imprinted on images.
DATE Date and time	Date and time are imprinted on images.
OFF Off (default setting)	Date and time are not imprinted on images.

✓ Notes About Print Date



- Imprinted dates form a permanent part of image data and cannot be deleted. The date and time cannot be imprinted on images after they have been captured.
- The date and time cannot be imprinted in the following situations.
 - When the scene mode is set to **Easy panorama**
 - When **Image quality** (📷23) is set to **RAW (NRW)**, **RAW (NRW) + Fine** or **RAW (NRW) + Normal**
 - When **Pre-shooting cache**, **Continuous H: 120 fps** or **Continuous H: 60 fps** is selected for **Continuous** (📷35)
 - When recording movies
 - When saving still images during movie recording
- The imprinted date and time may be difficult to read when using a small image size.

Vibration Reduction

Press the **MENU** button → **Y** tab (📖9) → Vibration reduction

Set to reduce the effects of camera shake while shooting.

Set **Vibration reduction** to **Off** when using a tripod to stabilize the camera during shooting.

Option	Description
 Normal (default setting)	Compensates camera shake that commonly occurs when shooting at telephoto zoom positions or slow shutter speeds. The camera automatically detects the panning direction and only compensates for vibration caused by camera shake. When the camera is panned horizontally, for example, vibration reduction only reduces vertical shake. If the camera is panned vertically, vibration reduction only compensates for horizontal shake.
 Active	Camera shake is automatically compensated during shooting if a comparatively large camera shake is likely to occur when shooting from a car or under poor foothold conditions.
OFF Off	Vibration reduction is disabled.



Notes About Vibration Reduction

- After turning on the camera or after switching from playback mode to shooting mode, wait for the shooting mode screen to be displayed completely before taking images.
- Images displayed in the camera monitor immediately after shooting may be displayed blurry.
- Vibration reduction may be unable to completely eliminate the effects of camera shake in some situations.

Motion Detection

Press the MENU button → Y tab (📖9) → Motion detection

Enable motion detection to reduce the effects of subject movement and camera shake when shooting still images.

Option	Description
 Auto	Motion detection is enabled with some shooting modes or settings, when  is displayed on the shooting screen. When the camera detects subject movement or camera shake,  turns green, and the ISO sensitivity and shutter speed are automatically increased to reduce blurring.
Off (default setting)	Motion detection is disabled.

Notes About Motion Detection

- Motion detection may be unable to eliminate the effects of subject movement and camera shake in some situations.
- Motion detection may be disabled if the subject exhibits significant movement or is too dark.
- The images captured using motion detection may be somewhat “grainy” in appearance.

AF Assist

Press the MENU button → Y tab (📖9) → AF assist

Enable or disable the AF-assist illuminator which assists autofocus operation.

Option	Description
Auto (default setting)	The AF-assist illuminator automatically lights up when the subject is dimly lit. The illuminator has a range of about 4.5 m (14 ft) at the maximum wide-angle position and about 3.5 m (11 ft) at the maximum telephoto position. <ul style="list-style-type: none">• Note that for some scene modes or focus areas, the AF-assist illuminator may not light.
Off	The AF-assist illuminator does not light.

Digital Zoom

Press the MENU button → Y tab (📖9) → Digital zoom

Option	Description
On (default setting)	Digital zoom is enabled.
Off	Digital zoom is disabled.

✔ Notes About Digital Zoom

- Digital zoom cannot be used in the following scene modes.
 - **Scene auto selector, Portrait, Night portrait, Easy panorama, Pet portrait**
- Digital zoom cannot be used when using certain settings of other functions.
- When digital zoom is in effect, **Metering** (👁️34) is set to **Center-weighted** or **Spot** depending on the magnification of an enlargement.

Control Ring Options

Press the MENU button → Y tab (📖9) → Control ring options

Assign a function (📖69) to the control ring when the shooting mode is  (auto), **P**, **S**, **A**, **M** or **U**.

Sound Settings

Press the MENU button → Y tab (📖9) → Sound settings

Option	Description
Button sound	<p>When On (default setting) is selected, the camera produces one beep when operations are performed, two beeps when focus is acquired on the subject, and three beeps when an error occurs. The start-up sound is also produced.</p> <ul style="list-style-type: none">• Sounds are disabled when using Pet portrait scene mode.• The start-up sound is not produced when Welcome screen is set to None.
Shutter sound	<p>When On (default setting) is selected, the shutter sound is produced when the shutter is released.</p> <ul style="list-style-type: none">• The shutter sound is not produced when using continuous shooting mode, when recording movies, or when using Pet portrait scene mode.

Auto Off

Press the MENU button → Y tab (📖9) → Auto off

Set the amount of time that elapses before the camera enters standby mode (📖23).

You can select **30 s**, **1 min** (default setting), **5 min**, or **30 min**.



Notes About Auto Off

The time that passes before the camera enters standby mode is fixed in the following situations:

- When a menu is displayed: 3 minutes (when auto off is set to **30 s** or **1 min**)
- When the AC adapter is connected: 30 minutes

Format Memory/Format Card

Press the MENU button → Y tab (📖9) → Format memory/Format card

Use this option to format the internal memory or a memory card.

Formatting the internal memory or memory cards permanently deletes all data. Data that has been deleted cannot be recovered. Make sure to transfer important images to a computer before formatting.

- Do not turn the camera off or open the battery-chamber/memory card slot cover during formatting.

Formatting the Internal Memory

Remove the memory card from the camera. The

Format memory option is displayed in the setup menu.

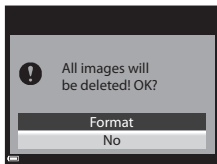

Formatting Memory Cards

Insert a memory card in the camera. The **Format card** option is displayed in the setup menu.

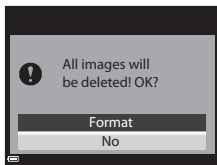

Language

Press the MENU button → Y tab (📖9) → Language

Select a language for display of camera menus and messages.

TV Settings

Press the **MENU** button → **Y** tab (📖9) → TV settings

Adjust settings for connection to a TV.

Option	Description
HDMI	Select a resolution for HDMI output. When Auto (default setting) is selected, the option best suited to the TV to which the camera is connected is automatically selected from 480p , 720p , or 1080i .
HDMI device control	When On (default setting) is selected, the HDMI-CEC-compatible TV's remote control can be used to control the camera during playback (👁15).



HDMI and HDMI-CEC

HDMI (High-Definition Multimedia Interface) is a multimedia interface.

HDMI-CEC (HDMI-Consumer Electronics Control) allows compatible devices to inter-operate.

Charge by Computer

Press the MENU button → Y tab (📖9) → Charge by computer

Option	Description
AUTO Auto (default setting)	When the camera is connected to a computer that is running (📖97), the battery inserted into the camera is automatically charged using power supplied by the computer.
Off	The battery inserted into the camera is not charged when the camera is connected to a computer.

✔ Notes About Charging with a Computer

- When connected to a computer, the camera automatically turns on and starts charging. If the camera is turned off, charging stops.
- About 3 hours and 30 minutes are required to charge a fully exhausted battery. Charging time increases when images are transferred while the battery is charging.
- The camera turns off automatically if there is no communication with the computer for 30 minutes after the battery has finished charging.

✔ When the Charge Lamp Quickly Flashes Green

Charging cannot be performed, possibly due to one of the reasons described below.

- The ambient temperature is not suited to charging. Charge the battery indoors with an ambient temperature of 5°C to 35°C (41°F to 95°F).
- The USB cable is not connected correctly, or the battery is faulty. Make sure the USB cable is connected correctly and replace the battery if necessary.
- The computer is in sleep mode and is not supplying power. Wake up the computer.
- The battery cannot be charged because the computer cannot supply power to the camera due to the computer's settings or its specifications.

Toggle Av/Tv Selection

Press the MENU button → Y tab (📖9) → Toggle Av/Tv selection

Switch the method for setting the flexible program, shutter speed or aperture value when shooting mode is set to **P, S, A, M** or **U**.

Option	Description
Do not toggle selection (default setting)	Use the command dial to set the flexible program or shutter speed, and the multi selector to set the aperture value.
Toggle selection	Use the multi selector to set the flexible program or shutter speed, and the command dial to set the aperture value.

Reset File Numbering

Press the MENU button → Y tab (📖9) → Reset file numbering

When **Yes** is selected, the sequential numbering of file numbers is reset (📷86). After resetting, a new folder is created and the file number for the next image taken starts with "0001."

✓ Notes About Reset File Numbering

Reset file numbering cannot be applied when the folder number reaches 999 and there are images in the folder. Insert a new memory card, or format the internal memory/memory card (📷75).

📎 Folders for Storing Files

Still images, movies and voice memos shot or recorded with this camera are saved in folders of the internal memory/memory card.

- Sequential numbers are added to folder names in ascending order, starting with "100" and ending with "999" (the folder names are not displayed on the camera).
- A new folder is created in the following situations.
 - When the number of files in a folder reaches 200
 - When a file in a folder is numbered "9999"
 - When **Reset file numbering** is performed
- A new folder is created each time a series of images are captured using interval timer shooting, and the images are saved in that folder with file numbers starting with "0001."

Blink Warning

Press the MENU button → Y tab (📖9) → Blink warning

Select whether or not the camera detects human subjects that have blinked using face detection (📖78) when shooting in the following modes:

- **Scene auto selector, Portrait** or **Night portrait** (when **Tripod** is selected) scene mode (📖36)
- When shooting mode is set to **P, S, A, M** or **U** (when **Face priority** (📖41) is selected for **AF area mode** option)

Option	Description
On	When one or more human subjects may have blinked in an image captured using face detection, the Did someone blink? screen is displayed in the monitor. Check the image and determine whether or not another image should be captured.
Off (default setting)	Blink warning is disabled.

The Blink Warning Screen

Faces detected by the blink warning are displayed inside a border.

The operations described below are available.

- To enlarge the face: Move the zoom control toward **T** (🔍). If more than one face is detected, use the multi selector ◀▶ to select the desired face.
- To switch to full-frame playback: Move the zoom control toward **W** (📐).

If you press the **OK** button, or if no operations are performed for a few seconds, the camera returns to shooting mode.





✓ Notes About Blink Warning

- The blink warning is disabled in the following situations.
 - When the smile timer is selected (📖58)
 - When an option other than **Single** (📖35) is selected for continuous shooting
 - When an option other than **Off** (📖40) is selected for exposure bracketing
 - When **On** (📖48) is selected for **Multiple exposure mode**
- The blink warning may not function properly in some shooting conditions.

Eye-Fi Upload

Press the MENU button → Y tab (📖9) → Eye-Fi upload





Option	Description
 Enable (default setting)	Upload images created by the camera to a preselected destination.
 Disable	Images are not uploaded.

✓ Notes About Eye-Fi Cards

- Note that images will not be uploaded if signal strength is insufficient even if **Enable** is selected.
- Remove your Eye-Fi card from the camera where wireless devices are prohibited. Signals may be transmitted even if **Disable** is selected.
- Refer to the instruction manual of your Eye-Fi card for more information. In the event of malfunction, contact the card manufacturer.
- The camera can be used to turn Eye-Fi cards on and off, but may not support other Eye-Fi functions.
- The camera is not compatible with the Endless Memory function. When it is set on a computer, disable the function. If the Endless Memory function is enabled, the number of images taken may not be displayed correctly.
- Eye-Fi cards are for use only in the country of purchase. Observe all local laws concerning wireless devices.
- Leaving the setting as **Enable** will result in the battery being depleted in a shorter period of time.

📌 Eye-Fi Communication Indicator

The communication status of the Eye-Fi card in the camera can be confirmed in the monitor (📖10).

- : **Eye-Fi upload** is set to **Disable**.
-  (lights): Eye-Fi upload enabled; waiting to begin upload.
-  (flashes): Eye-Fi upload enabled; uploading data.
- : Eye-Fi upload enabled but no images available for upload.
- : An error occurred. The camera cannot control the Eye-Fi card.

Peaking

Press the **MENU** button → **Y** tab (📖9) → Peaking

Option	Description
On (default setting)	When operating manual focus, focusing is assisted by highlighting areas that are in focus in white on the image displayed in the monitor (📖61, 62).
Off	Peaking is disabled.

Reset All

Press the **MENU** button → **Y** tab (📖9) → Reset all

When **Reset** is selected, the camera's settings are restored to their default values.

- Some settings, such as **Time zone and date** or **Language**, are not reset.
- User settings that were saved in **U** of the mode dial are not reset. To reset these settings, use **Reset user settings** (📖52).



Resetting File Numbering

To reset file numbering to "0001", delete all images saved in the internal memory or on the memory card before selecting **Reset all**. **Reset file numbering** can also be used to reset to "0001" (📖78).



Firmware Version







Press the **MENU** button → **Y** tab (📖9) → Firmware version







View the current camera firmware version.









Error Messages

Refer to the table below if an error message is displayed.

Display	Cause/Solution	
Battery temperature is elevated. The camera will turn off.	The camera turns off automatically. Wait until the battery has cooled before resuming use.	–
The camera will turn off to prevent overheating.	The inside of the camera has become hot. The camera turns off automatically. Wait until the camera has cooled before resuming use.	–
Memory card is write protected.	The write-protect switch is in the “lock” position. Slide the write-protect switch to the “write” position.	–
This card cannot be used.	An error occurred while accessing the memory card.	
This card cannot be read.	<ul style="list-style-type: none"> • Use an approved card. • Check that the terminals are clean. • Confirm that the memory card is correctly inserted. 	21 20 20
Card is not formatted. Format card?	The memory card has not been formatted for use in the camera. Formatting deletes all data saved on the memory card. If you need to keep copies of any images, make sure to select No and save the copies to a computer or other medium before formatting the memory card. Select Yes and press the  button to format the memory card.	20,  5
Not available if Eye-Fi card is locked.	The write-protect switch of the Eye-Fi card is in the “lock” position.	–
	An error occurred while accessing the Eye-Fi card. <ul style="list-style-type: none"> • Check that the terminals are clean. • Confirm that the Eye-Fi card is correctly inserted. 	20 20
Out of memory.	Delete images or insert a new memory card.	33, 91, 20

Display	Cause/Solution	
Image cannot be saved.	An error occurred while saving the image. Insert a new memory card or format the internal memory or memory card.	20,  75
	The camera has run out of file numbers. Insert a new memory card or format the internal memory or memory card.	
	The image cannot be used for the welcome screen.	 65
	There is insufficient space to save the copy. Delete images from the destination.	33, 91
Sound file cannot be saved.	A voice memo cannot be attached to this image. <ul style="list-style-type: none"> Voice memos cannot be attached to movies. Select an image captured with this camera. 	–  56
Image cannot be modified.	<ul style="list-style-type: none"> Select images that support the editing function. Images captured with cameras other than this camera cannot be edited. 	 7 –
Cannot record movie.	A time-out error occurred while saving the movie on the memory card. Select a memory card with a faster write speed.	21
Cannot reset file numbering.	File numbering cannot be reset because the sequential number of a folder has reached the upper limit. Insert a new memory card or format the internal memory or memory card.	20,  75
Memory contains no images.	There are no images in the internal memory or on the memory card. <ul style="list-style-type: none"> Remove the memory card from the camera to play back images in the camera's internal memory. To copy the images saved in the camera's internal memory to the memory card, press the MENU button to select Copy in the playback menu. 	20  57
File contains no image data.	The file was not created or edited with this camera.	
This file cannot be played back.	The file cannot be viewed on this camera. View the file using a computer or the device used to create or edit this file.	–

Display	Cause/Solution	
All images are hidden.	<ul style="list-style-type: none"> There are no images available for a slide show, etc. There are no images that can be displayed on the image selection screen for deletion. 	-
This image cannot be deleted.	The image is protected. Disable protection.	 55
Raise the flash.	<ul style="list-style-type: none"> When the scene mode is Scene auto selector, you can take an image even if the flash is lowered but the flash will not fire. When the scene mode is Night portrait or Backlighting with HDR set to Off, you must raise the flash to take an image. 	37 39, 41
No access.	The camera could not receive the communication signal from the smart device. Select Connect to smart device in the Wi-Fi options menu, and wirelessly connect the camera and smart device again.	95,  63
Could not connect.	The camera failed to establish the connection while receiving the communication signals from the smart device. Select a different channel for Channel in Options in the Wi-Fi options menu and establish the wireless connection again.	95,  63
Wi-Fi connection terminated.	A cable was connected to the camera while the camera and smart device were wirelessly connected, the battery level became low, or the connection was aborted due to poor connectivity. Check the status of the camera and establish the wireless connection again.	95,  63
Lens error	A lens error occurred. Turn the camera off and then on again. If the error persists, contact your retailer or Nikon-authorized service representative.	22
Communications error	An error occurred while communicating with the printer. Turn the camera off and reconnect the USB cable.	 16
System error	An error occurred in the camera's internal circuitry. Turn the camera off, remove and reinsert the battery, and turn the camera on. If the error persists, contact your retailer or Nikon-authorized service representative.	22

Display	Cause/Solution	
Printer error: check printer status.	After solving the problem, select Resume and press the  button to resume printing.*	–
Printer error: check paper.	Load the specified size of paper, select Resume , and press the  button to resume printing.*	–
Printer error: paper jam.	Remove the jammed paper, select Resume , and press the  button to resume printing.*	–
Printer error: out of paper.	Load the specified size of paper, select Resume , and press the  button to resume printing.*	–
Printer error: check ink.	There is a problem with the printer's ink. Check the ink, select Resume , and press the  button to resume printing.*	–
Printer error: out of ink.	Replace the ink cartridge, select Resume , and press the  button to resume printing.*	–
Printer error: file corrupt.	There is a problem with the image file to be printed. Select Cancel and press the  button to cancel printing.	–

* See the documentation provided with your printer for further guidance and information.

File Names

Images, movies, or voice memos are assigned file names as follows.

File name: DSCN0001.JPG

(1) (2) (3)

(1) Identifier	Not shown on camera monitor.	
	DSCN	Original still images, movies, still images extracted from movies
	SSCN	Small picture copies
	RSCN	Cropped copies
	FSCN	Images created by an image editing function other than crop and small picture, movies created by the movie editing function
(2) File number	Assigned automatically in ascending order, starting with "0001" and ending up with "9999." <ul style="list-style-type: none">• When a file number reaches "9999," a new folder is created and the next file number returns to "0001."• A new folder is created each time a series of images are captured using interval timer shooting, and the images are saved in that folder with file numbers starting with "0001."	
(3) Extension	Indicates file format.	
	.JPG	JPEG still images
	.NRW	RAW still images
	.MOV	Movies
	.WAV	Voice memos <ul style="list-style-type: none">• Identifier and file number are the same as the image to which the voice memo is attached.

Notes

- When images are shot with an **Image quality** (📷23) setting of **RAW (NRW) + Fine** or **RAW (NRW) + Normal**, the RAW (NRW) and JPEG images that are saved at the same time are assigned the same identifier and file number. The pair of images is saved in the same folder and is counted as one file.

Optional Accessories

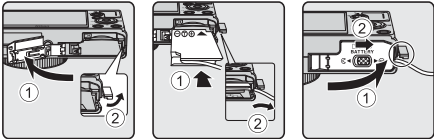
Battery charger	Battery Charger MH-65 (Charging time when no charge remains: Approx. 2 hours and 30 minutes)
AC adapter	<p>AC Adapter EH-62F (connect as shown)</p> <p>1 2 3</p>  <p>Before closing the battery-chamber/memory card slot cover, fully insert the power connector cord into the slot in the battery chamber. If part of the cord runs out of the groove, the cover or cord may be damaged when the cover is closed.</p>

Availability may vary with country or region.
See our website or brochures for the latest information.



A series of horizontal dashed lines spanning the width of the page, intended for handwriting practice.



Technical Notes and Index

Caring for the Products	2
The Camera.....	2
The Battery.....	3
Charging AC Adapter.....	4
Memory Cards.....	5
Caring for the Camera	6
Cleaning.....	6
Storage	7
Troubleshooting	8
Specifications.....	16
Index.....	22

Caring for the Products

The Camera

To ensure continued enjoyment of this Nikon product, observe the precautions described below in addition to the warnings in "For Your Safety" (📖vii-ix) when using or storing the device.

✔ Do Not Drop

The product may malfunction if subjected to strong shock or vibration.

✔ Handle the Lens and All Moving Parts with Care

Do not apply force to the lens, lens cover, monitor, memory card slot, or battery chamber. These parts are easily damaged. Applying force to the lens cover could result in camera malfunction or damage to the lens. Should the monitor break, care should be taken to avoid injury caused by broken glass and to prevent the liquid crystal from the display touching the skin or entering the eyes or mouth.

✔ Keep Dry

The device will be damaged if immersed in water or subjected to high humidity.

✔ Avoid Sudden Changes in Temperature

Sudden changes in temperature, such as when entering or leaving a heated building on a cold day, can cause condensation to form inside the device. To prevent condensation, place the device in a carrying case or a plastic bag before exposing it to sudden changes in temperature.

✔ Keep away from Strong Magnetic Fields

Do not use or store this device in the vicinity of equipment that generates strong electromagnetic radiation or magnetic fields. Strong static charge or the magnetic fields produced by equipment such as radio transmitters could interfere with the monitor, damage data saved on the memory card, or affect the product's internal circuitry.

✔ Do Not Point the Lens at Strong Light Sources for Extended Periods

Avoid pointing the lens at the sun or other strong light sources for extended periods when using or storing the camera. Intense light may cause deterioration of the image sensor, producing a white blur effect in photographs.

Turn the Product off Before Removing or Disconnecting the Power Source or the Memory Card

Do not remove the battery while the product is on, or while images are being saved or deleted. Forcibly cutting power in these circumstances could result in loss of data or in damage to product memory or internal circuitry.

Notes About the Monitor

- Monitors and electronic viewfinders are constructed with extremely high precision; at least 99.99% of pixels are effective, with no more than 0.01% being missing or defective. Hence while these displays may contain pixels that are always lit (white, red, blue, or green) or always off (black), this is not a malfunction and has no effect on images recorded with the device.
- Images in the monitor may be difficult to see under bright lighting.
- The monitor is lit by an LED backlight. Should the monitor begin to dim or flicker, contact your Nikon-authorized service representative.

The Battery

- Be sure to read and follow the warnings in “For Your Safety” (vii-ix) before use.
- Check the battery level before using the camera and replace or charge the battery if necessary. Do not continue charging once the battery is fully charged as this will result in reduced battery performance. Whenever possible, carry a fully charged spare battery when taking images on important occasions.
- Do not use the battery at ambient temperatures below 0°C (32°F) or above 40°C (104°F).
- Charge the battery indoors with an ambient temperature of 5°C to 35°C (41°F to 95°F) before use.
- When the battery temperature is between 0°C and 10°C (32°F to 50°F) or 45°C to 60°C (113°F to 140°F), the chargeable capacity may decrease.
- The battery is not charged at ambient temperatures below 0°C (32°F) or above 60°C (140°F).
- Note that the battery may become hot during use; wait for the battery to cool before charging. Failure to observe these precautions could damage the battery, impair its performance, or prevent it from charging normally.
- On cold days, the capacity of batteries tends to decrease. If an exhausted battery is used at a low temperature, the camera will not turn on. Be sure that the battery is fully charged before heading outside to take images in cold weather. Keep spare batteries in a warm place and exchange as necessary. Once warmed, a cold battery may recover some of its charge.
- Dirt on the battery terminals can prevent the camera from functioning. Should the battery terminals become dirty, wipe them off with a clean, dry cloth before use.

- If the battery will not be used for some time, insert it in the camera and completely exhaust it before removing it for storage. The battery should be stored in a cool location with an ambient temperature of 15°C to 25°C (59°F to 77°F). Do not store the battery in hot or extremely cold locations.
- Always remove the battery from the camera or optional battery charger when it is not being used. When inserted, minute amounts of current are drawn from the battery even when not in use. This may result in excessive draining of the battery and complete loss of function. Turning the camera on or off while the battery is exhausted can result in reduced battery life.
- Recharge the battery at least once every six months and completely exhaust it before returning it to storage.
- After removing the battery from the camera or optional battery charger, put the battery in a plastic bag, etc. to insulate it and store it in a cool place.
- A marked drop in the time a fully-charged battery retains its charge, when used at room temperature, indicates that the battery needs to be replaced. Purchase a new EN-EL12 battery.
- Replace the battery when it no longer holds a charge. Used batteries are a valuable resource. Please recycle used batteries in accordance with local regulations.

Charging AC Adapter

Be sure to read and follow the warnings in “For Your Safety” (📖vii-ix) before use.

- The Charging AC Adapter EH-71P is for use only with compatible devices. Do not use with another make or model of device.
- Do not use a USB cable other than the UC-E21. Using a USB cable other than the UC-E21 could result in overheating, fire or electric shock.
- Do not, under any circumstances, use another make or model of AC adapter other than Charging AC Adapter EH-71P, and do not use a commercially available USB-AC adapter or a battery charger for a mobile phone. Failure to observe this precaution could result in overheating or in damage to the camera.
- The EH-71P is compatible with AC 100 V-240 V, 50/60 Hz electrical outlets. When using in other countries, use a plug adapter (available commercially) as necessary. For more information about plug adapters, consult your travel agency.

Memory Cards

- Use only Secure Digital memory cards. See “Approved Memory Cards” (📖21) for recommended memory cards.
- Observe the precautions noted in the documentation included with your memory card.
- Do not affix labels or stickers to the memory card.
- Do not format the memory card using a computer.
- The first time you insert a memory card that has been used in another device into this camera, be sure to format it with this camera. We recommend formatting new memory cards with this camera before using them with this camera.
- Note that **formatting a memory card permanently deletes all images and other data on the memory card.** If there is data saved on the memory card that you wish to keep, copy that data to a computer before formatting.
- If the message **Card is not formatted. Format card?** is displayed when the camera is turned on, the memory card must be formatted. If there is data on the memory card that you do not want to delete, select **No** and press the  button. Copy that data to a computer before formatting. To format the memory card, select **Yes**.
- Observe the following precautions while formatting the memory card, saving and deleting images, and copying images to a computer, otherwise data or the memory card itself may be damaged.
 - Do not open the battery-chamber/memory card slot cover or remove the memory card or battery.
 - Do not turn off the camera.
 - Do not disconnect the AC adapter.

Caring for the Camera

Cleaning

Lens	Avoid touching glass parts with your fingers. Remove dust or lint with a blower (typically a small device with a rubber bulb attached to one end that is pumped to produce a stream of air out the other end). To remove fingerprints or other stains that cannot be removed with a blower, wipe the lens with a soft cloth, using a spiral motion that starts at the center of them and working toward the edges. If this fails, clean the lens using a cloth lightly dampened with commercial lens cleaner.
Monitor	Remove dust or lint with a blower. To remove fingerprints and other stains, clean the monitor with a soft, dry cloth, being careful not to apply pressure.
Body	Use a blower to remove dust, dirt, or sand, then wipe gently with a soft, dry cloth. After using the camera at the beach or other sandy or dusty environment, wipe off any sand, dust, or salt with a dry cloth lightly dampened with fresh water and dry thoroughly. Note that foreign matter inside the camera could cause damage not covered by the warranty.

Do not use volatile organic solvents such as alcohol or thinner, chemical detergents, anticorrosive agents, or anti-fogging agents.

Storage

Turn the camera off when not in use. Be sure that the power-on lamp is off before putting the camera away. Remove the battery if the camera will not be used for an extended period. Do not store the camera with naphtha or camphor moth balls, or in any of the following locations:

- Next to equipment that produces strong electromagnetic fields, such as televisions or radios
- Exposed to temperatures below -10°C (14°F) or above 50°C (122°F)
- Places that are poorly ventilated or subject to humidity of over 60%





To prevent mold or mildew, take the camera out of storage at least once a month. Turn the camera on and release the shutter a few times before putting the camera away again.















For storing the battery, follow the precautions in "The Battery" (🔋:3) in "Caring for the Products" (🔧:2).



Troubleshooting

If the camera fails to function as expected, check the list of common problems below before consulting your retailer or Nikon-authorized service representative.



Power, Display, Settings Issues







Problem	Cause/Solution	
The camera is on but does not respond.	<ul style="list-style-type: none"> • Wait for recording to end. • If the problem persists, turn the camera off. If the camera does not turn off, remove and reinsert the battery or batteries or, if you are using an AC adapter, disconnect and reconnect the AC adapter. Note that although any data currently being recorded will be lost, data that have already been recorded will not be affected by removing or disconnecting the power source. 	- 22,  87
Battery inserted in the camera cannot be charged.	<ul style="list-style-type: none"> • Confirm all connections. • When connected to a computer, the camera may not charge for any of the reasons described below. <ul style="list-style-type: none"> - Off is selected for Charge by computer in the setup menu. - Battery charging stops if the camera is turned off. - Battery charging is not possible if the camera's display language and date and time have not been set, or the date and time were reset after the camera's clock battery was exhausted. Use the charging AC adapter to charge the battery. - Battery charging may stop if the computer is in sleep mode. - Depending upon the computer specifications, settings, and status, battery charging may not be possible. 	18  77 - 24, 25 - -
Camera cannot be turned on.	<ul style="list-style-type: none"> • The battery is exhausted. • When the charging AC adapter is connected, the camera cannot be turned on even if the power switch is pressed. The camera turns on in playback mode by pressing and holding down the  (playback) button, but shooting is not possible. 	22 18











Problem	Cause/Solution	
Camera turns off without warning.	<ul style="list-style-type: none"> The camera automatically turns off to save power (auto off function). The camera or battery has become too cold and cannot operate properly. The inside of the camera has become hot. Leave the camera off until the inside of the camera has cooled, and then try turning it on again. 	23  3 –
The monitor is blank.	<ul style="list-style-type: none"> The camera is off. The battery is exhausted. The camera has entered standby mode to save power. Press the power switch, shutter-release button,  button or  ( movie-record) button, or rotate the mode dial. The flash lamp flashes while the flash is charging. Wait for the flash to charge. The camera and computer are connected via a USB cable. The camera and TV are connected via an HDMI cable. Interval timer shooting in progress. Wi-Fi is connected. 	22 22 23 54 97, 101 97,  15  37 95,  63
Monitor is hard to see.	<ul style="list-style-type: none"> Adjust the monitor brightness. The monitor is dirty. Clean the monitor. 	92,  68  6
Date and time of recording are not correct.	<ul style="list-style-type: none"> If the camera clock has not been set, the “Date not set” indicator flashes during shooting and movie recording. Images and movies saved before the clock is set are dated “00/00/0000 00:00” or “01/01/2014 00:00” respectively. Set the correct time and date from the Time zone and date option in the setup menu. The camera clock is not as accurate as ordinary watches or clocks. Periodically compare the time of the camera clock with that of a more accurate timepiece and reset as required. 	24, 92,  66 92,  66
No information displayed in monitor.	Hide info is selected for Photo info of Monitor settings in the setup menu.	92,  68
Print date not available.	Time zone and date has not been set in the setup menu.	24, 92,  66











Problem	Cause/Solution	
Date not imprinted on images even when Print date is enabled.	<ul style="list-style-type: none"> The current shooting mode does not support Print date. A function that restricts the Print date function is enabled. The date cannot be imprinted on movies. 	92,  70 76 –
Screen for setting time zone and date is displayed when camera is turned on.	The clock battery is exhausted; all settings were restored to their default values.	24, 25
Camera settings reset.		
Reset file numbering cannot be done.	Although a new folder is created in the internal memory or on the memory card by resetting file numbering, etc., if the sequential number of a folder name (which is not displayed on the camera) reaches the upper limit ("999"), reset is not possible. Change the memory card, or format the internal memory/memory card.	93,  78
Camera becomes hot.	The camera may become hot when used for an extended period of time to shoot movies or send images using an Eye-Fi card, or when used in a hot environment; this is not a malfunction.	–
Camera makes sound.	When Autofocus mode is set to Full-time AF or while in some shooting modes, the camera may produce an audible focusing sound.	67, 90

Shooting Issues







Problem	Cause/Solution	
Cannot switch to shooting mode.	<ul style="list-style-type: none"> Disconnect the HDMI cable or USB cable. When the camera is connected to the electrical outlet using the charging AC adapter, the camera cannot switch to shooting mode. 	97, 101,  15,  16 19





Problem	Cause/Solution	
No image captured when the shutter-release button is pressed.	<ul style="list-style-type: none"> • When the camera is in playback mode, press the  button, shutter-release button or  (movie-record) button. • When menus are displayed, press the MENU button. • The battery is exhausted. • When the scene mode is Night portrait or Backlighting with HDR set to Off, raise the flash. • When the flash lamp is flashing, the flash is charging. 	32 8 22 39, 41, 54 54
Camera cannot focus.	<ul style="list-style-type: none"> • The subject is too close. Try shooting using the Scene auto selector or Close-up scene mode, or the macro close-up focus mode. • Incorrect focus mode setting. Check or change the setting. • The subject is hard to focus on. • Set AF assist in the setup menu to Auto. • Subject is not in focus area when the shutter-release button is pressed halfway. • The focus mode is set to MF (manual focus). • Turn the camera off and then on again. 	37, 40, 59, 60 59, 60 79 92,  72 30, 67 59, 61 22
Colored stripes appear in the monitor when shooting.	Colored stripes may appear when shooting subjects with repeating patterns (such as window blinds); this is not a malfunction. The colored stripes will not appear in captured images or recorded movies. However, when using Continuous H: 120 fps or HS 480/4x , the colored stripes may be seen in the captured images and recorded movies.	-
Images are blurred.	<ul style="list-style-type: none"> • Use the flash. • Enable vibration reduction or motion detection. • Use BSS (Best Shot Selector) of Continuous in the shooting menu. • Use a tripod to stabilize the camera when shooting (using the self-timer at the same time is more effective). 	54 92,  71,  72 67 57
Bright specks appear in images captured with flash.	Flash is reflecting off particles in air. Lower the flash, and set the flash mode to  (off).	54
Flash does not fire.	<ul style="list-style-type: none"> • A shooting mode where the flash cannot fire is selected. • A function that restricts the flash is enabled. 	64 72

Problem	Cause/Solution	
Digital zoom cannot be used.	<ul style="list-style-type: none"> A function that restricts digital zoom is enabled. Digital zoom is set to Off in the setup menu. Digital zoom cannot be used in the following scene modes. <ul style="list-style-type: none"> - Scene auto selector, Portrait, Night portrait, Easy panorama, Pet portrait 	72 92,  73 72 36
Image size not available.	<ul style="list-style-type: none"> A function that restricts the Image size option is enabled. When the scene mode is set to Easy panorama, the image size is fixed. 	72 42
No sound when shutter is released.	Off is selected for Sound settings > Shutter sound in the setup menu. No sound is produced with some shooting modes and settings, even when On is selected.	76, 92,  74
AF-assist illuminator does not light.	Off is selected for the AF assist option in the setup menu. AF-assist illuminator may not light depending on the position of the focus area or the current scene mode, even when Auto is selected.	92,  72
Images appear smeared.	The lens is dirty. Clean the lens.	 6
Colors are unnatural.	White balance is not adjusted properly.	66,  31
Randomly spaced bright pixels ("noise") appear in image.	The subject is dark, and the shutter speed is too slow or ISO sensitivity is too high. Noise can be reduced by: <ul style="list-style-type: none"> Using the flash. Specifying a lower ISO sensitivity setting. 	54 67,  39
Images are too dark (underexposed).	<ul style="list-style-type: none"> The flash window is blocked. The subject is beyond the range of the flash. Adjust exposure compensation. Increase ISO sensitivity. The subject is backlit. Raise the flash or select the scene mode Backlighting and try taking an image again. On is selected for Built-in ND filter in the shooting menu. 	28  17 63 67,  39 41, 54 67
Images are too bright (overexposed).	<ul style="list-style-type: none"> Adjust exposure compensation. Use the Built-in ND filter setting in the shooting menu. 	63 67,  46

Problem	Cause/Solution	
Unexpected results when flash set to  (auto with red-eye reduction).	When taking images with  (auto with red-eye reduction) or fill flash with red-eye reduction in Night portrait scene mode, In-Camera Red-Eye Fix may be applied to areas not affected by red-eye in rare cases. Use any scene mode other than Night portrait , and change the flash mode to any setting other than  (auto with red-eye reduction) and try taking an image again.	39, 54
Skin tones are not softened.	<ul style="list-style-type: none"> • In some shooting conditions, facial skin tones may not be softened. • For images containing 4 or more faces, try using Skin softening in the playback menu. 	79 83,  9
Saving images takes time.	It may take more time to save images in the following situations. <ul style="list-style-type: none"> • When the noise reduction function is in operation • When the flash mode is set to  (auto with red-eye reduction) • When taking images in the following scene modes. <ul style="list-style-type: none"> - Hand-held in Night landscape - Noise reduction burst in Landscape or Close-up - HDR is set to any setting other than Off in Backlighting - Easy panorama • Continuous in the shooting menu is set to Continuous H: 120 fps or Continuous H: 60 fps • When using smile timer while shooting • When using Active D-Lighting while shooting • When using multiple exposure while shooting • When Image quality is set to RAW (NRW), RAW (NRW) + Fine or RAW (NRW) + Normal. 	- 55 39 38, 40 41 42 67,  35 58 67,  47 68,  48  23
A ring-shaped belt or rainbow-colored stripe appears in the monitor or images.	When shooting with backlighting or when a very strong light source (such as sunlight) is in the frame, a ring-shaped belt or rainbow-colored stripe (ghosting) may occur. Change the position of the light source, or frame the image so that the light source does not enter the frame, and try again.	-
Cannot select a setting/Selected setting is disabled.	<ul style="list-style-type: none"> • Certain menu items are unavailable depending on the shooting mode. Menu items that cannot be selected are displayed in gray. • A function that restricts the selected function is enabled. 	8 -

Playback Issues

Problem	Cause/Solution	
File cannot be played back.	<ul style="list-style-type: none"> • This camera may not be able to play back images saved with another make or model of digital camera. • This camera cannot play back RAW (NRW) images or movies captured or recorded with another make or model of digital camera. • This camera may not be able to play back data edited on a computer. • Files cannot be played back during interval timer shooting. 	<p>–</p> <p>–</p> <p>–</p> <p>67, 37</p>
Cannot zoom in on image.	<ul style="list-style-type: none"> • Playback zoom cannot be used with movies. • When zooming in on a small-sized image, the zoom ratio shown on the screen may differ from the actual zoom ratio of the image. • This camera may not be able to zoom in on images captured with another make or model of digital camera. 	<p>–</p> <p>–</p> <p>–</p>
Cannot record voice memo.	<ul style="list-style-type: none"> • Voice memos cannot be attached to movies. • Voice memos cannot be attached to images captured with other cameras. Voice memos attached to images using another camera cannot be played back on this camera. 	<p>–</p> <p>83, 56</p>
Cannot edit image.	<ul style="list-style-type: none"> • Some images cannot be edited. Images that have already been edited may not be edited again. • There is not enough free space in the internal memory or on the memory card. • This camera is unable to edit images captured with other cameras. • Editing functions used for images are not available for movies. 	<p>42, 7</p> <p>–</p> <p>85, 7</p> <p>–</p>
Images are not displayed on TV.	<ul style="list-style-type: none"> • HDMI is not correctly set in the TV settings setup menu. • The memory card contains no images. Replace the memory card. Remove the memory card to play back images from the internal memory. 	<p>93, 76</p> <p>20</p>
Nikon Transfer 2 does not start when camera is connected to a computer.	<ul style="list-style-type: none"> • The camera is off. • The battery is exhausted. • The USB cable is not correctly connected. • The camera is not recognized by the computer. • The computer is not set to start Nikon Transfer 2 automatically. For more information about Nikon Transfer 2, refer to help information contained in ViewNX 2. 	<p>22</p> <p>22</p> <p>97, 101</p> <p>–</p> <p>101</p>

Problem	Cause/Solution	
The PictBridge screen is not displayed when the camera is connected to a printer.	With some PictBridge-compatible printers, the PictBridge screen may not be displayed and it may be impossible to print images when Auto is selected for the Charge by computer option. Set the Charge by computer option to Off and reconnect the camera to the printer.	93,  77
Images to be printed are not displayed.	<ul style="list-style-type: none"> The memory card contains no images. Replace the memory card. Remove the memory card to print images from the internal memory. 	20 21
Cannot select paper size with camera.	<p>The camera cannot be used to select the paper size in the following situations, even when printing from a PictBridge-compatible printer. Use the printer to select the paper size.</p> <ul style="list-style-type: none"> The printer does not support the paper sizes specified by the camera. The printer automatically selects the paper size. 	 17,  19 –

Wi-Fi

Problem	Cause/Solution	
SSID (network name) is not displayed on the smart device.	<p>Select Connect to smart device in the Wi-Fi options menu on the camera to enter connection standby mode.</p> <p>Turn off the Wi-Fi function of the smart device and then turn it on again.</p>	95

Specifications

Nikon COOLPIX P340 Digital Camera

Type	Compact digital camera
Number of effective pixels	12.2 million
Image sensor	1/1.7-in. type CMOS; approx. 12.76 million total pixels
Lens	NIKKOR lens with 5x optical zoom
Focal length	5.1-25.5 mm (angle of view equivalent to that of 24-120 mm lens in 35mm [135] format)
f/-number	f/1.8-5.6
Construction	7 elements in 6 groups
Digital zoom magnification	Up to 4x (angle of view equivalent to that of approx. 480 mm lens in 35mm [135] format)
Vibration reduction	Lens shift
Motion blur reduction	Motion detection (still pictures)
Autofocus (AF)	Contrast-detect AF
Focus range	<ul style="list-style-type: none">• [W]: Approx. 30 cm (1 ft) - ∞, [T]: Approx. 50 cm (1 ft 8 in.) - ∞• Macro close-up mode: Approx. 2 cm (0.8 in.) (at a wide-angle zoom position) - ∞ (All distances measured from center of front surface of lens)
Focus-area selection	Target finding AF, face priority, manual (spot), manual (normal), manual (wide), subject tracking
Monitor	7.5 cm (3-in.), approx. 921k-dot (RGBW), wide viewing angle TFT LCD with anti-reflection coating and 6-level brightness adjustment
Frame coverage (shooting mode)	Approx. 100% horizontal and 100% vertical (compared to actual picture)
Frame coverage (playback mode)	Approx. 100% horizontal and 100% vertical (compared to actual picture)
Storage	
Media	Internal memory (approx. 56 MB) SD/SDHC/SDXC memory card
File system	DCF, Exif 2.3 and DPOF compliant
File formats	Still pictures: JPEG, RAW (NRW) (Nikon's own format) Sound files (voice memo): WAV Movies: MOV (Video: H.264/MPEG-4 AVC, Audio: LPCM stereo)

Image size (pixels)	<ul style="list-style-type: none"> • 12 M 4000×3000 • 8 M 3264×2448 • 4 M 2272×1704 • 2 M 1600×1200 • VGA 640×480 • 16:9 9M 3968×2232 • 16:9 2M 1920×1080 • 3:2 3984×2656 • 1:1 3000×3000
ISO sensitivity (Standard output sensitivity)	<ul style="list-style-type: none"> • ISO 80 to 3200 • ISO 6400, Hi 1 (equivalent to ISO 12800) (available when using P, S, A or M mode) • Hi 2 (equivalent to ISO 25600) (available when using High ISO monochrome in special effects mode)
Exposure	
Metering mode	Matrix, center-weighted, or spot
Exposure control	Programmed auto exposure with flexible program, shutter-priority auto, aperture-priority auto, manual, exposure bracketing enabled, exposure compensation (-2.0 EV - +2.0 EV in steps of 1/3 EV) enabled
Shutter	Mechanical and CMOS electronic shutter
Speed	<ul style="list-style-type: none"> • 1/2000 - 1 s • 1/2000 - 60 s (when ISO sensitivity is set to 80 - 400 in M mode) • 1/4000 s (maximum speed during high-speed continuous shooting)
Aperture	Electronically-controlled 7-blade iris diaphragm
Range	14 steps of 1/3 EV (W) (A , M mode)
Self-timer	Can be selected from 10 s and 2 s
Built-in flash	
Range (approx.) (ISO sensitivity: Auto)	[W]: 0.5 - 6.5 m (1 ft 8 in. - 21 ft) [T]: 0.5 - 2.5 m (1 ft 8 in. - 8 ft 2 in.)
Flash control	TTL auto flash with monitor preflashes
Flash exposure compensation	In steps of 1/3 EV in the range between -2 and +2 EV
Interface	Hi-Speed USB equivalent
Data transfer protocol	MTP, PTP
HDMI output	Can be selected from Auto, 480p, 720p, and 1080i
I/O terminal	<ul style="list-style-type: none"> • Micro-USB connector • HDMI micro connector (Type D) (HDMI output)

Wireless LAN	
Standards	IEEE 802.11b/g (standard wireless LAN protocol) ARIB STD-T66 (standard for low power data communication systems)
Communications protocols	IEEE 802.11b: DBPSK/DQPSK/CCK IEEE 802.11g: OFDM
Range (line of sight)	Approx. 10 m (11 yd)
Operating frequency	2412-2462 MHz (1-11 channels)
Security	OPEN/WPA2
Access protocols	CSMA/CA
Supported languages	Arabic, Bengali, Bulgarian, Chinese (Simplified and Traditional), Czech, Danish, Dutch, English, Finnish, French, German, Greek, Hindi, Hungarian, Indonesian, Italian, Japanese, Korean, Marathi, Norwegian, Persian, Polish, Portuguese (European and Brazilian), Romanian, Russian, Serbian, Spanish, Swedish, Tamil, Telugu, Thai, Turkish, Ukrainian, Vietnamese
Power sources	<ul style="list-style-type: none"> • One Rechargeable Li-ion Battery EN-EL12 (included) • AC Adapter EH-62F (available separately)
Charging time	Approx. 1 h 50 min (when using Charging AC Adapter EH-71P and when no charge remains)
Battery life¹	
Still pictures	Approx. 220 shots when using EN-EL12
Movie recording (actual battery life for recording)²	Approx. 50 min when using EN-EL12
Tripod socket	1/4 (ISO 1222)
Dimensions (W × H × D)	Approx. 103.0 × 58.3 × 32.0 mm (4.1 × 2.3 × 1.3 in.) (excluding projections)
Weight	Approx. 194 g (6.9 oz) (including battery and SD memory card)
Operating environment	
Temperature	0°C - 40°C (32°F - 104°F)
Humidity	85% or less (no condensation)

- Unless otherwise stated, all figures assume a fully-charged battery and an ambient temperature of 23 ±3°C (73.4 ±5.4°F) as specified by the Camera and Imaging Products Association (CIPA).

¹ Battery life may vary depending on conditions of use, such as the interval between shots or the length of time that menus and images are displayed.

² Individual movie files cannot exceed 4 GB in size or 29 minutes in length. Recording may end before this limit is reached if camera temperature becomes elevated.

Rechargeable Li-ion Battery EN-EL12

Type	Rechargeable lithium-ion battery
Rated capacity	DC 3.7 V, 1050 mAh
Operating temperature	0°C - 40°C (32°F - 104°F)
Dimensions (W × H × D)	Approx. 32 × 43.8 × 7.9 mm (1.3 × 1.7 × 0.3 in.)
Weight	Approx. 22.5 g (0.8 oz)

Charging AC Adapter EH-71P

Rated input	AC 100 - 240 V, 50/60 Hz, MAX 0.2 A
Rated output	DC 5.0 V, 1.0 A
Operating temperature	0°C - 40°C (32°F - 104°F)
Dimensions (W × H × D)	Approx. 55 × 22 × 54 mm (2.2 × 0.9 × 2.2 in.) (excluding plug adapter) For Argentina: Approx. 55 × 63 × 59 mm (2.2 × 2.5 × 2.4 in.) For Korea: Approx. 55 × 67 × 59 mm (2.2 × 2.7 × 2.4 in.)
Weight	Approx. 48 g (1.7 oz) (excluding plug adapter) For Argentina: Approx. 73 g (2.6 oz) For Korea: Approx. 70 g (2.5 oz)

Specifications

- Nikon will not be held liable for any errors this manual may contain.
- The appearance of this product and its specifications are subject to change without notice.

AVC Patent Portfolio License

This product is licensed under the AVC Patent Portfolio License for the personal and non-commercial use of a consumer to (i) encode video in compliance with the AVC standard ("AVC video") and/or (ii) decode AVC video that was encoded by a consumer engaged in a personal and non-commercial activity and/or was obtained from a video provider licensed to provide AVC video. No license is granted or shall be implied for any other use. Additional information may be obtained from MPEG LA, L.L.C.

See <http://www.mpegla.com>.

FreeType License (FreeType2)

Portions of this software are copyright © 2012 The FreeType Project (<http://www.freetype.org>). All rights reserved.

MIT License (HarfBuzz)

Portions of this software are copyright © 2014 The HarfBuzz Project (<http://www.freedesktop.org/wiki/Software/HarfBuzz>). All rights reserved.

Trademark Information

















- Microsoft, Windows and Windows Vista are either registered trademarks or trademarks of Microsoft Corporation in the United States and/or other countries.
- Mac, OS X, the iFrame logo and the iFrame symbol are trademarks or registered trademarks of Apple Inc., in the U.S. and other countries.
- Adobe and Acrobat are registered trademarks of Adobe Systems Inc.
- SDXC, SDHC and SD Logos are trademarks of SD-3C, LLC.
- PictBridge is a trademark.
- HDMI, HDMI logo and High-Definition Multimedia Interface are trademarks or registered trademarks of HDMI Licensing LLC.

HDMI









- Wi-Fi and the Wi-Fi logo are trademarks or registered trademarks of the Wi-Fi Alliance.
- Android and Google Play are trademarks or registered trademarks of Google, Inc.
- All other trade names mentioned in this manual or the other documentation provided with your Nikon product are trademarks or registered trademarks of their respective holders.

Index











Symbols

- A** Aperture-priority auto mode 46, 48
-  Apply selection button 5
-  Auto mode 26, 35
-  Delete button 33, 91, , 56
-  Flash mode 53, 54
-  Flash pop-up control 54
-  Focus mode 53, 59
- Fn** Function button 4
- M** Manual mode 46, 48
- MENU** Menu button 8, 66, 83, 90, 92
-  Movie mode 86
-  Playback button 4, 5, 32, 90
-  Playback zoom 81
- P** Programmed auto mode 46, 48
- SCENE** Scene mode 36
-  Self-timer/Smile timer 53, 57, 58
- S** Shutter-priority auto mode 46, 48
- EFFECTS** Special effects mode... 44
- T** (Telephoto) 29
-  Thumbnail display 82
- U** (User settings) mode 51
- W** (Wide-angle) 29
- .JPG 86
- .MOV 86
- .WAV 86

A



















































- AC adapter 97, 87
- Active D-Lighting 67, 47
- AF area mode 67, 71, 41
- AF assist 92, 72
- Aperture value 46
- Aperture-priority auto mode 46, 48
- Auto flash 55
- Auto off 23, 93, 74
- Auto with red-eye reduction 55, 56
- Autofocus 60, 67, 79, 90, 44, 62
- Autofocus mode 60, 67, 90, 44, 62























B

- Backlighting  41
- Battery 16, 18
- Battery charger 19, 87
- Battery level indicator 22
- Battery-chamber/memory card slot cover 16, 20
- Best Shot Selector 40, 36
- Black and white copy  41
- Blink warning 93, 79
- Brightness 92, 68
- BSS 40, 36
- Built-in ND filter 67, 71, 46
- Button sound 74

















C

- Calendar display 82
- Charge by computer 93, 77

- Charging AC adapter..... 18, 19
 Choose key picture..... 84, 58
 Close-up  40
 Color temperature..... 32
 Command dial..... 3, 5, 46
 Computer..... 98, 101
 Continuous..... 67, 71, 35
 Contrast..... 28
 Control ring..... 69
 Control ring options..... 92, 73
 COOLPIX Custom Picture Control
 66, 30
 COOLPIX Picture Control
 66, 71, 26
 Copy..... 84, 57
 Crop..... 81, 14
 Cross process..... 45
 Custom Picture Control
 66, 30
- D**
 Date and time..... 24, 92, 66
 Daylight saving time..... 24, 67
 Delete..... 33, 91, 6, 56
 Digital zoom..... 29, 92, 73
 Direct Print..... 98, 16
 D-Lighting..... 83, 8
 DPOF printing..... 20
 DSCN..... 86
 Dynamic Fine Zoom..... 29
- E**
 Easy panorama  42, 2
 Editing movies..... 21
 Editing still images..... 7
 Exposure bracketing..... 67, 40
 Exposure compensation..... 53, 63
 Exposure mode..... 46
- Extension..... 86
 Extracting still images..... 22
 Eye-Fi upload..... 93, 80
 Eyelet for camera strap..... 7
- E**
 Face detection..... 78
 Face priority..... 41
 Fast motion movies
 60, 61
 File name..... 86
 Fill flash..... 55
 Filter effects..... 83, 10, 28
 Fireworks show  41
 Firmware version..... 93, 81
 Flash..... 53, 54
 Flash exp. comp..... 67, 44
 Flash mode..... 53, 54
 Fn button setting..... 71
 Focal length..... 68, 50, 16
 Focus..... 30, 77, 88,
41, 44, 62
 Focus area
 12, 30, 43, 77, 41
 Focus indicator..... 11, 30
 Focus lock..... 80
 Focus mode..... 53, 59
 Food  40
 Format..... 20, 93, 75
 Format memory cards
 20, 93, 75
 Format the internal memory
 93, 75
 Frame rate..... 90, 62
 FSCN..... 86
 Full-frame playback
 13, 32, 81, 82

Full-time AF 67, 90, , 62
 Functions that cannot be used simultaneously..... 72
H
 HDMI..... 76
 HDMI device control..... 76
 HDMI micro connector..... 15
 HDR..... 41
 High ISO monochrome..... 45
 High key..... 45
 High-contrast monochrome..... 44
 High-speed continuous..... 35
 Histogram 14, 63, 92, 68
 HS movie 60, 61
I
 Identifier..... 86
 Image copy..... 84, 57
 Image quality..... 66, 71, 23
 Image selection screen 85
 Image sharpening 28
 Image size 66, 71, 25
 Infinity..... 60
 Internal memory indicator 22
 Interval timer shooting
 36, 37
 ISO sensitivity..... 67, 71, 39
L
 Landscape  38
 Language..... 93, 75
 Lens..... 6, 16
 Li-ion rechargeable battery
 16, 19
 Low key 45

M

M exposure preview..... 68, 51
 Macro close-up..... 60
 Manual focus..... 60, 61
 Manual mode 46, 48
 Memory capacity..... 22, 86, 87
 Memory card..... 20, 21
 Memory card slot..... 20
 Metering..... 67, 71, 34
 Microphone 86, 56
 Micro-USB connector
 97, 101, 16
 Minimum shutter speed 39
 Mode dial..... 26
 Monitor 10, 6
 Monitor settings..... 92, 68
 Motion detection 92, 72
 Movie length..... 87
 Movie menu 90, 59
 Movie mode 86
 Movie options..... 90, 59
 Movie playback..... 90
 Movie recording..... 86
 Movie recording time remaining
 86
 Multi selector 3, 5, 53
 Multiple exposure 68, 48
 Multi-shot 16..... 36
 Museum  40
N
 Night landscape  39
 Night portrait  39
 Noise reduction filter..... 67, 45
 Nostalgic sepia..... 44
 Number of exposures remaining
 22, 24

O

- Optical zoom 29
 Optional accessories 87

P

- Painting 45
 Party/indoor 39
 Peaking 93, 81
 Pet portrait 43
 Photo info 92, 68
 PictBridge 98, 16
 Picture Control 66, 71, 26
 Playback 32, 90, 56
 Playback menu 83
 Playback mode 32
 Playback zoom 81
 Power 22, 24
 Power switch/power-on lamp 1
 Preset manual 33
 Pre-shooting cache
 35, 37
 Pressing halfway 4, 30, 31
 Print 16, 17, 19
 Print date 92, 70
 Print order 83, 52
 Print order date option 53
 Printer 97, 16
 Programmed auto mode 46, 48
 Protect 83, 55

Q

- Quick adjust 28
 Quick retouch 83, 8

R































- RAW (NRW) images
 12, 23

RAW (NRW) processing

- 84, 12
 Rear-curtain sync 55
 Rechargeable battery 18
 Red-eye reduction 55, 56
 Reset all 93, 81
 Reset file numbering 93, 78
 Reset user settings 52
 Rotary multi selector 3, 5, 53
 Rotate image 83, 55
 RSCN 86

S

- Saturation 28
 Save user settings 52
 Scene auto selector 37
 Scene mode 36
 Selecting images 85
 Selective color 45
 Self-timer 53, 57
 Self-timer lamp 57, 58
 Sequence 34, 5, 57
 Sequence display options
 84, 58
 Setup menu 92, 65
 Shooting 26
 Shooting information 10, 32
 Shooting menu 66, 23
 Shooting mode 26, 27
 Shutter sound 74
 Shutter speed 46, 50
 Shutter-priority auto mode
 46, 48
 Shutter-release button
 4, 6, 30, 31
 Single 67, 35

- Single AF 67, 90, 44, 62
 Skin softening..... 79, 83, 09
 Slide show 83, 54
 Slow motion movies
 60, 61
 Slow sync 55
 Small picture 83, 11
 Smile timer 53, 58
 Soft 44
 Sound settings..... 92, 74
 Special effects mode..... 44
 Specialized menu for **U** 51
 Sports  38
 SSCN..... 86
 Standard flash..... 55
 Startup zoom position
 68, 51
 Subject tracking..... 42, 43
 Switching among tabs 9
- I**
 Target finding AF..... 77, 42
 Telephoto 29
 Thumbnail display 82
 Time difference 67
 Time zone 24, 67
 Time zone and date
 24, 92, 66
 Toggle Av/Tv selection
 93, 78
 Tone level..... 14
 Tone level information 14
 Toning..... 29
 TV 97, 15
 TV settings 93, 76
- U**
 USB cable..... 98, 101, 16
 User settings mode 51
- V**
 Vibration reduction
 71, 92, 71
 View grid 27
 View/hide framing grid
 12, 68
 ViewNX 2..... 99
 Voice memo 83, 56
 Volume 90, 56
- W**
 Welcome screen 92, 65
 White balance..... 66, 71, 31
 Wide-angle 29
 Wi-Fi options 94
 Wi-Fi options menu 95, 63
 Wireless LAN..... 94
- Z**
 Zoom..... 29
 Zoom control..... 5, 29
 Zoom memory 68, 50



A series of horizontal dashed lines spanning the width of the page, intended for handwriting practice.

No reproduction in any form of this manual, in whole or in part (except for brief quotation in critical articles or reviews), may be made without written authorization from NIKON CORPORATION.

NIKON CORPORATION

© 2014 Nikon Corporation



FX4A01(11)
6MN35511-01