

Nikon

DIGITAL CAMERA

COOLPIX P100

User's Manual

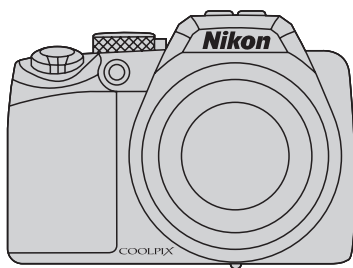

En

Trademark Information

- Microsoft, Windows and Windows Vista are either registered trademarks or trademarks of Microsoft Corporation in the United States and/or other countries.
- Macintosh, Mac OS, and QuickTime are trademarks of Apple Inc.
- Adobe and Acrobat are registered trademarks of Adobe Systems Inc.
- SD and SDHC logos are trademarks of SD-3C, LLC.
- PictBridge is a trademark.
- HDMI, **HDMI** logo and High-Definition Multimedia Interface are trademarks or registered trademarks of HDMI Licensing LLC.
- All other trade names mentioned in this manual or the other documentation provided with your Nikon product are trademarks or registered trademarks of their respective holders.

AVC Patent Portfolio License

This product is licensed under the AVC Patent Portfolio License for the personal and non-commercial use of a consumer to (i) encode video in compliance with the AVC standard ("AVC video") and/or (ii) decode AVC video that was encoded by a consumer engaged in a personal and non-commercial activity and/or was obtained from a video provider licensed to provide AVC video. No license is granted or shall be implied for any other use. Additional information may be obtained from MPEG LA, L.L.C.

See <http://www.mpegla.com>.

Introduction

First Steps

Basic Photography and Playback: 📷 (Auto) Mode

More on Shooting

More on Playback

Editing Pictures

Movie Recording and Playback

Connecting to Televisions, Computers and Printers

Basic Camera Setup

Caring for the Camera

Technical Notes and Index

For Your Safety

To prevent damage to your Nikon product or injury to yourself or to others, read the following safety precautions in their entirety before using this equipment. Keep these safety instructions where all those who use the product will read them. The consequences that could result from failure to observe the precautions listed in this section are indicated by the following symbol:



This icon marks warnings, information that should be read before using this Nikon product, to prevent possible injury.

WARNINGS

Turn off in the event of malfunction

Should you notice smoke or an unusual smell coming from the camera or Charging AC Adapter, unplug the Charging AC Adapter and remove the battery immediately, taking care to avoid burns. Continued operation could result in injury. After removing or disconnecting the power source, take the equipment to a Nikon-authorized service representative for inspection.

Do not disassemble

Touching the internal parts of the camera or Charging AC Adapter could result in injury. Repairs should be performed only by qualified technicians. Should the camera or Charging AC Adapter break open as the result of a fall or other accident, take the product to a Nikon-authorized service representative for inspection, after unplugging the product and/or removing the battery.

Do not use the camera or Charging AC Adapter in the presence of flammable gas

Do not use electronic equipment in the presence of flammable gas, as this could result in explosion or fire.

Handle the camera strap with care

Never place the strap around the neck of an infant or child.

Keep out of reach of children

Particular care should be taken to prevent infants from putting the battery or other small parts into their mouths.

 Observe caution when handling the battery

The battery may leak or explode if improperly handled. Observe the following precautions when handling the battery for use in this product:

- Before replacing the battery, turn the product off. If you are using the Charging AC Adapter/AC adapter, be sure it is unplugged.
 - Use only a Rechargeable Li-ion Battery EN-EL5 (supplied). Charge the battery by inserting it into the camera and connecting the Charging AC Adapter EH-68P/EH-68P (AR) (supplied).
 - When inserting the battery, do not attempt to insert it upside down or backwards.
 - Do not short or disassemble the battery or attempt to remove or break the battery insulation or casing.
 - Do not expose the battery to flame or to excessive heat.
 - Do not immerse in or expose to water.
 - Replace the terminal cover when transporting the battery. Do not transport or store with metal objects such as necklaces or hairpins.
 - The battery is prone to leakage when fully discharged. To avoid damage to the product, be sure to remove the battery when no charge remains.
 - Discontinue use immediately should you notice any change in the battery, such as discoloration or deformation.
- If liquid from the damaged battery comes in contact with clothing or skin, rinse immediately with plenty of water.

 Observe the following precautions when handling the Charging AC Adapter

- Keep dry. Failure to observe this precaution could result in fire or electric shock.
- Dust on or near the metal parts of the plug should be removed with a dry cloth. Continued use could result in fire.
- Do not handle the plug or go near the Charging AC Adapter during lightning storms. Failure to observe this precaution could result in electric shock.
- Do not damage, modify, forcibly tug or bend the USB cable, place it under heavy objects, or expose it to heat or flames. Should the insulation be damaged and the wires become exposed, take it to a Nikon-authorized service representative for inspection. Failure to observe these precautions could result in fire or electric shock.
- Do not handle the plug or Charging AC Adapter with wet hands. Failure to observe this precaution could result in electric shock.
- Do not use with travel converters or adapters designed to convert from one voltage to another or with DC-to-AC inverters. Failure to observe this precaution could damage the product or cause overheating or fire.

 **Use appropriate cables**

When connecting cables to the input and output jacks, use only the cables provided or sold by Nikon for the purpose, to maintain compliance with product regulations.

 **Handle moving parts with care**

Be careful that your fingers or other objects are not pinched by the lens cover or other moving parts.

 **CD-ROMs**

The CD-ROMs supplied with this device should not be played back on audio CD equipment. Playing CD-ROMs on an audio CD player could cause hearing loss or damage the equipment.

 **Observe caution when using the flash**

Using the flash close to your subject's eyes could cause temporary visual impairment. Particular care should be observed if photographing infants, when the flash should be no less than 1 m (3 ft. 4 in.) from the subject.

 **Do not operate the flash with the flash window touching a person or object**

Failure to observe this precaution could result in burns or fire.

 **Avoid contact with liquid crystal**

Should the monitor break, care should be taken to avoid injury caused by broken glass and to prevent liquid crystal from the monitor touching the skin or entering the eyes or mouth.

 **Turn the power off when using inside an airplane or the hospital**

Turn the power off while inside the airplane during take off or landing. Follow the instructions of the hospital when using while in a hospital. The electromagnetic waves given out by this camera may disrupt the electronic systems of the airplane or the instruments of the hospital.

Notices

Notice for Customers in the U.S.A.

Federal Communications Commission (FCC) Radio Frequency Interference Statement

This equipment has been tested and found to comply with the limits for a Class B digital device, pursuant to Part 15 of the FCC rules. These limits are designed to provide reasonable protection against harmful interference in a residential installation. This equipment generates, uses, and can radiate radio frequency energy and, if not installed and used in accordance with the instructions, may cause harmful interference to radio communications. However, there is no guarantee that interference will not occur in a particular installation. If this equipment does cause harmful interference to radio or television reception, which can be determined by turning the equipment off and on, the user is encouraged to try to correct the interference by one or more of the following measures:

- Reorient or relocate the receiving antenna.
- Increase the separation between the equipment and receiver.
- Connect the equipment into an outlet on a circuit different from that to which the receiver is connected.
- Consult the dealer or an experienced radio/television technician for help.



Nikon

COOLPIX P100

CAUTIONS

Modifications

The FCC requires the user to be notified that any changes or modifications made to this device that are not expressly approved by Nikon Corporation may void the user's authority to operate the equipment.

Interface Cables

Use the interface cables sold or provided by Nikon for your equipment. Using other interface cables may exceed the limits of Class B Part 15 of the FCC rules.

Notice for customers in the State of California WARNING

Handling the cord on this product will expose you to lead, a chemical known to the State of California to cause birth defects or other reproductive harm.

Wash hands after handling.

Nikon Inc.,

1300 Walt Whitman Road
Melville, New York 11747-3064
USA

Tel: 631-547-4200

Notice for customers in Canada

CAUTION

This Class B digital apparatus complies with Canadian ICES-003.

ATTENTION

Cet appareil numérique de la classe B est conforme à la norme NMB-003 du Canada.

Notice for customers in Europe

This symbol indicates that this product is to be collected separately.



The following apply only to users in European countries:

- This product is designated for separate collection at an appropriate collection point. Do not dispose of as household waste.
- For more information, contact the retailer or the local authorities in charge of waste management.

This symbol on the battery indicates that the battery is to be collected separately.



The following apply only to users in European countries:

- All batteries, whether marked with this symbol or not, are designated for separate collection at an appropriate collection point. Do not dispose of as household waste.
- For more information, contact the retailer or the local authorities in charge of waste management.

Table of Contents

















For Your Safety	ii
WARNINGS	ii
Notices	v
Introduction	1
About This Manual	1
Information and Precautions	2
Parts of the Camera	4
The Camera Body	4
Changing the Angle of the Monitor	6
Raising and Lowering the Built-in Flash	7
Attaching the Camera Strap and Lens Cap	7
The Monitor	8
Basic Operations	11
The Command Dial	11
The Multi Selector	12
The MENU Button	13
Switching Between Tabs	13
Help Displays	14
The [] (monitor) Button	14
The DISP (display) Button	15
First Steps	16
Inserting the Battery	16
Removing the Battery	17
Charging the Battery	18
Turning On and Off the Camera	21
Setting Display Language, Date and Time	22
Inserting Memory Cards	24
Removing Memory Cards	24
Basic Photography and Playback:  (Auto) Mode	26
Step 1 Turn the Camera On and Select  (Auto) Mode	26
Indicators Displayed in  (Auto) Mode	27
Step 2 Frame a Picture	28
Using the Electronic Viewfinder	28
Using the Zoom	29
Step 3 Focus and Shoot	30
Pressing the Shutter-Release Button Halfway/All the Way Down	30
Step 4 Viewing and Deleting Pictures	32
Viewing Pictures (Playback Mode)	32
Deleting Pictures	32
Using the Flash	34
Setting the Flash Mode	35
Taking Pictures with the Self-Timer	37
Using Focus Mode	38

Table of Contents

Setting the Focus Mode.....	39
Using Manual Focus.....	40
Adjusting the Brightness (Exposure Compensation).....	41
More on Shooting	42
Selecting a Shooting Mode (Mode Dial).....	42
Shooting Suited for the Scene	43
Shooting in the Scene Selected by the Camera (Scene Auto Selector).....	43
Selecting Scenes for Shooting (Scene Mode).....	45
Features.....	46
Taking Pictures for a Panorama	53
Taking Pictures of Smiling Faces (Smart Portrait Mode)	55
Smart Portrait Menu.....	57
Focusing on a Moving Subject in Subject Tracking Mode.....	59
Subject Tracking Menu	61
Shooting with a High-Speed Burst (Sport Continuous Mode)	62
Sport Continuous Menu.....	64
Setting the Exposure for Shooting (P, S, A, M Modes)	66
P, S, A, M Modes	66
P (Programmed Auto) Mode.....	68
S (Shutter-Priority Auto) Mode	69
A (Aperture-Priority Auto) Mode.....	70
M (Manual) Mode.....	71
Shooting Options: Shooting Menu (P, S, A, M Modes)	73
 Image Quality	75
 Image Size.....	76
 Optimize Image.....	79
 White Balance.....	82
 ISO Sensitivity.....	84
 Metering.....	85
 Continuous	86
 Auto Bracketing	89
 AF-Area Mode	90
 Autofocus Mode	93
 Flash Exp. Comp.....	93
 Noise Reduction	94
 Distortion Control	94
 Active D-Lighting	95
Functions that Cannot be Applied Simultaneously.....	96
Using U (User Setting Mode).....	98
Save the Settings in U	99
Resetting Saved Settings	100
More on Playback	101
Operations in Full-Frame Playback	101









































Viewing Continuously Shot Pictures (Pictures in a sequence)	102
Viewing Multiple Pictures: Thumbnail Playback	104
Calendar display	105
Taking a Closer Look: Playback Zoom	106
Playback Options: Playback Menu	107
 Print Set: Setting the Pictures and Number of Copies to Print	108
 Slide Show.....	110
 Delete: Deleting Multiple Pictures	111
 Protect	113
 Rotate Image.....	114
 Hide Image.....	114
 Copy: Copying Between the Internal Memory and Memory Card	115
 Sequence Display Options.....	116
 Choose Key Picture	116
Voice Memos: Recording and Playback	117
Recording Voice Memos	117
Playing Voice Memos	117
Deleting Voice Memos	117
Editing Pictures	118
Picture Editing Functions	118
Editing Pictures	120
 Quick Retouch: Enhancing Contrast and Saturation	120
 D-Lighting: Enhancing Brightness and Contrast.....	121
 Skin Softening: Making Skin Appear Smoother.....	122
 Small Picture: Resizing Pictures.....	124
 Black Border: Adding a Black Border to a Picture	125
 Crop: Cutting Out Part of a Picture.....	126
Movie Recording and Playback	127
Recording Movies	127
Recording Slow Motion Movies or Fast Motion Movies (HS Movie).....	130
Movie Menu	132
 Movie Options.....	133
 HS Movie Options	134
 Autofocus Mode.....	135
 Electronic VR.....	136
 Wind Noise Reduction	136
Movie Playback	137
Deleting Movie.....	137
Connecting to Televisions, Computers and Printers	138
Connecting to a TV.....	138
Connecting to a Computer	140
Before Connecting the Camera.....	140

Table of Contents

Transferring Pictures from a Camera to a Computer.....	141
Charging While Connecting to a Computer.....	145
Connecting to a Printer.....	146
Connecting the Camera and Printer.....	147
Printing Pictures One at a Time.....	148
Printing Multiple Pictures	149
Basic Camera Setup	152
Setup Menu.....	152
 Welcome Screen.....	154
 Date	155
 Monitor Settings.....	158
 DATE Date Imprint	159
 Vibration Reduction.....	160
 Motion Detection.....	162
 AF Assist.....	163
 Red-eye reduction.....	163
 Digital Zoom.....	164
 Sound Settings	165
 Auto Off.....	165
  Format Memory/Format Card	166
 Language	167
 TV Settings.....	167
 Charge by Computer	168
 Blink Warning.....	169
 Reset All.....	171
 R Reset file numbering.....	174
 Ver Firmware Version.....	174
Caring for the Camera.....	175
Caring for the Camera	175
Cleaning	177
Storage.....	178
Technical Notes and Index	179
Optional Accessories	179
Approved Memory Cards	180
File and Folder Names.....	181
Error Messages	183
Troubleshooting.....	188
Specifications	195
Supported Standards	198
Index.....	199

About This Manual

Thank you for your purchase of Nikon COOLPIX P100 digital camera. This manual is written to help you enjoy taking pictures with your Nikon digital camera. Read this manual thoroughly before use, and keep it where all those who use the product will read it.

Symbols and Conventions

To make it easier to find the information you need, the following symbols and conventions are used:



This icon marks cautions, information that should be read before use, to prevent damage to the camera.



This icon marks tips, additional information that may be helpful when using the camera.



This icon marks notes, information that should be read before using the camera.



This icon indicates that more information is available elsewhere in this manual or in the *Quick Start Guide*.

Notations

- A Secure Digital (SD) memory card is referred to as a “memory card”.
- The setting at the time of purchase is referred to as the “default setting”.
- The names of menu items displayed in the camera monitor, and the names of buttons or messages displayed in a computer monitor are indicated in bold text.

Screen Samples

In this manual, images are sometimes omitted from monitor and electronic viewfinder display samples so that monitor indicators can be more clearly shown.

Illustrations and Screen Display

Illustrations and text displays shown in this manual may differ from actual display.

Memory Cards

Pictures taken with this camera can be stored in the camera's internal memory or on removable memory cards. If a memory card is inserted, all new pictures will be stored on the memory card and delete, playback, and format operations will apply only to the pictures on the memory card. The memory card must be removed before the internal memory can be formatted or used to store pictures to, or delete, or view pictures.

Information and Precautions

Life-Long Learning

As part of Nikon's "Life-Long Learning" commitment to ongoing product support and education, continually updated information is available online at the following sites:

- For users in the U.S.A.: <http://www.nikonusa.com/>
- For users in Europe and Africa: <http://www.europe-nikon.com/support/>
- For users in Asia, Oceania, and the Middle East: <http://www.nikon-asia.com/>

Visit these sites to keep up-to-date with the latest product information, tips, answers to frequently asked questions (FAQs), and general advice on digital imaging and photography. Additional information may be available from the Nikon representative in your area. See the URL below for contact information:

<http://imaging.nikon.com/>

Use Only Nikon Brand Electronic Accessories

Nikon COOLPIX cameras are designed to the highest standards and include complex electronic circuitry. Only Nikon brand electronic accessories (including battery chargers, batteries, Charging AC Adapters and AC adapters) certified by Nikon specifically for use with this Nikon digital camera are engineered and proven to operate within the operational and safety requirements of this electronic circuitry.

THE USE OF NON-NIKON ELECTRONIC ACCESSORIES COULD DAMAGE THE CAMERA AND MAY VOID YOUR NIKON WARRANTY.

The use of third-party rechargeable Li-ion batteries not bearing the Nikon holographic seal could interfere with normal operation of the camera or result in the batteries overheating, igniting, rupturing, or leaking.

For more information about Nikon brand accessories, contact a local authorized Nikon dealer.

Holographic seal: Identifies this device as an authentic Nikon product.



Before Taking Important Pictures

Before taking pictures on important occasions (such as at weddings or before taking the camera on a trip), take a test shot to ensure that the camera is functioning normally. Nikon will not be held liable for damages or lost profits that may result from product malfunction.

About the Manuals

- No part of the manuals included with this product may be reproduced, transmitted, transcribed, stored in a retrieval system, or translated into any language in any form, by any means, without Nikon's prior written permission.
- Nikon reserves the right to change the specifications of the hardware and software described in these manuals at any time and without prior notice.
- Nikon will not be held liable for any damages resulting from the use of this product.
- While every effort was made to ensure that the information in these manuals is accurate and complete, we would appreciate it were you to bring any errors or omissions to the attention of the Nikon representative in your area (address provided separately).

Notice Concerning Prohibition of Copying or Reproduction

Note that simply being in possession of material that was digitally copied or reproduced by means of a scanner, digital camera or other device may be punishable by law.

• Items prohibited by law from being copied or reproduced

Do not copy or reproduce paper money, coins, securities, government bonds or local government bonds, even if such copies or reproductions are stamped "Sample". The copying or reproduction of paper money, coins, or securities which are circulated in a foreign country is prohibited. Unless the prior permission of the government was obtained, the copying or reproduction of unused postage stamps or post cards issued by the government is prohibited.

The copying or reproduction of stamps issued by the government and of certified documents stipulated by law is prohibited.

• Cautions on certain copies and reproductions

The government has issued cautions on copies or reproductions of securities issued by private companies (shares, bills, checks, gift certificates, etc.), commuter passes or coupon tickets, except when a minimum of necessary copies are to be provided for business use by a company. Also, do not copy or reproduce passports issued by the government, licenses issued by public agencies and private groups, ID cards and tickets, such as passes and meal coupons.

• Comply with copyright notices

The copying or reproduction of copyrighted creative works such as books, music, paintings, woodcut prints, maps, drawings, movies and photographs is governed by national and international copyright laws. Do not use this product for the purpose of making illegal copies or to infringe copyright laws.

Disposing of Data Storage Devices

Please note that deleting images or formatting data storage devices such as memory cards or built-in camera memory does not completely erase the original image data. Deleted files can sometimes be recovered from discarded storage devices using commercially available software, potentially resulting in the malicious use of personal image data. Ensuring the privacy of such data is the user's responsibility.

Before discarding a data storage device or transferring ownership to another person, erase all data using commercial deletion software, or format the device and then completely refill it with images containing no private information (for example, pictures of empty sky). Be sure to also replace any pictures selected for the welcome screen (□ 154). Care should be taken to avoid injury or damage to property when physically destroying data storage devices.

Parts of the Camera

The Camera Body

Introduction

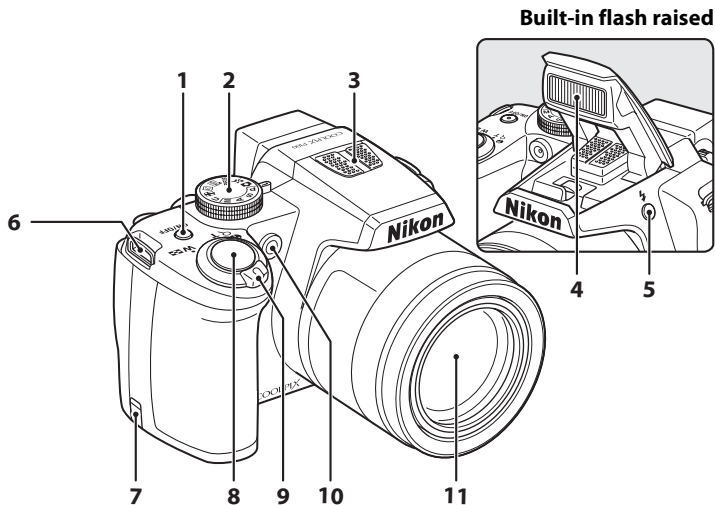

1	Power switch/Power-on lamp 19, 21, 145, 165
2	Mode dial..... 42
3	Microphone (stereo)..... 117, 127
4	Built-in flash 7, 34
5	⚡ (Flash pop-up) button..... 7, 35
6	Eyelet for camera strap (at two places) 7
7	Power connector cover (for connection with an optional AC Adapter)..... 179

8	Shutter-release button 30
9	Zoom control 29
	W : Wide 29
	T : Tele 29
	📷 : Thumbnail playback..... 104
10	🔍 : Playback zoom..... 106
	❓ : Help 14
10	Self-timer lamp..... 37
10	AF-assist illuminator..... 163
11	Lens 177, 195

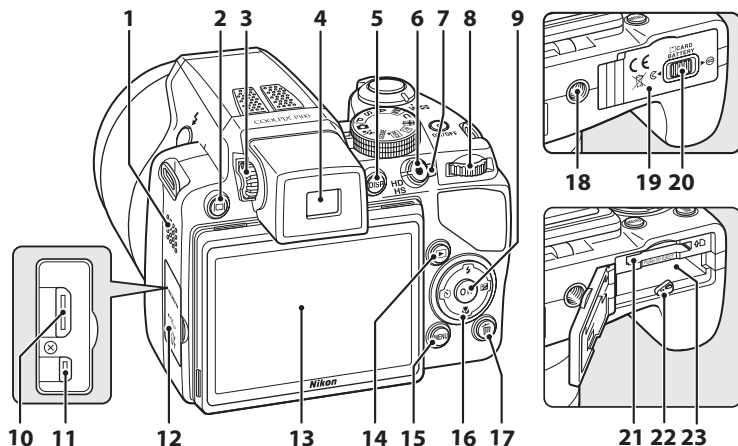

1	Speaker	117, 137
2	⏏ (monitor) button	14
3	Diopter adjustment control	14
4	Electronic viewfinder	14
5	DISP (display) button	15
6	● (movie-record) button	127
7	Movie mode switch	127
8	Command dial	11
9	OK (apply selection) button	12
10	HDMI Mini Connector	138
11	USB/Audio video connector	138, 141, 147
12	Connector cover	138, 141, 147

13	Monitor	8, 15, 27
14	▶ (playback) button	32
15	MENU button	13, 45, 74, 107, 132, 153
16	Multi selector	12
17	🗑 (delete) button	32, 33, 117, 137
18	Tripod socket	
19	Battery-chamber/ memory card slot cover	16, 24
20	Cover latch	16, 24
21	Memory card slot	24
22	Battery latch	16, 17
23	Battery chamber	16

Changing the Angle of the Monitor

The angle of the monitor can be lowered down to 82° or raised upward to 90°. This is convenient when taking pictures with the camera held at high or low positions.

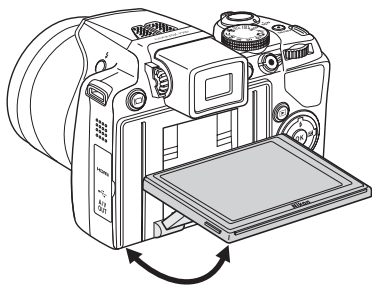
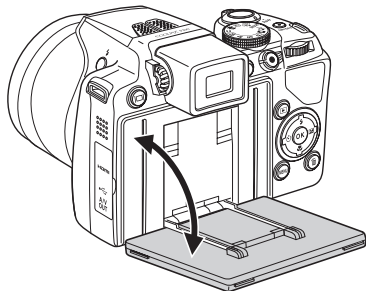

Notes on Monitor

- Do not apply excessive force when changing the angle of the monitor.
- The monitor cannot be moved horizontally.
- Put the monitor back in the original position when using in normal situations.

Raising and Lowering the Built-in Flash

Press the  (flash pop-up) button to raise the built-in flash.

- See “Using the Flash” (📖34) for more information on setting the flash.
- When not using the built-in flash, gently push the flash down.

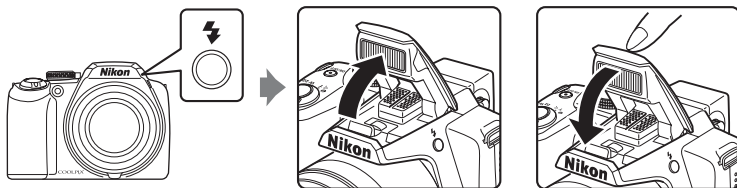

Attaching the Camera Strap and Lens Cap

Attach the lens cap to the strap, and then attach the strap to the camera (at two places).

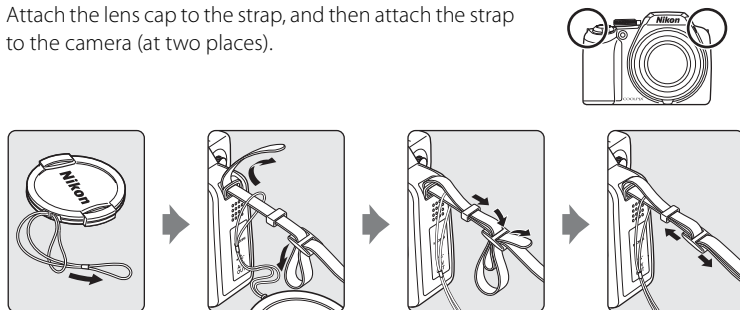

Lens Cap

- Remove the lens cap before you shoot a picture.
- At times when you will not be shooting pictures such as when the power is off, or while you are carrying the camera, attach the lens cap to the camera to protect the lens.

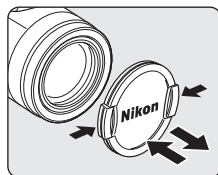

The Monitor

The following indicators may appear in the monitor during shooting and playback (actual display varies with current camera settings).

See page 15 for details on changing the monitor display.

Shooting

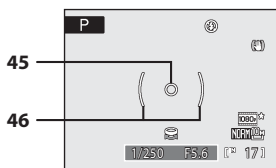
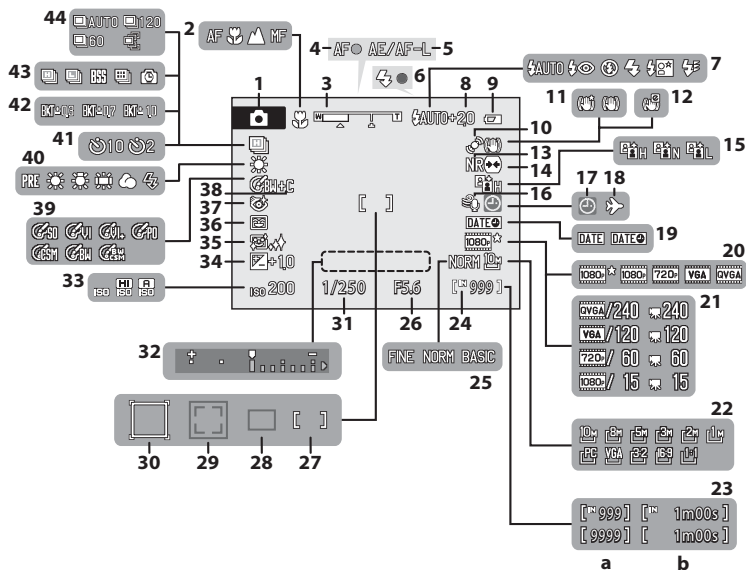

1	Shooting mode*26, 43, 45, 55, 59, 62, 66, 98	24	Internal memory indicator..... 27
2	Focus mode.....38	25	Image quality..... 75
3	Zoom indicator29	26	Aperture..... 67
4	Focus indicator30	27	Focus area (for manual, center) ...30, 90
5	AE/AF-L indicator.....54	28	Focus area (for auto)..... 90
6	Flash indicator.....36	29	Focus area (for face priority).....55, 90
7	Flash mode34	30	Focus area (for subject tracking mode)..... 59
8	Flash exposure compensation93	31	Shutter speed.....67
9	Battery level indicator26	32	Exposure display..... 71
10	Motion detection icon 162	33	ISO sensitivity36, 84
11	Vibration reduction icon (still pictures)160	34	Exposure compensation value 41
12	Electronic VR icon (movies) 136	35	Skin softening 57
13	Noise reduction94	36	Smile timer 57
14	Distortion control94	37	Blink proof 58
15	Active D-Lighting.....95	38	B&W + color..... 81
16	Wind noise reduction..... 136	39	Image optimization..... 79
17	"Date not set" indicator..... 183	40	White balance mode 82
18	Travel destination indicator155	41	Self-timer indicator 37
19	Date imprint..... 159	42	Bracketing..... 89
20	Movie options..... 132	43	Continuous shooting mode..... 86
21	HS movie options..... 134	44	High-speed mode 64
22	Image size.....76		Pre-shooting cache.....64, 65
	(a) Number of exposures remaining (still pictures)26	45	Spot metering area 85
23	(b) Movie length127	46	Center-weighted area 85

* Differs according to the current shooting mode.

Playback

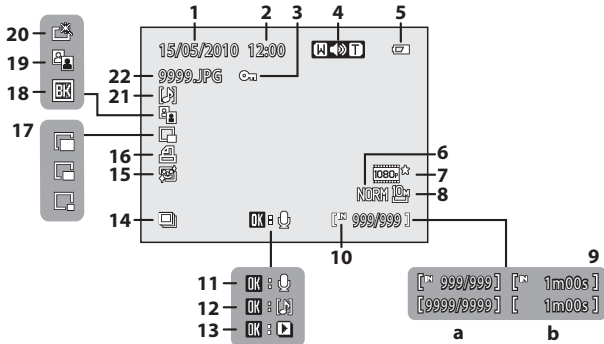

1	Date of recording	22
2	Time of recording	22
3	Protect icon	113
4	Volume indicator	117, 137
5	Battery level indicator	26
6	Image quality *	75
7	Movie options *	133
8	Image size *	76
9	(a) Current frame number/ total number of frames	32
	(b) Movie length	137
10	Internal memory indicator	32
11	Voice memo recording guide	117

12	Voice memo playback guide	117
13	Sequence playback guide	102
13	Movie playback guide	137
14	Sequence display	116
15	Skin softening icon	122
16	Print-order icon	108
17	Small picture	124, 126
18	Black border indicator	125
19	D-Lighting icon	121
20	Quick retouch icon	120
21	Voice memo indicator	117
22	File number and type	181

* Differs according to the selected option.

Basic Operations

The Command Dial

You can rotate the command dial to select items from a menu screen or to choose and configure any of the following functions.

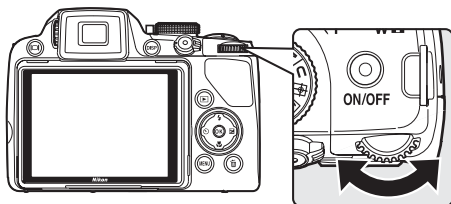

For Shooting

Mode	Use	Description	
Programmed auto (mode dial set to P)		Change the flexible program	68
Shutter-priority auto (mode dial set to S)		Adjust shutter speed	69
Aperture-priority auto (mode dial set to A)		Adjust aperture	70
Manual (mode dial set to M)		Adjust shutter speed or aperture (press the multi selector to select a different option)	71

For Playback

Mode	Use	Description	
Full-frame playback or thumbnail playback		Choose a picture	32, 101, 104
Calendar display		Choose a date	105
Playback zoom		Change the zoom ratio	106
During sequence playback or pause		Select playback control	102
During movie pause		Advanced or Rewound	137

The Multi Selector

This section describes standard uses of the multi selector to select modes, select menu options, and to apply selections.

Operate by pressing the up, down, left, right section, or the **OK** (apply selection) button.

For Shooting

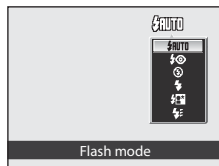
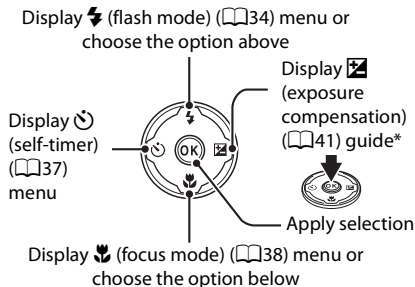

* In shooting mode **M** (manual), select whether to set the shutter speed or the aperture when the command dial is rotated (book 71).

For Playback

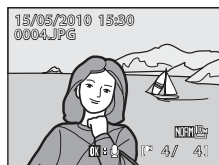
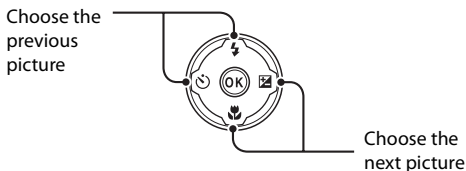

For the Menu Screen

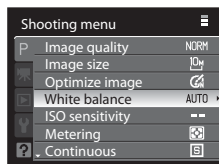
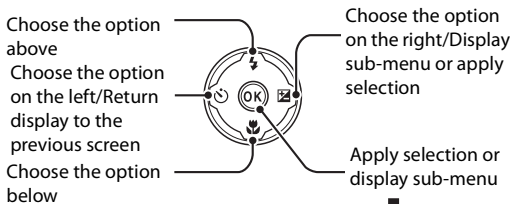

Note on the Multi Selector

12 In this manual, up, down, left, and right presses of the multi selector may be indicated with ▲, ▼, ◀ and ▶.

The MENU Button

Press the **MENU** button to display the menu and to select options for the menu items.

- Use the multi selector to navigate the menus (12).
- Menu items can also be chosen by rotating the command dial.
- Select a tab on the left side of the monitor to display the corresponding menu.
- Press the **MENU** button again to exit the menu.



Displayed when the menu contains two or more pages

Displays the menus for the mode selected by the mode dial

Displays the movie menu

Displays the playback menu

Displays the setup menu

Displayed when there are following menu options

Displayed when there are previous menu options

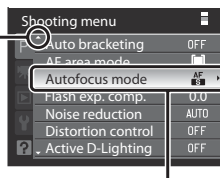

Select an item, then press the **OK** button or the multi selector **▶** to proceed to the next set of options.

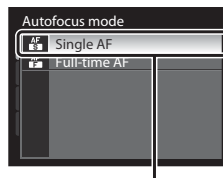

Press the **OK** button or the multi selector **▶** to apply the selection.

Switching Between Tabs

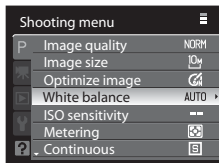

Press the multi selector **◀** to highlight the tab.



Press the multi selector **▲▼** to choose another tab, and press either the **OK** button or **▶**.

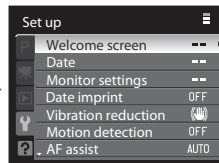

The chosen menu is displayed.

Help Displays

Rotate the zoom control to **T** (🔍) when **?** is displayed at the bottom of the menu screen to view a description of the currently selected menu option.

To return to the original menu, rotate the zoom control to **T** (🔍) again.

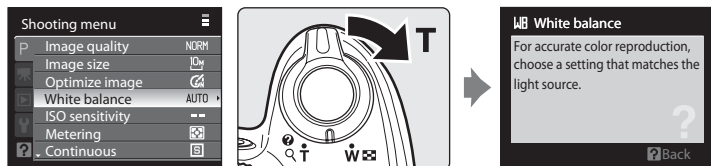

The **|** (monitor) Button

Press the **|** (monitor) button to switch between the monitor or electronic viewfinder. Switch to the one that suits the shooting conditions. For example, use the electronic viewfinder in bright locations when it is difficult to see the monitor.

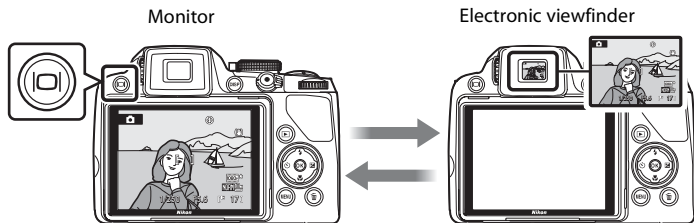

🔍 Diopter Adjustment of Electronic Viewfinder

When the diopter for the electronic viewfinder is out of focus and the display is difficult to see, adjust the diopter with the diopter adjustment control. While looking into the viewfinder, rotate the diopter adjustment control until the display is clearly visible.

Take care not to scratch your eye with your fingertips or nails when rotating the diopter adjustment control.

Diopter adjustment control

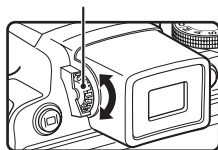

The DISP (display) Button

To switch between the information displayed on the monitor during shooting and playback, press the **DISP** button.

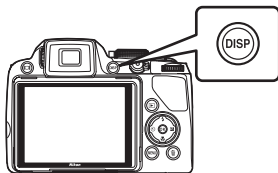

For Shooting

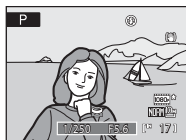

Display information

Display the picture and the shooting data.

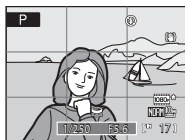

Framing grids¹

Display a boxed guide for framing.



Information hidden

Display the picture only.

For Playback

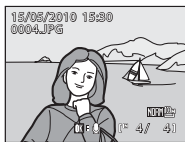

Display photo information

Display the picture taken and the photo information.

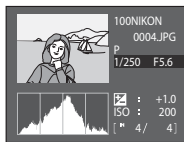

Display shooting data (except for movies)

Display highlight², histogram³ and shooting data⁴.



Information hidden

Display only the taken picture.

1 Available only when mode dial is set to **P**, **S**, **A**, **M** or **U**.

2 The brightest portions of the image (portions that are highlighted) will blink. Use highlights as a guide when setting exposure.

3 The histogram is a bar graph that shows the brightness distribution in the picture. The horizontal axis corresponds to pixel brightness, with dark tones to the left and bright tones to the right. The vertical axis shows the number of pixels.

4 The shooting data displayed includes the folder name, file name, shooting mode used (**P**, **S**, **A** or **M**), shutter speed, aperture, exposure compensation, ISO sensitivity, and the current file number/total number of exposures.

P is displayed when the shooting mode **SCENE**, **SCN**, **SMILE**, **AF**, **AF-ON** or **P** is chosen.

Inserting the Battery

Insert a Rechargeable Li-ion Battery EN-EL5 (supplied) into the camera.

- Charge the battery before first use or when the battery is running low (18).

1 Open the battery-chamber/memory card slot cover.

- Slide the cover latch to the  position (1), and open the battery-chamber/memory card slot cover (2).

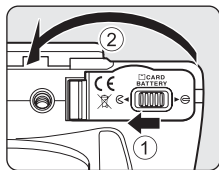

2 Insert the battery.

- Confirm that the positive (+) and negative (-) terminals are oriented correctly, as shown on the label at the entrance of the battery chamber, and insert the battery.
- Use the battery to push the orange battery latch in the direction indicated by the arrow (1) and fully insert the battery (2).
- When the battery is fully inserted, the battery latch will lock it in place.

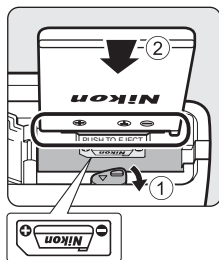

Inserting the Battery Correctly

Inserting the battery upside down or backwards could damage the camera. Be sure to confirm that the battery is in the correct orientation.

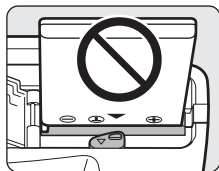

3 Close the battery-chamber/memory card slot cover.

- Close the battery-chamber/memory card slot cover (1), and slide the cover latch to the  position (2).

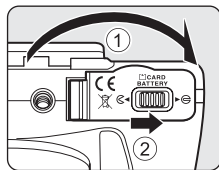

Removing the Battery

Turn the camera off (📖21) and confirm that the power-on lamp and the monitor are off before opening the battery-chamber/memory card slot cover.

Slide the orange battery latch in the direction shown (①) and eject the battery. Pull the battery out straight (②).

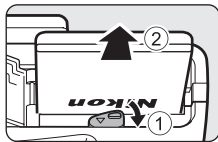

- Note that the battery may become hot during use; observe due caution when removing the battery.

✓ Notes on the Battery

- Be sure to read and follow the warnings and cautions of “For Your Safety” (📖ii) thoroughly before using the battery.
- Be sure to read and follow the warnings for “The Battery” (📖176) of the section “Caring for the Camera” thoroughly before using the battery.
- If the battery will not be used for an extended period, recharge it at least once every six months and run it flat before returning it to storage.

Charging the Battery

Charge the supplied Rechargeable Li-ion Battery EN-EL5 inserted into the camera, by connecting the supplied Charging AC Adapter EH-68P to the camera via the supplied USB Cable UC-E6, and then plugging the Charging AC Adapter into an electrical outlet.

1 Prepare the Charging AC Adapter EH-68P.

If a plug adapter* is included, attach the plug adapter to the plug on the Charging AC Adapter. Push the plug adapter firmly until it is securely held in place. Once the two are connected, attempting to forcibly remove the plug adapter could damage the product.

* The shape of the plug adapter varies according to the country or region in which the camera was purchased.

For Customers in Argentina

If the camera was purchased in Argentina, the shape of the Charging AC Adapter EH-68P (AR) differs from that supplied in other countries, and a plug adapter is not included. Proceed to step 2.

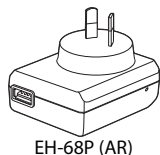
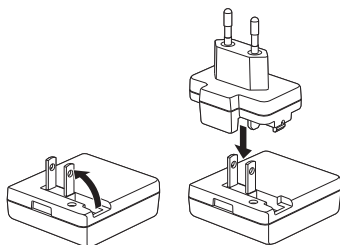

2 Be sure that the power-on lamp and the monitor are off.

- Be sure to insert the battery into the camera (📖16) and turn off the camera (📖21).

3 Use the supplied USB cable to connect the Charging AC Adapter to the camera.

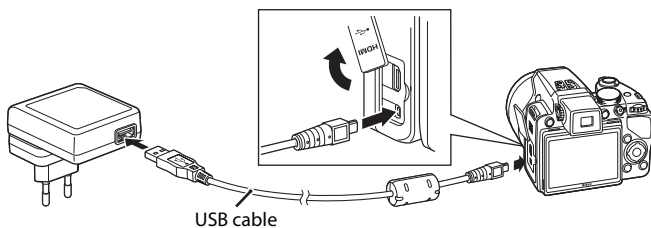

✓ Connecting the Cable

When connecting the cable, be sure that the camera connector is properly oriented. Do not use force when connecting the cable to the camera. When disconnecting the cable, do not pull the connector at an angle.

4 Plug the Charging AC Adapter into an electrical outlet.

- The camera's power-on lamp slowly blinks orange to indicate that the battery is charging.
- About three hours and 30 minutes are required to charge a fully exhausted battery.
- The following chart explains power-on lamp status when the camera is plugged into the electrical outlet.

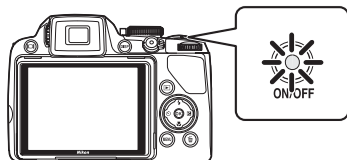
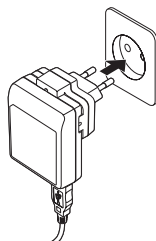

Power-on lamp	Description
Blinks slowly (orange)	Battery charging.
Off	Not charging. When the power-on lamp changes from slow blinking (orange) to off, charging is complete.
Flickers (orange)	<ul style="list-style-type: none"> • Operating temperature range exceeded. Charge the battery indoors with an ambient temperature of 5 °C to 35 °C (41 °F to 95 °F). • A USB cable is incorrectly connected, a Charging AC Adapter is incorrectly plugged in, or the battery is faulty. Disconnect the USB cable or unplug the Charging AC Adapter and correctly connect it again, or change the battery.

5 Disconnect the Charging AC Adapter from the electrical outlet and then disconnect the USB cable.

Charging the Battery

Notes on Charging AC Adapter

- Do not use the Charging AC Adapter EH-68P with any device that is not supported.
- Be sure to read and follow the warnings and cautions of "For Your Safety" (📖ii) thoroughly before using the EH-68P.
- Be sure to read and follow the warnings for "The Battery" (📖176) thoroughly before using the battery.
- The EH-68P is compatible with AC 100-240 V, 50/60 Hz electrical outlets. When using in other countries, use a third-party plug adapter as necessary. For more information about plug adapters, consult your travel agency.
- The Charging AC Adapter EH-68P is for charging the battery inserted into the camera. When the camera is connected to an electrical outlet with EH-68P, it cannot be turned on.
- Do not, under any circumstances, use a Charging AC Adapter other than the EH-68P or a USB AC adapter. Failure to observe this precaution could result in overheating or in damage to the camera.

Notes on AC Power Supply

- If the AC Adapter EH-62A (available separately) (📖179) is used, power is supplied to the camera from an electrical outlet and taking pictures and playing back pictures are available with this camera.
- Do not, under any circumstances, use any AC adapter other than the EH-62A. Failure to observe this precaution could result in overheating or in damage to the camera.

Charging Using Computer or Battery Charger



- Connecting the COOLPIX P100 to a computer also charges the Rechargeable Li-ion Battery EN-EL5 (📖145, 168).
- Rechargeable Li-ion Battery EN-EL5 can also be charged using the Battery Charger MH-61 (available separately) (📖179).

Turning On and Off the Camera

Remove the lens cap before turning on the camera. Press the power switch to turn on the camera. The power-on lamp (green) will light for a moment and the monitor will turn on.

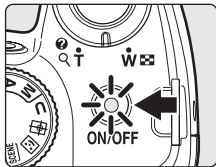
Press the power switch again to turn off the camera. When the power is turned off, both the power-on lamp and monitor turn off.





- When the camera is off, holding down the  button will turn the camera on in playback mode (32).

Lens Error

If **Lens error. (If the lens cap is attached, turn the camera off, remove the lens cap, and turn the camera on.)** is displayed, check that the lens cap has been removed and turn the camera on again.

Standby Mode (Auto Power Off)

If no operations are performed, the monitor turns off automatically, the camera enters standby mode and the power-on lamp blinks. If no operations are performed for another three minutes, the camera will turn off automatically.

- During shooting or playback, if no operations are performed for about a minute (default setting), the camera enters standby mode.
- If the monitor is off in standby mode (when the power-on lamp blinks), perform the following operations to turn on the monitor.
 - Press the power switch, the shutter-release button or the  button.
 - Rotate the mode dial.
- The time that elapses before the camera enters standby mode can be changed from the **Auto off** (165) in the setup menu (152).

Setting Display Language, Date and Time

A language-selection dialog is displayed the first time the camera is turned on.

1 Press the power switch to turn on the camera.

- The power-on lamp (green) will light for a moment and the monitor will turn on.
- Remove the lens cap.

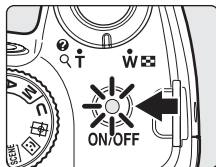

2 Use the multi selector to choose the desired language and press the **OK** button.

- For information on using the multi selector, see "The Multi Selector" (📖12).



3 Choose **Yes** and press the **OK** button.

- If **No** is selected, the date and time will not be set.

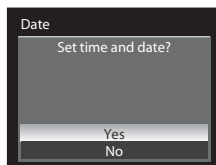

4 Press the multi selector **◀** or **▶** to select your home time zone (📖157), and press the **OK** button.

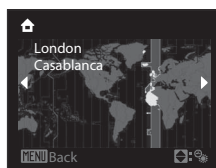

Daylight Saving Time

If daylight saving time is in effect, press the multi selector **▲** in the time zone selection screen displayed in step 4 to turn on the daylight saving time option.

When the daylight saving time option is enabled,  is displayed at the top of the monitor.

To turn off the daylight saving time option, press **▼**.

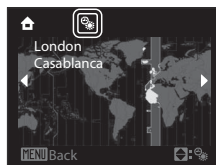

5 Edit the date.

- Press ▲ or ▼ to edit the highlighted item.
- Press ► to move the highlight in the following order.
D (day) → **M** (month) → **Y** (year) → **hour** → **minute** → **DMY** (the order in which the day, month, and year are displayed)
- Press ◀ to return the cursor to the previous item.

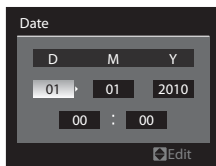
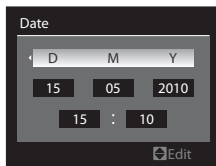
**6** Choose the order in which the day, month and year are displayed.**7** Make sure that the lens cap is removed, and then press the Ⓞ button or ►.

- The settings are applied and monitor display reverts to shooting mode.
- The lens will extend at this time.

📷 Changing the Date and Time and Imprinting the Date

- Select **Date** from **Date** (📖155) in the setup menu (📖152) to change the current date and time, and follow the procedure described in step 5 above.
- Select **Time zone** from **Date** in the setup menu to change the time zone and daylight saving time settings (📖155).
- To imprint the date on pictures, first set the date and time, and set **Date imprint** in the setup menu (📖159).

Inserting Memory Cards

Image and movie files are stored in the camera's internal memory (approx. 43 MB) or on removable memory cards (available separately) (📖180).

If a memory card is inserted in the camera, data is automatically stored on the memory card and data recorded to the memory card can be played back, deleted, or transferred. Remove the memory card to store data in the internal memory, or play back, delete, or transfer data from the internal memory.

- 1 Confirm that the power-on lamp and the monitor are turned off and open the battery-chamber/memory card slot cover.

- Be sure to turn off the camera before opening the battery-chamber/memory card slot cover.

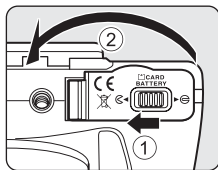

- 2 Insert the memory card.

- Slide the memory card in correctly as shown on the right, until it clicks into place.
- Close the battery-chamber/memory card slot cover after inserting the memory card.

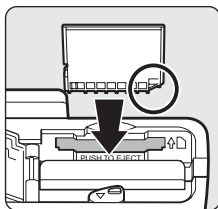

❑ Inserting the Memory Card Correctly

Inserting the memory card upside down or backwards could damage the camera or the memory card. Be sure to confirm that the memory card is in the correct orientation.

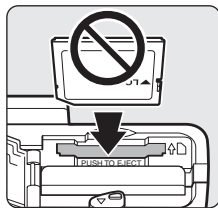

Removing Memory Cards

Before removing memory cards, turn the camera off and confirm that the power-on lamp and the monitor are off.

Open the battery-chamber/memory card slot cover and press the card in (①) gently to partially eject the card. Pull the memory card out straight (②).

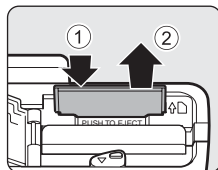

✓ Formatting a Memory Card

If the message at the right is displayed when the camera is turned on, the memory card must be formatted before use. **Note that formatting (📖166) permanently deletes all data on the memory card.** Be sure to make copies of any pictures you wish to keep before formatting the memory card.

To format, use the multi selector to choose **Yes** and press the **OK** button. When the confirmation dialog is displayed, choose **Format** and press the **OK** button to start formatting.

- Do not turn the camera off, or open the battery-chamber/memory card slot cover until formatting is complete.
- When you insert memory cards used in other devices into this camera for the first time, be sure to format them (📖166) with this camera.

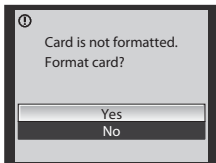

✓ The Write Protect Switch

Memory cards are equipped with a write protect switch. When this switch is in the "lock" position, data cannot be written to, or deleted from, the memory card. If the switch is in the "lock" position, unlock it by sliding the switch to the "write" position to record or delete pictures, or to format the memory card.

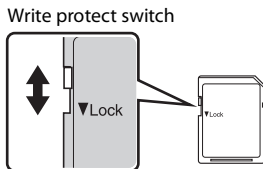

✓ Memory Cards

- Use only Secure Digital memory cards.
- Do not perform the following operations during formatting, while data is being written to or deleted from the memory card, or during data transfer to a computer. Failure to observe this precaution could result in the loss of data or in damage to the camera or memory card:
 - Eject the memory card
 - Remove the battery
 - Turn off the camera
 - Disconnect the AC adapter
- Do not use a computer to format the memory card.
- Do not disassemble or modify.
- Do not drop, bend, or expose to water or strong physical shocks.
- Do not touch the metal terminals with your fingers or metal objects.
- Do not affix labels or stickers to the memory card.
- Do not leave in direct sunlight, closed vehicles or areas exposed to high temperatures.
- Do not expose to humidity, dust, or to corrosive gases.

Step 1 Turn the Camera On and Select (Auto) Mode

This section describes how to take pictures in  (auto) mode, an automatic, “point-and-shoot” mode recommended for first-time users of digital cameras.

1 Remove the lens cap and press the power switch.

- The power will be turned on, and the lens will extend.
- The power-on lamp (green) will light for a moment and the monitor will turn on.

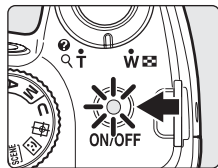

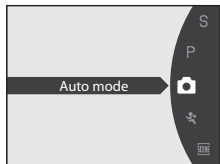
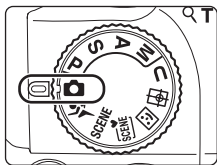

2 Rotate the mode dial to .



3 Check the battery level and number of exposures remaining in the monitor.

Battery Level

Monitor	Description
NO INDICATOR	Battery fully charged.
	Battery level low; prepare to charge or replace the battery.
 Battery exhausted.	Cannot shoot. Recharge or replace with a fully-charged battery.

Battery level indicator

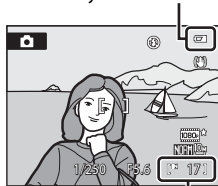

Number of exposures remaining

Number of Exposures Remaining

The number of exposures remaining will be displayed.

The number of pictures that can be stored depends on the remaining capacity of the internal memory or memory card, the image quality, and the image size (77).

Indicators Displayed in (Auto) Mode

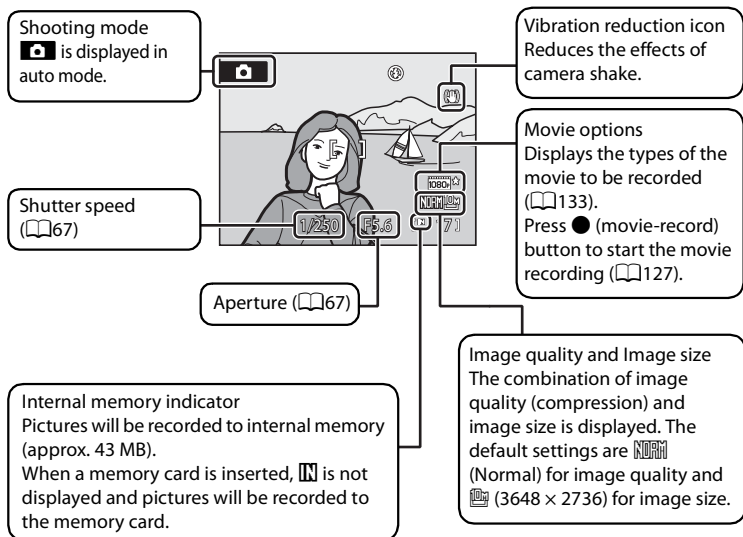

If the monitor is turned off in standby mode to save power, press the power switch or the shutter-release button to turn the monitor on (165).

Note on the Flash

When the built-in flash is lowered, the flash setting is fixed to off and  appears at the top of the monitor. In situations where flash is needed, such as in dark locations or when the subject is backlit, be sure to raise the built-in flash (135).

Functions Available in (Auto) Mode

- Focus mode (138) and exposure compensation (141) can be applied and pictures can be taken using the flash mode (134) and self-timer (137).
- Pressing the **MENU** button allows you to specify settings for the shooting menu options **Image quality** (175) and **Image size** (176).

Vibration Reduction

- See **Vibration reduction** (160) in the setup menu (152) for more information.
- Set **Vibration reduction** to **Off** when using a tripod to stabilize the camera during shooting.

Step 2 Frame a Picture

1 Ready the camera.

- Hold the camera steadily in both hands.
- Keep your fingers, hair, strap and other objects away from the lens, flash, AF-assist illuminator, microphone and speaker.

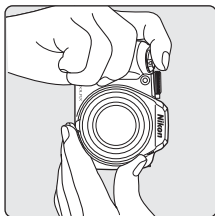
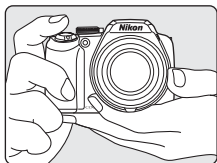

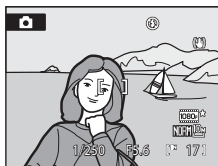

2 Frame the picture.

- Position the main subject near the center of the monitor.



Using the Electronic Viewfinder

Use the electronic viewfinder to frame pictures when bright light makes it difficult to see the display in the monitor. Press the  button to switch to the electronic viewfinder ( 14).

When the diopter for the electronic viewfinder is out of focus, rotate the diopter adjustment control to a position where the display is clearly visible ( 14).

Using the Zoom

Rotate the zoom control to activate optical zoom. Rotate in the direction of **T** to zoom in on the subject. Or rotate in the direction of **W** to have a wider view. Rotating the zoom control all the way in either direction will adjust the zoom quickly, while rotating the control partially will adjust the zoom slowly. A zoom indicator is displayed at the top of the monitor when the zoom control is rotated.

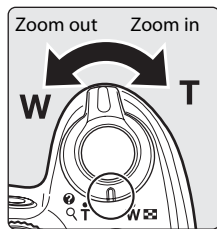

Optical zoom Digital zoom

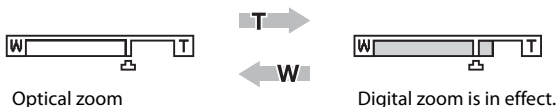

Digital Zoom

When the camera is already at the maximum optical zoom magnification, rotating the zoom control in the **T** direction will trigger digital zoom. The subject can be magnified up to 4x of the maximum optical zoom ratio. Focus will be on the center of the frame and the focus area will not be displayed when digital zoom is in effect.



Digital Zoom and Interpolation

Unlike optical zoom, digital zoom uses a digital imaging process known as interpolation to magnify images, resulting in slight deterioration of picture quality according to the image size (164) and digital zoom magnification.

Interpolation is applied at zoom positions beyond  when shooting still pictures. When zoom is increased beyond the  position, interpolation is initiated and the zoom indicator turns yellow to indicate that interpolation is being applied.

The position of  moves to the right as image size decreases, allowing for confirmation of the zoom positions at which shooting still pictures without interpolation is possible at the current image size setting.



When the image size is small

- By using **Digital zoom** (164) in the setup menu (152), it is possible to restrict the magnification of the digital zoom within a range where images may not deteriorate, or to set the digital zoom so that it will not operate.

Step 3 Focus and Shoot

1 Press the shutter-release button halfway.

- When the button is pressed halfway, the camera focuses.
- The camera focuses on the subject in the center focus area display. When the subject is in focus, the focus area display will glow green.

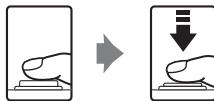

- When digital zoom is in effect, the camera focuses on the subject in the center of the frame, and the focus area is not displayed. When the subject is in focus, the focus indicator (8) glows green.
- Focus and exposure remain locked while the shutter-release button is pressed halfway.
- When the shutter-release button is pressed halfway and the camera is unable to focus, the AF-area or focus indicator blinks red. Change the composition and press the shutter-release button halfway again.

2 Press the shutter-release button the rest of the way down.

- The shutter will be released and the picture will be recorded to the memory card or internal memory.



Pressing the Shutter-Release Button Halfway/All the Way Down

The camera features a two-stage shutter-release button. To set focus and exposure, press the shutter-release button halfway, stopping when you feel resistance. Focus and exposure lock while the shutter-release button is held in this position. To release the shutter and take a picture, press the shutter-release button the rest of the way down. Do not use force when pressing the shutter-release button, as this may result in camera shake and blurred pictures.



Press the shutter-release button halfway to lock focus and exposure.

Press the shutter-release button the rest of the way down to shoot.

✓ During Recording

While pictures are being recorded, the number of exposures remaining display will blink. **Do not open the battery-chamber/memory card slot cover** while pictures are being recorded. Cutting power or removing the memory card in these circumstances could result in loss of data or in damage to the camera or card.

✓ Autofocus

Autofocus may not perform as expected in the following situations. In some rare cases, the subject may not be in focus despite the fact that the active focus area, or focus indicator, glows green:

- Subject is very dark
- Objects of sharply differing brightness are included in the scene (e.g., the sun is behind the subject and is in deep shadow)
- No contrast between the subject and surroundings (e.g., when the subject is standing in front of a white wall, wearing a white shirt)
- Several objects are at different distances from the camera (e.g., an animal inside a cage)
- Subject is moving rapidly

In the situations noted above, try pressing the shutter-release button halfway to refocus several times, or focus on another subject and use focus lock. When using focus lock, be sure that the distance between the camera and the subject with which focus was locked is the same as that for the actual subject.

🔒 Focus Lock

Use focus lock to focus on off-center subjects when Center is selected for AF area mode.

- Be sure that the distance between the camera and the subject does not change.
- When the shutter-release button is pressed halfway, exposure is locked.



Frame the subject to be focused on using the camera



Press the shutter-release button halfway.



Confirm that the focus area is green.



Continue holding down the shutter-release button halfway and recompose the picture.



Press the shutter-release button the rest of the way down to shoot.











🔦 AF-assist illuminator

If the subject is poorly lit, the AF-assist illuminator (📖163) may light by pressing the shutter-release button halfway.

Step 4 Viewing and Deleting Pictures

Viewing Pictures (Playback Mode)

Press the  (Playback) button.

- The last picture shot will be displayed in full-frame playback mode.
- Press the multi selector , ,  or  to view additional pictures. Continue holding down , ,  or  to fast forward pictures. Pictures can also be chosen by rotating the command dial.
- Pictures may be displayed briefly at low resolution immediately after switching to the previous picture or next picture.
- Press the  button or the shutter-release button to switch to shooting mode.
- When  is displayed, pictures stored in the internal memory will be displayed. When memory card is inserted,  is not displayed and pictures stored on the memory card will be displayed.

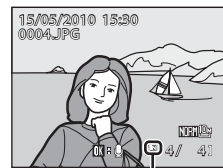
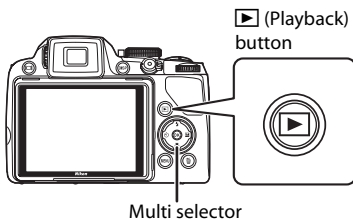

Internal memory indicator

Deleting Pictures

- 1 Press the  button to delete the picture currently displayed in the monitor.

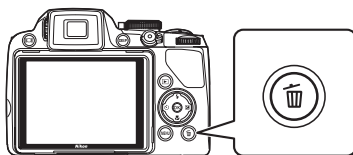

- 2 Use the multi selector to choose **Yes** and press the  button.

- The picture that is deleted cannot be restored.
- To exit without deleting the picture, choose **No** and press the  button.

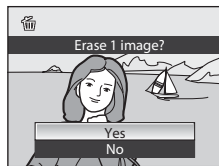



Options Available in Playback Mode

For details, see "More on Playback" (📖101) or "Editing Pictures" (📖118).

Pressing the Button to Turn on the Camera

When the camera is off, holding down the  button will turn the camera on in playback mode. The lens will not extend.

Viewing Pictures

- Press the  button to switch between using the monitor and electronic viewfinder display (📖14).
- Press the **DISP** button to switch between showing and hiding the photo information or shooting information that is displayed on the monitor (📖15).
- Pictures that were shot using face priority (📖91) will be rotated automatically when displayed in full-frame playback mode according to the orientation of the face (except for pictures shot when **Continuous** (📖86) or **Auto bracketing** (📖89) was set).
- When full-frame playback is performed for pictures that were shot continuously, those pictures shot at the same time are displayed together in a group (sequence display) (📖102).
- If the monitor is off in standby mode due to the camera's auto off function, press the  button to reactivate it (📖165).

Deleting the Last Picture Taken While in Shooting Mode

In shooting mode, press the  button to delete the last picture shot.

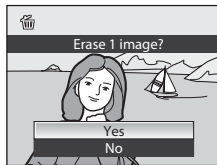

Deleting Multiple Pictures

Choose **Delete** (📖111) from the playback menu (📖107) to delete multiple pictures.

Using the Flash

In dark locations or when the subject is backlit, you can shoot pictures with flash by raising the built-in flash. You can set a flash mode that suits the shooting conditions. The flash has a range of about 0.5 to 10 m (1 ft. 8 in. to 32 ft.) for wide, and about 1.7 to 2.5 m (5 ft. 8 in. to 8 ft. 2 in.) for tele (when **ISO sensitivity** is set to **Auto**).

Auto

Flash fires automatically when lighting is poor.

Auto with red-eye reduction

Reduces “red-eye” in portraits.

Off

Flash will not fire even when lighting is poor.

Fill flash

Flash fires when a picture is taken, regardless of how bright the subject is. Use to “fill-in” (illuminate) shadows and backlit subjects.

Slow sync

Fill flash is combined with slow shutter speed.

Flash illuminates main subject; slow shutter speeds are used to capture background at night or under dim light.

Rear-curtain sync

Flash fires just before shutter closes, creating the effect of a stream of light behind moving subjects.

Auto with Red-eye Reduction

This camera uses **Advanced Red-eye Reduction (“In-Camera Red-Eye Fix”)**.

Pre-flashes are fired repeatedly at low intensity before the main flash, reducing the red-eye effect.

If the camera detects “red-eye” when a picture is taken, Nikon’s own In-Camera Red-Eye Fix processes the image before it is recorded.

Note the following when taking pictures:

- Because pre-flashes are fired, there is a slight lag between when the shutter-release button is pressed and when the picture is shot.
- The time required to save the picture increases slightly.
- Advanced red-eye reduction may not produce the desired results in some situations.
- In extremely rare instances, areas not subject to red-eye may be affected by advanced red-eye reduction processing; in these cases, choose another mode and try again.

When **Red-eye reduction** ( 163) in the setup menu is set to **Pre-flash off**, the shutter is released immediately when the shutter-release button is fully pressed, without firing the pre-flashes before the main flash.

Setting the Flash Mode

1 Press the (flash pop-up) button.

The built-in flash will be raised.

- When the built-in flash is lowered, the flash mode will be fixed to  (off).

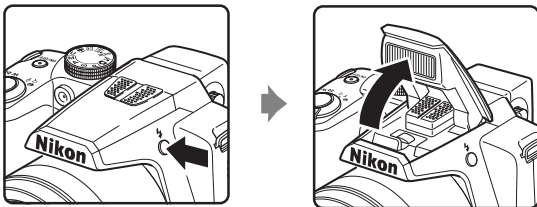





2 Press (flash mode) on the multi selector.

- The flash mode menu is displayed.



3 Press or on the multi selector to choose the desired mode and press the button.

- The icon for the selected flash mode is displayed at the top of the monitor.
- When  (auto) is applied,  is only displayed for a few seconds even if monitor indicators ( 15) are turned on.
- If a setting is not applied by pressing the  button within a few seconds, the selection will be cancelled.

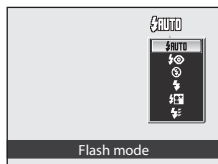

Lowering the Built-in Flash

When not using the built-in flash, gently push to lower the flash.

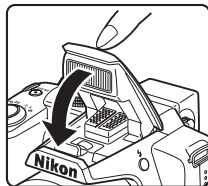

✔ Shooting When Lighting is Poor and When the Flash is Disabled (🔇)

- Use of a tripod is recommended to stabilize the camera during shooting and avoid the effects of camera shake. When the camera is stabilized with a tripod, set **Vibration reduction** (📖160) to **Off** in the setup menu (📖152).
- The **ISO** indicator is displayed when the camera automatically increases sensitivity. Pictures taken when **ISO** is displayed may be slightly mottled.
- When shooting at slow shutter speeds in dark location, the noise reduction function may operate. When the noise reduction function operates, it may take more time to save images.

✔ Note on Using the Flash

Reflections from dust particles in the air may appear as bright spots in pictures. To reduce these reflections, set the flash to 🚫 (Off), or shoot pictures with the built-in flash lowered.

🔍 The Flash Indicator

The flash indicator shows the flash status when the shutter-release button is pressed halfway down.

- On: Flash will fire when picture is shot.
- Blinks: Flash is charging. Wait a few seconds and try again.
- Off: Flash will not fire when picture is shot.



🔍 The Flash Mode Setting

The default flash mode setting with shooting mode.

- 📷 (auto) mode: ⚡AUTO auto flash.
- 🏞️ (scene auto selector): ⚡AUTO auto flash. The camera sets the flash mode according to the scene mode that it has automatically determined.
- SCENE: Varies depending on the scene (📖45 to 52).
- 📸 (smart portrait): ⚡AUTO auto flash (when blink proof is Off), fixed to 🚫 flash off (when blink proof is On) (📖58).
- 🎯 (subject tracking): ⚡AUTO auto flash.
- 🏃 (sport continuous): Fixed to 🚫 flash off.
- **P, S, A, M**: ⚡AUTO auto flash.

The flash cannot be used simultaneously with certain functions. See "Functions that Cannot be Applied Simultaneously" (📖96) for more information.

In the following situations, the setting for flash mode is stored in the camera's memory even after the camera is turned off.

- When shooting modes **P, S, A** or **M** is used
- When shooting using ⚡👁️ (auto with red-eye reduction) in 📷 (auto) mode

Taking Pictures with the Self-Timer

The self-timer is useful for taking pictures of yourself, such as in group souvenir shots, or if you want to reduce camera shake when you press the shutter-release button. You can select a two-second or ten-second timer.

When using the self-timer, use of a tripod is recommended. When the camera is stabilized with a tripod, set **Vibration reduction** (📖160) to **Off** in the setup menu (📖152).

1 Press (self-timer) on the multi selector.

- The self-timer menu is displayed.



2 Press or on the multi selector to choose **10s** or **2s** and press the button.

- **10s** (ten seconds): suitable for memorial portraits.
- **2s** (two seconds): suitable for preventing camera shake.
- The mode selected for self-timer is displayed.
- If a setting is not applied by pressing the  button within a few seconds, the selection will be cancelled.



3 Frame the picture and press the shutter-release button halfway.

- Focus and exposure will be set.

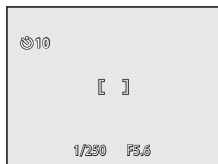

4 Press the shutter-release button the rest of the way down.

- The self-timer starts, and the number of seconds remaining until the shutter is released is displayed in the monitor. The self-timer lamp will blink. The lamp stops blinking one second before the picture is taken and remains lit until the shutter is released.
- When the shutter is released, the self-timer turns **OFF**.
- To stop the timer before a picture is taken, press the shutter-release button again.

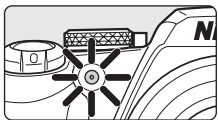
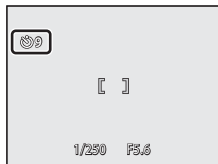

Using Focus Mode



Choose a focus mode according to the subject and composition.

AF Autofocus

Camera automatically adjusts focus according to distance to subject. Use when the distance from subject to lens is 50 cm (1 ft. 8 in.) or more, or 1.7 m (5 ft. 8 in.) or more when camera is zoomed all the way out.



Macro close-up

Use for close-ups of flowers or small objects.

The closest shooting distance will vary according to the magnification of the zoom. In the zoom position where the  icon and zoom indicator on the monitor glow green (wide-angle side from the  icon), the camera can focus on subjects as close as about 10 cm (4 in.) from the lens. In the center zoom position between the maximum wide-angle side and the  icon, the camera can focus on subjects as close as about 1 cm (0.4 in.) from the lens.

Infinity







Use when shooting distant scenes through window glass or when shooting landscapes.

When the shutter-release button is pressed halfway, the focus area or focus indicator () always glows green. However, the camera may not be able to focus on nearby objects. The flash mode is set to  (off).

MF Manual focus

The focus can be adjusted for any subject that is a distance of 1 cm (0.4 in.) to infinity from the lens ()40).

Focus Modes Available in Each Shooting Mode

		P, S, A, M, U	SCENE				
AF (Autofocus)	✓ ¹	✓ ¹	2	3	✓	✓	✓ ¹
 (Macro close-up)	✓	✓			-	-	✓
 (Infinity)	✓	✓			-	-	✓
MF (Manual focus)	-	✓			-	-	✓

1 Default setting for each shooting mode.

2 Available focus modes and default setting varies between different scene modes ()45 to 52).

3 The camera sets the focus mode according to the scene mode that it has automatically determined ()43).

The Focus Mode Setting



- For shooting modes **P**, **S**, **A** and **M**, the changed focus mode setting will be stored in the camera's memory even after the camera is turned off.
- Focus mode cannot be used simultaneously with certain features. See "Functions that Cannot be Applied Simultaneously" ()96) for more information.

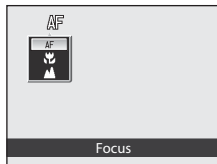

Setting the Focus Mode

- 1 Press  (focus mode) on the multi selector.

- The focus mode menu is displayed.



- 2 Press  or  on the multi selector to choose the desired focus mode and press the  button.

- The mode selected for focus mode is displayed.
- When **AF** (autofocus) is applied, **AF** is only displayed for a few seconds even if monitor indicators () are turned on.
- If a setting is not applied by pressing the  button within a few seconds, the selection will be cancelled.

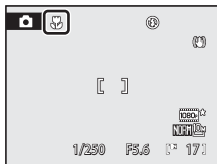



Macro Close-up

When using shooting mode **P**, **S**, **A**, **M** or **U**, if **Autofocus mode** () is set to **Full-time AF**, the camera will continually focus until you press the shutter-release button halfway and the focus locks. A sound will be heard while the camera focuses.

When using other shooting modes, **Full-time AF** is turned on automatically when macro mode is turned on.

Infinity

If you set focus mode to infinity while using  (auto) mode, the **P**, **S**, **A**, **M** and **U** modes, or  (Sport continuous) mode, the focus area will not be displayed on the screen.



Using Manual Focus

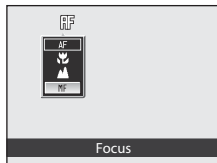

Available when the shooting mode is **P, S, A, M, U** or  (sport continuous). Select a shooting mode with the mode dial (42).

- 1** Press  (focus mode) on the multi selector to display the setup menu for focus mode.

- Use the multi selector to choose **MF** (manual focus) and press the  button. **MF** is displayed at the top of the monitor.
- The center of the picture will be enlarged and displayed on the screen.



- 2** Press  or  on the multi selector to adjust the focus.

- Adjust the focus while viewing the image in the monitor.
- Press  to focus on far subjects.
- Press  to focus on near subjects.
- Press the shutter-release button halfway to check the composition. Press the shutter-release button the rest of the way down to take the picture.

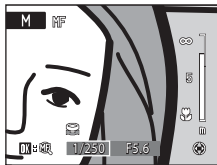

- 3** Press the  button to check the field of view.

- The field of view and the enlarged center section of the picture will be displayed together.
- Press the shutter-release button at this point to take the picture.

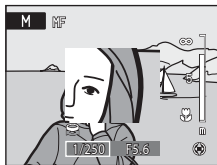

- 4** Press the  button.

- The set focus is locked. You can continue shooting with the locked focus.
- To readjust the focus, repeat steps 1 to 3.
- To change back to autofocus, return to step 1 and choose any setting other than **MF**.

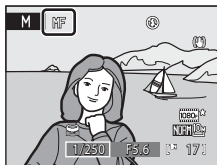

MF (Manual Focus)

- An approximate depth of field (the area in focus behind and in front of the subject) can be previewed by pressing the shutter-release button halfway.
- Digital zoom is not available.



Adjusting the Brightness (Exposure Compensation)



Exposure compensation is used to alter the exposure from the value suggested by the camera to make pictures brighter or darker.

1 Press  (exposure compensation) on the multi selector.

- The exposure compensation guide is displayed.
- Exposure compensation is not available for **M** (manual) mode.



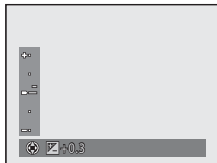

2 Press  or  on the multi selector to choose the compensation and press the  button.

- To make the subject brighter: adjust the exposure compensation to the "+" side.
- To make the subject darker: adjust the exposure compensation to the "-" side.
- Exposure compensation can be set to values between -2.0 and +2.0 EV.
- When an exposure compensation value other than **0.0** is applied, the value is displayed with the  icon in the monitor.
- To cancel the exposure compensation setting, change the value to **0.0** and press the  button.



3 Press the shutter-release button to take the picture.

- Pressing the shutter-release button instead of the  button in step 2 will allow pictures to be taken with the specified exposure compensation value, although the face priority (91) will not be available.

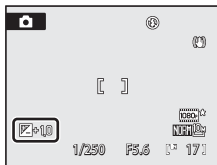

Exposure Compensation Value

For shooting modes **P**, **S** and **A**, the setting for exposure compensation will be stored in the camera's memory even after the camera is turned off.

Using Exposure Compensation

- The camera tends to lower exposure when the frame is dominated by brightly lit objects (for example, sunlit expanses of water, sand, or snow) or when the background is much brighter than the main subject. Positive compensation should be used in such case.
- The camera tends to raise exposure when the frame is dominated by very dark objects (for example, a swath of dark green leaves) or when the background is much darker than the main subject. Negative compensation should be used in such case.

Selecting a Shooting Mode (Mode Dial)

When the mode dial is rotated next to the mark, the camera switches to the corresponding shooting mode shown below.

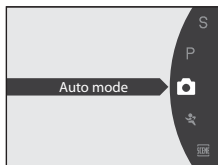
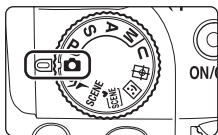

More on Shooting

Auto mode (📖26)

Choose this simple mode, an automatic, “point-and-shoot” mode recommended for first-time users of digital cameras.

P, S, A, M (📖66)

Choose these modes for greater control over shutter speed and aperture.

U User settings (📖98)

Save the settings made in shooting modes **P, S, A** and **M**. Once the settings are saved, you can shoot with the settings that are more frequently used by just changing over to this mode.

Sport continuous (📖62)

Continuous shooting of pictures is done at high speeds.

SCENE Scene (📖45)

Choose this mode for automatic adjustment of settings to suit the selected subject type.

Scene auto selector (📖43)

By simply framing a picture, the camera automatically selects the optimum scene mode for simpler shooting.

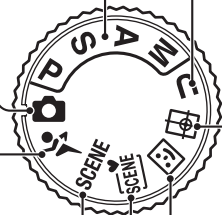

Subject tracking (📖59)

Choose this mode to shoot moving subjects. Once you register a subject to be focused on, the focus area moves and follows the subject.







Smart portrait (📖55)

The camera detects smiling faces using face priority and releases the shutter automatically. The skin softening function makes a human subject's skin appear smoother.

Shooting Suited for the Scene

Shooting in the Scene Selected by the Camera (Scene Auto Selector)

By simply framing a picture, the camera automatically selects the optimum scene mode for simpler shooting. When the camera is aimed at a subject in  scene auto selector mode, the camera automatically selects one of the following scene modes.

- Auto mode (typical photography)
- Portrait 
- Landscape 
- Night portrait 
- Night landscape 
- Close-up 
- Backlight 

1 Rotate the mode dial to .

- Scene auto selector will be enabled.
- If the built-in flash is not raised, the message **The flash is lowered.** will be displayed.
- Press the  (flash pop-up) button to raise the built-in flash.

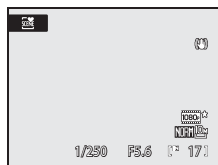

2 Frame the subject and take the picture.

- When the camera automatically selects a scene mode, the shooting mode icon changes to that for the scene mode currently enabled.

 : Auto mode

 : Portrait

 : Landscape

 : Night portrait

 : Night landscape

 : Close-up

 : Backlight

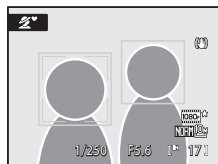



- Press the shutter-release button halfway to set focus and exposure. When the subject is in focus, the focus area (active focus area) glows green.
- Press the shutter-release button the rest of the way down to take the picture.

✔ **Note on Scene Auto Selector Mode**

Depending upon shooting conditions, the camera may not select the desired scene mode. Should this occur, switch to  (Auto) mode (□26) or choose the desired scene mode manually (□45).

✍ **Focusing in Scene Auto Selector Mode**

- In scene auto selector mode, the camera detects and focuses on a face (see “Shooting with Face Priority” (□91) for more information).
- When the shooting mode icon  is displayed or when  (close-up) mode is in use, the camera will automatically focus on the area (one of nine) containing the subject closest to the camera. This is similar to the **Auto** setting of **AF area mode** (□90).

✍ **Night Landscape Shooting in Scene Auto Selector Mode**







When the setting is switched to  (night landscape) in scene auto selector mode, the mood of the night landscape is captured with a slow shutter speed (continuous shooting is not performed), unlike **Night landscape** (□49) in scene mode. We recommend stabilizing the camera with a tripod.

- Set **Vibration reduction** (□160) to **Off** when using a tripod to stabilize the camera during shooting.

✍ **Note on the Flash**

When the built-in flash is lowered, the flash setting is fixed to off and  appears at the top of the monitor. In situations where flash is needed, such as in dark locations or when the subject is backlit, be sure to raise the built-in flash (□35).

✍ **Functions Available in Scene Auto Selector Mode**

- Digital zoom is not available.
-  **AUTO** (auto) (default setting) and  (off) flash mode settings (□34) can be applied. When  **AUTO** (auto) is applied, the camera automatically chooses the optimum flash mode setting for the scene mode it has selected. When  (off) is applied, the flash does not fire, regardless of shooting conditions.
- Self-timer (□37) and exposure compensation (□41) settings can be adjusted.
- The  (focus mode) button (□12, 38) on the multi selector is not available.
- If you press the **MENU** button to display the  (scene auto selector) menu, you can set **Image quality** (□75) and **Image size** (□76). Changes made to the image quality and image size settings apply to all shooting modes (except for sport continuous mode and shooting mode **U**).

Selecting Scenes for Shooting (Scene Mode)

Camera settings are automatically optimized for the selected subject type. The following scene modes are available.

Portrait	Beach/snow	Close-up	Copy
Landscape	Sunset	Food	Backlight
Night portrait	Dusk/dawn	Museum	Backlit scene HDR
Party/indoor	Night landscape	Fireworks show	Panorama assist

Setting the Scene Mode

1 Rotate the mode dial to **SCENE**.

- The camera enters scene mode. The default setting is (portrait).

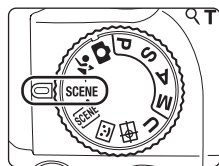

2 Press the **MENU** button to display the scene menu screen, choose the desired scene with the multi-selector and press the **OK** button.

- Switch to the tab when the scene menu is not displayed (13).

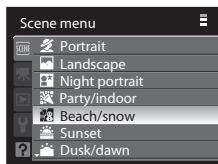

3 Frame the subject and take the picture.





- For scene modes that use the flash, be sure to press the (flash pop-up) button to raise the built-in flash before shooting.



Image Quality and Image Size

If you press the **MENU** button to display the (scene) menu, you can set **Image quality** (75) and **Image size** (76). Changes made to the image quality and image size settings apply to all shooting modes (except for sport continuous mode and shooting mode **U**).

Features

The following icons are used for descriptions in this section: = flash mode when the built-in flash is raised ([134](#)); =self-timer ([137](#)); = focus mode ([138](#)); =exposure compensation ([141](#)).

Portrait

NR

Use this mode for taking portraits in which the main subject stands out clearly.

- The camera automatically detects and focuses on a face (see “Shooting with Face Priority” ([191](#)) for more information).



- If the camera detects multiple faces, the camera focuses on the face closest to the camera.
- After the skin softening feature makes the subject's skin appear smoother (up to three people), record the image ([156](#)).
- If no face is recognized, the camera will focus on the subject in the center of the frame.
- Digital zoom is not available.



* Other settings can be selected.

Landscape

NR

Use this mode for vivid landscapes and cityscapes.

- Camera focuses at infinity. When the shutter-release button is pressed halfway, the focus area or focus indicator ([18](#)) always lights green; however, objects in the foreground may not always appear in focus.
- AF-assist illuminator ([163](#)) does not light.



1 Self-timer is available.

2 Other settings can be selected.

NR: Indicates pictures shot in this scene mode are processed automatically to reduce noise, and therefore may take more time to save.

Night portrait



Use this mode for portraits of a human subject shot in front of background lighting at night. Flash is used to illuminate the subject while maintaining the mood of the background.

- Shoot pictures with the built-in flash raised.
- The camera automatically detects and focuses on a face (see “Shooting with Face Priority” (□□91) for more information).
- If the camera detects multiple faces, the camera focuses on the face closest to the camera.
- After the skin softening feature makes the subject’s skin appear smoother (up to three people), record the image (□□56).
- If no face is recognized, the camera will focus on the subject in the center of the frame.
- Digital zoom is not available.



	 ¹		Off ²		AF		0.0 ²
---	--	---	------------------	---	----	---	------------------

1 Fill flash with slow sync and red-eye reduction.

2 Other settings can be selected.

Party/indoor

Suitable for taking pictures in parties. Captures the effects of candlelight and other indoor background lighting.

- The camera focuses on the subject in the center of the frame.
- Hold the camera steadily as pictures are easily affected by camera shake. When shooting under low lighting, use of a tripod is recommended. Set **Vibration reduction** (□□160) to **Off** when using a tripod to stabilize the camera during shooting.



	 ¹		Off ²		AF		0.0 ²
---	--	---	------------------	---	----	---	------------------

1 May automatically switch to slow sync with red-eye reduction. Other settings can be selected.

2 Other settings can be selected.

: Indicates a tripod is recommended when using this scene mode. Turn **Vibration reduction** (□□160) to **Off** when using a tripod.

: Indicates pictures shot in this scene mode are processed automatically to reduce noise, and therefore may take more time to save.

Shooting Suited for the Scene

Beach/snow

NR

Captures the brightness of such subjects as snowfields, beaches, or sunlit expanses of water.

- The camera focuses on the subject in the center of the frame.



* Other settings can be selected.

Sunset

 **NR**

Preserves the deep hues seen in sunsets and sunrises.

- The camera focuses on the subject in the center of the frame.





* Other settings can be selected.

Dusk/dawn



 **NR**

Preserves the colors seen in the weak natural light before sunrise or after sunset.

- Camera focuses at infinity. When the shutter-release button is pressed halfway, the focus area or focus indicator () always lights green; however, objects in the foreground may not always appear in focus.
- AF-assist illuminator () does not light.



* Other settings can be selected.



: Indicates a tripod is recommended when using this scene mode. Turn **Vibration reduction** () to **Off** when using a tripod.

NR: Indicates pictures shot in this scene mode are processed automatically to reduce noise, and therefore may take more time to save.

Night landscape

NR

This enables you to shoot night landscapes with the minimum of camera shake and noise. When the  icon at the top left of the screen glows green and the shutter-release button is pressed fully, pictures are shot continuously at high speed. The camera combines the shot pictures to save a single picture.

- Camera focuses at infinity. When the shutter-release button is pressed halfway, the focus area or focus indicator ( 8) always lights green. However, because the camera focuses at infinity, it may not be able to focus on nearby objects.
- After pressing the shutter-release button fully, hold the camera steadily until the still picture is displayed. Do not turn off the camera until the monitor display reverts to the shooting display.
- The angle of view (recorded range) of the stored picture is smaller than the visible range in the monitor during shooting.
- Digital zoom is not available.
- AF-assist illuminator ( 163) does not light.















* Other settings can be selected.

Close-up

NR

Photograph flowers, insects and other small objects at close range.

- The focus mode ( 38) setting will be changed to  (macro close-up) and the camera automatically zooms to the position at the closest distance at which the camera can focus.
- The closest shooting distance will vary according to the magnification of the zoom. In the zoom position where the  icon and zoom indicator on the monitor glow green (wide-angle side from the  icon), the camera can focus on subjects as close as about 10 cm (4 in.) from the lens. In the center zoom position between the maximum wide-angle side and the  icon, the camera can focus on subjects as close as about 1 cm (0.4 in.) from the lens.
- **AF area mode** will be changed to **Manual** to enable the focus area to be chosen ( 90). Press the  button and , ,  or  on the multi selector to move the focus area. When the focus area position is set by pressing the  button, the flash mode, self-timer or exposure compensation settings can be adjusted.
- The camera focuses continuously until focus is locked by pressing the shutter-release button halfway.
- As pictures are easily affected by camera shake, be sure that **Vibration reduction** ( 160) is enabled and hold the camera steadily.



- 1 Other settings can be selected. Note that when shooting with the flash, the flash may be unable to light the entire subject at distances of less than 50 cm (1 ft. 8 in.).
- 2 Other settings can be selected.

Shooting Suited for the Scene

Food

Use this mode when taking pictures of food.

- The focus mode (📖38) setting will be changed to 🌸 (macro close-up) and the camera automatically zooms to the position at the closest distance at which the camera can focus.



- The closest shooting distance will vary according to the magnification of the zoom. In the zoom position where the 🌸 icon and zoom indicator on the monitor glow green (wide-angle side from the △ icon), the camera can focus on subjects as close as about 10 cm (4 in.) from the lens. In the center zoom position between the maximum wide-angle side and the △ icon, the camera can focus on subjects as close as about 1 cm (0.4 in.) from the lens.
- You can adjust hue within a slider display at the left of the monitor. Pressing ▲ increases the red hue, and pressing ▼ increases the blue hue. The hue adjustments are stored in the camera's memory even after the camera is turned off.

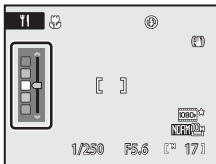

- AF area mode** will be changed to **Manual** to enable the focus area to be chosen (📖90). Press the OK button and ▲, ▼, ◀ or ▶ on the multi selector to move the focus area. When the focus area position is set by pressing the OK button, the hue adjustment, self-timer and exposure compensation settings can be adjusted.
- The camera focuses continuously until focus is locked by pressing the shutter-release button halfway.
- As pictures are easily affected by camera shake, be sure that **Vibration reduction** (📖160) is enabled and hold the camera steadily.



* Other settings can be selected.

Museum

Use indoors where flash photography is prohibited (for example, in museums and art galleries) or in other settings in which you do not want to use the flash.

- The camera focuses on the subject in the center of the frame.
- BSS (Best Shot Selector) (📖86) is used when shooting.
- As pictures are easily affected by camera shake, be sure that **Vibration reduction** (📖160) is enabled and hold the camera steadily.
- AF-assist illuminator (📖163) does not light.





1 Other settings can be selected.

2 🌸 (macro close-up) can be selected.

Fireworks show



Slow shutter speeds are used to capture the expanding burst of light from fireworks.



- Camera focuses at infinity. When the shutter-release button is pressed halfway, the focus area or focus indicator () always lights green; however, objects in the foreground may not always appear in focus.
- Digital zoom is not available.
- AF-assist illuminator () does not light.



Copy



Provides clear pictures of text or drawings on a white board or in print.

- The camera focuses on the subject in the center of the frame.
- Use  (macro close-up) mode () in focus mode with this mode to shoot pictures at close distances.
- Colored text and drawings may not show up well.

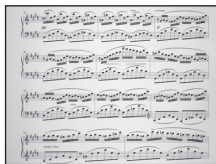

1 Other settings can be selected.

2  (macro close-up) can be selected.



Backlight

Use when light is coming from behind your subject, throwing features or details in shadow. The flash fires automatically to "fill in" (illuminate) shadows.

- Shoot pictures with the built-in flash raised.
- The camera focuses on the subject in the center of the frame.



* Other settings can be selected.

: Indicates a tripod is recommended when using this scene mode. Turn **Vibration reduction** () to **Off** when using a tripod.

: Indicates pictures shot in this scene mode are processed automatically to reduce noise, and therefore may take more time to save.

Shooting Suited for the Scene

Backlit scene HDR

Suitable for shooting landscapes with a large contrast between light and dark. When the shutter-release button is pressed fully, the pictures that were shot continuously at high speed are overlaid, and the following two frames are saved:

- The picture processed with Active D-Lighting (📖95)
 - The picture obtained from HDR (High Dynamic Range) overlay
- The second frame of the recorded pictures will be the one obtained from HDR overlay. When the number of exposures remaining is one frame, only the picture processed with Active D-Lighting is saved.
 - The camera focuses in the center of the frame.
 - The  icon at the top left of the monitor turns green when there is a large contrast between light and dark.
 - After pressing the shutter-release button fully, hold the camera steadily until the still picture is displayed. A longer period of time may be required before the recording is complete. Do not turn off the camera until the monitor display reverts to the shooting display.
 - The angle of view (recorded range) of the stored picture is smaller than the visible range in the monitor during shooting.
 - Digital zoom is not available.



* Other settings can be selected.

Panorama assist



NR



Use when taking a series of pictures that will later be joined to form a single panorama using the supplied Panorama Maker software. See "Taking Pictures for a Panorama" (📖53) for more information.



¹ Other settings can be selected.

²  (macro close-up) or  (infinity) can be selected.

NR: Indicates pictures shot in this scene mode are processed automatically to reduce noise, and therefore may take more time to save.

Taking Pictures for a Panorama





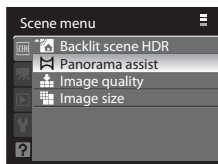

The camera focuses on the subject in the center of the frame. Use a tripod for best results. When the camera is stabilized with a tripod, set **Vibration reduction** (📖160) to **Off** in the setup menu (📖152).

- 1 Use the multi selector to choose  **Panorama assist** from the scene menu and press the **OK** button (📖45).

- The  icon is displayed to show the direction in which pictures will be joined.



- 2 Use the multi selector to choose the direction and press the **OK** button.

- Decide how pictures will be joined together in the completed panorama; right () , left () , up () or down () .
- The yellow panorama direction icon () will move to the direction pressed, so press the **OK** button to choose the direction. A white panorama direction icon () will be displayed in the chosen direction.
- Apply flash mode (📖34), self-timer (📖37), focus mode (📖38) and exposure compensation (📖41) settings with this step, if necessary.
- Press the **OK** button again to reselect the direction.



- 3 Shoot the first picture.

- The picture taken will be displayed in 1/3 of the monitor.

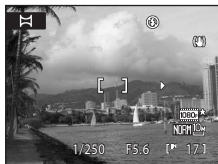

- 4 Shoot the second picture.

- Match the outline of the next picture so that one-third of the frame overlaps on to the previous picture, and press the shutter-release button.
- Repeat until you have taken the necessary number of pictures to complete the image.

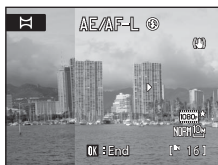

5 Press the **OK** button when shooting is completed.

- The camera returns to step 2.

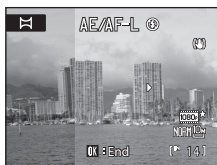

✓ Panorama Assist

- Set flash mode, self-timer, focus mode and exposure compensation before taking the first picture. They cannot be changed after the first picture is taken. Pictures cannot be deleted, nor can zoom, **Image quality** (☰75) or **Image size** settings (☰76) be adjusted after the first picture is taken.
- The panorama series is terminated if the camera enters standby mode with the auto off function (☰165) during shooting. Setting the time allowed to elapse before the auto off function is enabled to a longer time is recommended.

🔍 AE/AF-L (exposure lock) Indicator

When using panorama assist mode, all pictures in the panorama have the same exposure, white balance, and focus as the first picture of the panorama.

When the first picture is shot, **AE/AF-L** is displayed to indicate that exposure, white balance, and focus are locked.

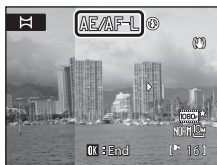

🔍 Panorama Maker

Install Panorama Maker from the supplied Software Suite CD.

Transfer pictures to a computer (☰140) and use Panorama Maker (☰144) to join them in a single panorama.

🔍 More Information

See "File and Folder Names" (☰181) for more information.

Taking Pictures of Smiling Faces (Smart Portrait Mode)



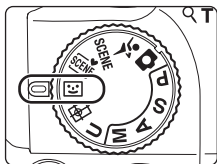

In the default setting, the camera detects smiling faces using face priority and releases the shutter automatically (smile timer function). The skin softening function makes a human subject's skin appear smoother.

1 Rotate the mode dial to (smart portrait).

- The camera enters smart portrait mode.



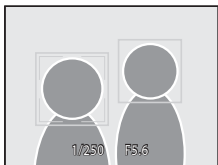

2 Frame the picture.

- Point the camera at the subject.
- When the camera detects a face, the focus area containing the face will be displayed with a yellow double border, and when focus is locked the double border will turn green for a moment.
- Up to three faces can be detected. When more than one face is detected, the face closest to the center of the frame is framed by a double border and the others by single borders.
- When more than one face is detected, press the  button to choose on which face to focus. Press   on the multi selector to choose the face on which to focus and press the  button.



3 The shutter is automatically released.

- If the camera detects that the face framed by the double border is smiling, the **Smile timer** function ( 57) automatically releases the shutter. When the flash does not fire, the shutter is released five times each time a picture is taken, and the picture in which the most people have smiles is saved. When the camera detects a face, the self-timer lamp ( 4) blinks. Immediately after the shutter is released, the self-timer lamp flickers. Each time the shutter is released, the camera repeats automatic shooting by face priority and smile detection.
- The shutter can also be released by pressing the shutter-release button. If no face is detected, the camera focuses on the subject in center of frame.
- When the shutter is released, the camera makes the subject's skin appear smoother, then records the image (**Skin softening** ( 57)).

4 Finish shooting.

- To finish automatic shooting of smiling faces, either turn the camera off, set **Smile timer** to **Off**, or rotate the mode dial to select another shooting mode.

Notes on Smart Portrait Mode

- Digital zoom is not available.
- Under some shooting conditions, faces and smiling faces may not be detected properly.
- See "Notes on Face Priority" (📖92) for more information.

Notes on Skin Softening

- When taking pictures with skin softening, the time required to save the pictures increases slightly.
- Depending on shooting conditions, even if the camera detects a face on the monitor at the time of shooting, effects of the skin softening function may not be visible, and areas other than the face may be processed. If the desired effect is not achieved, set **Skin softening** to **Off** and shoot again.
- The extent of skin softening effect that is applied cannot be set while using the **Portrait** or **Night portrait** scene modes.
- Skin softening can also be applied to pictures after they have been taken (📖122).

Auto Power Off When Using Smile Timer (Standby Mode)

When **Smile timer** is set to **On**, the auto off function (📖165) will turn the camera off in the following situations if no operations are performed.

- The camera is unable to detect any face.
- The camera has detected one or more faces, but is unable to detect a smiling face.

Functions Available in Smart Portrait Mode

- Flash mode is disabled when **Blink proof** is set to **On**. Flash mode (📖34) will be changed to **⚡AUTO** (auto) when **Blink proof** is set to **Off** (other settings can be selected).
- Exposure compensation (📖41) can be adjusted.
- If **Smile timer** is set to **Off**, self-timer (📖37) can be set.
- The focus mode is fixed to **AF** (autofocus).
- If you press the **MENU** button to display the  (smart portrait) menu, you can change the settings for **Image quality**, **Image size**, **Skin softening**, **Smile timer**, or **Blink proof**.

More Information

See "Autofocus" (📖31) for more information.

Smart Portrait Menu

Press the **MENU** button (📖13) to display the smart portrait menu and use the multi selector (📖12) to modify and apply settings. The following options are available. Switch to the 😊 tab when the smart portrait menu is not displayed (📖13).

- **Smile timer** and **Blink proof** cannot be used simultaneously.

Image quality

Image quality (📖75) settings can be changed. Changes made to the image quality setting apply to all shooting modes (except for sport continuous mode and shooting mode **U**).

Image size

Image size (📖76) settings can be changed. Changes made to the image size setting apply to all shooting modes (except for sport continuous mode and shooting mode **U**).

Skin softening

Set skin softening. When the shutter is released, the camera detects up to three faces and processes the image to make the faces appear smoother, then records the image.

The effect of this feature can be set to **High**, **Normal** (default setting), and **Low**. When **Off** is selected, skin softening is turned off.

- When skin softening is enabled, the icon for the current setting is displayed in the monitor during shooting (📖8). When **Off** is selected, an icon for the current setting is not displayed. Additionally, the effects of the current skin softening setting cannot be previewed in the monitor while shooting. To confirm, view the pictures after shooting.

Smile timer

- **On** (default setting): Among the detected faces, if a smile is detected on the face that is framed by a double border, the camera automatically releases the shutter. When the flash does not fire, the shutter is released five times each time a picture is taken, and the picture in which the most people have smiles is saved.
- **Off**: The camera does not release the shutter automatically using smile timer; the shutter is only released when the shutter-release button is pressed.
- When smile timer is enabled, the current setting is displayed during shooting (📖8). When **Off** is selected, an icon for the current setting is not displayed.

Blink proof

When set to **On**, the shutter is released five times as the shutter-release button is fully pressed once; the camera chooses one image in which the subjects' eyes are open, and saves it.

- The message on the right will be displayed for a few seconds when the camera records an image in which someone may have been blinking.
- When **Blink proof** is turned **On**, **Smile timer** is turned **Off**. Press the shutter-release button to release the shutter.
- When set to **On**, the flash cannot be used.
- The default setting is **Off**.
- When blink proof is enabled, the current setting is displayed during shooting (📷). When **Off** is selected, an icon for the current setting is not displayed.

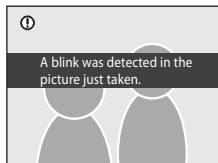

Focusing on a Moving Subject in Subject Tracking Mode



Use this mode to shoot moving subjects. Subject tracking begins once you select a subject to be focused on, and the focus area will move and follow the subject.

1 Rotate the mode dial to (subject tracking).

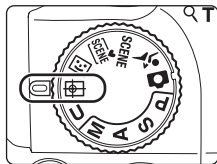
- The camera enters subject tracking mode, and a white border is displayed in the center of the frame.



2 Select a subject.

- Frame the subject in the center of the border, and press the  button.
 - The subject is registered.
 - When the camera is unable to focus on the subject, the border will glow red. Change the composition and try again.
- Once the subject is registered, it is framed by a yellow focus area display, and subject tracking begins.
- To change subjects, press the  button to cancel the currently selected subject, then select a new subject.
- If the camera loses sight of the subject, the focus area display disappears; register the subject again.

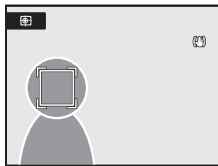
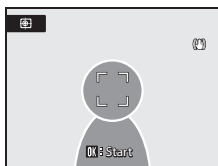



3 Press the shutter-release button to take the picture.

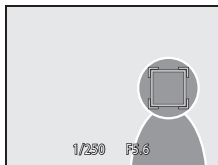



- If the camera focuses on the focus area when the shutter-release button is pressed halfway, the focus area display turns green and the focus is locked.
- If the camera is unable to focus, the focus area display will blink. Press the shutter-release button halfway again to focus.
- If the shutter-release button is pressed halfway while the focus area display is not displayed, the camera focuses at the center of the frame.
- Press the shutter-release button the rest of the way down to take the picture.



Subject Tracking Mode

- Digital zoom is not available.
- Set the zoom position, flash mode, exposure compensation, and menu before registering a subject. If any of these are changed after a subject is registered, the subject will be canceled.
- During certain conditions, such as when the subject is moving quickly, when there is a large amount of camera shake, or when there are multiple subjects that look alike, the camera may not be able to register or track a subject, or the camera may track a different subject. Additionally, the subject may not be tracked properly depending on factors such as the subject's size and brightness.
- In some rare cases when shooting subjects for which autofocus may not perform as expected (31), the subject may not appear in focus despite the fact that the focus area display glows green. Should this occur, switch to auto mode or set **AF area mode** (90) to **Manual** or **Center** in shooting modes **P**, **S**, **A**, **M** or **U**, refocus on another subject positioned at the same distance from the camera as the actual portrait subject, and use focus lock (31).

Usable Functions in Subject Tracking Mode

- Flash mode (34) and exposure compensation (41) settings can be adjusted.
- Self-timer cannot be used.
- The focus mode is fixed to **AF** (autofocus).
- Press the **MENU** button to display the  (subject tracking) menu and change the settings for **Image quality**, **Image size**, or **Autofocus mode** (61).

Subject Tracking Menu

Press the **MENU** button (📖13) to display the subject tracking menu and use the multi selector (📖12) to modify and apply settings. The following options are available.

Switch to the  tab when the subject tracking menu is not displayed (📖13).

Image quality

Image quality (📖75) settings can be changed. Changes made to the image quality setting apply to all shooting modes (except for sport continuous mode and shooting mode **U**).

Image size

Image size (📖76) settings can be changed. Changes made to the image size setting apply to all shooting modes (except for sport continuous mode and shooting mode **U**).

Autofocus mode

Allows you to set the **Autofocus mode** (📖93) used for subject tracking mode (the default setting is **Full-time AF**).

When using subject tracking mode while set to **Full-time AF**, the camera continuously focuses until the shutter-release button is pressed halfway to lock the focus. The sound of the camera focusing will be heard.

Changes made to the autofocus mode setting in this mode will not be applied to the autofocus mode setting in shooting modes **P**, **S**, **A**, **M** and **U**. The autofocus mode setting applied in subject tracking mode is stored in the camera's memory even after the camera is turned off.

Shooting with a High-Speed Burst (Sport Continuous Mode)

Sport continuous mode allows the split-second movements of high-speed moving subjects to be captured through continuous shooting.

- The image size is fixed to **1600x1200** or **1280x960** (📖64).
- The ISO sensitivity is set automatically within the range of ISO 160 to 3200.
- The focus, exposure, and white balance settings are fixed at the values for the first picture in each series.

1 Rotate the mode dial to (sport continuous).

- The camera enters sport continuous mode.

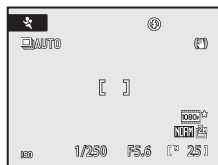

2 Press the MENU button and confirm or change the continuous shooting setting.

- See “Sport Continuous Menu” (📖64) for more information.
- Switch to the tab when the sport continuous menu is not displayed (📖13).
- Once the configuration is complete, press the MENU button to return to the shooting screen. Pressing the shutter-release button also returns to the shooting screen.

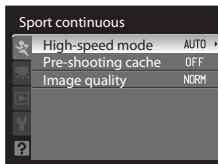

3 Frame the subject and shoot.

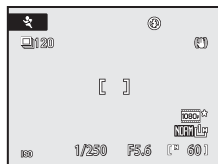

- The camera focuses on the subject in the center of the frame. Pressing the shutter-release button halfway sets the focus and exposure.
- When **High-speed mode** is set, press the shutter-release button fully to shoot continuously a number of frames that is appropriate for the setting. You do not need to hold down the shutter-release button.
- When Pre-shooting cache is set, press the shutter-release button fully and hold it down to shoot frames continuously (up to 25 frames).
- When shooting is finished, monitor display reverts to shooting mode. If the icon is displayed, do not turn off the camera.



Notes on Sport Continuous Shooting

- A longer period of time may be required before the recording is complete. The time taken until recording ends may vary, depending upon the amount of frames taken, image quality setting and the write speed of the memory card used.
- If the ISO sensitivity is raised for shooting, the shot pictures may be grainy.
- In clear sunlight, the correct exposure may not be obtained (overexposure).
- When shooting under lights that flicker at high speed such as fluorescent, mercury-vapor or sodium-vapor lamps, banding on the picture or variations in monitor brightness and hue may occur.

Functions Available in Sport Continuous Mode

- The flash and self-timer are not available.
- Exposure compensation (📖41) settings can be adjusted.
- Focus mode (📖38) settings can be adjusted. When **AF** (autofocus) (default setting) or  (macro close-up) is set in sport continuous mode, full-time AF (📖93) is set.
- AF-assist illuminator (📖163) does not light.
- When the **MENU** button is pressed to display the  (sport continuous) menu, the settings for **High-speed mode**, **Pre-shooting cache** or **Image quality** can be adjusted (📖64).

More Information

- See “Autofocus” (📖31) for more information.
- See “Viewing Continuously Shot Pictures (Pictures in a sequence)” (📖102) for more information.

Sport Continuous Menu

Press the **MENU** button (📖13) to display the sport continuous menu, and then use the multi selector (📖12) to change the settings. The following options are available.

Switch to the 📷 tab when the sport continuous menu is not displayed (📖13).

- **High-speed mode** and **Pre-shooting cache** cannot be set simultaneously.

High-speed mode

Choose the sport continuous shooting type.

Option	Description
Continuous H: auto (default setting)	Frame rate: Maximum 60 fps Number of continuously shot frames: 25 frames Image size: 📷 1600×1200 fixed <ul style="list-style-type: none"> • The frame rate varies depending on the brightness of the subject at the start of shooting. In dark conditions, the shutter speed decreases (1 second maximum), and the frame rate slows down.
Continuous H: 120 fps	Frame rate: Approx. 120 fps Number of continuously shot frames: 60 frames Image size: 📷 1280×960 fixed <ul style="list-style-type: none"> • Shoots 60 frames continuously at a high speed of about 1/120 second or faster.
Continuous H: 60 fps	Frame rate: Approx. 60 fps Number of continuously shot frames: 25 frames Image size: 📷 1600×1200 fixed <ul style="list-style-type: none"> • Shoots 25 frames continuously at a high speed of about 1/60 second or faster.

Pre-shooting cache

When the pre-shooting cache is used, it improves the chance of capturing a good picture. Up to five frames are recorded just before the shutter-release button is pressed down fully. The camera starts shooting when the shutter-release button is pressed down halfway, and shoots pictures continuously when the button is then pressed down fully (📖65).

The shooting ends when the shutter-release button is released or 25 frames have been shot continuously.

- Frame rate: Maximum 15 fps
- Number of continuously shot frames: Up to 25 frames (including a pre-shooting cache of up to five frames)
- Image size: 📷 **1600×1200** fixed

Image quality

Image quality (📖75) settings can be changed. This is stored in the camera's memory independently and is not applied to the settings in any other shooting mode.

Pre-shooting Cache

When pre-shooting cache is set to **On**, shooting starts when the shutter-release button is pressed down halfway for 0.5 seconds or more, and images that were shot just before the shutter-release button is pressed down fully can be saved as part of the continuously shot frames. Up to five frames can be recorded in the pre-shooting cache.

When pre-shooting cache is enabled, the current setting is displayed during shooting (8). When **Off** is selected, an icon for the current setting is not displayed. When the shutter-release button is pressed down halfway, the pre-shooting cache icon changes to green.

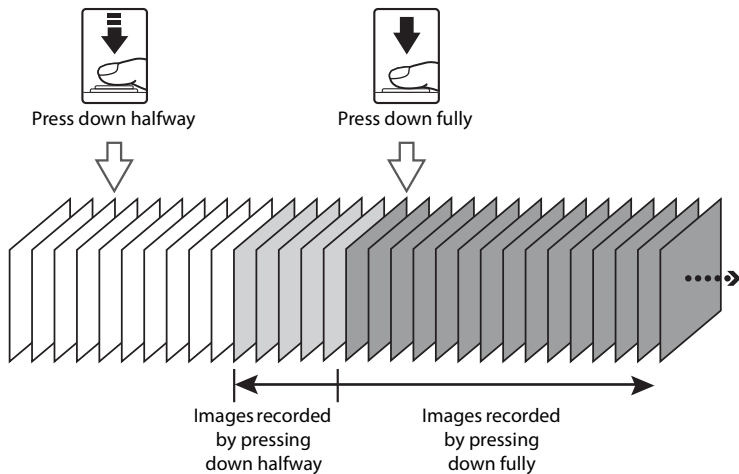

- Check the number of exposures remaining before starting to shoot. Having 25 or more exposures remaining in the memory is recommended when shooting. A pre-shooting cache cannot be recorded when the number of exposures remaining is five or less.

Setting the Exposure for Shooting (P, S, A, M Modes)

P, S, A, M Modes

By rotating the mode dial, you can shoot pictures in the following four exposure modes: **P** (programmed auto), **S** (shutter-priority auto), **A** (aperture-priority auto), and **M** (manual). In addition to allowing you to set the shutter speed and aperture yourself, these modes offer control over a variety of advanced settings such as changing the ISO sensitivity and white balance in the shooting menu (📖73).

Mode	Description	Usage
P Programmed auto (📖68)	Camera sets the shutter speed and aperture automatically for optimal exposure. Flexible program, which changes the combination of shutter speed and aperture, can be used (📖68).	Recommended for most situations.
S Shutter-priority auto (📖69)	User chooses shutter speed; camera selects aperture automatically.	Use to shoot fast moving subjects using a fast shutter speed, or use to emphasize the movements of a moving subject using a slow shutter speed.
A Aperture-priority auto (📖70)	User chooses aperture; camera selects shutter speed automatically.	Use to blur background or bring both foreground and background into focus.
M Manual (📖71)	User controls both shutter speed and aperture.	Use to control exposure according to shooting requirements.

Settings that are frequently used for **P**, **S**, **A** and **M** shooting modes can be saved in mode dial **U**. Rotating the mode dial to **U** enables you to shoot pictures using the saved settings that are used frequently (📖98).

Functions Available in P, S, A and M Modes

- The flash mode (📖34) can be changed, and the self-timer (📖37), focus mode (📖38) and exposure compensation (📖41) settings can be adjusted.
- Press the **MENU** button to adjust the shooting menu (📖73) settings.

Shutter Speed and Aperture

The same exposure can be achieved with different combinations of shutter speed and aperture, allowing you to freeze or blur motion and control depth of field. The following figure shows how shutter speed and aperture affect exposure. When the ISO sensitivity setting (☰84) is changed, the range of shutter speeds and aperture values at which the correct exposure can be obtained also changes.

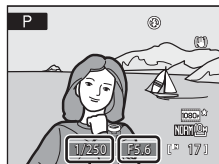

Shutter speed Aperture



Fast shutter speed:
1/1000 s



Slow shutter speed:
1/30 s



Large aperture
(small f-number):
f/2.8



Small aperture
(large f-number):
f/8.0

P (Programmed Auto) Mode

Shoot pictures with shutter speed and aperture value set automatically by the camera.

1 Rotate the mode dial to **P**.

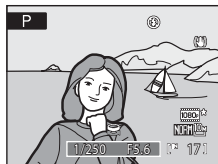

2 Frame the subject and shoot.

- At the default setting, the camera automatically selects the focus area (one of nine) containing the subject closest to the camera. When the subject is in focus, the focus area (active focus area) glows green (maximum of nine areas) (📖90).



Flexible Program

In mode **P**, different combinations of shutter speed and aperture can be selected by rotating the command dial ("flexible program"), without changing the exposure. While flexible program is in effect, an asterisk (*****) appears next to the mode indicator (**P**) in the monitor.

- Rotate the command dial to the right for large apertures (small f-numbers) when you want to blur background details, or for fast shutter speeds to capture fast-moving subjects.
- Rotate the command dial to the left for small apertures (large f-numbers) when you want to increase depth of field, or for slow shutter speeds to emphasize the motion of a subject.
- To restore default shutter speed and aperture settings, rotate the command dial until the ***** asterisk next to the mode indicator is no longer displayed. Selecting another mode, or turning off the camera, also restores default shutter speed and aperture settings.

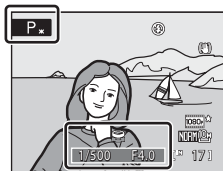
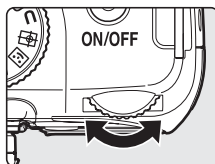

✓ Notes on Shutter Speed

- When the ISO sensitivity (📖84) is ISO 3200, the slowest shutter speed is restricted to one second.
- When **Multi-shot 16** is selected for the **Continuous** setting (📖86), the slowest shutter speed is restricted to 1/30 second.

S (Shutter-Priority Auto) Mode

Set the shutter speed and shoot pictures.

1 Rotate the mode dial to S.

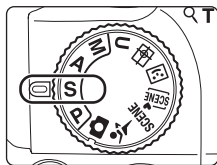

2 Rotate the command dial to choose the shutter speed value between 1/2000 second and eight seconds.

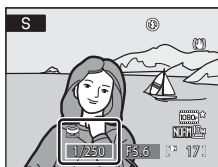

3 Focus and shoot.

- At the default setting, the camera automatically selects the focus area (one of nine) containing the subject closest to the camera. When the subject is in focus, the focus area (active focus area) glows green (maximum of nine areas) (📖90).



✓ S (Shutter-Priority Auto) Mode

- If the selected shutter speed would result in the picture being over- or underexposed, the shutter speed display will flash when the shutter-release button is pressed halfway. Choose another shutter speed and try again.
- At shutter speeds of 1/4 second or slower, "noise" may appear in the image in the form of randomly spaced, brightly colored dots. In such situations, the shutter speed indicator will turn red. Setting **Noise reduction** (📖94) to **On** is recommended.

✓ Notes on Shutter Speed

- When the ISO sensitivity (📖84) is ISO 800, the slowest shutter speed is restricted to four seconds, when ISO 1600, restricted to two seconds, and when ISO 3200, restricted to one second.
- When **Multi-shot 16** is selected for the **Continuous** setting (📖86), the slowest shutter speed is restricted to 1/30 second.

A (Aperture-Priority Auto) Mode

Set the aperture value and shoot pictures.

1 Rotate the mode dial to **A**.

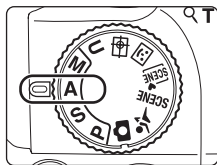

2 Rotate the command dial to choose the aperture value (f/-number).

- When the camera is zoomed all the way out, aperture can be set to values between f/2.8 and f/8.0; at maximum zoom, aperture can be set to values between f/5.0 and f/8.0.

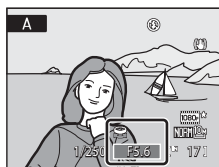

3 Focus and shoot.

- At the default setting, the camera automatically selects the focus area (one of nine) containing the subject closest to the camera. When the subject is in focus, the focus area (active focus area) glows green (maximum of nine areas) (📖90).

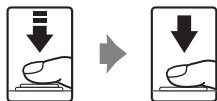

✓ **A (Aperture-Priority Auto) Mode**

If the selected aperture would result in the picture being over- or underexposed, the aperture display will flash when the shutter-release button is pressed halfway. Choose another aperture value and try again.

✓ **Notes on Shutter Speed**

- When the ISO sensitivity (📖84) is ISO 800, the slowest shutter speed is restricted to four seconds, when ISO 1600, restricted to two seconds, and when ISO 3200, restricted to one second.
- When **Multi-shot 16** is selected for the **Continuous** setting (📖86), the slowest shutter speed is restricted to 1/30 second.

📷 **Aperture and Zoom**

Aperture is expressed as an f-number, which is the ratio of the focal length of the lens to the effective diameter of the opening (aperture) through which light enters the camera. Large apertures (expressed by small f-numbers) let more light into the camera, and small apertures (large f-numbers) let less light. This camera has a lens with a focal length of 4.6-120 mm and an aperture of f/2.8 to f/5. When the camera is zoomed out, the f-number decreases. When the camera is zoomed in, the f-number increases.

M (Manual) Mode

Set the shutter speed and aperture value, and shoot pictures.

1 Rotate the mode dial to **M**.

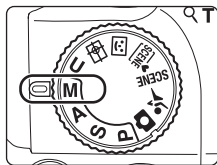

2 Press the multi selector to activate the shutter speed setting.

- The active setting switches between shutter speed and aperture each time the multi selector  is pressed.
- At shutter speeds of 1/4 second or slower, the shutter speed indicator turns red (see page 69).

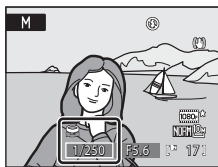

3 Rotate the command dial to choose the shutter speed value between 1/2000 second and eight seconds.

- When adjusting aperture or shutter speed, the degree of deviation from the exposure value measured by the camera is displayed for a few seconds in the exposure display.
- The degree of deviation in the exposure display is shown in EVs (-2 to +2 EV in increments of 1/3 EV).
A display similar to that illustrated at right indicates that the picture will be overexposed by 1 EV (+1).

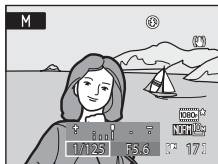

← Overexposed Underexposed →

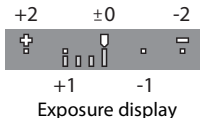

4 Press the multi selector to activate the aperture setting.

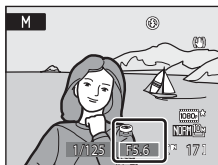

5 Rotate the command dial to choose an aperture value.

- Repeat steps 2 to 5 to modify shutter speed and aperture settings until the desired exposure is achieved.

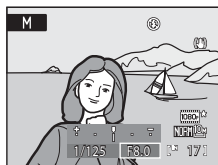

6 Focus and shoot.

- At the default setting, the camera automatically selects the focus area (one of nine) containing the subject closest to the camera. When the subject is in focus, the focus area (active focus area) glows green (maximum of nine areas) (□90).



✓ Notes on Shutter Speed







- When the ISO sensitivity (□84) is ISO 800, the slowest shutter speed is restricted to four seconds, when ISO 1600, restricted to two seconds, and when ISO 3200, restricted to one second.
- When **Multi-shot 16** is selected for the **Continuous** setting (□86), the slowest shutter speed is restricted to 1/30 second.

✓ Note on ISO Sensitivity

When **ISO sensitivity** (□84) is set to **Auto** (default setting), **High ISO sensitivity auto**, or **Fixed range auto**, ISO sensitivity will be fixed at ISO 160.

Shooting Options: Shooting Menu (P, S, A, M Modes)

While shooting in **P, S, A, M** and **U** (📖98), the shooting menu contains the following options.

	Image quality 📖75
	Choose the image quality (compression ratio) of recorded pictures. This can also be set in the menus of another shooting mode.
	Image size 📖76
	Choose the image size of recorded pictures. This can also be set in the menus of another shooting mode (except for sport continuous mode).
	Optimize image 📖79
	Change the settings for optimizing images according to the shooting scene or your preferences.
WB	White balance 📖82
	Match white balance to the light source to produce images with natural-looking colors.
ISO	ISO sensitivity 📖84
	Modify the camera's sensitivity to light according to the brightness of the subject.
	Metering 📖85
	Choose how the camera meters exposure.
	Continuous 📖86
	Change settings for Continuous (continuous shooting) and BSS (Best Shot Selector), etc.
BKT	Auto bracketing 📖89
	Vary exposure slightly over a burst of pictures.
[+]	AF area mode 📖90
	Choose how the focus area is determined.
	Autofocus mode 📖93
	Choose how the camera focuses.
	Flash exp. comp. 📖93
	Adjust flash level.
NR	Noise reduction 📖94
	Reduce noise in pictures shot at slow shutter speeds.
	Distortion control 📖94
	Choose whether to correct the peripheral distortion that occurs due to the intrinsic characteristics of lenses.
	Active D-Lighting 📖95
	Prevent loss of contrast detail in highlights and shadows when shooting images.

- U** Save user settings 📖99
 Save the current edited settings into the mode dial **U**.
- U** Reset user settings 📖100
 Reset the saved settings in **U** back to the default settings.

Displaying the Shooting Menu

Choose **P** (Programmed auto), **S** (Shutter-priority auto), **A** (Aperture-priority auto), **M** (Manual) or **U** (User settings) by rotating the mode dial. Press the **MENU** button and switch to the **P, S, A, M** or **U** tab to display the shooting menu (📖13).

More on Shooting

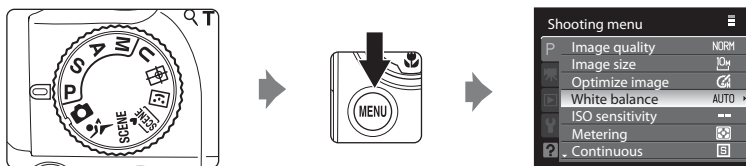

- Press the multi selector to select items and set functions on menus (📖12).
- Press the **MENU** button to exit the shooting menu.

✔ Functions that Cannot be Applied Simultaneously

Some functions cannot be enabled in conjunction with others (📖96).

✎ Navigating the Camera Menu

The command dial can also be used in place of pressing ▲ or ▼ on the multi selector.

Image Quality

Set to **P, S, A** or **M** → MENU → **P, S, A, M** (shooting menu) (📖74) → Image quality

Choose the amount of compression applied to pictures.

Lower compression ratios result in higher quality pictures, but also larger file sizes, limiting the number of pictures that can be recorded.

FINE Fine

Fine quality images (compression ratio of 1:4), suitable for enlargement or high quality prints.

NORM Normal (default setting)

Normal image quality (compression ratio of 1:8), suitable for most applications.

BASIC Basic

Basic image quality (compression ratio of 1:16), suitable for pictures that will be distributed by e-mail or used in web pages.

The icon for the current setting is displayed in the monitor in shooting and playback modes (📖8 to 10).

Notes on the Image Quality Setting

- Changes made to the image quality setting apply to all shooting modes (except for sport continuous mode and shooting mode **U**).
- Use the sport continuous menu to change the image quality setting for sport continuous mode (📖64).

More Information

- See “Number of Exposures Remaining” (📖77) for more information.
- See “Functions that Cannot be Applied Simultaneously” (📖96) for more information.

















Image Size

Set to **P**, **S**, **A** or **M** → MENU → **P**, **S**, **A**, **M** (shooting menu) (☞74) → Image size

Choose the size of pictures in pixels for recording.



Pictures shot at smaller sizes require less memory, making them suited to distribution by e-mail or the web.

Conversely, the larger the image, the larger the size at which it can be printed or displayed without becoming noticeably “grainy,” limiting the number of pictures that can be recorded.

Image size	Description
 3648×2736 (default setting)	Record pictures exhibiting greater detail than those shot at  3264×2448 or  2592×1944.
 3264×2448	Good balance between file size and quality makes this the best choice in most situations.
 2592×1944	
 2048×1536	Smaller than  3648×2736,  3264×2448 and  2592×1944 for recording more pictures.
 1600×1200	
 1280×960	
 1024×768	Record pictures of a size suitable for display on devices such as a computer monitor.
 640×480	Record pictures suitable for display on a television with a screen aspect ratio of 4:3, or for e-mail attachment.
 3648×2432	Record pictures with the same aspect ratio (3:2) as those shot with 35 mm film cameras.
 3584×2016	Record pictures with the same aspect ratio (16:9) as wide-screen televisions.
 2736×2736	Record perfectly square pictures.











The icon for the current setting is displayed in the monitor in shooting and playback modes (☞8 to 10).

Notes on the Image Size Setting

- Changes made to the image size setting apply to all shooting modes (except for sport continuous mode and shooting mode **U**).
- For sport continuous mode, the image size is fixed to  1600×1200 or  1280×960 (☞64).
- This feature cannot be used simultaneously with certain features. See “Functions that Cannot be Applied Simultaneously” (☞96) for more information.

Number of Exposures Remaining

The following table lists the approximate number of pictures that can be stored in internal memory and on a 4 GB memory card, at each combination of **Image size** (□□76) and **Image quality** (□□75) settings. Note that the number of images that can be stored will differ depending on the composition of the image (due to JPEG compression). In addition, this number may differ depending on the make of memory card, even if the capacity for the memory card is the same.

Image size	Image quality	Internal memory (43 MB)	Memory card ¹ (4 GB)	Print size ² (cm/in.)
 3648×2736 (default setting)	Fine	8	775	31×23/12×9
	Normal	17	1545	
	Basic	34	3015	
 3264×2448	Fine	11	970	28×21/11×8
	Normal	21	1915	
	Basic	42	3655	
 2592×1944	Fine	17	1525	22×16/8.5×6.5
	Normal	33	2940	
	Basic	63	5485	
 2048×1536	Fine	27	2410	17×13/7×5
	Normal	52	4640	
	Basic	98	8620	
 1600×1200	Fine	43	3770	14×10/5×4
	Normal	83	7100	
	Basic	144	12000	
 1280×960	Fine	65	5745	11×8/4×3
	Normal	119	10000	
	Basic	196	17000	
 1024×768	Fine	98	8620	9×7/3.5×2.5
	Normal	171	15000	
	Basic	275	24000	
 640×480	Fine	196	17000	5×4/2×1.5
	Normal	305	24000	
	Basic	458	40000	
 3648×2432	Fine	10	870	31×21/12×8
	Normal	19	1720	
	Basic	38	3350	
 3584×2016	Fine	12	1065	30×17/12×6.5
	Normal	24	2115	
	Basic	46	4020	
 2736×2736	Fine	11	1030	23×23/9×9
	Normal	23	2045	
	Basic	45	3890	

Shooting Options: Shooting Menu (**P**, **S**, **A**, **M** Modes)

- 1 If the number of exposures remaining is 10,000 or more, the number of exposures remaining display shows "9999".
- 2 Print size at an output resolution of 300 dpi.
Print sizes are calculated by dividing the number of pixels by printer resolution (dpi) and multiplying by 2.54 cm (1 in.). However, even with the same image size setting, images printed at higher resolutions will print smaller than the size indicated, and those printed at lower resolutions will print larger than the size indicated.



Printing Images of Size 1:1

Change the printer setting to "Border" when printing images of size set to 1:1.

The images may not be printed in 1:1 ratio depending on the printer.

See the instruction manual of the printer or check with the authorized print dealer for further details.

Optimize Image

Set to **P, S, A** or **M** → MENU → **P, S, A, M** (shooting menu) (📖74) → Optimize image

Change the settings for optimizing images according to the shooting scene or your preferences. Contrast, saturation, sharpening, and other settings can be adjusted in detail.

Normal (default setting)

Standard image optimization; recommended in most situations.

Softer

Softens outlines, producing natural results suitable for portraits or retouching on a computer.

Vivid

Enhances saturation and produces vibrant reds and greens. Images will become sharp and slightly high in contrast.

More vivid

Maximizes saturation, contrast, and sharpness to produce crisp images with sharp outlines.

Portrait

Lowers contrast while lending natural texture and rounded feel to skin of portrait subjects.

Custom

Customize image optimization settings (📖80).

Black-and-white

Shoot photos in black and white or sepia (📖81).

At settings other than **Normal**, the indicator for the current optimize image setting is displayed in the monitor during shooting (📖8).

Optimize Image

- If the optimize image setting is set to **Normal**, **Softer**, **Vivid**, **More vivid**, **Portrait** or **Standard** or **Black-and-white**, results will vary with exposure and the position of the subject in the frame even if shooting conditions remain the same. For consistent results over a series of photographs, select **Custom** and choose a setting other than **Auto** for contrast, sharpening, and saturation.
- This feature cannot be used simultaneously with certain features. See “Functions that Cannot be Applied Simultaneously” (📖96) for more information.

Customizing Image Enhancement Options: Custom

Select **Custom** to make separate adjustments to the following options.

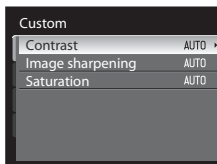

Contrast

Control contrast.

Lower settings prevent loss of detail in highlights under harsh lighting or in direct sunlight. Higher settings preserve detail in misty landscapes and other low-contrast subjects.

The default setting is **Auto**.

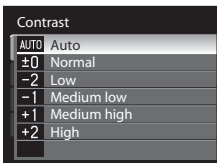
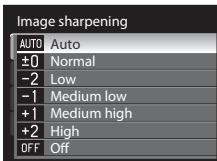

Image sharpening

Choose how much outlines are sharpened during shooting.

Choose high settings for sharp outlines, low settings for softer outlines.

The default setting is **Auto**.



Saturation

Control the vividness of colors.

Choose moderate for less saturated colors, enhanced for more vivid colors.

The default setting is **Auto**.

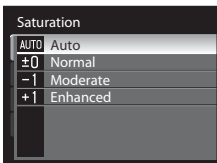

Note on Image Sharpening

The effects of image sharpening cannot be previewed in the monitor during shooting. Check results in playback mode.

Shooting in Black-and-White

When **Black-and-white** is selected, the options described below are available.

- Choose **Standard** to shoot in basic black-and-white.
- Choose **Custom** to manually adjust **Contrast**, **Image sharpening**, and **Monochrome filter** effects.
- When the **B&W + color** option is enabled (✓), one black-and-white picture and the same picture in full color are recorded simultaneously.

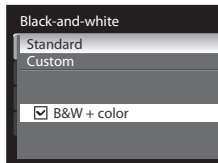

The following options can be adjusted in **Custom**.

Contrast

Same as **Optimize image** → **Custom** → **Contrast** (📖80).

Image sharpening

Same as **Optimize image** → **Custom** → **Image sharpening** (📖80).

Monochrome filter

This effect simulates black-and-white photography with a color filter.

- **Yellow, Orange, Red:**

Enhance contrast. Can be used to tone down the brightness of the sky in landscape photographs. Orange filter results in greater contrast than yellow filter, and red filter greater contrast than orange filter.

- **Green:**

Softens skin tones. Suitable for portraits.

- **Sepia:**

Adds a sepia color tone to make it look like an old picture.

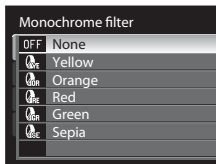

B&W + Color

Color pictures recorded when B&W + color is enabled are the same as those shot at an optimize image setting of **Normal**.

WB White Balance

Set to **P, S, A** or **M** → MENU → **P, S, A, M** (shooting menu) (📖74) → White balance

The color of light reflected from an object varies with the color of the light source. The human brain is able to adapt to changes in the color of the light source, with the result that white objects appear white whether seen in the shade, direct sunlight, or under incandescent lighting. Digital cameras can mimic this adjustment of the human eye by processing images according to the color of the light source. This is known as “white balance.” For natural coloration, choose a white balance setting that matches the light source before shooting. Although the default setting, **Auto**, can be used under most types of lighting, you can apply the white balance setting suited to a particular light source to achieve more accurate results.

AUTO Auto (default setting)

White balance automatically adjusted to suit lighting conditions. Best choice in most situations.

PRE Preset manual

Neutral-colored object used as reference to set white balance under unusual lighting conditions. See “Preset Manual” (📖83) for more information.

Daylight*

White balance adjusted for direct sunlight.

Incandescent*

Use under incandescent lighting.

Fluorescent

Use under most types of fluorescent lighting. Choose one of **FL1** (white fluorescent), **FL2** (daylight white/neutral fluorescent) and **FL3** (daylight fluorescent).

Cloudy*

Use when shooting under overcast skies.

Flash*

Use with the flash.

* Seven settings for fine-tuning become available. The “+” direction increases the blue hue and the “-” direction increases the red hue.

The effects of the selected option can be previewed in the monitor (📖8). At settings other than **Auto**, the icon for the current setting is displayed in the monitor.

Notes on White Balance

- At white balance settings other than **Auto** or **Flash**, turn the flash off (🔇) (📖34).
- This feature cannot be used simultaneously with certain features. See “Functions that Cannot be Applied Simultaneously” (📖96) for more information.

Preset Manual

Preset manual is used under unusual lighting conditions or when the desired effect has not been achieved with white balance settings like **Auto** and **Incandescent** (for example, to make images shot under a lamp with a red shade look as though they had been shot under white light).

1 Place a white or gray reference object under the lighting that will be used during shooting.

2 Display the shooting menu (📖74), use the multi selector to set **White balance to PRE Preset manual**, then press the **OK** button.

- The camera lens extends to a position that is half of the camera's maximum optical zoom.

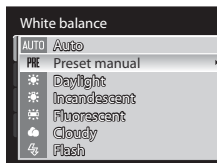

3 Choose **Measure**.

- To use the most recently measured value for preset manual, choose **Cancel** and press the **OK** button. The most recently measured value will be set for white balance.



4 Frame the reference object.

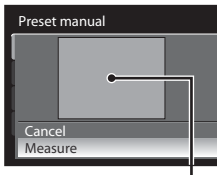

Reference object frame

5 Press the **OK** button to measure the white balance value.

- The shutter is released and the new white-balance preset value is set (no picture is recorded).

✔ Note on Preset Manual

The camera cannot measure a white balance value for when the flash fires. When shooting with the flash, set **White balance to Auto or Flash**.

ISO ISO Sensitivity

Set to **P**, **S**, **A** or **M** → MENU → **P**, **S**, **A**, **M** (shooting menu) (📖74) → ISO sensitivity

Sensitivity is a measure of how quickly the camera reacts to light. The higher the sensitivity, the less light needed to make an exposure. Although a high ISO rating is suitable for shooting pictures of subjects in action or in poor lighting, high sensitivity is often associated with “noise” - randomly spaced, brightly colored pixels concentrated in dark parts of the image.



ISO sensitivity

- **Auto** (default setting): Sensitivity is ISO 160 in bright places; in dark places the camera automatically raises sensitivity to a maximum of ISO 800.
- **High ISO sensitivity auto**: The ISO sensitivity is set automatically within the range of ISO 160 to 1600 according to the brightness of the subject.
- **Fixed range auto**: Choose the range in which the camera automatically adjusts ISO sensitivity, from **ISO 160-200** (default setting) or **ISO 160-400**. The camera will not raise sensitivity beyond the maximum value in the selected range. Set the maximum value for ISO sensitivity for effective control over the amount of “grain” that appears in images.
- **160, 200, 400, 800, 1600, 3200**: ISO sensitivity will be locked at the specified value.

Minimum shutter speed

When the shooting mode is **P** or **A** and **ISO sensitivity** is set to **Auto**, **High ISO sensitivity auto**, or **Fixed range auto**, the shutter speed at which the ISO sensitivity automatic control starts to function (1/125 to one second) is set. The default setting is **None**. If the exposure is insufficient with the shutter speed that is set here, the ISO sensitivity is increased automatically to obtain the correct exposure. If the exposure is still insufficient even after the ISO sensitivity is increased, the shutter speed slows down.

At settings other than Auto, the current setting is displayed in the monitor (📖8).

- If **Auto** is selected and the sensitivity is raised above ISO 160, the **ISO** icon will be displayed (📖36).
-  is displayed when **High ISO sensitivity auto** is selected, and  and the maximum ISO sensitivity value are displayed when **Fixed range auto** is selected.

Notes on ISO Sensitivity

- In **M** (manual) mode, ISO sensitivity will be fixed at ISO 160 if **Auto**, **High ISO sensitivity auto** or **Fixed range auto** is selected.
- When the ISO sensitivity is ISO 800, the slowest shutter speed is restricted to four seconds, when ISO 1600, restricted to two seconds, and when ISO 3200, restricted to one second.
- This feature cannot be used simultaneously with certain features. See “Functions that Cannot be Applied Simultaneously” (📖96) for more information.

Metering

Set to **P, S, A** or **M** → MENU → **P, S, A, M** (shooting menu) (📖74) → Metering

The process of measuring the brightness of the subject to determine the exposure is known as Metering.

Choose how the camera meters exposure.

Matrix (default setting)

Camera sets exposure for entire frame. Recommended in most situations.

Center-weighted

Camera meters by assigning the greatest weight to the center-weighted area that is displayed on the screen. Classic meter for portraits; preserves background details while letting lighting conditions at center of frame determine exposure. Can be used with focus lock (📖31) to meter off-center subjects.

Spot

Camera meters area shown by circle in center of frame. Ensures that subject in metering target is correctly exposed even if background is much lighter or darker. Ensure that the subject is within the area shown by circle when shooting. Can be used with focus lock (📖31) to meter off-center subjects.

Spot AF area

Camera meters selected focus area. Available only when a setting other than **Center** is selected for **AF area mode** (📖90).

Notes on Metering

- When digital zoom is in effect, at magnifications of 1.2x to 1.8x, **Metering** is set to **Center-weighted**, and at magnifications of 2.0x to 4.0x, it is set to **Spot**. When digital zoom is in effect, the metered area is not shown in the monitor.
- This feature cannot be used simultaneously with certain features. See “Functions that Cannot be Applied Simultaneously” (📖96) for more information.

Metering Area

The active metering area is displayed in the monitor when **Center-weighted** or **Spot** is selected for **Metering** (📖8).

Continuous

Set to **P, S, A** or **M** → MENU → **P, S, A, M** (shooting menu) (📖74) → Continuous

Change settings for Continuous (continuous shooting) and BSS (Best Shot Selector), etc.

Single (default setting)

One image is shot each time the shutter-release button is pressed.

Continuous H

While the shutter-release button is held down, the camera shoots about ten frames per second (fps) (when the image quality is set to **Normal** and the image size is set to  **3648×2736**). Shooting ends when the shutter-release button is released, or six shots have been taken with the shutter-release button held down.

Continuous L

While the shutter-release button is held down, up to 200 pictures are shot at a rate of about up to 2.8 frames per second (fps) (when image quality is set to **Normal** and image size is set to  **3648×2736**).

- When **Distortion control** (📖94) is set to **On**, the frame rate slows down.

BSS BSS

BSS is recommended for shooting under low lighting without the flash, with the camera zoomed in, or in other situations in which camera shake is likely to blur pictures.

The camera takes up to ten images while the shutter-release button is held down. The sharpest image (image with the most detail) in the series is automatically selected and saved.

Multi-shot 16

Each time shutter-release button is pressed, camera shoots 16 pictures at about 30 frames per second (fps) and arranges them in a single picture.

- The image quality for recording is fixed to **Normal** and the image size is fixed to  (2560×1920 pixels).
- Digital zoom is not available.

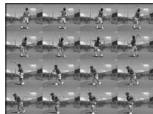

Intvl timer shooting

Camera takes images automatically at specified intervals (📖87).

At settings other than **Single**, the indicator for the current setting is displayed in the monitor (📖8).

✓ Notes on Continuous Shooting

- When **Continuous H**, **Continuous L**, **BSS** or **Multi-shot 16** is selected, the flash will be set to off. Focus, exposure and white balance are fixed at the values for the first picture in each series.
- The frame rate may become slower depending on the image quality, image size, memory card type or shooting conditions.
- This feature cannot be used simultaneously with certain features. See “Functions that Cannot be Applied Simultaneously” (📖96) for more information.
- Be aware that shooting will stop if the built-in flash is raised or lowered while you are pressing the shutter-release button fully in **Continuous H**, **Continuous L** or **BSS** mode.

✓ Note on Best Shot Selector

BSS is best suited for shooting stationary subjects. **BSS** may not produce the desired results if the subject moves or the composition changes while the shutter-release button is pressed all the way down.

✓ Note on Multi-shot 16

When shooting under lights that flicker at high speed such as fluorescent, mercury-vapor or sodium-vapor lamps, banding on the picture or variations in monitor brightness and hue may occur.

✓ Note on Shutter Speed

When **Multi-shot 16** is selected for the **Continuous** setting, the slowest shutter speed is restricted to 1/30 second.

📎 Shooting Pictures in Continuous H or Continuous L

Pictures that are shot in **Continuous H** or **Continuous L** are saved as a “sequence” for each shooting (📖102).

Interval Timer Shooting

Images are shot automatically at specified intervals. Choose from **30 s**, **1 min**, **5 min**, or **10 min**.

- 1 Display the shooting menu (📖74), use the multi selector to select **Intvl timer shooting** for the **Continuous** setting, and then press the **OK** button.

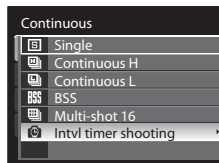

2 Choose the interval taken between each shot and press the **OK** button.

- The maximum amount of frames that can be taken during interval timer shooting differs according to the interval taken between each shot.
 - 30 s**: 600 images
 - 1 min**: 300 images
 - 5 min**: 60 images
 - 10 min**: 30 images

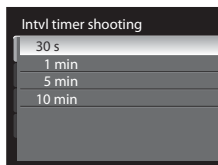

3 Press the **MENU** button.

- The camera returns to shooting mode.

4 Press the shutter-release button all the way down to shoot the first picture and initiate interval timer shooting.

- Monitor turns off and the power-on lamp blinks between shots.
- The monitor turns back on automatically right before the next image is shot.

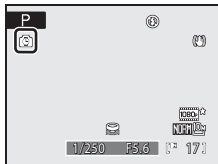

5 Press the shutter-release button all the way down a second time to end recording.

- Recording will end automatically if the internal memory or memory card becomes full, or when the maximum amount of frames have been recorded.

✓ Notes on Interval Timer Shooting

- To prevent the camera from turning off unexpectedly during recording, use a fully charged battery.
- To power the camera continuously for extended periods, use the AC Adapter EH-62A (available separately from Nikon). Do not, under any circumstances, use another make or model of AC adapter. Failure to observe this precaution could result in overheating or in damage to the camera.
- Do not rotate the mode dial to a different setting while performing interval timer shooting.

🔍 More Information

See "File and Folder Names" (📖181) for more information.

BKT Auto Bracketing

Set to **P**, **S**, **A** or **M** → MENU → **P**, **S**, **A**, **M** (shooting menu) (📖74) → Auto bracketing

The camera automatically varies exposure slightly over a burst of pictures. Use in situations where it is difficult to perform exposure compensation (📖41).

 ±0.3

Camera varies exposure by 0 EV, +0.3 EV, and -0.3 EV over next three shots. The three shots are taken in sequence when the shutter-release button is fully pressed.

 ±0.7

Camera varies exposure by 0 EV, +0.7 EV, and -0.7 EV over next three shots. The three shots are taken in sequence when the shutter-release button is fully pressed.

 ±1.0

Camera varies exposure by 0 EV, +1.0 EV, and -1.0 EV over next three shots. The three shots are taken in sequence when the shutter-release button is fully pressed.

OFF Off (default setting)

Bracketing is not performed.

When auto bracketing is enabled, the current setting is displayed during shooting (📖8). When **Off** is selected, an icon for the current setting is not displayed.

✓ Notes on Auto Bracketing

- **Auto bracketing** is not available in **M** (manual) mode.
- When exposure compensation (📖41) and **±0.3**, **±0.7** or **±1.0** in **Auto bracketing** are set simultaneously, the combined exposure compensation values are applied.
- This feature cannot be used simultaneously with certain features. See “Functions that Cannot be Applied Simultaneously” (📖96) for more information.

📖 More Information

See “Viewing Continuously Shot Pictures (Pictures in a sequence)” (📖102) for more information.

[+] **AF-Area Mode**

Set to **P, S, A** or **M** → MENU → **P, S, A, M** (shooting menu) (📖74) → AF area mode

Choose how the focus area is determined for autofocus.

When digital zoom is in effect, the camera will focus on the subject in the center focus area regardless of the applied **AF area mode** option.

Face priority

The camera automatically detects and focuses on a face (see “Shooting with Face Priority” (📖91) for more information). If the camera detects multiple faces, the camera focuses on the face closest to the camera. When subjects other than people are photographed, or a subject with which no face can be detected is framed, AF area mode is set to **Auto**. The camera automatically selects the focus area containing the subject closest to the camera.

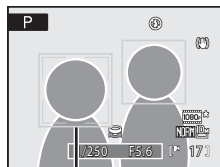

Focus area

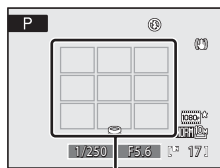

Auto (default setting)

The camera automatically selects the focus area containing the subject closest to the camera. Press the shutter-release button halfway to activate the focus area. When the shutter-release button is pressed halfway, the focus area selected by the camera will be displayed in the monitor (up to nine areas).



Focus areas

Manual

Choose manually the focus position from 99 areas in the screen. This option is suited to situations in which the intended subject is relatively still and not positioned in the center of the frame. Press the multi selector ▲, ▼, ◀ or ▶ to select one of 99 focus areas displayed in the monitor's focus-area selection screen, and shoot. To end focus-area selection and adjust the flash mode, focus mode, self-timer and exposure compensation settings, press the  button. To return to the focus-area selection screen, press the  button again.

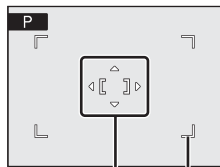

Focus area
Selectable areas

- At an **Image size** setting (📖76) of  **2736x2736**, 81 focus areas are available.

Center

Camera focuses on the subject in the center of the frame.
Center focus area is always used.

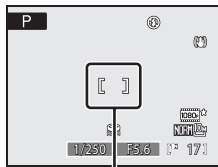

Focus area



More Information

- See "Autofocus" (📖31) for more information.
- See "Functions that Cannot be Applied Simultaneously" (📖96) for more information.

Shooting with Face Priority

The camera automatically detects and focuses on a face.

The face priority function will be enabled for the following situations.

- **Face priority** is selected for AF area mode (📖90)
- When **Portrait** (📖46) or **Night portrait** (📖47) is chosen for scene mode
- When scene auto selector mode (📖43) is chosen
- When smart portrait mode (📖55) is chosen

1 Frame the picture.

- When the camera detects a face, that face will be framed by a yellow double border.

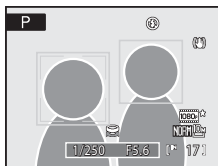

- When the camera detects more than one face, depending upon the shooting mode, the operation varies as follows.

Shooting mode	Faces framed by a double border	Number of faces to be recognized
P, S, A, M, U modes (Face priority)	The face closest to the camera * The other faces are framed by a single border.	Up to 12
Portrait or Night portrait scene modes		
Scene Auto Selector mode		
Smart portrait mode	The face closest to the center of the frame * The other faces are framed by a single border.	Up to 3

2 Press the shutter-release button halfway.

- The camera focuses on the face framed by the double border. The double border will glow green and focus will be locked.
- When the camera is unable to focus on a face, the double border will blink. Press the shutter-release button halfway again and focus.
- Press the shutter-release button all the way down to shoot.
- When using **Smile timer** in smart portrait mode, even if the shutter-release button is not pressed, the shutter is released automatically if the camera detects that the face framed by the double border is smiling (☞57).

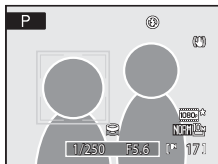

✓ Notes on Face Priority

- When **Face priority** is selected for AF area mode, the setting will automatically switch to **Auto** if no face is detected when the shutter-release button is pressed halfway.
- If no face is recognized when the shutter-release button is pressed halfway in the **Portrait** or **Night portrait** scene modes or in smart portrait mode, the camera will focus on the subject in the center focus area.
- The camera may be unable to detect faces in the following situations:
 - When faces are partially hidden by sunglasses or other obstructions
 - When faces take up too much or too little of the frame
- Depending on shooting conditions, such as whether or not the subject is facing the camera, faces may not be detected.
- In some rare cases of shooting subjects with which autofocus may not perform as expected (☞31), the subject may not be in focus despite the fact that the double border glows green. Should this occur, switch to auto mode or change the AF area mode setting to **Manual** or **Center** in **P**, **S**, **A**, **M** and **U** modes, refocus on another subject positioned at the same distance from the camera as the actual portrait subject, and use focus lock (☞31).
- Pictures that were shot using face priority will be rotated automatically when displayed in full-frame or thumbnail playback mode according to the orientation of the face (except for pictures shot while **Continuous** (☞86) or **Auto bracketing** (☞89) was set).

Autofocus Mode

Set to **P, S, A** or **M** → MENU → **P, S, A, M** (shooting menu) (📖74) → Autofocus mode

Choose how the camera focuses.

 Single AF (default setting)

Camera focuses when the shutter-release button is pressed halfway.

 Full-time AF

Camera focuses continuously until the shutter-release button is pressed down halfway. Use with moving subjects. A sound will be heard while the camera focuses.

Note on Autofocus Mode

This feature cannot be used simultaneously with certain features. See “Functions that Cannot be Applied Simultaneously” (📖96) for more information.

Note on the Autofocus Mode Setting for Subject Tracking Mode

You can set **Autofocus mode** for subject tracking mode (📖61). The default setting in subject tracking mode is **Full-time AF**. The **Autofocus mode** setting in subject tracking mode is stored in the camera's memory independently and is not applied to the **Autofocus mode** in shooting modes **P, S, A** or **M**.

Flash Exp. Comp.

Set to **P, S, A** or **M** → MENU → **P, S, A, M** (shooting menu) (📖74) → Flash exp. comp.

Flash compensation is used to adjust flash output by ± 2.0 EV in increments of $1/3$ EV, changing the brightness of the main subject relative to the background.

-0.3 to -2.0

Flash output is reduced from -0.3 to -2.0 EV, in increments of $1/3$ EV, to prevent unwanted highlights or reflections.

0.0 (default setting)

Flash output is not adjusted.

+0.3 to +2.0

Flash output is increased from $+0.3$ to $+2.0$ EV, in increments of $1/3$ EV, to make the main subject of the frame appear brighter.

At settings other than **0.0**, the icon for the current setting is displayed in the monitor (📖9).

NR Noise Reduction

Set to **P, S, A** or **M** → MENU → **P, S, A, M** (shooting menu) (📖74) → Noise reduction

At slow shutter speeds, pictures may be affected by “noise” in the form of randomly-spaced, brightly-colored dots concentrated in dark parts of the image. Use this option to reduce noise at slow shutter speeds. Enabling noise reduction increases the time needed to record pictures after they are shot.

AUTO Auto (default setting)

Noise reduction is performed at slow shutter speeds, likely to result in pictures affected by noise.

NR On

Noise reduction is applied to pictures shot at shutter speeds of 1/4 second or slower. Switching this to **On** is recommended when shooting at slow shutter speeds.

When noise reduction is performed, the  icon is displayed in the monitor during shooting (📖9).

Note on Noise Reduction

This feature cannot be used simultaneously with certain features. See “Functions that Cannot be Applied Simultaneously” (📖96) for more information.

Distortion Control

Set to **P, S, A** or **M** → MENU → **P, S, A, M** (shooting menu) (📖74) → Distortion control

Choose whether to correct the peripheral distortion that occurs due to the intrinsic characteristics of lenses. Enabling distortion control reduces the size of the frame, as compared to distortion control not being enabled.

On

Distortion is corrected.

OFF Off (default setting)

No distortion correction is performed.

When distortion control is enabled, the current setting is displayed during shooting (📖8). When **Off** is selected, an icon for the current setting is not displayed.

Note on Distortion Control

This feature cannot be used simultaneously with certain features. See “Functions that Cannot be Applied Simultaneously” (📖96) for more information.

Active D-Lighting

Set to **P, S, A** or **M** → MENU → **P, S, A, M** (shooting menu) (📖74) → Active D-Lighting

“Active D-Lighting” preserves details in highlights and shadows, creating photographs with natural contrast. The image taken will reproduce the contrast effect that is seen with the naked eye. This is particularly effective for shooting brightly lit outdoor scenery from darker indoors or taking pictures of shaded subjects at a sunny seaside.

High, Normal, Low

Set the level of the Active D-Lighting effect that is applied during shooting.

Off (default setting)

Active D-Lighting is not applied.

When Active D-Lighting is enabled, the current setting is displayed during shooting (📖8). When **Off** is selected, an icon for the current setting is not displayed.

Active D-Lighting















- Additional time is required to record images when shooting using Active D-Lighting.
- When Active D-Lighting is selected, exposure will be reduced in comparison to shooting without selecting Active D-Lighting. Adjustments will be made to highlighted areas, underexposed areas and mid-tones so that brightness of gradations will become appropriate.
- This feature cannot be used simultaneously with certain features. See “Functions that Cannot be Applied Simultaneously” (📖96) for more information.

















Active D-Lighting Versus D-Lighting

The **Active D-Lighting** option in the shooting menu adjusts exposure before shooting to optimize the dynamic range. The **D-Lighting** (📖121) option in the playback menu optimizes dynamic range in images after shooting.

Functions that Cannot be Applied Simultaneously

Certain settings in the shooting menu cannot be used with other functions.

Restricted function	Setting	Description
Flash mode	Focus mode ( 38)	When  (infinity) is selected for shooting, the flash is not available.
	Continuous ( 86)	When Continuous H , Continuous L , BSS or Multi-shot 16 is selected for shooting, the flash is not available.
	Auto bracketing ( 89)	The flash is not available.
Image quality/ Image size	Continuous ( 86)	When Multi-shot 16 is selected for shooting, Image quality will be fixed to Normal and Image size will be fixed to  (2560×1920 pixels).
Optimize image	Active D-Lighting ( 95)	When Active D-Lighting is used for shooting, the Contrast setting for Custom or for Custom in Black-and-white will be fixed to Auto under the Optimize image options.
White balance	Optimize image ( 79)	When Black-and-white is selected for Optimize image , White balance will be fixed to Auto .
ISO sensitivity	Continuous ( 86)	<ul style="list-style-type: none"> When shooting in Multi-shot 16, ISO sensitivity will be set automatically according to the brightness when shooting mode P, S or A is used. The setting for ISO sensitivity will be fixed at 160 for shooting mode M. When shooting in Continuous L, 3200 is not available. If Continuous L is selected while ISO sensitivity is set to 3200, the sensitivity is changed to 1600.
Metering	AF area mode ( 90)	When Spot AF area is selected for Metering , setting AF area mode to Center changes the Metering setting to Matrix .
	Active D-Lighting ( 95)	When an option other than Off is selected for Active D-Lighting , the setting for Metering will be reset to Matrix .
Continuous/Auto bracketing	Continuous ( 86)/Auto bracketing ( 89)	<p>Continuous and Auto bracketing are not available simultaneously.</p> <p>When an option other than Single is selected for Continuous, the setting for Auto bracketing will be reset to Off.</p> <p>When an option other than Off is selected for Auto bracketing, the setting for continuous will be reset to Single.</p>
	Self-timer ( 37)	The self-timer and Continuous H , Continuous L , BSS , Multi-shot 16 , Intvl timer shooting or Auto bracketing are not available simultaneously.

Restricted function	Setting	Description
Continuous/Auto bracketing	Optimize image ( 79)	When Black-and-white is selected and B&W + color is enabled in Optimize image , then Continuous H , Continuous L , BSS , Multi-shot 16 and Auto bracketing are not available. When the B&W + color check box is selected, the setting for continuous is reset to Single and Auto bracketing is reset to Off . To perform simultaneous recording of black-and-white and color with Intvl timer shooting , first select B&W + color , and then select the Intvl timer shooting setting.
	Noise reduction ( 94)	When On is selected for Noise reduction , Continuous H and Multi-shot 16 are not available.
	Distortion control ( 94)	When Distortion control is set to On , Multi-shot 16 and Intvl timer shooting are not available.
AF area mode	Digital zoom ( 164)	When digital zoom is in effect, AF-area is fixed to Center .
	Focus mode ( 38)	When  (infinity) is selected as the focus mode for shooting, the camera focuses at infinity regardless of the applied AF area mode option.
Noise reduction	Continuous ( 86)/Auto bracketing ( 89)/ Distortion control ( 94)	<ul style="list-style-type: none"> When Continuous H or Multi-shot 16 is selected for shooting, the noise reduction function is not available. When Continuous L, BSS or Auto bracketing is selected for shooting and Distortion control is set to On, the noise reduction function is not available.
Distortion control	Continuous ( 86)	When Multi-shot 16 or Intvl timer shooting is selected for shooting, distortion control is not available.
Active D-Lighting	ISO sensitivity ( 84)	When ISO sensitivity is set to High ISO sensitivity auto or 1600 or higher, Active D-Lighting is not available. When High ISO sensitivity auto or 1600 or higher is selected, Active D-Lighting is reset to Off .
Date imprint	Continuous ( 86)	When Continuous H , Continuous L or BSS is selected for shooting, date imprint is not available.
	Auto bracketing ( 89)	Date imprint is not available.
Blink warning	Continuous ( 86)/Auto bracketing ( 89)	Blink warning does not take effect.
Digital zoom	Continuous ( 86)	When Multi-shot 16 is selected for shooting, the digital zoom is not available.

**More Information**See "Notes on Digital Zoom" (164) for more information.

Using U (User Setting Mode)

Settings that are frequently used for **P**, **S**, **A** and **M** shooting modes can be saved in mode dial **U**.

Rotating the mode dial to **U** enables you to shoot using the saved settings.

The following settings can be saved in **U**.

Basic Settings

Shooting modes P/S/A/M (66) ¹	Monitor display (14, 15)	Zoom position (29)
(Flash mode) (34)	(Focus mode) (38) ²	(exposure compensation) (41)

Shooting menu

Image quality (75)	Image size (76)	Optimize image (79)
WB White balance (82) ³	ISO ISO sensitivity (84)	Metering (85)
Continuous (86)	BKT Auto bracketing (89)	AF area mode (90) ⁴
Autofocus mode (93)	Flash exp. comp. (93)	NR Noise reduction (94)
Distortion control (94)	Active D-Lighting (95)	

1 The current flexible program (when set to **P**), shutter speed (when set to **S** and **M**) or aperture (when set to **A** and **M**) settings will be saved.

2 The current focus distance will be saved when set to **MF** (manual focus).

3 The preset value for preset manual applies to the **P**, **S**, **A**, **M** and **U** shooting modes.

4 The current focus area position is saved when AF area mode is set to **Manual**.

Clock battery

If the internal clock battery (156) is exhausted, the settings saved in **U** will be reset. Writing down any important setting is recommended.

Save the Settings in **U**

1 Rotate the mode dial to the desired exposure mode.

- Rotate to **P**, **S**, **A** or **M**.
- Settings can be saved even if rotated to **U** (the default settings of shooting mode **P** are saved when the camera is first purchased).

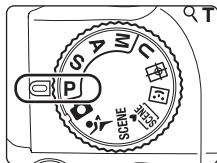

2 Change to a frequently used setting.

3 Press the **MENU** button.

- The shooting menu is displayed.
- Switch to the **P**, **S**, **A**, **M** or **U** tab when the shooting menu is not displayed (13).

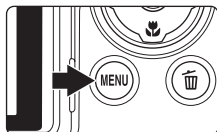

4 Use the multi selector to choose **Save user settings** and press the **OK** button.

- **Done** screen is displayed, and the current settings are saved.

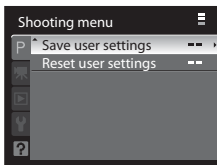

Shooting in **U** (user setting) mode

- Rotate the mode dial to **U** to shoot with the saved settings.
- The settings can be changed. Also, the changed settings can be saved again.

Resetting Saved Settings

The saved setting will revert back to the default setting of shooting mode **P**.

- 1 Choose **Reset user settings** in the shooting menu screen and press the **OK** button.

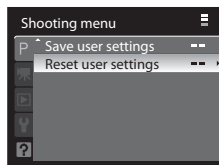

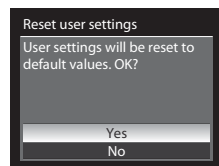

- 2 Choose **Yes** and press the **OK** button.

- The saved settings have been reset.









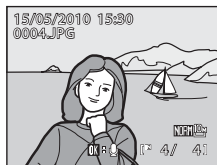











Operations in Full-Frame Playback

In shooting mode, press the  (playback) button to enter playback mode and play back the images that have been shot (32).

In full-frame playback, the following operations are available.



To	Use	Description	
Choose pictures		Press  ,  ,  or  to choose a picture to display. Press and hold  ,  ,  or  to fast forward pictures. Pictures can also be chosen by rotating the command dial.	12
Thumbnail display/ Calendar display	W 	Display images by 4, 9 or 16 picture thumbnails. Rotate the zoom control towards the W  in the 16-picture thumbnail display to change to the calendar display.	104
Playback zoom	T 	Enlarge the view of the picture currently displayed in the monitor, up to about 10x. Press the OK button to return to full-frame playback.	106
Hide or show photo information	DISP	Hide or show the shooting information and photo information in monitor.	15
Switch between displays		Switch between the monitor and electronic viewfinder display.	14
Record/play voice memos	OK	Record or play back voice memos up to 20 seconds in length.	117
Perform continuous playback of a sequence		Perform continuous playback of the pictures when the key picture of a sequence is displayed.	102
Play back movies		Play back the displayed movies.	137
Delete pictures		Delete the displayed pictures. When pressed during sequence display, all the pictures in the sequence are deleted.	32, 103
Display menu	MENU	Display the playback menu.	107
Switch to shooting mode		Press the  button or the shutter-release button to change back to the last chosen shooting mode. Switching to shooting mode can also be performed by pressing the  (movie-record) button.	32
			

Viewing Pictures

Pictures that were shot using face priority (91) will be rotated automatically when displayed in full-frame playback mode according to the orientation of the face (except for pictures shot when

Continuous (86) or **Auto bracketing** (89) was set).

Viewing Continuously Shot Pictures (Pictures in a sequence)

Pictures that were shot continuously in the following modes are saved as a “sequence” for each shooting.

- **Continuous H** or **Continuous L** for the **Continuous** (📖86)
- **Auto bracketing** (📖89)
- Sport continuous mode (📖62)

In the full-frame playback or thumbnail display (📖104), the first frame of a sequence is displayed as the representative key picture.

- When the monitor indicators are turned on (📖15),  is displayed on the pictures in the sequence.

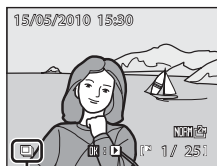







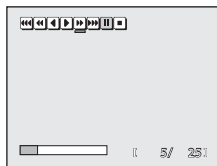











Sequence display

Continuous Playback of Pictures in a Sequence (Sequence Playback)

Press the **OK** button during the full-frame display of a key picture to perform continuous playback of the pictures in the sequence. Playback controls appear at the top of the monitor during playback. Press the multi-selector **◀** or **▶** or rotate the command dial to choose a playback control, and press the **OK** button. The following operations are available.





To	Use	Description
Rewind		The rewind speed increases in the sequence:  →  → 
Advance	 /  / 	The advance speed increases in the sequence:  →  → 
Pause		 Rewind by one frame.
		 Advance by one frame.
		 /  /  Resume playback.
		 Display the first picture of the sequence.
		 Display the last picture of the sequence.
End playback		Return to full-frame playback mode.

Perform Playback Zoom for Pictures in a Sequence

Rotate the zoom control to **T** (📖) while playback is paused to perform playback zoom (📖106).

Deleting Pictures in a Sequence

- Press the  button while the key picture is displayed to delete all the pictures in the sequence that is displayed.
- Press the  button while sequence playback is paused to select the deletion method.
 - **Erase current picture:** Delete only the frame that is displayed ([132](#)).
 - **Erase selected images:** Select pictures for deletion ([111](#)).
 - **Erase entire sequence:** Delete all the pictures in the sequence that is playing back.
 - To exit without deleting the picture, press the **MENU** button.

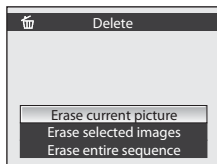

Note on Sequence

Sequence display is not possible for pictures shot continuously using cameras other than COOLPIX P100.

Playback Menu Options Available with Sequence

When the **MENU** button is pressed while the key picture of a sequence is displayed, the following menu operations are available for the pictures in the selected sequence.

- Print set ([108](#))
- Slide show ([110](#))
- Delete ([111](#))
- Protect ([113](#))
- Hide image ([114](#))
- Copy ([115](#))
- Sequence display options ([116](#))
- Choose key picture ([116](#))

In addition, press the **MENU** button while the sequence playback is paused to change the settings or perform editing for individual pictures.

Individual Display of Pictures in a Sequence

All the individual pictures in a sequence can be displayed instead of the key picture only. While individual picture is displayed, editing ([118](#)) can be performed or voice memos ([117](#)) can be recorded for each picture. To display pictures in a sequence individually, change **Sequence display options** ([116](#)) in the playback menu to **Individual pictures**.

Changing Key Picture in Sequence

The key picture can be changed with **Choose key picture** ([116](#)) in the playback menu.

Viewing Multiple Pictures: Thumbnail Playback

Rotate the zoom control to **W** (📏) in full-frame playback mode (📖32, 101) to display pictures as thumbnail images in thumbnail playback mode.



The following operations can be performed in thumbnail playback.

To	Use	Description	📖
Choose pictures		Press ▲, ▼, ◀ or ▶ on the multi selector.	12
		Rotate the command dial.	11
Increase the number of thumbnails displayed/Calendar display	W (📏)	Rotate the zoom control towards the W (📏) direction to increase the number of thumbnails from 4 → 9 → 16 → Calendar display. In calendar display, the images can be selected according to date by moving the cursor (📖105). Rotate towards the T (🕒) direction to return to thumbnail display.	-
Decrease number of picture thumbnails displayed	T (🕒)	Rotate the zoom control towards the T (🕒) direction to decrease the number of thumbnails from 16 → 9 → 4. Rotate towards T (🕒) again during 4 thumbnails display to return to full-frame playback.	-
Return to full-frame playback	OK (Ⓞ)	Press the OK (Ⓞ) button.	32, 101
Switch to shooting mode		Press the button or the shutter-release button to change back to the last chosen shooting mode. Switching to shooting mode can also be performed by pressing the (movie-record) button.	32

✎ Icons on the Thumbnails

When pictures marked using **Print set** (📖108) or **Protect** (📖113) are selected, the icons shown at right are displayed.

When Sequence (📖102) is selected in thumbnail playback mode, the icons shown on the right are displayed.

Movies are displayed as film frames.

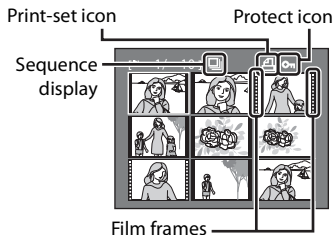

Calendar display

Rotate the zoom control towards **W** (🗘) during playback mode when 16 thumbnails are displayed (📖104) to change to calendar display.

Move the cursor and choose the image according to the date. Dates will be underlined in yellow if there are pictures taken on that date.

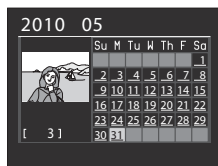

The following operations can be performed while the calendar is displayed.

To	Use	Description	📖
Select date		Press ▲, ▼, ◀ or ▶ on the multi selector.	12
		Rotate the command dial.	11
Return to full-frame playback	OK	Change to full-frame playback display of the first photo taken on the chosen date.	32, 101
Return to thumbnail display	T (🗘)	Rotate the zoom control to T (🗘).	-

✔ Notes on Calendar display





- Images taken without the date set will be treated as images taken on "01.01.10".
- **MENU** and buttons are disabled while the Calendar is displayed.

Taking a Closer Look: Playback Zoom

Rotating the zoom control to **T** (Q) during full-frame playback mode (📖32) zooms in on the current picture, enlarging and displaying the center of the picture on the monitor.

- The guide at lower right shows which portion is enlarged. The following operations can be performed while pictures are zoomed in.



To	Use	Description	📖
Zoom in	T (Q)	Zoom increases each time the zoom control is rotated to T (Q), up to about 10x. Zoom also increases by rotating the command dial to the right.	-
Zoom out	W (📐)	Rotate the zoom control to W (📐). When the magnification ratio reaches 1x, the display returns to full-frame playback mode. Zoom also decreases by rotating the command dial to the left.	-
Move the display area		Press the multi selector ▲ , ▼ , ◀ or ▶ to move the display area to other areas of the picture.	12
Return to full-frame playback	OK	Press the OK button.	32, 101
Crop picture	MENU	Press to crop the current picture to contain only the portion visible in the monitor.	126
Switch to shooting mode		Press the  button or the shutter-release button to change back to the last chosen shooting mode. Switching to shooting mode can also be performed by pressing the ● (movie-record) button.	32
			

Pictures Taken Using the Face-Priority Function















When zooming in on a picture taken using the face-priority function (📖91), the picture will be enlarged with the face detected during shooting at the center of the monitor (except for pictures shot while **Continuous** (📖86) or **Auto bracketing** (📖89) was set).

- If more than one face was detected, the picture will be enlarged with the face on which focus was acquired at the center of the monitor. Press the multi selector **▲**, **▼**, **◀**, or **▶** to display other faces that were detected.
- When the zoom control is further rotated towards the **T** (Q) or **W** (📐) direction, the zoom ratio will change and will become a normal playback zoom display.



Playback Options: Playback Menu

The following options are available in playback menu.

	Quick retouch 📖120
Easily create retouched images in which contrast and saturation have been enhanced.	
	D-Lighting 📖121
Enhance brightness and contrast in dark portions of pictures.	
	Skin softening 📖122
Make the subject's skin appear smoother.	
	Print set 📖108
Select pictures to print and the number of copies for each.	
	Slide show 📖110
View pictures stored in the internal memory or on a memory card in an automatic slide show.	
	Delete 📖111
Delete a picture. Multiple pictures can be deleted.	
	Protect 📖113
Protect selected pictures from accidental deletion.	
	Rotate image 📖114
Change the orientation of an existing picture.	
	Hide image 📖114
Hide selected pictures during playback.	
	Small picture 📖124
Create a small copy of the current picture.	
	Copy 📖115
Copy files between memory card and internal memory.	
	Black border 📖125
Create a new picture surrounded by a black border.	
	Sequence display options 📖116
Set whether to display continuously shot pictures individually or return to displaying the key picture only.	
	Choose key picture 📖116
Change the key picture for the series of pictures that were shot continuously (Pictures in a sequence 📖102).	

Displaying the Playback Menu

Display the playback menu by pressing the **MENU** button and switching to the  tab (📖13).

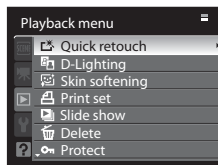
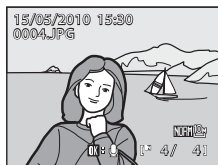



- Press the multi selector to select items and set functions on menus (📖12).
- To exit the playback menu, press the **MENU** button.

Print Set: Setting the Pictures and Number of Copies to Print

Press the **MENU** button →  (Playback menu) (107) →  Print set





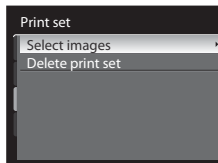

If you choose to use one of the following methods to print pictures that are recorded on a memory card, the pictures to print and the number of copies can be set in advance on the memory card.

- Printing with a DPOF-compatible (198) printer that is equipped with a card slot.
- Ordering the prints from a digital photo lab that has a DPOF service.
- Printing by connecting the camera to a PictBridge-compatible (198) printer (146). (When the memory card is removed from the camera, the print settings can also be performed for the pictures recorded on the internal memory.)

1 Choose **Select images** and press the button.



2 Choose the pictures (up to a maximum of 99) and number of copies (up to nine per picture).

- Press the multi selector  or  to choose the pictures, and press  or  to set the number of copies for each.
- Pictures can also be chosen by rotating the command dial.
- Pictures selected for printing can be recognized by the check mark icon and the numeral indicating the number of copies to be printed. A check mark is not displayed with pictures for which no copies have been specified and these pictures will not be printed.
- Rotate the zoom control to **T** () to switch to full-frame playback, or **W** () to switch to 12 thumbnails display.
- Press the  button when setting is complete.





More Information

See "Printing Images of Size 1:1" (78) for more information.

3 Choose whether or not to also print shooting date and photo information.

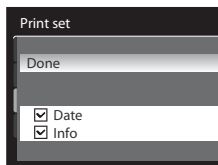
- Choose **Date** and press the **OK** button to print the date of recording on all pictures in the print order.
- Choose **Info** and press the **OK** button to print shooting information (shutter speed and aperture) on all pictures in the print order.
- Choose **Done** and press the **OK** button to complete the print order.



Pictures selected for printing are recognized by the  icon displayed with playback.

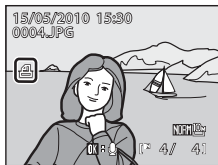

Notes on Printing Shooting Date and Photo Information

When the **Date** and **Info** options are enabled in the Print set menu, shooting date and photo information are printed on pictures when a DPOF-compatible ([198](#)) printer which supports printing of shooting date and photo information is used.

- Photo information cannot be printed when the camera is connected directly to a printer, via the supplied USB cable, for DPOF printing ([151](#)).
- **Date** and **Info** are reset each time the **Print set** menu is displayed.
- The date and time printed on the picture is the date and time recorded on the camera when the picture was taken. The date and time printed using this option will not be affected even if the camera's **Date** setting is changed from the setup menu after the pictures are taken.



Deleting All Print Orders



In step 1 of the print set procedure ([108](#)), choose **Delete print set** and press the **OK** button to delete the print settings for all pictures.

Date imprint

The shooting date and time can be imprinted in pictures at the time of shooting by using **Date imprint** ([159](#)) in the setup menu. This information can be printed even from printers that do not support printing of date and time.



Only the date and time of Date imprint on the pictures will be printed, even if **Print set** is enabled with the date selected in the print set screen.

Slide Show

Press the **MENU** button →  (Playback menu) (📖107) →  Slide show



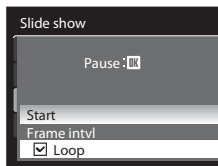

View pictures stored in the internal memory or on a memory card in an automatic slide show.

1 Use the multi selector to choose **Start** and press the button.

- To change the interval between pictures, choose **Frame intvl**, select the desired interval time, and press the  button before choosing **Start**.
- To repeat the slide show automatically, enable **Loop** and press the  button before choosing **Start**. The check mark () will be added to the loop option when enabled.



2 The slide show begins.

- Press the multi selector  to view pictures in the order recorded, or  to view pictures in reverse order. Press and hold  to fast forward, or  to rewind.
- Press the  button to pause the slide show.



3 Choose End or Restart.

- When the slide show ends or is paused, choose **End** and press the  button to return to the playback menu. Choose **Restart** to play the slide show again.

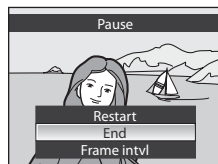

Notes on Slide Show

- Only the first frame of movies (📖137) included in slide shows is displayed.
- Only the key picture is displayed for a sequence (📖102) for which the display of the key picture only is set.
- Slide shows play for a maximum of 30 minutes, even when **Loop** is selected (📖165).



Delete: Deleting Multiple Pictures

Press the **MENU** button →  (Playback menu) (107) →  Delete

Delete a picture. Multiple pictures can also be deleted.

Erase selected images

In the picture selection screen, choose the pictures for deletion. See "Selecting Pictures" (112) for more information.

- When a sequence (102) that is set to display the key picture only is chosen, all pictures in the sequence that is displayed are deleted.
- When **Delete** is chosen while sequence playback (102) is paused, only the pictures in the sequence can be chosen.

Erase all images



Delete all pictures.

- Not displayed when **Delete** is chosen while sequence playback is paused.

Erase entire sequence

Displayed when **Delete** is chosen while sequence playback is paused. All pictures in the sequence that is playing are deleted.

Notes on Deletion

- Once deleted, pictures cannot be recovered. Transfer important images to a computer before deletion.
- Pictures marked with the  icon are protected and cannot be deleted (113).

Selecting Pictures

The picture selection screen, as shown at right, will be displayed with the following menus:

- **Playback menu:** Quick retouch* (📖120),
D-Lighting* (📖121),
Skin softening* (📖122),
Select images in Print set (📖108),
Erase selected images in Delete (📖111),
Protect (📖113),
Rotate image (📖114),
Hide image (📖114),
Small picture* (📖124),
Selected images in Copy (📖115),
Black border* (📖125),
Choose key picture (📖116)
- **Setup menu:** Welcome screen (📖154)

* These menus will be displayed if menu items are selected when the playback menu has been displayed from a mode other than playback mode (📖13).

Follow the procedure described below to select pictures.



1 Press the multi selector ◀ or ▶ to choose the desired picture.

- The command dial can also be used in place of pressing ◀ or ▶ on the multi selector.
- Only one picture can be selected for **Quick retouch, D-Lighting, Skin softening, Rotate image, Small picture, Black border, Choose key picture** and **Welcome screen**. Proceed to step 3.
- Rotate the zoom control to **T** (📷) to switch to full-frame playback, or **W** (📺) to switch to 12 thumbnails display.

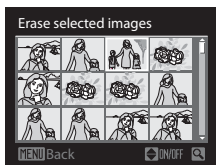

2 Press ▲ or ▼ to select ON or OFF (or the number of copies).

- When ON is selected, a check mark is displayed in the current picture. Repeat steps 1 and 2 to select additional pictures.



3 Press the OK button to apply picture selection.

- With selections such as **Erase selected images**, the confirmation dialog is displayed. Follow the instructions on the screen.

Protect

Press the MENU button → [Playback menu] (107) → Protect

Protect selected pictures from accidental deletion.

In the picture selection screen, choose a picture and set or cancel protection. See "Selecting Pictures" (112) for more information.

Note, however, that formatting the camera's internal memory or the memory card will permanently erase protected files (166).

Protected pictures are recognized by the icon in playback mode (10, 105).

Rotate Image

Press the **MENU** button →  (Playback menu) (📖107) →  Rotate image

Change the orientation of pictures played back in the camera's monitor after shooting. Pictures can be rotated 90° clockwise or counterclockwise.

Pictures that were recorded in the portrait (vertical) orientation can be rotated up to 180° in either direction.

Select a picture in the picture selection screen (📖112), and press the **OK** button to display the rotate image screen. Press the multi selector ◀ or ▶ to rotate the picture 90°.

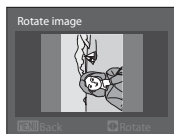

Rotate 90°
counterclockwise



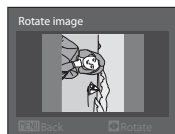

Rotate 90°
clockwise



More on Playback

Press the **OK** button to set the orientation displayed, and save the orientation data with the picture.

Hide Image



Press the **MENU** button →  (Playback menu) (📖107) →  Hide image

Hide selected pictures during playback.

In the picture selection screen, choose a picture and enable or disable the Hide image setting. See "Selecting Pictures" (📖112) for more information.



Hidden pictures cannot be deleted using the **Delete** option. Note, however, that formatting the camera's internal memory or the memory card will permanently erase hidden files (📖166).

Copy: Copying Between the Internal Memory and Memory Card

Press the **MENU** button →  (Playback menu) (📖107) →  Copy

Copy pictures between the internal memory and a memory card.

1 Use the multi selector to select an option from the copy screen and press the **OK** button.

- : Copy pictures from internal memory to memory card.
- : Copy pictures from memory card to internal memory.

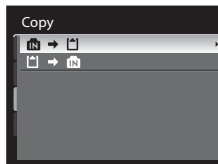

2 Select a copy option and press the **OK** button.

- **Selected images:** Copy pictures selected from the picture selection screen (📖112). When a sequence (📖102) that is set to display the key picture only is chosen, all pictures in the sequence that is displayed are copied. When **Copy** is chosen while sequence playback (📖102) is paused, only the pictures in the sequence can be chosen.
- **All images:** Copy all pictures. Not displayed when **Copy** is chosen while sequence playback is paused.
- **Current sequence:** Displayed when **Copy** is chosen while sequence playback is paused. All pictures in the sequence that is playing are copied.

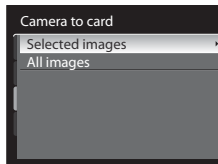

Notes on Copying Pictures

- JPEG-, MOV-, and WAV-format files can be copied. Files recorded in any other format cannot be copied.
- If voice memos (📖117) are attached to pictures selected for copying, voice memos are copied with the pictures.
- Pictures recorded with another make or model of camera or that have been modified on a computer cannot be copied.
- Edited copies have the same protection marking (📖113) as the original, but are not marked for printing (📖108).
- Hidden pictures (📖114) cannot be copied.
- While the sequence playback (📖102) is paused, pictures can only be copied in the  (from SD card to internal memory) direction.



Memory contains no images. Message



If there are no pictures stored on the memory card when playback mode is applied, the message, **Memory contains no images.**, will be displayed. Press the **MENU** button to display the copy option screen, and copy the pictures stored in the camera's internal memory to the memory card.

More Information

See "File and Folder Names" (181) for more information.

Sequence Display Options

Press the **MENU** button →  (Playback menu) (107) →  Sequence display options

Set whether to display the series of pictures that were shot continuously (Pictures in a sequence 102) in the full-frame display (101) or thumbnail display (104) of playback mode.

- When setting, before pressing the **MENU** button, choose in the full-frame or thumbnail display the sequence that you want to set (the picture in the sequence display (10, 105)).

Individual pictures



The pictures that were shot in a sequence are displayed individually.

- When the pictures are displayed individually, sequence playback (102) cannot be performed.

Key picture only

Returns a sequence in which pictures are displayed individually to the key picture only display.



Choose Key Picture

Press the **MENU** button →  (Playback menu) (107) →  Choose key picture

When **Sequence display options** is set to **Key picture only**, the key picture displayed for the full-frame or thumbnail display in playback mode is changed for each sequence.

- When setting, before pressing the **MENU** button, choose in the full-frame or thumbnail display the sequence that you want to set.
- When the key picture selection screen is displayed, choose a picture. See "Selecting Pictures" (112) for more information.

Voice Memos: Recording and Playback

Use the camera's built-in microphone to record voice memos for pictures marked with **OK** :  in full-frame playback mode (32).

Recording Voice Memos

A voice memo, up to 20 seconds in length, will be recorded while the **OK** button is pressed down.

- Do not touch the built-in microphone during recording.
- During recording, **REC** and  blink in the monitor.

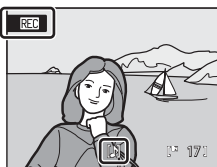
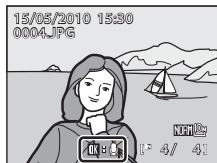



Playing Voice Memos

Press the **OK** button while a picture is displayed in full-frame playback mode to play the voice memo. Playback ends when the voice memo ends or when the **OK** button is pressed again.

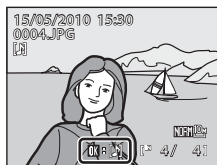
- Pictures with voice memos can be recognized by the **OK** :  icon.
- Use the zoom control **T/W** during playback to adjust the volume.



Deleting Voice Memos

Choose a picture with a voice memo and press the  button. Use the multi selector to choose  and press the **OK** button. Only the voice memo will be deleted.

Notes on Voice Memos

- When a picture with a voice memo attached is deleted, both the picture and its voice memo are deleted.
- Voice memos cannot be recorded for a picture that already has a voice memo attached on it. The current voice memo must be deleted before a new voice memo can be recorded.
- Voice memos cannot be attached to images taken with cameras other than COOLPIX P100.

More Information

See "File and Folder Names" (181) for more information.

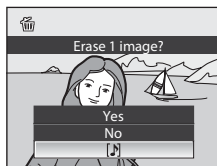



Picture Editing Functions

Use this camera to edit pictures in-camera and store them as separate files (📖181).

Editing function	Application
Quick retouch (📖120)	Easily create a copy with enhanced contrast and richer colors.
D-Lighting (📖121)	Create a copy of the current picture with enhanced brightness and contrast, brightening dark portions of the picture.
Skin softening (📖122)	Make the subject's skin appear smoother.
Small picture (📖124)	Create a small copy of pictures suitable for use on web pages or as e-mail attachments.
Black border (📖125)	Create a copy with a black frame along border of the picture that provides a little more impact.
Crop (📖126)	Crop picture. Enlarge the image or refine the composition and create a copy containing only the portion visible in the monitor.

✓ Notes on Picture Editing

- Editing other than Black border cannot be performed on pictures shot with **Image size** (📖76) of  **3648×2432**,  **3584×2016**, and  **2736×2736**.
- This camera's editing functions cannot be used for pictures taken with cameras other than COOLPIX P100.
- If a copy created using this camera is viewed on cameras other than COOLPIX P100, the picture may not be displayed or may not be transferred to a computer.
- Editing functions are not available when there is not enough free space in the internal memory or on the memory card.
- Perform one of the following operations before editing a sequence (📖102) for which only the key picture is displayed.
 - Select a picture while the sequence playback (📖102) is paused.
 - Set **Sequence display options** (📖116) to **Individual pictures** to display the pictures individually, and then select a picture.

Restrictions on Picture Editing

The following limitations apply when editing pictures that were created by editing.

Copies Created By:	Can Be Edited By:
Quick retouch D-Lighting	Skin softening, small picture, or crop can be used. Quick retouch and D-Lighting cannot be used together.
Skin softening	Quick retouch, D-Lighting, small picture, or crop can be used.
Small picture Crop	No additional editing functions can be used.
Black border	No additional editing functions can be used. A black border cannot be added to a picture created with a different editing function.

- Copies created by editing cannot be edited again using the same edit function.
- To use an editing function together with small picture or crop, use the other edit function first, and use small picture or crop as the last edit function performed on that picture.
- Pictures that were taken using skin softening can be edited using skin softening.



Original Pictures and Edited Copies



- Copies created with editing functions are not deleted if the original pictures are deleted. The original pictures are not deleted if copies created with editing functions are deleted.
- Edited copies are stored with the same recording date and time as the original.
- Even if the pictures that are marked for **Print set** (📖108) or **Protect** (📖113) are used for editing, these settings will not be reflected on the edited copies.

Editing Pictures

Quick Retouch: Enhancing Contrast and Saturation

Easily create retouched images in which contrast and saturation have been enhanced. Retouched copies are stored as separate files.

- 1 Choose the desired picture from full-frame (32) or thumbnail (104) playback mode and press the **MENU** button.

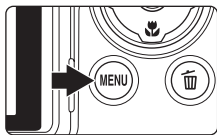

- The playback menu is displayed.
- Switch to the  tab when the playback menu is not displayed (13).

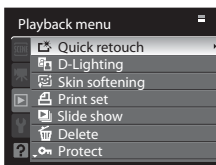

- 2 Use the multi selector to choose  **Quick retouch** and press the **OK** button.

- The original version will be shown on the left and the edited version will be shown on the right.
- If the playback menu is displayed from a mode other than playback mode, choose **Quick retouch** to display the picture selection screen (112). Choose an image to edit and press the **OK** button.



- 3 Choose the extent of the setting using  or , and press the **OK** button.

- A retouched copy is created.
- To cancel, press the **MENU** button.
- Quick retouched copies can be recognized by the  icon displayed during playback.

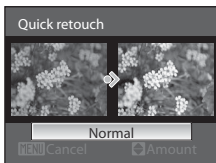



More Information

See "File and Folder Names" (181) for more information.

D-Lighting: Enhancing Brightness and Contrast

D-Lighting can be used to create copies with enhanced brightness and contrast, brightening dark portions of a picture. Enhanced copies are stored as separate files.

- 1 Choose the desired picture from full-frame () or thumbnail () playback mode and press the **MENU** button.

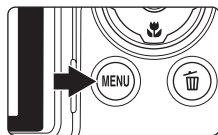

- The playback menu is displayed.
- Switch to the  tab when the playback menu is not displayed ()13).

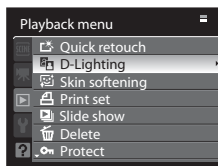

- 2 Use the multi selector to choose  **D-Lighting** and press the **OK** button.

- The original version will be shown on the left and the edited version will be shown on the right.
- If the playback menu is displayed from a mode other than playback mode, choose **D-Lighting** to display the picture selection screen ()112). Choose an image to edit and press the **OK** button.



- 3 Choose the extent of the setting using  or , and press the **OK** button.

- A new, edited copy is created.
 - To cancel, press the **MENU** button.
- D-Lighting copies can be recognized by the  icon displayed during playback.

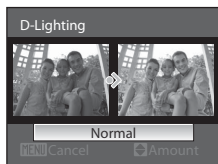



More Information

See "File and Folder Names" ()181) for more information.

Skin Softening: Making Skin Appear Smoother

Skin softening can be applied to faces that are detected in pictures already taken, to make skin appear smoother. Pictures edited with this function are stored as separate files.

- 1 Choose the desired picture from full-frame (32) or thumbnail (104) playback mode and press the **MENU** button.

- The playback menu is displayed.
- Switch to the  tab when the playback menu is not displayed (13).

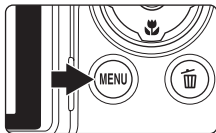

- 2 Use the multi selector to choose  **Skin softening** and press the **OK** button.

- The screen that allows you to set the amount of skin softening appears.
- If no faces can be detected in the image, a warning is displayed and the screen returns to the playback menu.
- If the playback menu is displayed from a mode other than playback mode, the picture selection screen (112) is displayed when **Skin softening** is chosen. Choose an image to edit and press the **OK** button.

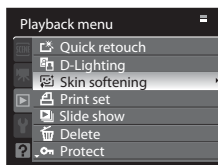

- 3 Press **▲** or **▼** to choose the extent of skin softening to be applied, and press the **OK** button.

- A confirmation screen is displayed, and the image is displayed zoomed in on the face edited by skin softening.
- To cancel, press the **MENU** button.

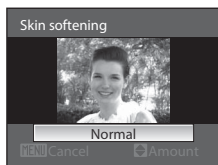

4 Confirm the results.

- Up to 12 faces, in order of proximity to the center of the frame, can be enhanced.
- When multiple faces are edited using skin softening, use the multi selector ◀ and ▶ to switch the face that is displayed.
- To adjust the extent of skin softening, press the **MENU** button and return to step 3.
- Press the **OK** button to create a copy edited with skin softening.
- Copies created by editing with skin softening can be recognized by the  icon displayed during playback.





Note on Skin Softening

Depending on conditions such as the direction the subject is facing or the brightness of the face, the face may not be detected properly, or the desired effect may not be achieved.



More Information

See "File and Folder Names" ( 181) for more information.

Small Picture: Resizing Pictures

Create a small copy of the current picture. Suitable for displaying on web pages or sending as e-mail attachments. The available size is  **640×480**,  **320×240** or  **160×120**. Small copies are stored as separate files with a compression ratio of 1:16.

- 1 Choose the desired picture from full-frame ( 32) or thumbnail ( 104) playback mode and press the **MENU** button.

- The playback menu is displayed.
- Switch to the  tab when the playback menu is not displayed ( 13).

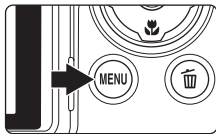

- 2 Use the multi selector to choose  **Small picture** and press the **OK** button.

- If the playback menu is displayed from a mode other than playback mode, choose **Small picture** to display the picture selection screen ( 112). Choose an image to edit and press the **OK** button.

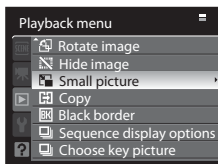

- 3 Choose the desired copy size and press the **OK** button.

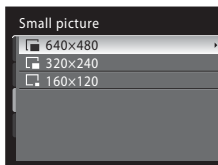

- 4 Choose **Yes** and press the **OK** button.

- A new, smaller copy is created.
- To cancel, choose **No** and press the **OK** button.
- The copy is displayed with a gray frame.

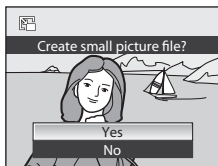

More Information

See "File and Folder Names" ( 181) for more information.

BK Black Border: Adding a Black Border to a Picture

This function creates copies with **Thin**, **Medium**, or **Broad** black lines, along borders of pictures. The created picture is stored as a separate file.

- 1 Choose the desired picture from full-frame (📖32) or thumbnail (📖104) playback mode and press the **MENU** button.

- The playback menu is displayed.
- Switch to the **▶** tab when the playback menu is not displayed (📖13).

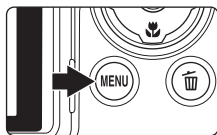

- 2 Use the multi selector to choose **BK** **Black border** and press the **OK** button.

- If the playback menu is displayed from a mode other than playback mode, choose **Black border** to display the picture selection screen (📖112). Choose an image to edit and press the **OK** button.

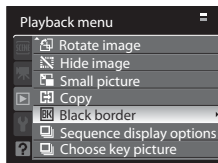

- 3 Choose the desired thickness of frame and press the **OK** button.

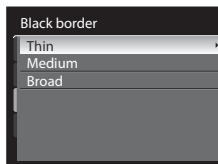

- 4 Choose **Yes** and press the **OK** button.

- A new copy with a black frame is created.
- To cancel, choose **No** and press the **OK** button.

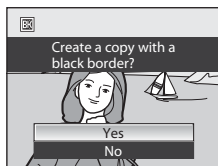

✓ Black Border

- Borders of a picture will be hidden with black lines because black portion is drawn from picture's edges according to their thickness.
- When a picture with a black border is printed using a printer's borderless print function, black frame may not be printed.

🔍 More Information

See "File and Folder Names" (📖181) for more information.

✂ Crop: Cutting Out Part of a Picture

Create a copy containing only the portion visible in the monitor when **MENU** : ✂ is displayed with playback zoom (📖106) enabled. Cropped copies are stored as separate files.

1 Enlarge the desired picture during full-frame display (📖32) by rotating the zoom control to the **T** (🔍) direction.

- To crop a picture displayed in "tall" (portrait) orientation, zoom in on the picture until the black bars displayed on the both sides of the monitor disappear. The cropped picture will be displayed in landscape orientation. To crop the picture in its current "tall" (portrait) orientation, first, use the **Rotate image** option (📖114) to rotate the picture so that it is displayed in landscape orientation. Next, enlarge the picture for cropping, crop the picture, and then rotate the cropped picture back to "tall" (portrait) orientation.

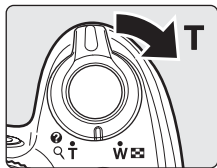

2 Refine copy composition.

- Rotate the zoom control to **T** (🔍) or **W** (📐) to adjust the zoom ratio.
- Press the multi selector ▲, ▼, ◀ or ▶ to scroll the picture until only the portion you want to copy is visible in the monitor.



3 Press the **MENU** button.

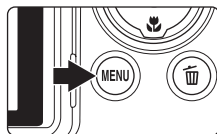

4 Use the multi selector to choose **Yes** and press the **OK** button.

- A new picture, containing only the portion visible in the monitor, is created.
- To cancel, choose **No** and press the **OK** button.



📐 Image Size

As the area to be saved is reduced, the image size (pixels) of the cropped copy is also reduced. When the size of the cropped copy is 320 × 240 or 160 × 120, the small picture icon 🖼 or 🖼 is displayed on the left of the screen in full-frame playback mode.

📖 More Information

See "File and Folder Names" (📖181) for more information.

Recording Movies

You can shoot high-definition movies with sound.

- Regardless of the remaining memory on the memory card, the maximum length for a single movie is 29 minutes.

1 Turn on the camera and display the shooting screen.

- Movies can be recorded in any shooting mode (142).
- The movie options show the type of movie that will be shot. The default setting is **1080p HD 1080p★ (1920×1080)** (133).

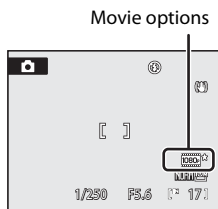

2 Rotate the movie mode switch to HD.

- Lower the built-in flash. If the built-in flash is raised, it may disturb the recording.

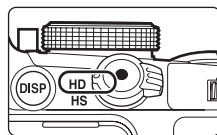

3 Press the ● (movie-record) button to start the movie recording.

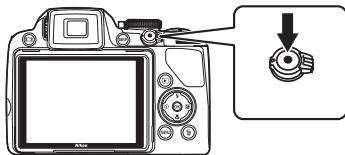

- The LCD monitor turns off for a moment, and then the movie recording starts.
- The camera focuses in the center of the frame. The focus area is not displayed while the movie is recorded.
- When shooting high-definition or full high-definition movies, the aspect ratio of the shooting screen is switched to 16:9 (The movie is recorded in the range shown in the screen on the right).
- A progress bar at the bottom of the monitor shows the amount of recording time remaining. Recording stops automatically when the recording time runs out.

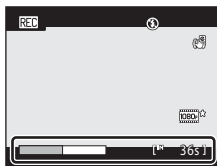

4 Press the ● (movie-record) button to end recording.

✔ Notes on Movie Recording

- When recording a movie onto a memory card, a memory card with an SD speed class of Class 6 or higher is recommended (📖180). If the transfer speed of the card is slow, the movie recording may end unexpectedly.
- When recording movies, the angle of view (recorded range) is smaller than that of still pictures.
- Using a digital zoom causes image quality to deteriorate. If you start recording the movie without using digital zoom, and you rotate the zoom control in the **T** direction, the zoom stops at the maximum optical zoom ratio. Release the zoom control and rotate it again in the **T** direction to trigger digital zoom. The digital zoom is cancelled when movie recording is finished.
- The sound of the zoom control operation, camera zooming or auto focusing may be recorded.
- The following phenomena may occur on a monitor display during movie shooting. These phenomena will be recorded on the shot movie.
 - Banding on the picture under lights such as fluorescent, mercury vapor or sodium lamps
 - Distortion of subjects that move at high speed through the frame, such as trains or cars
 - Distortion of the entire frame when the camera is panned horizontally
 - After-images left by bright areas such as light sources when the camera is panned



✔ Notes on Autofocus

- If **Autofocus mode** in the movie menu is set to **AF Single AF** (default setting), the focus is locked when the ● (movie-record) button is pressed to start movie recording (📖135).
- Autofocus may not perform as expected (📖31). Should this occur, try the following:
 1. Before recording, set **Autofocus mode** in the movie menu to **AF Single AF** (default setting).
 2. Position a different subject at the same distance in the middle of the screen. Press the ● (movie-record) button to start the movie recording, and change the composition.

✔ Note on Recording Movies

When the movie has been fully recorded to the internal memory or memory card, the monitor display will revert to the shooting display. **Do not open the battery-chamber/memory card slot cover while pictures are being recorded.** Turning the camera off or removing the memory card while movies are being recorded could result in loss of data or in damage to the camera or card.

Functions Available in Movie Recording

- Movies are recorded with the same hue adjustment as  (auto mode) in any shooting mode (142). Settings such as the hue adjustment in scene mode and **Optimize image** or **White balance** in the shooting menu (173) are not applied to movies.
- When the shooting mode is **P**, **S**, **A**, **M** or **U**, the **Metering** (185) setting is also applied to the movie recording (except for **Spot AF area**).
- The focus mode and exposure compensation settings are also applied to the movie that is recorded. Check the settings before starting to record the movie.
- The self-timer (137) is available. When the  (movie-record) button is pressed after setting the self-timer, the camera focuses after ten seconds or two seconds, and then the movie recording starts.
- The flash will not fire.
- Press the **MENU** button before starting to record the movie and switch to the  (movie) tab to select movie menu settings (132).
- To reduce the effects of camera shake when recording movies, set **Electronic VR** (136) in the movie menu.

Recording Slow Motion Movies or Fast Motion Movies (HS Movie)

After the movie mode switch is rotated to HS and movie recording is started, when the **OK** button is pressed during recording, the mode switches to high speed (HS) recording (HS movie recording). The section that is shot as an HS movie can be played in slow motion from 1/8 to 1/2 the speed of normal playback, or it can be played speeded up to twice the normal speed.

1 Turn on the camera and rotate the movie mode switch to HS.

- The HS movie options show the type of HS movie that will be shot (134).
- Lower the built-in flash. If the built-in flash is raised, it may disturb the recording.

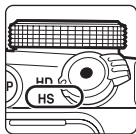

HS movie options

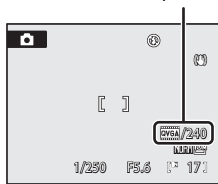

2 Press the **REC** (movie-record) button to start the movie recording.

- The LCD monitor turns off for a moment, and then the movie recording starts.
- The camera focuses in the center of the frame. The focus area is not displayed while the movie is recorded.
- In the default setting, movies are recorded with a resolution of 320x240 pixels.

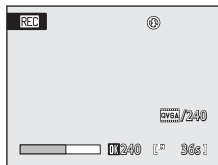

3 Press the **OK** button when you want to start recording the HS movie.

- HS movie recording starts.
- In the default setting, up to ten seconds of a movie can be shot with a slow motion playback of 1/8 the speed of a normal movie.
- The remaining time display changes to the remaining time for the HS movie recording. Recording stops automatically when the remaining time runs out.
- Once the HS movie recording starts, the camera cannot be switched to normal speed movie recording.

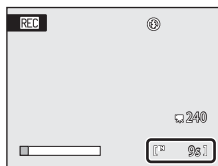

4 Press the **REC** (movie-record) button to end recording.

✓ Notes on HS Movie

- Sound is not recorded for the section shot for slow motion or speeded up playback.
- The vibration reduction function is not available during movie recording while the movie mode switch is rotated to HS. The zoom position, focus, exposure and white balance are fixed when the (movie-record) button is pressed to start movie recording.

📹 HS Movies

When **HS movie options** (📖134) is set to **240 fps**, **120 fps** or **60 fps**, a movie can be recorded for which slow motion playback is possible. When **15 fps** is set, a movie can be shot for which speeded up playback at twice the normal speed is possible.

- The shooting frame rate before pressing the (OK) button is 30 frames per second (fps).
- The shot movie, including the section shot as an HS movie, is played at 30 fps.

When recording at 240 fps:

When shooting, up to ten seconds of a movie is recorded at high speed. The section recorded at high speed is played in slow motion eight times longer than at normal speed.

Press the (OK) button to start HS movie recording.

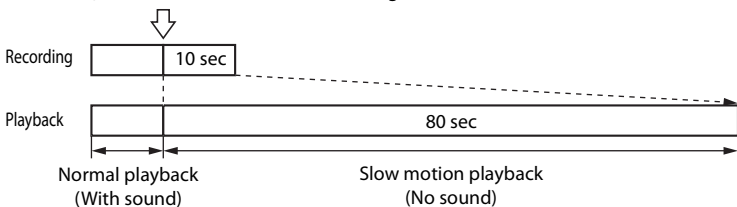

When recording at 15 fps:

When shooting, up to two minutes of a movie is recorded for speeded up playback. It is played twice the speed of a normal movie.

Press the (OK) button to start HS movie recording.

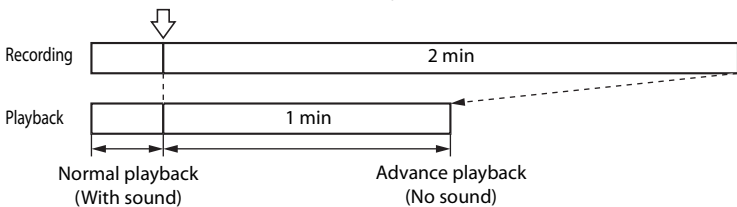

📹 Starting Recording with HS Movie

When the **Open with HS footage** check box in **HS movie options** is selected (✓), HS movie recording starts immediately when movie recording is started.

Movie Menu

The options below can be set in the movie menu.

- 🔊 **Movie options** 📖 133
 Options can be selected for the movie that is shot when the movie mode switch is rotated to HD.
- 🔊 **HS movie options** 📖 134
 Options can be selected for the movie that is shot when the movie mode switch is rotated to HS.
- 🔊 **Autofocus mode** 📖 135
 Choose how the camera focuses when recording movies with the movie mode switch rotated to HD.
- 👁️ **Electronic VR** 📖 136
 Enable or disable electronic VR when recording movies with the movie mode switch rotated to HD.
- 🔊 **Wind noise reduction** 📖 136
 Set whether or not to reduce wind noise during movie recording.

Displaying the Movie Menu

Press the **MENU** button to display the menu screen, and switch to the 🔊 tab (📖 13).

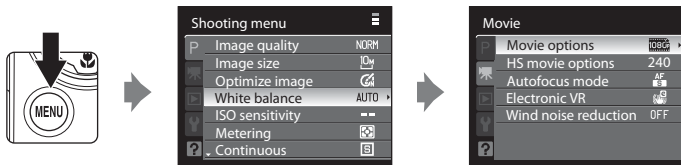





- Press the multi selector to select items and set functions on the menu (📖 12).
- Press the **MENU** button to exit the movie menu.

🎬 Movie Options

Press **MENU** button → 🎬 (Movie menu) (📖132) → **Movie options**

Options can be selected for the movie that is shot when the movie mode switch is rotated to HD. The higher the resolution and bitrate, the higher the picture quality; but the file size also becomes larger.

Option	Description
 HD 1080p★ (1920×1080) (default setting)	Movies with an aspect ratio of 16:9 are recorded in full high-definition. This option is suited to playback on a wide screen TV that is compatible with full high-definition. <ul style="list-style-type: none"> • Image size: 1920×1080 pixels • Movie bitrate: 14 Mbps
 HD 1080p (1920×1080)	Movies with an aspect ratio of 16:9 are recorded in full high-definition. This option is suited to playback on a wide screen TV that is compatible with full high-definition. <ul style="list-style-type: none"> • Image size: 1920×1080 pixels • Movie bitrate: 12 Mbps
 HD 720p (1280×720)	Movies with an aspect ratio of 16:9 are recorded in high-definition. This option is suited to playback on a wide screen TV. <ul style="list-style-type: none"> • Image size: 1280×720 pixels • Movie bitrate: 9 Mbps
 VGA (640×480)	Movies with an aspect ratio of 4:3 are recorded. <ul style="list-style-type: none"> • Image size: 640×480 pixels • Movie bitrate: 3 Mbps
 QVGA (320×240)	Movies with an aspect ratio of 4:3 are recorded. <ul style="list-style-type: none"> • Image size: 320×240 pixels • Movie bitrate: 640 kbps

- The movie bitrate is the volume of movie data recorded per second. As a variable bitrate (VBR) system has been adopted, the movie recording rate varies automatically according to the subject so that more data is recorded per second for movies containing frequently moving subjects, thus increasing movie file size.
- The frame rate is approximately 30 frames per second (fps) in any options.

More Information

See "Maximum Movie Length" (📖135) for more information.

🎬 HS Movie Options

Press **MENU** button → 🎬 (Movie menu) (📖132) → HS movie options

Options can be selected for the movie that is shot when the movie mode switch is rotated to HS.

Option	Description
240 fps (default setting)	Slow motion movies with an aspect ratio of 4:3 are recorded at 1/8 the speed of a normal movie. <ul style="list-style-type: none"> • Maximum recording time*: 10 seconds (playback time: 80 seconds) • Image size: 320×240 pixels • Movie bitrate: 640 kbps
120 fps	Slow motion movies with an aspect ratio of 4:3 are recorded at 1/4 the speed of a normal movie. <ul style="list-style-type: none"> • Maximum recording time*: 10 seconds (playback time: 40 seconds) • Image size: 640×480 pixels • Movie bitrate: 3 Mbps
60 fps	Slow motion movies with an aspect ratio of 16:9 are recorded at half the speed of a normal movie. <ul style="list-style-type: none"> • Maximum recording time*: 30 seconds (playback time: 1 minute) • Image size: 1280×720 pixels • Movie bitrate: 9 Mbps
15 fps	Fast motion movies with an aspect ratio of 16:9 are recorded at twice the speed of a normal movie. <ul style="list-style-type: none"> • Maximum recording time*: 2 minutes (playback time: 1 minute) • Image size: 1920×1080 pixels • Movie bitrate: 12 Mbps



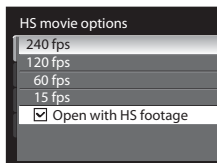

* The maximum recording time refers only to the section shot for slow motion or speeded up playback.

Open with HS Footage Check Box

When **Open with HS footage** is selected and the **OK** button is pressed to select the check box [✓], HS movie recording starts immediately when the movie recording starts. The default setting is off.



Maximum Movie Length

Option	Internal memory (43MB)	Memory card (4GB)*
 HD 1080p★ (1920×1080) (default setting)	23 s	34 min
 HD 1080p (1920×1080)	26 s	39 min 25 s
 HD 720p (1280×720)	34 s	50 min
 VGA (640×480)	1 min 37 s	2 h 5 min
 QVGA (320×240)	4 min 34 s	4 h 45 min

All figures are approximate. The maximum recording time may vary by make of memory card and the bitrates at which the movie was recorded.

* The maximum recording time for a single movie is 29 minutes. The maximum movie length displayed during recording is 29 minutes, even when there is enough free space on the memory card for a longer movie.



More Information

See "File and Folder Names" (📖181) for more information.

Autofocus Mode

Press MENU button →  (Movie menu) (📖132) → Autofocus mode

Choose how the camera focuses when recording movies with the movie mode switch rotated to HD.

Option	Description
 Single AF (default setting)	Focus is locked when the ● (movie-record) button is pressed.
 Full-time AF	During movie recording, camera focuses continuously until focus is locked. The sound of the focusing operation may be recorded during shooting. To prevent sound of camera focusing from interfering with recording, use of Single AF is recommended.

Autofocus Mode during Movie Shooting

- When the scene mode is **Fireworks show**, the focus is fixed at infinity.
- When the focus mode is **MF** (manual focus), the focus is fixed before movie recording starts.

Electronic VR

Press **MENU** button →  (Movie menu) (📖132) → Electronic VR

Enable or disable electronic VR when recording movies with the movie mode switch rotated to HD.

Option	Description
On (default setting)	Reduces the effects of camera shake in movie modes.
Off	Electronic VR is not enabled.

When the electronic VR is set to **On**,  is displayed on the screen when movie recording starts (📖8).

Note on Electronic VR

Electronic VR is not available when recording HS movies.

Wind Noise Reduction

Press **MENU** button →  (Movie menu) (📖132) → Wind noise reduction

Set whether or not to reduce wind noise during movie recording.

Option	Description
On	Records while minimizing the noise of wind blowing on the microphone. Suitable for recording in strong winds. During playback, not only wind noise, but other sounds may also become difficult to hear.
Off (default setting)	Wind noise is not reduced.

When the wind noise reduction setting is enabled, the current setting is displayed during shooting (📖8). When **Off** is selected, an icon for the current setting is not displayed.

Movie Playback

In full-frame playback mode (📖32), movies are recognized by the movie options icon (📖133). To play a movie, display it in full-frame playback mode and press the **OK** button.

Use the zoom control **T** or **W** during playback to adjust the volume.

Playback controls appear at the top of the monitor. Press the multi selector ◀ or ▶ to choose a playback control, then press the **OK** button to perform the selected operation.

The following operations are available.

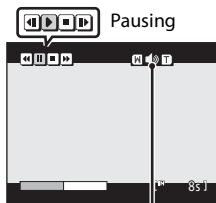
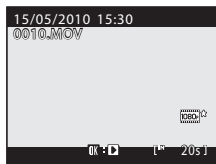

During playback Volume indicator

To	Use	Description	
Rewind	◀	Rewind the movie when the OK button is pressed down.	
Advance	▶	Advance the movie when the OK button is pressed down.	
Pause	⏸	The following operations can be performed with the playback controls at the top of the monitor while playback is paused.	
		◀	Rewind the movie by one frame. Rewind continues while the OK button is pressed.*
		▶	Advance the movie by one frame. Advance continues while the OK button is pressed.*
	▶	Resume playback.	
End	⏹	Return to full-frame playback mode.	

* The movie can also be advanced or rewound by one frame by rotating the command dial.

Deleting Movie

Press the **Trash** button, when displayed in full-frame playback mode (📖32), or when selected in thumbnail (📖104) playback mode.

Select **Yes** and press the **OK** button to delete the movie, or select **No** to exit without deleting the movie.

✔ Note on Movie Playback

Movies recorded with cameras other than COOLPIX P100 cannot be played back.

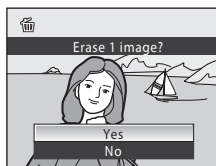

Connecting to a TV

Connect the camera to a television to play back pictures on the television. If your television is equipped with an HDMI connector, you can connect it to the camera with an HDMI cable to enjoy recorded movies in the high-definition quality.

1 Turn off the camera.

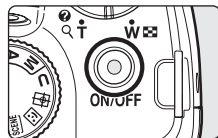

2 Connect the camera to the TV.

When connecting using the supplied audio/video cable

- Connect the yellow plug to the video-in jack on the TV, and the white plug to the audio-in jack.

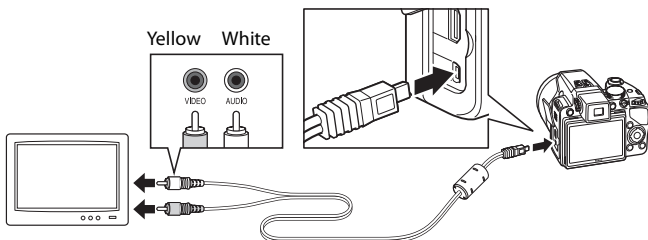

When connecting using the optional HDMI cable

- Connect the plug to the HDMI jack on the TV.

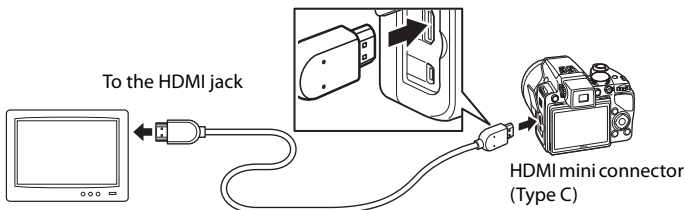

3 Tune the television to the video channel.

- See the documentation provided with your television for details.

4 Hold down the button to turn on the camera.

- The camera enters playback mode, and pictures recorded to the internal memory, or memory card, will be displayed on the television.
- While the camera is connected to the TV, the monitor will remain off.

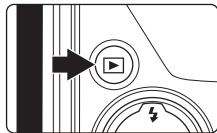

Notes on Connecting an HDMI Cable

- An HDMI cable is not supplied. Use a third-party HDMI cable to connect the camera to a TV. The output terminal on this camera is a HDMI Mini Connector (Type C). When purchasing an HDMI cable, be sure that the device end of the cable is a HDMI Mini Connector.
- To enjoy playback in high-definition quality when the camera is connected to a television that has an HDMI connector, we recommend shooting still pictures with **Image size** set to  **2048x1536** or higher, and recording movies with **Movie options** set to  **HD 720p (1280x720)** or higher.

Notes on Connecting the Audio/Video Cable

- When connecting the audio/video cable, be sure that the connectors are oriented correctly. Do not use force when connecting the audio/video cable. When disconnecting the audio/video cable, do not pull the connector at an angle.
- Do not connect an audio/video cable and HDMI cable to the camera at the same time.
- Do not connect an HDMI cable and USB cable to the camera at the same time.

When Nothing Appears on the TV

Make sure that the **TV settings** ( 167) in the setup menu ( 152) are appropriate for your television.

Connecting to a Computer

Use the supplied USB cable to connect the camera to a computer, and copy (transfer) pictures to a computer with the supplied Nikon Transfer software.

Before Connecting the Camera

Install the Software

Before connecting the camera to a computer, software, including Nikon Transfer, ViewNX for displaying transferred pictures, and Panorama Maker for creating panorama photos, must be installed using the supplied Software Suite CD.

For more information on installing the software, refer to the *Quick Start Guide*.

Compatible Operating Systems

Windows

- Windows 7 (Home Basic/Home Premium/Professional/Enterprise/Ultimate editions)
- Windows Vista Service Pack 2 (Home Basic/Home Premium/Business/Enterprise/Ultimate editions)
- 32-bit versions of Windows XP Service Pack 3 (Home Edition/Professional)

Macintosh

- Mac OS X (version 10.4.11, 10.5.8, 10.6)

For details about the movie playback conditions for high-definition and full high-definition movies, see the ViewNX help information (📖144).

Refer to the Nikon website for the latest information on operating system compatibility.

✔ Note on Computer Connection

Disconnect other USB devices such as commercial USB chargers from the computer. Simultaneous connection of the camera and other USB devices to the computer could result in operation malfunction or excessive supply of power to the camera, causing damage to the camera or memory card. Refer to the documentation supplied with other USB devices for more information.

✔ Notes on Power Source

- When connecting the camera to a computer to transfer pictures, use a fully charged battery to prevent the camera from turning off unexpectedly.
- When the camera is connected to a computer via the supplied USB cable with **Auto** (default setting) selected for the **Charge by computer** option (📖145, 168) in the setup menu, the battery inserted into the camera is automatically charged using power supplied by the computer. Pictures can be transferred while the battery is charging.
- If the AC Adapter EH-62A (available separately) is used, COOLPIX P100 can be powered from an electrical outlet. Do not use any other make or model of AC adapter as they may cause the camera to overheat or malfunction.

Transferring Pictures from a Camera to a Computer

- 1 Start the computer to which Nikon Transfer was installed.
- 2 Be sure that the camera is off.
- 3 Connect the camera to the computer using the supplied USB cable.

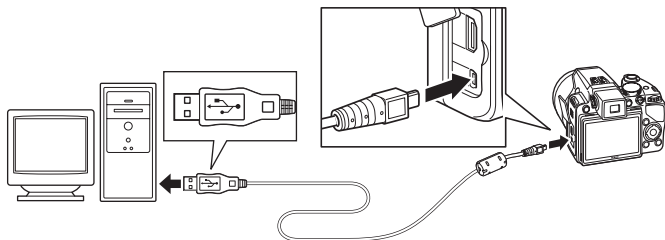

- The camera turns on automatically and the power-on lamp glows or blinks (📖145). The camera monitor will remain off.

✔ Connecting the USB Cable

- Be sure that connectors are properly oriented. Do not attempt to insert connectors at an angle, and do not use force when connecting or disconnecting the USB cable.
- The connection may not be recognized if the camera is connected to the computer via a USB hub.

4 Start Nikon Transfer installed on the computer.

- **Windows 7**

When the **Devices and Printers ► P100** screen is displayed, click **Change program** under **Import pictures and videos**. Select **Copy pictures to a folder on my computer** in the **Change program** dialog and click **OK**.

Double-click **Copy pictures to a folder on my computer** on the **Devices and Printers ► P100** screen.

- **Windows Vista**

When the **AutoPlay** dialog is displayed, click **Copy pictures to a folder on my computer using Nikon Transfer**.

- **Windows XP**

When the action selection dialog is displayed, select **Nikon Transfer Copy pictures to a folder on my computer**, and click **OK**.

- **Mac OS X**

Nikon Transfer will start automatically when the camera is connected if **Yes** was selected in the **Auto-Launch setting** dialog when Nikon Transfer was first installed.

- When the level of the battery in the camera is low, the computer may not recognize the camera and it may not be possible to transfer pictures. If the power from the computer starts to charge the camera battery, wait until the battery level rises.
- If there are a large number of images on the memory card, it may take some time for Nikon Transfer to start.

- 5** Confirm that the source device is displayed in the transfer options **Source** panel and click **Start Transfer**.

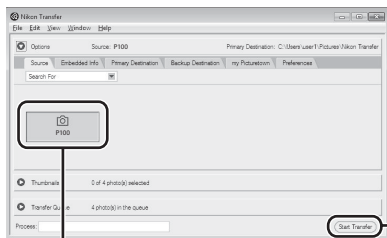

Source device

Start Transfer button

At the Nikon Transfer default settings, all pictures are transferred to the computer. At the Nikon Transfer default settings, ViewNX starts automatically when transfer is complete and transferred pictures can be viewed.

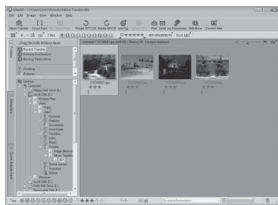

For more information on using Nikon Transfer or ViewNX, refer to the help information contained in Nikon Transfer or ViewNX (144).

Disconnecting the Camera

Do not turn off the camera or disconnect the camera from the computer during transfer.

When transfer is complete, turn off the camera and disconnect the USB cable.

The camera turns off automatically if there is no communication with the computer for 30 minutes while the camera is connected via the USB cable.

Charging the Battery

When the camera's power-on lamp is blinking slowly in orange, the battery inserted in the camera is charging (145).

Using a Card Reader

The pictures stored on the memory card inserted into a card reader or similar device can also be transferred to the computer using Nikon Transfer.

- If the memory card capacity is 2 GB or more, or if the memory card is SDHC-compliant, the card reader or similar device must support these memory card specifications.
- Insert a memory card into the card reader or similar device, and refer to the steps 4 and 5 (📖142) to transfer pictures.
- To transfer pictures stored in the camera's internal memory to the computer, the pictures must first be copied to a memory card using the camera (📖115).

Starting Nikon Transfer or ViewNX Manually

Windows:

Choose **Start** menu>**All Programs**>**Nikon Transfer**>**Nikon Transfer** (or **All Programs**>**ViewNX**>**ViewNX**).

Double-clicking the Nikon Transfer or ViewNX shortcut icon on the desktop will also start Nikon Transfer or ViewNX.

Macintosh:

Open **Applications** and double-click **Nikon Software**>**Nikon Transfer**>**Nikon Transfer** (or **Nikon Software**>**ViewNX**>**ViewNX**).

Clicking the Nikon Transfer or ViewNX icon on the Dock will also start Nikon Transfer or ViewNX.

Viewing Nikon Transfer and ViewNX Help Information

For more information on Nikon Transfer or ViewNX, start Nikon Transfer or ViewNX and select **Nikon Transfer Help** or **ViewNX Help** from the **Help** menu.

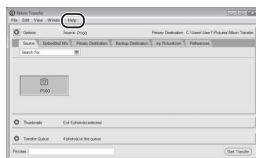

Panorama Creation with Panorama Maker

- Use a series of pictures taken in **Panorama assist** scene mode (📖52) to create a single panorama photo with Panorama Maker.
- Panorama Maker can be installed on a computer using the supplied Software Suite CD-ROM.
- After installation is complete, follow the procedure described below to start Panorama Maker.

Windows:

Choose **Start** menu, open **All Programs**>**ArcSoft Panorama Maker 5**>**Panorama Maker 5**.

Macintosh:

Open **Applications** and double-click the **Panorama Maker 5** icon.

- For more information on using Panorama Maker, refer to the on-screen instructions and help information contained in Panorama Maker.

Image File Names and Folder Names

See "File and Folder Names" (📖181) for more information.

Charging While Connecting to a Computer

When connecting the camera to a computer via the supplied USB cable while **Auto** (default setting) is selected for the **Charge by computer** option (📖168) in the setup menu, the battery inserted into the camera is automatically charged using power supplied by the computer.

See “Before Connecting the Camera” (📖140) and “Transferring Pictures from a Camera to a Computer” (📖141) for more information on connecting the camera to a computer.

Power-on Lamp

The following chart explains power-on lamp status when the camera is connected to a computer.

Status	Description
Slow blinking (orange)	Battery charging.
Glows (green)	Battery not charging. Charging is complete when the power-on lamp stops blinking orange and glows green.
Flickers (orange)	<ul style="list-style-type: none"> Operating temperature range exceeded. Charge the battery indoors with an ambient temperature of 5°C to 35°C (41°F to 95°F) before use. A USB cable is not correctly connected or the battery is faulty. Reconnect the USB cable correctly or replace the battery. Computer is in sleep mode and does not supply power. Reboot a computer. The battery cannot be charged as computer's specifications or settings does not support power supply to the camera.

✓ Notes on Charging with Connection to a Computer

- The battery cannot be charged, nor can data be transferred, when the camera is connected to a computer before the camera's date and time have been set (📖22). If the camera's clock battery (📖156) has been exhausted, the date and time must be reset before the battery can be charged or images can be transferred with connection to a computer. In this case, use the Charging AC Adapter EH-68P (📖18) to charge the battery and then set the camera's date and time.
- If the camera is turned off, charging will also stop.
- If a computer enters sleep mode while charging, charging will stop and the camera may be turned off.
- When disconnecting the camera from a computer, turn the camera off and then disconnect the USB cable.
- About six hours are required to charge a fully exhausted battery. Charging time increases when images are transferred while the battery is charging.
- When the camera is connected to a computer, an application installed on the computer, such as Nikon Transfer, may start. If the camera was connected to the computer for the sole purpose of charging the battery, exit the application.
- The camera turns off automatically if there is no communication with the computer for 30 minutes after the battery has finished charging.
- Depending upon computer specifications, settings, and power supply and allocation, it may be impossible to charge the battery inserted into the camera via computer connection.

Connecting to a Printer

Users of PictBridge-compatible (📖198) printers can connect the camera directly to the printer and print pictures without using a computer. The steps for printing are as follows.

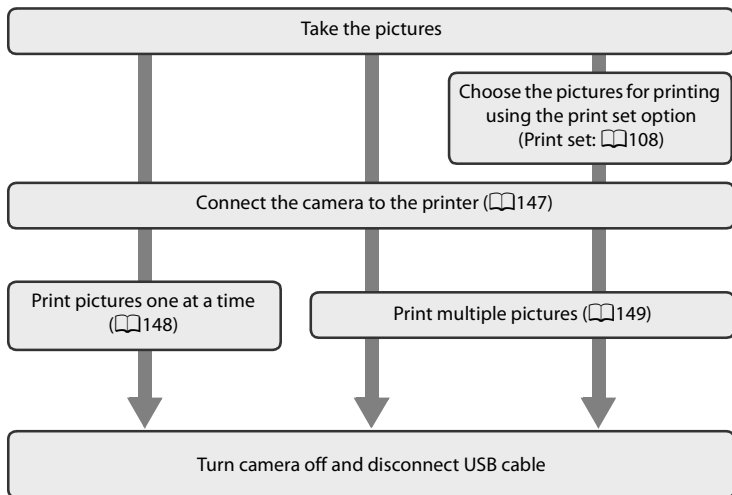

✓ Notes on Power Source

- When connecting the camera to a printer, use a fully charged battery to prevent the camera from turning off unexpectedly.
- The AC Adapter EH-62A (available separately from Nikon) can be used to power the camera using an electrical outlet. Do not, under any circumstances, use another make or model of AC adapter. Failure to observe this precaution could result in overheating or in damage to the camera.

✓ Printing Pictures

In addition to printing pictures transferred to a computer and printing over a direct camera-to-printer connection for images recorded in the memory card, the following options are also available for printing pictures:

- Insert a memory card into a DPOF-compatible printer's card slot.
- Take a memory card to a digital photo lab.

For printing using these methods, specify the pictures and the number of prints each using the **Print set** (📖108) option in the playback menu.

Connecting the Camera and Printer

- 1 Turn off the camera.

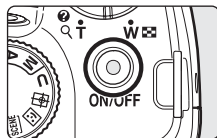

- 2 Turn on the printer.

- Check printer settings.

- 3 Connect the camera to the printer using the supplied USB cable.

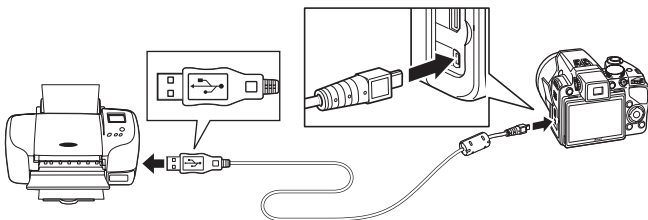

- 4 The camera turns on automatically.

- When connected correctly, the **PictBridge** startup screen (①) will be displayed in the camera monitor. Then the **Print selection** screen (②) will be displayed.

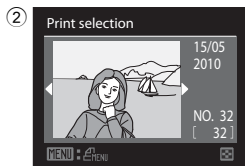
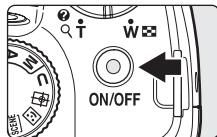

✓ Connecting the USB Cable

When connecting the USB cable, be sure that the connectors are oriented correctly. Do not use force when connecting the USB cable. When disconnecting the USB cable, do not pull the connector at an angle.

✓ If the PictBridge Screen is not Displayed

Turn off the camera and disconnect the USB cable. Set **Charge by computer** (🗨️ 168) in the camera's setup menu to **Off**, then connect the camera again.

More Information

See "Printing Images of Size 1:1" (📖78) for more information.

Printing Pictures One at a Time

After connecting the camera to the printer correctly (📖147), print pictures by following the procedure below.

1 Use the multi selector to choose the picture to be printed and press the button.

- Pictures can also be chosen by rotating the command dial.
- Rotate the zoom control to **W** (📷) to display 12 thumbnails, or to **T** (📺) to switch back to full-frame playback.

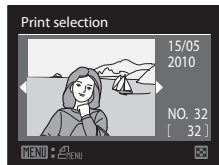

2 Choose **Copies** and press the button.

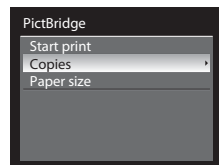

3 Choose the number of copies (up to nine) and press the button.



4 Choose **Paper size** and press the button.

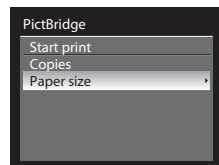

5 Choose the desired paper size and press the **OK** button.

- To specify paper size using printer settings, choose **Default** in the paper size menu.

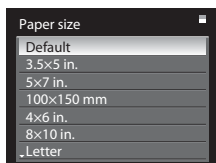

6 Choose **Start print** and press the **OK** button.

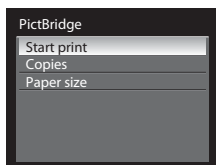

7 Printing starts.

- Monitor display returns to that shown in step 1 when printing is complete.
- To cancel before all copies have been printed, press the **OK** button.

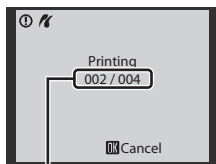

Current print/total number of prints

Printing Multiple Pictures

After connecting the camera to the printer correctly (147), print pictures by following the procedure below.

1 When the **Print selection** screen is displayed, press the **MENU** button.

- The **Print menu** is displayed.

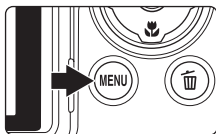

2 Use the multi selector to choose **Paper size** and press the **OK** button.

- To exit the print menu, press the **MENU** button.

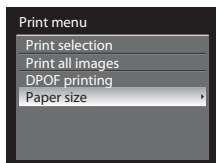

3 Choose the desired paper size and press the **OK** button.

- To specify paper size using printer settings, choose **Default** in the paper size menu.

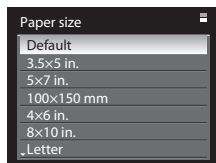

4 Choose **Print selection**, **Print all images** or **DPOF printing** and press the **OK** button.

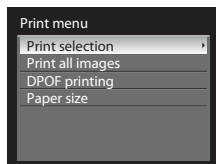

Print selection

Choose the pictures (up to a maximum of 99) and number of copies (up to nine per picture).

- Press the multi selector ◀ or ▶ to choose the pictures, and press ▲ or ▼ to set the number of copies for each.
- Pictures can also be chosen by rotating the command dial.
- Pictures selected for printing can be recognized by the check mark icon and the numeral indicating the number of copies to be printed. A check mark is not displayed with pictures for which no copies have been specified and these pictures will not be printed.
- Rotate the zoom control to **T** (Q) to switch to full-frame playback, or **W** (R) to switch to 12 thumbnails display.
- Press the **OK** button when setting is complete.
- The menu shown at right will be displayed. To print, choose **Start print** and press the **OK** button.
- Choose **Cancel** and press the **OK** button to return to the print menu.

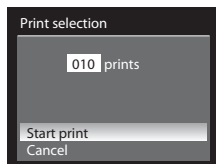

Print all images

All pictures stored in the internal memory, or on the memory card, are printed one at a time.

- The menu shown at right will be displayed. To print, choose **Start print** and press the **OK** button.
- Choose **Cancel** and press the **OK** button to return to the print menu.

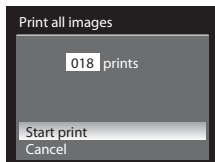
**DPOF printing**

Print pictures for which a print order was created in **Print set** option (108).

- The menu shown at right will be displayed. To print, choose **Start print** and press the **OK** button.
- Choose **Cancel** and press the **OK** button to return to the print menu.
- To view the current print order, choose **View images** and press the **OK** button. To print pictures, press the **OK** button again.

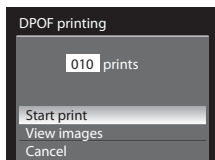
**5 Printing starts.**

- Monitor display returns to that shown in step 2 when printing is complete.
- To cancel before all copies have been printed, press the **OK** button.

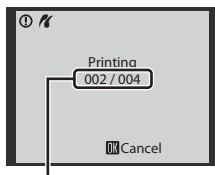



































Current print/total number of prints

 Paper Size

The camera supports the following paper sizes: **Default** (the default paper size for the current printer), **3.5x5 in.**, **5x7 in.**, **100x150 mm**, **4x6 in.**, **8x10 in.**, **Letter**, **A3**, and **A4**. Only sizes supported by the current printer will be displayed.

Setup Menu

The setup menu contains the following options.

	Welcome screen	 154
	Choose whether or not to display the welcome screen on the monitor when the camera is turned on.	
	Date	 155
	Set camera clock and choose home and destination time zones.	
	Monitor settings	 158
	Adjust post-shooting image review and monitor brightness settings.	
	Date imprint	 159
	Imprint the date on pictures.	
	Vibration reduction	 160
	Choose whether or not vibration reduction is enabled when shooting still pictures.	
	Motion detection	 162
	Enable motion detection to reduce the effects of camera shake and subject movement when shooting still pictures.	
	AF assist	 163
	Enable or disable AF-assist illumination.	
	Red-eye reduction	 163
	Choose the red-eye reduction method when the flash mode is auto with red-eye reduction.	
	Digital zoom	 164
	Enable or disable digital zoom.	
	Sound settings	 165
	Adjust sound settings.	
	Auto off	 165
	Set time before camera enters standby mode to save power.	
	Format memory/Format card	 166
	Format internal memory or memory card.	
	Language	 167
	Choose language used for camera monitor display.	
	TV settings	 167
	Adjust settings necessary for connection to TV.	
	Charge by computer	 168
	Choose whether or not the battery is charged when the camera is connected to a computer via USB cable.	
	Blink warning	 169
	Choose whether or not to detect blinking eyes when shooting pictures using face priority.	
	Reset all	 171
	Restore camera settings to default values.	

- | | | |
|------------|----------------------------------|-------|
| R | Reset file numbering | 📖 174 |
| | Reset the file numbering. | |
| Ver | Firmware version | 📖 174 |
| | Display camera firmware version. | |

Displaying the Setup Menu

Switch to the **Y** tab in the menu screen.

- 1 Press the **MENU** button to display the menu screen.

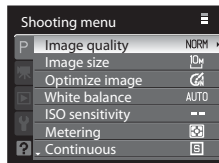

- 2 Press **◀** on the multi selector.

- Tab will be selectable.
- See "The Multi Selector" (📖 12).

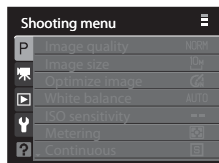

- 3 Press **▲** or **▼** to select the **Y** tab.

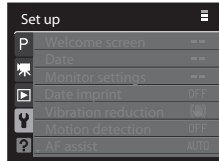

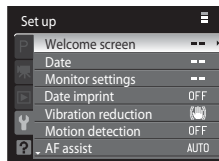

- 4 Press **▶** or the **OK** button.

- The setup menu items will be selectable.
- Press the multi selector to select items and set functions on menus (📖 12).
- To exit the setup menu, press the **MENU** button or press **◀** and switch to another tab.



Welcome Screen

Press the **MENU** button →  (Setup menu) ( 153) → Welcome screen

Choose whether or not to display the welcome screen on the monitor when the camera is turned on.

None (default setting)







Displays the shooting or playback screen without displaying the welcome screen.

COOLPIX



Displays the welcome screen before displaying the shooting or playback screen.

Select an image

Select a picture that you have shot to display as the welcome screen. Display the picture selection screen, choose a picture ( 112), and press the  button to register it.

- As the selected picture is stored in the camera, the picture will appear in the welcome screen even if the original picture is deleted.
- Pictures shot with **Image size** ( 76) of  **3648×2432**,  **3584×2016**, and  **2736×2736** cannot be stored.
- Pictures reduced to 160×120 or smaller using small picture editing ( 124) and cropping ( 126), cannot be selected.

Date







Press the **MENU** button →  (Setup menu) (153) → Date

Set the camera's internal clock.

Date



Set camera clock to the current date and time.

Use the multi selector to set the date and time.

- Highlight an item (day, month, year, hour, minute, and the order in which day, month, and year are displayed): Press  or .
- Edit the highlighted item: Press  or .
- Finish setting: After selecting the order in which the day, month, and year are displayed, press the  button (23).

Time zone

 (home time zone) can be specified and daylight saving enabled or disabled from time zone options.

When  (travel destination) is selected, the time difference (157) from the home time zone () is automatically calculated and the date and time in the selected region are recorded. Useful when travelling.

Setting the Travel Destination Time Zone

1 Use the multi selector to choose **Time zone** and press the .

- The **Time zone** screen is displayed.

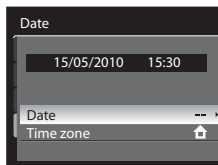

2 Choose  **Travel destination** and press the .

- The date and time displayed on the monitor changes according to the region currently selected.

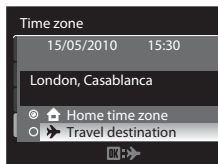

3 Press **▶**.

- The time zone selection screen is displayed.

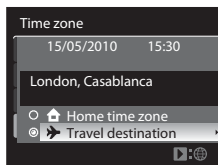
**4** Press **◀** or **▶** to choose the travel destination time zone.

- When using the camera in an area where daylight saving time is in effect, press **▲** to set the clock to daylight saving time. When daylight saving time is turned on, the icon is displayed and the clock advances by one hour. To turn off the daylight saving time option, press **▼**.
- Press the **OK** button to choose the travel destination time zone.
- While the travel destination time zone is selected, the icon will be displayed in the monitor when the camera is in shooting mode.

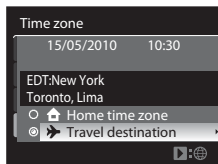
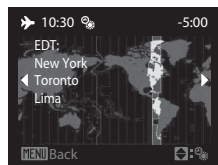
**✓ The Clock Battery**

The camera's internal clock uses a different battery from the camera's battery. The clock battery charges when the main battery is installed or the AC adapter is connected, and provides several days of clock battery power after about ten hours of charging.

✎ Home Time Zone

- To switch to the home time zone, choose **Home time zone** in step 2 and press the **OK** button.
- To change the home time zone, choose **Home time zone** in step 2 and perform the steps for **Travel destination** to set the home time zone.

✎ Daylight Saving Time

When daylight saving time starts or ends, turn on or off the daylight saving time option from the time zone selection screen displayed in step 4.

📅 Imprinting the Date on Pictures

After setting the date and time, set the **Date imprint** setting in the setup menu (📖159). Once **Date imprint** is set, the shooting date and time can be imprinted on the pictures.



 **Time Zones**

The camera supports the time zones listed below.

For time differences not listed below, set the camera clock using **Date**.

UTC +/-	Location	UTC +/-	Location
-11	Midway, Samoa	+1	Madrid, Paris, Berlin
-10	Hawaii, Tahiti	+2	Athens, Helsinki, Ankara
-9	Alaska, Anchorage	+3	Moscow, Nairobi, Riyadh, Kuwait, Manama
-8	PST (PDT): Los Angeles, Seattle, Vancouver	+4	Abu Dhabi, Dubai
-7	MST (MDT): Denver, Phoenix	+5	Islamabad, Karachi
-6	CST (CDT): Chicago, Houston, Mexico City	+5.5	New Delhi
-5	EST (EDT): New York, Toronto, Lima	+6	Colombo, Dhaka
-4.5	Caracas	+7	Bangkok, Jakarta
-4	Manaus	+8	Beijing, Hong Kong, Singapore
-3	Buenos Aires, Sao Paulo	+9	Tokyo, Seoul
-2	Fernando de Noronha	+10	Sydney, Guam
-1	Azores	+11	New Caledonia
±0	London, Casablanca	+12	Auckland, Fiji

Monitor Settings

Press the **MENU** button →  (Setup menu) ( 153) → Monitor settings

Change the settings for the options below.

Image review

On (default setting): Picture is automatically displayed in the monitor immediately after it is taken and the monitor display returns to shooting mode.

Off: Picture is not displayed after it is taken.

Brightness

Choose from five settings for monitor brightness. The default setting is **3**.

DATE Date Imprint

Press the **MENU** button → **Y** (Setup menu) (📖153) → Date imprint

The shooting date and time can be imprinted in pictures at the time of shooting. This information can be printed even from printers that do not support printing of date and time (📖109).



Off (default setting)

Date and time are not imprinted in pictures.

Date

The date is imprinted in pictures.

Date and time

The date and time are imprinted in pictures.

At settings other than **Off**, the icon for the current setting is displayed in the monitor (📖8).

✓ Notes on Date Imprint

- Imprinted dates cannot be deleted from the image, nor can dates be imprinted after the picture has been taken.
- Dates cannot be imprinted in the following situations.
 - When **Night landscape**, **Museum**, **Backlit scene HDR** or **Panorama assist** is selected for scene mode
 - When **Continuous H**, **Continuous L** or **BSS** is selected for the **Continuous** setting (📖86)
 - When **Auto bracketing** (📖89) is used
 - When **Smile timer** or **Blink proof** (📖58) in smart portrait is set to **On**
 - When sport continuous mode is selected
 - During movie recording
- Dates imprinted at **Image size** (📖76) setting of **VGA 640×480** may be difficult to read. Choose **PC 1024×768** or larger when using date imprint.
- The date is recorded using the format selected in the setup menu's **Date** option (📖22, 155).

📎 Date Imprint and Print Set

When printing from DPOF-compatible printers that support printing of shooting date and photo information, the date and information can be printed on pictures without the date and time being imprinted on them, using options in the **Print set** menu (📖108).

Vibration Reduction

Press the **MENU** button →  (Setup menu) ( 153) → Vibration reduction

Specify the vibration reduction setting for taking still pictures. Correct blur, caused by slight hand movement known as camera shake, that commonly occurs when shooting with zoom applied or at slow shutter speeds.

When the camera is stabilized for still picture shooting with a tripod, set vibration reduction to **Off**.

On (hybrid)

Records with optical compensation for camera shake during still picture recording using the image sensor shift method, and under the following conditions, also performs electronic VR using image enhancement.

- When the flash does not fire
- When the shutter speed is slower than 1/60 second
- When the self-timer is off
- When **Single** is selected for the **Continuous** setting
- When **Off** is selected for the **Auto bracketing** setting
- When the ISO sensitivity is 200 or less

On (default setting)

Compensates for camera shake during still picture recording using the image sensor shift method. Camera automatically detects the panning direction and only corrects for vibration due to camera shake.



When the camera is panned horizontally, for example, vibration reduction only reduces vertical shake. If camera is panned vertically, vibration reduction only compensates for horizontal shake.

Off

Vibration reduction is not enabled.

When vibration reduction is enabled, the current setting is displayed during shooting (when **Off** is selected, an icon for the current setting is not displayed) ( 8, 27).



Compensating Movies with Electronic VR

To reduce the effects of camera shake when recording movies, enable **Electronic VR** ( 136) from the movie menu ( 132).

Notes on Vibration Reduction

- It may take a few seconds to activate vibration reduction after the power is turned on or the camera enters shooting mode from playback mode. Wait until the display stabilizes before shooting.
- Due to characteristics of the vibration reduction function, images displayed in the camera's monitor immediately after shooting may appear blurry.
- Vibration reduction may be unable to completely eliminate the effects of camera shake in some situations.
- When the camera shake is extremely high or low, picture compensation with electronic VR may not be possible even when **On (hybrid)** is set.
- When the shutter speed is fast or extremely slow, electronic VR may not operate even when **On (hybrid)** is set.
- When electronic VR in **On (hybrid)** operates, saving the picture takes longer than normal, because when the picture is shot, the shutter is released twice automatically to perform picture compensation. **Shutter sound** (📖165) only sounds once. Only one frame is recorded.

Motion Detection

Press the **MENU** button →  (Setup menu) ( 153) → Motion detection

Enable motion detection to reduce the effects of camera shake and subject movement when shooting still pictures.

Auto

When the camera detects the movement of the subject or camera shake, the ISO sensitivity is raised and the shutter speed is increased to reduce their effects.

However, motion detection does not function in the following situations.

- When the fill flash fires
- In the following scene modes: **Night portrait, Dusk/dawn, Night landscape, Museum, Fireworks show** and **Backlight**
- When shooting modes **P, S, A, M** or **U** is used
- When subject tracking mode is selected.
- When sport continuous mode is selected.

Off (default setting)

Motion detection will not be applied.

When motion detection is enabled, the current setting is displayed during shooting ( 8).

The motion detection icon will glow green when the camera detects any vibration and increases the shutter speed. When **Off** is selected, the icon for the current setting is not displayed.

Notes on Motion Detection

- Motion detection may be unable to completely reduce effects of camera shake and subject movement in some situations.
- Motion detection may not function if the subject exhibits significant movement or is too dark.
- The pictures taken may become grainy.

AF Assist

Press the **MENU** button →  (Setup menu) (📖153) → AF assist

Enable or disable the AF-assist illumination that assists the auto focus when the lighting is poor.

Auto (default setting)

AF-assist illumination will be used to assist the focus operation when the subject is poorly lit. The illuminator has a range of about 10 m (32 ft.) at the maximum wide-angle position and about 3.5 m (11 ft.) at the maximum telephoto position. However, note that for some focus areas or scene modes, the AF-assist illuminator may not light even if **Auto** is set.

Off

Disable this function. The camera may be unable to focus if lighting is poor.

Red-eye reduction

Press the **MENU** button →  (Setup menu) (📖153) → Red-eye reduction

Choose the red-eye reduction method when the flash mode (📖34) is  (auto with red-eye reduction).



Pre-flash on (default setting)

The flash repeatedly fires pre-flashes at low intensity before the main flash to reduce the red-eye effect, and it then performs the red-eye reduction process using picture compensation.
The time from when the shutter-release button is pressed to when the shutter is actually released is longer than normal.

Pre-flash off

Pre-flashes will not fire. The shutter is released immediately when the shutter-release button is fully pressed, and the red-eye reduction process is performed using picture compensation.

Digital Zoom

Press the **MENU** button →  (Setup menu) () 153 → Digital zoom





Enable or disable digital zoom.

On (default setting)

When the camera is zoomed in to the maximum optical zoom position, rotating and holding the zoom control at **T** () triggers digital zoom () 29).

Crop



Limit zoom magnification up to the position of  (except when shooting a movie). Also limit digital zoom to the range at which image quality of shot still pictures does not deteriorate.

The digital zoom is not available when the image size is  **3648×2736**,  **3264×2448**,  **3648×2432**,  **3584×2016** or  **2736×2736**.

Off

Digital zoom will not be activated (except when shooting a movie).

Notes on Digital Zoom

- When digital zoom is in effect, AF area mode is set to **Center** () 90).
- Digital zoom cannot be used in the following situations.
 - When the focus mode () is set to **MF** (manual focus)
 - When **Portrait**, **Night portrait**, **Night landscape**, **Fireworks show** or **Backlit scene HDR** is selected for scene mode
 - When scene auto selector mode is selected
 - When smart portrait mode is selected
 - When subject tracking mode is selected
 - When **Multi-shot 16** is selected for the **Continuous** () 86) setting
- At magnifications of 1.2x to 1.8x, **Metering** is set to **Center-weighted**, and at magnifications of 2.0x to 4.0x, it is set to **Spot**.

Sound Settings

Press the **MENU** button →  (Setup menu) (📖153) → Sound settings

Adjust the following sound settings.

Button sound

Turn button sound **On** (default setting) or **Off**. A beep will sound once when the settings are completed successfully, twice when the camera focuses on the subject, and three times when an error is detected. Start-up sound will also play when the camera is turned on.

Shutter sound

Choose shutter sound from **On** (default setting) or **Off**.

- Even when **On** is set, the shutter sound is not made during continuous shooting or movie recording.

Auto Off

Press the **MENU** button →  (Setup menu) (📖153) → Auto off

If no operations are performed for the selected length of time, the monitor will turn off and the camera enters standby mode (📖21) to reduce drain on the batteries. The power-on lamp blinks in standby mode. If no operations are performed for another three minutes, the camera will turn off.

Choose the time allowed to elapse before the camera enters standby mode if no operations are performed from **30 s**, **1 min** (default setting), **5 min**, and **30 min**.

Canceling Standby Mode

Standby mode is canceled when the following buttons are pressed.

- Power switch
- Shutter-release button
-  button



The standby mode can also be canceled by rotating the mode dial.

Notes on Auto Off

The time taken for the monitor to enter standby mode is as follows.

- When menus are displayed: three minutes
- During slideshow playback: maximum of 30 minutes
- When the AC adapter EH-62A is connected: 30 minutes

Format Memory/Format Card

Press the **MENU** button →  (Setup menu) (153) → **Format memory/Format card**

Use this option to format the internal memory or a memory card.

Formatting the Internal Memory

To format the internal memory, remove the memory card from the camera. The **Format memory** option appears in the setup menu.

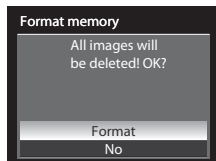

Formatting Memory Card

When the memory card is inserted in the camera, the **Format card** option appears in the setup menu.

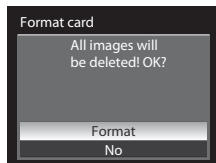

Formatting Internal Memory and Memory card

- **Formatting the internal memory or memory card permanently deletes all data.** Be sure to transfer important pictures to a computer before formatting.
- Do not turn off the camera, disconnect the AC adapter, or open the battery-chamber/memory card slot cover during formatting.
- The first time you insert the memory cards used in other devices into this camera, be sure to format them with this camera.

Language

Press the **MENU** button →  (Setup menu) (📖153) → Language

Choose one of 24 languages for display of camera menus and messages.

Čeština	Czech
Dansk	Danish
Deutsch	German
English	(default setting)
Español	Spanish
Ελληνικά	Greek
Français	French
Indonesia	Indonesian
Italiano	Italian
Magyar	Hungarian
Nederlands	Dutch
Norsk	Norwegian

Polski	Polish
Português	Portuguese
Русский	Russian
Suomi	Finnish
Svenska	Swedish
Türkçe	Turkish
عربي	Arabic
简体中文	Simplified Chinese
繁體中文	Traditional Chinese
日本語	Japanese
한글	Korean
ภาษาไทย	Thai

TV Settings

Press the **MENU** button →  (Setup menu) (📖153) → TV settings

Select the settings necessary for connecting to a television.

Video mode

Choose from **NTSC** and **PAL**.

HDMI

Choose a picture resolution for HDMI output from **Auto** (default setting), **480p**, **720p**, or **1080i**. When **Auto** is set, the output resolution that is best suited to the connected high-definition TV is selected automatically from **480p**, **720p** and **1080i**.

Charge by Computer

Press the **MENU** button →  (Setup menu) ( 153) → Charge by computer

Choose whether or not the battery inserted in the camera is charged when the camera is connected to a computer via USB cable ( 145).

Auto (default setting)

When the camera is connected to a computer that is running, the battery inserted into the camera is automatically charged using power supplied by the computer.

Off

The battery inserted into the camera is not charged when the camera is connected to a computer.

Notes on Connecting the Camera to a Printer

- The battery cannot be charged with connection to a printer, even if the printer complies with the PictBridge standard.
- When **Auto** is selected for **Charge by computer**, it may be unable to print pictures with direct connection of the camera to some printers. If the **PictBridge** startup screen is not displayed in the monitor after the camera is connected to a printer and turned on, turn the camera off and disconnect the USB cable. Set **Charge by computer** to **Off** and reconnect the camera to the printer.

Blink Warning

Press the **MENU** button → **Y** (Setup menu) (📖153) → **Blink warning**

Choose whether or not blinking eyes are detected when using face priority (📖91) in the following shooting modes.

- Scene auto selector mode (📖43)
- **Portrait** (📖46) or **Night portrait** (📖47) scene modes
- Shooting modes **P**, **S**, **A**, **M** or **U** (when **Face priority** (📖90) is selected for AF area mode)

On

When the camera detects that a human subject has closed the eyes immediately after recognizing the face and shooting the subject, the **Did someone blink?** screen will appear on the monitor.

The face of the human subject that may have closed his/her eyes is framed by a yellow border. You can check the picture taken and determine if you need to take the picture again.

See "Operating the Did someone blink? Screen" (📖170) for more information.

Off (default setting)

Blink warning does not take effect.

Note on Blink Warning

When a setting other than **Single** is selected for **Continuous** (📖86), blink warning does not take effect.

Operating the Did someone blink? Screen

The following operations can be performed when the **Did someone blink?** screen is displayed.

If no operations are performed for a few seconds, the screen automatically returns to the shooting mode screen.







To	Use	Description
Zoom in to the face for which blinking was detected	T (Q)	Rotate the zoom control to T (Q).
Return to full-frame playback	W (checkered flag)	Rotate the zoom control to W (checkered flag).
Select the face to be displayed		When the camera detects that one or more human subjects have closed their eyes, press ▲, ▼, ◀ or ▶ during playback zoom to display other faces.
Delete the picture taken		Press the button.
Return to shooting mode		Press the button or the shutter-release button.

Reset All



Press the MENU button →  (Setup menu) (153) → Reset all

When **Reset** is selected, the camera settings will be restored to the following default values.



Pop-up Menu

Option	Default value
Flash mode ( 34)	Auto
Self-timer ( 37)	OFF
Focus mode ( 38)	Autofocus
Exposure compensation ( 41)	0.0

Shooting in the Scene Mode

Option	Default value
Scene menu ( 45)	Portrait
White balance in food mode ( 50)	Center



Smart Portrait Menu

Option	Default value
Skin softening ( 57)	Normal
Smile timer ( 57)	On
Blink proof ( 58)	Off

Subject Tracking Menu

Option	Default value
Autofocus mode ( 61)	Full-time AF

Sport Continuous Menu

Option	Default value
High-speed mode ( 64)	Continuous H: auto
Pre-shooting cache ( 64)	Off
Image quality ( 64)	Normal

Movie Menu

Option	Default value
Movie options (📖133)	HD1080p★ (1920×1080)
HS movie options (📖134)	240 fps
Autofocus mode (📖135)	Single AF
Electronic VR (📖136)	On
Wind noise reduction (📖136)	Off

Shooting Menu

Option	Default value
Image quality (📖75)	Normal
Image size (📖76)	📷 3648×2736
Optimize image (📖79)	Normal
Custom in Optimize image (📖80)	Contrast: Auto Image sharpening: Auto Saturation: Auto
Custom of Black-and-white in Optimize image (📖81)	Contrast: Auto Image sharpening: Auto Monochrome filter: None B&W + color: OFF
White balance (📖82)	Auto
ISO sensitivity (📖84)	Auto
Fixed range auto (📖84)	ISO 160-200
Minimum shutter speed (📖84)	None
Metering (📖85)	Matrix
Continuous (📖86)	Single
Intvl timer shooting (📖87)	30 s
Auto bracketing (📖89)	Off
AF area mode (📖90)	Auto
Autofocus mode (📖93)	Single AF
Flash exp. comp. (📖93)	0.0
Noise reduction (📖94)	Auto
Distortion control (📖94)	Off
Active D-Lighting (📖95)	Off

Setup Menu

Option	Default value
Welcome screen (📖154)	None
Image review (📖158)	On
Brightness (📖158)	3
Date imprint (📖159)	Off
Vibration reduction (📖160)	On
Motion detection (📖162)	Off
AF assist (📖163)	Auto
Red-eye reduction (📖163)	Pre-flash on
Digital zoom (📖164)	On
Button sound (📖165)	On
Shutter sound (📖165)	On
Auto off (📖165)	1 min
HDMI (📖167)	Auto
Charge by computer (📖168)	Auto
Blink warning (📖169)	Off

Others

Option	Default value
Paper size (📖148, 149)	Default
Slide show (📖110)	3 s

- Choosing **Reset all** also clears the current file number (📖181) in the memory. Numbering will continue from the lowest number available. If all pictures (📖111) are deleted before selecting **Reset all**, the file number for the next image taken will start from 0001.
- The following settings will not return to default settings even if **Reset all** is performed.
 - Shooting menu:** Preset manual data for **White balance** (📖83)
 - Playback menu:** **Sequence display options** (📖116) and **Choose key picture** (📖116)
 - Setup menu:** **Date** (📖155), **Language** (📖167) and **Video mode** (📖167) in **TV settings**
- User settings that were saved to the mode dial **U** mode will not be reset to default settings when **Reset all** is performed. To change these settings back to the default settings, use **Reset user settings** (📖100).

R Reset file numbering

Press the MENU button → **Y** (Setup menu) (📖153) → Reset file numbering

When **Yes** is selected, the sequential numbering of file numbers will be reset (📖181). After resetting, a new folder will be created and the file number for the next image taken will start from "0001."

✓ Notes on Reset file numbering

- **Reset file numbering** cannot be used when scene mode is set to **Panorama assist**, and if **Intvl timer shooting** is chosen for **Continuous** when **P, S, A, M** or **U** shooting modes are used. For **Panorama assist** and **Intvl timer shooting**, a new folder will be created, and file numbers will be assigned automatically starting with "0001." (📖181, 182).
- **Reset file numbering** cannot be applied when the folder number reaches 999 and there are images in the folder. Insert a new memory card, or format the internal memory/memory card (📖166).

Ver. Firmware Version

Press the MENU button → **Y** (Setup menu) (📖153) → Firmware version

Displays the current camera firmware version.

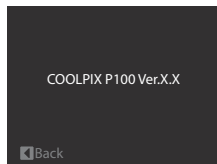

Caring for the Camera

To ensure continued enjoyment of this Nikon product, observe the following precautions when using or storing the device.

Keep dry

The device will be damaged if immersed in water or subjected to high humidity.

Do not drop

The product may malfunction if subjected to strong shock or vibration.

Handle the lens and all moving parts with care

Do not apply force to the lens, lens cover, monitor, memory card slot or battery chamber. These parts are easily damaged. Applying force to the lens cover could result in camera malfunction or damage to the lens. Should the monitor break, care should be taken to avoid injury caused by broken glass and to prevent the liquid crystal from the display touching the skin or entering the eyes or mouth.

Do not point the lens at strong light sources for extended periods

Avoid pointing the lens at the sun or other strong light sources for extended periods when using or storing the camera. Intense light may cause deterioration of the CCD image sensor, producing a white blur effect in photographs.

Keep away from strong magnetic fields

Do not use or store this device in the vicinity of equipment that generates strong electromagnetic radiation or magnetic fields. Strong static charges or the magnetic fields produced by equipment such as radio transmitters could interfere with the monitor, damage data stored on the memory card, or affect the product's internal circuitry.

Avoid sudden changes in temperature

Sudden changes in temperature, such as when entering or leaving a heated building on a cold day, can cause condensation to form inside the device. To prevent condensation, place the device in a carrying case or a plastic bag before exposing it to sudden changes in temperature.

Turn the product off before removing or disconnecting the power source

Do not remove the battery while the product is on, or while images are being recorded or deleted. Forcibly cutting power in these circumstances could result in loss of data or in damage to product memory or internal circuitry.

The Battery

- Check the battery level when taking the camera out, and charge the battery if necessary. Do not continue charging once the battery is fully charged, as this will result in reduced battery performance. If possible, carry a fully-charged spare battery when taking pictures on important occasions.
- Do not use the battery at ambient temperatures below 0 °C (32 °F) or above 40 °C (104 °F). Failure to observe this precaution could damage the battery or impair its performance.
- Charge the battery in an indoor environment that is between 5 and 35 °C (41 to 95 °F).
- When charging the battery by connecting the COOLPIX P100 to the Charging AC Adapter EH-68P/ EH-68P (AR) or to a computer, the chargeable capacity may decrease when the battery temperature is between 45 to 60 °C (113 to 140 °F). The battery will not charge if its temperature is below 0 °C (32 °F) or above 60 °C (140 °F).
- If an exhausted battery is used at a low temperature, the camera may not turn on. Be sure that the battery is fully charged and spare batteries are prepared before heading outside to take pictures in cold weather. Keep spare batteries in a warm place and exchange as necessary. Once warmed, a cold battery that could not be used temporarily due to lowered performance may recover some of its charge.
- Should the battery terminals become dirty, the camera may not turn on due to poor contact. Wipe the terminals off with a clean, dry cloth before use.
- If the battery will not be used for some time, insert it in the camera and run it flat before removing it for storage. Attach the included terminal cover to the battery and store it in a cool location with an ambient temperature of 15 to 25 °C (59 to 77 °F). Do not store the battery in hot or extremely cold locations.
- While the battery is in storage, charge it at least once every six months and then use the camera to run it flat again before storing it in a cool location.
- Always remove the battery from the camera or battery charger when it is not being used. Left installed, minute amounts of current flow even when unused, and the battery may become excessively drained and no longer function.
- A marked drop in the time a fully-charged battery retains its charge, when used at room temperature, indicates that the battery needs to be replaced. Purchase a new battery.
- Replace the battery when it no longer holds a charge. Used batteries are a valuable resource. Please recycle used batteries in accordance with local regulations.

Cleaning

Lens/ electronic viewfinder	Avoid touching glass parts with your fingers. Remove dust or lint with a blower (typically a small device with a rubber bulb attached to one end that is pumped to produce a stream of air out the other end). To remove fingerprints or other stains that cannot be removed with a blower, wipe the lens with a soft cloth, using a spiral motion that starts at the center of the lens and working toward the edges. If this fails, clean the lens using a cloth lightly dampened with commercial lens cleaner.
Monitor	Remove dust or lint with a blower. To remove fingerprints and other stains, clean the monitor with a soft, dry cloth, being careful not to apply pressure.
Body	Use a blower to remove dust, dirt or sand, then wipe gently with a soft, dry cloth. After using the camera at the beach or seaside, wipe off any sand or salt with a dry cloth lightly dampened with fresh water, then dry thoroughly. Note that foreign matter inside the camera could cause damage not covered by the warranty.

Do not use alcohol, thinner, or other volatile chemicals.

Storage

Turn the camera off when not in use. Check that the power-on lamp is off before putting the camera away. Remove the battery if the camera will not be used for an extended period. Do not store the camera with naphtha or camphor moth balls, or in any of the following locations:

- Next to equipment that produces strong electromagnetic fields, such as televisions or radios
- Exposed to temperatures below -10 °C (14 °F) or above 50 °C (122 °F)
- Poorly ventilated or subject to humidities of over 60 %

To prevent mold or mildew, take the camera out of storage at least once a month. Turn the camera on and release the shutter a few times before putting the camera away again.



Notes on the Monitor

- The monitor may contain a few pixels that are always lit or that do not light. This is a characteristic common to all TFT LCD displays, and does not indicate a malfunction. Images recorded using the product will not be affected.
- Images in the monitor may be difficult to see under bright lighting.
- The monitor is lit by an LED backlight. Should the monitor begin to dim or flicker, contact your Nikon-authorized service representative.

Optional Accessories

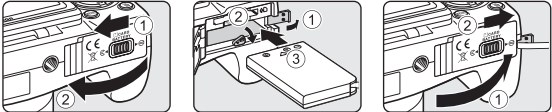
Rechargeable battery	Rechargeable Li-ion Battery EN-EL5
Charging AC Adapter	Charging AC Adapter EH-68P/EH-68P (AR)
Battery charger	Battery Charger MH-61
AC adapter	<p>AC Adapter EH-62A (connect as shown)</p>  <p>1 Before closing the battery-chamber/memory card slot cover, fully insert the cord of the AC adapter into the slot in the battery chamber. If part of the cord runs out of the groove, the cover or cord may be damaged when the cover is closed.</p>
USB cable	USB Cable UC-E6
A/V cable	Audio Video Cable EG-CP14
Lens cap	Lens Cap LC-CP21

Approved Memory Cards

The following Secure Digital (SD) memory cards have been tested and approved for use in this camera.

All cards of the designated make and capacity can be used, regardless of speed.

SanDisk	2 GB ¹ , 4 GB ² , 8 GB ² , 16 GB ² , 32 GB ²
TOSHIBA	2 GB ¹ , 4 GB ² , 8 GB ² , 16 GB ² , 32 GB ²
Panasonic	2 GB ¹ , 4 GB ² , 8 GB ² , 12 GB ² , 16 GB ² , 32 GB ²
Lexar	2 GB ¹ , 4 GB ² , 8 GB ²

- 1 If the memory card will be used with a card reader or similar device, check that device supports 2 GB cards.
- 2  SDHC-compliant. If the memory card will be used with a card reader or similar device, check that device supports SDHC.

Contact the manufacturer for details on the above cards.

File and Folder Names

Pictures, movies, and voice memos are assigned file names as follows.

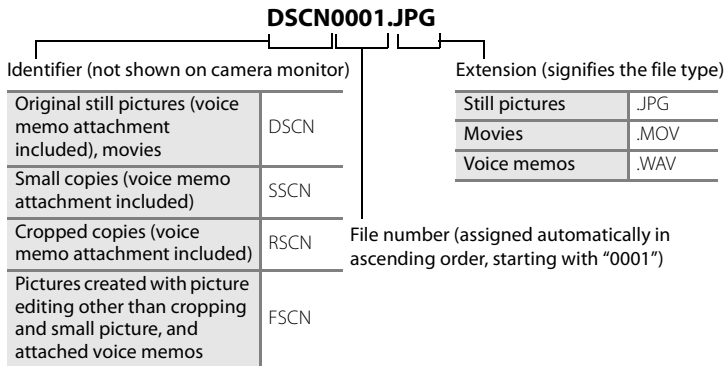











- A folder for storing files will be automatically created using the following naming convention: 'Folder number + NIKON' (e.g., '100NIKON'). If there are 200 files in the folder, a new folder will be created. (For example, the folder name following '100NIKON' will be '101NIKON'. In this case, the file number starts from 201.) When the number of files within a folder reaches 9999 or **Reset file numbering** (📖174) is performed, a new folder will be created. File numbers will be assigned automatically starting with '0001'. If the folder contains no files, a new folder will not be created even if **Reset file numbering** is performed.
- Voice memo file names have the same identifier and file number as the picture to which the voice memo is attached.
- Files are stored in folders named with a folder number followed by a five-character identifier: "P_" plus a three-digit sequence number for pictures shot using Panorama assist (e.g., "101P_001") (📖53).
- Each time a picture is taken in Interval timer shooting (📖87), a folder named with the convention: 'Folder number + INTVL' (e.g., 101INTVL) is created.

File and Folder Names











- When image files or voice files are copied to or from the internal memory or memory card (📖115), the file naming conventions are as follows:
 - Files copied using **Selected images** are copied to the current folder (or to the folder used for subsequent pictures), where they are assigned file numbers in ascending order following the largest file number in memory.
 - Files copied using **All images**, along with their folder, are copied together. Folder numbers are assigned in ascending order, following the largest folder number on the destination medium (📖115).
- A single folder can hold up to 200 pictures; if the current folder already contains 200 pictures, a new folder, named by adding one to the current folder name, will be created the next time a picture is taken. When the current folder is numbered 999, if there are 200 pictures in the folder or if a picture is numbered 9999, no further pictures can be taken until the internal memory or memory card is formatted (📖166), or a new memory card is inserted.











Error Messages

The following table lists the error messages and other warnings displayed in the monitor, as well as the solutions for dealing with them.



















Display	Description	Solution	
 (blinks)	Clock not set.	Set clock.	155
	Battery is running low.	Prepare to charge or change battery.	16, 18
 Battery exhausted.	Battery exhausted.	Charge or change battery.	16, 18
 Battery temperature high	Battery temperature is high.	Turn off camera, and allow battery to cool down before resuming use. After five seconds, this message will disappear, the monitor will turn off, and the power-on lamp will blink rapidly. After the lamp blinks for three minutes, the camera will turn off automatically, but you can also press the power switch to turn it off manually.	21
 The camera will turn off to prevent overheating.	Inside of the camera has become hot. The camera turns off automatically.	Leave the camera off until the inside of the camera has cooled and then turn it on again.	–
 (blinks red)	Camera cannot focus.	<ul style="list-style-type: none"> • Refocus. • Use focus lock. 	30, 31 31
 Please wait for the camera to finish recording.	Camera cannot perform other operations until recording is complete.	Wait until message clears from display automatically when recording is complete.	–
 Memory card is write protected.	Write-protect switch is in “lock” position.	Slide the write-protect switch to “write” position.	25
 This card cannot be used.	Error accessing memory card.	<ul style="list-style-type: none"> • Use an approved card. • Check that connectors are clean. • Confirm that memory card is correctly inserted. 	180
 This card cannot be read.			24 24





Error Messages

Display	Description	Solution	
<p> Card is not formatted. Format card? Yes No</p>	Memory card has not been formatted for use in this camera.	All data stored on the memory card will be deleted when formatted. If there is any data on the card that you want to keep, select No , and backup the data to a computer before formatting the memory card. To format the memory card, select Yes and press the  button.	25
<p> Out of memory.</p>	Memory card is full.	<ul style="list-style-type: none"> Choose lower image quality or smaller image size. Delete pictures. Replace memory card. Remove memory card and use internal memory. 	75, 76 32, 111, 137 24 24
<p> Image cannot be saved.</p>	Error occurred while recording picture.	Format internal memory or memory card.	166
	Camera has run out of file numbers.	Replace the memory card, or format the internal memory/memory card.	24, 166
	Picture cannot be used for welcome screen.	<p>The following pictures cannot be used.</p> <ul style="list-style-type: none"> Pictures shot with Image size of  3648x2432,  3584x2016 or  2736x2736 Pictures created with small picture or crop function that are 160x120 or less 	76 124, 126
	There is insufficient space to save a copy.	Delete pictures from destination.	111
<p> A blink was detected in the picture just taken.</p>	Someone may have had their eyes closed when the picture was taken.	Check results in playback mode.	58
<p> Image cannot be modified.</p>	Cannot edit selected picture.	<ul style="list-style-type: none"> Confirm the conditions that are required for editing. These options cannot be used with movies. 	118 -

Display	Description	Solution	
 Cannot record movie.	Time out error while recording movie.	Choose memory card with faster write speed.	180
 Cannot reset file numbering.	No more folders can be created.	Insert a new memory card, or format the internal memory/memory card.	24, 166, 174
 Memory contains no images.	No pictures in the internal memory or memory card.	<ul style="list-style-type: none"> • Pictures stored in the internal memory can only be viewed if no memory card is inserted. • To copy files from internal memory to memory card, press the MENU button to display the Copy screen, then copy the files from internal memory to memory card. 	24 115
 File contains no image data.	File not created with COOLPIX P100.	File cannot be viewed on this camera. View file using the computer or any other devices which was used to create or edit this file.	-
 This file cannot be played back.			
 All images are hidden.	The picture cannot be played back in a slide show.	-	110
	All images in the internal memory/memory card are hidden.	Disable the Hide image setting to view images.	114
 This image cannot be deleted.	Picture is protected.	Disable protection.	113
 Travel destination is in the current time zone.	Destination in same time zone as home.	-	157
 Mode dial is not in the proper position.	Mode dial is between two modes.	Rotate the mode dial to select the desired mode.	42

Error Messages

Display	Description	Solution	
 Press the flash pop-up button to raise the flash.	The built-in flash is not raised during the Night portrait or Backlight scene modes.	Press the  (flash pop-up) button to raise the built-in flash.	35, 47, 51
 The flash is lowered.	The built-in flash is not raised during the scene auto selector mode.	Press the  (flash pop-up) button to raise the built-in flash. The camera can still shoot normally with the flash lowered if you do not wish to use it.	35, 43
 Lower the flash.	The built-in flash is raised when recording a movie.	Lower the built-in flash gently and shoot a picture. Note that sound of lowering the flash may be recorded.	35, 127
 Lens error. (If the lens cap is attached, turn the camera off, remove the lens cap, and turn the camera on.)	Lens error	Remove lens cap if it is still attached, and turn the camera off and then on again. If the error persists, contact retailer or Nikon-authorized service representative.	21
 Communications error	Error occurred during communication with printer.	Turn off camera and reconnect cable.	141, 147
System error 	Error has occurred in camera's internal circuitry.	Turn off camera, remove and reinsert battery, and turn on camera. If the error persists, contact retailer or Nikon-authorized service representative.	21
 Printer error: check printer status.	Printer error	Check printer. After solving the problem, select Resume and press the  button to resume printing.*	-
 Printer error: check paper	Specified size of paper is not loaded in printer.	Load the specified type of paper, select Resume and press the  button to resume printing.*	-
 Printer error: paper jam	Paper has jammed in the printer.	Remove the jammed paper, select Resume and press the  button to resume printing.*	-
 Printer error: out of paper	No paper is loaded in the printer.	Load the specified type of paper, select Resume and press the  button to resume printing.*	-
 Printer error: check ink	Ink error	Check ink, select Resume and press the  button to resume printing.*	-





Display	Description	Solution	
 Printer error: out of ink	Ink cartridge is empty.	Replace ink, select Resume and press the  button to resume printing.*	-
 Printer error: file corrupt	An error caused by the image file has occurred.	Select Cancel and press the  button to cancel printing.	-

* See the documentation provided with your printer for further guidance and information.

Troubleshooting

If the camera fails to function as expected, check the list of common problems below before consulting your retailer or Nikon-authorized service representative. Refer to the page numbers in the right-most column for more information.





Display, Settings and Power Supply

Problem	Cause/Solution	
Monitor and electronic viewfinder are blank.	<ul style="list-style-type: none"> • Camera is off. • Battery is exhausted. • Standby mode for saving power: Press the power switch, shutter-release button or the  button, or rotate the mode dial. • Monitor and electronic viewfinder cannot be used simultaneously. Press the  button to alternate between displays. • Camera and computer are connected via USB cable. • Camera and TV are connected via A/V cable or HDMI cable. • Interval timer shooting in progress. • The camera cannot be turned on while connected to an electrical outlet via the Charging AC Adapter. 	21 26 21, 33 14 140 138 87 20
Monitor is hard to read.	<ul style="list-style-type: none"> • Ambient lighting too bright: use electronic viewfinder or move to darker location. • Adjust monitor brightness. • Monitor is dirty. Clean monitor. 	14 158 175
The electronic viewfinder is hard to read.	Adjust diopter adjustment control.	14
Display does not switch to monitor (or electronic viewfinder) when the  button is pressed.	<ul style="list-style-type: none"> • You cannot switch the display in the following situations: <ul style="list-style-type: none"> - While recording or playing back movies - While recording or playing back voice memos - During interval timer shooting - While connected to a printer - While displaying image deletion screens • You cannot switch the display while displaying a certain error message. 	127, 137 117 87 147 32, 33 183
Camera turns off without warning.	<ul style="list-style-type: none"> • Battery is exhausted. • Camera has turned off automatically to save power. • Inside of the camera has become hot. Leave the camera off until the inside of the camera has cooled. • Battery is cold. • The camera turns off if it is connected to the Charging AC Adapter while it is turned on. • The camera turns off if the USB cable is disconnected while the camera is connected to a computer or printer. Connect the USB cable again. 	26 21 - 176 18 141, 147

Electronically Controlled Cameras







In extremely rare instances, unusual characters may appear in the monitor and the camera may stop functioning. In most cases, this phenomenon is caused by a strong external static charge. Turn the camera off, remove and replace the battery, then turn the camera on again. In the event of continued malfunction, contact your retailer or Nikon-authorized service representative. Note that disconnecting the power source as described above may result in the loss of any data not recorded to internal memory or the memory card at the time the problem occurred. Data already recorded will not be affected.

Shooting





Problem	Cause/Solution	
Cannot set to shooting mode	Disconnect the HDMI cable or USB cable.	138, 141, 147
No picture taken when shutter-release button is pressed.	<ul style="list-style-type: none"> When camera is in playback mode, press the  or shutter-release button. When menus are displayed, press the MENU button. Battery is exhausted. The built-in flash is not raised during the Night portrait or Backlight scene modes. When flash indicator blinks, flash is charging. 	32 13 26 35, 47, 51 36
Camera cannot focus.	<ul style="list-style-type: none"> The intended subject is one with which autofocus does not perform well. Set AF assist in the setup menu to Auto. Subject not in focus area when shutter-release button pressed halfway. The focus mode is set to MF (manual focus). Turn camera off and then on again. 	31 163 30, 90 38, 40 21
Pictures are blurred.	<ul style="list-style-type: none"> Use flash. Use vibration reduction and motion detection. Use BSS (Best Shot Selector). Use a tripod to stabilize the camera (use with the self-timer for best results). 	34 160, 162 86 37
Bright specks appear in pictures shot using flash.	Flash is reflecting off particles in air. Turn flash  (off).	34
Flash does not fire.	<ul style="list-style-type: none"> Flash is set to  (off). Some scene modes that cannot turn on flash are selected. Smart portrait mode is selected, with Blink proof set to On. Sport continuous mode is selected. Another function that is set now is restricting the flash. 	34 45 58 62 96

Problem	Cause/Solution	
Digital zoom cannot be used.	<ul style="list-style-type: none"> • Off is selected for Digital zoom in the setup menu. • Digital zoom cannot be used in the following situations. <ul style="list-style-type: none"> - When focus mode is set to MF (manual focus) - When Portrait, Night portrait, Night landscape, Fireworks show or Backlit scene HDR is selected for scene mode - When scene auto selector is chosen - When smart portrait mode is selected - When subject tracking mode is selected - When Multi-shot 16 is set for Continuous in the shooting menu 	164 38, 40 46, 47, 49, 51, 52 43 55 59 86
Range of settable shutter speeds is narrow.	When the inside of the camera becomes hot, the shutter speed is restricted automatically. When the shutter speed reaches a restricted minimum speed, the shutter speed display blinks twice in the monitor during shooting. Leave the camera for a while until the temperature drops, and then set the shutter speed.	-
Image size not available.	Another function that is set now is restricting Image size .	96
No sound when shutter is released.	<ul style="list-style-type: none"> • Off is selected for Shutter sound under Sound settings in the setup menu. • Continuous H, Continuous L, BSS or Multi-shot 16 is selected for Continuous in the shooting menu. • A setting other than Off is selected for Auto bracketing. • Museum is selected in scene mode. • Smile timer or Blink proof is set to On for smart portrait mode. • Sport continuous mode is selected. • Do not block the speaker. 	165 86 89 50 57, 58 62 5, 28
AF-assist illuminator does not light.	Off is selected for AF assist in the setup menu. Even when Auto is set, AF-assist illuminator may not light depending on the AF area position or scene mode.	163
Pictures appear smeared.	Lens is dirty. Clean lens.	175
Colors are unnatural.	White balance does not match light source.	82
Randomly spaced bright pixels ("noise") appear in image.	As the subject is dark, shutter speed is too slow or ISO sensitivity is too high. Noise can be reduced by: <ul style="list-style-type: none"> • Using flash. • Specifying a lower ISO sensitivity setting. • Applying Noise reduction in the shooting menu to suit situations. • Using a scene mode which has noise reduction ability. 	34 84 94 45

Troubleshooting

Problem	Cause/Solution	
Pictures are too dark (underexposed).	<ul style="list-style-type: none"> Flash is set to  (off). Built-in flash window is blocked. Subject is beyond flash range. Adjust exposure compensation. Raise the ISO sensitivity. Subject is backlit. Raise the built-in flash, set Backlight of the scene mode or set the flash mode to  (fill flash). 	34 28 34 41 84 34, 51
Pictures are too bright (overexposed).	Adjust exposure compensation.	41
Unexpected results occurred when flash is set to auto with red-eye reduction.	When  (auto with red-eye reduction) or “fill flash with slow sync and red-eye reduction” of the Night portrait scene mode is applied during shooting, In-Camera Red-Eye Fix may, in very rare cases, be applied to areas not affected by red-eye. Set a flash mode other than  (auto with red-eye reduction), select a scene mode other than Night portrait , and resume shooting.	34, 47
Skin softening results are not as expected.	<ul style="list-style-type: none"> Skin softening may not produce the desired results depending on shooting conditions. For pictures with four or more faces, try using Skin softening in the playback menu. 	57 122
Saving images takes time.	It may take more time to save images in the following situations. <ul style="list-style-type: none"> When the noise reduction function is in operation When flash is set to  (auto with red-eye reduction) When using scene mode Night landscape or Backlit scene HDR while shooting When using skin softening while shooting When using sport continuous while shooting When using Active-D Lighting while shooting 	94 34 49, 52 57 62 95
Cannot set or use Continuous or Auto bracketing.	Another function that is set now is restricting the Continuous setting or Auto bracketing.	96
Cannot set Optimize image.	Another function that is set now is restricting Optimize image.	96

Playback



Problem	Cause/Solution	
File cannot be played back.	<ul style="list-style-type: none"> File was overwritten or renamed by computer or another make or model of camera. Interval timer shooting in progress. Movies recorded with cameras other than COOLPIX P100 cannot be played back. 	– 87 127
Cannot play a sequence.	<ul style="list-style-type: none"> Pictures shot continuously with cameras other than COOLPIX P100 cannot be played as a sequence. Check the Sequence display options setting. 	– 116
Cannot zoom in on picture.	Playback zoom cannot be used with movies, small pictures, or cropped copies of size 320 × 240 pixels and below.	–
Cannot record or play back voice memo.	<ul style="list-style-type: none"> Voice memos cannot be attached to movies. Voice memos cannot be attached to pictures taken with cameras other than COOLPIX P100. Voice memos that are attached to the picture using other cameras cannot be played back on this camera. 	137 117
Cannot use quick retouch, D-Lighting, skin softening, small picture, black border, or crop options.	<ul style="list-style-type: none"> These options cannot be used with movies. Editing other than Black border cannot be performed on pictures shot with Image size of  3648×2432,  3584×2016, and  2736×2736. Confirm the conditions that are required for editing. Pictures taken with cameras other than COOLPIX P100 cannot be edited. 	137 76 118 –
Pictures not displayed on television.	<ul style="list-style-type: none"> Video mode or HDMI is not correctly set in the TV settings setup menu. Both an HDMI cable and an audio/video cable, or both an HDMI cable and a USB cable are connected. Memory card contains no pictures. Replace memory card. Remove memory card to play back pictures from internal memory. 	167 138 24
Nikon Transfer does not start when camera is connected to a computer.	<ul style="list-style-type: none"> Camera is off. Battery is exhausted. USB cable is not correctly connected. Camera is not recognized by the computer. Confirm that the operating system used is compatible with the camera. Computer is not set to launch Nikon Transfer automatically. For more information on Nikon Transfer, refer to help information contained in Nikon Transfer.	21 26 141 – 140 144

Troubleshooting

Problem	Cause/Solution	
The PictBridge screen is not displayed when the camera is connected to a printer.	With some PictBridge-compatible printers, the PictBridge startup screen may not be displayed and it may be unable to print pictures when Auto is selected for the Charge by computer option in the setup menu. Set the Charge by computer option to Off and reconnect the camera to the printer.	168
Pictures to be printed are not displayed.	<ul style="list-style-type: none"> • Memory card contains no pictures. Replace memory card. • Remove memory card to print pictures from internal memory. 	24 24
Cannot select paper size with camera.	<p>Paper size cannot be selected from the camera in the following situations, even for PictBridge compatible printers. Use the printer to select page size.</p> <ul style="list-style-type: none"> • The page size selected using the camera is not compatible with the printer. • A printer that automatically sets the paper size is being used. 	148, 149 –

Specifications

Nikon COOLPIX P100 Digital Camera

Type	Compact digital camera
Effective pixels	10.3 million
Image sensor	1/2.3-in. CMOS; approx. 10.6 million total pixels
Lens	26× optical zoom, NIKKOR lens
Focal length	4.6-120mm (angle of view equivalent to that of 26-678mm lens in 35mm [135] format)
f/-number	f/2.8-5
Construction	14 elements in 11 groups
Digital zoom	Up to 4× (angle of view equivalent to that of approx. 2712mm lens in 35mm [135] format)
Vibration reduction	Both image sensor shift and electronic (still pictures) Electronic (movies)
Autofocus (AF)	Contrast-detect AF, Multi area AF
Focus range (from lens) (approx.)	<ul style="list-style-type: none">• [W]: 50 cm (1 ft. 8 in.) to ∞, [T]: 1.7 m (5 ft. 8 in.) to ∞• Macro close-up mode: 10 cm (4 in.) to ∞ (zoom position on the wide-angle side from the  icon where the  icon glows green); 1 cm (0.4 in.) to ∞ (center zoom position between the maximum wide-angle side and the  icon)
Focus-area selection	Face priority, auto (9-area automatic selection), center, manual with 99 focus areas
Electronic viewfinder	Color LCD viewfinder, 0.6 cm/0.24-in. TFT LCD, approx. 230k-dot, with diopter adjustment function
Frame coverage (shooting mode)	Approx. 97% horizontal and 97% vertical (compared to actual picture)
Frame coverage (playback mode)	Approx. 100% horizontal and 100% vertical (compared to actual picture)
Monitor	7.5cm/3-in., approx. 460k-dot, TFT LCD Vari-angle monitor with anti-reflection coating and 5-level brightness adjustment, tiltable 82° downward, 90° upward
Frame coverage (shooting mode)	Approx. 97 % horizontal and 97 % vertical (compared to actual picture)
Frame coverage (playback mode)	Approx. 100 % horizontal and 100 % vertical (compared to actual picture)
Storage	
Media	Internal memory (approx. 43 MB), SD (Secure Digital) memory cards
File system	DCF, Exif 2.2, and DPOF compliant
File formats	Still pictures: JPEG Sound files (Voice Memo): WAV Movies: MOV (Video: MPEG-4 AVC/H.264, Audio: AAC stereo)

Specifications

Image size (pixels)	<ul style="list-style-type: none"> • 10 M 3648×2736 • 5 M 2592×1944 • 2 M 1600×1200 • PC 1024×768 • 3:2 3648×2432 • 1:1 2736×2736 • 8 M 3264×2448 • 3 M 2048×1536 • 1 M 1280×960 • VGA 640×480 • 16:9 3584×2016
ISO sensitivity (Standard output sensitivity)	<ul style="list-style-type: none"> • ISO 160, 200, 400, 800, 1600, 3200 • Auto (auto gain from ISO 160 to 800) • High ISO Sensitivity auto (ISO 160 to 1600) • Fixed range auto (ISO 160 to 200, 160 to 400) • Sport continuous mode (ISO 160 to 3200)
Exposure	256-segment matrix, center-weighted, spot, spot AF area (with support for 99 focus areas)
Metering	
Exposure control	Programmed auto exposure with flexible program, shutter priority auto, aperture-priority auto, manual, auto bracketing, motion detection, exposure compensation (-2.0 to +2.0 EV in steps of 1/3 EV)
Range (📷 Auto mode)	[W]: -1 to +16.2 EV [T]: 0.6 to 16.3 EV (exposure values achieved with automatic ISO sensitivity adjustment converted to ISO 100 values)
Shutter	Mechanical and CMOS electronic shutter
Speed	<ul style="list-style-type: none"> • 1/2000 -2 s • 1/2000 -8 s (S, A, M mode) • 1/8000 -1 s (sport continuous mode) • 4 s (Fireworks show scene mode)
Aperture	Electronically-controlled 6-blade iris diaphragm
Range	10 steps of 1/3 EV
Self-timer	Can be selected from 10 and 2 seconds duration
Built-in flash	
Range (approx.) (ISO sensitivity: Auto)	[W]: 0.5 to 10 m (1 ft. 8 in. to 32 ft.) [T]: 1.7 to 2.5 m (5 ft. 8 in. to 8 ft. 2 in.)
Flash control	TTL auto flash with monitor preflashes
Interface	Hi-Speed USB
Data transfer protocol	MTP, PTP
Video output	Can be selected from NTSC and PAL
I/O terminal	Audio/video output; digital I/O (USB); HDMI Mini Connector (HDMI output)
Supported languages	Arabic, Chinese (Simplified and Traditional), Czech, Danish, Dutch, English, Finnish, French, German, Greek, Hungarian, Indonesian, Italian, Japanese, Korean, Norwegian, Polish, Portuguese, Russian, Spanish, Swedish, Thai, Turkish

Power sources	One Rechargeable Li-ion Battery EN-EL5 (supplied) AC Adapter EH-62A (optional)
Charging time	Approx. 3 h 30 min (when using Charging AC Adapter EH-68P/ EH-68P (AR) and when no charge remains)
Battery life*	Approx. 250 shots (EN-EL5)
Dimensions (W × H × D)	Approx. 114.4 × 82.7 × 98.6 mm (4.5 × 3.3 × 3.9 in.) (excluding projections)
Weight	Approx. 481 g (17.0 oz) (with battery and SD memory card)
Operating environment	
Temperature	0 to 40 °C (32 to 104 °F)
Humidity	85 % and below (no condensation)

- Unless otherwise stated, all figures are for a camera with a fully-charged Rechargeable Li-ion Battery EN-EL5 operated at an ambient temperature of 25 °C (77 °F).

* Based on Camera and Imaging Products Association (CIPA) standards for measuring the life of camera batteries. Measured at 23 (±2) °C (73 (±4) °F); zoom adjusted with each shot, flash fired with every other shot, image quality set to **Normal**, image size set to  **3648×2736**. Battery life may vary depending on shooting interval and length of time menus and images are displayed.

Rechargeable Li-ion Battery EN-EL5

Type	Rechargeable lithium-ion battery
Rated capacity	DC 3.7 V, 1100 mAh
Operating temperature	0 to 40 °C (32 to 104 °F)
Dimensions (W × H × D)	Approx. 36 × 54 × 8 mm (1.4 × 2.1 × 0.3 in.) (excluding projections)
Weight	Approx. 30 g (1.1 oz) (excluding terminal cover)

Charging AC Adapter EH-68P/EH-68P (AR)

Rated input	AC 100-240 V, 50/60 Hz, 0.065-0.04 A
Rated capacity	6.5-9.6 VA
Rated output	DC 5.0 V, 0.5 A
Operating temperature	0 to 40 °C (32 to 104 °F)
Dimensions (W × H × D)	EH-68P: Approx. 55 × 22 × 65 mm (2.2 × 0.9 × 2.6 in.) EH-68P (AR): Approx. 55 × 51.6 × 66 mm (2.2 × 2.0 × 2.6 in.)
Weight	EH-68P: Approx. 60 g (2.1 oz) EH-68P (AR): 65 g (2.3 oz)

Specifications

- Nikon will not be held liable for any errors this manual may contain.
- The appearance of this product and its specifications are subject to change without notice.

Supported Standards

- **DCF:** Design Rule for Camera File System is a standard widely used in the digital camera industry to ensure compatibility among different makes of camera.
- **DPOF:** Digital Print Order Format is an industry-wide standard that allows pictures to be printed from print orders stored on the memory card.
- **Exif version 2.2:** This camera supports Exif (Exchangeable Image File Format for Digital Still Cameras) version 2.2, a standard that allows information stored with photographs to be used for optimal color reproduction when images are output from Exif-compliant printers.
- **PictBridge:** A standard developed cooperatively by the digital camera and printer industries, allowing photographs to be output directly to a printer without connecting the camera to a computer.

Index

Symbols

54

A Aperture-priority mode 66, 70

(apply selection) button 12

Auto mode 26

Delete button 32, 33, 117, 137

DISP (display) button 15

Exposure compensation 41

Flash mode 35

Flash pop-up button 35

Focus mode 39

Help 14

M Manual mode 66, 71

MENU Menu button 13

Monitor button 14

Movie-record button 127

Playback button 32

Playback mode 32

Playback zoom 106

P Programmed auto mode 66, 68

Scene auto selector 43

SCENE Scene mode 45

Self-timer 37

S Shutter-priority auto mode 66, 69

Smart Portrait mode 55, 57

Sport continuous mode 62, 64

Subject tracking mode 59, 61

T Tele 29

Thumbnail display 104

U User setting mode 98

W Wide 29

JPG 181

.MOV 181

.WAV 181

A

A/V cable 179

AC adapter 179

Active D-Lighting 95

AF area mode 90

AF assist 4, 163

Aperture 67

Aperture-priority auto 70

Audio/video cable 138

Audio/video-in jack 138

Auto 34

Auto bracketing 89

Auto mode 26

Auto off 165

Autofocus 39, 60, 93, 135

Autofocus mode 61, 93

AV cable 138

B

B&W + color 81

Backlight 51

Backlit scene HDR 52

Battery 16, 18, 179

Battery charger 20, 179

Battery level indicator 26

Battery-chamber/memory card slot cover
16, 24

Beach/snow 48

Best shot selector 86

Black border 125

Blink proof 58

Blink warning 169

BSS 86

Built-in flash 34

Button sound 165

C

Calendar display 105

Charge by computer 145, 168

Charger 179

Charging AC Adapter 18, 179

Choose key picture 116

Close-up 49

Command dial 11

Computer 140

Continuous 86

Copy 51

Crop 126

Custom 80

D

Date 22, 155

Date imprint 159

Daylight saving time 22, 156

Delete 32, 33, 103, 111, 117, 137

Digital zoom 29, 164

Diopter adjustment control 14

Distortion control 94

D-Lighting 121

DPOF printing 151

DSCN 181

Dusk/dawn  48

E

Electronic viewfinder 14

Electronic VR 136

Exposure compensation 41

Exposure mode 66

Extension 181

Eyelet for camera strap 7

F

Face priority 90

File name 181

Fill flash 34

Fireworks show  51

Firmware version 174

Fixed range auto 84

Flash exposure compensation 93

Flash indicator 36

Flash mode 34

Focus 30, 90, 93

Focus area 30

Focus indicator 30

Focus lock 31

Focus mode 38

Folder name 181

Food  50

Format 25, 166

Format the internal memory 166

Format the memory card 25, 166

FSCN 181

Full-frame playback 32, 33, 101

Full-time AF 93, 135

H

HDMI 138, 167

Help 14

Hide Image 114

High ISO Sensitivity auto 84

High speed continuous shooting 64

HS movie 130, 131, 134

I

Identifier 181

Image copy 115

Image quality 75

Image Sharpening 80

Image size 76

Infinity 38

Internal memory 24

Internal memory indicator 27

Interval Timer Shooting 86, 87

ISO sensitivity 36, 84

L

Landscape  46

Language 167

Lens 4, 177, 195

Lens cap 7, 179

Li-ion rechargeable battery 18, 179

Lithium-ion type battery 16, 18, 179

M

Macro close-up 38

Manual focus 38, 40

Manual Mode 71

Memory capacity 26

Memory card 24, 180

Memory card slot 24

Metering 85

Microphone 4, 117, 127

Minimum shutter speed 84

Mode dial 42

Monitor 8, 10, 177

Monitor brightness 158

Monitor settings 158

Monochrome filter 81

Motion detection 162

Movie length 135

Movie menu 132

Movie playback 137

Movie recording 127

Movie settings 133

Multi selector 12

Multi-shot 16 86

Museum  50

N



Night landscape  49

Night portrait  47
 Nikon Transfer 141
 Noise reduction 94
 Number of exposures remaining 26, 77

O

Off 34
 Optical zoom 29
 Optimize Image 79
 Optional accessories 179

P

Panorama assist  52, 53
 Paper size 148, 149
 Party/indoor  47
 PictBridge 146, 198
 Picture editing 118
 Pictures in a sequence 102
 Playback 32, 101, 104, 105, 106, 117, 137
 Playback menu 107
 Playback mode 32
 Playback zoom 106
 Portrait  46
 Power 21, 22, 26
 Power connector cover 4, 179
 Power switch/power-on lamp 18, 21
 Preset manual 83
 Pre-shooting cache 64, 65
 Press halfway 30
 Print 146, 148, 149
 Print set 108
 Print Set Date Option 109
 Printer 146
 Programmed auto mode 68
 Protect 113

Q

Quick retouch 120

R

Rear-curtain sync 34
 Rechargeable battery 179
 Recording 127
 Recording slow motion movies 130
 Red-eye reduction 34, 163
 Reset all 171
 Reset file numbering 174

Resetting Saved Settings 100
 Rotate image 114
 RSCN 181

S

Saturation 80
 Save to user setting 99
 Scene auto selector 43
 Scene mode 45
 Self-timer 37
 Self-timer lamp 37, 55
 Sequence display options 116
 Setup menu 152
 Shooting 26, 42
 Shooting menu 73
 Shooting with Face Priority 91
 Shutter sound 165
 Shutter speed 67
 Shutter-Priority Auto Mode 69
 Shutter-release button 30
 Single 86
 Single AF 93, 135
 Skin softening 57, 122
 Slide show 110
 Slow sync 34
 Small picture 124
 Smart portrait mode 55, 57
 Smile timer 57
 Sound settings 165
 Sport continuous mode 62, 64
 SSCN 181
 Subject Tracking Menu 59, 61
 Sunset  48
 Switching between tabs 13

T

Tele 29
 Television 138
 Thumbnail display 104
 Time difference 157
 Time zone 157
 TV settings 167

U

USB cable 141, 147, 179
 USB/Audio video connector 138, 141, 147
 User setting mode 98

Index

V

- Vari-angle monitor 6
- Vibration reduction 160
- Video output 167
- Voice memo 117
- Volume 137

W

- Welcome screen 154
- White balance 82
- Wide 29
- Wind Noise Reduction 136

Z

- Zoom 29
- Zoom control 29

Nikon

No reproduction in any form of this manual, in whole or in part (except for brief quotation in critical articles or reviews), may be made without written authorization from NIKON CORPORATION.



NIKON CORPORATION

Fuji Bldg., 2-3 Marunouchi 3-chome,
Chiyoda-ku, Tokyo 100-8331, Japan

© 2010 Nikon Corporation

Printed in Japan

FX0B02(11)

6MM74911-02