

Nikon

DIGITAL CAMERA

COOLPIX S620

User's Manual



En

Trademark Information

- Microsoft, Windows and Windows Vista are either registered trademarks or trademarks of Microsoft Corporation in the United States and/or other countries.
- Macintosh, Mac OS, and QuickTime are trademarks of Apple Inc.
- Adobe and Acrobat are registered trademarks of Adobe Systems Inc.
- The SD logo is a trademark of the SD Card Association.
- PictBridge is a trademark.
- All other trade names mentioned in this manual or the other documentation provided with your Nikon product are trademarks or registered trademarks of their respective holders.

Introduction

First Steps



Basic Photography and Playback : Auto Mode



Shooting Suited for the Scene



Automatic Shooting of Smiling Faces



Focusing on a Moving Subject in Subject Tracking Mode



More on Playback



Movies



Voice Recordings

Connecting to Televisions, Computers and Printers

MENU

Shooting, Playback and Setup Menus

Technical Notes

For Your Safety

To prevent damage to your Nikon product or injury to yourself or to others, read the following safety precautions in their entirety before using this equipment. Keep these safety instructions where all those who use the product will read them. The consequences that could result from failure to observe the precautions listed in this section are indicated by the following symbol:



This icon marks warnings, information that should be read before using this Nikon product, to prevent possible injury.

WARNINGS

Turn off in the event of malfunction

Should you notice smoke or an unusual smell coming from the camera or AC adapter, unplug the AC adapter and remove the battery immediately, taking care to avoid burns. Continued operation could result in injury. After removing or disconnecting the power source, take the equipment to a Nikon-authorized service representative for inspection.

Do not disassemble

Touching the internal parts of the camera or AC adapter could result in injury. Repairs should be performed only by qualified technicians. Should the camera or AC adapter break open as the result of a fall or other accident, take the product to a Nikon-authorized service representative for inspection, after unplugging the product and/or removing the battery.

Do not use the camera or AC adapter in the presence of flammable gas

Do not use electronic equipment in the presence of flammable gas, as this could result in explosion or fire.

Handle the camera strap with care

Never place the strap around the neck of an infant or child.

Keep out of reach of children

Particular care should be taken to prevent infants from putting the battery or other small parts into their mouths.

Observe caution when handling the battery

The battery may leak or explode if improperly handled. Observe the following precautions when handling the battery for use in this product:

- Before replacing the battery, turn the product off. If you are using the AC adapter, be sure it is unplugged.
- Use only a Rechargeable Li-ion Battery EN-EL12 (supplied). Charge the battery by inserting it in a Battery Charger MH-65 (supplied).
- When inserting the battery, do not attempt to insert it upside down or backwards.
- Do not short or disassemble the battery or attempt to remove or break the battery insulation or casing.
- Do not expose the battery to flame or to excessive heat.
- Do not immerse in or expose to water.
- Replace the terminal cover when transporting the battery. Do not transport or store with metal objects such as necklaces or hairpins.
- The battery is prone to leakage when fully discharged. To avoid damage to the product, be sure to remove the battery when no charge remains.
- Discontinue use immediately should you notice any change in the battery, such as discoloration or deformation.
- If liquid from the damaged battery comes in contact with clothing or skin, rinse immediately with plenty of water.

Observe the following precautions when handling the battery charger

- Keep dry. Failure to observe this precaution could result in fire or electric shock.
- Dust on or near the metal parts of the plug should be removed with a dry cloth. Continued use could result in fire.
- Do not handle the power cable or go near the battery charger during lightning storms. Failure to observe this precaution could result in electric shock.
- Do not damage, modify, forcibly tug or bend the power cable, place it under heavy objects, or expose it to heat or flames. Should the insulation be damaged and the wires become exposed, take it to a Nikon-authorized service representative for inspection. Failure to observe these precautions could result in fire or electric shock.
- Do not handle the plug or battery charger with wet hands. Failure to observe this precaution could result in electric shock.
- Do not use with travel converters or adapters designed to convert from one voltage to another or with DC-to-AC inverters. Failure to observe this precaution could damage the product or cause overheating or fire.

 **Use appropriate cables**

When connecting cables to the input and output jacks, use only the cables provided or sold by Nikon for the purpose, to maintain compliance with product regulations.

 **Handle moving parts with care**

Be careful that your fingers or other objects are not pinched by the lens cover or other moving parts.

 **CD-ROMs**

The CD-ROMs supplied with this device should not be played back on audio CD equipment. Playing CD-ROMs on an audio CD player could cause hearing loss or damage the equipment.

 **Observe caution when using the flash**

Using the flash close to your subject's eyes could cause temporary visual impairment. Particular care should be observed if photographing infants, when the flash should be no less than 1 m (3 ft. 4 in.) from the subject.

 **Do not operate the flash with the flash window touching a person or object**

Failure to observe this precaution could result in burns or fire.

 **Avoid contact with liquid crystal**

Should the monitor break, care should be taken to avoid injury caused by broken glass and to prevent liquid crystal from the monitor touching the skin or entering the eyes or mouth.

 **Turn the power off when using inside an airplane or the hospital**

Turn the power off while inside the airplane during take off or landing. Follow the instructions of the hospital when using while in a hospital. The electromagnetic waves given out by this camera may disrupt the electronic systems of the airplane or the instruments of the hospital.

Notices

Notice for Customers in the U.S.A.

Federal Communications Commission (FCC) Radio Frequency Interference Statement

This equipment has been tested and found to comply with the limits for a Class B digital device, pursuant to Part 15 of the FCC rules. These limits are designed to provide reasonable protection against harmful interference in a residential installation. This equipment generates, uses, and can radiate radio frequency energy and, if not installed and used in accordance with the instructions, may cause harmful interference to radio communications. However, there is no guarantee that interference will not occur in a particular installation. If this equipment does cause harmful interference to radio or television reception, which can be determined by turning the equipment off and on, the user is encouraged to try to correct the interference by one or more of the following measures:

- Reorient or relocate the receiving antenna.
- Increase the separation between the equipment and receiver.
- Connect the equipment into an outlet on a circuit different from that to which the receiver is connected.
- Consult the dealer or an experienced radio/television technician for help.



Nikon

COOLPIX S620

CAUTIONS

Modifications

The FCC requires the user to be notified that any changes or modifications made to this device that are not expressly approved by Nikon Corporation may void the user's authority to operate the equipment.

Interface Cables

Use the interface cables sold or provided by Nikon for your equipment. Using other interface cables may exceed the limits of Class B Part 15 of the FCC rules.

Notice for customers in the State of California

WARNING

Handling the cord on this product will expose you to lead, a chemical known to the State of California to cause birth defects or other reproductive harm.

Wash hands after handling.

Nikon Inc.,

1300 Walt Whitman Road
Melville, New York 11747-3064
USA

Tel: 631-547-4200

Notice for customers in Canada

CAUTION

This Class B digital apparatus complies with Canadian ICES-003.

ATTENTION

Cet appareil numérique de la classe B est conforme à la norme NMB-003 du Canada.

Notice for customers in Europe

This symbol indicates that this product is to be collected separately.



The following apply only to users in European countries:

- This product is designated for separate collection at an appropriate collection point. Do not dispose of as household waste.
- For more information, contact the retailer or the local authorities in charge of waste management.

This symbol on the battery indicates that the battery is to be collected separately.



The following apply only to users in European countries:

- All batteries, whether marked with this symbol or not, are designated for separate collection at an appropriate collection point. Do not dispose of as household waste.
- For more information, contact the retailer or the local authorities in charge of waste management.

Table of Contents































For Your Safety	ii
WARNINGS	ii
Notices	v
<hr/>	
Introduction	1
About This Manual	1
Information and Precautions	2
Parts of the Camera	4
The Camera Body.....	4
The Monitor.....	6
Basic Operations.....	8
The  (shooting mode) Button	8
The  (playback) Button	9
The Rotary Multi Selector	10
The MENU Button.....	12
Switching Between Tabs	12
Help Displays.....	13
Pressing the Shutter-Release Button Halfway/All the Way Down.....	13
Attaching the Camera Strap	13
<hr/>	
First Steps	14
Charging the Battery	14
Inserting the Battery	16
Removing the Battery	17
Turning On and Off the Camera.....	17
Setting Display Language, Date and Time.....	18
Inserting Memory Cards.....	20
Removing Memory Cards.....	20
<hr/>	
 Basic Photography and Playback : Auto Mode.....	22
Step 1 Turn the Camera On and Select  (Auto) Mode.....	22
Indicators Displayed in  (Auto) Mode	23
Step 2 Frame a Picture.....	24
Using the Zoom.....	25
Step 3 Focus and Shoot	26
Step 4 Viewing and Deleting Pictures	28
Viewing Pictures (Playback Mode)	28
Deleting Pictures.....	28
Using the Flash.....	30
Setting the Flash Mode.....	30
Taking Pictures with the Self-Timer	32
Macro Mode	33
Exposure Compensation	34

Table of Contents

 Shooting Suited for the Scene	35
Shooting in Scene Mode	35
Setting the Scene Mode.....	35
Features.....	36
Shooting in the Scene Mode Selected by the Camera (Scene Auto Selector).....	42
Taking Pictures in Food Mode	44
Taking Pictures for a Panorama	46
 Automatic Shooting of Smiling Faces	48
Shooting in Smile Mode	48
Notes on Blink Proof.....	49
 Focusing on a Moving Subject in Subject Tracking Mode	50
Subject Tracking Mode	50
 More on Playback	52
Viewing Multiple Pictures: Thumbnail Playback	52
Calendar Display.....	53
Taking a Closer Look: Playback Zoom	54
Editing Pictures	55
Using Quick Retouch.....	56
Enhancing Brightness and Contrast: D-Lighting	57
Creating a Cropped Copy: Crop	58
Resizing Pictures: Small Picture	59
Voice Memos: Recording and Playback	60
Recording Voice Memos	60
Playing Voice Memos	61
Deleting Voice Memos	61
Viewing Pictures by Date (List by Date Mode)	62
Selecting a Date in List by Date Mode	62
Using List by Date Mode	63
List by Date Menu	64
Image Searching (Auto Sort Mode)	65
Displaying Pictures in the Auto Sort Mode	65
Auto Sort Mode	67
Auto Sort Menu	67

🎬 Movies	68
Recording Movies	68
The Movie Menu	69
🎬 Selecting Movie Options	69
🔊 Autofocus Mode	69
Movie Playback	70
Deleting Movie Files	70
<hr/>	
🎤 Voice Recordings	71
Making Voice Recordings	71
Playing Voice Recordings	73
Deleting Sound Files	74
Copying Voice Recordings	75
<hr/>	
Connecting to Televisions, Computers and Printers	76
Connecting to a TV	76
Connecting to a Computer	77
Before Connecting the Camera	77
Transferring Pictures from the Camera to a Computer	78
Connecting to a Printer	81
Connecting the Camera to a Printer	82
Printing Pictures One at a Time	83
Printing Multiple Pictures	84
Creating a DPOF Print Order: Print Set	87
<hr/>	
MENU Shooting, Playback and Setup Menus	89
Shooting Options: The Shooting Menu	89
Displaying the Shooting Menu	89
🔍 Image Mode	90
WB White Balance	92
📊 Metering	94
📺 Continuous	95
ISO ISO Sensitivity	97
🎨 Color Options	98
🔍 AF-Area Mode	99
🔊 Autofocus Mode	102
Functions that Cannot be Applied Simultaneously	103

Table of Contents

Playback Options: The Playback Menu	104
Displaying the Playback Menu	104
 Slide Show.....	106
 Delete.....	107
 Protect.....	107
 Rotate Image.....	108
 Copy.....	109
Basic Camera Setup: The Setup Menu.....	110
Displaying the Setup Menu.....	111
 Menus.....	112
 Welcome Screen.....	113
 Date.....	114
 Monitor Settings.....	117
 Date Imprint.....	118
 Vibration Reduction.....	119
 Motion Detection.....	120
 AF Assist.....	121
 Digital Zoom.....	121
 Sound Settings.....	122
 Auto Off.....	122
 Format Memory/Format Card.....	123
 Language.....	124
 Video Mode.....	124
 Blink Warning.....	125
 Reset All.....	127
 Firmware Version.....	129
<hr/>	
Technical Notes	130
Optional Accessories	130
Approved Memory Cards	130
File and Folder Names.....	131
Caring for the Camera	132
Cleaning	134
Storage.....	135
Error Messages.....	136
Troubleshooting.....	140
Specifications	145
Supported Standards	148
Index.....	149

About This Manual

Thank you for your purchase of a Nikon COOLPIX S620 digital camera. This manual was written to help you enjoy taking pictures with your Nikon digital camera. Read this manual thoroughly before use, and keep it where all those who use the product will read it.

Symbols and Conventions

To make it easier to find the information you need, the following symbols and conventions are used:



This icon marks cautions, information that should be read before use, to prevent damage to the camera.



This icon marks tips, additional information that may be helpful when using the camera.



This icon marks notes, information that should be read before using the camera.



This icon indicates that more information is available elsewhere in this manual or in the *Quick Start Guide*.

Notations

- A Secure Digital (SD) memory card is referred to as a “memory card”.
- The setting at the time of purchase is referred to as the “default setting”.
- The names of menu items displayed in the camera monitor, and the names of buttons or messages displayed in a computer monitor are indicated in bold text.

Screen Samples

In this manual, images are sometimes omitted from monitor display samples so that monitor indicators can be more clearly shown.

Illustrations and Screen Display

Illustrations and text displays shown in this manual may differ from actual display.

Memory Cards

Pictures taken with this camera can be stored in the camera's internal memory or on removable memory cards. If a memory card is inserted, all new pictures will be stored on the memory card and delete, playback, and format operations will apply only to the pictures on the memory card. The memory card must be removed before the internal memory can be formatted or used to store pictures to, or delete, or view pictures.

Information and Precautions

Life-Long Learning

As part of Nikon's "Life-Long Learning" commitment to ongoing product support and education, continually updated information is available online at the following sites:

- For users in the U.S.A.: <http://www.nikonusa.com/>
- For users in Europe and Africa: <http://www.europe-nikon.com/support/>
- For users in Asia, Oceania, and the Middle East: <http://www.nikon-asia.com/>

Visit these sites to keep up-to-date with the latest product information, tips, answers to frequently asked questions (FAQs), and general advice on digital imaging and photography. Additional information may be available from the Nikon representative in your area. See the URL below for contact information:

<http://imaging.nikon.com/>

Use Only Nikon Brand Electronic Accessories

Nikon COOLPIX cameras are designed to the highest standards and include complex electronic circuitry. Only Nikon brand electronic accessories (including battery chargers, batteries and AC adapters) certified by Nikon specifically for use with this Nikon digital camera are engineered and proven to operate within the operational and safety requirements of this electronic circuitry.

THE USE OF NON-NIKON ELECTRONIC ACCESSORIES COULD DAMAGE THE CAMERA AND MAY VOID YOUR NIKON WARRANTY.

The use of third-party rechargeable Li-ion batteries not bearing the Nikon holographic seal could interfere with normal operation of the camera or result in the batteries overheating, igniting, rupturing, or leaking.

For more information about Nikon brand accessories, contact a local authorized Nikon dealer.

Holographic seal: Identifies this device as an authentic Nikon product.



Before Taking Important Pictures

Before taking pictures on important occasions (such as at weddings or before taking the camera on a trip), take a test shot to ensure that the camera is functioning normally. Nikon will not be held liable for damages or lost profits that may result from product malfunction.

About the Manuals

- No part of the manuals included with this product may be reproduced, transmitted, transcribed, stored in a retrieval system, or translated into any language in any form, by any means, without Nikon's prior written permission.
- Nikon reserves the right to change the specifications of the hardware and software described in these manuals at any time and without prior notice.
- Nikon will not be held liable for any damages resulting from the use of this product.
- While every effort was made to ensure that the information in these manuals is accurate and complete, we would appreciate it were you to bring any errors or omissions to the attention of the Nikon representative in your area (address provided separately).

Notice Concerning Prohibition of Copying or Reproduction

Note that simply being in possession of material that was digitally copied or reproduced by means of a scanner, digital camera or other device may be punishable by law.

• Items prohibited by law from being copied or reproduced

Do not copy or reproduce paper money, coins, securities, government bonds or local government bonds, even if such copies or reproductions are stamped "Sample". The copying or reproduction of paper money, coins, or securities which are circulated in a foreign country is prohibited. Unless the prior permission of the government was obtained, the copying or reproduction of unused postage stamps or post cards issued by the government is prohibited.

The copying or reproduction of stamps issued by the government and of certified documents stipulated by law is prohibited.

• Cautions on certain copies and reproductions

The government has issued cautions on copies or reproductions of securities issued by private companies (shares, bills, checks, gift certificates, etc.), commuter passes or coupon tickets, except when a minimum of necessary copies are to be provided for business use by a company. Also, do not copy or reproduce passports issued by the government, licenses issued by public agencies and private groups, ID cards and tickets, such as passes and meal coupons.

• Comply with copyright notices

The copying or reproduction of copyrighted creative works such as books, music, paintings, woodcut prints, maps, drawings, movies and photographs is governed by national and international copyright laws. Do not use this product for the purpose of making illegal copies or to infringe copyright laws.

Disposing of Data Storage Devices

Please note that deleting images or formatting data storage devices such as memory cards or built-in camera memory does not completely erase the original image data. Deleted files can sometimes be recovered from discarded storage devices using commercially available software, potentially resulting in the malicious use of personal image data. Ensuring the privacy of such data is the user's responsibility.

Before discarding a data storage device or transferring ownership to another person, erase all data using commercial deletion software, or format the device and then completely refill it with images containing no private information (for example, pictures of empty sky). Be sure to also replace any pictures selected for the welcome screen (□ 113). Care should be taken to avoid injury or damage to property when physically destroying data storage devices.



Parts of the Camera

The Camera Body

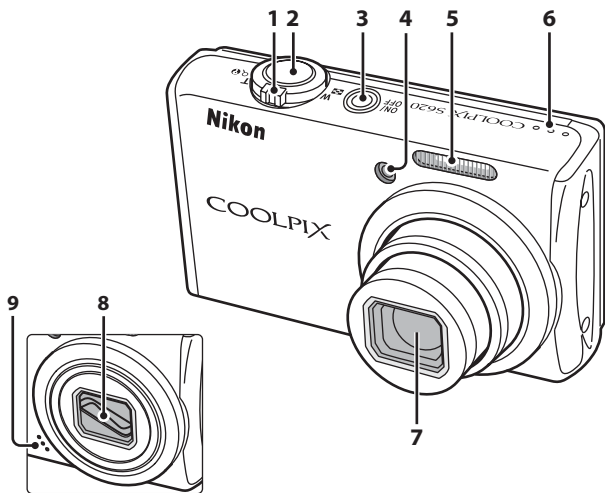
Introduction



Lens cover closed

1	Zoom control 25	5 Built-in flash 30
	W : Wide 25	6 Speaker 60, 70, 73
	T : Tele 25	7 Lens 134, 145
	 : Thumbnail playback 52, 53	8 Lens cover
	 : Playback zoom 54	9 Built-in microphone 60, 68, 71
	 : Help 13	
2	Shutter-release button 13, 26	
3	Power switch/Power-on lamp 17, 122	
4	Self-timer lamp 32	
	AF-assist illuminator 121	

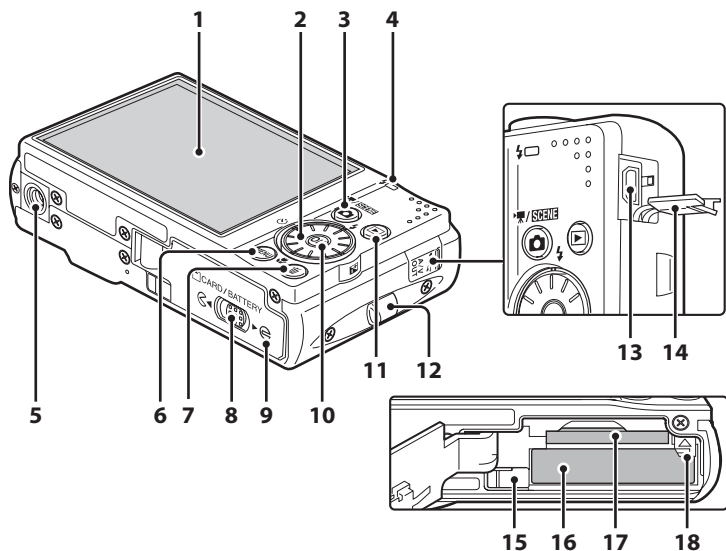

1	Monitor	6, 23
2	Rotary multi selector	10
3	(shooting mode) button	8
4	Indicator lamp	71
	Flash lamp	31
5	Tripod socket	
6	MENU button	12, 89, 104, 111
7	(delete) button	28, 29, 61, 70, 74
8	Cover latch	16, 20
9	Battery-chamber/ memory card slot cover	16, 20

10	(apply selection) button	10
11	(playback) button	9, 28
12	Eyelet for camera strap	13
13	Cable connector	76, 78, 82
14	Connector cover	76, 78, 82
15	Power connector cover	130
16	Battery chamber	16
17	Memory card slot	20
18	Battery latch	16, 17

The Monitor

The following indicators may appear in the monitor during shooting and playback (actual display varies with current camera settings).

The indicators and photo info displayed during shooting and playback will turn off after a few seconds (📖117).

Shooting

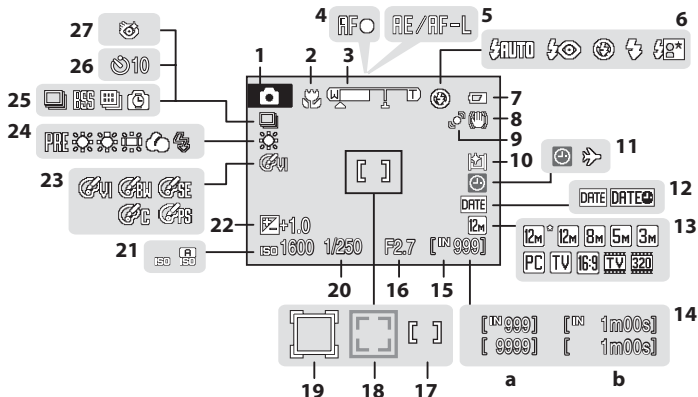

1	Shooting mode*.....	22, 35, 50, 48, 68	14	(a) Number of exposures remaining (still pictures).....	22
2	Macro mode.....	33	15	(b) Movie length.....	68
3	Zoom indicator.....	25, 33	16	Internal memory indicator.....	23
4	Focus indicator.....	26	17	Aperture.....	26
5	AE/AF-L indicator.....	47	18	Focus area.....	26, 99
6	Flash mode.....	30	19	Focus area (Face Priority).....	48, 99
7	Battery level indicator.....	22	20	Focus area (Subject Tracking mode).....	50
8	Vibration reduction icon.....	23, 119	21	Shutter speed.....	26
9	Motion detection icon.....	23, 120	22	ISO sensitivity.....	31, 97
10	Monitor brightness boost indicator	23	23	Exposure compensation value.....	34
11	"Date not set" indicator.....	114	24	Color options.....	98
12	Time zone indicator.....	114	25	White balance mode.....	92
13	Date imprint.....	118	26	Continuous shooting mode.....	95
	Image mode.....	90	27	Self-timer indicator.....	32
	Movie options.....	69		Blink proof.....	49

* Differs according to the current shooting mode. Refer to the sections on each mode for details.

Playback

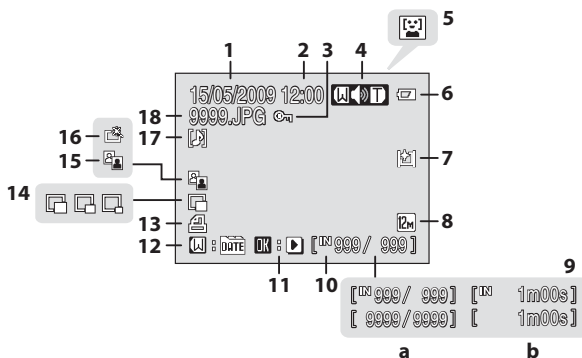

1	Date of recording.....	18	10	Internal memory indicator	28
2	Time of recording.....	18	11	Movie playback indicator.....	70
3	Protect icon	107	12	List by date guide.....	62
4	Volume indicator.....	61, 70, 73	13	Print-order icon	87
5	Auto sort folder icon ¹	65	14	Small picture	58, 59
6	Battery level indicator	22	15	D-Lighting icon	57
7	Monitor brightness boost indicator..	23	16	Quick retouch icon.....	56
8	Image mode ²	90	17	Voice memo indicator.....	61
	Movie option ²	70	18	File number and type	131
9	(a) Current frame number/ total number of frames	28			
	(b) Movie length.....	70			



1 The icons for auto sorting playback folder selected in playback will appear.

2 Differs according to the selected option.

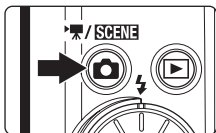

Basic Operations

The (shooting mode) Button





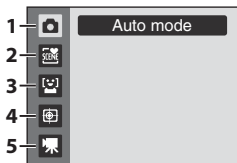

- Press the  button in playback mode to change to shooting mode.
- Press the  button in shooting mode to display the shooting-mode selection menu.

Shooting-mode Selection Menu

The rotary multi selector can be used in the shooting-mode selection menu to change the shooting mode. To exit the shooting-mode selection menu, choose a shooting mode and press the  button or press the  button again.









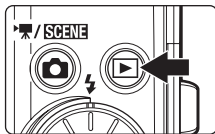

1.  Auto mode (22)
2.  Scene mode (35)*
3.  Smile mode (48)
4.  Subject tracking mode (50)
5.  Movie mode (68)



* The icon displayed will differ according to the last chosen mode.

The (playback) Button









- Press the  button in shooting mode to change to playback mode.
- Press the  button in playback mode to display the playback-mode selection menu.
- When the camera is off, holding down the  button will turn the camera on in playback mode (28).
- Press and hold down the  button while the camera is on to turn up the monitor brightness to the maximum level. Press and hold down the  button again to return to the original level of brightness. When the  button is used to change the brightness level to the maximum level, the  icon will be displayed on the monitor.

Playback-mode Selection Menu

The rotary multi selector can be used in the playback-mode selection menu to change the playback mode. To exit the playback-mode selection menu, choose a playback mode and press the  button or press the  button again.



1.  Playback mode ()28)
2.  Auto sort mode ()65)
3.  List by date mode ()62)

The Rotary Multi Selector

This section describes standard uses of the rotary multi selector to select modes, select menu options, and to apply selection.

For Shooting

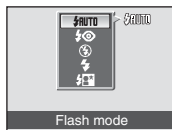
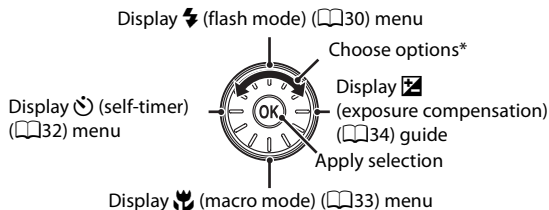

* Options can also be chosen by pressing the rotary multi selector up or down.

For Playback

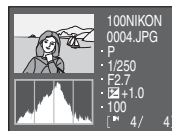
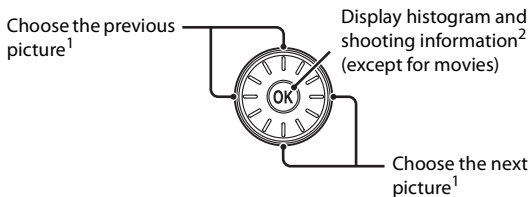

1 Subsequent or previous pictures can also be selected by rotating the rotary multi selector.

2 A graph showing tone distribution. The horizontal axis corresponds to pixel brightness, with dark tones to the left and bright tones to the right. The vertical axis shows the number of pixels.

The shooting information displayed includes the folder name, file name, shooting mode used, shutter speed, aperture, exposure compensation, ISO sensitivity, and the current file number.

P will be displayed for shooting mode.

Press the button again to return to full-frame playback.

For the Menu Screen

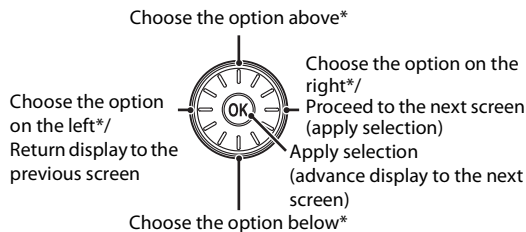

* Options can also be chosen by rotating the rotary multi selector.

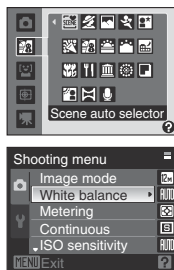

Note on the Rotary Multi Selector

In this manual, up, down, left, and right presses of the rotary multi selector may be indicated with ▲, ▼, ◀ and ▶.

The MENU Button

Press the **MENU** button to display the menu for the chosen mode.

- Use the rotary multi selector to navigate the menus (11).
- Choose the **Y** tab on the left to display the setup menu.
- Press the **MENU** button again to exit the menu.

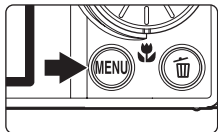

Displayed when the menu contains two or more pages

- Upper tab: Display the menus for the current mode used
- Lower tab: Displays the setup menu

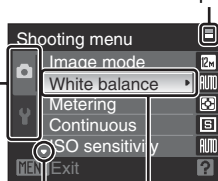

Displayed when there are one or more menu options to follow

The selected option

Displayed when there are previous menu options

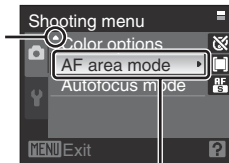

Press the **OK** button or the rotary multi selector **▶** to proceed to the next set of options.



Press the **OK** button or the rotary multi selector **▶** to apply selection.

Switching Between Tabs

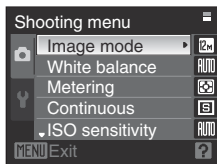

Press the rotary multi selector **◀** to highlight the tab.



Press the rotary multi selector **▲** or **▼** to choose another tab, and press either the **OK** button or **▶**.

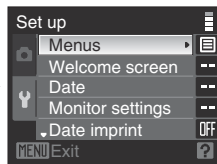

The chosen menu is displayed.

Help Displays

Rotate the zoom control to **T** (?) when **[?]/[?]** is displayed at the bottom of the menu screen to view a description of the currently selected menu option. To return to the original menu, rotate the zoom control to **T** (?) again.

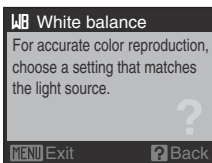
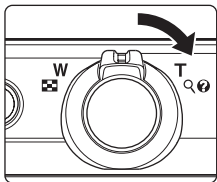

Pressing the Shutter-Release Button Halfway/All the Way Down

The camera features a two-stage shutter-release button. To set focus and exposure, press the shutter-release button halfway, stopping when you feel resistance. Focus and exposure lock while the shutter-release button is held in this position. To release the shutter and take a picture, press the shutter-release button the rest of the way down.

Do not use force when pressing the shutter-release button, as this may result in camera shake and blurred pictures.



Press the shutter-release button halfway to set focus and exposure.

Press the shutter-release button the rest of the way down to shoot.

Attaching the Camera Strap

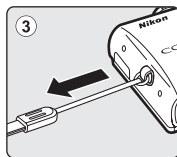
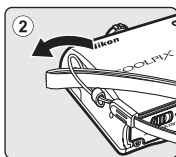
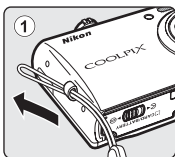

Charging the Battery

Charge the Rechargeable Li-ion Battery EN-EL12 (supplied) using the Battery Charger MH-65 (supplied).

1 Connect the power cable in the order of ①-②.

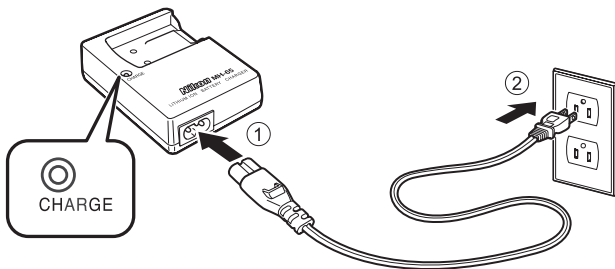

2 Insert the battery into the battery charger by sliding the battery forward ①, and press down until it locks into place ②.

- CHARGE lamp starts blinking when charging starts.
- Charging is complete when the lamp stops blinking.
- About 150 minutes are required to charge a fully exhausted battery.

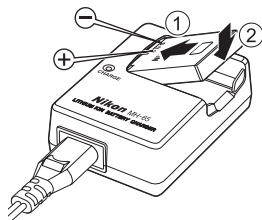

The following chart explains CHARGE lamp status.

CHARGE lamp	Description
Blinks	Battery charging.
On	Battery fully charged.
Flickers	<ul style="list-style-type: none"> The battery is not inserted correctly. Remove the battery and reinsert it into the battery charger so that the battery is lying flat. Charge the battery indoors with an ambient temperature of 5°C to 35°C (41°F to 95°F) before use. The battery is faulty. Unplug the charger immediately and stop charging the battery. Bring the battery and charger to a Nikon-authorized service representative for inspection.

3 Remove the battery and unplug the charger.

Notes on the Battery Charger

- The supplied battery charger is for use only with a Rechargeable Li-ion Battery EN-EL12. Do not use with incompatible batteries.
- Be sure to read and follow the warnings and cautions of “For Your Safety” (📖ii) thoroughly before using the battery charger.

Notes on the Battery

- Be sure to read and follow the warnings and cautions of “For Your Safety” (📖ii) thoroughly before using the battery.
- Be sure to read and follow the warnings for “The Battery” (📖133) of the section “Caring for the Camera” thoroughly before using the battery.
- If the battery will not be used for an extended period, recharge it at least once every six months and run it flat before returning it to storage.

Note on AC Power Supply

To power the camera continuously for extended periods, use the AC Adapter EH-62F (available separately from Nikon) (📖130). Do not, under any circumstances, use another make or model of AC adapter. Failure to observe this precaution could result in overheating or in damage to the camera.

Inserting the Battery

Insert a Rechargeable Li-ion Battery EN-EL12 (supplied) into the camera.

- Charge the battery before first use or when the battery is running low (14).

- 1 Open the battery-chamber/memory card slot cover.

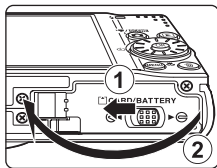

- 2 Insert the battery.

- Confirm that the positive (+) and negative (-) terminals are oriented correctly, as shown on the label at the entrance of the battery chamber, and insert the battery.
- Use the battery to push the battery latch in the direction indicated by the arrow ① and fully insert the battery ②. When the battery is fully inserted, the battery latch will lock it in place.

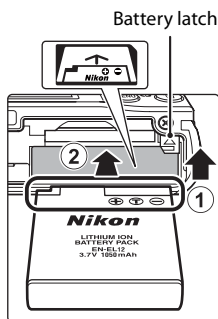

✓ Inserting the Battery Correctly

Inserting the battery upside down or backwards could damage the camera. Be sure to check the battery is in the correct orientation.



- 3 Close the battery-chamber/memory card slot cover.

- Close the battery-chamber/memory card slot cover ①, and slide the cover latch to the \blacktriangleright position ②.

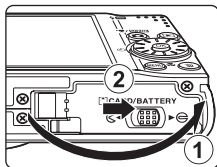

Removing the Battery

Turn the camera off and confirm that the power-on lamp and the monitor are off before opening the battery-chamber/memory card slot cover.

To eject the battery, open the battery-chamber/memory card slot cover and slide the battery latch in the direction shown ①. The battery can then be removed by hand ②.

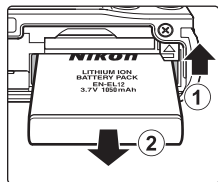

- Note that the battery may become hot during use; observe due caution when removing the battery.



Turning On and Off the Camera

Press the power switch to turn on the camera. The power-on lamp (green) will light for a moment and the monitor will turn on.

Press the power switch again to turn off the camera. When the camera turns off, both the power-on lamp and monitor will turn off.

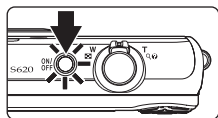

- When the camera is off, holding down the  button will turn the camera on in playback mode (28).



Auto Power Off in Shooting Mode (Standby Mode)

If no operations are performed for about a minute (default setting), the monitor will turn off automatically and the camera will enter standby mode. If no operations are performed for another three minutes, the camera will turn off automatically (the auto off function).

If the monitor is off in standby mode, press the power switch or the shutter-release button to reactivate it.

- The time allowed to elapse before the camera enters standby mode can be changed from the **Auto off** option (122) in the setup menu (110).

Setting Display Language, Date and Time

A language-selection dialog is displayed the first time the camera is turned on.

1 Press the power switch to turn on the camera.

- The power-on lamp (green) will light for a moment and the monitor will turn on.

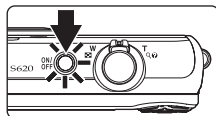

2 Use the rotary multi selector to choose the desired language and press the **OK** button.

- For information on using the rotary multi selector, see "The Rotary Multi Selector" (10).



3 Choose **Yes** and press the **OK** button.

- If **No** is selected, the date and time will not be set.

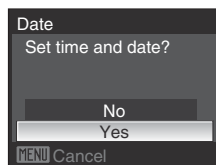

4 Press the rotary multi selector **◀** or **▶** to select your home time zone (116) and press the **OK** button.

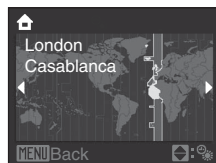

Daylight Saving Time

If daylight saving time is in effect, press the rotary multi selector **▲** in the time zone selection screen displayed in step 4 to turn on the daylight saving time option.

When the daylight saving time option is enabled,  is displayed at the top of the monitor. To turn off the daylight saving time option, press **▼**.



5 Edit the date.

- Rotate the rotary multi selector, or press ▲ or ▼ to edit the highlighted item.
- Press ► to move the highlight in the following order.
D (day) → **M** (month) → **Y** (year) → **hour** → **minute** → **DMY** (the order in which the day, month, and year are displayed)
- Press ◀ to return to the previous item.

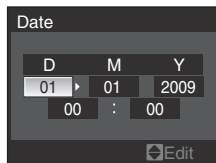

6 Choose the order in which the day, month and year are displayed and press the OK button or ►.

- The settings are applied and monitor display exits to shooting mode.

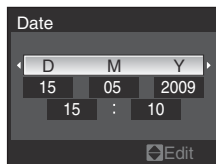

Changing the Date and Time

- Select **Date** from the **Date** (📖114) in the setup menu (📖110) to change the current date and time and follow the procedure described in step 5 above.
- Select **Time zone** from the **Date** in the setup menu to change the time zone and daylight saving time settings (📖114).

Inserting Memory Cards

Image, sound, and movie files are stored in the camera's internal memory (approx. 45 MB) or on removable memory cards (available separately) (📖130).

If a memory card is inserted in the camera, data are automatically stored on the memory card and data recorded to the memory card can be played back, deleted, or transferred. Remove the memory card to store data in the internal memory, or play back, delete, or transfer data from the internal memory.

- 1 Confirm the power-on lamp and the monitor are turned off and open the battery-chamber/memory card slot cover.

- Be sure to turn off the camera before opening the battery-chamber/memory card slot cover.

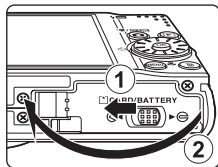

- 2 Insert the memory card.

- Slide the memory card in correctly as shown on the right, until it clicks into place.
- Close the battery-chamber/memory card slot cover after inserting the memory card.

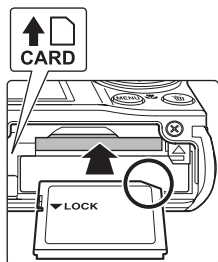

❑ Inserting the Memory Card Correctly

Inserting the memory card upside down or backwards could damage the camera or the memory card. Be sure to check the memory card is in the correct orientation.

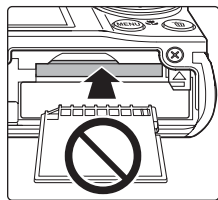

Removing Memory Cards

Before removing memory cards, **turn the camera off** and confirm that the power-on lamp and the monitor are off.

Open the battery-chamber/memory card slot cover and press the card in ① gently to partially eject the card. The card can then be removed by hand ②.

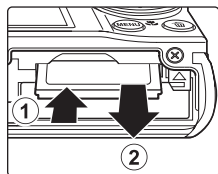

✓ Formatting a Memory Card

If the message at the right is displayed when the camera is turned on, the memory card must be formatted before use. **Note that formatting (📖123) permanently deletes all data on the memory card.** Be sure to make copies of any pictures you wish to keep before formatting the memory card.

Use the rotary multi selector to choose **Yes** and press the **OK** button. When the confirmation dialog is displayed, choose **Format** and press the **OK** button to start formatting.

- Do not turn the camera off or open the battery-chamber/memory card slot cover until formatting is complete.
- When you insert memory cards used in other devices into this camera for the first time, be sure to format them (📖123) with this camera.

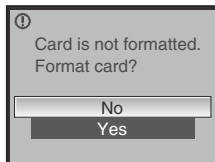

✓ The Write Protect Switch

Memory cards are equipped with a write protect switch. When this switch is in the “lock” position, data cannot be written to, or deleted from, the memory card. If the switch is in the “lock” position, unlock it by sliding the switch to the “write” position to record or delete pictures, or to format the memory card.

Write protect switch

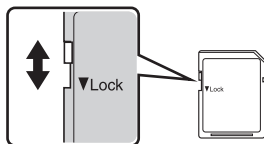

✓ Memory Cards

- Use only Secure Digital memory cards.
- Do not perform the following during formatting, while data is being written to or deleted from the memory card, or during data transfer to a computer. Failure to observe this precaution could result in the loss of data or in damage to the camera or memory card:
 - Eject the memory card
 - Remove the battery
 - Turn off the camera
 - Disconnect the AC adapter
- Do not use a computer to format the memory card.
- Do not disassemble or modify.
- Do not drop, bend, or expose to water or strong physical shocks.
- Do not touch the metal terminals with your fingers or metal objects.
- Do not affix labels or stickers to the memory card.
- Do not leave in direct sunlight, closed vehicles or areas exposed to high temperatures.
- Do not expose to humidity, dust, or to corrosive gases.

Step 1 Turn the Camera On and Select (Auto) Mode

This section describes how to take pictures in  (auto) mode, an automatic, “point-and-shoot” mode recommended for first-time users of digital cameras.

1 Press the power switch to turn on the camera.

- The power-on lamp (green) will light for a moment and the monitor will turn on. The lens will also extend.
- Proceed to step 4 when  is displayed on the monitor.

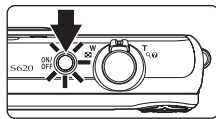

2 Press the button.

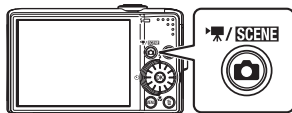

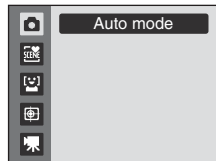

3 Use the rotary multi selector to choose and press the .

- The camera enters  (auto) mode.



4 Check the battery level and number of exposures remaining in the monitor.

Battery Level

Monitor	Description
NO INDICATOR	Battery fully charged.
	Battery level low; prepare to charge or replace the battery.
 Battery exhausted.	Cannot shoot. Recharge or replace with a fully-charged battery.

Battery level indicator

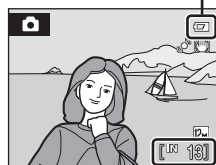

Number of exposures remaining

Number of Exposures Remaining

The number of exposures remaining will be displayed.

The number of pictures that can be stored depends on the remaining capacity of the internal memory or memory card and the image mode setting (91).



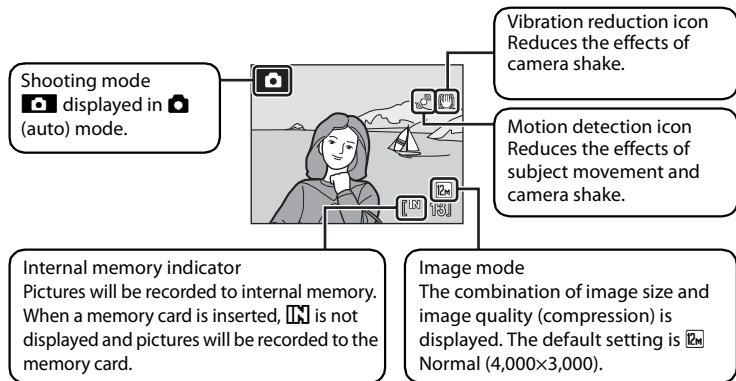

Indicators Displayed in (Auto) Mode









The indicators and photo info displayed during shooting and playback will turn off after a few seconds ( 117).

If the monitor is turned off in standby mode to save power, press the power switch or the shutter-release button to reactivate it ( 122).

Monitor Brightness Boost

If it is difficult to see the monitor display when shooting outdoors, holding down the  button while the power is on to switch monitor brightness to the maximum setting. Hold down the  button again to change back to the original brightness. The  icon will be displayed in the monitor when the brightness setting is set to the maximum by pressing the  button.

Functions Available in (Auto) Mode

In  (auto) mode, macro mode ( 33) and exposure compensation ( 34) can be applied and pictures can be taken using the flash mode ( 30) and self-timer ( 32). Pressing the **MENU** button in  (auto) mode allows you to specify settings for all shooting menu options ( 89).

Vibration Reduction

When **On** (default setting) is chosen for **Vibration reduction** ( 119), the camera effectively reduces camera shake that commonly occurs when shooting with zoom applied or at slow shutter speeds.

Set **Vibration reduction** to **Off** when using a tripod to stabilize the camera during shooting.

Motion Detection

When **Auto** (default setting) is chosen for **Motion detection** option ( 120) in the setup menu and the camera detects camera shake and subject movement, the camera increases shutter speed to reduce blurring.

When the camera detects camera shake or subject movement and increases shutter speed, the motion detection icon will glow green.

Step 2 Frame a Picture

1 Ready the camera.

- Hold the camera steadily in both hands.
- Keep your fingers, hair, strap and other objects away from the lens, flash, AF-assist illuminator, microphone and speaker.

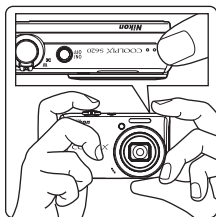

2 Frame the picture.

- Position the main subject near the center of the monitor.

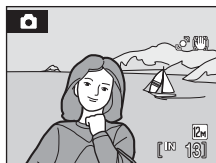

Using the Zoom

Rotate the zoom control to activate optical zoom. Rotate in the direction of **T** to zoom in on the subject. Or rotate in the direction of **W** to have a wider view. A zoom indicator is displayed at the top of the monitor when the zoom control is rotated.

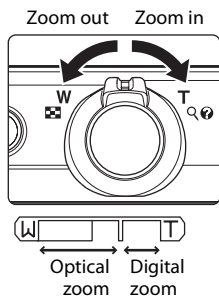

Digital Zoom

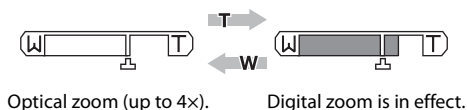

When the camera is already at the maximum optical zoom magnification, rotating the zoom control in the **T** direction will trigger digital zoom. The subject can be magnified up to 4x of the maximum optical zoom ratio.

Focus will be on the center of the frame and the focus area will not be displayed when digital zoom is in effect.



Digital Zoom and Interpolation

Unlike optical zoom, digital zoom uses a digital imaging process known as interpolation to magnify images, resulting in slight deterioration of picture quality according to the image mode (□90) and digital zoom magnification.

Interpolation is applied at zoom positions beyond . When zoom is increased beyond the  position, interpolation is initiated and the zoom indicator turns yellow to indicate that interpolation is being applied.

The position of  moves to the right as image size decreases, allowing for confirmation of the zoom positions at which shooting without interpolation is possible at the current image mode setting.



When the image size is small

- Digital zoom can be disabled from the **Digital zoom** option (□121) in the setup menu (□110).

Step 3 Focus and Shoot

1 Press the shutter-release button halfway.

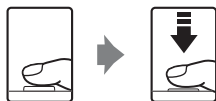

- Camera automatically selects the focus area (one of nine) containing the subject closest to the camera. When the subject is in focus, the focus area (active focus area) glows green.

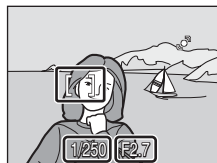
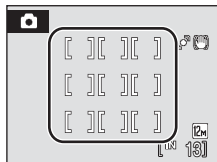

Shutter speed Aperture

- When digital zoom is in effect, the focus area is not displayed. When the camera focuses on the subject in the center of the frame, the focus indicator (L/6) will glow green.
- Press the shutter-release button halfway to display the shutter speed and aperture.
- Focus and exposure remain locked while the shutter-release button is pressed halfway.
- When the shutter-release button is pressed halfway and the camera is unable to focus, the focus area or focus indicator blinks red. Change the composition and press the shutter-release button halfway again.

2 Press the shutter-release button the rest of the way down.



- The shutter will be released and the picture will be recorded to the memory card or internal memory.

During Recording

While pictures are being recorded, the number of exposures remaining display will blink. **Do not open the battery-chamber/memory card slot cover** while pictures are being recorded. Cutting power or removing the memory card in these circumstances could result in loss of data or in damage to the camera or card.



Autofocus

Autofocus may not perform as expected in the following situations. In some rare cases, the subject may not be in focus despite the fact that the active focus area, or focus indicator, glows green:

- Subject is very dark
- Objects of sharply differing brightness are included in the scene (e.g. the sun is behind the subject and is in deep shadow)
- No contrast between the subject and surroundings (e.g. when the subject is standing in front of a white wall, wearing a white shirt)
- Several objects are at different distances from the camera (e.g. the subject is inside a cage)
- Subject is moving rapidly

In the situations noted above, try pressing the shutter-release button halfway to refocus several times, or focus on another subject and use focus lock ( 100). When using focus lock, be sure that the distance between the camera and the subject with which focus was locked is the same as that for the actual subject.









AF-assist Illuminator and Flash

If the subject is poorly lit, the AF-assist illuminator ( 121) may light by pressing the shutter-release button halfway, or the flash ( 30) may fire by pressing the shutter-release button all the way down.

Step 4 Viewing and Deleting Pictures

Viewing Pictures (Playback Mode)

Press the  button.

- The last picture shot will be displayed in full-frame playback mode.
- Rotate the rotary multi selector, or press , ,  or , to view additional pictures (10).
- Pictures may be displayed briefly at low resolution while being read from the memory card or internal memory.
- Press the  button or the shutter-release button to return to shooting mode.
- When  is displayed, pictures stored in the internal memory will be displayed. When memory card is inserted,  is not displayed and pictures stored on the memory card will be displayed.

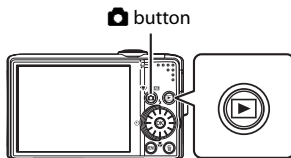



Internal memory indicator

Deleting Pictures

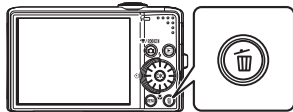
- 1 Press the  button to delete the picture currently displayed in the monitor.







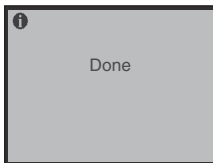
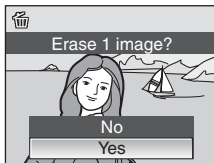





- 2 Use the rotary multi selector to choose **Yes** and press the  button.

- To exit without deleting the picture, choose **No** and press the  button.



Options Available in Playback Mode



The following options are available in full-frame playback mode.

Option	Use	Description	
Playback zoom	T 	Enlarge the view of the picture currently displayed in the monitor, up to about 10x. Press the  button to return to full-frame playback mode.	54
Thumbnail display/ Calendar display	W 	Display images by 4, 9 or 16 picture thumbnails or the calendar.	52
Display shooting information		Display the histogram and the shooting information. Press the  button to return to full-frame playback.	10
Change playback mode		Display the playback-mode selection menu, and switch to List by Date mode or Auto sort playback mode.	62, 65
Switch to shooting mode		Press the  button or the shutter-release button to change back to the last chosen shooting mode.	28
			

Pressing the Button to Turn on the Camera

When the camera is off, holding down the  button will turn the camera on in playback mode. The lens will not extend.

Viewing Pictures



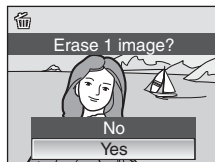

- Pictures stored in the internal memory can only be viewed if no memory card is inserted.
- Pictures that were shot using Face Priority (101) will be rotated automatically when displayed in full-frame playback mode according to the orientation of the face (excluding pictures that were shot using **Continuous**, **BSS** and **Multi-shot 16** (95)).
- If the monitor is turned off in standby mode to save power, press the power switch or the shutter-release button to reactivate it (122).

Deleting the Last Picture Taken While in Shooting Mode

In shooting mode, press the  button to delete the last picture shot.



Deleting Multiple Pictures

Choose **Delete** (107) from the Playback menu (104), List by Date menu (64) or Auto sort menu (67) to delete multiple pictures.

Using the Flash

The flash has a range of about 0.5 to 8.0 m (1 ft. 8 in. to 26 ft.) when the camera is zoomed out all the way. With maximum optical zoom applied, the range is about 0.5 to 3.5 m (1 ft. 8 in. to 11 ft.) (when **ISO sensitivity** is set to **Auto**). The following flash modes are available.

Auto

Flash fires automatically when lighting is poor.

Auto with red-eye reduction

Reduces “red-eye” in portraits (📖31).

Off

Flash will not fire even when lighting is poor.

Fill flash

Flash fires when a picture is taken. Use to “fill-in” (illuminate) shadows and backlit subjects.

Slow sync

Auto is combined with slow shutter speed.

Suitable for taking portrait images with the night landscape as the background. Flash illuminates main subject; slow shutter speeds are used to capture background at night or under dim light.



Setting the Flash Mode

1 Press (flash mode).

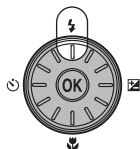
- The flash mode menu is displayed.



2 Use the rotary multi selector to choose the desired flash mode and press the button.

- The icon for the selected flash mode is displayed at the top of the monitor.
-  will disappear after a few seconds, regardless of the **Photo info** option (📖117).
- If a setting is not applied by pressing the  button within a few seconds, the selection will be cancelled.

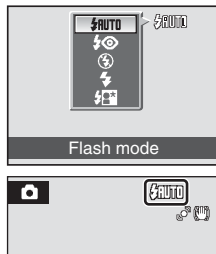

✓ Shooting When Lighting is Poor and When the Flash is Disabled (🔋)

- Use of a tripod is recommended to stabilize the camera during shooting and avoid the effects of camera shake. Set **Vibration reduction** (📖119) to **Off** when using a tripod to stabilize the camera during shooting.
- The **ISO** indicator is displayed when the camera automatically increases sensitivity. Pictures taken when **ISO** is displayed may be slightly mottled.
- When **ISO** is displayed and higher sensitivity is applied, noise reduction may be automatically applied as pictures are recorded. This will result in increased recording times.

✓ Note on Using the Flash

When using the flash, reflections from dust particles in the air may appear as bright spots in pictures. To reduce these reflections, set the flash mode to 📷 (Off).

🔧 The Flash Lamp

The flash lamp indicates the flash status when the shutter-release button is pressed halfway down.

- On 📷 : Flash will fire when picture is shot.
- Blinks 📷 : Flash is charging. Wait a few seconds and try again.
- Off 📷 : Flash will not fire when picture is shot.

If the battery is low, the monitor display will turn off, and remain off, until the flash is fully charged.

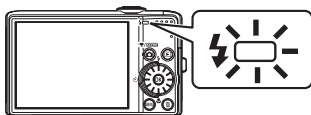

🔧 The Flash Mode Setting

The default flash mode setting varies with shooting mode.

- 📷 (auto) mode: 📷AUTO (auto)
- Scene mode: setting varies for different scene modes (📖36).
- 😊 (smile) mode: set to 📷 (off) (when Blink Proof is on),
📷AUTO (auto) (when Blink Proof is off)
- 📷 (subject tracking) mode: 📷 (off)

The flash mode setting applied in 📷 (auto) mode is stored in the camera's memory even after the camera is turned off, and reapplied the next time 📷 (auto) mode is selected.

🔧 Red-eye Reduction

This camera uses **Advanced Red-eye Reduction ("In-Camera Red-Eye Fix")**.

The flash fires repeatedly at low intensity before the main flash, reducing the red-eye effect.

The camera then analyzes the picture; if red-eye is detected, the affected area will be processed to further reduce red-eye before the picture is saved.

Note that because there is a slight lag between the shutter-release button being pressed and the picture being shot, this mode is not recommended when a quick shutter response is required. The time before the next picture can be shot also increases slightly. Advanced red-eye reduction may not produce the desired results in all situations. In extremely rare instances, areas not subject to red-eye may be affected by advanced red-eye reduction processing; in these cases, choose another mode and try again.

Taking Pictures with the Self-Timer

The camera is equipped with a ten-second and two-second timer for self-portraits. When using the self-timer, use of a tripod is recommended. Turn **Vibration reduction** (📖 119) to **Off** when using a tripod.

1 Press (self-timer).

- The self-timer menu is displayed.

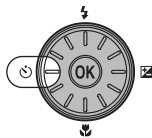

2 Use the rotary multi selector to choose **10s** or **2s** and press the button.

- 10s** (ten seconds): suited for important occasions (such as weddings)
- 2s** (two seconds): suited for preventing camera shake
- The mode selected for self-timer is displayed.
- If a setting is not applied by pressing the  button within a few seconds, the selection will be cancelled.

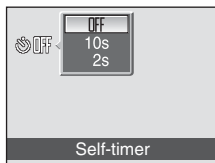

3 Frame the picture and press the shutter-release button halfway.

- Focus and exposure will be set.



4 Press the shutter-release button the rest of the way down.

- The self-timer starts, and the number of seconds remaining the shutter is released is displayed in the monitor. The self-timer lamp will blink. The lamp stops blinking one second before the picture is taken and remains lit until the shutter is released.
- When the shutter is released, the self-timer turns **OFF**.
- To stop the timer before a picture is taken, press the shutter-release button again.

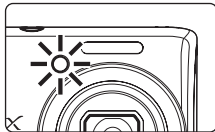
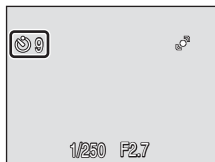

Macro Mode



Macro mode is used for taking pictures of objects as close as 2 cm (0.8 in.). Note that the flash may be unable to light entire subject at distances of less than 50 cm (1ft. 8in.).

1 Press (macro mode).

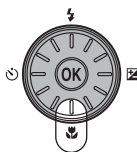
- The macro mode menu is displayed.



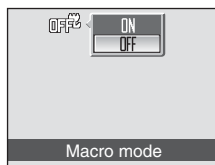

2 Use the rotary multi selector to choose **ON** and press the button.

- The macro mode icon () is displayed.
- If a setting is not applied by pressing the  button within a few seconds, the selection will be cancelled.



3 Use the zoom control and frame the picture.

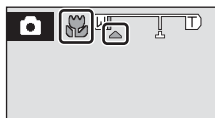

- The closest distance at which the camera can focus varies depending on the zoom position. At the zoom position (wide angle position before the  icon) where the  icon and zoom display glow green, the camera can focus on subjects as close as 3 cm (1.2 in.) from the lens. At the wide-most zoom position, the camera can focus on subjects as close as 2 cm (0.8 in.) from the lens.



Macro Mode

- If macro mode is turned **ON** in the scene modes indicated below, **Autofocus mode** ( 102) will be automatically set to **Full-time AF**.
 - **Beach/snow**
 - **Close-up** (the macro mode setting is fixed at **ON**)
 - **Food** (the macro mode setting is fixed at **ON**)
 - **Museum**
 - **Copy**
 - **Panorama assist**
- In **Full-time AF**, the camera automatically focuses continuously until focus and exposure are locked by pressing the shutter-release button halfway.

The Macro Mode Setting

The macro mode setting applied in  (auto) mode is stored in the camera's memory even after the camera is turned off, and reapplied the next time  (auto) mode is selected.

Exposure Compensation

Exposure compensation is used to alter the exposure from the value suggested by the camera to make pictures brighter or darker.

1 Press (exposure compensation).

- The exposure compensation guide and histogram are displayed.

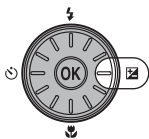

2 Use the rotary multi selector to adjust the exposure and press the button.

- When the subject is too dark: adjust the exposure compensation to "+" side.
- When the subject is too bright: adjust the exposure compensation to "-" side.
- Exposure compensation can be set to values between -2.0 and +2.0 EV.
- If a setting is not applied by pressing the  button within a few seconds, the selection will be cancelled.

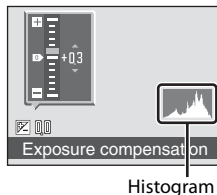



3 The setting is applied.

- The value is displayed with the  icon in the monitor.



Exposure Compensation Value

The exposure compensation value applied in  (auto) mode is stored in the camera's memory even after the camera is turned off, and reapplied the next time  (auto) mode is selected.

Using Exposure Compensation

- The camera tends to lower exposure when the frame is dominated by brightly lit objects (for example, sunlit expanses of water, sand, or snow) or when the background is much brighter than the main subject.
- Negative compensation may be called for when large areas of the frame contain very dark objects (for example, a swath of dark green leaves) or when the background is much darker than the main subject.

Using the Histogram

A histogram is a graph showing the distribution of tones in the image.

- The horizontal axis corresponds to pixel brightness, with dark tones to the left and bright tones to the right. The vertical axis shows the number of pixels.
- Increasing exposure compensation shifts tone distribution to the right, and decreasing it shifts tone distribution to the left.
- Use as a guide when using exposure compensation and shooting without the flash.

Shooting in Scene Mode

Camera settings are automatically optimized for the selected subject type. The following scene modes are available.

Scene auto selector	Portrait	Landscape	Sports
Night portrait	Party/indoor	Beach/snow	Sunset
Dusk/dawn	Night landscape	Close-up	Food
Museum	Fireworks show	Copy	Backlight
Panorama assist	Voice recording*		

* See “Voice Recordings” (71).

Setting the Scene Mode

- 1 Display the shooting-mode selection menu by pressing the button in shooting mode, and use the rotary multi selector to choose a scene icon.

- The icon for the scene mode that was chosen previously will be displayed. The default setting is (Scene auto selector).

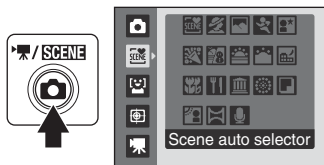

- 2 Press , choose a scene and press the button.

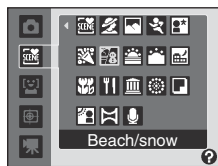

- 3 Frame the subject and take the picture.



Image Mode

Image mode (90) settings can be changed in the scene mode by pressing the **MENU** button. Changes made to the image mode setting apply to all shooting modes (except for the movie mode).

Features

Scene auto selector

By simply framing a picture, the camera automatically selects the optimum scene mode. See “Shooting in the Scene Mode Selected by the Camera (Scene Auto Selector)” (142) for more information.



- 1 The camera automatically chooses the optimum flash mode setting for the scene mode it has selected.  (Off) can be selected.
- 2 Other settings can be selected.
- 3 Changes to On when the camera selects close-up scene mode.

Portrait

NR

Use this mode for taking portraits in which the main subject stands out clearly. Portrait subjects exhibit smooth, natural-looking skin tones.

- The camera detects and focuses on a face looking toward the camera (see “Shooting with Face Priority” (101) for more information).
- If the camera detects multiple faces, the camera focuses on the face closest to the camera.
- If no face is recognized, the camera will focus on the subject in the center of the frame.
- Digital zoom is not available.



* Other settings can be selected.

Landscape

NR

Use this mode for vivid landscapes and cityscapes.





- Camera focuses at infinity. When the shutter-release button is pressed halfway, the focus area or focus indicator (6) always lights green; however, focus may not be set for near subjects, while the camera focuses at infinity.
- AF-assist illuminator does not light regardless of the AF assist (121) setting.



* Other settings can be selected.

NR: Pictures shot in scene modes utilizing **NR** are processed automatically to reduce noise and therefore take a longer time to record.

Icons Used for Descriptions

The following icons are used for descriptions in this section:  (flash mode) (30);  (self-timer) (32);  (macro mode) (33);  (exposure compensation) (34).

Sports

Use this mode for dynamic action shots that freeze the action in a single shot and record motion in a series of pictures. With continuous shooting, instantaneous movements in moving subjects can be captured clearly.

- The camera focuses continuously until focus is locked by pressing the shutter-release button halfway.
- While the shutter-release button is held down, pictures are taken at rate of up to about 1.0 frames per second (fps) when image mode is set to **Normal (4000)**. Shooting ends when the shutter-release button is released, or ten shots have been taken with the shutter-release button held down.
- The maximum frame rate with continuous shooting may vary, depending upon the current image mode and the type of memory card used.
- Motion detection (☐120) is disabled.
- AF-assist illuminator does not light, regardless of the AF assist (☐121) setting.



* Other settings can be selected.

Night portrait



Use this mode to achieve a natural balance between the main subject and background lighting in portraits taken at night.

- The camera detects and focuses on a face looking toward the camera (see "Shooting with Face Priority" (☐101) for more information).
- If the camera detects multiple faces, the camera focuses on the face closest to the camera.
- If no face is recognized, the camera will focus on the subject in the center of the frame.
- Motion detection (☐120) is disabled.
- Digital zoom is not available.



1 Slow sync with red-eye reduction. Other settings can be selected.

2 Other settings can be selected.

Party/indoor



Suitable for taking pictures in parties. Captures the effects of candlelight and other indoor background lighting.

- The camera focuses on the subject in the center of the frame.
- Hold the camera steadily as pictures are easily affected by camera shake. When shooting under low lighting, use of a tripod is recommended. Set **Vibration reduction** (☐119) to **Off** when using a tripod to stabilize the camera during shooting.

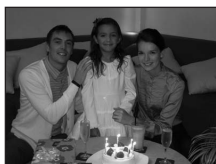

1 Fill flash with slow sync and red-eye reduction. Other settings can be selected.

2 Other settings can be selected.

: For scene modes with , use of a tripod is recommended. Turn **Vibration reduction** (☐119) to **Off** when using a tripod.

: Pictures shot in scene modes utilizing may be processed automatically to reduce noise and therefore take a longer time to record.

Shooting in Scene Mode

Beach/snow

NR

Captures the brightness of such subjects as snowfields, beaches, or sunlit expanses of water.

- The camera focuses on the subject in the center of the frame.

**AUTO***

Off*



Off*





0.0*

* Other settings can be selected.

Sunset

 **NR**

Preserves the deep hues seen in sunsets and sunrises.

- Camera focuses at infinity. When the shutter-release button is pressed halfway, the focus area or focus indicator () always lights green; however, focus may not be set for near subjects, while the camera focuses at infinity.
- AF-assist illuminator does not light regardless of the AF assist () setting.



Off*



Off





0.0*

* Other settings can be selected.

Dusk/dawn

 **NR**

Preserves the colors seen in the weak natural light before sunrise or after sunset.

- Camera focuses at infinity. When the shutter-release button is pressed halfway, the focus area or focus indicator () always lights green; however, focus may not be set for near subjects, while the camera focuses at infinity.
- AF-assist illuminator does not light regardless of the AF assist () setting.



Off*





Off



0.0*

* Other settings can be selected.

: For scene modes with , use of a tripod is recommended. Turn **Vibration reduction** () to **Off** when using a tripod.

NR: Pictures shot in scene modes utilizing **NR** may be processed automatically to reduce noise and therefore take a longer time to record.

Night landscape



Use this mode to capture night landscapes. Slow shutter speeds are used to produce stunning night landscapes.

- Camera focuses at infinity. When the shutter-release button is pressed halfway, the focus area or focus indicator (📖6) always lights green; however, focus may not be set for near subjects, while the camera focuses at infinity.
- AF-assist illuminator does not light regardless of the AF assist (📖121) setting.



			Off*		Off		0.0*
--	--	--	------	--	-----	--	------

* Other settings can be selected.

Close-up



Photograph flowers, insects and other small objects at close range.

- Macro mode (📖33) will be turned on and the camera automatically zooms to the position at the closest distance at which the camera can focus. The closest distance at which the camera can focus varies depending on the zoom position. At the zoom position (wide angle position before the 📐 icon) where the 📐 icon and zoom display glow green, the camera can focus on subjects as close as 3 cm (1.2 in.) from the lens. At the wide-most zoom position, the camera can focus on subjects as close as 2 cm (0.8 in.) from the lens.
- **AF area mode** is set to **Manual**. Press the button to choose the focus area in which focus is acquired. (📖99).
- The camera focuses continuously until focus is locked by pressing the shutter-release button halfway.
- As pictures are easily affected by camera shake, check the **Vibration reduction** (📖119) setting and hold the camera steadily.



			Off*		On		0.0*
--	--	--	------	--	----	--	------

* Other settings can be selected. Note that when shooting with the flash, the flash may be unable to light the entire subject at distances of less than 50 cm (1 ft. 8 in.)

Food



Use this mode to take pictures of food. See "Taking Pictures in Food Mode" (📖44) for more information.

- **AF area mode** is set to **Manual**. Press the button to choose the focus area in which focus is acquired (📖99).



			Off*		On		0.0*
--	--	--	------	--	----	--	------

* Other settings can be selected.

: For scene modes with , use of a tripod is recommended. Turn **Vibration reduction** (📖119) to **Off** when using a tripod.

: Pictures shot in scene modes utilizing may be processed automatically to reduce noise and therefore take a longer time to record.

Shooting in Scene Mode

Museum

Use indoors where flash photography is prohibited (for example, in museums and art galleries) or in other settings in which you do not want to use the flash.

- Camera focuses on subject in center of frame.
- BSS (Best Shot Selector) (📖95) is used when shooting.
- As pictures are easily affected by camera shake, check the **Vibration reduction** (📖119) setting and hold the camera steadily.
- AF-assist illuminator does not light regardless of the AF assist (📖121) setting.



* Other settings can be selected.

Fireworks show



Slow shutter speeds are used to capture the expanding burst of light from a firework.

- Camera focuses at infinity. When the shutter-release button is pressed halfway, the focus area or focus indicator (📖6) always lights green; however, focus may not be set for near subjects, while the camera focuses at infinity.
- Motion detection (📖120) is disabled.
- AF-assist illuminator does not light regardless of the AF assist (📖121) setting.



Copy







Provides clear pictures of text or drawings on a white board or in print.

- The camera focuses on the subject in the center of the frame.
- Use macro mode (📖33) to focus at short ranges.
- Colored text and drawings may not show up well.



* Other settings can be selected.

: For scene modes with , use of a tripod is recommended. Turn **Vibration reduction** (📖119) to **Off** when using a tripod.

: Pictures shot in scene modes utilizing  may be processed automatically to reduce noise and therefore take a longer time to record.

Backlight

Use when light is coming from behind your subject, throwing features or details in shadow. The flash fires automatically to “fill in” (illuminate) shadows.

- The camera focuses on the subject in the center of the frame.
- Motion detection ( 120) is disabled.



* Other settings can be selected.

Panorama assist



Use when taking a series of pictures that will later be joined to form a single panorama using the supplied Panorama Maker software. See “Taking Pictures for a Panorama” ( 46) for more information.





* Other settings can be selected.

Shooting in the Scene Mode Selected by the Camera (Scene Auto Selector)

By simply framing a picture, the camera automatically selects the optimum scene mode for simpler shooting. When the camera is aimed at a subject in  scene auto selector mode, the camera automatically selects one of the following scene modes.

- Auto mode (22)
- Landscape (36)
- Night landscape (39)
- Backlight (41)
- Portrait (36)
- Night portrait (37)
- Close-up (39)

- 1 Display the shooting-mode selection menu by pressing the  button in shooting mode, and use the rotary multi selector to choose  **Scene auto selector** (35).

- Scene auto selector will be enabled.



- 2 Frame the subject and take the picture.

- When the camera automatically selects a scene mode, the shooting mode icon changes to that for the scene mode currently enabled.

 : Auto mode

 : Portrait

 : Landscape

 : Night portrait

 : Night landscape

 : Close-up

 : Backlight

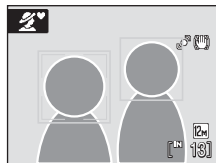

- Press the shutter-release button halfway to set focus and exposure.
- Press the shutter-release button the rest of the way down to take the picture.

✔ **Note on Scene Auto Selector Mode**

Depending upon shooting conditions, the camera may not select the desired scene mode. Should this occur, switch to auto mode (📖22) or choose the desired scene mode manually (📖35).

✎ **Flash Mode in Scene Auto Selector Mode**

📷AUTO (auto) (default setting) and 🔌 (off) flash mode settings (📖30) can be applied.



- When 📷AUTO (auto) is applied, the camera automatically chooses the optimum flash mode setting for the scene mode it has selected.
- When 🔌 (off) is applied, the flash does not fire, regardless of shooting conditions.

✎ **Functions Restricted in Scene Auto Selector Mode**

- Digital zoom is not available.
- The macro mode button on the rotary multi selector cannot be used (📖10, 33).
- The **AF area mode** setting (📖99) is set to **Auto** in 📷 (close-up) mode.



Taking Pictures in Food Mode

Use this mode to take pictures of food.

- 1 Display the shooting-mode selection menu by pressing the  button in shooting mode, and use the rotary multi selector to choose  **Food** (📖35).









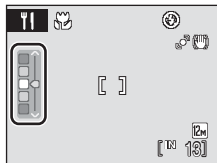

- Macro mode (📖33) will be turned on and the camera automatically zooms to the position at the closest distance at which the camera can focus.

- 2 Press the rotary multi selector  or  to choose white balance.

- Press  to increase the amount of red, or  to increase the amount of blue.



- 3 Frame the picture.

- The closest distance at which the camera can focus varies depending on the zoom position. At the zoom position (wide angle position before the  icon) where the  icon and zoom display glow green, the camera can focus on subjects as close as 3 cm (1.2 in.) from the lens. At the wide-most zoom position, the camera can focus on subjects as close as 2 cm (0.8 in.) from the lens.
- As pictures are easily affected by camera shake, check the **Vibration reduction** (📖119) setting and hold the camera steadily.
- **AF area mode** is set to **Manual** (📖99). Press the  button to move the focus area. Press the rotary multi selector , ,  or  to move the focus area to the desired position. Press the  button again to lock the selected focus area.
- Self-timer (📖32) and exposure compensation (📖34) settings can be adjusted while the focus area is locked.

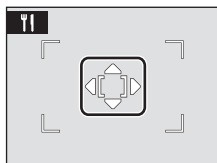
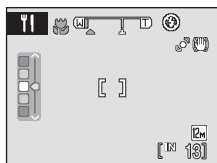

4 Press the shutter-release button to take the picture.

- Focus is locked when the shutter-release button is pressed halfway, and a picture is taken when the shutter-release button is pressed the rest of the way down.
- When the camera is unable to focus, the focus area blinks red. Change the composition and press the shutter-release button halfway again.



Note on Food Mode

Flash mode is disabled. Macro mode setting () is changed to **ON**.

White Balance Setting in Food Mode

- Increasing the amount of red or blue will decrease illumination effects.
- Changing white balance in food mode will not affect **White balance** in the shooting menu ()92).
- The white balance setting applied in food mode is stored in the camera's memory even after the camera is turned off, and reapplied the next time food mode is selected.

Taking Pictures for a Panorama

The camera focuses on the subject in the center of the frame. Use a tripod for best results.





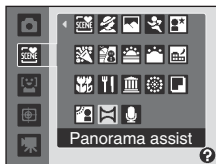



Set **Vibration reduction** (📖119) to **Off** when using a tripod to stabilize the camera during shooting.

- 1 Display the shooting-mode selection menu by pressing the  button in shooting mode, and use the rotary multi selector to choose **📷 Panorama assist** (📖35).



- The  icon is displayed to show the direction in which pictures will be joined.

- 2 Use the rotary multi selector to choose the direction and press the  button.

- Decide how pictures will be joined together in the completed panorama; right () , left () , up () or down () .
- The yellow panorama direction icon () will move to the direction pressed and press the  button to choose the direction. A white panorama direction icon () will be displayed in the chosen direction.
- Apply flash mode (📖30), self-timer (📖32), macro mode (📖33) and exposure compensation (📖34) settings with this step, if necessary.
- Press the  button again to reselect the direction.



- 3 Shoot the first picture.

- The picture taken will be displayed in 1/3 of the monitor.



4 Shoot the second picture.

- Compose the next picture so that it overlaps the first picture.
- Repeat until you have taken the necessary number of pictures to complete the image.



5 Press the **OK** button when shooting is completed.

- The camera returns to step 2.



✓ Panorama Assist

- Flash mode, self-timer, macro mode and exposure compensation settings cannot be adjusted after the first picture is taken. Pictures cannot be deleted, nor can zoom or image mode setting (📖90) be adjusted until the series is finalized.
- The panorama series is terminated if the camera enters standby mode with the auto off function (📖122) during shooting. Setting the time allowed to elapse before the auto off function is enabled to a longer time is recommended.

🔍 AE/AF-L (exposure lock) Indicator

AE/AF-L is displayed to indicate that white balance, exposure, and focus have been locked at the values set with the first shot. All pictures taken in a panorama series have the same focus, exposure, and white-balance settings.



🔍 Panorama Maker



Install Panorama Maker from the supplied Software Suite CD. Transfer pictures to a computer (📖77) and use Panorama Maker (📖80) to join them in a single panorama.

🔍 More Information

See "File and Folder Names" (📖131) for more information.

Shooting in Smile Mode

The camera detects a smiling face using face priority and releases the shutter automatically.

- 1 Display the shooting-mode selection menu by pressing the  button in shooting mode, use the rotary multi selector to choose , and then press the  button.



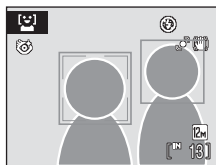

- 2 Frame the picture.

- Point the camera at the subject.
- When the camera detects a face looking toward the camera, the focus area containing the face will be displayed with a yellow double border, and when focus is locked the double border will turn green for a moment.
- Up to three faces can be detected. When more than one face is detected, the face closest to the center of the frame is framed by a double border and the others by single borders.



- 3 The shutter is automatically released.

- If the camera detects that the face framed by the double border is smiling, the shutter is automatically released.
- When the camera detects a face, the self-timer lamp () blinks. Immediately after the shutter is released with detection of a smiling face, the self-timer lamp flickers.
- When the shutter is released, automatic shooting, with which the camera detects a smiling face and releases the shutter automatically, will be performed repeatedly.
- At the default setting, blink proof is enabled (.

- 4 Exit smile mode by pressing the  button.

- Switch to another shooting mode.



Face Priority and Smiling Face Detection Features

When the camera is pointed at a face looking toward the camera in smile mode, the face is automatically recognized and that smiling face will be detected.

- Under some shooting conditions, face priority will not take effect and smiling faces cannot be detected.
- See "Shooting with Face Priority" () 101 for more information about face priority.

Notes on Blink Proof

The blink proof function can be used in smile mode. The camera takes two pictures and chooses an image in which the subjects' eyes are open.

- The message on the right will be displayed for a few seconds when the camera detects someone blinking in the picture taken.
- To turn blink proof on or off, press the **MENU** button in smile mode to display the smile mode menu and choose **Blink proof** to change the setting.
- The setting for blink proof can be previewed in the monitor (📖6).

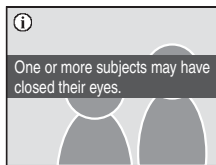

Operation of the Shutter-Release Button

Pictures can also be taken by pressing the shutter-release button.

- When a face is detected, the focus is locked to the detected face and the shutter is released.
- If no face is detected, the camera focuses on the subject in center of frame.

Functions Available in Smile Mode

- Flash mode is disabled when **Blink proof** is set to **On**. Flash mode (📖30) will be changed to **⚡AUTO** (auto) when **Blink proof** is set to **Off** (other settings can be selected).
- Exposure compensation (📖34) settings can be changed.
- Digital zoom is not available.
- Press the **MENU** button to display the menu for smile mode and change the settings for **Image mode** (📖90). Changes made to the image mode setting apply to all shooting modes (except those available from the movie mode).

Auto Off while in Smile Mode (Standby Mode)

The auto off function (📖122) will be activated and the camera will turn off if no operations are performed in any of the following situations in smile mode.



- The camera is unable to detect any face.
- The camera has detected one or more faces, but is unable to detect a smiling face.

More Information

See "Autofocus" (📖27) for more information.

Subject Tracking Mode

Use this mode to shoot moving subjects. Select a subject to be focused on. The focus area will automatically move and follow the subject.

- 1** Display the shooting-mode selection menu by pressing the  button in shooting mode, use the rotary multi selector to choose , and then press the **OK** button.



- A white border is displayed in the center of the frame.
- The flash mode (📖30) is set to  (off) (the setting can be changed).

- 2** Select a subject.

- Frame the subject in the center of the border, and press the **OK** button.
 - The subject is selected and will be framed by a yellow double border.
 - When the camera is unable to focus on the subject, the single border will glow red. Change the composition and try again.
- Once the selected subject is not visible on the monitor, the double border will disappear and the selection will be cancelled. Select the subject again.



- 3** Press the shutter-release button halfway.

- The camera focuses on the focus area framed by the double border. The double border will glow green and focus will be locked.
- When the camera is unable to focus, the double border will blink. Press the shutter-release button halfway again to focus.
- If the shutter-release button is pressed halfway while the double border is not displayed, the camera focuses on the subject at the center of the frame.

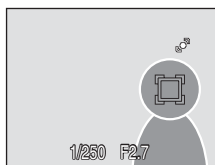

- 4** Press the shutter-release button the rest of the way down.

- The shutter will be released and the picture will be recorded to the memory card or internal memory.



✔ Subject Tracking Mode

- Adjust flash mode and exposure compensation settings before choosing the subject. If any setting is adjusted after selection of the subject, the selection of the subject will be cancelled. Deleting pictures, adjusting zoom or image mode settings (📖90) will also cancel the selection of the subject.
- In some situations, such as when the subject is moving rapidly, the camera may be unable to track the selected subject.
- In some rare cases shooting subjects with which autofocus may not perform as expected (📖27), the subject may not be in focus despite the fact that the double border glows green. Should this occur, switch to auto mode and set **AF area mode** (📖99) to **Manual** or **Center**, refocus on another subject positioned at the same distance from the camera as the actual portrait subject, and use focus lock (📖100).

📎 Usable Functions in Subject Tracking Mode

- Digital zoom is not available.
- Flash mode (📖30) and exposure compensation (📖34) settings can be adjusted.
- When the **MENU** button is pressed in subject tracking mode, the **Image mode** (📖90) and **Autofocus mode** (📖102) menus are displayed.
 - Changes made to the image mode setting apply to all shooting modes (except those available from the movie mode).
 - Changes made to the autofocus mode setting in this mode will not be applied to the autofocus mode setting in the auto shooting mode. The default autofocus mode setting in subject tracking mode is **Full-time AF**. The autofocus mode setting applied in subject tracking mode is stored in the camera's memory even after the camera is turned off.

Viewing Multiple Pictures: Thumbnail Playback

Rotate the zoom control to **W** (📐) in full-frame playback mode (📖28) to display pictures as thumbnail images in thumbnail playback mode.



The following operations can be performed in thumbnail playback.

To	Use	Description	📖
Choose pictures		Rotate the rotary multi selector, or press ▲, ▼, ◀ or ▶ to choose pictures.	10
Increase the number of thumbnails displayed/Calendar display	W (📐)	Rotate the zoom control towards the W (📐) direction to increase the number of thumbnails from 4 → 9 → 16 → Calendar display. In Calendar display, move and choose the image according to the date (📖53). Rotate towards the T (📏) direction to return to thumbnail display.	-
Decrease number of picture thumbnails displayed	T (📏)	Rotate the zoom control towards the T (📏) direction to decrease the number of thumbnails from 16 → 9 → 4. Rotate towards T (📏) again during 4 thumbnails display to return to full frame playback.	-
Return to full-frame playback		Press the button.	28
Switch to shooting mode	 	Press the button or the shutter-release button to return to the last shooting mode selected.	28

✎ Icons on the Thumbnails

When print set (📖87) and protected pictures (📖107) are selected in thumbnail playback mode, the icons shown at the right are displayed with them.

Movies are displayed as film frames.

Print-set icon

Protect icon

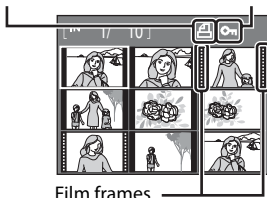

✎ Thumbnail Display in Auto Sort

When thumbnails are displayed in the auto sort mode (📖65), the icon representing the type of the pictures being played back will appear at the top right corner of the screen.

Calendar Display

Rotate the zoom control towards **W** (🗘) during playback mode when 16 thumbnails are displayed (📖52) to change to Calendar display.

Move the cursor and choose the image according to the date. Dates will be underlined in yellow if there are pictures taken on that date.

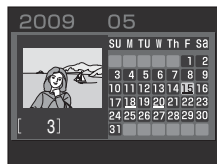

The following operations can be performed while the Calendar is displayed.

To	Use	Description	📖
Select date		Rotate the rotary multi selector, or press ▲ , ▼ , ◀ or ▶ to select a date.	10
Return to full-frame playback		Changes to the full-frame playback for the first photo taken for the chosen date.	28
Return to thumbnail display	T (🗘)	Rotate the zoom control to T (🗘).	-

✔ Notes on Calendar Display

- Images taken without the date set will be treated as images taken on "01.01.09".
- **MENU** and buttons are disabled while the Calendar is displayed.

🗘 Note on List by Date Mode

Use list by date mode (📖62) to playback images of the same date.

Playback menu (📖64) operations can also be performed for the images of the chosen date.

Taking a Closer Look: Playback Zoom

Rotating the zoom control to **T** (🔍) during full-frame playback mode (📖28) zooms in on the current picture, enlarging and displaying the center of the picture on the monitor.

- The guide at lower right shows which portion of the picture is enlarged.



The following operations can be performed while pictures are zoomed in.

To	Use	Description	📖
Zoom in	T (🔍)	Zoom increases each time the zoom control is rotated to T (🔍), up to about 10x.	-
Zoom out	W (📐)	Rotate the zoom control to W (📐). When the magnification ratio reaches 1x, the display returns to full-frame playback mode.	-
Move the display area		Press the rotary multi selector ▲, ▼, ◀ or ▶ to move the display area to other areas of the picture.	10
Return to full-frame playback		Press the button.	28
Crop picture	MENU	Press to crop the current picture to contain only the portion visible in the monitor.	58
Switch to shooting mode	 	Press the button or the shutter-release button to return to the last shooting mode selected.	28

Pictures Taken Using the Face-Priority Function

When zooming in (playback zoom) on a picture taken using the face-priority function (📖101), the picture will be enlarged with the face detected with shooting at the center of the monitor (excluding pictures that were shot using **Continuous**, **BSS** and **Multi-shot 16** (📖95)).

- If more than one face was detected, the picture will be enlarged with the face on which focus was acquired at the center of the monitor. Press the rotary multi selector ▲, ▼, ◀, or ▶ to display other faces that were detected.
- When rotating the zoom control towards the **T** (🔍) or **W** (📐) direction to adjust the zoom ratio, the center of the picture (normal playback zoom display), rather than the face, is displayed at the center of the monitor.

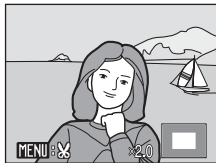

Editing Pictures

Use this camera to edit pictures in-camera and store them as separate files (📖131).

Editing function	Description
Quick retouch (📖56)	Easily create a copy with enhanced contrast and richer colors.
D-Lighting (📖57)	Create a copy of the current picture with enhanced brightness and contrast, brightening dark portions of the picture.
Crop (📖58)	Crop picture. Enlarge the image or refine the composition and create a copy containing only the portion visible in the monitor.
Small picture (📖59)	Create a small copy of pictures suitable for use on web pages or as e-mail attachments.

Notes on Picture Editing

- Pictures taken at an **Image mode** (📖90) setting of **16:9 (1920)** cannot be edited.
- This camera's editing functions cannot be used for pictures taken with another make or model of camera.
- If a copy created using this camera is viewed on another make or model of camera, the picture may not be displayed or may not be transferred to a computer.
- Editing functions are not available when there is not enough free space in the internal memory or on the memory card.

Restrictions on Picture Editing

1st editing	2nd editing			
	Quick retouch	D-Lighting	Crop	Small picture
Quick retouch	–	–	✓	✓
D-Lighting	–	–	✓	✓
Crop	–	–	–	–
Small picture	–	–	–	–

- Pictures cannot be edited twice with the same editing function.
- Quick retouch or D-Lighting should be done first while the restricted use of combination exists.

Original Pictures and Edited Copies

- Copies created with editing functions are not deleted if the original pictures are deleted. The original pictures are not deleted if copies created with editing functions are deleted.
- Edited copies are stored with the same recording date and time as the original.
- Even if the pictures that are marked for **Print set** (📖87) or **Protect** (📖107) are used for editing, these settings will not be reflected on the edited copies.

Using Quick Retouch

Easily create retouched images in which contrast and saturation have been enhanced. Retouched copies are stored as separate files.

- 1 Choose the desired picture from full-frame (📖28) or thumbnail (📖52) playback mode and press the **MENU** button.

- The playback menu is displayed.

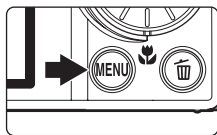

- 2 Use the rotary multi selector to choose **Quick retouch** and press the **OK** button.

- The original version will be shown on the left and the edited version will be shown on the right.

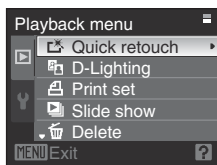

- 3 Choose the extent of the setting using **▲** or **▼** of the rotary multi selector, and press the **OK** button.

- A new edited copy is created.
- To cancel Quick retouch, press the **MENU** button.
- Quick retouched copies can be recognized by the  icon displayed during playback.



More Information

See "File and Folder Names" (📖131) for more information.

Enhancing Brightness and Contrast: D-Lighting

D-Lighting can be used to create copies with enhanced brightness and contrast, brightening dark portions of a picture. Enhanced copies are stored as separate files.

- 1 Choose the desired picture from full-frame (📖28) or thumbnail (📖52) playback mode and press the **MENU** button.

- The playback menu is displayed.

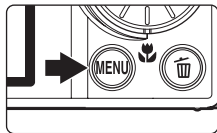

- 2 Use the rotary multi selector to choose **D-Lighting** and press the **OK** button.

- The original version will be shown on the left and the edited version will be shown on the right.

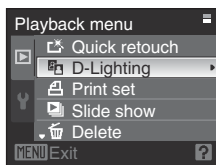

- 3 Choose **OK** and press the **OK** button.

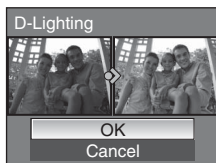

- A new copy with enhanced brightness and contrast is created.
- To cancel D-Lighting, choose **Cancel** and press the **OK** button.
- D-Lighting copies can be recognized by the **D-L** icon displayed during playback.



More Information

See "File and Folder Names" (📖131) for more information.

Creating a Cropped Copy: Crop





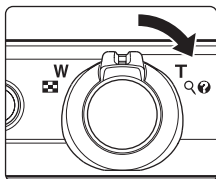

Create a copy containing only the portion visible in the monitor when **MENU**  is displayed with playback zoom (54) enabled. Cropped copies are stored as separate files.

1 Enlarge the desired picture during full-frame display (28) by rotating the zoom control to the **T** () direction.

- To crop a picture displayed in “tall” (portrait) orientation, zoom in on the picture until the black bars displayed on the both sides of the monitor disappear. The cropped picture will be displayed in landscape orientation. To crop the picture in its current “tall” (portrait) orientation, first, use the **Rotate image** option (108) to rotate the picture so that it is displayed in landscape orientation. Next, enlarge the picture for cropping, crop the picture, and then rotate the cropped picture back to “tall” (portrait) orientation.



2 Refine copy composition.

- Rotate the zoom control to **T** () or **W** () to adjust the zoom ratio.
- Press the rotary multi selector , , , or  to scroll the picture until only the portion you want to copy is visible in the monitor.



3 Press the **MENU** button.

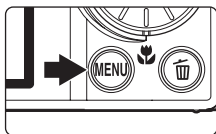



4 Use the rotary multi selector to choose **Yes** and press the **OK** button.

- A new picture, containing only the portion visible in the monitor, is created.
- To cancel creating a cropped copy, choose **No** and press the **OK** button.



Image Size



As the area to be saved is reduced, the image size (pixels) of the cropped copy is also reduced. When the size of the cropped copy is 320 × 240 or 160 × 120, the small picture icon  or  is displayed on the left of the screen in full-frame playback mode.

More Information

See “File and Folder Names” (131) for more information.

Resizing Pictures: Small Picture

Create a small copy of the current picture. Small copies are stored as JPEG files with a compression ratio of 1:16. The following sizes are available.

Option	Description
 640×480	Suitable for television playback.
 320×240	Suitable for displaying on web pages.
 160×120	Suitable for e-mail attachments.

- 1 Choose the desired picture from full-frame () or thumbnail () playback mode and press the **MENU** button.

- The playback menu is displayed.

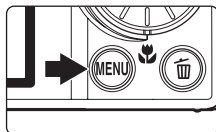

- 2 Use the rotary multi selector to choose  **Small picture** and press the **OK** button.

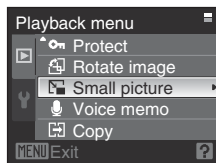

- 3 Choose the desired copy size and press the **OK** button.



- 4 Choose **Yes** and press the **OK** button.

- A new, smaller copy is created.
- To cancel creating a small copy, choose **No** and press the **OK** button.

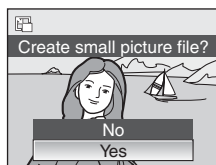

More Information

See "File and Folder Names" ( 131) for more information.

Voice Memos: Recording and Playback

Use the camera's built-in microphone to record voice memos for pictures.

Recording Voice Memos

- 1 Choose the desired picture from full-frame playback (📖28) and press the **MENU** button.

- The playback menu is displayed.

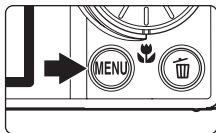

- 2 Use the rotary multi selector to choose **Voice memo** and press the **OK** button.

- The screen for recording a voice memo will be displayed.

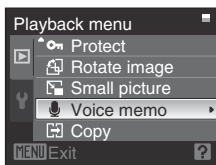

- 3 Press and hold the **OK** button to record voice memo.

- Recording ends after 20 seconds or when the **OK** button is released.
- Do not touch the built-in microphone during recording.
- During recording, **REC** and **[M]** blink in the monitor.
- When recording ends, the voice memo playback screen is displayed. Follow step 3 of "Playing Voice Memos" (📖61) to playback the voice memo.
- Press the **MENU** button before or after recording a voice memo to return to full-frame playback.

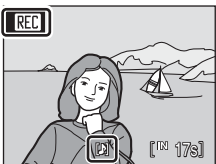

More Information

See "File and Folder Names" (📖131) for more information.

Playing Voice Memos

Pictures for which voice memos have been recorded are indicated with  in full-frame playback mode.

- 1 Choose the desired picture from full-frame () and press the **MENU** button.

- The playback menu is displayed.

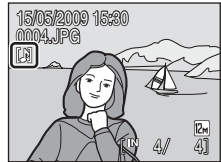

- 2 Use the rotary multi selector to choose  **Voice memo** and press the **OK** button.

- The screen for playing a voice memo will be displayed.

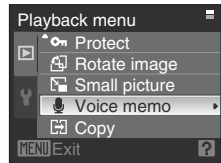



- 3 Press the **OK** button to play voice memo.

- Playback ends when the voice memo ends or the **OK** button is pressed again.
- Rotate the zoom control **T** or **W** during playback to adjust the volume.
- Press the **MENU** button before or after playing a voice memo to return to full-frame playback.



Deleting Voice Memos

Choose a picture with a voice memo and press the  button. Use the rotary multi selector to choose  and press the **OK** button. Only the voice memo will be deleted.

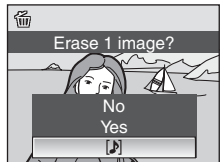

Notes on Voice Memos

- When a picture with a voice memo attached is deleted, both the picture and its voice memo are deleted.
- Voice memos cannot be recorded for a picture that already has a voice memo attached on it. The current voice memo must be deleted before a new voice memo can be recorded.
- Voice memos cannot be attached to images shot using other cameras.

Viewing Pictures by Date (List by Date Mode)

In the **DATE** list by date mode, you can playback only the images taken on the same date.

In full-frame playback mode, just as with playback mode, picture display can be enlarged, pictures can be edited, voice memos can be recorded or played back, and movies can be played back. When the **MENU** button is pressed, the list by date menu is displayed, and all pictures taken on a specified date can be selected for deletion, printing, and protection.

Selecting a Date in List by Date Mode

- 1 Display the playback-mode selection menu by pressing the  button in playback mode, use the rotary multi selector to select **DATE** and then press the **OK** button.

- Dates for which pictures exist will be listed.



- 2 Choose the desired date and press the **OK** button.

- Camera lists up to 29 dates. If pictures exist for more than 29 dates, all pictures recorded earlier than most recent 29 dates will be listed together as **Others**.
- The first picture for that date will be displayed in full-frame playback.
- Rotate the zoom control to **W** () in full-frame playback mode to return to the List by date screen.

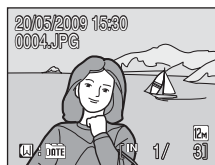
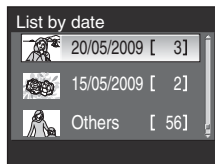













Notes on List by Date Mode

- Only the most recent 9,000 pictures can be displayed in list by date mode.
- Images taken without the date set will be treated as images taken on "01.01.09".









Using List by Date Mode

The following operations are possible from the list by date screen.

To	Use	Description	
Select date		Rotate the rotary multi selector, or press ▲ or ▼ to select a date.	10
Switch to full-frame playback		Press the  button to display the first picture taken on the selected date. Rotate the zoom control to W  in full-frame playback to return to the date selection screen.	29
Delete pictures		Press the  button after selecting a date, and a confirmation dialog will be displayed. Choose Yes and press the  button to delete all pictures taken on the selected date.	28
View list by date menu	MENU	Press the MENU button to display the list by date menu.	64
Change playback mode		Press the  button to display the playback-mode selection menu.	9
Switch to shooting mode		Press the  button or the shutter-release button to return to the last shooting mode selected.	28
			

List by Date Menu

Press the **MENU** button in list by date mode to display the following menus for only the pictures taken on the specified date.

Quick retouch*	 56
D-Lighting*	 57
Print set	 87
Slide show	 106
Delete	 107
Protect	 107
Rotate image*	 108
Small picture*	 59
Voice memo*	 60

* During full-frame playback only

When the **MENU** button is pressed in the list by date screen ( 62), options can be applied to all pictures taken on the same date, or all pictures taken on the same date can be deleted.

To apply options to individual pictures, or to select individual pictures for deletion, display a picture full-frame and press the **MENU** button.

Note on Print set





When print marking already exists for pictures taken on dates other than that specified, a confirmation dialog **Save print marking for other dates?** will be displayed. Choose **Yes** to add the new print marking to the existing marking. Choose **No** to remove the existing print marking and leave only the new marking.

If the amount of pictures exceed 99 due to the new print markings added, the **Too many images selected. Remove print marking for other dates?** confirmation dialog will be displayed. Choose **Yes** to remove the existing print marking and leave only the new marking.

Image Searching (Auto Sort Mode)



Pictures and movies will automatically be sorted in any of the following folder names after shooting them.

If the  auto sort mode is selected, you can display the pictures and movies by selecting the folder name sorted in shooting.

 Smile	 Portraits	 Food
 Landscape	 Dusk to dawn	 Close-ups
 Movie	 Retouched copies	 Other scenes

In full-frame playback mode, just as with the normal playback mode, picture displays can be enlarged, the thumbnail/calendar playback can be done, pictures can be edited, and voice memos can be recorded. Also, all images sorted in the same folder can be deleted at the same time and print set and protect can be set at the same time.

Displaying Pictures in the Auto Sort Mode

- 1 Display the playback-mode selection menu by pressing the  button in playback mode, use the rotary multi selector to select , and then press the  button.



- The auto sort folder list screen appears.
See “Types of Folders and their Content” (□□66) for more information about the sort folders.
- The pictures in the folder are displayed.



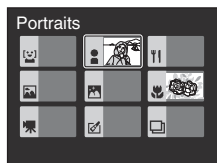



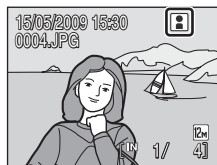



- 2 Choose a folder and press the  button.



- Pictures in the selected folder will be displayed in full-frame playback.
- The icon of the folder being played back currently will be displayed in the top right of the screen.



Types of Folders and their Content

Categories	Description
 Smile	Pictures taken in the smile mode (📖48) are displayed.
 Portraits	Pictures taken with face priority (📖101) of the  (auto) mode (📖22) or with Portrait* , Night portrait* , Party/indoor or Backlight* of scene mode (📖35) are displayed.
 Landscape	Pictures taken using the scene mode Landscape* are displayed.
 Dusk to dawn	Pictures taken using the scene modes Night landscape* , Sunset , Dusk/dawn and Fireworks show are displayed.
 Close-ups	Pictures taken using the scene mode Close-up* or with the macro (📖33) of the  (auto) mode are displayed.
 Food	Pictures taken using the scene mode Food (📖44) are displayed.
 Movie	Movies recorded using the movie mode (📖68) are displayed.
 Retouched copies	Pictures created using Quick retouch (📖56), D-Lighting (📖57), Crop (📖58) or Small picture (📖59) are displayed.
 Other scenes	All pictures that are not included in the other folders are displayed.











* The pictures taken using the **Scene auto selector** (📖36) are included.

Notes when using the Auto Sort Mode

- Up to 999 images can be added per folder in the auto sort mode. A newly shot picture/movie whose folder already contains 999 images cannot be registered nor displayed in the auto sort mode. Display the picture/movie using the normal playback mode (📖28) or the list by date mode (📖62).
- Pictures or movies copied from the internal memory or the memory card (📖68) cannot be displayed in the auto sort mode.
- Pictures or movies recorded by a camera other than this camera cannot be displayed in the auto sort mode.









Auto Sort Mode

The following operations are possible from the auto sort folder list screen.

To	Use	Description	
Select the folder		Rotate the rotary multi selector, or press ▲ , ▼ , ◀ or ▶ to select the folder.	10
Switch to full-frame playback		Press the OK button to display the first picture in the selected folder.	29
Deleting pictures		Press the  button after selecting pictures from the folder, and a confirmation dialog will be displayed. Choose Yes and press the OK button to delete all pictures from the folder.	28
Change playback mode		Press the  button to display the playback-mode selection menu.	9
Switch to shooting mode	 	Press the  button or the shutter-release button to return to the last shooting mode selected.	28

Auto Sort Menu

Display the menu below by pressing the **MENU** button in the full-frame playback of auto sort mode.

Quick retouch	 56	Protect	 107
D-Lighting	 57	Rotate image	 108
Print set	 87	Small picture	 59
Slide show	 106	Voice memo	 60
Delete	 107		

Note on Print set



When print marking already exists for pictures in categories other than the type specified, a confirmation dialog **Save print marking for other images?** will be displayed. Choose **Yes** to add the new print marking to the existing marking. Choose **No** to remove the existing print marking and leave only the new marking.

If the amount of pictures exceed 99 due to the new print markings added, the **Too many images selected. Remove print marking from other images?** confirmation dialog will be displayed.

Choose **Yes** to remove the existing print marking and leave only the new marking.

Recording Movies

To shoot movies with sound recorded via the built-in microphone, select shooting mode and follow the steps below.

- 1** Display the shooting-mode selection menu by pressing the  button in shooting mode, use the rotary multi selector to select , and then press the **OK** button.

- Exposure count display shows the maximum total length of movie that can be recorded.



- 2** Press the shutter-release button all the way down to start recording.

- Camera focuses on the subject in center of the frame.
- A progress bar at the bottom of the monitor shows the amount of recording time remaining.
- To end recording, press the shutter-release button all the way down again.
- Recording stops automatically when the internal memory or memory card becomes full, or recording time reaches 25 minutes.

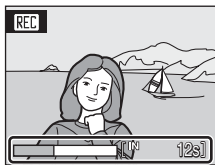

Shooting Movies

- Macro mode ([□□33](#)) is enabled. Flash mode ([□□30](#)), self-timer ([□□32](#)), and exposure compensation ([□□34](#)) are disabled.
- Macro mode settings cannot be applied or changed while movies are being recorded. Apply or change settings as necessary before movie recording begins.
- Optical zoom cannot be adjusted once movie recording begins. Digital zoom cannot be applied before movie recording begins, but up to 2x digital zoom can be applied while movies are being recorded.

Note on Recording Movies

When the movie has been fully recorded to the internal memory or memory card, the monitor display will revert to the normal shooting mode display. **Do not open the battery-chamber/memory card slot cover while movies are being recorded.** Turning the camera off or removing the memory card while movies are being recorded could result in loss of data or in damage to the camera or card.

Changing Movie Settings

Movie options and **Autofocus mode** settings can be changed in the movie menu ([□□69](#)).



The Movie Menu

Movie options and **Autofocus mode** (📖69) settings can be changed in the movie menu. Press the **MENU** button in movie mode to display the movie menu and use the rotary multi selector to modify and apply settings.



🔊 Selecting Movie Options

Set to 🔊 (Movie) → MENU (Movie menu) → 🔊 Movie options

The movie menu offers the options shown below.

Option	Image size and frame rate
 TV movie 640 (default setting)	Image size: 640 × 480 pixels Frame rate: 30 frames per second
 Small size 320	Image size: 320 × 240 pixels Frame rate: 30 frames per second

📝 Maximum Movie Length

Option	Internal memory (approx. 45 MB)	Memory card (512 MB)
 TV movie 640 (default setting)	32 s	Approx. 5 min 30 s
 Small size 320	1 min 22 s	Approx. 14 min 20 s

* All figures are approximate. The maximum recording time may vary with make of memory card. This camera can record movies up to a maximum of 25 minutes in length. Regardless of the remaining memory on the memory card, the movie length remaining displayed on the screen will be 25 minutes.



🔍 More Information

See "File and Folder Names" (📖131) for more information.

🎥 Autofocus Mode

Set to 🔊 (Movie) → MENU (Movie menu) → 🎥 Autofocus mode

Choose how the camera focuses in movie mode.

Option	Description
 Single AF (default setting)	Camera focuses when shutter-release button is pressed halfway and locks at this position during shooting. Focus will be locked at that position during shooting.
 Full-time AF	Camera focuses continuously until focus is acquired and locked. To prevent sound of camera focusing from interfering with recording, use of Single AF is recommended.

Movie Playback

In full-frame playback mode (📖28), movies are recognized by the movie mode icons. To play a movie, display it in full-frame playback mode and press the **OK** button.

Use the zoom control **T** or **W** during playback to adjust the volume.

Rotate the rotary multi selector to advance or rewind the voice recording.

Playback controls appear at the top of the monitor. Press the rotary multi selector ◀ or ▶ to choose a control, then press the **OK** button to perform the selected operation. The following operations are available.

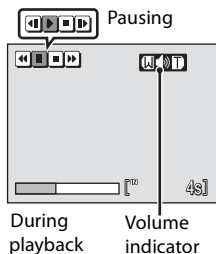

To	Select	Description						
Rewind	◀	Rewind the movie when the OK button is pressed down.						
Advance	▶	Advance the movie when the OK button is pressed down.						
Pause	⏸	Press the OK button to pause playback. The following operations can be performed while playback is paused.						
		<table border="1"> <tr> <td>◀</td> <td>Press the OK button to rewind the movie by one frame. Rewind continues while the button is pressed. *</td> </tr> <tr> <td>▶</td> <td>Press the OK button to advance the movie by one frame. Advance continues while the button is pressed. *</td> </tr> <tr> <td>▶</td> <td>Press the OK button to resume playback.</td> </tr> </table>	◀	Press the OK button to rewind the movie by one frame. Rewind continues while the button is pressed. *	▶	Press the OK button to advance the movie by one frame. Advance continues while the button is pressed. *	▶	Press the OK button to resume playback.
		◀	Press the OK button to rewind the movie by one frame. Rewind continues while the button is pressed. *					
▶	Press the OK button to advance the movie by one frame. Advance continues while the button is pressed. *							
▶	Press the OK button to resume playback.							
End	⏹	Press the OK button to return to full-frame playback mode.						

* The rotary multi selector can also be rotated to advance or rewind the movie frame by frame.

Deleting Movie Files

Press the **🗑** button when displayed in full-frame playback mode (📖28) or when selected in thumbnail (📖52) playback mode.

A confirmation dialog is displayed. Select **Yes** and press the **OK** button to delete the movie, or select **No** to exit without deleting the movie.

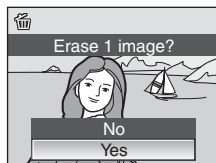

Making Voice Recordings

Audio voice recordings can be recorded over the built-in microphone and played back over the built-in speaker.

- 1 Display the shooting-mode selection menu by pressing the  button in shooting mode, and use the rotary multi selector to choose a scene icon.





- The icon for the scene mode that was chosen previously will be displayed. The default setting is  (Scene auto selector).

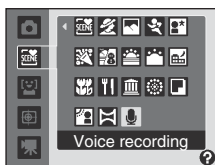

- 2 Press , choose  **Voice recording** and press the  button.





- The length of recording that can be made will be displayed.

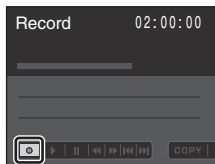

- 3 Press  or  to choose  on the operation panel, and press the  button to start recording.

- The indicator lamp lights during recording.
- If no operations are performed for about 30 seconds after voice recording begins, the camera's power saving function is enabled and the monitor turns off. Press any button to light up the monitor.
- See "Operations During Recording" ( 72) for more information.



- 4 Press  or  to choose  on the operation panel, and press the  button to stop recording.

- Recording will end automatically if the internal memory or memory card becomes full, or after 120 minutes of recording on the memory card.

More Information

See "File and Folder Names" ( 131) for more information.

Operations During Recording



To	Press	Description
Move the cursor on the operation panel		Press ◀ or ▶ on the rotary multi selector. ■ : Press the OK button to end recording. : Press the OK button to pause recording. Choose ◉ and press the OK button to resume recording while recording is paused.
Create index*		Press ▲ or ▼ on the rotary multi selector. Indexes make it easy to locate desired portions of a recording. Start of recording is index number 01; other numbers that follow are assigned in ascending order each time the rotary multi selector is pressed, up to index number 98.

* The copied files can be played back using QuickTime or any other WAV-compatible audio player. Note that index points created with the camera cannot be used when voice recordings are played back on computers.

Playing Voice Recordings

- 1 Display the shooting-mode selection menu by pressing the  button in shooting mode, and use the rotary multi selector to choose a scene icon.



- The icon for the scene mode that was chosen previously will be displayed. The default setting is  (Scene auto selector).







- 2 Press , choose  **Voice recording** and press the  button.

- The screen switches to the voice recording screen.

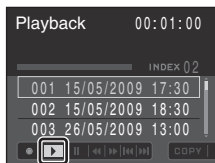

- 3 Press  or  on the rotary multi selector to choose .



- 4 Press  or  to choose the desired sound file and press the  button.

- The selected sound file will be played back.
- See "Operations During Playback" ( 74) for more information.

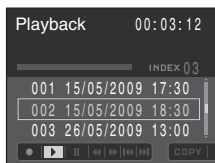

Operations During Playback

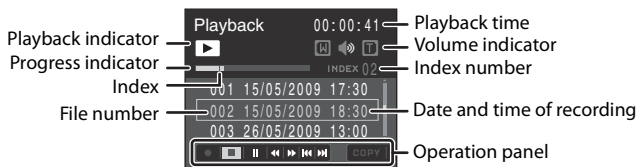

Use the zoom control **T/W** to adjust playback volume. Rotate the rotary multi selector to advance or rewind the voice recording.

Press the rotary multi selector ◀ or ▶ to choose a control, then press the **OK** button to perform the selected operation. The following operations are available.

To	Press	Description
Rewind	◀◀	Rewind the voice recording when the OK button is pressed down.
Advance	▶▶	Advance the voice recording when the OK button is pressed down.
Skip to previous index	◀◀	Press the OK button to skip to the previous index.
Skip to next index	▶▶	Press the OK button to skip to the next index.
Pause	⏸	Press the OK button to pause playback. Press the OK button to resume playback while playback is paused.
End	■	Press the OK button to end playback.

Deleting Sound Files

Press the **🗑** button during playback, or choose a sound file in the voice recording screen, and press the **🗑** button to display the confirmation dialog. To delete the file, choose **Yes** and press the **OK** button. To cancel deletion, choose **No**.

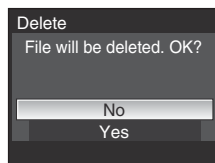

Copying Voice Recordings

Copy voice recordings between the internal memory and a memory card. This option is available only when a memory card is inserted.

- 1 Press ◀ or ▶ on the rotary multi selector in the voice recording screen (step 3 of 73), choose **COPY** and press the **OK** button.

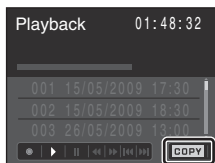

- 2 Choose a copy option and press the **OK** button.

- : Copy recordings from internal memory to memory card.
- : Copy recordings from memory card to internal memory.

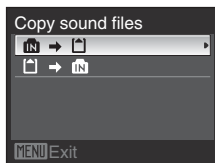

- 3 Choose a copy option and press the **OK** button.

- **Selected files**: proceed to step 4
- **Copy all files**: proceed to step 5

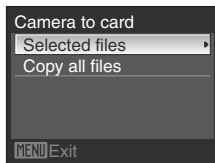

- 4 Choose the data to be copied.

- Press the rotary multi selector ▶ to select the file (✓). Press the rotary multi selector ▶ again to cancel the selection.
- Multiple files can be selected.
- Press the **OK** button when setting is complete.

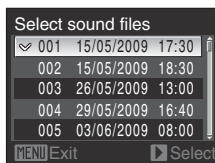

- 5 When a confirmation dialog is displayed, choose **Yes** and press the **OK** button.

- Copying starts.

Note on Copying Sound Files

This camera may be unable to play or copy sound files created with other cameras.

Connecting to a TV

Connect the camera to a television using the supplied audio/video cable to play back pictures on the television.

1 Turn off the camera.

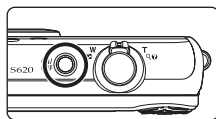

2 Connect the camera to the TV using the supplied audio/video cable.

- Connect the yellow plug to the video-in jack on the TV, and the white plug to the audio-in jack.

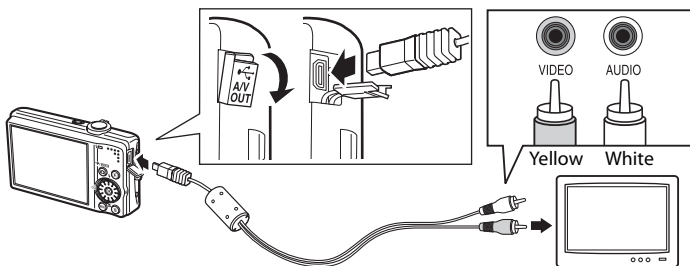

3 Tune the television to the video channel.

- See the documentation provided with your television for details.

4 Hold down the button to turn on the camera.

- The camera enters playback mode, and pictures recorded to the internal memory, or memory card, will be displayed on the television.
- While connected to the TV, the camera monitor will remain off.

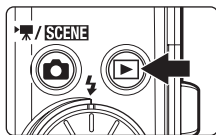

Connecting the Audio/Video Cable

When connecting the audio/video cable, be sure that the connectors are oriented correctly. Do not use force when connecting the audio/video cable. When disconnecting the audio/video cable, do not pull the connector at an angle.

When Nothing Appears on the TV

Be sure that the camera's video mode setting in the setup menu (📖110) → **Video mode** (📖124) conforms to the standard used by your television.

Connecting to a Computer

Use the supplied USB cable to connect the camera to a computer, and copy (transfer) pictures to a computer with the supplied Nikon Transfer software.

Before Connecting the Camera

Installing the Software

Before connecting the camera to a computer, software, including Nikon Transfer, and Panorama Maker for creating panorama photos, must be installed from the supplied Software Suite CD. For more information on installing the software, refer to the *Quick Start Guide*.

Compatible Operating Systems

Windows

Preinstalled versions of 32-bit Windows Vista Home Basic/Home Premium/Business/Enterprise/Ultimate editions (Service Pack 1), Windows XP Home Edition/Professional (Service Pack 3)

Macintosh

Mac OS X (version 10.3.9, 10.4.11, 10.5.5)

Refer to the Nikon website for the latest information on operating system compatibility.

Notes on Power Source

- When connecting the camera to a computer or printer, use a fully charged battery to prevent the camera from turning off unexpectedly.
- Use the optional AC Adapter EH-62F to charge this camera using home electronic outlets. Do not, under any circumstances, use another make or model of AC adapter. Failure to observe this precaution could result in overheating or in damage to the camera.

Transferring Pictures from the Camera to a Computer

- 1 Start the computer to which Nikon Transfer was installed.
- 2 Turn off the camera.
- 3 Connect the camera to the computer using the supplied USB cable.

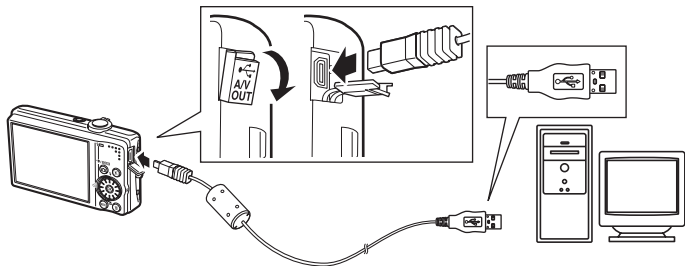

- 4 Turn on the camera.

- The power-on lamp will light.

- **Windows Vista:**

When the **AutoPlay** dialog is displayed, click **Copy pictures to a folder on my computer using Nikon Transfer**. Nikon Transfer will start. To bypass this dialog in the future, check **Always do this for this device**:

- **Windows XP:**

When the action selection dialog is displayed, click **Nikon Transfer Copy pictures to a folder on my computer**, and click **OK**. Nikon Transfer will start. To bypass this dialog in the future, check **Always use this program for this action**.

- **Mac OS X:**

Nikon Transfer will start automatically if **Yes** was selected in the **Auto-Launch setting** dialog when Nikon Transfer was first installed.

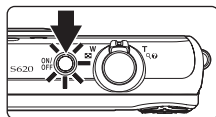

Connecting the USB Cable

- When connecting the USB cable, be sure that the connectors are oriented correctly. Do not use force when connecting the USB cable. When disconnecting the USB cable, do not pull the connector at an angle.
- Connection may not be recognized when the camera is connected to a computer via a USB hub.

5 Transfer pictures when Nikon Transfer has finished loading.

- Click the **Start Transfer** button in Nikon Transfer. All pictures will be transferred to the computer (at the Nikon Transfer default setting).

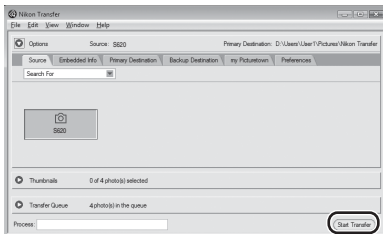

Start Transfer button

- The folder to which pictures are transferred to is automatically opened when transfer is complete (at the Nikon Transfer default setting).
- If ViewNX has been installed, ViewNX will start automatically and you can view the pictures transferred.
- For more information on using Nikon Transfer or ViewNX, refer to the help information contained in Nikon Transfer or ViewNX.

6 Disconnect the camera when transfer is complete.

- Turn the camera off and disconnect the USB cable.

Using a Card Reader

Pictures stored on a memory card that is inserted into a card reader or similar device can also be transferred to the computer using Nikon Transfer.

- If the memory card has a capacity greater than 2 GB, or is SDHC-compliant, the intended device must support these features of the memory card.
- Nikon Transfer will start automatically when a memory card is inserted into the card reader or similar device. (default setting of Nikon Transfer) See step 5 of “Transferring Pictures from the Camera to a Computer” (📖79).
- To transfer pictures stored in the camera’s internal memory to the computer, the pictures must first be copied to a memory card using the camera (📖75, 109).

Using the Computer to Open Image/sound Files

- Navigate to the folder to which pictures were saved and open a picture in the viewer supplied with your operating system.
- Sound files can be played back using QuickTime or any other WAV compatible audio player.

Panorama Creation with Panorama Maker

- Use a series of pictures taken using the **Panorama assist** option in scene mode (📖46) to create a single panorama photo with Panorama Maker.
- Panorama Maker can be installed to a computer using the supplied Software Suite CD.
- After installation is complete, follow the procedure described below to start Panorama Maker.

Windows:

From the **Start** menu, open **All Programs** → **ArcSoft Panorama Maker 4** → **Panorama Maker 4**.

Macintosh:

Open Applications by selecting **Applications** from the Go menu, and double-click the **Panorama Maker 4** icon.

- For more information on using Panorama Maker, refer to the on-screen instructions and help information contained in Panorama Maker.

More Information

See “File and Folder Names” (📖131) for more information.

Connecting to a Printer

Users of PictBridge-compatible (📖148) printers can connect the camera directly to the printer and print pictures without using a computer. The steps for printing are as follows.

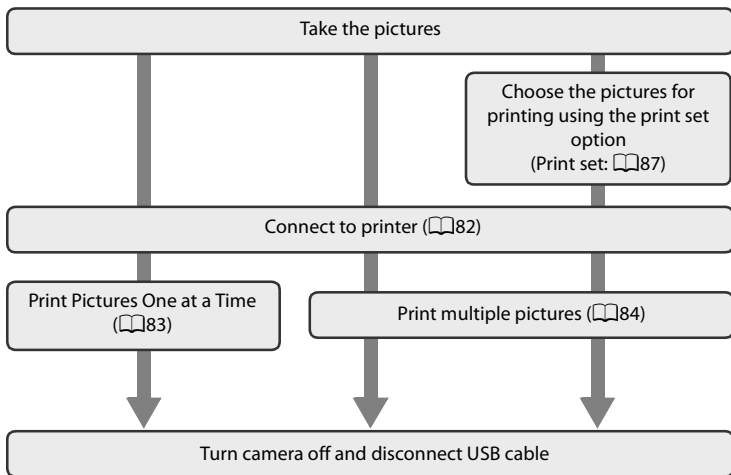

✓ Notes on Power Source

- When connecting the camera to a computer or printer, use a fully charged battery to prevent the battery from draining unexpectedly.
- Use the optional AC Adapter EH-62F to charge this camera using home electronic outlets. Do not, under any circumstances, use another make or model of AC adapter. Failure to observe this precaution could result in overheating or in damage to the camera.

🔍 Printing Pictures

In addition to printing pictures transferred to a computer and printing over a direct camera-to-printer connection for images recorded in the memory card, the following options are also available for printing pictures:

- Insert a memory card into a DPOF-compatible printer's card slot.
- Take a memory card to a digital photo lab.

For printing using these methods, specify the pictures and the number of prints each using the **Print set** (📖87) option in the playback menu.

Connecting the Camera to a Printer

- 1 Turn off the camera.

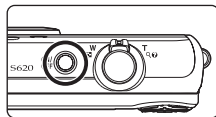

- 2 Turn on the printer.

- Check printer settings.

- 3 Connect the camera to the printer using the supplied USB cable.

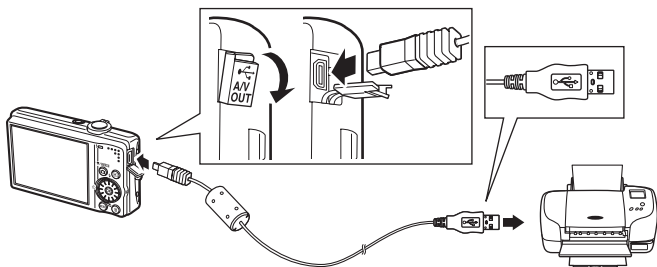

- 4 Turn on the camera.

- When connected correctly, the PictBridge startup screen ① will be displayed in the camera monitor. Then the print selection screen will be displayed ②.

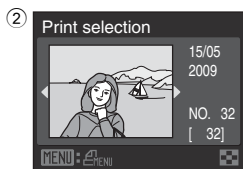
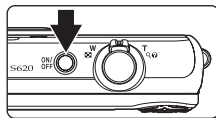

✓ Connecting the USB Cable

When connecting the USB cable, be sure that the connectors are oriented correctly. Do not use force when connecting the USB cable. When disconnecting the USB cable, do not pull the connector at an angle.

Printing Pictures One at a Time

After connecting the camera to the printer correctly (📖82), print pictures by following the procedure below.

1 Use the rotary multi selector to choose the picture to be printed and press the **OK** button.

- Rotate the zoom control to **W** (📷) to display 12 thumbnails, or to **T** (📺) to switch back to full-frame playback.

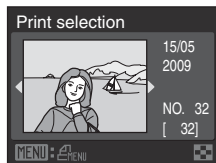

2 Choose **Copies** and press the **OK** button.

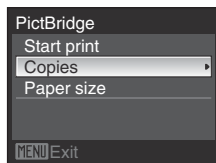

3 Choose the number of copies (up to nine) and press the **OK** button.

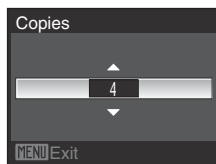

4 Choose **Paper size** and press the **OK** button.

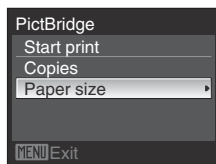

5 Choose the desired paper size and press the **OK** button.

- To specify paper size using printer settings, choose **Default** in the paper size menu.

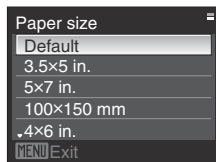

6 Choose **Start print** and press the **OK** button.

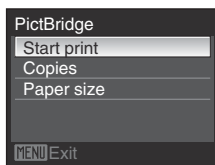

7 Printing starts.

- Monitor display returns to that shown in step 1 when printing is complete.
- To cancel before all copies have been printed, press the **OK** button.

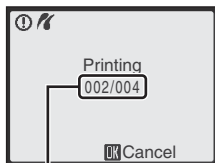

Current print/
total number of prints

Printing Multiple Pictures

After connecting the camera to the printer correctly (82), print pictures by following the procedure below.

1 When the print selection screen is displayed, press the **MENU** button.

- The print menu is displayed.

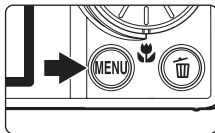

2 Use the rotary multi selector to choose **Paper size** and press the **OK** button.

- To exit the print menu, press the **MENU** button.

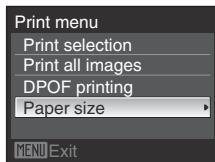

3 Choose the desired paper size and press the **OK** button.

- To specify paper size using printer settings, choose **Default** in the paper size menu.

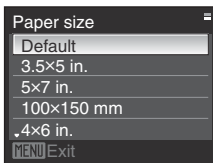

4 Choose **Print selection**, **Print all images** or **DPOF printing** and press the **OK** button.

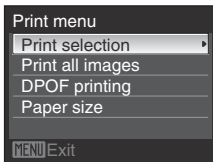

Print selection

Choose the pictures (up to a maximum of 99) and number of copies (up to nine per picture).

- Rotate the rotary multi selector, or press ◀ or ▶ to choose the pictures, and press ▲ or ▼ to set the number of copies for each.
- Pictures selected for printing can be recognized by the check mark icon and the numeral indicating the number of copies to be printed. A check mark is not displayed with pictures for which no copies have been specified and these pictures will not be printed.
- Rotate the zoom control to **T** (🔍) to switch to full-frame playback, or **W** (🖼️) to switch to 12 thumbnails display.
- Press the **OK** button when setting is complete.
- The menu shown at right will be displayed. To print, choose **Start print** and press the **OK** button.
- Choose **Cancel** and press the **OK** button to return to the print menu.

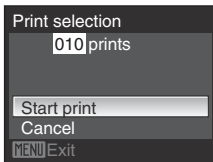
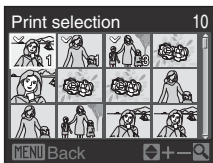

Print all images

All pictures stored in the internal memory, or on the memory card, are printed one at a time.

- The menu shown at right will be displayed. To print, choose **Start print** and press the **OK** button.
- Choose **Cancel** and press the **OK** button to return to the print menu.

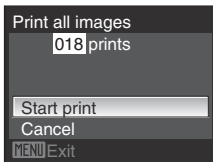

DPOF printing

Print the pictures in the print order that was created using **Print set** (87).

- The menu shown at right will be displayed. To print, choose **Start print** and press the **OK** button.
- Choose **Cancel** and press the **OK** button to return to the print menu.
- To view the current print order, choose **View images** and press the **OK** button. To print pictures, press the **OK** button again.

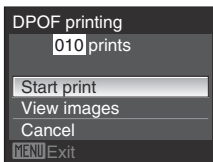

5 Printing starts.

- Monitor display returns to that shown in step 2 when printing is complete.
- To cancel before all copies have been printed, press the **OK** button.

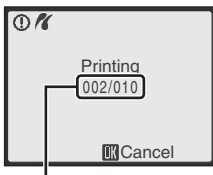

Current print/
total number of prints

Paper Size

The camera supports the following paper sizes: **Default** (the default paper size for the current printer), **3.5x5 in.**, **5x7 in.**, **100x150 mm**, **4x6 in.**, **8x10 in.**, **Letter**, **A3**, and **A4**. Only sizes supported by the current printer will be displayed.

Creating a DPOF Print Order: Print Set

The Print set option in the playback menu is used to create digital “print orders” for printing on DPOF-compatible printers or in print shops (📖 148).

When the camera is connected to a PictBridge-compatible printer, pictures can be printed from the printer according to the DPOF print order you have created for pictures on the memory card. If the memory card is removed from the camera, you can create the DPOF print order for pictures in the internal memory and print pictures according to the DPOF print order.

1 Press the **MENU** button in playback mode.

- The playback menu is displayed.

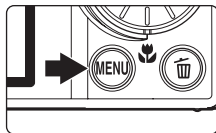

2 Use the rotary multi selector to choose **Print set** and press the **OK** button.

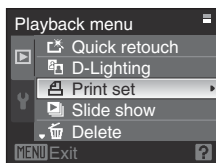

3 Choose **Select images** and press the **OK** button.

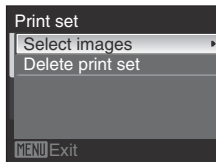

4 Choose the pictures (up to a maximum of 99) and number of copies (up to nine per picture).

- Rotate the rotary multi selector, or press ◀ or ▶ to choose the pictures, and press ▲ or ▼ to set the number of copies for each.
- Pictures selected for printing can be recognized by the check mark icon and the numeral indicating the number of copies to be printed. A check mark is not displayed with pictures for which no copies have been specified and these pictures will not be printed.
- Rotate the zoom control to **T** (📷) to switch to full-frame playback, or **W** (📱) to switch to 12 thumbnails display.
- Press the **OK** button when setting is complete.

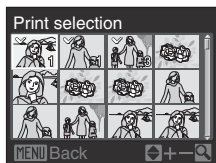

5 Choose whether or not to also print shooting date and photo information.

- Choose **Date** and press the **OK** button to print the date of recording on all pictures in the print order.
- Choose **Info** and press the **OK** button to print shooting information (shutter speed and aperture) on all pictures in the print order.
- Choose **Done** and press the **OK** button to complete the print order.

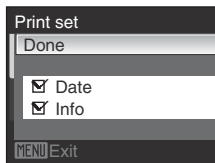

Pictures selected for printing are recognized by the  icon displayed with playback.

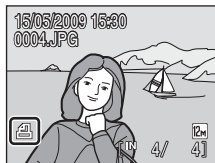

Notes on Printing Shooting Date and Photo Information

When the **Date** and **Info** options are enabled in the Print set menu, shooting date and photo information are printed on pictures when a DPOF-compatible ( 148) printer which supports printing of shooting date and photo information is used.

- Photo information cannot be printed when the camera is connected directly to a printer, via the supplied USB cable, for DPOF printing ( 86).
- **Date** and **Info** are reset each time the **Print set** menu is displayed.

Deleting All Print Orders

Choose **Delete print set** in step 3 and press the **OK** button. Print orders for all pictures will be deleted.

Note on the Print Set Date Option

The date and time printed on the picture is the date and time recorded on the camera when the picture was taken. The date and time printed using this option will not be affected even if the camera's **Date** setting is changed from the setup menu after the pictures are taken.



















Date Imprint

The date and time of recording can be imprinted on pictures using the **Date imprint** option ( 118) in the setup menu. Pictures with the date and time imprinted on them can also be printed from printers that do not support printing of the date and time on pictures.

Only the date and time of date imprint on the pictures will be printed, even if **Print set** is enabled with the date selected in the print set screen.

Shooting Options: The Shooting Menu

The shooting menu of auto mode contains the following options.

	Image mode*	 90
Choose the image mode (a combination of the image size and image quality (compression)) to be used when recording.		
	White balance	 92
Match white balance to the light source.		
	Metering	 94
Choose how the camera meters exposure.		
	Continuous	 95
Change settings for Continuous and BSS (Best Shot Selector).		
	ISO sensitivity	 97
Control the camera's sensitivity to light.		
	Color options	 98
Apply color effects to pictures as they are recorded.		
	AF area mode	 99
Choose where the camera focuses.		
	Autofocus mode	 102
Choose how the camera focuses.		

* The **Image mode** setting is also available from other shooting mode (except the movie mode).

Displaying the Shooting Menu

Set the camera to  (auto) mode (22).

Press the **MENU** button to display the shooting menu.

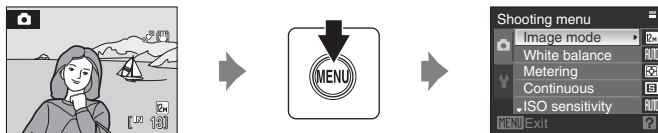

- Use the rotary multi selector to choose and apply settings (10).
- Press the **MENU** button to exit the shooting menu.

Functions that Cannot be Applied Simultaneously

Some functions cannot be enabled in conjunction with others (103).

Image Mode

Set to (Auto) → MENU (Shooting menu) → Image mode

Choose an image mode, which is the combination of image size and image quality (compression), according to how you plan to use the picture and the capacity of the internal memory or memory card.

The larger the image, the larger the size at which it can be printed or displayed without becoming noticeably “grainy,” limiting the number of pictures that can be recorded.

Image mode	Image size (pixels)	Description
High (4000★)	4,000×3,000	Highest quality, suitable for enlargements or high-quality prints. The compression ratio is approximately 1:4.
Normal (4000) (default setting)	4,000×3,000	The best choice in most situations. The compression ratio is approximately 1:8.
Normal (3264)	3,264×2,448	
Normal (2592)	2,592×1,944	
Normal (2048)	2,048×1,536	Smaller size allows more pictures to be stored. The compression ratio is approximately 1:8.
PC screen (1024)	1,024×768	Suited to display on computer monitor. The compression ratio is approximately 1:8.
TV screen (640)	640×480	Suited to full-screen display on a television or distribution by e-mail or the web. The compression ratio is approximately 1:8.
16:9 (1920)	1,920×1,080	Pictures with an aspect ratio of 16:9 can be taken. The compression ratio is approximately 1:8.









The icon for the current setting is displayed in the monitor in shooting and playback modes (6, 7).

Image Mode

Changes made to the image mode setting apply to all shooting modes (except those available from the movie mode).

Number of Exposures Remaining

The following table lists the approximate number of pictures that can be stored in internal memory and on a 512 MB memory card. Note that the number of images that can be stored will differ depending on the composition of the image (due to JPEG compression). In addition, this number may differ depending on the make of memory card, even if the capacity for the memory card is the same.



Setting	Internal memory (approx. 45 MB)	Memory card ¹ (512 MB)	Print size ² (cm/in.)
 High (4000 ★)	7	80	34 × 25/13 × 10
 Normal (4000)	13	150	34 × 25/13 × 10
 Normal (3264)	19	220	28 × 21/11 × 8
 Normal (2592)	31	340	22 × 16/8.5 × 6.5
 Normal (2048)	49	550	17 × 13/7 × 5
 PC screen (1024)	159	1,700	9 × 7/3.5 × 2.5
 TV screen (640)	319	3,400	5 × 4/2 × 1.5
 16:9 (1920)	73	800	16 × 9/6.5 × 3.5

1 If the number of exposures remaining is 10,000 or more, the number of exposures remaining display shows "9999".

2 Print size at an output resolution of 300 dpi.

Print sizes are calculated by dividing the number of pixels by printer resolution (dpi) and multiplying by 2.54 cm (1 in.). However, even with the same image size setting, images printed at higher resolutions will print smaller than the size indicated, and those printed at lower resolutions will print larger than the size indicated.

WB White Balance

Set to  (Auto) → MENU (Shooting menu) →  White balance

The color of light reflected from an object varies with the color of the light source. The human brain is able to adapt to changes in the color of the light source, with the result that white objects appear white whether seen in the shade, direct sunlight, or under incandescent lighting. Digital cameras can mimic this adjustment of the human eye by processing images according to the color of the light source. This is known as “white balance.” For natural coloration, choose a white balance setting that matches the light source before shooting.

Although the default setting, **Auto**, can be used under most types of lighting, you can apply the white balance setting suited to a particular light source to achieve more accurate results.

Auto (default setting)

White balance automatically adjusted to suit lighting conditions. Best choice in most situations. Can be used in most situations.

Preset manual

Neutral-colored object used as reference to set white balance under unusual lighting conditions, see “Preset Manual” (📖93) for details.

Daylight

White balance adjusted for direct sunlight.

Incandescent

Use under incandescent lighting.

Fluorescent

Use under most types of fluorescent lighting.

Cloudy

Use when shooting under overcast skies.

Flash

Use with the flash.

The effects of the selected option can be previewed in the monitor. At settings other than **Auto**, the icon for the current setting is displayed in the monitor (📖6).

Flash Mode

At white balance settings other than **Auto** or **Flash**, turn the flash off (🔴) (📖30).

Preset Manual

Preset manual is used with mixed lighting or to compensate for light sources with a strong color cast when the desired effect has not been achieved with settings like **Auto** and **Incandescent** (for example, to make images shot under a lamp with a red shade look as though they had been shot under white light).

1 Place a white or gray reference object under the lighting that will be used during shooting.

2 Use the rotary multi selector to choose **PRE Preset manual** in the white balance menu, and press the **OK** button.

- The camera zooms in.

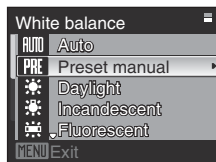

3 Choose **Measure**.

- To use the most recently measured value for preset manual, choose **Cancel** and press the **OK** button. The most recently measured value will be set for White Balance.



4 Frame the reference object.

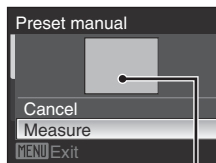

Reference object frame



5 Press the **OK** button to measure the white balance value.

- The shutter is released and the new white balance value is set.
- No images are recorded.

Note on Preset Manual

Regardless of the flash mode selected, the flash will not fire when the **OK** button is pressed in step 5. Therefore, the camera cannot measure a value for preset manual for when the flash is used.

Metering

Set to  (Auto) → MENU (Shooting menu) →  Metering

The process of measuring the brightness of the subject to determine the exposure is known as Metering.

Choose how the camera meters exposure.

Matrix (default setting)

Camera sets exposure for entire frame. Recommended in most situations.

Center-weighted

Camera meters entire frame but assigns greatest weight to subject in center of frame. Classic meter for portraits; preserves background details while letting lighting conditions at center of frame determine exposure. Can be used with focus lock (100) to meter off-center subjects.

Note on Metering

When digital zoom is in effect, **Metering** is set to **Center-weighted**, and the metered area is not displayed in the monitor.

Metering Area

The active metering area is displayed in the monitor when **Center-weighted** is selected for **Metering**.

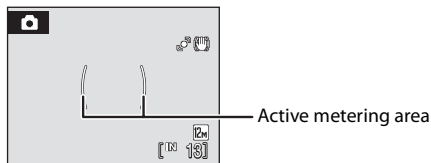

Continuous

Set to  (Auto) → MENU (Shooting menu) →  Continuous

Change settings for Continuous and BSS (Best Shot Selector).

Flash will be switched off when **Continuous**, **BSS**, or **Multi-shot 16** is selected.

Focus, exposure, and white balance are fixed at the values for the first image in each series.

Single (default setting)

One image is shot each time the shutter-release button is pressed.

Continuous

While the shutter-release button is held down, pictures are taken at rate of up to about 1.0 frames per second (fps) when image mode is set to  **Normal (4000)**. Shooting ends when the shutter-release button is released, or ten shots have been taken with the shutter-release button held down.

BSS BSS

BSS is recommended for shooting under low lighting without the flash, with the camera zoomed in, or in other situations in which camera shake is likely to blur pictures.

The camera takes up to ten images while the shutter-release button is held down. The sharpest image (image with the most detail) in the series is automatically selected and saved.

Multi-shot 16

Each time the shutter-release button is pressed all the way down, 16 pictures are taken at about 30 frames per second and the camera arranges them in a single picture with image mode set to  **Normal (2592)**.

- Digital zoom is not available.
- The setting for **ISO sensitivity** (97) will be changed automatically according to the brightness.

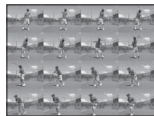

Intvl timer shooting

Camera takes images automatically at specified intervals (96).

At settings other than **Single**, the indicator for the current setting is displayed in the monitor (6).

Note on Continuous Shooting

The maximum frame rate with continuous shooting may vary, depending upon the current image mode and the type of memory card used.

Note on Best Shot Selector

BSS is best suited for shooting stationary subjects. However, BSS may not produce the desired results if the subject moves or the composition changes while the shutter-release button is pressed all the way down.

✔ Note on Multi-shot 16

If bright objects such as the sun or electric lights are captured when shooting with the Multi-shot 16 option, vertical streaks of light may appear in the recorded images. We recommend that you avoid capturing bright objects when shooting with the Multi-shot 16 option.

Interval Timer Shooting

Images are shot automatically at specified intervals.

Choose from **30 s**, **1 min**, **5 min**, or **10 min**.

- Use the rotary multi selector to choose **Intvl timer shooting** in the continuous mode menu and press the **OK** button.

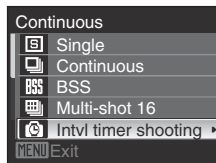

- Choose the interval taken between each shot and press the **OK** button.

- The maximum amount of frames that can be taken during Interval Timer Shooting differs according to the interval taken between each shot.
 - **30 s**: 600 images
 - **1 min**: 300 images
 - **5 min**: 60 images
 - **10 min**: 30 images

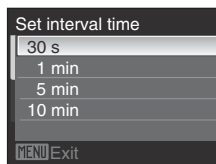

- Press the **MENU** button.

- The camera returns to shooting mode.

- Press the shutter-release button all the way down to shot the first picture and initiate interval timer shooting.

- Monitor turns off and the power-on lamp blinks between shots.
- The monitor turns back on automatically right before the next image is shot.

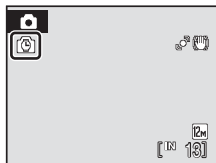

- Press the shutter-release button all the way down a second time to end recording.

- Recording will end automatically if the internal memory or memory card becomes full, or when the maximum amount of frames have been recorded.

✓ Notes on Interval Timer Shooting

- To prevent the camera from turning off unexpectedly during recording, use a fully charged battery.
- Use the optional AC Adapter EH-62F to charge this camera using home electronic outlets. Do not, under any circumstances, use another make or model of AC adapter. Failure to observe this precaution could result in overheating or in damage to the camera.

📖 More Information

See “File and Folder Names” (📖131) for more information.

ISO ISO Sensitivity

Set to 📷 (Auto) → MENU (Shooting menu) → ISO ISO sensitivity

Sensitivity is a measure of how quickly the camera reacts to light. The higher the sensitivity, the less light needed to make an exposure. Although a high ISO rating is suited for taking pictures of subjects in action or in poor lighting, high sensitivity is often associated with “noise” -randomly spaced, brightly colored pixels concentrated in dark parts of the image.

Auto (default setting)

Sensitivity is ISO 100 in bright places; in dark places the camera automatically raises sensitivity to a maximum of ISO 1600.

Fixed range auto

Choose the range in which the camera automatically adjusts ISO sensitivity, from **ISO 100-400** (default setting), or **ISO 100-800**. The camera will not raise sensitivity beyond the maximum value in the selected range. Set the maximum value for ISO sensitivity for effective control over the amount of “grain” that appears in images.

100, 200, 400, 800, 1600, 3200, 6400

ISO Sensitivity will be locked at the specified value.

- When ISO sensitivity is locked, **Motion detection** (📖120) does not function even when **Auto** is selected.

At settings other than Auto, the current setting is displayed in the monitor (📖6). If **Auto** is selected and the sensitivity is raised above an ISO 100, the **ISO** icon will be displayed (📖31). If **Fixed range auto** is selected, **ISO** + the maximum value for ISO sensitivity will be displayed.

Color Options

Set to  (Auto) → MENU (Shooting menu) →  Color options

Make colors more vivid or record pictures in monochrome.

 **Standard color (default setting)**

Use for pictures exhibiting natural color.

 **Vivid color**

Use to achieve a vivid, “photoprint” effect.

 **Black-and-white**

Record pictures in black-and-white.

 **Sepia**

Record pictures in sepia tones.

 **Cyanotype**

Record pictures in cyan-blue monochrome.

 **Pastel**

Change to a pastel shade.

At settings other than **Standard color**, the icon for the current setting is displayed in the monitor (6). Monitor color tones also change depending upon the setting.

[+/-] AF-Area Mode

Set to (Auto) → MENU (Shooting menu) → [+/-] AF area mode

Use this option to determine where the camera focuses.

When digital zoom is in effect, the camera will focus on the subject in the center focus area regardless of the applied **AF area mode** option.



Face priority

The camera automatically detects and focuses on a face looking toward the camera (see “Shooting with Face Priority” (📖101) for more information).

If the camera detects multiple faces, the camera focuses on the face closest to the camera.

When shooting pictures of subjects other than people, or framing a subject with which no face is recognized, AF area mode will be set to **Auto**. The camera chooses the focus area

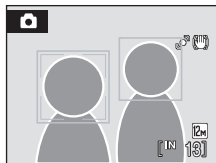

Auto (default setting)

Camera automatically selects the focus area (one of nine) containing the subject closest to the camera. Press the shutter-release button halfway to activate the focus area.

When the shutter-release button is pressed halfway, the focus area selected by the camera will be displayed in the monitor.

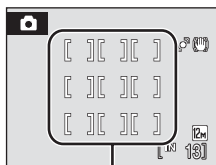

Focus areas



Manual

Choose the focus position from 99 areas in the screen. This option is suited to situations in which the intended subject is relatively still and not positioned in the center of the frame. Press the rotary multi selector or to select one of 99 focus areas displayed in the monitor's focus-area selection screen, and shoot.

To end focus-area selection and adjust the flash mode, macro mode, self-timer and exposure compensation settings, press the button. To return to the focus-area selection screen, press the button again.

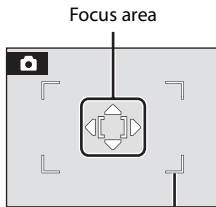

Selectable areas

Shooting Options: The Shooting Menu

Center

Camera focuses on the subject in the center of the frame.
Center focus area is always used.

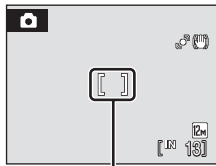

Focus area

Focus Lock

Use focus lock to focus on off-center subjects when center is selected for AF area mode.
The following steps explain the usage of focus lock when **Center** is selected for **AF area mode**.

1 Position the subject in the center of the frame.



2 Press the shutter-release button halfway.

- Confirm that the focus area indicator is green.
- Focus and exposure are locked.



3 Continue holding down the shutter-release button halfway and recompose the picture.

- Be sure that the distance between the camera and the subject does not change.



4 Press the shutter-release button the rest of the way down to shoot.



More Information

See "Autofocus" (📖27) for more information.

Shooting with Face Priority

The camera automatically detects and focuses on a face looking toward the camera. The face priority function will be enabled for the scenarios below.

- **Face priority** is selected for AF area mode (📖99)
- When **Scene auto selector** (📖42), **Portrait** (📖36) or **Night portrait** (📖37) is chosen for scene mode
- Smile mode (📖48)

1 Frame the picture.

- When the camera detects a face looking toward the camera, that face will be framed by a yellow double border.



- When the camera detects more than one face, operation varies, depending upon the shooting mode, as follows.

Shooting mode	Faces framed by a double border	Number of faces to be recognized
Auto mode (Face priority) Scene auto selector, Portrait or Night portrait scene modes	The face closest to the camera * The other faces are framed by a single border.	Up to 12
Smile mode	The face closest to the camera * The other faces are framed by a single border.	Up to 3

2 Press the shutter-release button halfway.

- The camera focuses on the face framed by the double border. The double border will glow green and focus will be locked.
- When the camera is unable to focus on a face, the double border will blink. Press the shutter-release button halfway again and focus.
- Press the shutter-release button all the way down to shoot.
- You do not need to press the shutter-release button halfway in smile mode. If the camera detects a smiling face, the shutter is automatically released (📖48).

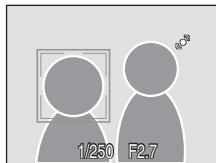

✓ Notes on Face Priority

- When **Face priority** is selected for AF area mode, the setting will automatically switch to **Auto** if no face is detected when the shutter-release button is pressed halfway.
- If no face is recognized when the shutter-release button is pressed halfway in the **Portrait** or **Night portrait** scene modes or smile mode, the camera will focus on the subject in the center of the frame.
- The camera may be unable to detect faces in the following situations:
 - When faces are partially hidden by sunglasses or other obstructions
 - When the subject is not looking directly at the camera
 - When faces take up too much or too little of the frame
- The camera's ability to detect faces depends on a variety of factors, including whether or not the subject is facing the camera.
- In some rare cases shooting subjects with which autofocus may not perform as expected (📖27), the subject may not be in focus despite the fact that the double border glows green. Should this occur, switch to auto mode and set AF area mode to **Manual** or **Center**, refocus on another subject positioned at the same distance from the camera as the actual portrait subject, and use focus lock (📖100).
- Images that were taken using face priority will be rotated and displayed automatically according to the orientation of the faces detected, in full-frame and thumbnail playback modes (excluding pictures that were shot using **Continuous**, **BSS** and **Multi-shot 16** (📖95)).

🔍 Autofocus Mode

Set to 📷 (Auto) → MENU (Shooting menu) → 🔍 Autofocus mode

Choose how the camera focuses.

📷 Single AF (default setting)

Camera focuses when the shutter-release button is pressed halfway.

📷 Full-time AF

Camera focuses continuously until the shutter-release button is pressed down halfway. Use with moving subjects.

✓ Notes on Autofocus Mode

- **Autofocus mode** will be automatically fixed at **Single AF** when **Face priority** is selected for **AF area mode** (📖99).
- Changes made to the **Autofocus mode** setting of auto mode will not be applied to the **Autofocus mode** setting of the Subject tracking mode.

Functions that Cannot be Applied Simultaneously

Restrictions apply to the following settings in  (auto) mode.

Flash mode

- Selecting **Continuous**, **BSS** or **Multi-shot 16** for **Continuous** changes the flash mode setting to  (off).
- Selecting **Single** or **Intvl timer shooting** for **Continuous** restores the original flash mode setting.

Self-timer

- If self-timer is on, only one picture will be taken when the shutter is released, regardless of settings selected for the **Continuous** setting.
- The last **Continuous** setting applied is restored when picture is taken or self-timer is turned off.

Continuous

- If **Multi-shot 16** is chosen for **Continuous**,  **Normal (2592)** will be chosen for **Image mode** and the setting for **ISO sensitivity** will be changed automatically according to the brightness.
- Selecting an option other than **Multi-shot 16** for **Continuous** restores the original setting for **Image mode** and **ISO sensitivity**.

White balance and Color options





















- **White balance** is automatically set to **Auto** and cannot be adjusted when **Black-and-white**, **Sepia** or **Cyanotype** is selected for **Color options**.
- Selecting **Standard color**, **Vivid color** or **Pastel** for **Color options** restores the last **White balance** applied.

Autofocus mode

- **Autofocus mode** is automatically set to **Single AF** and cannot be adjusted when **Face priority** is selected for **AF area mode**.
- The last **Autofocus mode** setting applied is restored when any setting other than **Face priority** is selected for **AF area mode**.

Playback Options: The Playback Menu

The playback menu contains the following options.

	Quick retouch  56
Easily create retouched images in which contrast and saturation have been enhanced.	
	D-Lighting  57
Enhances brightness and contrast in dark portions of pictures.	
	Print set  87
Select pictures to print and the number of copies for each.	
	Slide show  106
View pictures stored in the internal memory or on a memory card in an automatic slide show.	
	Delete  107
Delete selected or all pictures.	
	Protect  107
Protect selected pictures from accidental deletion.	
	Rotate image  108
Change the orientation of an existing picture.	
	Small picture  59
Create a small copy of the current picture.	
	Voice memo  60
Record and play voice memo.	
	Copy  109
Copy files between memory card and internal memory.	

Displaying the Playback Menu

Enter the playback mode by pressing the  button ( 28).

Display the playback menu by pressing the **MENU** button.

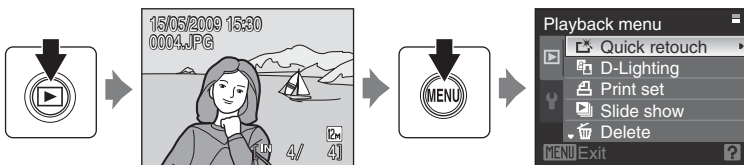

- Use the rotary multi selector to choose and apply settings ( 10).
- To exit the playback menu, press the **MENU** button.

Selecting Pictures

The picture selection screen, as shown at right, will be displayed with the following menus:

- **Playback menu:**

- **Select images** in Print set (📖87)

- **Erase selected images** in Delete (📖107)

- Protect (📖107)

- Rotate image (📖108)

- **Selected images** in Copy (📖109)

- **Setup menu:**

- Welcome screen (📖113)



Follow the procedure described below to select pictures.

1 Rotate the rotary multi selector, or press ◀ or ▶ to choose the desired picture.

- Only one picture can be selected for **Rotate image** and **Welcome screen**. Proceed to step 3
- Rotate the zoom control to **T** (🔍) to switch to full-frame playback, or **W** (📐) to switch to 12 thumbnails display.



2 Press ▲ or ▼ to select ON or OFF (or the number of copies).

- When ON is selected, a check mark is displayed in the current picture. Repeat steps 1 and 2 to select additional pictures.



3 Press the Ⓞ button to apply picture selection.

Slide Show

Press the  button (Playback mode) → MENU (Playback menu) →  Slide show

Playback pictures, stored in the internal memory or on a memory card, one by one in an automated “slide show.”

1 Use the rotary multi selector to choose **Start** and press the **OK** button.

- To change the interval between pictures, choose **Frame intvl**, select the desired interval time, and press the **OK** button before choosing **Start**.
- To repeat the slide show automatically, enable **Loop** and press the **OK** button before choosing **Start**. The check mark (✓) will be added to the loop option when enabled.

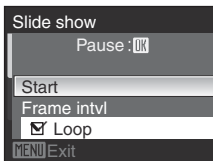

2 The slide show begins.

- Press the rotary multi selector **▶** while the slide show is in progress to view images in the order recorded (hold down to fast forward), or **◀** to view images in reverse order (hold down to rewind).
- Press the **OK** button to pause the slide show.



3 Choose **End** or **Restart**.

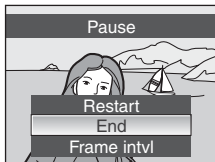

- When the slide show ends or is paused, choose **End** and press the **OK** button to return to the playback menu or choose **Restart** to play the slide show again.



Notes on Slide Show

- Movies are not included in slide shows.
- Slide shows play for a maximum of 30 minutes, even when **Loop** is selected ( 122).

Delete

Press the  button (Playback mode) → MENU (Playback menu) →  Delete

Delete selected or all pictures.

Erase selected images

Delete selected pictures (see “Selecting Pictures” (📖105) for more information).



Erase all images

Delete all pictures.

Notes on Deletion

- Once deleted, pictures cannot be recovered. Transfer important images to a computer before deletion.
- pictures marked with the  icon are protected and cannot be deleted.

Protect

Press the  button (Playback mode) → MENU (Playback menu) →  Protect

Protect selected pictures from accidental deletion.

Select the picture and apply the setting in the picture selection screen (see “Selecting Pictures” (📖105) for more information).

Note, however, that formatting the camera’s internal memory or the memory card will permanently erase protected files (📖123).

Protected pictures are recognized by the  icon in playback mode (📖7, 53).



Rotate Image

Press the  button (Playback mode) → MENU (Playback menu) →  Rotate image

Change the orientation of pictures played back in the camera's monitor after shooting.

Pictures can be rotated 90° clockwise or counterclockwise.



Pictures that were recorded in the portrait (vertical) orientation can be rotated up to 180° in either direction.

Select a picture in the picture selection screen ([105](#)), and press the  button to display the Rotate image screen. Press the rotary multi selector  or  to rotate the picture 90°.





Press the  button to set the orientation displayed, and save the orientation data with the picture.

Copy

Press the  button (Playback mode) → MENU (Playback menu) →  Copy

Copy pictures between the internal memory and a memory card.

1 Use the rotary multi selector to select an option from the copy screen and press the  button.

- : Copy pictures from internal memory to memory card.
- : Copy pictures from memory card to internal memory.







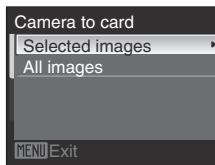

2 Select a copy option and press the  button.

- **Selected images:** Copy pictures selected from the picture selection screen (105).
- **All images:** Copy all pictures.



Notes on Copying Pictures

- JPEG-, AVI-, and WAV-format files can be copied. Files recorded in any other format cannot be copied.
- If voice memos (60) are attached to pictures selected for copying, voice memos are copied with the pictures.
- Sound files recorded using Voice Recording (71) can be copied using the **Copy sound files** option (75).
- Pictures recorded with another make or model of camera or that have been modified on a computer cannot be copied.
- Edited copies have the same protection marking (87) as the original, but are not marked for printing (107).
- Pictures or movies copied from the internal memory or the memory card (65) cannot be displayed in the auto sort mode.

Memory contains no images. Message



































If there are no pictures stored on the memory card when playback mode is applied, the message, **Memory contains no images.**, will be displayed. Press the MENU button to display the copy option screen, and copy the pictures stored in the camera's internal memory to the memory card.

More Information

See "File and Folder Names" (131) for more information.

Basic Camera Setup: The Setup Menu

The setup menu contains the following options.

	Menus  112
	Choose how menus are displayed.
	Welcome screen  113
	Select screen displayed when camera is turned on.
	Date  114
	Set camera clock and choose home and destination time zones.
	Monitor settings  117
	Adjust monitor brightness and choose display style.
	Date imprint  118
	Imprint date on pictures.
	Vibration reduction  119
	Choose whether or not vibration reduction is enabled.
	Motion detection  120
	Adjust the motion detection setting to reduce the effects of camera shake and subject movement when shooting still pictures.
	AF assist  121
	Enable or disable AF-assist illumination.
	Digital zoom  121
	Enable or disable digital zoom.
	Sound settings  122
	Adjust sound settings.
	Auto off  122
	Set time before camera enters standby mode.
	Format memory/Format card  123
	Format internal memory or memory card.
	Language  124
	Choose language used for camera monitor display.
	Video mode  124
	Adjust settings necessary for connection to TV.
	Blink warning  125
	Choose whether or not to detect blinking human subjects when shooting pictures using face priority ( 101).
	Reset all  127
	Restore camera settings to default values.
	Firmware version  129
	Display camera firmware version.

Displaying the Setup Menu

Choose the **Y** tab in the menu screen.

- 1 Press the **MENU** button to display the menu screen.

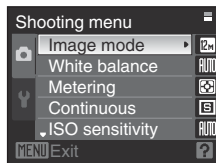

- 2 Press **◀** on the rotary multi selector.

- Tab will be selectable.

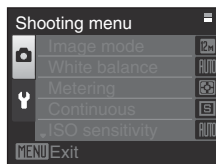

- 3 Press **▲** or **▼** to select the **Y** tab.

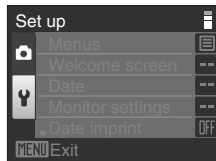

- 4 Press **▶** or the **OK** button.

- The setup menu options will be selectable.
- Use the rotary multi selector to choose and apply settings (10).
- To exit the setup menu, press the **MENU** button or **◀** to select the shooting or playback tabs.

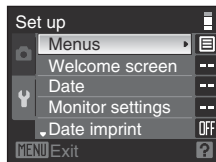

Menus

Press the **MENU** button →  (setup menu) (📖111) →  Menus

Select a format for menu display.

Text (default setting)

Menus are displayed in list format.

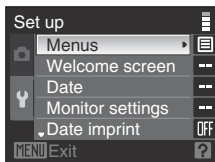

Icons

All menu options can be displayed in a single page.

Menu name

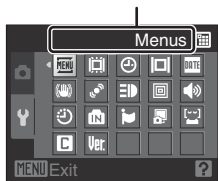

Welcome Screen

Press the **MENU** button →  (setup menu) (📖111) →  Welcome screen

You can select the welcome screen to be displayed when the camera is turned on.

None (default setting)

Welcome screen is not displayed.

COOLPIX

Displays a welcome screen.

Select an image

Select a picture in the internal memory or on the memory card for the welcome screen. Choose a picture in the picture selection screen (📖105), and press the **OK** button.

As the selected picture is stored in the camera, the picture will appear in the welcome screen even if the original picture is deleted.

- Pictures taken at an **Image mode** setting (📖90) of **16:9 (1920)**, and copies created at a size of 320 × 240 or smaller using the crop (📖58) or small picture (📖59) function, cannot be used.

Date





Press the **MENU** button →  (Setup menu) (111) →  Date

Set the camera clock and choose home and travel destination time zones.





Date

Set camera clock to current date and time.

Use the following controls to set the date and time.

-   : highlight a different item (day, month, year, hour, minute, and the order in which day, month, and year are displayed)
-   : edit the highlighted item
-  button: apply the setting

Time zone

 (home time zone) can be specified and daylight saving enabled or disabled from time zone options. When  (travel destination) is selected, the time difference (116) between the home time zone () is automatically calculated and the date and time in the selected region are recorded. Useful when travelling.

Setting the Travel Destination Time Zone

1 Use the rotary multi selector to choose **Time zone** and press the button.

- The time zone screen is displayed.

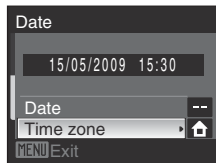

2 Choose **Travel destination** and press the button.

- The date and time displayed on the monitor changes according to the region currently selected.

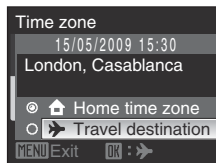

3 Press .

- The time zone selection screen is displayed.

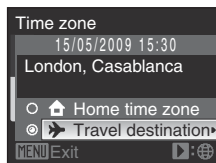

4 Press ◀ or ▶ to choose the travel destination time zone.

- Pressing ▲ in a time zone where daylight saving is in effect will display the ☀ icon on the top of the screen. Daylight saving will be turned on and the time will advance by one hour. Press ▼ to turn it off.
- Press the OK button to enter the travel destination time zone.
- While the travel destination time zone is selected, the 📍 icon will be displayed in the monitor when the camera is in shooting mode.

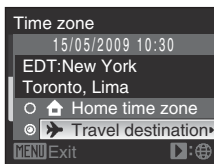
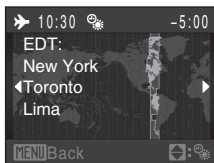

✓ The Clock Battery

The camera's internal clock uses a different battery from the camera's battery. The clock battery charges when the main battery is installed or the AC adapter is connected, and provide several days of backup power after about ten hours of charging.

📍 (Home Time Zone)

- To switch to the home time zone, choose 🏠 **Home time zone** in step 2 and press the OK button.
- To change the home time zone, choose 🏠 **Home time zone** in step 2 and perform the steps for ▶ **Travel destination** to set the home time zone.

📌 Daylight Saving Time

When daylight saving time starts or ends, turn the daylight saving time option on or off from the time zone selection screen displayed in step 4.

 **Time Zones**  19

The camera supports the time zones listed below.

For time differences not listed below, set the camera clock using **Date**.

UTC +/-	Location	UTC +/-	Location
-11	Midway, Samoa	+1	Madrid, Paris, Berlin
-10	Hawaii, Tahiti	+2	Athens, Helsinki, Ankara
-9	Alaska, Anchorage	+3	Moscow, Nairobi, Riyadh, Kuwait, Manama
-8	PST (PDT): Los Angeles, Seattle, Vancouver	+4	Abu Dhabi, Dubai
-7	MST (MDT): Denver, Phoenix	+5	Islamabad, Karachi
-6	CST (CDT): Chicago, Houston, Mexico City	+5.5	New Delhi
-5	EST (EDT): New York, Toronto, Lima	+6	Colombo, Dhaka
-4	Caracas, Manaus	+7	Bangkok, Jakarta
-3	Buenos Aires, Sao Paulo	+8	Beijing, Hong Kong, Singapore
-2	Fernando de Noronha	+9	Tokyo, Seoul
-1	Azores	+10	Sydney, Guam
±0	London, Casablanca	+11	New Caledonia
		+12	Auckland, Fiji

Monitor Settings

Press the **MENU** button → **Y** (Setup menu) (📖111) → **Monitor settings**

Change the settings for the options below.

Photo info

Choose information displayed in the monitor during shooting and playback mode.

Brightness





Choose from five settings for monitor brightness. The default setting is **3**.

When monitor brightness boost (📖23) is activated, the monitor brightness is set to **5** and cannot be changed.

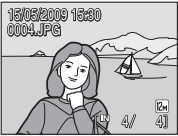

Photo Info

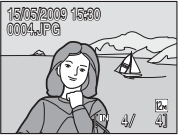
The following display options are available.

See “The Monitor” (📖6) for information on indicators in the monitor.

	During Shooting	During Playback
Show info		
Auto info (default setting)	The current settings or operation guide is displayed as in Show info above. After a few seconds, display will be the same as Hide info .	
Framing grid + Auto info	 <p>In ☑ (auto) mode, a framing grid is displayed to help frame pictures; other current settings or operation guide is displayed for a few seconds, as in Auto info above.</p> <p>In other shooting modes, the current settings or operation guide is displayed, as in Auto info above.</p>	 <p>The current settings or operation guide is displayed, as in Auto info above.</p>
Hide info		

Date Imprint

Press the **MENU** button →  (Setup menu) (111) →  **Date imprint**

Date and time of recording can be imprinted on pictures. This information can be printed even from printers that do not support printing of date and time (88).

Off (default setting)

Date and time are not imprinted on pictures.

Date



Date is imprinted on the bottom right corner of pictures taken while this option is in effect.

Date and time

Date and time are imprinted on the bottom right corner of pictures taken while this option is in effect.

At settings other than **Off**, the icon for the current setting is displayed in the monitor during shooting (6).



Date Imprint

- Imprinted dates form a permanent part of image data and cannot be deleted.
- Dates imprinted at an **Image mode** (90) setting of **TV TV screen (640)** may be difficult to read. Choose **PC PC screen (1024)** or larger when using date imprint.
- The date is recorded using the format selected in the setup menu's **Date** option (18, 114).
- Dates cannot be imprinted in the following situations.
 - When **Panorama assist** is selected for scene mode
 - Movie mode

Date Imprint and Print Set

When printing from DPOF-compatible printers which support printing of shooting date and photo information, the date and information can be printed on pictures without date and time imprinted on them, using options in the **Print set** option (87).

Vibration Reduction

Press the **MENU** button →  (Setup menu) ( 111) →  Vibration reduction

Vibration reduction effectively corrects blur, caused by slight hand movement known as camera shake, that commonly occurs when shooting with zoom applied or at slow shutter speeds. Vibration reduction can be used in all shooting modes. Set Vibration reduction to **Off** when using a tripod to stabilize the camera during shooting.

On (default setting)

Vibration reduction is enabled when shooting still pictures and recording movies. Camera detects and factors out panning movements when reducing camera shake.

When camera is panned horizontally, for example, vibration reduction reduces only vertical shake. If camera is panned vertically, vibration reduction affects only horizontal shake.

Off

Vibration reduction is not enabled.

When vibration reduction is enabled, the current setting is displayed during shooting (when **Off** is selected, an icon for the current setting is not displayed) ( 6, 23).

Notes on Vibration Reduction

- Vibration reduction may take a few seconds to activate after the power is turned on, or the camera enters shooting mode from playback mode. Wait until the display stabilizes before shooting.
- Due to characteristics of the vibration reduction function, images displayed in the camera's monitor immediately after shooting may appear blurry.
- Vibration reduction may be unable to completely eliminate the effects of camera shake in some situations.

Motion Detection

Press the **MENU** button →  (Setup menu) (📖111) →  Motion detection

Enable motion detection to reduce the effects of camera shake and subject movement when shooting still pictures.

Auto (default setting)

When camera detects the movement of the subject or camera shake, the shutter speed will be increased for reducing the effects of them.

However, motion detection does not function in the following situations.

- When the flash fires
- When the **ISO sensitivity** (📖97) setting value is fixed or when **Multi-shot 16** (📖95) is chosen in auto shooting mode
- When specific scene modes are used (📖36 to 41)
- When subject tracking mode is selected

Off

Motion detection will not be applied.

When motion detection is enabled, the current setting is displayed during shooting (when **Off** is selected, an icon for the current setting is not displayed)(📖6, 23).

The motion detection icon will glow green when the camera detects any vibration and increases the shutter speed.

Notes on Motion Detection

- Motion detection may be unable to completely reduce the camera shake and subject movement in some situations.
- Motion detection may not function if the subject exhibits significant movement or is too dark.
- The pictures taken may become somewhat grainy.

AF Assist

Press the **MENU** button → **Y** (Setup menu) (📖111) →  AF assist

Enable or disable AF-assist illumination.

Auto (default setting)

AF-assist illumination will be used to assist the focus operation when the subject is poorly lit. The illuminator has a range of about 3.0 m (9 ft. 10 in.) at the maximum wide-angle position and about 1.5 m (4 ft. 11 in.) at the maximum telephoto position. However, note that for some scene modes, AF-assist illumination turns off automatically (📖36 to 41) even if **Auto** is set.

Off

Disable this function. The camera may be unable to focus if lighting is poor.

Digital Zoom

Press the **MENU** button → **Y** (Setup menu) (📖111) →  Digital zoom

Enable or disable digital zoom.

On (default setting)

When the camera is zoomed in to the maximum optical zoom position, rotating and hold the zoom control at **T** (📖) triggers digital zoom (📖25).

Off

Digital zoom will not be activated (except when shooting a movie).

Notes on Digital Zoom

- When digital zoom is in effect, AF area mode is set to **Center** (📖99).
- Digital zoom cannot be used in the following situations.
 - When **Scene auto selector**, **Portrait** or **Night portrait** is selected for scene mode
 - When subject tracking mode is selected
 - When smile mode is selected
 - When **Multi-shot 16** is selected for **Continuous** (📖95)
 - Before movie recording begins (digital zoom of up to 2x can be applied while movies are being recorded)
- When digital zoom is in effect, **Metering** is set to **Center-weighted**.

Sound Settings

Press the MENU button →  (Setup menu) ( 111) →  Sound settings

Adjust the following sound settings.

Button sound

Turn button sound **On** (default setting) or **Off**. A beep will sound once when operations are completed successfully, twice when the camera acquires focus on the subject, and three times when error is detected. Start-up sound will also play when the camera is turned on.

Shutter sound

Choose shutter sound from **On** (default setting) or **Off**.

Auto Off

Press the MENU button →  (Setup menu) ( 111) →  Auto off

If no operations are performed for the selected length of time, the monitor will turn off and the camera enters standby mode ( 17) to reduce drain on the batteries.

The power-on lamp blinks in standby mode. If no operations are performed for another three minutes, the camera will turn off automatically.

Choose the time allowed to elapse before the camera enters standby mode if no operations are performed from **30 s**, **1 min** (default setting), **5 min**, and **30 min**.

Canceling Standby Mode

Cancel standby mode and reactivate the monitor by pressing the power switch or the shutter-release button.

Notes on Auto Off

Regardless of the option selected, the monitor will remain on as follows.

- When **30 s** or **1 min** is selected for Auto off and menus are displayed: three minutes
- Slideshow playback: maximum of 30 minutes
- AC adapter is connected: 30 minutes

Format Memory/Format Card

Press the **MENU** button →  (Setup menu) ( 111) →  **Format memory**/ **Format card**

Use this option to format the internal memory or a memory card.

Formatting the Internal Memory

To format the internal memory, remove the memory card from the camera. The **Format memory** option appears in the setup menu.

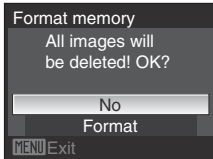

Formatting a Memory Card

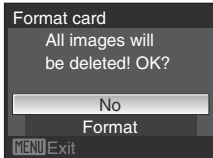

When the memory card is inserted in the camera, the **Format card** option appears in the setup menu.



Formatting Internal Memory and Memory Cards

- Formatting the internal memory or memory cards permanently deletes all data. Be sure to transfer important pictures to a computer before formatting.
- Do not turn the camera off, disconnect the AC adapter, or open the battery-chamber/memory card slot cover during formatting.
- The first time you insert the memory cards used in other devices into this camera, be sure to format them with this camera.

Language



Press the **MENU** button →  (Setup menu) (📖111) →  Language

Choose one of 24 languages for display of camera menus and messages.

Čeština	Czech
Dansk	Danish
Deutsch	German
English	(default setting)
Español	Spanish
Ελληνικά	Greek
Français	French
Indonesia	Indonesian
Italiano	Italian
Magyar	Hungarian
Nederlands	Dutch
Norsk	Norwegian

Polski	Polish
Português	Portuguese
Русский	Russian
Suomi	Finnish
Svenska	Swedish
Türkçe	Turkish
عربي	Arabic
中文简体	Simplified Chinese
中文繁體	Traditional Chinese
日本語	Japanese
한글	Korean
ภาษาไทย	Thai



Video Mode



Press the **MENU** button →  (Setup menu) (📖111) →  Video mode

Adjust settings for connection to TV.

Choose from **NTSC** or **PAL**.

Blink Warning

Press the **MENU** button →  (Setup menu) ( 111) →  Blink warning

Set whether or not to detect human subjects with eyes closed when shooting pictures using face priority ( 101) in any mode other than smile mode ( 48).

On

When the camera detects that one or more human subjects have closed their eyes shortly after recognizing the faces and shooting them, the **Did someone blink?** screen will appear on the monitor.

The face of the human subject that may have closed his/her eyes is framed by a yellow border. You can check the picture taken and determine if you need to take the picture again.

Off (default setting)

Blink warning doesn't take effect.

Note on Blink warning

Blink warning does not take place when **Continuous** is set to **Continuous**, **BSS**, **Multi-shot 16** or **Intvl timer shooting**.

Operating the Did someone blink? Screen

When the camera detects a blinking human subject, the **Did someone blink?** screen will appear on the monitor.

The following operations can be performed in the **Did someone blink?** screen.

If no operations are performed for a few seconds, the screen automatically returns to the shooting mode screen.



To	Use	Description
Enlarge and display the detected face	T (Q)	Zoom increases each time the zoom control is rotated to T (Q).
Return to full-frame playback	W (Q)	Rotate the zoom control to W (Q).
Select the face to be displayed		If the camera detects more than one human subject blinking, press ◀ or ▶ during playback zoom to display other faces.
Delete the picture taken		Press the button.
The camera returns to shooting mode.		Press the button or the shutter-release button.

Reset All

Press the MENU button →  (Setup menu) (📖111) →  Reset all

When **Reset** is selected, the camera's settings will be restored to their default values.

Pop-up Menu

Option	Default value
Flash mode (📖30)	Auto
Self-timer (📖32)	OFF
Macro mode (📖33)	OFF
Exposure compensation (📖34)	0.0

Shooting in the Scene Mode

Option	Default value
Scene setting for shooting mode (📖35)	Scene auto selector
White balance setting in food mode (📖44)	Center

Smile Menu

Option	Default value
Blink proof (📖49)	On

Subject Tracking Menu

Option	Default value
Autofocus mode (📖51)	Full-time AF

Movie Menu

Option	Default value
Movie options (📖69)	TV movie 640
Autofocus mode (📖69)	Single AF

Shooting Menu

Option	Default value
Image mode (📖90)	 Normal (4000)
White balance (📖92)	Auto
Metering (📖94)	Matrix
Continuous (📖95)	Single
ISO sensitivity (📖97)	Auto
Color options (📖98)	Standard color
AF area mode (📖99)	Auto
Autofocus mode (📖102)	Single AF

Setup Menu

Option	Default value
Menus (📖112)	Text
Welcome screen (📖113)	None
Photo info (📖117)	Auto info
Brightness (📖117)	3
Date imprint (📖118)	Off
Vibration reduction (📖119)	On
Motion detection (📖120)	Auto
AF assist (📖121)	Auto
Digital zoom (📖121)	On
Button sound (📖122)	On
Shutter sound (📖122)	On
Auto off (📖122)	1 min
Blink warning (📖125)	Off

Others

Option	Default value
Paper size (📖83, 84)	Default
Slide show (📖106)	3 s
Monitor brightness boost (📖23)	Off

- Choosing **Reset all** also clears the current file number (📖131) from the memory. Numbering will continue from the lowest number available. To reset file numbering to "0001", delete all pictures (📖107) before selecting **Reset all**.
- The following menu settings will remain unaffected when menus are reset with **Reset all**.

Shooting menu:

Preset manual data (📖93) acquired for **White balance**

Setup menu:

Date (📖114), **Language** (📖124), and **Video mode** (📖124)

Ver. Firmware Version

Press the MENU button → **Y** (Setup menu) (📖111) → **Ver.** Firmware version

View the current camera firmware version.

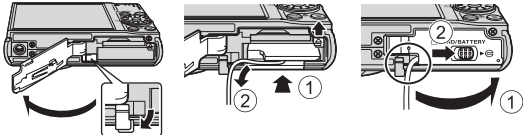

Optional Accessories

Rechargeable battery	Rechargeable Li-ion Battery EN-EL12
Battery charger	Battery Charger MH-65
AC adapter	<p>AC Adapter EH-62F (connect as shown)</p>  <p>Insert the AC adapter cord into the groove deeply in the battery chamber before closing the battery-chamber/memory card slot cover. If part of the cord runs out of the groove, the cover or cord may be damaged when the cover is closed.</p>
USB cable	USB Cable UC-E6
A/V cable	Audio Video Cable EG-CP14

Approved Memory Cards

The following Secure Digital (SD) memory cards have been tested and approved for use in this camera.

- All cards of the designated make and capacity can be used, regardless of speed.

SanDisk	512 MB, 1 GB, 2 GB ¹ , 4 GB ² , 8 GB ² , 16 GB ²
TOSHIBA	512 MB, 1 GB, 2 GB ¹ , 4 GB ² , 8 GB ² , 16 GB ²
Panasonic	512 MB, 1 GB, 2 GB ¹ , 4 GB ² , 8 GB ² , 16 GB ²
Lexar	1 GB, 2 GB ¹ , 4 GB ² , 8 GB ²

1 If the memory card will be used with a card reader or similar device, check that device supports 2 GB cards.

2  SDHC-compliant. If the memory card will be used with a card reader or similar device, check that device supports SDHC.

Operation is not guaranteed with other makes of card. Contact the manufacturer for details on the above cards.

Refer to the Nikon website for the latest information on approved cards.

File and Folder Names

Pictures, movies, voice memos, and voice recordings are assigned file names as follows.

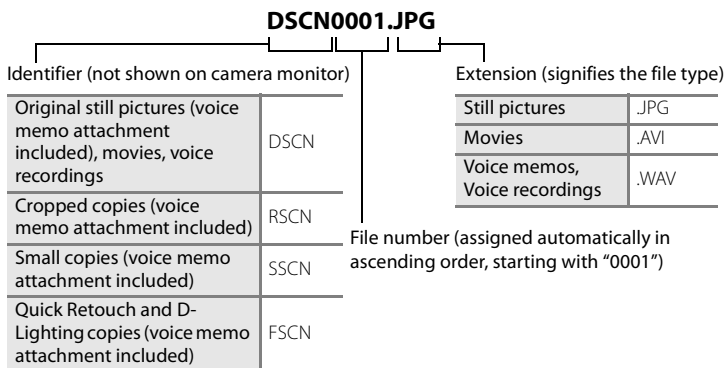

- Files are stored in folders named with a folder number followed by a five-character identifier: "P_" plus a three-digit sequence number for pictures shot using **Panorama assist** (e.g. "101P_001"; 📖46), "INTVL" for interval timer photography (e.g. "101INTVL"; 📖96), "SOUND" for voice recordings (e.g. "101SOUND"; 📖71), and "NIKON" for all other pictures (e.g. "100NIKON"). When the number of files within a folder reaches 9999, a new folder will be created. File numbers will be assigned automatically starting with "0001."
- Voice memo file names have the same identifier and file number as the picture to which the voice memo is attached.
- Files copied using **Copy** → **Selected images** or **Copy sound files** → **Selected files** are copied to the current folder, where they are assigned new file numbers in ascending order starting from the largest file number in memory. **Copy** → **All images** and **Copy sound files** → **Copy all files** copy all folders from the source medium; file names do not change but new folder numbers are assigned in ascending order, starting from the largest folder number on the destination medium (📖75, 109).
- A single folder can hold up to 200 pictures; if the current folder already contains 200 pictures, a new folder, named by adding one to the current folder name, will be created the next time a picture is taken. If the current folder is numbered 999 and contains 200 pictures, or a picture is numbered 9999, no further pictures can be taken until the internal memory or memory card is formatted (📖123), or a new memory card is inserted.

Caring for the Camera

To ensure continued enjoyment of this Nikon product, observe the following precautions when using or storing the device.

Keep dry

The device will be damaged if immersed in water or subjected to high humidity.

Do not drop

The product may malfunction if subjected to strong shock or vibration.

Handle the lens and all moving parts with care

Do not apply force to the lens, lens cover, monitor, memory card slot or battery chamber. These parts are easily damaged. Applying force to the lens cover could result in camera malfunction or damage to the lens. Should the monitor break, care should be taken to avoid injury caused by broken glass and to prevent the liquid crystal from the display touching the skin or entering the eyes or mouth.

Do not point the lens at strong light sources for extended periods

Avoid pointing the lens at the sun or other strong light sources for extended periods when using or storing the camera. Intense light may cause deterioration of the CCD image sensor, producing a white blur effect in photographs.

Keep away from strong magnetic fields

Do not use or store this device in the vicinity of equipment that generates strong electromagnetic radiation or magnetic fields. Strong static charges or the magnetic fields produced by equipment such as radio transmitters could interfere with the monitor, damage data stored on the memory card, or affect the product's internal circuitry.

Avoid sudden changes in temperature

Sudden changes in temperature, such as when entering or leaving a heated building on a cold day, can cause condensation to form inside the device. To prevent condensation, place the device in a carrying case or a plastic bag before exposing it to sudden changes in temperature.

Turn the product off before removing or disconnecting the power source

Do not remove the battery while the product is on, or while images are being recorded or deleted. Forcibly cutting power in these circumstances could result in loss of data or in damage to product memory or internal circuitry.

 **The Battery**

- Check the battery level when taking the camera out, and charge the battery if necessary. Do not continue charging once the battery is fully charged, as this will result in reduced battery performance. If possible, carry a fully-charged spare battery when taking pictures on important occasions.
- Do not use the battery at ambient temperatures below 0 °C (32 °F) or above 40 °C (104 °F). Failure to observe this precaution could damage the battery or impair its performance.
- Charge indoors at an ambient temperature between 5 and 35 °C (41 to 95 °F). When the battery temperature is between 0 and 10 °C (32 to 50 °F) or 45 to 60 °C (113 to 140 °F), the chargeable capacity may decrease. The battery will not charge if its temperature is below 0 °C (32 °F) or above 60 °C (140 °F).
- If an exhausted battery is used at a low temperature, the camera may not turn on. Be sure that the battery is fully charged and spare batteries are prepared before heading outside to take pictures in cold weather. Keep spare batteries in a warm place and exchange as necessary. Once warmed, a cold battery that could not be used temporarily due to lowered performance may recover some of its charge.
- Should the battery terminals become dirty, the camera may not turn on due to poor contact. Wipe the terminals off with a clean, dry cloth before use.
- If the battery will not be used for some time, insert it in the camera and run it flat before removing it for storage. Attach the included terminal cover to the battery and store it in a cool location with an ambient temperature of 15 to 25 °C (59 to 77 °F). Do not store the battery in hot or extremely cold locations.
- While the battery is in storage, charge it at least once every six months and then use the camera to run it flat again before storing it in a cool location.
- Always remove the battery from the camera or battery charger when it is not being used. Left installed, minute amounts of current flow even when unused, and the battery may become excessively drained and no longer function.
- A marked drop in the time a fully-charged battery retains its charge, when used at room temperature, indicates that the battery needs to be replaced. Purchase a new battery.
- Replace the battery when it no longer holds a charge. Used batteries are a valuable resource. Please recycle used batteries in accordance with local regulations.

Cleaning

Lens	Avoid touching glass parts with your fingers. Remove dust or lint with a blower (typically a small device with a rubber bulb attached to one end that is pumped to produce a stream of air out the other end). To remove fingerprints or other stains that cannot be removed with a blower, wipe the lens with a soft cloth, using a spiral motion that starts at the center of the lens and working toward the edges. If this fails, clean the lens using a cloth lightly dampened with commercial lens cleaner.
Monitor	Remove dust or lint with a blower. To remove fingerprints and other stains, clean the monitor with a soft, dry cloth, being careful not to apply pressure.
Body	Use a blower to remove dust, dirt or sand, then wipe gently with a soft, dry cloth. After using the camera at the beach or seaside, wipe off any sand or salt with a dry cloth lightly dampened with fresh water, then dry thoroughly. Note that foreign matter inside the camera could cause damage not covered by the warranty.

Do not use alcohol, thinner, or other volatile chemicals.

Storage

Turn the camera off when not in use. Check that the power-on lamp is off before putting the camera away. Remove the battery if the camera will not be used for an extended period. Do not store the camera with naphtha or camphor moth balls, or in any of the following locations:

- Next to equipment that produces strong electromagnetic fields, such as televisions or radios
- Exposed to temperatures below -10 °C (14 °F) or above 50 °C (122 °F)
- Poorly ventilated or subject to humidities of over 60 %

To prevent mold or mildew, take the camera out of storage at least once a month. Turn the camera on and release the shutter a few times before putting the camera away again.



Notes on the Monitor

- The monitor may contain a few pixels that are always lit or that do not light. This is a characteristic common to all TFT LCD displays, and does not indicate a malfunction. Images recorded using the product will not be affected.
- Images in the monitor may be difficult to see under bright lighting.
- The monitor is lit by an LED backlight. Should the monitor begin to dim or flicker, contact your Nikon-authorized service representative.



Notes on Smear













When framing bright subjects, vertical comet-like streaks that whiten toward either end may appear in the display. This phenomenon, known as “smear”, does not indicate a malfunction.







In shooting modes other than multi-shot 16 or movie, smear has no effect on the images that are recorded.

When using the multi-shot 16 shooting and movie modes, however, we recommend that you avoid shooting bright objects.



Error Messages













The following table lists the error messages and other warnings displayed in the monitor, as well as the solutions for dealing with them.

Display	Problem	Solution	
 (blinks)	Clock not set.	Set clock.	114
	Battery is running low.	Prepare to charge or change battery.	14, 16
 Battery exhausted.	Battery exhausted.	Charge or replace battery.	14, 16
 Battery temperature high	Battery temperature is high.	Turn off camera, and allow battery to cool down before resuming use. After five seconds, this message will disappear, the monitor will turn off, and the power-on lamp will blink rapidly. After the lamp blinks for three minutes, the camera will turn off automatically, but you can also press the power switch to turn it off manually.	17
 (blinks red)	Camera cannot focus.	<ul style="list-style-type: none"> • Refocus. • Use focus lock. 	26, 27 100
 Please wait for the camera to finish recording.	Camera cannot perform other operations until recording is complete.	Wait until message clears from display automatically when recording is complete.	27, 68
 Memory card is write protected.	Write-protect switch is in "lock" position.	Slide the write-protect switch to "write" position.	21
 This card cannot be used.	Error accessing memory card.	<ul style="list-style-type: none"> • Use an approved card. • Check that connectors are clean. • Confirm that memory card is correctly inserted. 	130 20 20
 This card cannot be read.			
 Card is not formatted. Format card? No Yes	Memory card has not been formatted for use in this camera.	Choose Yes and press the  button to format memory card.	21
 Out of memory.	Memory card is full.	<ul style="list-style-type: none"> • Choose smaller image mode. • Delete pictures or sound files. • Replace memory card. • Remove memory card and use internal memory. 	90 28, 70, 74, 107 20 20

Display	Problem	Solution	
 Image cannot be saved.	Error occurred while recording picture.	Format internal memory or memory card.	123
	Camera has run out of file numbers.	<ul style="list-style-type: none"> Replace memory card. Format internal memory or memory card. 	20 123
	Picture cannot be used for welcome screen.	Choose a picture taken at an Image mode setting of BS 16:9 (1920) , and copies created at a size of 320 × 240 or smaller using the crop or small picture function, cannot be used.	58, 59, 90
	There is insufficient space to save a copy.	Delete pictures from destination.	107
 Sound file cannot be saved.	Camera has run out of file numbers.	<ul style="list-style-type: none"> Replace memory card. Format internal memory or memory card. 	20 123
	The image file cannot have any voice memos attached to it.	<ul style="list-style-type: none"> Choose an image that was taken using this camera. Voice memos cannot be attached onto movies. 	60 –
 One or more subjects may have closed their eyes.	An image that has blinking subjects detected in it was saved.	Check results in playback mode.	28, 49
 Image cannot be modified.	Cannot edit selected picture.	<ul style="list-style-type: none"> Select picture that supports quick retouch, D-Lighting, crop or small picture. These options cannot be used with movies. 	55 –
 Cannot record movie.	Time out error while recording movie.	Choose memory card with faster write speed.	130

Error Messages

Display	Problem	Solution	
i Memory contains no images.	No pictures in the internal memory or memory card.	To copy image or sound files from internal memory to memory card, press the MENU button. Copy will be displayed.	109
	No pictures are contained in the folder selected in the auto sort mode.	Select a folder containing the sorted pictures.	66
	No pictures can be played back in the auto sort mode.	Play back the pictures using the playback mode or the list by date mode.	28, 62
i No sound file.	There are no sound files to be copied.	Check that the correct copy option has been selected.	75
i File contains no image data. ! This file cannot be played back.	File not created with this camera.	File cannot be viewed on this camera. View file using the computer or any other devices which was used to create or edit this file.	-
i All images are hidden.	The picture cannot be played back in a slide show.	-	106
i This image cannot be deleted.	Picture is protected.	Disable protection.	107
i Travel destination is in the current time zone.	Destination in same time zone as home.	-	116
Lens error !	Lens error.	Turn camera off and then on again. If error persists, contact retailer or Nikon-authorized service representative.	17
! Communications error	USB cable disconnected during printing.	Turn camera off and reconnect cable.	82
System error !	Error has occurred in camera's internal circuitry.	Turn camera off, remove and reinsert battery, and turn camera on. If error persists, contact retailer or Nikon-authorized service representative.	16, 17
! Printer error: check printer status.	Printer error.	Check printer. After solving the problem, select Resume and press the  button to resume printing.*	-

Display	Problem	Solution	
 Printer error: check paper	Specified size of paper is not loaded in printer.	Load the specified type of paper, select Resume and press the  button to resume printing.*	-
 Printer error: paper jam	Paper has jammed in the printer.	Remove the jammed paper, select Resume and press the  button to resume printing.*	-
 Printer error: out of paper	No paper is loaded in the printer.	Load the specified type of paper, select Resume and press the  button to resume printing.*	-
 Printer error: check ink	Ink error.	Check ink, select Resume and press the  button to resume printing.*	-
 Printer error: out of ink	Ink cartridge is empty.	Replace ink, select Resume and press the  button to resume printing.*	-
 Printer error: file corrupt	An error caused by the image file has occurred.	Select Cancel and press the  button to cancel printing.	-

* See the documentation provided with your printer for further guidance and information.

Troubleshooting

If the camera fails to function as expected, check the list of common problems below before consulting your retailer or Nikon-authorized service representative. Refer to the page numbers in the right-most column for more information.





Display, Settings and Power Supply

Problem	Cause/Solution	
Monitor is blank.	<ul style="list-style-type: none"> • Camera is off. • Battery is exhausted. • Standby mode for saving power: press the power switch or the shutter-release button. • When flash lamp blinks red, flash is charging. Wait until charging has finished. • Camera and computer are connected via USB cable. • Camera and TV are connected via audio/video cable. • Interval timer photography in progress. 	17 22 13, 17 31 77 76 96
Monitor is hard to read.	<ul style="list-style-type: none"> • Adjust monitor brightness. • Monitor is dirty. Clean monitor. • Use monitor brightness boost. 	117 132 23
Camera turns off without warning.	<ul style="list-style-type: none"> • Battery is exhausted. • Camera has turned off automatically to save power. • Battery is cold. 	22 122 133
Date and time of recording are not correct.	<ul style="list-style-type: none"> • Pictures recorded before clock was set, and “Date not set” indicator blinks during shooting, will have time stamp of “00/00/0000 00:00”; movies and voice recordings will be dated “01/01/09 00:00.” Set the correct date and time using Date in the setup menu. • Check camera clock regularly against more accurate timepieces and reset as required. 	18, 114 114
No information displayed in monitor.	Hide info is selected for Photo info of the Monitor settings option in the setup menu.	117
Date imprint not available.	Date has not been set.	18, 114
Date not appearing on pictures even when Date imprint is enabled.	The date is not imprinted on movies or on pictures taken in Panorama assist scene mode.	46, 68, 118
Camera settings reset.	Backup battery is exhausted; all settings were restored to their default values.	115
Monitor turns off, and the power-on lamp blinks rapidly.	Battery temperature is high. Turn off camera, and allow battery to cool down before resuming use. After the lamp blinks for three minutes, the camera will turn off automatically, but you can also press the power switch to turn it off manually.	17





Electronically Controlled Cameras



In extremely rare instances, unusual characters may appear in the monitor and the camera may stop functioning. In most cases, this phenomenon is caused by a strong external static charge. Turn the camera off, remove and replace the battery, then turn the camera on again. In the event of continued malfunction, contact your retailer or Nikon-authorized service representative. Note that disconnecting the power source as described above may result in the loss of any data not recorded to internal memory or the memory card at the time the problem occurred. Data already recorded will not be affected.

Shooting



Problem	Cause/Solution	
No picture taken when shutter-release button is pressed.	<ul style="list-style-type: none"> When camera is in playback mode, press the  button. When menus are displayed, press the MENU button. Battery is exhausted. When flash lamp blinks red, flash is charging. 	8, 28 12 22 31
Camera cannot focus.	<ul style="list-style-type: none"> The intended subject is one with which autofocus does not perform well. Set AF assist in the setup menu to Auto. Turn camera off and then on again. 	27 121 17
Pictures are blurred.	<ul style="list-style-type: none"> Use flash. Use vibration reduction and motion detection. Use BSS (Best Shot Selector). Use a tripod to stabilize the camera (use with the self-timer for best results). 	30 119, 120 95 32
Bright specks appear in pictures shot using flash.	Flash is reflecting off particles in air. Turn flash  (off).	31
Flash does not fire.	<ul style="list-style-type: none"> Flash is  (off). Some scene modes that cannot turn on flash are selected. The Blink proof setting is set to On for smile mode.  mode is selected. Continuous, BSS, or Multi-shot 16 is selected for Continuous in shooting menu. 	30 35 49 68 95
Optical zoom cannot be used.	Optical zoom cannot be used while recording movies.	68

Troubleshooting

Problem	Cause/Solution	
Digital zoom cannot be used.	<ul style="list-style-type: none"> • Digital zoom is set to Off in the setup menu. • Digital zoom cannot be used in the following situations. <ul style="list-style-type: none"> - When Scene auto selector, Portrait or Night portrait is selected for scene mode - When subject tracking mode is selected - When smile mode is selected - When Multi-shot 16 is selected for Continuous - Before movie recording begins (digital zoom of up to 2x can be applied while movies are being recorded) 	121 36, 37, 42 50 48 95 68
Image mode not available.	Image mode cannot be adjusted when Multi-shot 16 is selected for Continuous .	95
No sound when shutter is released.	<ul style="list-style-type: none"> • Off is selected for Shutter sound of the Sound settings option in the setup menu. • Continuous, BSS, or Multi-shot 16 is selected for Continuous in shooting menu. • When Sports, or Museum is selected in scene mode. • The Blink proof setting is set to On for smile mode. •  mode is selected. • Do not block the speaker. 	122 95 37, 40 49 68 4, 24
AF-assist illuminator does not light.	<ul style="list-style-type: none"> • Off is selected for AF assist in the setup menu. • AF-assist illuminator turns off automatically in some scene modes. 	121 36 – 41
Pictures appear smeared.	Lens is dirty. Clean lens.	132
Colors are unnatural.	White balance does not match light source.	92
Randomly spaced bright pixels ("noise") appear in image.	<p>The subject is dark, so shutter speed is too slow or ISO sensitivity is too high. Noise can be reduced by:</p> <ul style="list-style-type: none"> • Use flash. • Specifying a lower ISO sensitivity setting. • Using a scene mode which has noise reduction ability. 	30 97 36
Pictures are too dark (underexposed).	<ul style="list-style-type: none"> • Flash is  (off). • Flash window is blocked. • Subject is beyond flash range. • Adjust exposure compensation. • Raise the ISO sensitivity. • Subject is backlit. Use Backlight or change the flash mode to  (fill flash). 	30 24 30 34 97 30, 41
Pictures are too bright (overexposed).	Adjust exposure compensation.	34

Problem	Cause/Solution	
Unexpected results occurred when flash is set to auto with red-eye reduction.	When  (auto with red-eye reduction) or “fill flash with slow sync and red-eye reduction” of the Night portrait scene mode is applied during shooting, In-Camera Red-Eye Fix may, in very rare cases, be applied to areas not affected by red-eye. Set a flash mode other than  (auto with red-eye reduction) and select a scene mode other than Night portrait , then shoot.	30, 37

Playback

Problem	Cause/Solution	
File cannot be played back.	<ul style="list-style-type: none"> • File was overwritten or renamed by computer or another make or model of camera. • Interval timer photography in progress. 	– 96
Cannot zoom in on picture.	Playback zoom cannot be used with movies, small pictures, or cropped copies smaller than 320 × 240 pixels.	–
Cannot record voice memo.	<ul style="list-style-type: none"> • Voice memos cannot be attached to movies. • Voice memos cannot be attached to pictures taken by other cameras. Voice memos that are attached to the picture using other cameras cannot be played back on this camera. 	70 60
Cannot use Quick retouch, D-Lighting, crop, or small picture options	<ul style="list-style-type: none"> • These options cannot be used with movies. • These options cannot be used with pictures taken when  16:9 (1920) is applied in the Image mode setting. • Select picture that supports quick retouch, D-Lighting, crop or small picture. • Pictures taken with another make or model of camera cannot be edited. • Other cameras may be unable to play back, or transfer to a computer, pictures edited with this camera. 	70 90 55 – –
Pictures not displayed on television.	<ul style="list-style-type: none"> • The Video mode setting in setup menu has not been set correctly. • Memory card contains no pictures. Replace memory card. Remove memory card to play back pictures from internal memory. 	124 20

Troubleshooting

Problem	Cause/Solution	
<p>The recorded pictures are not displayed in auto sort mode.</p>	<ul style="list-style-type: none"> • The picture you want to display is sorted in another folder. • Pictures or movies recorded by another camera, and pictures copied using Copy on another camera cannot be displayed in the auto sort mode. • Pictures in the internal memory or memory card may not be displayed if overwritten on a computer. • Up to 999 images can be added to each folder in the auto sort mode. If the desired folder already contains 999 pictures, new pictures cannot be added. 	<p>65 109</p> <p>–</p> <p>66</p>
<p>Nikon Transfer does not start when camera is connected.</p>	<ul style="list-style-type: none"> • Camera is off. • Battery is exhausted. • USB cable is not correctly connected. • Camera is not recognized by the computer. • Confirm that the operating system used is compatible with the camera. • Computer is not set to launch Nikon Transfer automatically. <p>For more information on Nikon Transfer, refer to help information contained in Nikon Transfer.</p>	<p>17 22 78 – 77 –</p>
<p>Pictures to be printed are not displayed.</p>	<p>Memory card contains no pictures. Replace memory card. Remove memory card to print pictures from internal memory.</p>	<p>20</p>
<p>Cannot select paper size with camera.</p>	<p>Paper size cannot be selected from the camera in the following situations, even for PictBridge compatible printers. Use the printer to select page size.</p> <ul style="list-style-type: none"> • The page size selected using the camera is not compatible with the printer. • A printer that automatically sets the paper size is being used. 	<p>83, 84</p> <p>–</p>

Specifications

Nikon COOLPIX S620 Digital Camera

Type	Compact digital camera
Effective pixels	12.2 million
Image sensor	¹ / ₂ .233-in. CCD; total pixels: approx. 12.39 million
Lens	4x optical zoom, NIKKOR lens
Focal length	5.0-20.0mm (equivalent with 35mm [135] format picture angle: 28-112mm)
f/-number	f/2.7-5.8
Construction	7 elements in 6 groups
Digital zoom	Up to 4x (equivalent with 35mm [135] format picture angle: approx. 448mm)
Vibration reduction	Lens shift
Autofocus (AF)	Contrast-detect AF
Focus range (from lens)	<ul style="list-style-type: none">• [W]: Approx. 50 cm (1 ft. 8 in.) to ∞, [T]: Approx. 60 cm (2 ft.) to ∞• Macro mode: Approx. 2 cm (0.8 in.) to ∞ (when the zoom is zoomed out)
Focus-area selection	Face priority, auto (9-area automatic selection), manual with 99 focus areas, center
Monitor	2.7-in., approx. 230k-dot, wide viewing angle TFT LCD with anti-reflection coating and 5-level brightness adjustment (equipped with monitor brightness boost function)
Frame coverage (shooting mode)	Approx. 100 % horizontal and 100 % vertical
Frame coverage (playback mode)	Approx. 100 % horizontal and 100 % vertical
Storage	
Media	Internal memory (approx. 45 MB), SD (Secure Digital) memory cards
File system	DCF, Exif 2.2, and DPOF compliant
File formats	Compressed: JPEG-Baseline compliant Movies: AVI Sound files: WAV
Image size (pixels)	<ul style="list-style-type: none">• 4000×3000 High (4000★)/Normal (4000)• 3264×2448 Normal (3264)• 2592×1944 Normal (2592)• 2048×1536 Normal (2048)• 1024×768 PC screen (1024)• 640×480 TV screen (640)• 1920×1080 16:9 (1920)
ISO sensitivity (Standard output sensitivity)	<ul style="list-style-type: none">• ISO 100, 200, 400, 800, 1600, 3200, 6400• Auto (auto gain from ISO 100 to 1600)• Fixed range auto (ISO 100 to 400, 100 to 800)

Specifications

Exposure	
Metering	224-segment matrix, center-weighted
Exposure control	Programmed auto exposure with motion detection and exposure compensation (-2.0 to +2.0 EV in steps of $\frac{1}{3}$ EV)
Range (ISO 100)	[W]: -1 to +15.5 EV [T]: 1.2 to 17.7 EV
Shutter	Mechanical and charge-coupled electronic shutter
Speed	<ul style="list-style-type: none">• $\frac{1}{1500}$-1 s (when ISO sensitivity is set to Auto)• $\frac{1}{1500}$-8 s (when ISO sensitivity is locked)• 4 s (Fireworks show scene mode)
Aperture	Electronically-controlled ND filter (-2 AV) selection
Range	2 steps (f/2.7 and f/5.4 [W])
Self-timer	Can be selected from 10 and 2 seconds duration
Built-in flash	
Range (approx.) (ISO sensitivity: Auto)	[W]: 0.5 to 8.0 m (1 ft. 8 in. to 26 ft.) [T]: 0.5 to 3.5 m (1 ft. 8 in. to 11 ft.)
Flash control	TTL auto flash with monitor preflashes
Interface	Hi-Speed USB
Data transfer protocol	MTP, PTP
Video output	Can be selected from NTSC and PAL
I/O terminal	Audio video output/digital I/O
Supported languages	Arabic, Chinese (Simplified and Traditional), Czech, Danish, Dutch, English, Finnish, French, German, Greek, Hungarian, Indonesian, Italian, Japanese, Korean, Norwegian, Polish, Portuguese, Russian, Spanish, Swedish, Thai, Turkish
Power sources	One Rechargeable Li-ion Battery EN-EL12 (supplied) AC Adapter EH-62F (optional)
Battery life*	Approx. 250 shots (EN-EL12)
Dimensions (W × H × D)	Approx. 90 × 53 × 23 mm (3.5 × 2.1 × 0.9 in.) (excluding projections)
Weight	Approx. 120 g (4.2 oz) (without battery and SD memory card)
Operating environment	
Temperature	0 to 40 °C (32 to 104 °F)
Humidity	Less than 85 % (no condensation)

- Unless otherwise stated, all figures are for a camera with a fully-charged Rechargeable Li-ion Battery EN-EL12 operated at an ambient temperature of 25 °C (77 °F).
- * Based on Camera and Imaging Products Association (CIPA) standards for measuring the life of camera batteries. Measured at 23 (±2) °C (73 (±4) °F); zoom adjusted with each shot, flash fired with every other shot, image mode set to **Normal (4000)**. Battery life may vary depending on shooting interval and length of time menus and images are displayed.

Rechargeable Li-ion Battery EN-EL12

Type	Rechargeable lithium-ion battery
Rated capacity	DC 3.7 V, 1050 mAh
Operating temperature	0 to 40 °C (32 to 104 °F)
Dimensions (W × H × D)	Approx. 32 × 43.8 × 7.9 mm (1.3 × 1.7 × 0.3 in.)
Weight	Approx. 22.5 g (0.8 oz) (excluding terminal cover)

Battery Charger MH-65

Rated input	AC 100-240 V, 50/60 Hz, 0.08-0.05 A
Rated capacity	8–12 VA
Rated output	DC 4.2 V, 0.7 A
Applicable batteries	Nikon Rechargeable Li-ion Battery EN-EL12
Charging time	Approx. 150 minutes when no charge remains
Operating temperature	0 to 40 °C (32 to 104 °F)
Dimensions (W × H × D)	Approx. 58 × 27.5 × 80 mm (2.3 × 1.1 × 3.1 in.) (excluding power cable)
Length of power cable	Approx. 1.8 m (6 ft.)
Weight	Approx. 70 g (2.5 oz) (excluding power cable)

Specifications























- Nikon will not be held liable for any errors this manual may contain.
- The appearance of this product and its specifications are subject to change without notice.





Supported Standards

- **DCF:** Design Rule for Camera File System is a standard widely used in the digital camera industry to ensure compatibility among different makes of camera.
- **DPOF:** Digital Print Order Format is an industry-wide standard that allows pictures to be printed from print orders stored on the memory card.
- **Exif version 2.2:** This camera supports Exif (Exchangeable Image File Format for Digital Still Cameras) version 2.2, a standard that allows information stored with photographs to be used for optimal color reproduction when images are output from Exif-compliant printers.
- **PictBridge:** A standard developed cooperatively by the digital camera and printer industries, allowing photographs to be output directly to a printer without connecting the camera to a computer.



Index

Symbols

-  AE/AF-L 47
-  Apply selection button 10
-  Auto mode 22
-  Auto sort mode 65
-  Delete button 28, 29, 61, 70, 74
-  Exposure compensation 34
-  Flash mode 30
-  Help 13
-  List by date mode 62
-  Macro mode 33
- MENU** Menu button 12
-  Movie mode 68
-  Playback button 9, 28
-  Playback mode 28
-  Playback zoom 54
-  Scene mode 35
-  Self timer 32
-  Setup menu 110
-  Shooting mode button 8
-  Smile mode 48
-  Subject tracking mode 50
- T** Tele 25
-  Thumbnail Playback 52, 53
- W** Wide 25
- .AVI 131
- .JPG 131
- .WAV 131
- A**
- AC adapter 130
- AF area mode 99
- AF assist 121
- Aperture 26
- Audio/video cable 76, 130
- Audio/video-in jack 76
- Auto 30
- Auto mode 22
- Auto off 122
- Auto sort mode 65
- Autofocus 33, 51, 69, 102
- Autofocus mode 51, 69, 102
- AV cable 76, 130
- B**
- Backlight  41

- Battery 14, 16, 115
- Battery chamber 5
- Battery charger 14, 130
- Battery latch 16
- Battery level indicator 22
- Battery-chamber/memory card slot cover 16, 20
- Beach/snow  38
- Best shot selector 95
- Blink reduction 49
- Blink warning 125, 126
- BSS 95
- Built-in flash 30
- Button sound 122
- C**
- Cable connector 76, 77, 81
- Calendar display 53
- Center-weighted 94
- Charger 14, 130
- Close-up  39
- Color options 98
- Compression ratio 90
- Computer 77
- Connector cover 5
- Continuous 95
- Copy  40
- Crop 58
- D**
- Date 18, 114
- Date imprint 118
- Daylight saving time 18, 115
- Delete 28, 61, 70, 74, 107
- Digital zoom 25, 121
- D-Lighting 57
- DPOF 148
- DPOF print 86
- DSCN 131
- Dusk/dawn  38
- E**
- EN-EL12 14
- Exposure compensation 34
- Extension 131
- Eyelet for camera strap 5

E

- Face priority 99
- File name 131
- Fill flash 30
- Fireworks show  40
- Firmware version 129
- Fixed range auto 97
- Flash lamp 31
- Flash mode 30, 31
- Flash off 30
- Focus 26, 69, 99
- Focus indicator 6, 26
- Focus lock 100
- Folder name 131
- Food  39, 44
- Format 21, 123
- Format the internal memory 123
- Formatting 21, 123
- FSCN 131
- Full-frame playback 28, 29
- Full-time AF 69, 102

H

- Help 13
- Histogram 10, 34

I

- Identifier 131
- Image copy 109
- Image mode 90, 91
- Image size 90
- Internal memory 20
- Internal memory indicator 23
- Interval Timer Shooting 96
- ISO sensitivity 31, 97

L

- Lamp indicator 5, 71
- Landscape  36
- Language 124
- Lens 4, 145
- Lens cover 4
- Li-ion rechargeable battery 16
- List by date menu 64
- List by date mode 62
- Lithium-ion type battery 14, 130

M

- Macro mode 33
- Matrix 94
- Memory capacity 22
- Memory card 20, 130
- Memory card slot 20
- Menus 112
- Metering 94
- Microphone 4
- Monitor 6, 134
- Monitor brightness 117
- Monitor brightness boost 23
- Monitor display settings 117
- Monitor settings 117
- Motion detection 23, 120
- Movie length 69
- Movie menu 69
- Movie mode 68
- Movie playback 70
- Movie recording 68
- Movie settings 69
- Multi-shot 16 95
- Museum  40



N

- Night landscape  39
- Night portrait  37
- Nikon Transfer 77, 78
- Number of exposures remaining 22, 91

O

- Optical zoom 25
- Optional accessories 130



P

- Panorama assist  41, 46
- Panorama Maker 77, 80
- Paper size 83, 84
- Party/indoor  37
- PictBridge 81, 148
- Playback 28, 52, 53, 54, 61, 70, 73
- Playback menu 104
- Playback mode 28
- Playback zoom 54
- Playback-mode selection menu 9
- Portrait  36
- Power 17, 18, 22

Power switch 17, 18, 22
Preset manual 93
Press halfway 13
Print 83, 84, 87
Print set 87
Print Set Date Option 88
Printer 81
Protect 107

Q
Quick retouch 56

R
Rechargeable battery 130
Red-eye reduction 30, 31
Reset all 127
Rotary multi selector 18
Rotate image 108
RSCN 131

S
Scene auto selector  36, 42
Scene mode 35, 36
Self-timer 32
Self-timer lamp 32, 48
Setup menu 110
Shooting 22, 24, 26
Shooting info 10
Shooting menu 89
Shooting with Face Priority 101
Shooting-mode selection menu 8
Shutter button 13, 26
Shutter sound 122
Shutter speed 26
Single 95
Single AF 69, 102
Slide show 106
Slow sync 30
Small picture 59
Small size 69
Smile mode 48
Sound files copy 75
Sound files playback 73
Sound settings 122
Speaker 4
Sports  37
SSCN 131

Strap 13
Subject tracking mode 50
Sunset  38

T

Tele 25
Television 76
Thumbnail display 52
Time difference 116
Time zone 114, 116
Tripod socket 5
TV Movie 69

U

USB cable 78, 82, 130

V

Vibration reduction 23, 119
Video mode 124
Voice memo 60
Voice recording  71
Volume 61, 70, 74

W

Welcome screen 113
White balance 92
Wide 25

Z

Zoom control 25

Nikon

No reproduction in any form of this manual, in whole or in part (except for brief quotation in critical articles or reviews), may be made without written authorization from NIKON CORPORATION.



NIKON CORPORATION

Fuji Bldg., 2-3 Marunouchi 3-chome,
Chiyoda-ku, Tokyo 100-8331, Japan

© 2009 Nikon Corporation

FX9A01(11)
6MM66711-01