

## 13. Quickly set up

This product is compatible for MIJIA intelligent platform, which can be controlled by "MIJIA" App; it is supported to MIUI system and can lined with other intelligent products of MIJIA

### 1. APP Download

Search for "MIJIA" in application store or scan the QR code below to download and install MIJIA APP



### 2. Add the device

Open "My Devices" in MIJIA APP, click the "+" at the top right corner of the page to add device, and this device can be found at the list of "My Devices" when the device is added successfully

### 3. Buy more

Please download MIJIA APP and login MIJIA Store to buy more intelligent products and high quality goods, or scan the QR code below to browse the page of MIJIA Store



The functions of actual product may not be conformed to the contents in the instructions totally due to technical upgrading and firmware updating.

In order to get the latest function introduction and safety use information, please visit corresponding section of MI community or Ninebot official BBS, and communicate with other users.

Online customer service: [www.mi.com/service](http://www.mi.com/service)

Service telephone: 400-100-5678

[www.mi.com](http://www.mi.com)

Version V.1.2

## Electric Scooter Instruction Manual



# Welcome to use our product

Thank you for choosing  MI electric scooter (hereinafter referred to as electric scooter), and the electric scooter is a kind of fashion sport recreational device.

## Contents

|   |    |
|---|----|
| 1. Product and accessories .....                                | 02 |
| 2. Functional schematic diagram .....                           | 03 |
| 3. Electric scooter body assembly .....                         | 04 |
| 4. Charger connection .....                                     | 05 |
| 5. Learn to ride .....  | 05 |
| 6. Safety tips .....  | 07 |
| 7. Folding and carrying .....                                   | 12 |
| 8. Daily care and maintenance .....                             | 13 |
| 9. Model parameter table .....                                  | 15 |
| 10. Name and content of harmful substances in the product ..... | 16 |
| 11. Trademark and legal statement .....                         | 16 |
| 12. Warranty policy .....                                       | 17 |

## 1. Product and accessories

The whole electric scooter

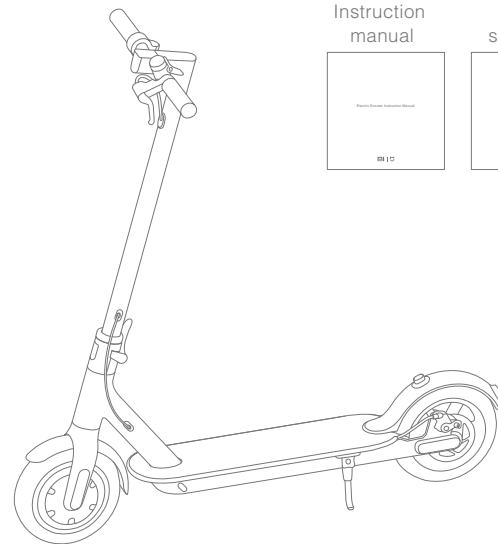

### Accessories



Please carefully check whether the goods in the packaging box are complete and under good conditions, and in case of any absence or damage and other problems, please visit after sales service page of MI [www.mi.com/service](http://www.mi.com/service) or call the service telephone of MI 400-100-5678 for consulting.

## 2. Functional schematic diagram

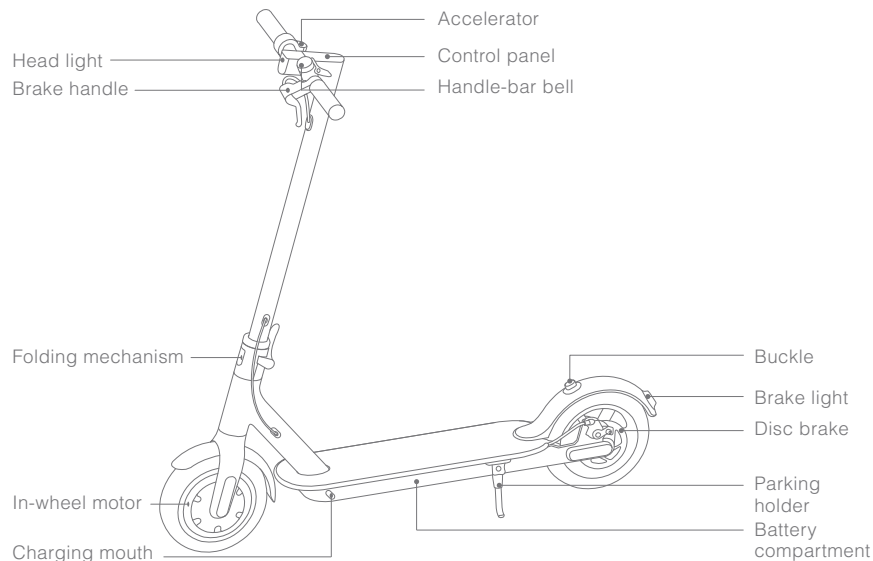

### Control panel

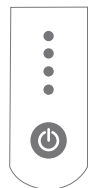

Power indicator:

there are four power indicator lights on the control panel to show the power of the battery. The power indicator lights will show the indicate status according to the sequence of normal light, flickering and quenching from up to down. When four lights are all on normally, the power is about 100% – 86%; if there are 3 lights on normally and only 1 light is flickering, the power is about 85% – 71%; and so forth, the flickering power indicator light will be quenching with the consuming of power. When the power indicator light at the bottom is flickering, it means that the power will be used up very soon, and please charge the electric scooter before using. When the power is used up, and the four lights are all quenching, the scooter will glide through inertia until the scooter is stopped naturally.

Mode indicator:

the power indicator light at the bottom has two colors, white and green. The light is white when the scooter is working under normal mode; the light is green when the scooter is under energy-saving mode. (Energy-saving mode: the maximum speed is 18km/h, and the accelerator is more smoothly, which is suitable for beginner to get familiar with riding.)

Power switch:

under shutdown status, pressing the switch shortly can start the scooter, and long time pressing the switch for 2s and more under power-on condition can close down the scooter. When the scooter is starting up, shortly press the switch once: start up/shut down the driving light; shortly press the switch continuously for twice: shift in the normal mode and energy-saving mode.

## 3. Electric scooter body assembly

1. Fasten the vertical tube of scooter and open the parking holder

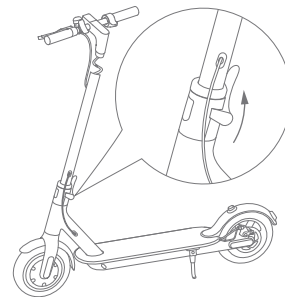

2. Install the horizontal handle on the vertical tube

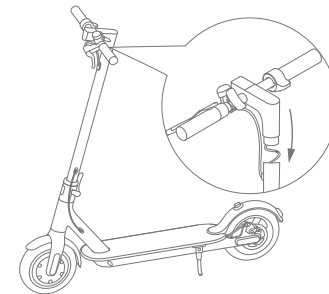

3. Use the hexagon wrench in the packaging box to lock the screws on both sides tightly

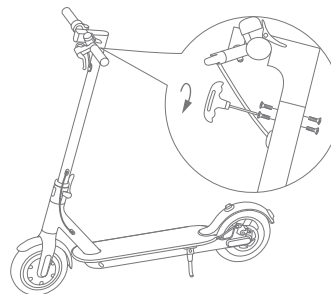

4. Carry on switch testing after the installation is finished

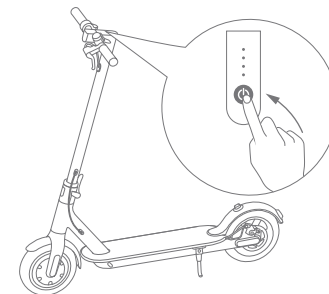

## 4. Charger connection

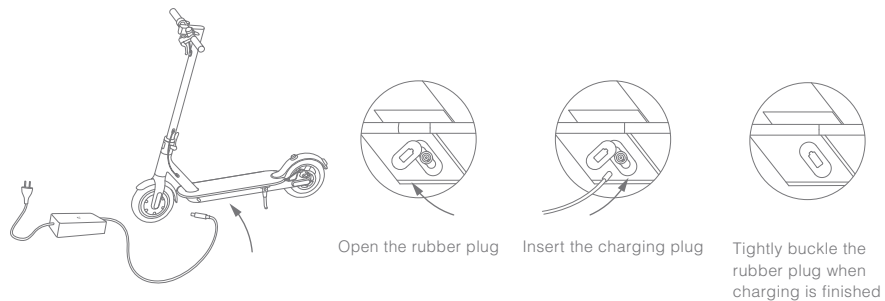

## 5. Learn to ride

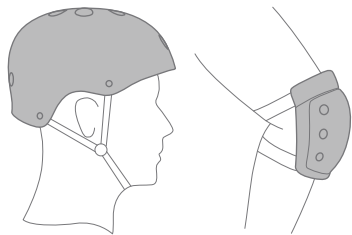

You may get hurt during the learning period, and please wear helmet and protectors all the way, as shown in the figure.

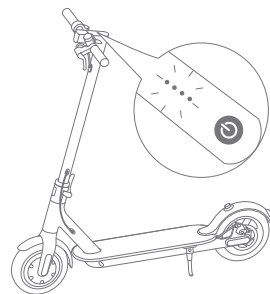

- 1 Start up the scooter and check the power indicator light

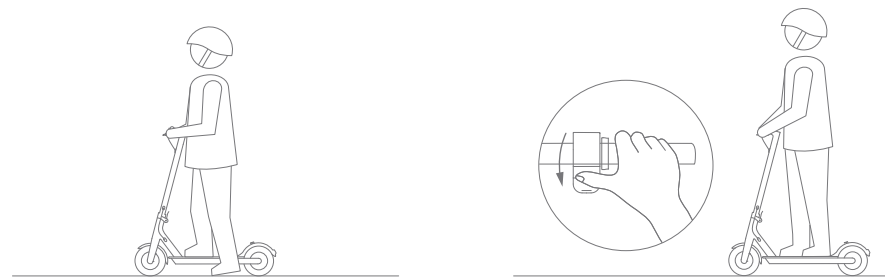

- 2 Stand on the pedal with one leg and use the other leg to thrust against the ground

- 3 Step on the pedal by both legs when the electric scooter is gliding on the ground, and slightly press the accelerator thumb shifter (the accelerator can be started when the speed is over 5km/h)

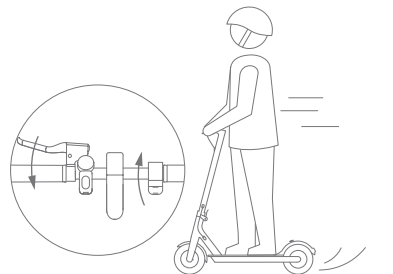

- 4 Loosen the accelerator thumb shifter for slow down, and energy recovery system will be started automatically for slowing down; vigorously hold the brake handle at the front left side of horizontal handle for emergency stopping

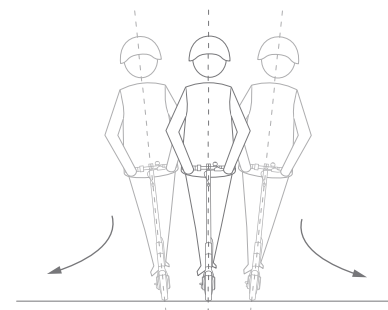

- 5 If you want to change the direction, slightly shift your body weight to the direction to be turned and slowly turn the handle

## 6. Safety tips

Please get rid of safety risks



 Avoid riding electric scooters in the rain



 Do not pass the deceleration strip, elevator threshold, cobbly road and other irregular roads in high speed. Keep middle or low speed (5-10km/h) when driving on rugged road. Bend your knees slightly for better adjusting the complex roads mentioned above

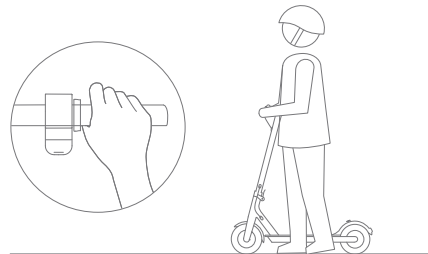

 Do not press accelerator thumb shifter when pushing the scooter for walking

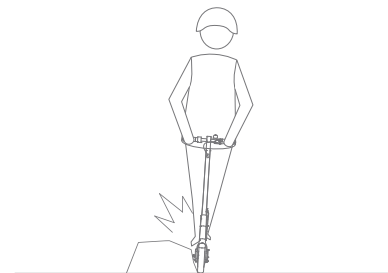

 Please avoid obstacles on road when riding the electric scooter

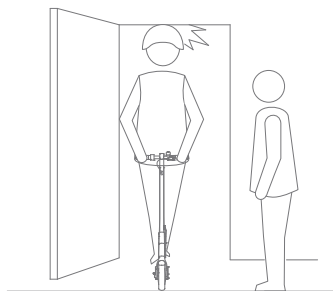

 Avoid knocking on door frame, elevator and other obstacles at high place

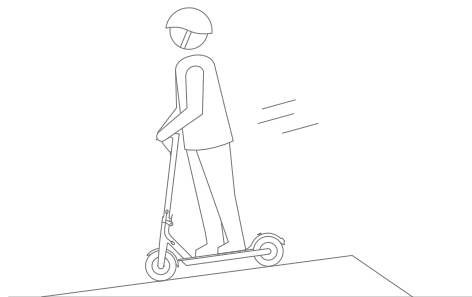

 Please do not speed up on downhill path

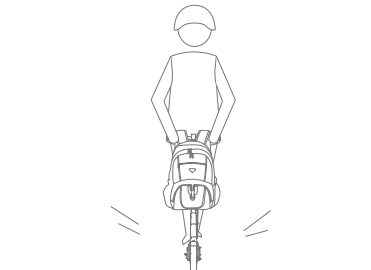

 Do not hang backpack or other heavy goods on the handle in front



 Do not step only one leg on the pedal when the scooter is running

Never try the following dangerous actions

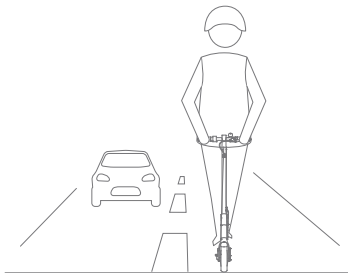

⊗ Prohibit riding electric scooters on motorway and residential district with persons and vehicles mixed

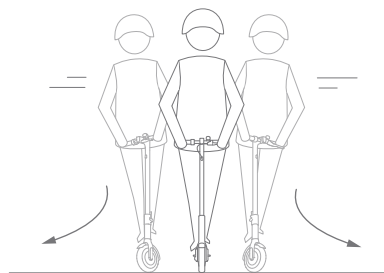

⊗ Prohibit turn the handle by a large scale under high speed driving



⊗ Prohibit stepping the end of mud guard

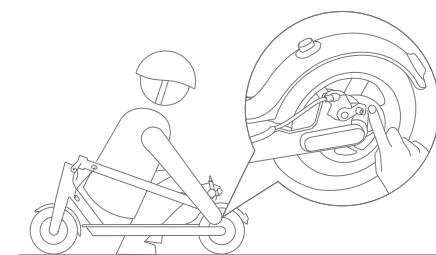

⊗ Prohibit touching disc brake



⊗ Prohibit riding electric scooters in the ponding that is higher than 2cm

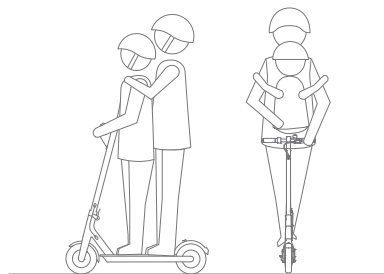

⊗ Prohibit riding an electric scooter by many person or riding an electric scooter with a child in hug



⊗ Prohibit driving electric scooters without hands holding on

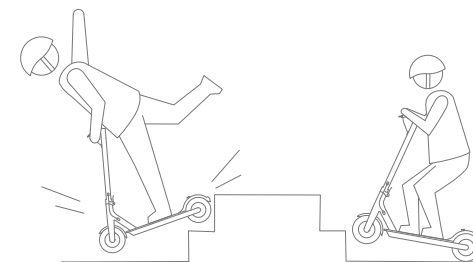

⊗ Prohibit riding electric scooters up and down the stairs or jumping obstacles

## Safety tips

- Electric scooter is a kind of sport recreational tool rather than vehicle, however, once the electric scooter is driven into public area, it will have the natures of vehicles and have the safety risks that all vehicles may have. Riding the electric scooter in strict accordance with the tips on this instruction manual can protect you and others from dangers at the most extent, and users should abide by the traffic rules and regulations made by the state or province or cities.
- At the same time, you need to understand that: once the electric scooter is ridden on public ways or other public places, you may face the risks caused by illegal driving by others or incorrect operation of vehicles, even though that you ride the electric scooter in strict accordance with this safety driving manual. Just like that people who walk or ride bicycle on road may be hurt by other vehicles; like all other vehicles, the faster you ride the electric scooter, the longer distance is needed to stop the scooter, and you may fall down due to trackslip or overbalance if you stop the electric scooter emergently on smooth road. Therefore, it' s very important to maintain sharp vigilance, keep proper speed and keep a certain safe distance with others or other vehicles. Please be careful and ride the scooter in low speed when ride into unfamiliar terrain.
- Please respect the road right of pedestrians. Avoid scaring the pedestrians, especially for children. Remind pedestrians and ride in low speed when passing behind the pedestrians. Go through from the left side of pedestrians as far as possible (it is applicable to the countries and places that all vehicles keep to the right). When you ride a scooter face to pedestrians, keep the right side and ride in low speed.
- When you drive the electric scooter at the countries and regions that there is no national standards and rules related to the electric scooter so far, please do follow the safety requirements toward users stipulated in this manual. As for any property loss, personal loss, accident, legal dispute and any other adverse events caused conflict of interest arisen from violating the using behaviors mentioned in this manual, the MI Communication Technology Co., Ltd. shall not bear any direct responsibility and joint liability.
- For fear of any damage, do not lend the electric scooter to personnel who can' t operate it. If you lend the electric scooter to your friends, please take charge of the safety of your friends, teach him/her how to use it and tell him/her to wear safety protectors.
- Please carry out basic checking to the electric scooter every time before using it; if there is obvious loose parts, low battery life, the tire is leaked slowly or excessive wear, turn the handle with abnormal noise or turn the handle invalidly and any other abnormal situation, please stop using it immediately and never ride the scooter forcibly. Call the service telephone of MI 400-100-5678 to get professional guiding idea or maintenance service.

## 7. Folding and carrying

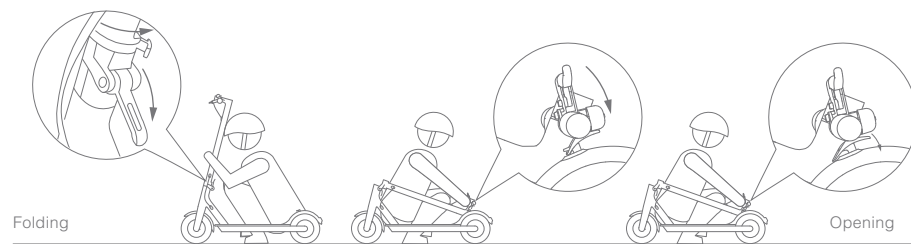

Confirm that the electric scooter is off; hold the vertical tube and push aside the folding thumb shifter, open the folding wrench, and hook the tinkle bell with back mud guard after aligning the position of tinkle bell and back mud guard. For opening the electric scooter, press the hook at the tinkle bell place, when the hood of tinkle bell is divorced from hook of mud guard, stand the vertical tube, lock the folding board tightly and put the folding thumb shifter back.



Hold the vertical tube by one hand or both hands for carrying after folding the electric scooter.

## 8. Daily care and maintenance

### Cleaning and storage for electric scooter

If there are dirt and stains on the surface of the electric scooter, use soft cloth dipped with clean water to wipe the dirt; if the dirt and stains are hard to be cleaned, coat some toothpaste on dirty place, use the brush to brush repeatedly, and use wet cloth to clean. If the plastic part has scratches, use abrasive paper or other abrasive materials for polishing.

Note: do not clean the body by using alcohol, petrol, kerosene or other chemical solvent with corrosion and volatility, or otherwise it will damage the appearance of body and internal structure seriously. Prohibit using pressure water gun for spraying and washing; when cleaning the electric scooter, be sure that the electric scooter is under off condition, the charging cable has been pulled up and the rubber plug at the charging mouth is covered tightly, or otherwise you may get an electric shock or the scooter may have serious fault since water is entering.

When the electric scooter is not used, keep the electric scooter at day and shady indoor place as far as possible and avoid putting it outdoors for long time. Exposure to sunlight/overheated/subcooled outdoor environment will fasten the aging for the appearance and tire of electric scooter or reduce the service life of the electric scooter and battery.

### Maintenance for battery of the electric scooter

1. Do not use battery of other model or brand, or may cause safety risks.
2. Prohibit touching the contacts of battery, disassembling or puncturing the shell. Avoid metal products touching the contacts of battery and then cause short circuit; otherwise, it may cause damage of battery or even casualties.
3. Only use original charger for charging, or otherwise the battery may be damaged or got fired.
4. Improper dealing with wasted or old battery may cause environmental pollution seriously. Please follow local rules to dispose this wasted battery. Do not throw the battery away freely and jointly protect the natural environment.
5. Please charge the battery in full after every time use and then store it, which is good for extending the service life of battery.

Do not put the battery under high temperature environment over 50°C or low temperature environment lower than -20°C (for example, do not put the electric scooter or the battery in the car that is exposed in the air in summer); do not throw the battery into fire, otherwise the battery may be invalid, overheated or even got fired. If the electric scooter is not used for more than 30 days, please charge the battery in full and store the scooter under cool and dry indoors, and charge the battery in full every 60 days, otherwise the battery may be damaged, and such damage is not under the range of warranty.

Avoid charging the scooter when the power is used up, and charge the electric scooter after every time use, which can greatly extend the service life of battery. What's more, use the electric scooter under normal temperature, the battery may have better endurance mileage and property; use the electric scooter under 0°C, the endurance and performance of battery may be decreased. Under typical condition and -20°C environment, the endurance mileage of battery may be half or less of it under normal temperature condition. When the temperature is getting back, the endurance ability of battery will be recovered, and see the display of residual mileage stipulated in the APP.

Note: the electric scooter that is charged in full will use up the storage power for about 120-180 days under standby mode. There is intelligent chip in the battery to record down the charging situation of the battery, and the battery can't be charged if it is damaged due to non charging for a long time; if the battery is not charged at the time, the battery may be damaged due to over discharge, and such damage can't be recovered, and the battery can't be repaired for free under such condition. (note: non professionals are prohibited disassembling the battery freely, otherwise it may cause serious safety accidents due to electric shock or short circuit)

### Disc brake debugging

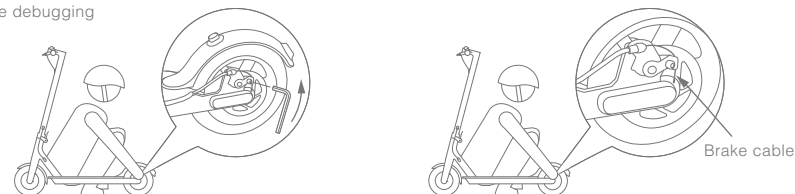

If you feel that the brake is too tight, use M5 hexagon wrench to loosen the tension disc screw on disc brake seat from counter-clockwise direction, send back the brake line and slightly shorten the exposed line, and then tightly lock the tension disc screw; if you feel that the brake is too loose, loosen the tension disc screw, pull out the brake line to let the exposed line be longer, and then tightly lock the tension disc screw.

### Handlebar shaking debugging

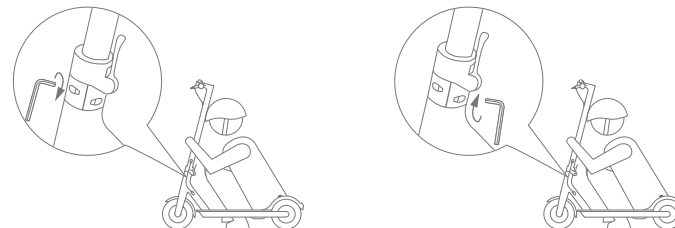

If the handlebar of electric scooter is shaking during the riding period, please use M5 hexagon wrench to tighten the two screws at the place of folding mechanism.

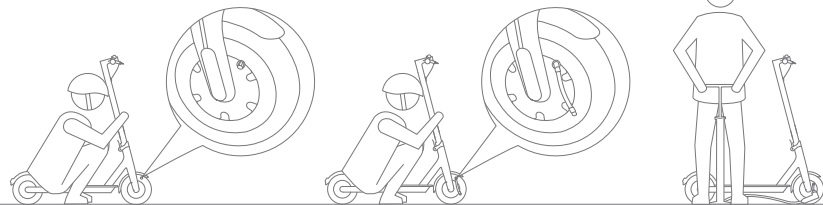

### Use of extended charging connector



If the front and back wheels of your electric scooter are lack of air, please use the complementary extended charging connector to connect to the air jet of the tire for pumping up. Screw off the mouth of air jet of front and back tire firstly, tighten the extended charging connector with the air jet of tire, and connect to the inflator for pumping up after tightening.



## 9. Model parameter table

| Performance indicator                | Items                                 | Parameter of electric scooter   |
|--------------------------------------|---------------------------------------|---|
| Product size                         | L x W x H [1] (cm)                    | 108×43×114  |
|                                      | After folding: L x W x H (cm)         | 108×43×49   |
| Product weight                       | Weight of the whole scooter (kg)      | About 12.5  |
| Riding requirements                  | Maximum load (kg)                     | 100   |
|                                      | Applicable age (year)                 | 16 — 50   |
|                                      | Applicable height (cm)                | 120 — 200   |
| Main parameters of the whole scooter | Highest speed (km/h)                  | About 25  |
|                                      | Typical endurance [2] (km)            | About 30  |
|                                      | Maximum gradeability (%)              | About 14  |
|                                      | Applicable terrain                    | Cement, asphalt road, flat soil road, stair no higher than 1cm, ditch no wider than 3cm                                 |
|                                      | Working temperature (°C)              | -10 — 40  |
|                                      | Storage temperature (°C)              | -20 — 45  |
|                                      | Protective level                      | IP54  |
| Parameter of battery                 | Rated voltage (VDC)                   | 36V                                    |
|                                      | Highest charging voltage (VDC)        | 42V                                    |
|                                      | Rated capacity (Wh)                   | 280   |
|                                      | Intelligent battery management system | Abnormal temperature/short circuit/under voltage automatic dormancy/double over charge/double over discharge protection |
| Motor parameters                     | Rated power (W)                       | 250   |
|                                      | Largest power (W)                     | 500   |
| Charger parameter                    | Rated power (W)                       | 71  |
|                                      | Rated input voltage (VAC)             | 100 — 240V ~  |
|                                      | Rated output voltage (VDC)            | 42V                                    |
|                                      | Rated current (A)                     | 1.7   |
|                                      | Product certification                 | CCC, RoHS   |
|                                      | Charging time (h)                     | About 5   |

[1] Height of scooter: the distance from the ground to the highest point of the scooter.

[2] Typical endurance: it is measured under full charged condition, with 75kg load, under 25°C, on flat road without wind, in the speed of 15km/h under energy-saving mode; the actual endurance will be different due to load, temperature, wind speed, road condition, operation habit and other factors.

Note: Data and parameters are different for different model electric scooter. It is subject to change without prior notice.

## 10. Name and content of harmful substances in the product

| Part name                | Harmful substances |              |              |                      |                                |                                       |
|--------------------------|--------------------|--------------|--------------|----------------------|--------------------------------|---------------------------------------|
|                          | Lead (Pb)          | Mercury (Hg) | Cadmium (Cd) | Chromium VI (Cr(VI)) | Polybrominated biphenyls (PBB) | Polybrominated diphenyl ethers (PBDE) |
| Charger                  | ×                  | ○            | ○            | ○                    | ○                              | ○                                     |
| Battery                  | ×                  | ○            | ○            | ○                    | ○                              | ○                                     |
| Air jet                  | ×                  | ○            | ○            | ○                    | ○                              | ○                                     |
| Charging mouth           | ×                  | ○            | ○            | ○                    | ○                              | ○                                     |
| Main control board       | ×                  | ○            | ○            | ○                    | ○                              | ○                                     |
| Instrument circuit board | ×                  | ○            | ○            | ○                    | ○                              | ○                                     |
| In-wheel motor           | ×                  | ○            | ○            | ○                    | ○                              | ○                                     |
| Frame                    | ○                  | ○            | ○            | ○                    | ○                              | ○                                     |
| Tire                     | ○                  | ○            | ○            | ○                    | ○                              | ○                                     |



This form is prepared according to the rules of SJ/T 11364.

○ : It means that the content of this harmful substance in all homogenic materials for this part is under the limitation requirements of GB/T 26572.

× : It means that the content of this harmful substance in at least a certain homogenic materials for this part is over the limitation requirements of GB/T 26572.



## 11. Trademark and legal statement

 is the registered trademark of MI Technology Co., Ltd. (hereinafter referred to as MI Company). All rights reserved to the trademark . Other trademarks mentioned in the manual may be the registered trademarks of the owner. Naenbo, Ninebot, No. 9 and other trademarks are trademarks of Ninebot (Tianjin) Technology Co., Ltd., which are protected by laws, and no infringement allowed.

This manual is made by Ninebot (Beijing) Technology Co., Ltd. and have copyright, without written approval of Ninebot (Beijing) Technology Co., Ltd., any unit or individuals shall not use, copy, change, record, spread or attached to other products for using and selling to any parts of this manual.

This manual has covered various function introductions and using instruction as far as possible on printing. However, as the products are perfecting constantly, design is changing, this manual may not be conforming to the products purchased totally. Please scan the APP QR code on back cover to download APP that is suitable for Android or iOS system and read the latest electric edition manual. Based on the updating of products, this manual may have deviations on color, appearance and other aspects of actual products, and please refer to the actual products.

Entrusting party: MI Communication Technology Co., Ltd.

Manufacturer: Ninebot (Changzhou) Technology Co., Ltd.

Address: F16-17, Building A, Building 3, R & D Hub, Changzhou Science & Education Town, No. 18, Middle Changwu Road, Wujin District, Changzhou City

Product executive standard: Q/320412NCZ002-2016

## 12. Warranty policy

The After Sales Service of electric scooter will carry on after-sales "three guarantees" service in strict accordance with Law of the People's Republic of China on the Protection of the Rights and Interests of Customers and Product Quality Law of The People's Republic of China, and the service contents are as follows:

### I. Warranty period

1. In case the product purchased have the performance fault stipulated in the Performance Fault Table of Electric Scooter condition within 7 days from the next day of signing and the fault is confirmed after inspection by Mi after-sales service center, you can enjoy goods returns or exchanging service for free;
2. In case the product purchased have the performance fault stipulated in the Performance Fault Table of Electric Scooter condition within 8 ~ 15 days from the next day of signing and the fault is confirmed after inspection by Mi after-sales service center, you can enjoy goods exchanging and maintenance service for free;
3. In case the product purchased have the performance fault stipulated in the Performance Fault Table of Electric Scooter condition within 12 months from the next day of signing and the fault is confirmed after inspection by Mi after-sales service center, you can enjoy maintenance service for free;

Friendly reminder: As the packaging box is needed to ensure the safety of products in delivery, I suggest that you'd better keep the packaging box for at least 15 days from the next day of the signing.

### II. Maintenance contents

| Type                     | Maintenance content  | Starting time |
|--------------------------|--|---------------|
| Main body                | Frame assembly, In-wheel motor, controller assembly, handlebar, forehead subject, center tank instrument, rear hub, brake disk, disc brake assembly, fold vertical bar, front fork, rotating parts of front fork tube, control bus, brake cables | 1 year        |
| Accessories              | Battery, charger, brake level, thumb shifter handle  | 6 months      |
| Appearance wearing parts | Crashproof stripe, front light assembly, instrument cover, handlebar grip, outer tire, inner tire, tinkle bell parts, mud guard, tail lump, overlay, kickstand components, battery tank cover, foot pad, charger port seat, rubber plug          | 3 months      |

Note: The internal hexagonal wrench and extended charging connector are matched consumables of the product, which have no warranty period.

### III. Non warranty regulation

1. Maintenance without authorization, misuse, collision, negligence, abuse, feed liquor, accidents, change, using the accessories that are not matched with this product incorrectly, tearing or altering label and anti-counterfeiting marks;
2. Product has exceeded the valid period of "three-guarantee";
3. Product has damages caused by force majeure events;
4. Product has faults that are nonconforming to the performance faults stipulated in the Performance Fault Table of Electric Scooter;
5. Product has faults that are conforming to the performance faults stipulated in the Performance Fault Table of Electric Scooter caused by man-made reasons;
6. Damaged caused by man-made reasons (including without limitation to feed liquor in scooter, puncture the tire, collision, traces & damaged caused by normal use of appearance parts, etc.);
7. If the product is used for commercial, such condition is not included in the warranty service.

### IV. Performance Fault Table of Electric Scooter

| Name             | Performance fault  |
|------------------|--|
| Electric scooter | Motor can't work under normal use condition;<br>Controller fault under normal use condition;<br>Charger fault under normal use condition;<br>Battery fault under normal use condition;<br>Deformation, breakage and other conditions that the scooter can't be used normally under normal use condition; |

## IC Radiation Exposure Statement for Canada

This device complies with Industry Canada licence-exempt RSS standard(s). Operation is subject to the following two conditions: (1) this device may not cause interference, and (2) this device must accept any interference, including interference that may cause undesired operation of the device.

Le présent appareil est conforme aux CNR d'Industrie Canada applicables aux appareils radio exempts de licence. L'exploitation est autorisée aux deux conditions suivantes : (1) l'appareil ne doit pas produire de brouillage, et (2) l'utilisateur de l'appareil doit accepter tout brouillage radioélectrique subi, même si le brouillage est susceptible d'en compromettre le fonctionnement.

Under Industry Canada regulations, this radio transmitter may only operate using an antenna of a type and maximum (or lesser) gain approved for the transmitter by Industry Canada. To reduce potential radio interference to other users, the antenna type and its gain should be so chosen that the equivalent isotropically radiated power (e.i.r.p.) is not more than that necessary for successful communication.

Conformément à la réglementation d'Industrie Canada, le présent émetteur radio peut fonctionner avec une antenne d'un type et d'un gain maximal (ou inférieur) approuvé pour l'émetteur par Industrie Canada. Dans le but de réduire les risques de brouillage radioélectrique à l'intention des autres utilisateurs, il faut choisir le type d'antenne et son gain de sorte que la puissance isotrope rayonnée équivalente (p.i.r.e.) ne dépasse pas l'intensité nécessaire à l'établissement d'une communication satisfaisante.

User manuals for transmitters equipped with detachable antennas shall also contain the following notice in a conspicuous location:

This radio transmitter (identify the device by certification number, or model number if Category II) has been approved by Industry Canada to operate with the antenna types listed below with the maximum permissible gain and required antenna impedance for each antenna type indicated. Antenna types not included in this list, having a gain greater than the maximum gain indicated for that type, are strictly prohibited for use with this device.

Le présent émetteur radio (identifier le dispositif par son numéro de certification ou son numéro de modèle s'il fait partie du matériel de catégorie I) a été approuvé par Industrie Canada pour fonctionner avec les types d'antenne énumérés ci-dessous et ayant un gain admissible maximal et l'impédance requise pour chaque type d'antenne. Les types d'antenne non inclus dans cette liste, ou dont le gain est supérieur au gain maximal indiqué, sont strictement interdits pour l'exploitation de l'émetteur.

### IMPORTANT NOTE:

Radiation Exposure Statement:

This equipment complies with “Industry Canada RSS-102 for radiation exposure limits set forth for an uncontrolled environment”.

Déclaration d'exposition aux radiations: Cet équipement est conforme aux limites d'exposition aux rayonnements IC établies pour un environnement non contrôlé.

**Industry Canada – Emissions compliance statement**

This Class B digital apparatus complies with Canadian ICES-003. Avis de Conformité à la Réglementation d' Industrie Canada. Cet appareil numérique de la classe B est conforme à la norme NMB-003 du Canada.

### **Federal Communications Commission (FCC) Interference Statement**

This equipment has been tested and found to comply with the limits for a Class B digital device, pursuant to Part 15 of the FCC Rules.

These limits are designed to provide reasonable protection against harmful interference in a residential installation. This equipment generate, uses and can radiate radio frequency energy and, if not installed and used in accordance with the instructions, may cause harmful interference to radio communications.

However, there is no guarantee that interference will not occur in a particular installation. If this equipment does cause harmful interference to radio or television reception, which can be determined by turning the equipment off and on, the user is encouraged to try to correct the interference by one of the following measures:

- Reorient or relocate the receiving antenna.
- Increase the separation between the equipment and receiver.
- Connect the equipment into an outlet on a circuit different from that to which the receiver is connected.
- Consult the dealer or an experienced radio/TV technician for help.

This device complies with Part 15 of the FCC Rules. Operation is subject to the following two conditions:

(1) This device may not cause harmful interference, and (2) this device must accept any interference received, including interference that may cause undesired operation.

FCC Caution: Any changes or modifications not expressly approved by the party responsible for compliance could void the user's authority to operate this equipment.

### **RF exposure warning**

This equipment complies with FCC radiation exposure limits set forth for an uncontrolled environment.