

NINJA[®]

COFFEE

CF020 series

OWNER'S GUIDE



ninjakitchen.com
1-877-646-5288

IMPORTANT SAFEGUARDS

For Household Use Only

READ ALL INSTRUCTIONS BEFORE USING YOUR NINJA® COFFEE BREWER.

Safety Signal Words

This Owner's Guide and the safety labels attached to this appliance use signal words that indicate safety hazards with differing levels of severity.

Below are the words used and their definitions:

- **WARNING** indicates a hazardous situation which, if not avoided, could result in death or serious injury.
- **CAUTION** indicates a hazardous situation which, if not avoided, could result in minor or moderate injury.
- **NOTICE** is used to address practices not related to physical injury.

The words "**WARNING**" and "**CAUTION**" are preceded by a triangle, signifying that these are safety related.

The terms "**IMPORTANT**" and "**NOTE**" are also used to describe good ideas for better and more efficient equipment use.

THIS BOOK COVERS MODEL NUMBER:

CF020

TECHNICAL SPECIFICATIONS

Voltage: 120V~, 60Hz.
Power: 1450 Watts
Water Reservoir
Capacity: 43 Ounces

WARNING:

To reduce the risk of fire, electric shock, serious injury, death or damage when using this appliance, follow these basic safety precautions.

- ▲ **CAUTION: APPLIANCE CREATES HOT LIQUID. HANDLE WITH CARE.**
- ▲ **CAUTION: DO NOT remove the vessel while the appliance is brewing unless the Drip Stop is in the closed position. Return the vessel quickly and open the Drip Stop to continue the brew.**
- ▲ **CAUTION: Never open the brew basket while your Ninja Coffee brewer is in use.**
- ▲ **CAUTION: Please ensure you are using at least a 12 oz. cup for the Cup size and a 16 oz. travel mug for the Travel Mug size to prevent overflow and a scalding injury.**

General Precautions

- 1 **DO NOT** allow young children to operate the appliance or use as a toy. Close supervision is necessary when any appliance is used near children.
- 2 To reduce the risk of electric shock, this appliance has a polarized plug (one blade is wider than the other). As a safety feature, this plug will fit into a polarized outlet only one way. If the plug does not fit fully into the outlet, reverse the plug. If it still does not fit, contact a qualified electrician. **DO NOT** force into outlet or try to modify to fit.
- 3 To protect against electrical shock, do not submerge the appliance or allow the power cord to come into contact with water or any other liquid.
- 4 Allow the appliance to cool before removing any parts and before cleaning.
- 5 **DO NOT** abuse the power cord. Never carry the appliance by the power cord or yank it to disconnect from electrical outlet; instead grasp the plug and pull to disconnect.
- 6 **DO NOT** operate any appliance with a damaged cord or plug, or after the appliance malfunctions, or has been dropped or damaged in any manner.



- 7 **DO NOT** let the power cord hang over the edges of tables or counters or touch hot surfaces such as the stovetop.
- 8 **DO NOT** remove the brew basket or carafe while the appliance is brewing. **Scalding may occur if any of these parts are removed during brewing cycles.**
- 9 The use of an accessory not recommended by the manufacturer may create an overflow condition and scalding hazard, or result in fire, electric shock, or personal injury.
- 10 **DO NOT** operate your appliance in an appliance garage or under a wall cabinet. When storing in an appliance garage always unplug the unit from the electrical outlet. Not doing so could create a risk of fire, especially if the appliance touches the walls of the garage or the door touches the unit as it closes.

Operating Notice

- 11 Clogging and backing up of water and/or coffee in the filter basket can occur under any or a combination of any of the following conditions: the use of coffee that is too finely ground; using two or more paper filters; using the permanent filter in conjunction with a paper filter; not cleaning coffee grounds from the permanent filter; or allowing coffee grounds to spill over the filter.
- 12 **ALWAYS** use appliance on a dry, level surface.
- 13 **DO NOT** use this appliance for anything other than its intended use. **DO NOT** use outdoors.
- 14 **DO NOT** place on or near a hot gas or electric burner, or in a heated oven.
- 15 **DO NOT** touch hot surfaces. Use handles or knobs.
- 16 **DO NOT** touch warming plate while the brewer is in use.
- 17 **DO NOT** run the appliance without water.
- 18 **DO NOT** use well water; use tap water.
- 19 **ALWAYS** place a vessel beneath the brew basket to receive the brewed coffee.
- 20 **DO NOT** overfill the water reservoir. Fill water only to the Max Fill line.

Glass Carafe

- 21 The carafe is designed for use with this appliance only. It must never be used on a stovetop.
- 22 **DO NOT** set a hot carafe on a wet or cold surface.

- 23 **DO NOT** use a cracked or scratched carafe or a carafe having a loose or weakened handle.
- 24 **DO NOT** clean carafe with abrasive cleansers, steel wools pads, or other abrasive material.
- 25 **DO NOT** place carafe in microwave.
- 26 **DO NOT** expose carafe to extreme temperature changes.
- 27 **DO NOT** use carafe for carbonated beverages.
- 28 **DO NOT** drink directly from the carafe. Liquid from the carafe may be very hot.
- 29 Do not use the carafe to store food when not in use.
- 30 Ensure the carafe is completely empty before starting a cleaning or brewing cycle. Starting a cycle with water or coffee in the carafe will cause an overflow.

Maintenance

- 31 Remove the power cord from the electrical outlet and allow unit to cool before surface cleaning, and before removing brew basket, water reservoir, or filters.
- 32 Clean the glass carafe with a soft brush or sponge. **DO NOT** use a wire brush.
- 33 To prevent illness from bacterial growth in the appliance, follow all cleaning instructions in the Care & Maintenance section of this Owner's Guide.
- 34 If the product is not operating properly, contact SharkNinja Operating LLC at 1-877-646-5288 or ninjakitchen.com for examination, repair, or adjustment.
- 35 Clean the system on a weekly basis.

Cord Statement

- 36 A short power-supply cord is provided to reduce the risks resulting from becoming entangled in or tripping over a longer cord.
- 37 **DO NOT** use extension cord with this product.

SAVE THESE INSTRUCTIONS

Getting to Know Your Ninja® Coffee Brewer

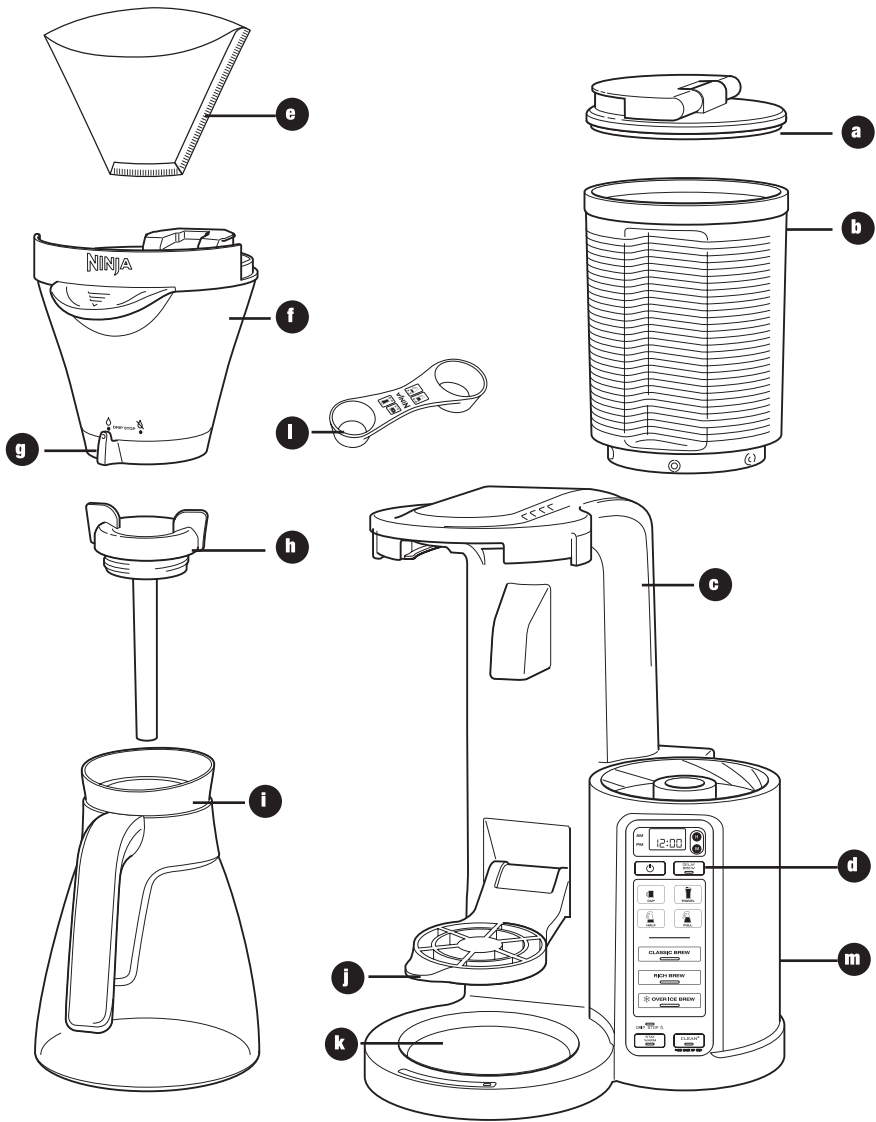

- a** Flip-Top Water Reservoir Lid
- b** Removable Water Reservoir
- c** Brewer
- d** Control Panel
- e** Paper Filter Kit
- f** Removable Brew Basket
- g** Drip Stop Toggle

- h** Brew-Through Carafe Lid
- i** Glass Carafe
- j** Multi-Serve Cup Platform
- k** Intelligent Warming Plate
- l** Double-Sided Scoop: Carafe Side and Single-Serve Side
- m** Power Cord & Wrap (not shown)



Control Panel

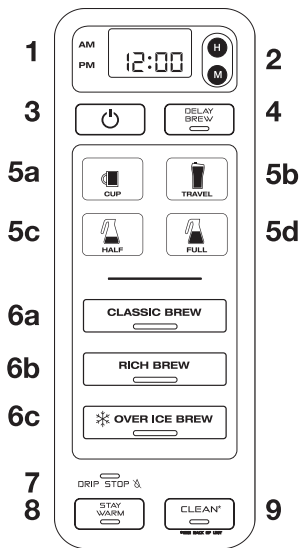

- 1 Programmable Digital Clock
- 2 Clock Hour & Minute Buttons
- 3 Power Button
- 4 Delay Brew Button
- 5 Sizes
 - a Cup
 - b Travel Mug
 - c Half Carafe
 - d Full Carafe
- 6 Brew Types
 - a Classic Brew Button
 - b Rich Brew Button
 - c Over Ice Brew Button
- 7 Drip Stop Indicator
- 8 Stay Warm Indicator/Button
- 9 Intelligent Clean Cycle Indicator/Button

Features of the Ninja® Coffee Brewer

- **Thermal Flavor Extraction® Technology** – Blends precision water delivery with automated controls for calibrated temperature, pre-infusion, coffee saturation, and flavor richness to unlock the full flavor potential of your coffee.
- **Multi-Serve** – Brew directly into your favorite cup, travel mug, or carafe.
- **Brew Types** – Control the strength and style of your coffee:
 - a. Classic Brew for smooth, balanced hot coffee.
 - b. Rich Brew for a richer-than-Classic but still smooth coffee flavor that stands up to milk, cream, or flavoring.
 - c. Over Ice Brew for smooth, rich, freshly brewed iced coffee that's not watered down.
- **Multi-Serve Cup Platform** – Pull it down and place your favorite cup on it. Brew directly into your cup.
- **Removable Water Reservoir with Easy-Access Flip-Top Lid** – For quick and easy filling.
- **Auto-iQ™** – The Ninja Coffee brewer knows how much water to use for each size and brew type.
- **43 oz. Glass Carafe**
- **LED Control Panel with Programmable Digital Clock**
- **24-Hour Programmable Delay Brew Button** – Set it to automatically brew the following morning. The brewer will remain pre-heated and ready to brew at the time you programmed.
- **Drip Stop** – Stops the flow of coffee from the brew basket, allowing you to pour a cup mid-brew. Switch toggle to the closed position to prevent dripping once the brew cycle is finished.
- **Clean Function** – When your Ninja Coffee brewer senses there is hard-water calcium buildup in your brewer, which can affect the flavor of your coffee, the CLEAN light will illuminate. Follow the cleaning instructions in the Care & Maintenance section, or on the back of your unit.
- **Stay Warm Button** – Your warming plate will automatically turn on after brewing a carafe and turn off after 2 hours. The Stay Warm button allows you to manually control how long your coffee stays warm by turning the warming plate off or on.
- **Intelligent Warming Plate** – Automatically adjusts the temperature of the warming plate to keep your coffee at the ideal drinking temperature without burning it.
- **Pre-Heat Mode** – After pressing the Power button to turn on your Ninja Coffee brewer, allow 3 minutes for your brewer to pre-heat. Your Ninja Coffee brewer will remain pre-heated for 72 hours, unless you turn off your unit by pressing the Power button.
- **Sleep Mode** – After 72 hours, the Ninja Coffee brewer will enter sleep mode to conserve energy. Pre-Heat mode will shut off, and the lights on your unit will dim. You may turn off Sleep Mode by selecting a brew size. This will reinitiate the Pre-Heat Mode.
- **Audible Ready Signal** – Alerts you that your coffee is ready.
- **2-Hour Shutoff** – Automatically turns off the warming plate two hours after you brew coffee.
- **Paper Filter Kit** – Use the paper filters in your removable brew basket to catch grounds and keep them from entering your coffee.

Before First Use

- 1 Remove all packaging material, stickers, and labels from the brewer.
- 2 Wash the water reservoir, glass carafe, and brew basket in warm, soapy water with a soft cloth.
NOTE: The glass carafe is dishwasher safe. Place on top rack only.
- 3 Rinse and dry thoroughly.
- 4 Wipe the intelligent warming plate with a damp cloth.
- 5 Before first use, prime the system by running two Full Carafe, Classic Brew cycles with water only. After each cycle is complete, discard the water.
NOTE: See the Priming Your Ninja Coffee Brewer section.

Setting the Clock & Delay Brew



Fig. 1

SETTING THE CLOCK

- 1 Plug the power cord into an electrical outlet. The clock will flash on the control panel to indicate that the time has not been set. **(Fig. 1)**
- 2 Press the H (hour) or M (minute) button until you reach the current time. The AM or PM indicator will illuminate on the left side of the display as you are setting the time. **(Fig. 1)**
- 3 After 5 seconds, the clock will stop flashing and the clock will be set.

NOTE: If the clock stops flashing and does not display the correct time of day, pressing the H (hour) or M (minute) button at any time will cause the clock to flash again. You can now reprogram the correct time of day by following the steps above.

NOTE: If you unplug the brewer or in the event of an extended power loss, you will need to reset the clock the next time the brewer is plugged in.

SETTING THE DELAY BREW TIME

NOTE: The Ninja Coffee brewer must remain on for the Delay Brew function to work. Do not power off after setting Delay Brew.

- 1 Press Power button, then press Delay Brew. The Delay Brew button will illuminate and the clock will begin to flash "12:00" or the last delay brew time that was set. **(Fig. 1)**
- 2 While the clock is flashing, press the H (hour) or M (minute) button to set the time you would like the Delay Brew to begin. The AM or PM indicator will illuminate on the left side of the display as you are setting the desired time.

- 3 Once the proper time has been set, select the size of the vessel that you would like to brew into.
- 4 Select the Brew Type that you desire from the 3 flashing buttons. The selected brew type will illuminate. **(Fig. 1)**
- 5 Once the time, brew size, and brew type have been set, allow the Delay Brew button to stop flashing, or press the Delay Brew button to activate. The light on the button will illuminate and an audible signal will play to verify the Delay Brew is set. Your Ninja Coffee brewer will now brew at the time you programmed.

NOTE: To deactivate the Delay Brew cycle, press the Delay Brew button once more and the light on the button will turn off. Any change to the selected brew size or starting any other brew will cancel the programmed Delay Brew.

- 6 Place the appropriate-sized vessel under brew basket.

IMPORTANT: Make sure the Drip Stop is in the open position.

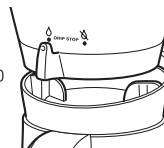

Priming Your Ninja® Coffee Brewer

⚠ CAUTION: Fill reservoir with water up to, but not exceeding, the Max Fill line. We recommend fresh, cool, filtered water. Do not fill water reservoir with any other liquids such as brewed coffee, carbonated beverages, etc., as other liquids may damage your brewer.

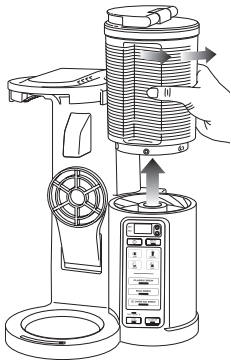

Fig. 2

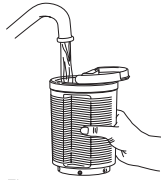

Fig. 3a

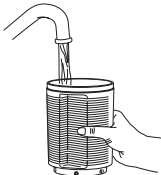

Fig. 3b

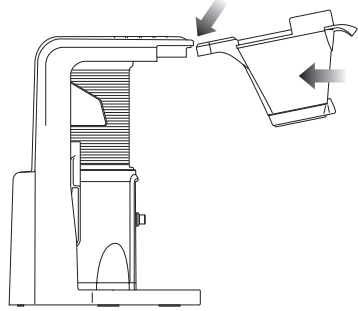

Fig. 4

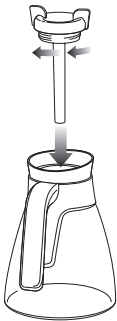

Fig. 5

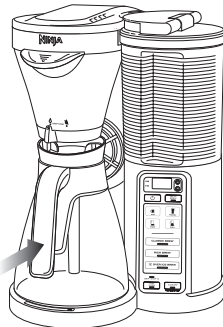

Fig. 6



Fig. 7

- 1 Place the brewer on a dry, clean, and level surface.
- 2 Holding the water reservoir by the grip, twist counterclockwise to remove. **(Fig. 2)** Either flip the lid top over **(Fig. 3a)** or remove lid by twisting counterclockwise **(Fig. 3b)**. Fill with water up to, but not exceeding, the Max Fill line (43 oz.). To replace the water reservoir, place on top of the base and twist clockwise until you feel the reservoir lock into place. **NOTE:** Do not fill past the Max Fill line. If overfilled, remove the water reservoir from the brewer and pour out water until the level is no higher than the Max Fill line.
Depending on the size and brew type, you may have water left in the reservoir.
- 3 Ensure the brew basket is properly inserted. To reinsert the brew basket, align it with the rails and slide it into the brewer until it clicks in place. **(Fig. 4)**
- 4 Twist the brew-through lid clockwise onto the glass carafe to lock into place. **(Fig. 5)**
- 5 Center the carafe below the brew basket. **(Fig. 6)**
NOTE: Do not place any ground coffee in the brew basket for the first two cycles.
- 6 Plug the brewer into an electrical outlet.
- 7 Once all parts are securely in place, press the Power button.
- 8 With the unit powered on, make sure the Drip Stop toggle is set to the open position. Select the Full Carafe size and Classic Brew setting. **(Fig. 7)**
- 9 When the brew is complete, discard the water in the carafe. Repeat, beginning with step 2. You are now ready to use your Ninja Coffee brewer to brew coffee.
NOTE: After removing the water reservoir, there may be a small amount of water in the reservoir valve. This can be easily removed with a dry cloth.

Preparing & Using the Ninja® Coffee Brewer

HOW MUCH COFFEE DO YOU GET IN YOUR CUP?

Each size and brew type produces a different amount of coffee to optimize richness and flavor.

NOTE: The coffee grounds will absorb some of the water that is brewed, resulting in slightly less brewed coffee than water used.





⚠ CAUTION: Please ensure you are using at least a 12 oz. cup for the Cup size and a 16 oz. travel mug for the Travel Mug size.

Approximate Brew Volume

Size/Brew	Classic	Rich	Over Ice	
			Coffee Only	With Ice
Cup	9.5 oz.	8.8 oz.	3.7 oz.	9.5 oz.
Travel Mug	14 oz.	13.2 oz.	5.8 oz.	14 oz.
Half Carafe	21 oz.	19.5 oz.	10.5 oz.	21 oz.
Full Carafe	38 oz.	35.5 oz.	15.8 oz.	38 oz.

WOULD YOU LIKE A HOTTER COFFEE?

The type of cup you brew into can drastically influence the drinking temperature of your coffee.

CUP TYPE	CERAMIC CUP			NINJA® CUP	PAPER CUP
Cup Temperature	Room Temp	Pre-warmed with hot water	Pre-warmed in microwave with milk	Room Temp	Room Temp
Drinking Temperature	Hot 	Hotter 	Hotter 	Hotter 	Hottest 
Why is there a difference?	A cold ceramic mug will steal heat from the coffee as it warms itself up.	If the mug is already warm, it will not steal as much heat from the coffee.	Just like your cold mug, cold milk lowers the temperature of your coffee.	The double-walled Ninja® cup is designed to retain initial coffee temp better than a ceramic cup.	Unlike a ceramic mug, a thinner paper cup does not steal substantial heat from the coffee.

PRE-HEATING

- 1 Plug in your brewer, then press the Power button to initiate pre-heating. The word "PRE-HEAT" will flash across the clock display.
- 2 Allow 3 minutes for your brewer to pre-heat.
- 3 After 3 minutes, the word "PRE-HEAT" will disappear from the clock display and you will hear a beep, indicating your brewer is now pre-heated.
- 4 Your Ninja Coffee brewer will stay pre-heated for 72 hours unless you turn the brewer off by pressing the Power button.

- ⚠ **CAUTION: HOT WATER** Do not remove the brew basket or vessel while brewing.
- ⚠ **CAUTION: STEAM** Do not touch steam vents or the top of the brewer while brewing.
- ⚠ **CAUTION:** The brew basket is hot after brewing. Always allow the brewer to cool down before cleaning.

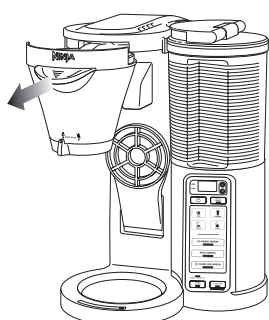

Fig. 8

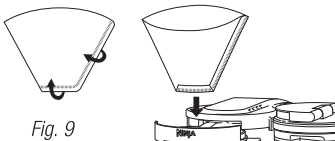

Fig. 9

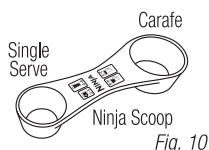

Fig. 10

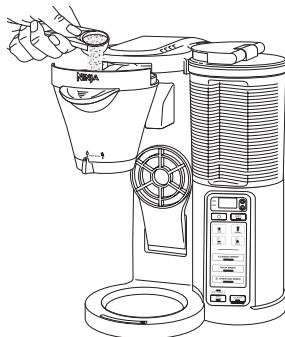

Fig. 11

FILLING THE BREW BASKET WITH COFFEE

For best results, use the measurement chart below to determine how much ground coffee to use for each brew size. The amount of ground coffee for each size will remain the same no matter which brew type is selected.

- ⚠ **CAUTION: The maximum capacity for ground coffee is 12 rounded tablespoons or 6 Ninja® Carafe Scoops. Exceeding this amount or using fine ground coffee may cause overflow.**

- 1 Open the brew basket by sliding it out of the brewer. (Fig. 8)
NOTE: The brew basket can be removed from the brewer by lifting it at a slight upward angle (similar to a cabinet drawer).
NOTE: Check for any loose grounds that may be left in the brew basket. Remove and rinse brew basket, if needed.
- 2 Place the #4 Paper Cone Filter in the brew basket. Fold it along the seams, open it fully and firmly press it into the brew basket, making sure it is fully seated. (Fig. 9)
- 3 Use the Ninja Scoop (Fig. 10) and follow the measurements below to fill the filter. These measurements are based on level scoops—adjust to your preferred taste. (Fig. 11) We suggest using a medium grind if grinding whole beans.

NOTE: Exceeding the recommended medium grind for whole beans may cause the brew basket to overflow.

Single Serve	Ninja® Scoop (Single Serve Side)	Tablespoon
Cup	2-3 scoops	2-3 Tbsp.
Travel Mug	3-4 scoops	3-4 Tbsp.
Carafe	Ninja® Scoop (Carafe Side)	Tablespoon
Half Carafe	2-3 scoops	5-7 Tbsp.
Full Carafe	4-6 scoops	8-12 Tbsp.

- 4 Slide the brew basket back into the brewer until it clicks into place.

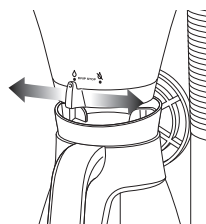

Fig. 12

DRIP STOP

NOTE: If the Drip Stop is closed before you begin a brew, the brewer will notify you with 5 beeps. Set the Drip Stop to the open position.

CAN'T WAIT FOR THAT FIRST CUP TO BE READY?

When brewing a carafe, close the Drip Stop to pause the brew cycle and pour a cup. Promptly replace the carafe and open the Drip Stop to complete the brew. (Fig. 12)

NOTE: If you forget to open the Drip Stop, the Ninja Coffee brewer will pause the brew, and after 20 seconds it will give you a friendly audible reminder. After 6 minutes, the brew will be canceled.

CAN'T WAIT FOR THE LAST FEW DROPS?

When the brew cycle is complete, set the Drip Stop to the closed position to stop dripping from the brew basket.

NOTE: While the Drip Stop is closed, the Drip Stop indicator will light up on the bottom of the control panel, above the Stay Warm button.

NOTE: Remember to open the Drip Stop when you're ready to brew again. If you forget, your Ninja Coffee brewer will give you a friendly audible reminder.

Preparing & Using the Ninja® Coffee Brewer - cont.

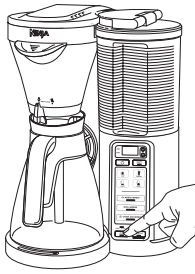

Fig. 13

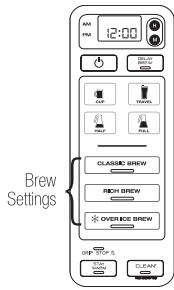

Fig. 14

INTELLIGENT WARMING PLATE

The Intelligent Warming Plate will automatically turn on after selecting Half Carafe or Full Carafe on either the Classic Brew or Rich Brew setting. The Intelligent Warming Plate will adjust the heat it produces over time to avoid burning the coffee.

⚠ CAUTION: The HOT SURFACE light will illuminate when the warming plate is hot. Do not touch the surface when this light is illuminated.

STAY WARM BUTTON

Press the Stay Warm button after the brew to turn the Intelligent Warming Plate off. You can turn the Intelligent Warming Plate back on within 2 hours of the brew by pressing the Stay Warm button again. (Fig. 13)

If you would like the Warming Plate to stay on longer, you can program it to stay on up to 4 hours.

- 1 Select either the Half Carafe or Full Carafe brew size.
- 2 Press and hold Stay Warm button until the clock begins to flash, displaying the time at which the warming plate is currently set to stop.
- 3 Quickly press the hour (H) or minute (M) button to increase the time up to 4 hours.
- 4 To lock in the new time, press the Stay Warm button again, or wait 5 seconds for it to lock in automatically.

BREWING COFFEE

NOTE: Each brew has a pre-infusion cycle with varying times. The brew will begin, stop, and be quiet for a short period of time before it begins again. This pre-infusion cycle is used to evenly saturate the coffee grounds.

⚠ CAUTION: Ensure the carafe is completely empty before starting a brewing cycle. Starting a brewing cycle with coffee in the carafe will cause an overflow.

CLASSIC OR RICH BREW

Classic Brew - For a smooth, balanced flavor.

Rich Brew - For a coffee that is richer than Classic Brew and still smooth, with more room for milk and cream.

- 1 After filling the water reservoir and adding ground coffee to the filter, be sure the Drip Stop is open and the reservoir, brew basket, and filter are securely in place.
- 2 Turn the unit on, and place the empty vessel that you would like to brew into underneath the brew basket.

NOTE: If making a single cup, lower the Multi-Serve cup platform and center the cup or mug on the platform. Please ensure you are using at least a 12 oz. cup for the Cup size and a 16 oz. travel mug for the Travel Mug size.

- 3 Select your size from the control panel. After selecting your size, choose either Classic or Rich Brew from the control panel. If you need to cancel the brew, press the Classic Brew or Rich Brew button again, or press the Power button. (Fig. 14)

NOTE: If brewing a Half Carafe or a Full Carafe, the Stay Warm indicator and Intelligent Warming Plate will automatically turn on. This can be turned off by pressing the Stay Warm button. The Intelligent Warming Plate will turn off automatically after 2 hours.

NOTE: Do not remove water reservoir, brew basket, or vessel while brewing.

- 4 The Ninja Coffee brewer will beep to signal a completed brew.

NOTE: Rich Brew will use slightly less water and yield slightly less brewed coffee than Classic Brew.

OVER ICE BREW

Designed to brew hot coffee over ice to lock in the flavor for a rich, freshly brewed, smooth iced coffee that's not watered down. Be sure your vessel is filled with ice before brewing.

⚠ IMPORTANT NOTICE: DO NOT USE GLASSWARE.

However, the provided glass carafe is safe to use due to its specialized glass material.

- 1 After filling the water reservoir, add ground coffee to the filter. Be sure the Drip Stop is open and the reservoir, brew basket, and filter are securely in place.
- 2 Turn the unit on. Fill the vessel that you would like to brew into with ice cubes, and place the vessel underneath the brew basket.
- 3 Press Over Ice Brew and the brew will begin. If you need to cancel the brew, press the Over Ice Brew button again, or press the Power button.

IMPORTANT: Always fill the desired vessel to the top with ice before placing it below the brew basket. Do not add ice to the water reservoir.

NOTE: The brew will begin, stop, and be quiet for a short period of time before it begins again. This pre-infusion process is used to evenly saturate the coffee grounds.

NOTE: If making a carafe of Over Ice coffee, fill the carafe with ice and brew without the brew-through lid.

- 4 The Ninja Coffee brewer will beep to signal a completed brew. Stir coffee to cool completely.

NOTE: When brewing Over Ice coffee, the Intelligent Warming Plate will not turn on.

Care & Maintenance

CLEANING AFTER A BREW

⚠ CAUTION: Make sure the brewer is unplugged from the power source before cleaning.

⚠ CAUTION: Be sure to allow the brewer to cool before cleaning.

IMPORTANT: Discontinue use if the glass carafe is scratched or if handle is loose or damaged.

NOTE: Do not leave coffee in the glass carafe for an extended period of time after a brew.

NOTE: Do not leave unused water in the reservoir for multiple days. Rinse and replace with fresh water.

- 1 Before cleaning, close the Drip Stop.
- 2 After each brew is complete and the coffee grounds have cooled, discard the paper filter. If using the permanent filter, carefully remove and wash. Remove brew basket from the brewer, rinse, and wash with soap and warm water.

NOTE: The brew basket is not dishwasher safe.

NOTE: If coffee grounds spill over into the brew basket or in the overflow channels, remove and rinse under water until grounds are removed.

- 3 Wash the carafe and brew-through lid with soap and warm water. Use a bottle brush or cloth to wash the inside of the carafe.

NOTE: The brew-through lid, glass carafe, permanent filter, and water reservoir are top-rack dishwasher safe.

IMPORTANT: Clean the glass carafe with a soft brush or sponge. Do not use a wire brush.

- 4 Wipe machine down with a cloth and soap and warm water. Let the warming plate cool before cleaning with a wet cloth and soap and water. **Do not immerse the base in water.**

CLEANING YOUR CARAFE

We recommend cleaning your carafe with warm, soapy water, or placing in the top-rack of your dishwasher.

If you want to clean the carafe more thoroughly, we recommend using a soft foam brush such as the one shown.



CLEANING YOUR WATER RESERVOIR

- 1 Empty the water reservoir.
- 2 Hand wash with dish soap and rinse or place on the top rack of your dishwasher.

CLEANING & DESCALING YOUR BREWING SYSTEM

⚠ CAUTION: Be sure to allow the brewer to cool before wiping down any surface for cleaning.

⚠ CAUTION: DO NOT immerse the coffeemaker into water or any other liquid.

The CLEAN button will illuminate when a cleaning cycle is recommended for your Ninja® Coffee brewer, as calcium scale buildup could be affecting the flavor of your coffee.

To clean and descale your Ninja Coffee brewer:

NOTE: The clean cycle takes approximately 60 minutes.

- 1 Select the Full Carafe size and set the empty carafe beneath the brew basket.
- 2 Use a descaling solution specifically formulated for coffeemaker cleaning and follow the directions on the package. Fill the water reservoir up to, but not exceeding, the Max Fill line (43 oz.).

OR

Fill the water reservoir to the Travel Mug line (16 oz.) with white vinegar, then fill the rest of the reservoir with water up to, but not exceeding, the Max Fill line (43 oz.).

IMPORTANT: Use only white vinegar.

- 3 Once the water reservoir is filled with your cleaning solution and water mixture, press the CLEAN button.
NOTE: To cancel the clean cycle, press the Power button or CLEAN button once. The unit will beep, and stop brewing through the cleaning mixture. Discard any remaining cleaning mixture in the reservoir and the carafe, and thoroughly clean each. Refill the reservoir with fresh water up to, but not exceeding, the Max Fill line, and set the empty carafe beneath the brew basket. Run a Full Carafe, Classic Brew with water only to remove any cleaning solution that could affect the flavor of your coffee.

IMPORTANT: If you cancel the clean cycle, your machine will not be properly descaled, and the CLEAN indicator light will remain on.

- 4 The clock will display and countdown the remaining clean cycle time, as this takes approximately 60 minutes to complete. Your Ninja Coffee brewer will deliver a small amount of cleaning solution to distribute it through the system. It will then pause for a half an hour, deliver additional cleaning solution, and pause for another half hour. The extended pauses allow for maximum cleaning and descaling.

⚠ CAUTION: DO NOT remove the carafe at any time throughout the clean cycle.

- 5 Upon completion, the brewer will beep, and the CLEAN light will turn off.
- 6 Empty and thoroughly clean the carafe and water reservoir with warm, soapy water to remove any cleaning solution that could affect the flavor of your coffee.
- 7 Fill the reservoir with fresh water up to, but not exceeding, the Max Fill line (43 oz.) and set the empty carafe beneath the brew basket.
- 8 Flush the system by running a Full Carafe, Classic Brew cycle with water only. After the cycle is complete, discard the water and thoroughly clean the carafe to remove any cleaning solution that could affect the flavor of your coffee.
NOTE: If the CLEAN light illuminates again, then calcium scale buildup is still present. Repeat the steps above and the CLEAN light will automatically shut off when your brewer is clean.

Please call Customer Service at 1-877-646-5288 to purchase descaling solution or if the brewer needs any servicing.



Troubleshooting Guide

PROBLEMS	POSSIBLE REASONS & SOLUTIONS
<p>My Ninja® Coffee brewer beeped and did not complete a full brewing cycle.</p>	<p>Ensure the water reservoir is locked in place and is filled with enough water for the desired brew.</p> <p>Check the Clean indicator light. If illuminated, run a clean cycle with the appropriate descaling solution or a white vinegar mixture. See Care & Maintenance section.</p> <p>Check the Drip Stop indicator light. If illuminated, ensure the brew basket is fully inserted into the brewer and the vessel is under the brew basket, then open the Drip Stop.</p> <p>If the Clean cycle was run and the Ninja Coffee brewer is still not completing the brew or the Clean light is flashing, you may have hard water and a critical amount of calcium buildup.</p> <p>If the problem persists, please call customer service at 1-877-646-5288.</p>
<p>There is sediment in my coffee.</p>	<p>If there is sediment at the bottom of the brewed coffee, this may be due to using finely ground coffee in a permanent filter.</p> <p>To reduce the amount of sediment in the brewed coffee use a slightly coarser grind or use a paper filter.</p>
<p>There are grounds in my coffee.</p>	<p>A filter must be in place when brewing (either the permanent filter or a paper filter). It is possible that the brew basket overflowed. Once cooled, clean out the brew basket and refill using the appropriate amount of coffee. Too many grounds can cause the brew basket to overflow. Alternatively, fine ground coffee can clog the brew basket. For best brewing results, use a medium-ground coffee.</p>
<p>The brew basket drips even after the brew cycle is completed.</p>	<p>Once the brew cycle is complete, move the drip stop to the closed position, denoted by a water droplet with a slash through it, before removing your brewing vessel.</p>
<p>Paper filter is folding over.</p>	<p>The Ninja Coffee brewer is designed to take a #4 cone filter. Be sure you are using this size and shape, as larger sizes may fold over. If not, allow the brew basket to cool before handling. The paper filters are thicker on two edges. Fold those edges along their creases (one along the bottom and one along the side) before inserting into the brew basket. Alternatively, you can wet the sides of the paper filter to temporarily adhere it to the brew basket.</p> <p>NOTE: When using a paper filter, do not use the permanent filter.</p> <p>If problem persists, try using a permanent filter.</p>
<p>Coffee is not hot enough.</p>	<p>Your Ninja Coffee brewer is equipped with a pre-heating function that ensures your cup of coffee as hot as it possibly can be. After turning on your Ninja Coffee brewer, the pre-heat notification will illuminate for 3 minutes as it warms up. Once it has warmed up to the proper temperature, the pre-heat notification will turn off, indicating it is time to brew.</p> <p>To brew the hottest possible cup with your Ninja Coffee brewer, keep it plugged in and powered on at all times to allow the brewing system to remain warm and ready to brew.</p> <p>IMPORTANT: DO NOT use hot water in the water reservoir. We recommend cool, fresh, filtered water.</p>
<p>Over Ice Brew is not cold.</p>	<p>The Over Ice Brew is designed to brew hot coffee over ice to lock in the flavor for rich, smooth iced coffee. Make sure your cup, travel mug, or carafe is filled all the way to the top with ice cubes.</p>



PROBLEMS	POSSIBLE REASONS & SOLUTIONS								
Weak coffee.	For stronger coffee, try the Rich Brew setting using dark roast beans and the permanent filter in your brew basket (rather than a paper filter). If you want an even bolder flavor, you can add more coffee grounds to the brew basket — just keep in mind that the additional grounds do absorb liquid, so you will wind up with a more concentrated, smaller cup of coffee.								
Coffee is too strong.	For milder coffee, try the Classic Brew setting using light roast beans and a paper filter in your brew basket (rather than the permanent filter). If you want an even milder flavor, you can put less coffee in the brew basket — just keep in mind that grounds do absorb liquid during the normal brew cycle, so you will wind up with a less concentrated, larger cup of coffee.								
Brew will not start.	<p>Ensure the unit is powered on and the display is illuminated. If there are no lights, it means the machine is not getting power. Try a different outlet and press the Power button. Check to make sure there is water in the water reservoir.</p> <p>Make sure the Drip Stop is open, as the machine will beep 5 times and the brew cycle will not start if the Drip Stop is in the closed position. If the Drip Stop LED is illuminated, and the Drip Stop is in the open position, it means the brew basket was inserted incorrectly. Reinsert the brew basket by aligning it with the rails and slide it into the brewer until it clicks in place.</p> <p>If the above actions have not stopped the beeping, it may be time to run the clean cycle. Please refer to the Care & Maintenance section.</p> <p>NOTE: The brew will begin, stop, and be quiet for a short period of time before it begins again. This process is used to evenly saturate the coffee grounds.</p>								
Brew cycle is too slow.	<p>A carafe brew will take approximately 8 minutes and a single-cup brew will take approximately 4 minutes.</p> <p>If the brew cycle is taking longer than normal, run the clean cycle with descaling solution.</p>								
My cup, travel mug, or carafe overflowed.	<p>The cup, travel mug, or carafe may not have been empty prior to brewing.</p> <p>The water exceeded the Max Fill line on the water reservoir prior to brewing.</p> <p>The Ninja® Coffee brewer is designed to dispense the following amounts on classic brew:</p> <table border="0" data-bbox="365 1055 559 1152"> <tr> <td>Cup</td> <td>9.5 oz.</td> </tr> <tr> <td>Travel Mug</td> <td>14 oz.</td> </tr> <tr> <td>Half Carafe</td> <td>21 oz.</td> </tr> <tr> <td>Carafe</td> <td>38 oz.</td> </tr> </table> <p>Please ensure you are using at least a 12 oz. cup for the Cup size and a 16 oz. travel mug for the Travel Mug size.</p> <p>NOTE: With Rich Brew and Over Ice Brew there will be less volume dispensed.</p>	Cup	9.5 oz.	Travel Mug	14 oz.	Half Carafe	21 oz.	Carafe	38 oz.
Cup	9.5 oz.								
Travel Mug	14 oz.								
Half Carafe	21 oz.								
Carafe	38 oz.								
Brew basket overflowed.	<p>The bottom opening is clogged. This can happen with finely ground coffee or too many coffee grounds in the brew basket.</p> <p>Medium-ground coffee is recommended.</p>								
There is water left in my reservoir.	<p>Fill the reservoir with water up to, but not exceeding, the Max Fill line and Auto-iQ™ One Touch Intelligence will use the exact amount of water needed for each brew size and style selected.</p> <p>After brewing you may notice leftover water in your reservoir.</p> <p>The markings on the water reservoir indicate the minimum amount of water to be used for each brew size, but all brew styles use different amounts of water to create the proper flavor and richness.</p>								

Troubleshooting Guide - cont.

PROBLEMS	POSSIBLE REASONS & SOLUTIONS
Will coffee pods work with the Ninja Coffee brewer?	This brewer is designed to brew coffee grounds only. Do not insert pods or K-Cups®.
My Ninja Coffee brewer is leaking.	<p>Ensure you are filling your water reservoir up to, but not exceeding, the Max Fill line. After removing the water reservoir, there may be a small amount of water in the reservoir valve. This can be easily removed with a dry cloth.</p> <p>If the leak is coming from the brew basket, make sure that all parts are assembled correctly and securely.</p> <p>If the leak is coming from the bottom of the brewer, call customer service at 1-877-646-5288.</p>
Why is the second cup that I brewed hotter than the first brew?	Once the Ninja® Coffee brewer has brewed the first cup, the brewer is pre-warmed. This enables any following brews to be slightly hotter. For a hotter first cup, after plugging in and turning on your brewer by pressing the Power button, allow 3 minutes for your brewer to pre-heat.
How long does it take to pre-heat to get the hottest cup?	After turning on your Ninja Coffee brewer, the pre-heat notification will illuminate for 3 minutes as your brewer warms up. Once it has warmed up to the proper temperature, the pre-heat notification will turn off indicating it is time to brew.
What impacts coffee brew volume?	<p>When you make hot coffee, the coffee grounds will absorb some of the water that is brewed, resulting in slightly less brewed coffee than the water used. The more coffee you use, the more water will be absorbed. Additionally, our wider bottom carafe holds most of the coffee at the base, which helps control the temperature more evenly.</p> <p>Classic Brew:</p> <div style="display: flex; justify-content: space-around; align-items: center;"> <div style="text-align: center;">  <p>Full Carafe</p> </div> <div style="text-align: center;">  <p>Half Carafe</p> </div> </div>
How does the Ninja Coffee brewer keep coffee at the right temperature?	The carafe is designed to keep most of the coffee volume in the bottom so it will be closer to the Intelligent Temp Warming plate. This helps maintain the coffee at the ideal drinking temperature.

*K-Cup is a registered trademark of Keurig Green Mountain, Inc. Use of the K-Cup trademark does not imply any affiliation with or endorsement by Keurig Green Mountain, Inc.

Replacement Parts

ORDERING REPLACEMENT PARTS

To order additional parts and attachments, please visit our website: ninjaaccessories.com or contact customer service: **1-877-646-5288**.



Shark | NINJA

ONE (1) YEAR LIMITED WARRANTY

SharkNinja Operating LLC warrants this product to be free from material defects and workmanship for a period of one (1) year from the date of purchase when utilized for normal household use, subject to the following conditions, exclusions and exceptions.

The liability of **SharkNinja Operating LLC** is limited solely to the cost of the repair or replacement of the unit at our option. This Limited Warranty does not cover normal wear of parts and does not apply to any unit that has been tampered with or used for commercial purposes. This Limited Warranty does not cover damage caused by misuse, abuse, negligent handling or damage due to faulty packaging or mishandling in transit. This Limited Warranty does not cover damage or defects caused by or resulting from damages from shipping or from repairs, service or alteration to the product or any of its parts, which have been performed by a repair person not authorized by **SharkNinja Operating LLC**.

If your appliance fails to operate properly while in use under normal household conditions within the warranty period, return the complete appliance and accessories, freight prepaid. For assistance with warranty service options or customer support, please call our customer care and product specialists at 1-877-646-5288 or visit our website: ninjakitchen.com/warranty.

If the appliance is found to be defective in material or workmanship, **SharkNinja Operating LLC**, will repair or replace it free of charge. Proof of purchase is required and a fee of \$19.95 will apply to cover the cost of return freight.*

This Limited Warranty is extended to the original purchaser of the unit and excludes all other legal, implied and/or conventional warranties. The responsibility of **SharkNinja Operating LLC** if any, is limited to the specific obligations expressly assumed by it under the terms of this Limited Warranty. In no event is **SharkNinja Operating LLC** liable for incidental or consequential damages to anyone of any nature whatsoever. Some states do not permit the exclusion or limitation of incidental or consequential damages, so the above may not apply to you.

This Limited Warranty gives you specific legal rights, and you may also have other rights which vary from state to state or from province to province.

***IMPORTANT: Carefully pack item to avoid damage in shipping. Be sure to include proof of purchase date and to attach tag to item before packing with your name, complete address and phone number with a note giving purchase information, model number, and what you believe is the problem with the item. We recommend you insure the package (as damage in shipping is not covered by your Limited Warranty). Mark the outside of your package "ATTENTION CUSTOMER SERVICE".**

Product Registration

Please visit registryourninja.com or call 1-877-646-5288 to register your new Ninja® product within ten (10) days of purchase. You will be asked to provide the store name, date of purchase and model number along with your name and address.

The registration will enable us to contact you in the unlikely event of a product safety notification. By registering, you acknowledge to have read and understood the instructions for use, and warnings set forth in the accompanying instructions.



VISIT US ONLINE AT:

ninjakitchen.com

Or follow us on any of our social media pages:



fb.me/ninjacoffeebar



youtube.com/ninjacoffeebar



@ninjacoffeebar



pinterest.com/ninjakitchen



@ninjacoffeebar

SharkNinja Operating LLC

US: Needham, MA 02494

CAN: Ville St-Laurent, QC H4S 1A7

1-877-646-5288

ninjakitchen.com

Copyright © 2017 SharkNinja Operating LLC

For SharkNinja U.S. Patent information, visit sharkninja.com/USPatents.

Ninja and Thermal Flavor Extraction are registered trademarks of SharkNinja Operating LLC.

Auto-iQ is a trademark of SharkNinja Operating LLC.

Printed in China

Illustrations may differ from actual product. We are constantly striving to improve our products, therefore the specifications contained herein are subject to change without notice.

CF020_69_170320_1