

# NINJA

## COFFEE BAR™

CF085Z

OWNER'S GUIDE



[www.ninjacoffeebar.com](http://www.ninjacoffeebar.com)

1-877-646-5288

# IMPORTANT SAFEGUARDS

## For Household Use Only

### READ ALL INSTRUCTIONS BEFORE USING YOUR NINJA COFFEE BAR™.

#### Safety Signal Words

This manual and the safety labels attached to this appliance utilize signal words that signify safety hazards with different levels of severity.

Below are the words used and the definitions for these words:

- **WARNING** indicates a hazardous situation which, if not avoided, could result in death or serious injury.
- **CAUTION** indicates a hazardous situation which, if not avoided, could result in minor or moderate injury.
- **NOTICE** is used to address practices not related to physical injury.

The words “**WARNING**” and “**CAUTION**” are preceded by a triangle signifying that these are safety related.

The terms “**IMPORTANT**” and “**NOTE**” are also used to describe good ideas for better and more efficient equipment use.

---

#### THIS BOOK COVERS MODEL NUMBERS:

CF085Z

#### TECHNICAL SPECIFICATIONS

Voltage: 120V~, 60Hz.

Power: 1400 Watts

Water Reservoir

Capacity: 43 Ounces

### **WARNING:**

To reduce the risk of fire, electric shock, serious injury, death or damage when using this appliance, follow these basic safety precautions.

#### General Precautions

- 1 Do not allow young children to operate the appliance or use as a toy. Close supervision is necessary when any appliance is used near children.
- 2 To reduce the risk of electric shock, this appliance has a polarized plug (one blade is wider than the other). As a safety feature, this plug will fit into a polarized outlet only one way. If the plug does not fit fully into the outlet, reverse the plug. If it still does not fit, contact a qualified electrician. Do not force into outlet or try to modify to fit.
- 3 To protect against electrical shock, do not submerge the appliance or allow the power cord to come into contact with water or any other liquid.
- 4 Allow the appliance to cool before taking off parts and before cleaning.
- 5 Do not abuse the power cord. Never carry the appliance by the power cord or yank it to disconnect from electrical outlet; instead grasp the plug and pull to disconnect.
- 6 Do not operate any appliance with a damaged cord or plug, or after the appliance malfunctions, has been dropped or damaged in any manner.
- 7 Do not let the power cord hang over the edge of table or counter or touch hot surfaces such as the stove.

- 8 Extension cords are not recommended for use with this product.
- 9 Do not remove the brew basket or carafe while the appliance is brewing. **Scalding may occur if any of these parts are removed during brewing cycles.**
- 10 The use of an accessory not recommended by the manufacturer may result in fire, electric shock, create an overflow condition and scalding hazard or personal injury.
- 11 Do not operate your appliance in an appliance garage or under a wall cabinet. When storing in an appliance garage always unplug the unit from the electrical outlet. Not doing so could create a risk of fire, especially if the appliance touches the walls of the garage or the door touches the unit as it closes.
- 12 Clogging and backing up of water and/or coffee in the filter basket can occur under any or a combination of any of the following conditions: The use of too finely ground coffee, using two or more paper filters, using a permanent filter in conjunction with a paper filter, not cleaning coffee grounds from a permanent filter, or allowing coffee grounds to spill over the filter.
- 13 Always use appliance on a dry, level surface.
- 14 Do not use this appliance for anything other than its intended use. Do not use outdoors.
- 15 Do not touch hot surfaces. Use handles or knobs.
- 16 The carafe is designed for use with this appliance. It must never be used on a range top.
- 17 Do not place carafe in microwave.
- 18 Do not use a carafe having a loose or weakened handle.
- 19 Do not clean carafe with abrasive cleansers, steel wools pads, or other abrasive material.
- 20 Do not place on or near a hot gas or electrical burner, or in a heated oven.
- 21 Do not use for carbonated beverages.
- 22 Do not drink directly from the carafe. Liquid from the carafe may be very hot.
- 23 Do not use the carafe to store any other type of food when not in use.
- 24 Do not place carafe in dishwasher.
- 25 Ensure that the carafe is completely empty before starting a cleaning or brewing cycle. Starting a cycle with water or coffee in the carafe will cause an overflow.

#### Operating Notice

- 12 Clogging and backing up of water and/or coffee in the filter basket can occur under any or a combination of any of the following conditions: The use of too finely ground coffee, using two or more paper filters, using a permanent filter in conjunction with a paper filter, not cleaning coffee grounds from a permanent filter, or allowing coffee grounds to spill over the filter.
- 13 Always use appliance on a dry, level surface.
- 14 Do not use this appliance for anything other than its intended use. Do not use outdoors.
- 15 Do not touch hot surfaces. Use handles or knobs.

#### Thermal Carafe

- 16 The carafe is designed for use with this appliance. It must never be used on a range top.
- 17 Do not place carafe in microwave.

#### Maintenance

- 26 Remove the power cord from the electrical outlet, allow to cool before removing brew basket, water reservoir, or filters before surface cleaning.
- 27 If the product is not operating properly contact SharkNinja Operating LLC at 1-877-646-5288 or [www.ninjacoffeebar.com](http://www.ninjacoffeebar.com) for examination, repair or adjustment.

#### Cord Statement

28. A short power-supply cord is provided to reduce the risks resulting from becoming entangled in or tripping over a longer cord.
29. Do not use extension cord with this product.

# SAVE THESE INSTRUCTIONS

## FCC Statement

This device complies with part 15 of the FCC rules. Operation is subject to the following two conditions:

- 1) This device may not cause harmful interference, and
- 2) This device must accept any interference received, including interference that may cause undesired operation.

This equipment has been tested and found to comply with the limits for a Class B digital device, pursuant to Part 15 of the FCC rules. These limits are designed to provide reasonable protection against harmful interference in a residential installation. This equipment generates, uses and can radiate radio frequency energy and, if not installed and used in accordance with the instructions, may cause harmful interference to radio communications. However, there is no guarantee that the interference will not occur in a particular installation. If this equipment does cause harmful interference to radio or television reception, which can be determined by turning the equipment off and on, the user is encouraged to try to correct the interference by one or more of the following measures:

- a) Reorient or relocate the receiving antenna.
- b) Increase the separation between the equipment and the receiver.
- c) Connect the equipment into an outlet different from that which the receiver is connected.
- d) Consult the dealer or an experienced radio/TV technician for help.

## Contents

Thank you for  
purchasing the  
Ninja Coffee  
Bar™.

Getting To Know Your Ninja Coffee Bar™ .....	5
Control Panel .....	6
Features Of The Ninja Coffee Bar™ .....	7
Before First Use .....	8
Setting The Clock And Delay Brew .....	9
Assembly .....	10
Preparing For Use .....	11
Filling The Water Reservoir .....	11
How Much Coffee Do You Get In Your Cup.....	11
Would You Like A Hotter Coffee .....	12
Filling The Brew Basket With Coffee .....	12
Drip Stop .....	13
Brewing Coffee .....	13
Classic And Rich Brew .....	13
Over Ice Brew .....	14
Specialty Brew .....	14
Care & Maintenance .....	15
Cleaning After A Brew .....	15
How To Clean & Descale .....	15
Troubleshooting Guide .....	16
Replacement Parts .....	18
Warranty & Registration .....	22

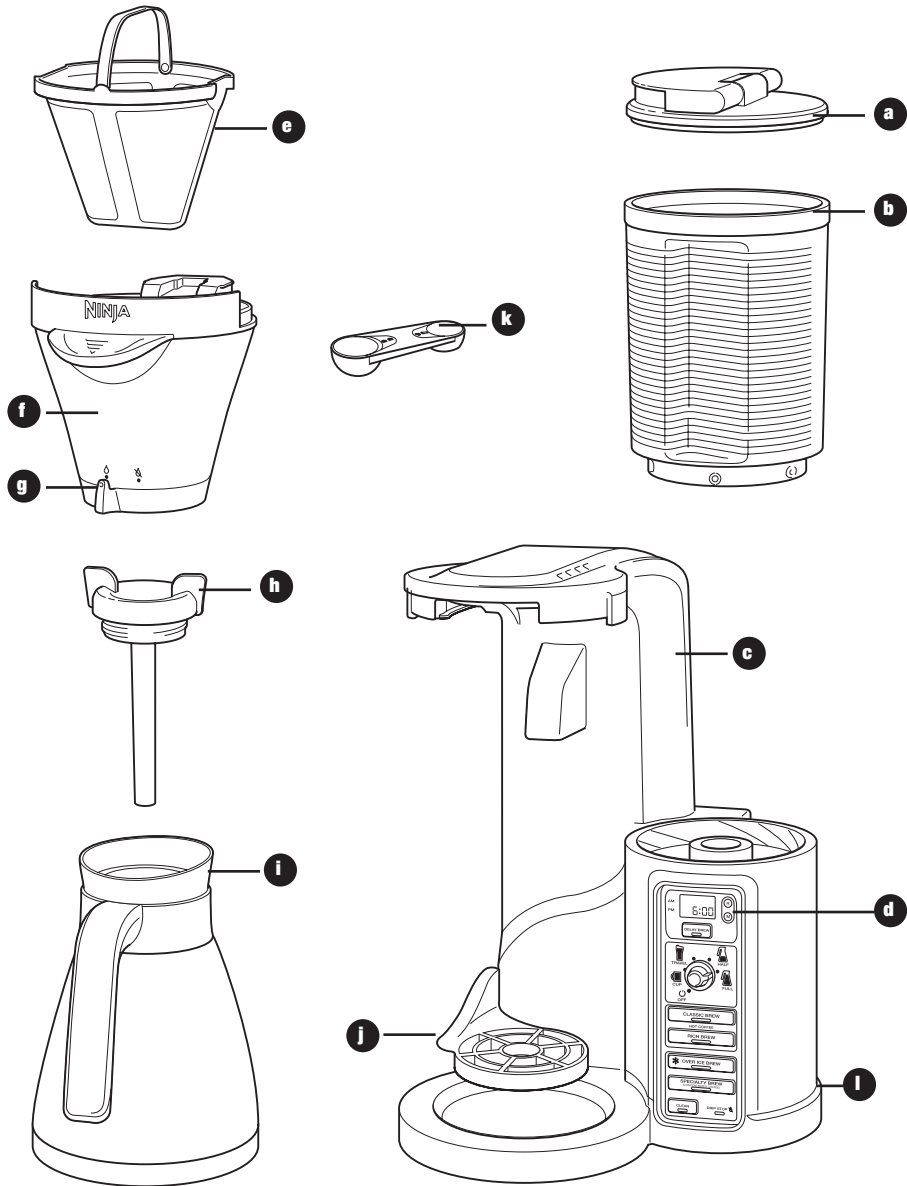

- a Flip Top Water Reservoir Lid
- b Removable Water Reservoir
- c Brewer
- d Control Panel
- e Permanent Filter
- f Removable Brew Basket
- g Drip Stop Toggle
- h Brew-through Carafe Lid
- i Thermal Carafe
- j Multi-Serve Cup Platform
- k Double Sided Scoop: Carafe Side and Single Serve Side
- l Power Cord & Wrap (not shown)

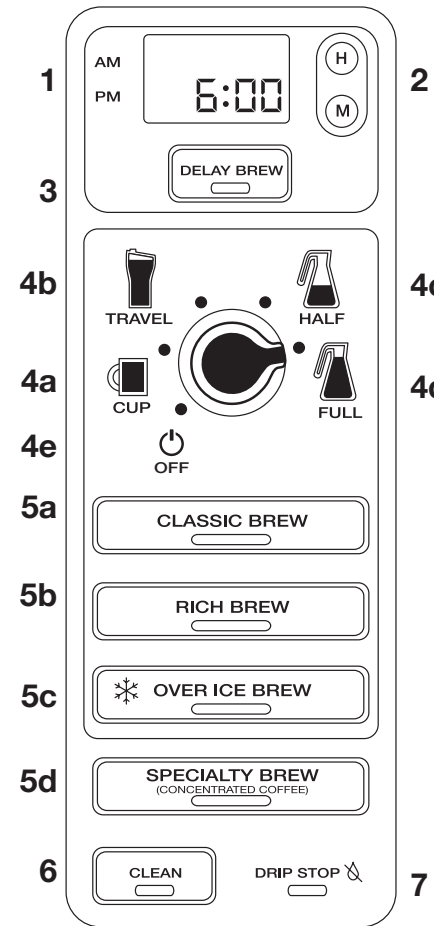

- 1 Programmable Digital Clock
- 2 Clock Hour and Minute Buttons
- 3 Delay Brew Button
- 4 Multi-Serve Dial
  - a Cup
  - b Travel Mug
  - c Half Carafe
  - d Full Carafe
  - e Off - Turns off all functions except the clock
- 5 Brew Type
  - a Classic Brew Button
  - b Rich Brew Button
  - c Over Ice Brew Button
  - d Specialty Brew Button
- 6 Intelligent Clean Cycle Indicator/Button
- 7 Drip Stop Indicator

## Features of the Ninja Coffee Bar™

- **Thermal Flavor Extraction Technology** - Blends Precision Water Delivery with automated controls for Calibrated Temperature, Pre-infusion, Coffee Saturation, and Flavor Richness. Ninja®'s Thermal Flavor Extraction technology can truly unlock the full flavor potential of your coffee.
- **Multi Serve** – Ability to brew directly into your favorite cup, travel mug, or carafe.
- **Brew Types** – control the strength and style of your coffee:
  - a. Classic Brew for smooth, balanced hot coffee.
  - b. Rich Brew for a richer-than-classic and still smooth coffee with more room for milk and cream.
  - c. Over Ice Brew for a smooth, rich, freshly brewed iced coffee that's not watered down.
  - d. Specialty Brew for a strong extract for specialty milk-based drinks or blended iced drinks.
- **Multi Serve Cup Platform** – Pull it down and place your favorite cup on it and brew directly into it.
- **Removable Water Reservoir with Easy Access Flip Top Lid** – For quick and easy filling.
- **Auto-iQ™** – The Ninja Coffee Bar™ knows how much water to use for each size and brew type.
- **43 oz Thermal Carafe**
- **LED Control Panel with Programmable Digital Clock**
- **24-HR Programmable Delay Brew Button** – Set it to automatically brew the following morning.
- **Drip Stop** – Stops the flow of coffee from the brew basket allowing you to pour a cup mid-brew; switch toggle to the closed position to prevent dripping once the brew cycle is finished.
- **Clean Function** – It illuminates when your Ninja Coffee Bar™ senses that there is hard water calcium buildup in your brewer which can affect the flavor of your coffee. When it illuminates, follow the cleaning instructions in the Care & Maintenance section or printed on the back of your brewer.
- **Audible Ready Signal** – Alerts you that your coffee is ready.
- **Permanent Filter** - The permanent filter is a reusable filter that preserves the natural coffee oils and small coffee particles to provide a robust flavor, similar to what you would experience when using a French press.

Go to [www.ninjacoffeebar.com](http://www.ninjacoffeebar.com) for more information and how-to videos.

### Multi Serve

Brew into a cup, travel mug, or a classic carafe or half carafe.

Cup

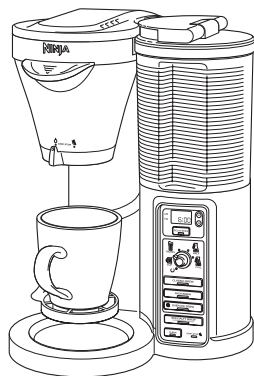

Travel Mug

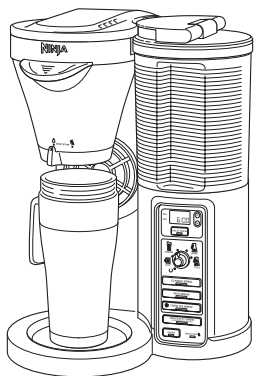

Classic Carafe or Half Carafe

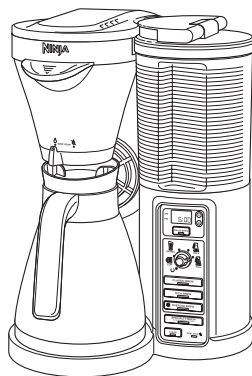

## Before First Use

### PLEASE KEEP THESE IMPORTANT SAFEGUARDS IN MIND WHEN USING THE APPLIANCE:

- ⚠️ **CAUTION: APPLIANCE CREATES HOT LIQUID. HANDLE WITH CARE.**
- ⚠️ **CAUTION: DO NOT remove the vessel while the appliance is running without the Drip Stop in the closed position. Return the vessel quickly and open the Drip Stop to continue the brew.**
- ⚠️ **CAUTION: DO NOT place the thermal carafe in the dishwasher.**
- ⚠️ **CAUTION: Never open the brew basket when the coffeemaker is in use.**
- ⚠️ **CAUTION: Please ensure that you are using at least a 12 oz. cup for the cup size and a 16 oz. travel mug for the travel mug size to prevent overflow and a scalding injury.**

**IMPORTANT: DO NOT run the appliance without water.**

**IMPORTANT: Always place a vessel beneath the brew basket to receive the brewed coffee.**

**IMPORTANT: DO NOT overfill the water reservoir, fill water only to the Max Fill line.**

- 1 Remove all packaging material, stickers and labels from the brewer.  
**NOTE:** The thermal carafe is NOT dishwasher safe.
- 2 Wash the water reservoir, permanent filter, thermal carafe and brew basket in warm, soapy water with a soft cloth.
- 3 Rinse and dry thoroughly.
- 4 Before first use, run two full carafe cycles with water only and discard water.

## Setting the Clock & Delay Brew

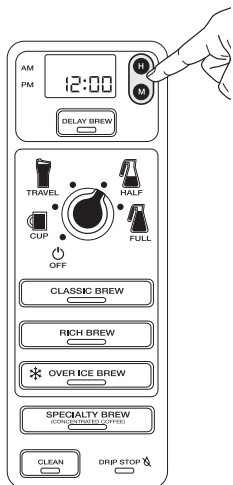

Fig. 1

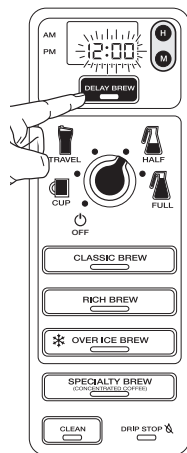

Fig. 2



Fig. 3

### TO SET THE CLOCK

- 1 Plug the power cord into an electrical outlet. The clock will flash on the control panel to indicate that the time has not been set. (Fig. 1)
- 2 Press the H (hour) or M (minute) button until you reach the current time. The AM or PM indicator will illuminate on the left side of the display as you are setting the time. (Fig. 2)
- 3 After 5 seconds the clock will stop flashing and the clock will be set.

**NOTE:** If the clock stops flashing and does not display the correct time of day, pressing the H (hour) or the M (minute) button at any time will again cause the clock to flash again. You can now re-program the correct time of day by following the steps above.

**NOTE:** If you unplug the brewer or in the event of an extended power loss, you will need to reset the clock the next time the brewer is plugged in.

### TO SET THE DELAY BREW TIME

- 1 Press Delay Brew. The Delay Brew button will illuminate and the clock will begin to flash "12:00" or the last delay brew time that was set. (Fig. 2)
- 2 While the clock is flashing, press the H (hour) or M (minute) button to set the time that you would like the delay brew to begin. The AM or PM indicator will illuminate on the left side of the display as you are setting the desired time.
- 3 Once the proper time has been set, select the size of the vessel that you would like to brew.

- 4 Select the Brew Type that you desire from the 4 flashing buttons. The selected brew type will be lit. (Fig. 3)
- 5 Once the time, brew size, and brew type have been set, allow the Delay Brew to flash and lock in or press the Delay Brew button to activate the Delay Brew. When the Delay Brew is activated, the light on the Delay Brew button will illuminate and an audible signal will play to verify the Delay Brew is set.
- 6 The Delay Brew time is now set and your Ninja Coffee Bar™ will automatically brew at the time you programmed.

**NOTE:** To deactivate the Delay Brew cycle, press the Delay Brew button once more and the light on the Delay Brew button will turn off. Any change to the selected brew size or starting any other brew will cancel the programmed Delay Brew.

- 7 Place the appropriate-sized vessel under brew basket for the selected size.

**IMPORTANT:** Make sure the Drip Stop is in the open position.

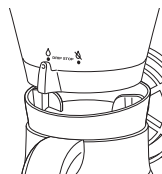

Go to [www.ninjacoffeebar.com](http://www.ninjacoffeebar.com) for more information and how-to videos.

## Assembly

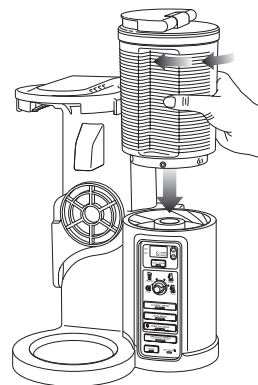

Fig. 4

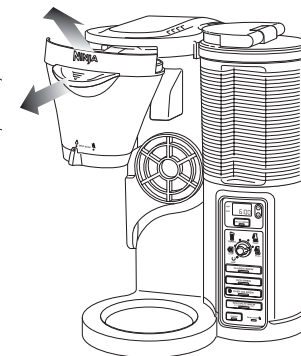

Fig. 5

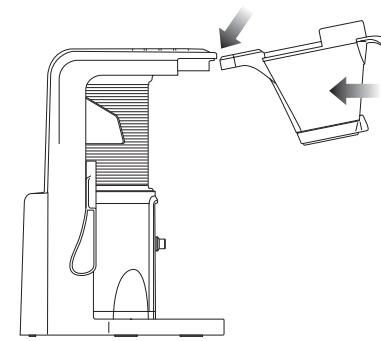

Fig. 6

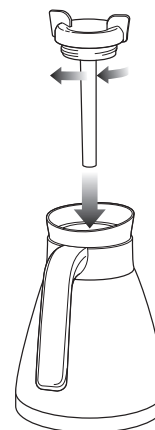

Fig. 7

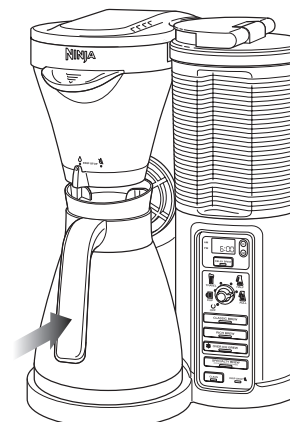

Fig. 8



Fig. 9

- 1 Place the brewer on a dry, clean and level surface.

- 2 Holding the water reservoir by the grip, twist counterclockwise to remove. Either flip the lid top over or remove lid by twisting counterclockwise to remove. Fill with water up to, but not exceeding the Clean Cycle Max Fill line (30 oz.). To replace the water reservoir, place on top of the base and twist clockwise until a click indicates it is locked in place. (Fig. 4)



- 3 Slide brew basket out and angle up slightly to remove it from the brewer. (Fig. 5) To reinsert, align the brew basket with the rails and slide back into the brewer. (Fig. 6)

- 4 Once the brew basket is in place, slide all the way into place until you hear a slight click.

- 5 Twist the brew-through lid clockwise onto the thermal carafe to lock into place. (Fig. 7)

- 6 Center the thermal carafe below the brew basket. (Fig. 8)

**NOTE:** Do not use any coffee for the first two brew cycles in order to clean the brewer.

- 7 Plug the brewer into an electrical outlet.

- 8 Once all parts are securely in place, press the Clean button to thoroughly clean the machine before first use. (Fig. 9)

- 9 Discard the water in the carafe and repeat, beginning from step 2, with one more clean cycle of water before first use.



## Preparing for Use

- CAUTION:** Only fill water reservoir up to, but not exceeding the Max Fill line with water; we recommend fresh, cool, filtered water. Do not fill water reservoir with any other liquids such as brewed coffee, carbonated beverages, etc. as other liquids may damage your brewer.

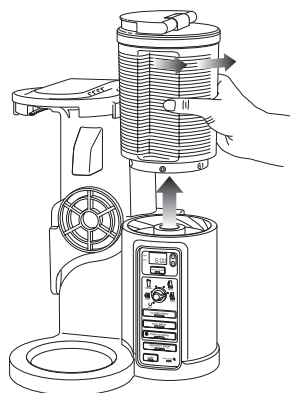

Fig. 10



Fig. 11a

OR

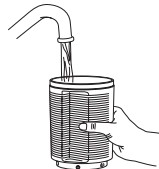

Fig. 11b

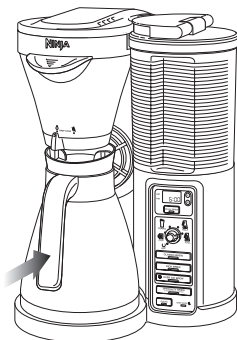

Fig. 12

### FILLING THE WATER RESERVOIR

- For easy filling, remove the water reservoir by slightly twisting counterclockwise until it is free from the brewer. (Fig. 10)
- Either flip the lid top over or remove lid by twisting counterclockwise to remove. (Fig. 11a, Fig. 11b)

**NOTE:** The water reservoir and water reservoir lid can lock in multiple locations.

- For best results, fill the water reservoir with fresh, cool, filtered water. Ensure that the water is above the minimum fill line for the brew size that is selected. Do not exceed the Max Fill line. The machine's intelligence will automatically measure the amount of water needed. To avoid refilling after each cup, fill to the carafe line.

**NOTE:** Do not fill past the Max Fill line or water will begin to overflow from the overflow hole at the top of the hand grip. Remove the water reservoir from the brewer and empty to the Max Fill line.

**Depending on the size and brew type, you may have water left in the reservoir.**

- Place the water reservoir back on the brewer and twist clockwise until you feel the reservoir lock into place.
- Place the vessel that you would like to brew into underneath the brew basket—ensure that the vessel is centered under the brew basket. (Fig. 12)

**NOTE:** After removing the water reservoir, there may be a small amount of water in the reservoir valve. This can be easily removed with a dry cloth.

### HOW MUCH COFFEE DO YOU GET IN YOUR CUP?

Each size and brew type produces a different amount of coffee to optimize strength, taste, and size.

**NOTE:** The coffee grounds will absorb some of the water that is brewed, resulting in slightly less brewed coffee than water used.

**CAUTION:** Please ensure that you are using at least a 12 oz. cup for the cup size and a 16 oz. travel mug for the travel mug size.

### APPROXIMATE BREW VOLUME

Size/Brew	Classic	Rich	Specialty
Cup	9.5 oz.	8.8 oz.	3.1 oz.
Travel Mug	14 oz.	13.2 oz.	4 oz.
Half Carafe	19 oz.	17.8 oz.	5 oz.
Full Carafe	38 oz.	35.5 oz.	10 oz.

Size/Brew	Over Ice	
	Coffee Only	With Ice
Cup	3.7 oz.	9.5 oz.
Travel Mug	5.8 oz.	14 oz.
Half Carafe	7.6 oz.	19 oz.
Full Carafe	15.8 oz.	38 oz.

## WOULD YOU LIKE A HOTTER COFFEE?

Have you ever wondered why you get paper cups on the go? The type of cup you brew into can drastically influence the drinking temperature!

	CERAMIC CUP			NINJA® CUP	PAPER CUP
<b>Cup Temperature</b>	Room Temperature	Pre-warmed with hot water	Pre-warmed in microwave with milk	Room Temperature	Room Temperature
<b>Drinking Temperature</b>	Hot 	Hotter 	Hotter 	Hotter 	Hottest 
<b>Why is there a difference?</b>	A cold ceramic mug will steal heat from the coffee as it warms itself up.	If the mug is already warm, it will not steal as much heat from the coffee.	Just like your cold mug, cold milk lowers the temperature of your coffee.	The Ninja double wall cup is designed to retain initial coffee temp better than a ceramic cup.	Unlike a ceramic mug, a thinner paper cup does not steal substantial heat from the coffee.

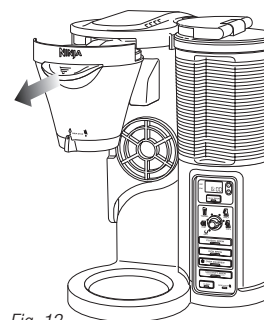

Fig. 13

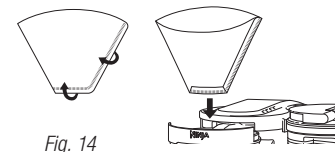

Fig. 14

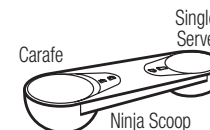

Fig. 15a

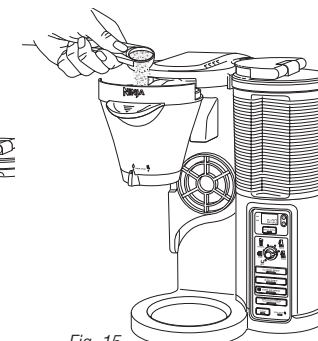

Fig. 15

### FILLING THE BREW BASKET WITH COFFEE

For best results, use the below measurements of ground coffee for each size brew—the amount of ground coffee for each size will remain the same for any brew type that you select. For example, if you select Cup and Classic Brew, you will use the same amount of coffee grounds as if you select Cup and Specialty Brew.

**CAUTION:** The maximum capacity for ground coffee is 12 rounded tablespoons or 6 Ninja Carafe Scoops. Exceeding this amount or using fine ground coffee may cause overflow.

- Open the brew basket by sliding the brew basket out of the brewer. (Fig. 13)

**NOTE:** The brew basket can be removed from the brewer by lifting the brew basket at a slight upward angle (similar to a cabinet drawer).

**NOTE:** Check for any loose grounds that may be left in the brew basket. Remove and rinse the brew basket if needed.

- Place the permanent filter or a #4 paper cone filter in the brew basket. If using a paper cone filter, remove the permanent filter, fold along the seams, open it fully, and firmly press it into the brew basket making sure that it is fully seated. (Fig. 14)

- Use the Ninja Scoop (Fig. 15a) and follow the measurements below to fill the filter. These measurements are based on level scoops—adjust to your preferred taste. (Fig. 15) We suggest using a medium grind size if grinding whole beans.

Single Serve	Ninja® Scoop (Single Serve Side)	Tablespoon
Cup	2–3 scoops	2–3 Tbsp.
Travel Mug	3–4 scoops	3–4 Tbsp.
Carafe	Ninja® Scoop (Carafe Side)	Tablespoon
Half Carafe	2–3 scoops	5–7 Tbsp.
Full Carafe	4–6 scoops	8–12 Tbsp.

**NOTE:** Exceeding the recommended medium grind size for whole beans and 6 Ninja Carafe Scoops may cause the brew basket to overflow.

- Slide the brew basket back into the brewer and click in place.

## Preparing for Use - cont.

- ⚠ **CAUTION: HOT WATER** Do not remove the brew basket or vessel while brewing.
- ⚠ **CAUTION: STEAM** Do not touch steam vents or the top of the brewer while brewing.
- ⚠ **CAUTION: The brew basket is hot after brewing.** Always allow the brewer to cool down before cleaning.

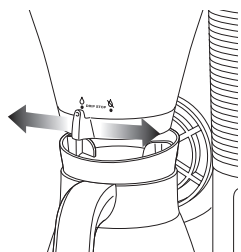

Fig. 16

### DRIP STOP

**NOTE: If the Drip Stop is closed before you begin a brew, the brewer will notify you with 5 beeps. Set the Drip Stop to the open position and select your brew concentration level.**

### CAN'T WAIT FOR THAT FIRST CUP TO BE READY?

When brewing a carafe close the Drip Stop to pause the brew cycle and pour a cup. Remember to reopen the Drip Stop to complete the brew. (Fig. 16)

**NOTE:** If you forget to open the Drip Stop, the Ninja Coffee Bar™ will pause the brew, and after 20 seconds it will give you a friendly audible reminder. After 6 minutes the brew will be canceled.

### CAN'T WAIT FOR THE LAST FEW DROPS?

When the brew cycle is complete, set the Drip Stop to the closed position to stop dripping from the brew basket.

**NOTE:** While the Drip Stop is closed the Drip Stop indicator will light up in the bottom right hand corner of the control panel.

**NOTE:** Remember to open the Drip Stop when you're ready to brew again. If you forget, your Ninja Coffee Bar™ will give you a friendly audible reminder.

### BREWING COFFEE

**NOTE: Each brew has a pre-infusion cycle with varying times. The brew will begin, stop, and be quiet for a short period of time before it begins again. This process is used to evenly saturate your coffee grounds.**

**NOTE:** For a hotter coffee, rinse the coffee cup, mug or thermal carafe with hot water prior to brewing.

⚠ **CAUTION: Ensure the carafe is completely empty before starting a brewing cycle. Starting a brewing cycle with coffee in the carafe will cause an overflow.**

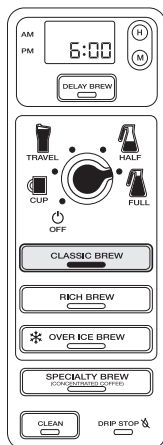

Fig. 17

### CLASSIC OR RICH BREW

**Classic Brew** - For a smooth, balanced flavor.

**Rich Brew** - For a coffee that is richer than Classic Brew and still smooth, with more room for milk and cream.

- After filling the water reservoir and adding ground coffee to the filter, be sure that the Drip Stop is open and the reservoir, basket, and filter are securely in place.
- Use the multi-serve dial to select the size of coffee you would like to brew. Place the empty vessel that you would like to brew into underneath the brew basket.
 

**NOTE:** If making a single cup, lower the multi-serve cup platform down and center the cup or mug on the cup platform. Please ensure that you are using at least a 12 oz. cup for the cup size and a 16 oz. travel mug for the travel mug size.
- Press the Classic Brew or the Rich Brew button and the brew will begin. (Fig. 17, Fig. 18) Press the Classic or Rich button again or turn the Multi-Serve Size dial to Off to cancel the brew.

**NOTE: The brew will begin, stop, and be quiet for a short period of time before it begins again. This process is used to evenly saturate your coffee grounds.**

**NOTE:** Do not remove water reservoir, brew basket, or vessel while brewing.

- The Ninja Coffee Bar™ will beep to signal a completed brew.

**NOTE:** Rich Brew will use slightly less water and yield slightly less brewed coffee than Classic Brew.

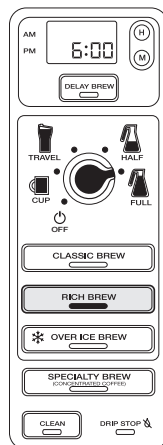

Fig. 18

### OVER ICE BREW

Designed to brew hot coffee over ice to lock in the flavor for a rich, freshly brewed, smooth iced coffee without becoming watered down. Be sure your vessel is filled with ice before brewing.

⚠ **CAUTION: DO NOT USE GLASSWARE.**

- After filling the water reservoir, add ground coffee to the filter (feel free to add more coffee if you like a stronger taste), be sure that the Drip Stop is open, reservoir, basket, and filter are securely in place.
- Use the multi-serve dial to select the size of coffee that you would like to brew.
- Before brewing, fill the desired vessel to the top with ice cubes and place the vessel below the brew basket. Press "Over Ice Brew" and the brew will begin. (Fig. 19) Press the Over Ice button again or turn the Multi-Serve Size dial to Off to cancel the brew.

**IMPORTANT: Always fill the desired vessel to the top with ice before placing it below the brew basket. Do not add ice to the water reservoir.**

**NOTE: The brew will begin, stop, and be quiet for a short period of time before it begins again. This process is used to evenly saturate your coffee grounds.**

**NOTE:** If making a Carafe of Over-Ice-Brew, fill the carafe with ice and brew without the brew-through lid.

- The Ninja Coffee Bar™ will beep to signal a completed brew. Stir to cool coffee completely.

### APPROXIMATE BREW VOLUME

⚠ **CAUTION: Make sure to use the proper cup size, not doing so may lead to coffee overflowing the cup.**

Size/Brew	Over Ice	
	Coffee Only	With Ice
Cup	3.7 oz.	9.5 oz.
Travel Mug	5.8 oz.	14 oz.
Half Carafe	7.6 oz.	19 oz.
Full Carafe	15.8 oz.	38 oz.



Fig. 19



Fig. 20

### SPECIALTY BREW

The Specialty Brew delivers a strong coffee concentrate perfect for an iced blended coffee drink or milk based specialty drink. Refer to the Let's Get Started Guide for inspiring recipes.

- After filling the water reservoir and adding ground coffee to the filter, be sure that the Drip Stop is open, reservoir, basket, and filter are securely in place.
- Use the multi-serve dial to select the size of coffee that you would like to brew.
 

**NOTE:** If brewing an iced blended drink, fill the desired vessel with the amount of ice recommended in the recipe before brewing.
- Place the vessel that you would like to brew into underneath the brew basket. Press "Specialty Brew" and the brew will begin. (Fig. 20) Press the Specialty button again or turn the Multi-Serve Size dial to Off to cancel the brew.

**NOTE: The brew will begin, stop, and be quiet for a short period of time before it begins again. This process is used to evenly saturate your coffee grounds.**

- The Ninja Coffee Bar™ will beep to signal a completed brew.

Go to [www.ninjacoffeebar.com](http://www.ninjacoffeebar.com) for more information and how-to videos.



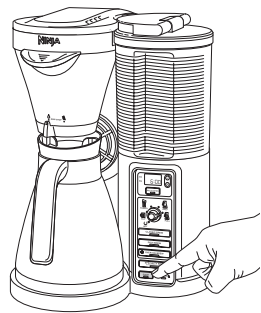

Fig. 21

**CLEANING AFTER A BREW**

**CAUTION:** Make sure that the brewer is unplugged from the power source before cleaning.

**CAUTION:** Be sure to allow the brewer to cool before cleaning.

**NOTE:** Do not leave coffee in the thermal carafe for an extended period of time after a brew.

**NOTE:** Do not leave water in the reservoir unused for multiple days. Rinse and replace with fresh water.

- 1 Before cleaning, close the Drip Stop.
- 2 After each brew is complete and the coffee grounds have cooled, carefully remove the permanent filter and wash. If using the paper filter, simply discard. Remove brew basket from the brewer, rinse and wash with soap and warm water. **NOTE: The brew basket and thermal carafe are not dishwasher safe.** **NOTE:** If coffee grounds spilled over into the brew basket or in the overflow channels, remove and rinse under water until grounds are removed.
- 3 Wash the thermal carafe and brew-through lid with soap and warm water. Use a bottle brush or a cloth to wash the inside of the carafe. **NOTE:** The brew-through lid, permanent filter and water reservoir are top shelf dishwasher safe.
- 4 Wipe machine down with a warm cloth with soap and water to clean the base plate and outer parts. **Do not immerse the base in water.** **NOTE:** For best results, use a bottle brush. This will allow you to scrub all of the inside with soap and hot water.

**CLEANING YOUR THERMAL CARAFE**

We recommend rinsing your carafe with warm soapy water.

**NOTE:** Do not place the thermal carafe in the dishwasher.

If you want to clean the carafe more thoroughly, we recommend using a soft foam brush such as the one shown.



**HOW TO CLEAN & DESCALE**

- CAUTION:** Be sure to allow the brewer to cool before cleaning.
- CAUTION:** DO NOT immerse the coffeemaker into water or any other liquid.
- CAUTION:** DO NOT place the thermal carafe in the dishwasher.

**NOTE:** Cleaning is recommended before or as soon as the Clean button illuminates. Cleaning your Ninja Coffee Bar™ is recommended to keep your brewer brewing hot, rich, and smooth coffee.

The Clean button will illuminate when your Ninja Coffee Bar™ senses there is a calcium build up on your machine which may be affecting the flavor of your coffee. To clean your machine and keep the same great taste of Ninja® coffee, follow the directions below.

- 1 Select the carafe size and set the carafe in place beneath the brew basket.
- 2 Use a descaling solution and follow the directions on the package and fill up to, but not exceeding the Clean Cycle Max Fill line (30 oz.).

OR

Fill the water reservoir to the cup line (11 oz.) with white vinegar, then fill the rest of the water reservoir with water up to, but not exceeding the Clean Cycle Max Fill line (30 oz.)

**IMPORTANT: Use only white vinegar.**

- 3 Once the water reservoir is filled with your cleaning solution and water mixture (**not exceeding the Clean Cycle Max Fill line**), simply press the Clean button to activate the clean cycle. (Fig. 21) **NOTE:** The clean cycle takes approximately 8 minutes to fully descale and clean the machine.
- 4 Once the clean cycle is complete, empty and rinse the carafe and water reservoir. Please take special care to thoroughly clean the carafe and water reservoir to remove any cleaning solution that could affect the flavor of your coffee.
- 5 Once the clean light turns off, fill the water reservoir with water up to, but not exceeding the Clean Cycle Max Fill line (30 oz.) and run 2 more clean cycles with fresh water to rinse the internal parts of the brewer.

**NOTE:** If the Clean light illuminates on the next brew after a clean cycle, this means there is still calcium build up on the brewer. Repeat steps above and the clean light will automatically shut off when it senses your Ninja Coffee Bar™ is clean and free of calcium build up!



Please call customer service if any servicing needs to be performed on the brewer at 1-877-646-5288.

PROBLEMS	POSSIBLE REASONS & SOLUTIONS
<b>Sediment in my coffee.</b>	If there is sediment at the bottom of the brewed coffee, this may be due to finely ground coffee in a permanent filter. To reduce the amount of sediment in the brewed coffee use a slightly coarser grind or use a paper filter.
<b>Grounds in my coffee.</b>	If there are grounds in your coffee, check to make sure the brew basket did not overflow. If there are too many grounds in the brew basket, or you are using a fine ground coffee, the grounds will flow into an overflow channel designed to make sure overflow is captured in the brew vessel. For best results use medium ground coffee in the recommended measurements.
<b>Brew basket dripping after brew.</b>	Check to see if the Drip Stop toggle is set to the closed, no drip position. If the Drip Stop is set to the closed, no drip position and the brewer continues to drip, run a clean cycle or wash the brew basket thoroughly with warm, soapy water.
<b>Paper filter falling over.</b>	The Ninja Coffee Bar™ is designed to take a #4 cone filter. Be sure you are using this size and shape for best results. Be sure the paper filter is firmly pressed into the brew basket. Wet the corners of the filter for best results. If problem persists, try using a permanent filter.
<b>Coffee is not hot enough.</b>	To keep your coffee hotter longer, preheat your mug or carafe by rinsing it with hot water from the tap. If using a microwave safe mug with cream or milk, try preheating the cream or milk in the microwave for 30 seconds. <b>NOTE:</b> Never place carafe in the microwave.
<b>Over Ice Brew is not cold.</b>	The Over Ice Brew is designed to brew hot coffee over ice to lock in the flavor for rich, smooth iced coffee. Make sure your cup, travel mug, or carafe is filled all the way to the top with ice cubes.
<b>Weak coffee.</b>	If the coffee tastes weak, try adding more coffee grounds into the brew basket for the next brew cycle. If the coffee is still weak after adding more coffee grounds, try Rich Brew to make a stronger more concentrated cup.
<b>Coffee too strong.</b>	Try using a more coarse grind. If the coffee is still too strong, try using less coffee grounds.
<b>Brew will not start.</b>	Check to make sure the brewer is plugged in and water is in the water reservoir. If the drip stop is in the open position, check that the brew basket is pushed all the way into the brewer. If you hear 5 beeps, check that the drip stop is in the open position. <b>NOTE:</b> The brew will begin, stop, and be quiet for a short period of time before it begins again. This process is used to evenly saturate your coffee grounds.
<b>Brew cycle is too slow.</b>	A carafe brew will take approximately 8 minutes and the single cup will take approximately 4 minutes. If the brew cycle is taking longer than normal, run the clean cycle with the descaling solution.

## Troubleshooting Guide - cont.

PROBLEMS	POSSIBLE REASONS & SOLUTIONS								
<b>My cup, travel mug or carafe overflowed.</b>	<p>The cup, travel mug or carafe may not have been empty prior to brewing.</p> <p>The water exceeded the Max Fill line on the water reservoir prior to brewing.</p> <p>The Ninja Coffee Bar™ is designed to dispense the following amounts on classic brew:</p> <table border="0"> <tr> <td>Cup</td> <td>9.5 oz</td> </tr> <tr> <td>Travel Mug</td> <td>14 oz</td> </tr> <tr> <td>Half Carafe</td> <td>19 oz</td> </tr> <tr> <td>Carafe</td> <td>38 oz</td> </tr> </table> <p>Please ensure that you are using at least a 12 oz. cup for the cup size and a 16 oz. travel mug for the travel mug size.</p> <p><b>NOTE:</b> On Rich Brew, Over Ice Brew, and Specialty Brew there will be less volume dispensed.</p>	Cup	9.5 oz	Travel Mug	14 oz	Half Carafe	19 oz	Carafe	38 oz
Cup	9.5 oz								
Travel Mug	14 oz								
Half Carafe	19 oz								
Carafe	38 oz								
<b>Brew basket overflowed.</b>	Check the amount of coffee or type of grind used.								
<b>My water reservoir is leaking.</b>	If water was filled above the Max Fill line, water may overflow from the overflow hole at the top of the hand grip. Remove the water reservoir from the brewer and empty to the Max Fill line.								
<b>Water left in my reservoir.</b>	<p>Ninja Coffee Bar™ allows you to fill the reservoir up to but not exceeding the Max Fill line and Auto-iQ™ One Touch Intelligence will only use the water needed for the brew size and style selected.</p> <p>After a brew you may notice left over water in your water reservoir after filling to the minimum fill line of the size selected. The water reservoir markings are minimum fill lines that indicate if there is enough water for the proper brew size in the reservoir for any brew style in that size, but all brew styles use different amounts of water to create the proper flavor and concentration.</p> <p>You can brew multiple cups before needing to refill.</p>								
<b>Does it take coffee pods?</b>	This brewer is designed to brew coffee grounds only. Do not insert pods or K-Cups®.								
<b>My Ninja Coffee Bar™ is leaking.</b>	<p>If the leak is coming from the brew basket, be sure all the parts are fit securely in the brewer.</p> <p>If the leak is coming from the bottom of the brewer call customer service at 1-877-646-5288.</p>								
<b>My Ninja Coffee Bar™ beeped and did not complete the full brew that I selected.</b>	<p>Ensure the water reservoir is locked in place and is filled with enough water for the desired brew.</p> <p>Check the CLEAN indicator light. If illuminated, run a clean cycle with the appropriate descaling solution or a white vinegar mixture. See Care &amp; Maintenance section.</p> <p>Check the Drip Stop indicator light. If illuminated, ensure the brew basket is fully inserted into the brewer and open the Drip Stop once the vessel is placed under the brew basket.</p> <p>If the problem persists please call customer service at 1-877-646-5288.</p>								
<b>Why is the second cup that I brewed hotter than the first brew?</b>	Once the Ninja Coffee Bar™ has brewed the first cup, the brewing system is pre-warmed. This enables any following brews to be slightly hotter. For a hot first cup try prewarming your mug.								

\*K-Cup is a registered trademark of Keurig Green Mountain, Inc. Use of the K-Cup trademark does not imply any affiliation with or endorsement by Keurig Green Mountain, Inc.

PROBLEMS	POSSIBLE REASONS & SOLUTIONS
<b>I noticed the carafe design &amp; lid. What are the benefits?</b>	<p>Our unique carafe shape and design has the following benefits:</p> <ul style="list-style-type: none"> <li>Easy grip design making it easy to pour coffee without dripping.</li> <li>Thoroughly mix your coffee from the first drop to the last thanks to the Brew-Through Carafe Lid.</li> <li>Optimize coffee temperature.</li> <li>Allow you to brew both hot and iced coffee.</li> </ul>
<b>Coffee Brew Volume: What impacts coffee brew volume?</b>	<p>When you make hot coffee, coffee grounds will absorb some of the water that is brewed resulting in slightly less brewed coffee than the water used. The more coffee you use, the more water will be absorbed. Additionally, our wider bottom carafe holds most of the volume coffee at the base which helps control the temperature more evenly.</p> <p>Classic Brew:</p> <div style="display: flex; justify-content: space-around; align-items: center;"> <div style="text-align: center;">  <p><b>Full Carafe</b></p> </div> <div style="text-align: center;">  <p><b>Half Carafe</b></p> </div> </div>
<b>How does the Ninja coffee bar keep coffee at the right temperature?</b>	The carafe is designed to keep most of the coffee volume in the bottom so it can be held closer to the Precise Temp Warming plate. This helps maintain the coffee at the ideal drinking temperature.

Go to [www.ninjacoffeebar.com](http://www.ninjacoffeebar.com) for more information and how-to videos.

## Replacement Parts

### ORDERING REPLACEMENT PARTS

To order additional parts and attachments, please visit our website: [www.ninjacoffeebar.com](http://www.ninjacoffeebar.com) or feel free to contact customer service: **1-877-646-5288**.

---



---



---



---



---



---



---



---



---



---



---



---



---



---



---



---



---



---



---



---



---



---



---



---



---



---



---



---



---



---



---



---



---



---



---



---



---



---



---



---



---



---



---



---

## ONE (1) YEAR LIMITED WARRANTY

**SharkNinja Operating LLC** warrants this product to be free from material defects and workmanship for a period of one (1) year from the date of purchase when utilized for normal household use, subject to the following conditions, exclusions and exceptions.

The liability of **SharkNinja Operating LLC** is limited solely to the cost of the repair or replacement of the unit at our option. This Limited Warranty does not cover normal wear of parts and does not apply to any unit that has been tampered with or used for commercial purposes. This Limited Warranty does not cover damage caused by misuse, abuse, negligent handling or damage due to faulty packaging or mishandling in transit. This Limited Warranty does not cover damage or defects caused by or resulting from damages from shipping or repairs, service or alteration to the product or any of its parts, which have been performed by a repair person not authorized by **SharkNinja Operating LLC**.

If your appliance fails to operate properly while in use under normal household conditions within the warranty period, return the complete appliance and accessories, freight prepaid. For assistance with warranty service options or customer support, please call our customer care and product specialists at , call 1 (877) 646-5288 or visit our website [www.ninjacoffeebar.com](http://www.ninjacoffeebar.com).

If the appliance is found to be defective in material or workmanship, **SharkNinja Operating LLC** will repair or replace it free of charge. Proof of purchase is required and a fee of \$19.95 will apply to cover the cost of return freight. \*

This Limited Warranty is extended to the original purchaser of the unit and excludes all other legal, implied and/or conventional warranties. The responsibility of **SharkNinja Operating LLC** if any, is limited to the specific obligations expressly assumed by it under the terms of this Limited Warranty. In no event is **SharkNinja Operating LLC** liable for incidental or consequential damages to anyone of any nature whatsoever. Some states do not permit the exclusion or limitation of incidental or consequential damages, so the above may not apply to you.

This Limited Warranty gives you specific legal rights, and you may also have other rights which vary from state to state or from province to province.

**\*IMPORTANT: Carefully pack item to avoid damage in shipping. Be sure to include proof of purchase date and to attach tag to item before packing with your name, complete address and phone number with a note giving purchase information, model number and what you believe is the problem with the item. We recommend you insure the package (as damage in shipping is not covered by your Limited Warranty). Mark the outside of your package "ATTENTION CUSTOMER SERVICE".**

## Product Registration

Please visit [www.ninjacoffeebar.com](http://www.ninjacoffeebar.com) or call 1-877-646-5288 to register your new Ninja® product within ten (10) days of purchase. You will be asked to provide the store name, date of purchase and model number along with your name and address.

The registration will enable us to contact you in the unlikely event of a product safety notification. By registering you acknowledge to have read and understood the instructions for use, and warnings set forth in the accompanying instructions.



**VISIT US ONLINE AT:**

[www.ninjacoffeebar.com](http://www.ninjacoffeebar.com)

**Or follow us on any of our social media pages:**



[fb.me/ninjakitchen](https://fb.me/ninjakitchen)



[youtube.com/ninjacoffeebar](https://youtube.com/ninjacoffeebar)



[@ninjacoffeebar](https://twitter.com/ninjacoffeebar)



[pinterest.com/ninjacoffeebar](https://pinterest.com/ninjacoffeebar)



[@ninjacoffeebar](https://instagram.com/ninjacoffeebar)

SharkNinja Operating LLC

US: Newton, MA 02459

CAN: Ville St-Laurent, QC H4S 1A7

1-877-646-5288

[www.ninjacoffeebar.com](http://www.ninjacoffeebar.com)

Copyright © 2016 SharkNinja Operating LLC

For SharkNinja U.S. Patent information visit <http://www.sharkninja.com/USPatents>.

Ninja is a registered trademark of SharkNinja Operating LLC.

Ninja Coffee Bar is a trademark of SharkNinja Operating LLC.

Printed in China

Illustrations may differ from actual product. We are constantly striving to improve our products, therefore the specifications contained herein are subject to change without notice.

CF085Z\_151217\_2\_V2