



2012 LEAF

NAVIGATION SYSTEM OWNER'S MANUAL



Zero Emission

For your safety, read carefully and keep in this vehicle.

NISSAN NAVIGATION SYSTEM HELP-DESK CONTACT INFORMATION

For assistance or inquiries about the NISSAN Navigation System, or to order updated map data, contact the NISSAN NAVIGATION SYSTEM HELPDESK at:

- ADDRESS: P.O. Box 1588,
Orem, UT 84059-992
- E-MAIL: Nissan-Navi-Info@navteq.com
- WEB SITE: www.NissanNavigation.com or
www.nissan.ca
- PHONE: 1-888-661-9995
- HOURS: 6:00 AM to 5:00 PM
(Pacific Time)

NISSAN CONSUMER AFFAIRS DEPARTMENT

For assistance or inquiries about the NISSAN warranty, service or general questions, contact the NISSAN Consumer Affairs Department at:

For U.S. customers
Nissan North America, Inc.
Consumer Affairs Department
P.O. Box 685003
Franklin, TN 37068-5003
1-877-NOGASEV
1-877-664-2738

For Canadian customers
Nissan Canada Inc.
5290 Orbitor Drive
Mississauga, Ontario L4W 4Z5
1-877-NOGASEV
1-877-664-2738

FOREWORD

Thank you for purchasing a NISSAN vehicle.

This user's manual is for the navigation system only. This manual contains operating instructions for the NISSAN Navigation System offered in your NISSAN vehicle.

Please read this manual carefully to ensure safe operation of the navigation system.

- Because of possible specification changes and optional equipment, sections of this manual may not apply to your vehicle.
- All information, specifications and illustrations in this manual are those in effect at the time of printing. NISSAN reserves the right to change specifications or design at any time without notice.
- Do not remove this manual from the vehicle when selling this vehicle. The next user of this navigation system may need the manual.



Zero Emission

LEAF

Get the most out of
your **navigation system!**

Welcome to the world of the LEAF.
This graphical index introduces useful ways to
make driving your LEAF every day more
pleasurable!

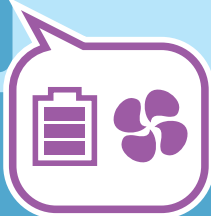

EV

Check the driving range and set your destination

You can easily check on the map approximately how far you can drive with the current level of battery charge. Use this information to help you plan your route.



DISPLAYING DRIVING RANGE P. 2-3

SETTING DESTINATION P. 3-17

EV

Make driving more pleasurable with the CARWINGS™ service

By connecting to the NISSAN CARWINGS™ Data Center, you can use your personal computer or internet-enabled smart phone to start battery charging or have the NISSAN CARWINGS™ Data Center start climate control operation in advance of your departure, and can also receive notifications by email informing you about the battery charge status and if the charge connector is disconnected.*

CARWINGS™

P. 5-1

* Requires an active CARWINGS™ subscription and the vehicle must be in an area that has cellular phone coverage.



Avoid traffic congestion!

By determining which roads are congested in advance, you can avoid an unexpected traffic jam. Registration with Sirius XM[®] Radio, Inc. is necessary in order to receive XM[®] NavTraffic information.

VIEWING AVAILABLE TRAFFIC INFORMATION

P. 6-6

Useful functions to make driving a pleasure!

Listen to your iPod[®] on the audio system or make a hands-free phone call with a compatible Bluetooth[®] cellular phone. (Refer to the list of NISSAN compatible Bluetooth[®] phones.)



AUDIO SYSTEM P. 4-1

BLUETOOTH[®] HANDS-FREE PHONE SYSTEM P. 7-1



 EV

Charging support and assistance!

If the system determines that the vehicle will not be able to reach the selected destination with the current level of battery charge, it will suggest a detour to a charging station. Also, if the level of remaining charge is low or if there is a Li-ion battery malfunction, a message will be displayed on the navigation screen when the  low battery charge warning light in the meter illuminates.*

BATTERY AND
POWER INFORMATION

P. 2-15

 EV

Support and information about charging facilities

You can display icons for charging stations on the map as well as detailed information for each station. Information for charging stations can also be updated.*

DISPLAYING CHARGING STATION ICONS
ON THE MAP

P. 2-5

VIEWING CHARGING STATION
INFORMATION

P. 6-5

UPDATING CHARGING STATION
INFORMATION

P. 2-6

* Requires an active CARWINGS™ subscription and the vehicle must be in an area that has cellular phone coverage.



What is close by?

You can display icons for restaurants and parking lots etc. on the map and can also search for facilities located near your vehicle.

DISPLAYING MAP ICONS P. 3-12

FINDING NEARBY PLACES P. 3-28



Make good use of the timer!

Before you set off on a journey, you can make the environment inside the vehicle more comfortable while the battery is charging. Pre-cooling/heating helps reduce power consumption while driving and helps extend vehicle range.*

SETTING TIMER CHARGE P. 2-8

SETTING CLIMATE CTRL. TIMER P. 2-10

Table of Contents

Introduction	0
LEAF Navigation System overview	IT
Getting Started	1
Unique EV functions	2
Navigation	3
Audio system	4
CARWINGS™	5
Viewing technical information	6
Bluetooth® Hands-Free Phone System	7
Voice recognition	8
Monitor system (if so equipped)	9
Troubleshooting guide/General system information	10
Index	11

0 Introduction

How to use this manual	0-2	Safety information	0-2
For safe operation.....	0-2	Laser product.....	0-4
Reference symbols	0-2		

HOW TO USE THIS MANUAL

This manual uses special words, symbols and icons, organized by function.

Please refer to the following items and familiarize yourself with them.

FOR SAFE OPERATION

WARNING

This is used to indicate the presence of a hazard that could cause death or serious personal injury. To avoid or reduce the risk, the procedures must be followed precisely.

CAUTION

This is used to indicate the presence of a hazard that could cause minor or moderate personal injury or damage to your vehicle. To avoid or reduce the risk, the procedures must be followed carefully.

NOTE:

Indicates items that help you understand and maximize the performance of your vehicle. If ignored, they may lead to a malfunction or poor performance.

REFERENCE SYMBOLS



INFO:

This indicates information that is necessary for efficient use of your vehicle or accessories.



Reference page:

This indicates the title and page that you should refer to.

[]:

This indicates a key/item displayed on the screen.



Voice Command:

This indicates an operation by voice command.

SAFETY INFORMATION

This system is primarily designed to help you reach your destination, and it also performs other functions as outlined in this manual. However, you, the driver, must use the system safely and properly. Information concerning road conditions, traffic signs and the availability of services may not always be up-to-date. The system is not a substitute for safe, proper and legal driving.

Before using the navigation system, please read the following safety information. Always use the system as outlined in this manual.

WARNING

- **When the driver wants to operate the navigation system, first park the vehicle in a safe location and set the parking brake. Operating the system while driving can distract the driver and may result in a serious accident.**
- **Do not rely on route guidance alone. Always be sure that all driving maneuvers are legal and safe in order to avoid accidents.**
- **Do not disassemble or modify this system. If you do, it may result in accidents, fire or electrical shock.**

- If you notice any foreign objects in the system hardware, spill liquid on the system or notice smoke or a smell coming from it, stop using the system immediately and contact a NISSAN certified LEAF dealer. Ignoring such conditions may lead to accidents, fire or electrical shock.

CAUTION

- Do not use this system if you notice any malfunctions such as a frozen screen or the lack of sound. Continued use of the system may result in accidents, fire or electrical shock.
- Some states/provinces may have laws limiting the use of video screens while driving. Use this system only where it is legal to do so.
- Extreme temperature conditions [below -4°F (-20°C) and above 158°F (70°C)] could affect the performance of the system.



INFO:

Do not keep the navigation system running with the READY to drive indicator light is OFF. Doing so may discharge the vehicle battery. When you use the navigation system, always make sure the READY to drive indicator light is ON.

NOTE:

- Establishing the CARWINGS™ service is necessary before using this service.
- To check the Li-ion battery charging status or to use the remote heater and air conditioner using an internet enabled smart phone or personal computer, the following conditions must be met:
 - The vehicle must be located in a cellular phone or smart phone coverage area.
 - The internet enabled cellular phone or smart phone must be located in a cellular phone or smart phone coverage area.
 - The computer must be connected to the internet.
 - A cellular phone must be used to communicate with the vehicle.

— A cellular phone capable of text messaging must be used to receive text message regarding vehicle charge status.

- When the remote heater and air conditioner is set, the system operates the heater and air conditioner to adjust the in-cabin temperature to a factory pre-set temperature.
- When the charge connector is disconnected from the vehicle, the heater and air conditioner operates using vehicle Li-ion battery electric power.
- If the remote heater and air conditioner function and Li-ion battery charging are performed at the same time, Li-ion battery charging will take longer than usual due to the power used to heat or cool the vehicle.
- Certain remote functions require a compatible smart phone, which is not included with vehicle.
- CARWINGS™ information system features are included through a subscription service which requires owner consent to activate. The subscription must be active to use these features.

- **CARWINGS™** communications may be received at a verified e-mail address or by SMS/text messaging-enabled cellular phone.
- **Standard text rates and/or data usage** may apply depending on your carrier.

LASER PRODUCT

This navigation system is certified as a Class 1 laser product.

The navigation system complies with DHHS Rules 21 CFR Chapter 1, Subchapter J.

WARNING

- **Do not disassemble or modify this system. There are no user serviceable parts in this navigation system.**
- **If maintenance, adjustments and operations other than those specified in this manual are attempted, injury due to laser radiation and exposure could occur.**



Required XM® Radio and XM NavTraffic® monthly subscriptions are sold separately. XM NavTraffic® are only available in select markets. For more information, see www.xmradio.com/navtraffic.



Required XM® Radio and XM NavWeather™ monthly subscriptions are sold separately. XM NavWeather™ is only available in select markets. For more information, see www.xmradio.com/navweather.



Bluetooth® is a trademark owned by Bluetooth SIG, Inc., and licensed to Clarion.

LEAF Navigation System overview

Features of LEAF Navigation System.....	IT-2
Unique EV functions	IT-2
Telematics service.....	IT-4

FEATURES OF LEAF NAVIGATION SYSTEM

UNIQUE EV FUNCTIONS

In addition to the conventional navigation functions, the LEAF navigation system also offers specific support for driving an EV.

CAUTION

Charging station information may not be detailed in all areas or reflect current charging station locations. For up to date information about charging stations, such as business hours or charging equipment, NISSAN recommends that you directly access the information on your own. Additionally, always check the remaining amount of battery charge and set a reasonable driving schedule.

Driving range display

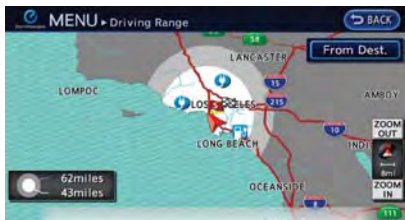

By pressing the  button on the steering wheel, you can display the estimated one way range that the vehicle can be driven from the current location based on the amount of remaining battery charge. When a destination or a waypoint has been set, the driving area will be displayed with the destination or waypoint in the center.

 "Displaying estimated driving range"
(page 2-3)

Charging stations located within the driving area will also be displayed. By moving the map, you can set a charging station as a destination or waypoint.

 "Setting a charging station as destination"
(page 2-4)

Charging station information

NOTE:

Charging stations that have been searched for using this function are not necessarily equipped with devices that can be used to charge a LEAF. Be sure to confirm this in advance before setting a charging station as the destination.

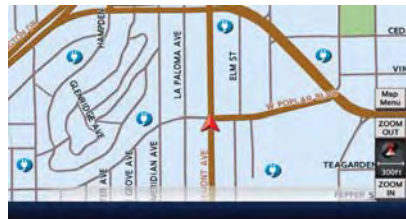

Icons for charging stations can be displayed on the map. You can also display only charging stations that are equipped with quick charge devices or only charging stations that are equipped with normal charge devices.

 "Displaying charging station icons on map"
(page 2-5)



You can search for charging stations near the current location, set a charging station as a destination or waypoint, and check detailed information about charging stations.

 "Finding charging station" (page 3-24)

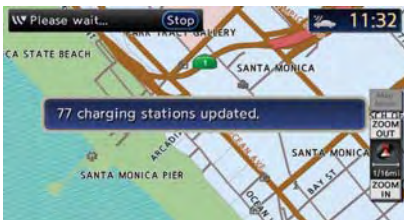

When connecting to the NISSAN CARWINGS Data Center, the system will periodically perform an automatic update of information for charging stations near your home. The system will also automatically update information for charging stations near the current vehicle location when the Li-ion battery charge is low. You can also manually update the charging stations around your current vehicle location at any time.

☞ "Updating charging station information" (page 2-6)

Energy information display



Estimated driving range, average energy economy and instant energy economy are displayed.

☞ "Viewing energy economy information" (page 2-7)

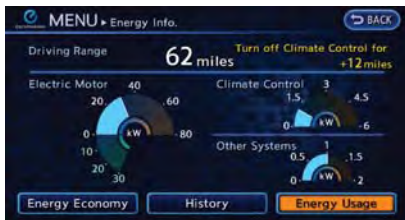

Estimated driving range and energy usage of various systems are displayed. Also, variation of the estimated driving distances between the climate control ON and OFF is displayed.

☞ "Viewing energy usage information" (page 2-8)

Timer functions



Charging of the Li-ion battery will automatically start at a scheduled time according to the start time, end time and day of the week set. The timer charge function allows two different timer settings. Each timer charge can be set to activate on a different day of the week. If no timer is set, the charge will start immediately after connecting the charge connector.

☞ "Setting timer charge" (page 2-8)



The air conditioner starts to operate at the time of day and day of the week specified in the settings. This pre cools or heats the passenger compartment before starting to drive. Electric power consumption from the Li-ion battery resulting from heater and air conditioner operation can be reduced because the temperature in the passenger compartment is adjusted before starting to drive.

☞ "Setting Climate Ctrl. Timer" (page 2-10)

TELEMATICS SERVICE

This vehicle incorporates a communication device that is called a TCU (Telematics Communication Unit). The communication connection between this unit and the NISSAN CARWINGS Data Center allows for various services.

NOTE:

- Establishing the CARWINGS™ service is necessary before using this service.
- To check the Li-ion battery charging status or to use the remote heater and air conditioner using an internet enabled smart phone or personal computer, the following conditions must be met:
 - The vehicle must be located in a cellular phone or smart phone coverage area.
 - The internet enabled cellular phone or smart phone must be located in a cellular phone or smart phone coverage area.
 - The computer must be connected to the internet.
 - A cellular phone must be used to communicate with the vehicle.

— A cellular phone capable of text messaging must be used to receive text message regarding vehicle charge status.

- When the remote heater and air conditioner is set, the system operates the heater and air conditioner to adjust the in-cabin temperature to a factory pre-set temperature.
- When the charge connector is disconnected from the vehicle, the heater and air conditioner operates using vehicle Li-ion battery electric power.
- If the remote heater and air conditioner function and Li-ion battery charging are performed at the same time, Li-ion battery charging will take longer than usual due to the power used to heat or cool the vehicle.
- Certain remote functions require a compatible smart phone, which is not included with vehicle.
- CARWINGS™ information system features are included through a subscription service which requires owner consent to activate. The subscription must be active to use these features.

- CARWINGS™ communications may be received at a verified e-mail address or by SMS/text messaging-enabled cellular phone.
- Standard text rates and/or data usage may apply depending on your carrier.

Remote functions



You can use a personal computer or an internet enabled smart phone to check the battery status and operate battery charging or the heater/air conditioner remotely from another location.

Battery status check:

The status of the battery can be checked using your personal computer or an internet enabled smart phone even if you are not in the vehicle. You may also choose to have SMS messages (text messages) sent to a cellular phone.

Unplugged status, Charge status:

By registering frequently used charging stations, notifications can be sent to your personal computer or cellular phone email address to inform you when the charging connector is disconnected or charging is stopped mid-charge at those locations.

Remote charge, Remote climate control:

Remote activation of battery charging or climate control can be set using your personal computer or a internet enabled smart phone.

Navigation Telematics (CARWINGS™ service)

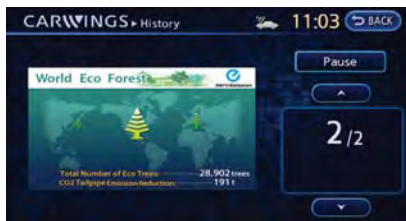

When the system connects to the NISSAN CARWINGS Data Center, charging station information will be automatically updated and you can receive useful information for driving your vehicle.

Automatic update of charging stations:

The information for the charging stations that is recorded in the map data is automatically updated.

All Information Feeds:

Convenient information for driving such as weather and traffic information, ECO information shared with the LEAF users, etc. is provided.

Favorites:

When the information of an Internet site is selected and it is stored in the page that is specially established in the NISSAN Owner's Portal Website, the information is converted into an appropriate format via the NISSAN CARWINGS Data Center and provided for use in the vehicle. The content of the information is automatically read out. For the registration method of information data, visit the NISSAN Owner's Portal Website.

MEMO

1 Getting Started



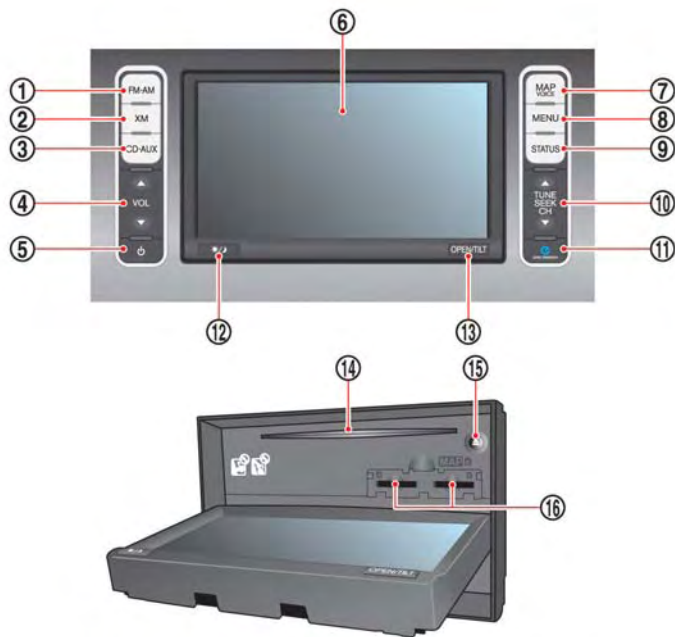

Control buttons and functions.....	1-2	Menu screen	1-9
Control panel	1-2	Status screen.....	1-10
Steering wheel switches.....	1-4	FM-AM radio screen.....	1-10
USB connector and Auxiliary input jack	1-4	XM satellite radio screen	1-10
Start-up screen	1-5	CD-AUX screen.....	1-10
Functions disabled while driving.....	1-6	Items to be set initially.....	1-11
Basic operation	1-7	Subscription to CARWINGS™ service.....	1-11
Selecting item	1-7	Inputting user ID and password	1-11
Adjusting volume and others	1-7	Storing home location	1-12
Scrolling message or list	1-7	Connecting cellular phone	1-13
How to input letters and numbers	1-7	Display adjustment	1-14
Viewing display screens.....	1-9	Volume settings.....	1-16
Map screen.....	1-9	Clock settings.....	1-16
Zero Emission menu screen	1-9	Language and unit settings.....	1-17

CONTROL BUTTONS AND FUNCTIONS



CONTROL PANEL

- 1 FM-AM button:**
Push to switch between the FM the AM radio bands.
- 2 XM button:**
Push to switch to an XM satellite radio band.
- 3 CD-AUX button:**
Push to switch between USB memory/iPod® player/CD/Bluetooth® streaming audio/AUX screens.
- 4 VOL (Volume control) button:**
Push to adjust the volume of the audio system.
- 5  (Audio system ON-OFF) button:**
Push to turn the audio system on or off.
- 6 Monitor:**
- 7 MAP button/VOICE button:**
Push to display the current location map screen. Push and hold to repeat voice guidance.
- 8 MENU button:**
Push to display the setting menu (destination, route, information, settings, phone and CAR-WINGS™) screen.
- 9 STATUS button:**
Push to display the current status of the climate control, radio, audio, vehicle information (driving range and average energy economy) and navigation systems.
- 10 TUNE SEEK CH button:**
Push to select a track/station. Push and hold to search for a track/station automatically or to fast-forward/rewind when listening to music.

- ⑪  (Zero Emission menu) button:
Push to display the menu screen where several useful functions for electric vehicle driving are available.
- ⑫  (Day/Night) button:
Push to switch between the day screen (bright) and the night screen (dark). Push and hold to turn off the display. Push again to turn on the display.
- ⑬ **OPEN/TILT** button:
Push to open the monitor to access the CD slot and the SD card slot. Push and hold to adjust the monitor angle.
- ⑭ CD slot:
- ⑮  (CD eject) button:
Push to eject a CD.
- ⑯ SD card slot:
Remove the cover to access the SD card slot. Insert an SD card. Push the inserted SD card in and release it to eject the SD card from the slot. An SD card containing map data is provided with the vehicle and is inserted in the right hand slot of the system. To transfer the data, insert an SD card in the left side slot.
-  "Transferring information to/from address book" (page 3-67)

NOTE:
Do not remove the SD card containing map data that is inserted in the right-hand slot. When this SD card containing map data is removed the navigation system will not operate. If the SD card containing map data is accidentally removed, after reinserting the SD card containing map data into the right-hand slot, place the power switch in the OFF position and then place back in the ON position again.

 **INFO:**

- Never remove the SD card while the monitor is opening or closing or the angle of the monitor is being adjusted. Doing so may damage or deform the SD card.
- Never insert foreign objects such as coins into the SD card slot. Doing so may result in a malfunction of the device.
- Be careful not to drop the cover for the SD card slot into the gap of the monitor. Doing so may result in a malfunction of the device.
- Do not apply overload to the SD card when inserting it to the slot. Doing so may result in a malfunction of the device.

- The SD card may be hot when it is removed from the device. This does not indicate a malfunction.

Opening/Closing monitor

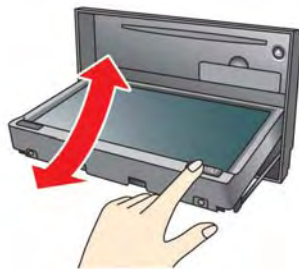

Open the monitor to insert/eject a CD or an SD card.

CAUTION

- **Be careful not to pinch your hand or fingers while the monitor is moving to its open or closed position. This may cause injury to your hand or fingers.**
- **Do not force the monitor to open or close. Doing so may damage the monitor.**

When the **OPEN/TILT** button is pushed while the monitor is closed, the monitor will open. When the **OPEN/TILT** button is pushed while the monitor is open, the monitor will close.

Adjusting monitor angle



The angle of the monitor can be adjusted to select from 3 different preset angles. Once the angle of the monitor is selected and stored in the system, the selected angle is always set after performing the open/close operation of the monitor.

Push and hold the **OPEN/TILT** button until a chime sounds. When the button is released, the next preset angle will be selected. Continue this procedure until the preferred angle is obtained.

STEERING WHEEL SWITCHES

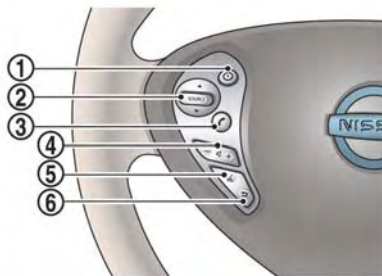

- ① (Driving range) button:
Push to display the driving range screen. Push again to return to the previous screen.
 "Displaying estimated driving range"
(page 2-3)
- ② **SOURCE** button:
Push to change the mode in sequence of AM, FM, XM, CD, USB memory, iPod® player and Bluetooth® streaming audio. If a mode is not ready to function, it will be skipped. Push up or down to select a radio station or a track.
- ③ (PHONE) button:
Push to display the hands-free phone operation screen.
- ④ - + (Volume control) button:
Allows you to adjust the volume.
- ⑤ (TALK) button:
Push to enter the voice recognition mode.

- ⑥ (CANCEL) button:
Push to cancel the voice command.

USB CONNECTOR AND AUXILIARY INPUT JACK

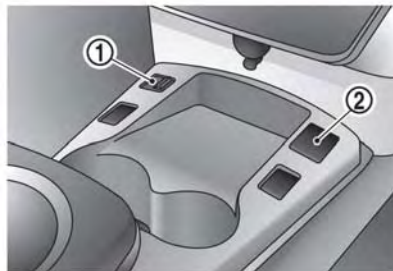

- ① **USB connector:**
Connect to play an iPod® or a USB memory.
- ② **Auxiliary input jack:**
Connect an audio player that accepts a 1/4 inch (3.5 mm) TRS connector (such as an MP3 player etc.) to play back music.

START-UP SCREEN



1. The system starts when the power switch is pushed to the "ACC" or "ON" position. The start-up screen is displayed.



2. Check the message that is displayed on the screen and touch [OK] to accept.

INFO:

If you do not select [OK], vehicle data will not be stored in the NISSAN CARWINGS Data Center and you will not be able to check it via the NISSAN Owner's Portal Website.

Also, if [Share Vehicle Information] is set to OFF, vehicle data will not be uploaded. Make sure that this setting is ON.

When [Service Reminder] is set to ON, communication with the NISSAN CARWINGS Data Center will be performed once daily. NISSAN recommends that you set [Service Reminder] to ON.

 "CARWINGS™ settings" (page 5-10)

NOTE:

- **Navigation functions, audio, hands-free phone, vehicle information display, etc. can still be operated even if [Decline] is touched. However, if the CARWINGS™ function is selected, the start-up screen will be displayed again.**
- **If other buttons such as the MAP button or MENU button etc., are pressed without [OK] or [Decline] being touched, the corresponding screen will be displayed and operations can be performed. However, if the CARWINGS™ function is selected, the**

start-up screen will be displayed again.

FUNCTIONS DISABLED WHILE DRIVING



To ensure safe driving, some functions cannot be operated or have limited operation while the vehicle driving speed is above 5 mph (8 km/h).

The on-screen text and keys for these restricted functions will be "grayed-out" or muted and cannot be selected while driving. In some cases, a screen message will appear indicating a restricted function.

Restricted functions while driving include:

- Character (letter and number) input screen during destination entry (street address, places, phone number, freeway entrance/exit, intersection, city center)
- Setting route condition after setting destination
- Scrolling and viewing of certain navigation list
- Displaying detail information and touching item on the information screen
- Adding/editing home location
- Adding/editing address book entries
- Editing current route
- Storing current position, information, destination
- Displaying charging station information
- Registering cellular phones

- Making a call by dial number and handset phonebook
- Setting phone, CARWINGS™ and Bluetooth® functions

These functions will become available again when the vehicle speed is reduced to 5 mph (8 km/h).

Destination functions available while driving include:

- Home
- Nearby Charging Stations
- Address Book
- Previous Destinations
- Nearby Places
- Stored Routes
- Map input

BASIC OPERATION

Examples of operations performed using the touch panel operation are described here.

SELECTING ITEM



When the item is touched, the next screen is displayed.

ADJUSTING VOLUME AND OTHERS



Touch [+] or [-] located on the right and left of the bar graph to perform the adjustment.

SCROLLING MESSAGE or LIST

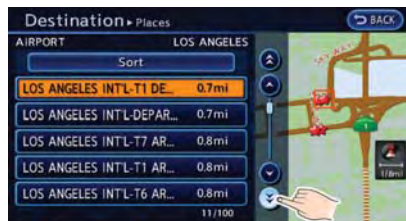

Touch [▲] or [▼] to scroll the message or list.

Touch [⊕] or [⊖] to skip to the next page.

HOW TO INPUT LETTERS AND NUMBERS

Character (letters and numbers) input screen

Alphanumeric characters are entered to set a destination, search for a facility, edit stored locations, etc.



1. Touch a character on the displayed keyboard. The selected character is entered.



2. Touch [Delete] to delete the last character entered.

Touch and hold [Delete] to delete all the characters entered.

Touch [Space] to enter a space.



3. After finishing the entry, touch [List].

INFO:

- The list screen appears automatically when text has been entered and the matching list items have been narrowed down to a number that will fit on the screen.
- Symbol keys are displayed by touching [Symbols]. Alphabet keys are displayed by touching [A-Z].

Phone number input screen

Perform the following procedure to enter a number.

INFO:

Only the locations included in the map data database can be searched for by a phone number.



1. Touch a number on the displayed keyboard. The selected number is entered.



2. Touch [Delete] to delete the last number entered.

Touch and hold [Delete] to delete all the numbers entered.



3. After finishing the entry, touch [List].

VIEWING DISPLAY SCREENS

This system allows you to set various functions and check information on the screen that is displayed by pushing each button located on the control panel.

MAP SCREEN

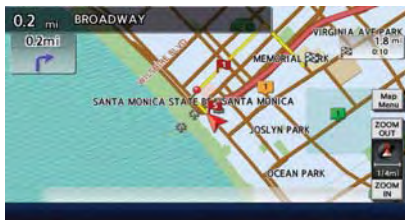

When the **MAP** button is pushed, a map screen where the vehicle position is centered is displayed.

When the map is moved or the **MAP** button is pushed while the menu screen is displayed, a map indicating the current vehicle position is displayed. Various useful information for driving is shown on the map screen.

"Map settings" (page 3-3)

ZERO EMISSION MENU SCREEN



Push the (Zero Emission menu) button to display the menu screen where several useful functions for electric vehicle driving can be set. Select a preferred menu and touch an item to be set.

"2. Unique EV functions"

MENU SCREEN

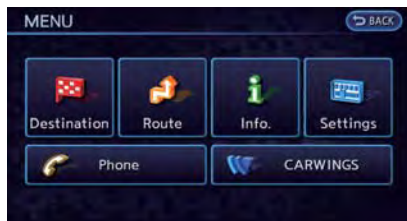

When the **MENU** button is pushed, the menu screen is displayed. Select a preferred menu and touch an item to be set.

Available options:

- [Destination]:
There are several methods you can use to set your destination. Understand the advantages of each method and select the best method for finding and setting your destination.
 "Setting destination" (page 3-17)
- [Route]:
During route guidance, you can modify the route conditions or confirm the route information. Set the appropriate route condition according to your purpose.
 "Route guidance" (page 3-36)
- [Info.]:
This screen allows you to set or view various information that is helpful for using the vehicle safely and comfortably.
 "6. Viewing technical information"
- [Settings]:
The system can be customized to make it easier for you to use.
- [Phone]:
Useful functions for the Bluetooth® Hands-Free Phone System can be set.
 "Phone settings" (page 7-8)

- [CARWINGS]: Information feeds are displayed and settings for CARWINGS™ can be performed.  “5. CARWINGS™”

STATUS SCREEN

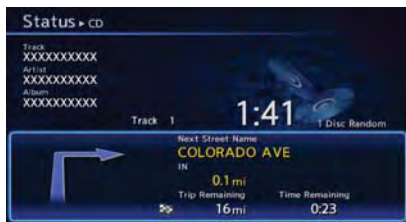

Push the **STATUS** button to display the current status of the navigation system.

Each time the **STATUS** button is pushed, displayed information is switched in the order of climate control, vehicle information and navigation route information.

There are different status screens displayed depending on various factors, such as the currently active mode, whether a destination has been set or not, etc.

FM-AM RADIO SCREEN



Push the **FM-AM** button to turn on the radio and display the radio screen. Push the switch to toggle the radio mode: AM→FM1→FM2.

 “FM-AM-SAT radio operation” (page 4-11)

XM SATELLITE RADIO SCREEN



Push the **XM** button to turn on the satellite radio and display the XM satellite radio screen. Push the switch to toggle the radio mode: XM1→XM2→XM3.

 “FM-AM-SAT radio operation” (page 4-11)

CD-AUX SCREEN





Push the **CD-AUX** button to turn on the audio system and display the audio screen. Push the **CD-AUX** button to toggle the mode: iPod player/USB memory→CD→Bluetooth® streaming audio*1→AUX.

 “Compact Disc (CD) player operation” (page 4-12)

 “iPod® player operation” (page 4-14)

 “USB memory operation” (page 4-15)

 “Bluetooth® streaming audio” (page 4-9)

 “Auxiliary input jack” (page 4-20)

*1 The screen can only be switched when a Bluetooth® streaming audio device has been registered.

ITEMS TO BE SET INITIALLY

The settings included in this section should be performed before using the system for the first time.

SUBSCRIPTION TO CARWINGS™ SERVICE

It is necessary to subscribe to CARWINGS™ in order to use the CARWINGS™ service. For the details about the subscription, visit the NISSAN Owner's Portal Website or contact a NISSAN certified LEAF dealer.

INPUTTING USER ID AND PASSWORD

User registration is required before using the CARWINGS™ service. CARWINGS™ is a service that provides various types of information by communicating with the NISSAN CARWINGS Data Center. Access the NISSAN Owner's Portal Website before starting the service. Confirm the terms of service and complete the user registration form. After registration is completed, a user ID and password are provided.

Inputting procedure

Enter the user ID and password in the system by performing the following procedure.

1. Push the  (Zero Emission menu) button and touch [CARWINGS].
2. Touch [CARWINGS Settings].
3. Touch [Sign in].

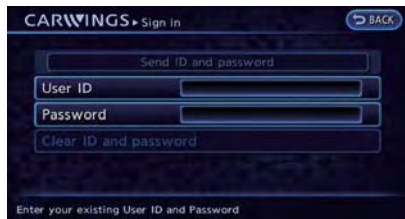

4. Touch [User ID]. The user ID input screen is displayed.



5. Enter the user ID and touch [OK]. Return to the previous screen.

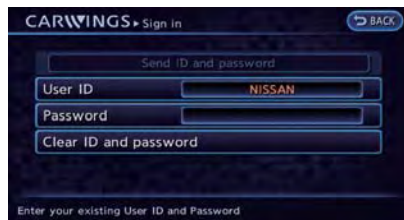

6. Touch [Password]. The password input screen is displayed.



7. Enter your password and touch [OK]. Return to the previous screen.

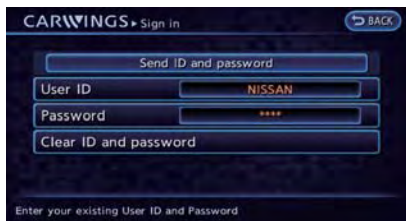

8. Touch [Send ID and password]. A confirmation message is displayed.
9. Confirm the contents of the message, then touch [Yes]. It takes approximately 30 seconds to send the information. The system connects to the NISSAN CARWINGS Data Center, and then the CARWINGS™ service can then be used.

INFO:

- The following can be used when inputting a user ID or password: letters of the alphanumeric characters, symbols, + , - , # , / , . (period), _ (underscore), @, etc.
- The ID that is registered to the vehicle is required to match the ID that is obtained from the NISSAN Owner's Portal Website in order to activate the system. If the IDs do not match, the system cannot be activated. In this case visit the NISSAN Owner's Portal

Website and obtain an ID again.

- The setting of the ID and password is only required during initial registration. However, it is recommended to regularly change the password. For details about how to receive a new password, refer to the NISSAN Owner's Portal Website.
- When selling your vehicle, be sure to delete the ID and password in the registration screen. To delete the user ID and the password, touch [Clear ID and Password].
- The CARWINGS™ service uses the TCU (Telematics Communication Unit) which is like a cellular. Even if the signal strength bar of the TCU indicates good reception, connection to the NISSAN CARWINGS Data Center may be disabled. This does not indicate a malfunction. Operate the system again after a few minutes.
- The CARWINGS™ service cannot be used under the following conditions:
 - The vehicle moves outside the service area of the TCU connection to the system.
 - The vehicle is in a location with poor signal reception such as a tunnel, underground parking, behind a building or in a mountainous area.

STORING HOME LOCATION

If your home location is already stored in the Address Book, it can be easily retrieved to set the route to your home. The procedure to store your home location is the same as for storing any other location.

As an example, the procedure for storing your home location by searching for a destination by map is described here.

1. Push the **MENU** button and touch [Destination].



2. Touch [Home]. A confirmation message is displayed.



3. Confirm the contents of the message, then touch [Yes].



4. Touch [Map]. The current location map screen is displayed.

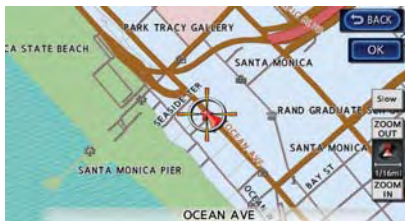

5. If necessary, adjust your home location by touch panel operation.
6. After adjusting the location, touch [OK]. A message is displayed and your home location is stored in the Address Book.

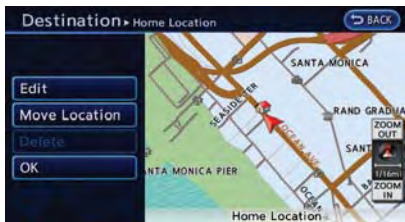

7. Adjust the location of a stored item and edit the contents of a stored item as necessary.
8. Touch [OK] to return to the Destination screen.

INFO:

You can also perform the same setting by pushing the **MENU** button and selecting [Settings].

 "Storing location" (page 3-35)

CONNECTING CELLULAR PHONE

Your vehicle is equipped with Bluetooth[®] Hands-Free Phone System. If you are an owner of a compatible Bluetooth[®] enabled cellular phone, you can set up the wireless connection between your cellular phone and the in-vehicle phone module. With Bluetooth[®] wireless technology, you can make or receive a telephone call with your cellular phone in your pocket.



1. Push the  button and touch [Connect Phone].



- When a PIN code appears on the screen, operate the compatible Bluetooth® cellular phone to enter the PIN code.

The procedure for cellular phone connection varies according to each cellular phone. Refer to the cellular phone Owner's Manual for the details.

You can also visit www.nissanusa.com/bluetooth or call NISSAN Consumer Affairs Department for instructions on pairing NISSAN recommended cellular phones.

When the connection process is completed, the screen will return to the Phone menu screen.

Some cellular phones or other devices may cause interference or a buzzing noise to come from the audio system speakers. Storing the device in a different location may reduce or eliminate the noise.



INFO:

The cellular phone connection can also be set by performing the following procedure.

- Push the **MENU** button and touch [Settings].
- Touch [Bluetooth Connections].
- Touch [Connect Bluetooth].

DISPLAY ADJUSTMENT

This menu turns on and off the display and adjusts the image quality of the navigation screen.



- Push the **MENU** button and touch [Settings].
- Touch [Display].
- Touch the preferred adjustment item and adjust to the preferred setting.

Available settings

- [Display]:
Turn on or off the screen.
☞ "Display" (page 1-14)
- [Brightness]:
Adjust the screen brightness.
☞ "Brightness" (page 1-15)
- [Contrast]:
Adjust the screen contrast.
☞ "Contrast" (page 1-15)
- [Background Color]:
Set the background color.
☞ "Background color" (page 1-15)

Display



To turn off the display, touch [Display].

The display can also be turned off by pushing and holding the ***M** button for more than 2 seconds.

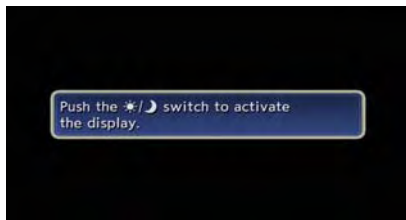

When any button is pushed with the display off, the display turns on. The display will automatically turn off when there is no switch operation for 5 seconds.

To turn on the display, push the * / moon button.

Brightness



1. Touch [Brightness].
2. Adjust the display brightness by touching [+] or [-].

Contrast



1. Touch [Contrast].
2. Adjust the display contrast by touching [+] or [-].

Background color



1. Touch [Background Color].
2. Touch [Day] or [Night]. The indicator of the selected color illuminates.

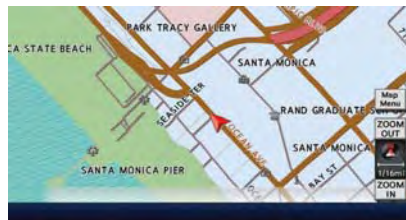

Day screen

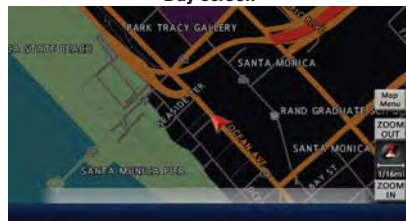

Night screen



INFO:

The background color setting can also be changed by pushing the * / moon button.

VOLUME SETTINGS

This turns on and off, as well as adjusts, the phone function (ringer, incoming and outgoing volume), the voice guide function and the beep function.



1. Push the **MENU** button and touch [Settings].
2. Touch [Volume & Beeps].
3. Touch the item you would like to adjust.

Available settings

- [Audio Volume]:
Adjust the volume level of the audio system by touching [+] or [-].
- [Guidance Volume]:
Adjust the volume level of voice guidance by touching [+] or [-].
- [Ringtone]:
Adjust the volume level of the ringtone by touching [+] or [-].

- [Incoming Call]:
Adjust the incoming call volume by touching [+] or [-].
- [Outgoing Call]:
Adjust the outgoing call volume by touching [+] or [-].
- [CARWINGS Volume]:
Adjust the volume level of the CARWINGS™ information channel by touching [+] or [-].
- [Switch Beeps]:
Select to toggle the beep function between ON and OFF. The indicator light illuminates when the beep function is set to ON. The beep sounds when pushing and holding a button or when a prohibited operation is performed.
- [Guidance Voice]:
Select to toggle the voice guidance function between ON and OFF. The indicator light illuminates when the voice guidance function is set to ON.

CLOCK SETTINGS

This changes the clock settings.



1. Push the **MENU** button and touch [Settings].
2. Touch [Others].
3. Touch [Clock].
4. Touch the item you would like to adjust.
5. Adjust the preferred setting. Touch the item to set ON or OFF.

Available settings

- [On-screen Clock]:
Select to toggle the clock display located in the top right corner of the display between ON and OFF. The indicator light illuminates when the clock display is set to ON.
- [Clock Format (24h)]:
Select the clock format between 12-hour and 24-hour times. The indicator light

illuminates when the clock is set to the 24-hour format.

- [Offset (hour)]:
Touch [+] or [-] to adjust the offset value (between -12 and +12).
- [Offset (min)]:
Touch [+] or [-] to adjust the offset value (between -59 and +59).
- [Daylight Savings Time]:
Select to toggle the daylight savings time setting between ON and OFF. The indicator light illuminates when the daylight savings time setting is set to ON.
- [Time Zone]:
Select an appropriate time zone from the list that appears when this item is highlighted.

LANGUAGE AND UNIT SETTINGS

This changes the language and measurement unit used in the system.

Language settings



1. Push the **MENU** button and touch [Settings].
2. Touch [Others].
3. Touch [Language & Units].
4. Touch [Select Language].

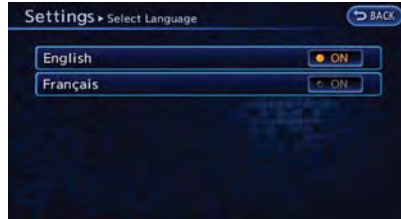

5. Touch the item you would like to set. The indicator light of the selected item illuminates.

Available languages

- English
- Français



INFO:

Do not push power switch while changing the language.

Unit settings



1. Push the **MENU** button and touch [Settings].
2. Touch [Others].
3. Touch [Language & Units].
4. Touch [Select Units].



5. Touch the preferred unit. The indicator of the selected unit illuminates.

Available units

- US: mile, °F, mile/kWh
 - Metric: km, °C, km/kWh
6. Push the **MAP** button to return to the current location map screen.

2 Unique EV functions



Zero Emission menu screen	2-2	Viewing energy economy history	2-7
Displaying estimated driving range and charging station information	2-3	Viewing energy usage information	2-8
Displaying estimated driving range	2-3	Timer function operation	2-8
Displaying charging station icons on map	2-5	Setting timer charge	2-8
Updating charging station information	2-6	Setting Climate Ctrl. Timer.....	2-10
Energy information display.....	2-7	Unique EV function settings.....	2-13
Viewing energy economy information	2-7	Setting messages that are displayed on screen....	2-14
		Battery and power information	2-15





ZERO EMISSION MENU SCREEN

Push the  (Zero Emission menu) button to display the menu that includes useful functions for electric vehicle driving.



Available settings

- [Driving Range]:
The estimated driving area within range, including the current position is displayed on the map screen.
 "Displaying estimated driving range" (page 2-3)
- [Nearby Stations]:
Charging station information for the current position area is displayed.
 "Finding charging station" (page 3-24)
- [Update Stations]:
Charging station information is updated through connection to the Nissan CARWINGS Data Center.
 "Updating charging station information" (page 2-6)

- [Energy Information]:
Energy information is displayed on the screen.
 "Energy information display" (page 2-7)
- [Charging Timer]:
The timer charge function can be set.
 "Setting timer charge" (page 2-8)
- [Climate Ctrl. Timer]:
The Climate Ctrl. Timer function can be set.
 "Setting Climate Ctrl. Timer" (page 2-10)
- [CARWINGS]:
Information feeds are displayed and settings for CARWINGS™ can be performed.
 "5. CARWINGS™"
- [Settings]:
Set messages that are displayed on the screen and email messages that can be received using a personal computer or cellular phone.
 "Unique EV function settings" (page 2-13)

NOTE:

- **Establishing the CARWINGS™ service is necessary before using this service.**
- **To check the Li-ion battery charging status or to use the remote heater and air conditioner using an internet enabled smart phone or personal computer, the following conditions must be met:**
 - **The vehicle must be located in a cellular phone or smart phone coverage area.**
 - **The internet enabled cellular phone or smart phone must be located in a cellular phone or smart phone coverage area.**
 - **The computer must be connected to the internet.**
 - **A cellular phone must be used to communicate with the vehicle.**
 - **A cellular phone capable of text messaging must be used to receive text message regarding vehicle charge status.**
- **When the remote heater and air conditioner is set, the system operates the heater and air conditioner to adjust the in-cabin temperature to a factory pre-set temperature.**

DISPLAYING ESTIMATED DRIVING RANGE AND CHARGING STATION INFORMATION

The estimated driving range and charging station information are displayed on the map screen.

- When the charge connector is disconnected from the vehicle, the heater and air conditioner operates using vehicle Li-ion battery electric power.
- If the remote heater and air conditioner function and Li-ion battery charging are performed at the same time, Li-ion battery charging will take longer than usual due to the power used to heat or cool the vehicle.
- Certain remote functions require a compatible smart phone, which is not included with vehicle.
- CARWINGS™ information system features are included through a subscription service which requires owner consent to activate. The subscription must be active to use these features.
- CARWINGS™ communications may be received at a verified e-mail address or by SMS/text messaging-enabled cellular phone.
- Standard text rates and/or data usage may apply depending on your carrier.

CAUTION

Charging station information may not be detailed in all areas or reflect current charging station locations. For up to date information about charging stations, such as business hours or charging equipment, NISSAN recommends that you directly access the information on your own. Additionally, always check the Li-ion battery available charge and set a reasonable driving schedule.



DISPLAYING ESTIMATED DRIVING RANGE

The estimated driving range including the current position or the destination is displayed on the map screen depending on the charging status of the vehicle. A destination or a waypoint can be set on this screen.

INFO:

The estimated driving range map shows the predicted area the vehicle can reach on the basis of the estimated driving range that is indicated in the meter. Driving habits, the actual road environment (hills, etc.), and traffic conditions (traffic jams, etc.) will affect the actual available range.

The Driving Range screen is displayed by performing the following procedure.

- Push the  button on the steering wheel.
- Push the  (Zero Emission menu) button and touch [Driving Range].

INFO:

Models with Li-ion battery heater:

The estimated driving range will increase or decrease when the air conditioner, heater or Li-ion battery heater (if so equipped) is turned on or off, or the vehicle is shifted between D (Drive) and ECO, or when any other accessory is turned on or off based on driving.

How to view driving range screen



- 1 The extended estimated driving range is displayed using the possible driving distance on the meter as a radius.
- 2 The normal estimated driving range is displayed based on the current charging condition.
- 3 [From Dest.]:
The estimated driving range around the destination is displayed while setting the route. If some waypoints are set, the nearest waypoint from the current vehicle position is centered on the estimated driving range map.
[Go Here]:
Any locations that are displayed within the

estimated driving range can be set as a destination or a waypoint.

- 4 Charging station icons:



- : Normal charge icon
- : Quick charge icon (for vehicle equipped for quick charging)

- 5 The possible driving distance is displayed for each estimated driving range.

INFO:

When a route is set that includes waypoints, the estimated driving range will be displayed based on the nearest waypoint.

Setting a charging station as destination

While the estimated driving area is displayed on the map screen, the spot where the cross pointer is placed by moving the map can be set for the destination.



1. Scroll the map, place the cross pointer over the preferred location, and touch [Go Here].

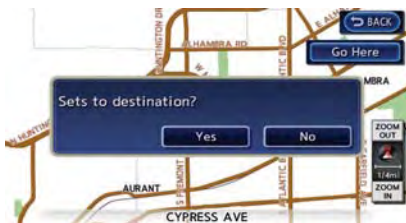

- The system sets the destination to the selected location and starts calculating a route.

INFO:

- This procedure only allows you to set a destination or waypoint on the driving range screen. The system does not automatically set a desired charging station as a destination or waypoint. When a charging station displayed on the map is set as a destination by moving the map, zoom in the map and set a point as a destination as precisely as possible. If the destination is not set precisely, the system may provide guidance to a location that is not a charging station.
- The driving range is displayed as a numeric value above the destination or waypoint that has been set. The values displayed here are approximate and should only be used as a

guide.

DISPLAYING CHARGING STATION ICONS ON MAP

The charging station icons are displayed on the map screen. There are two types of icons: quick charge (for vehicle equipped for quick charging) and normal charge.

- Touch [Map Menu] while the current location map screen is displayed.

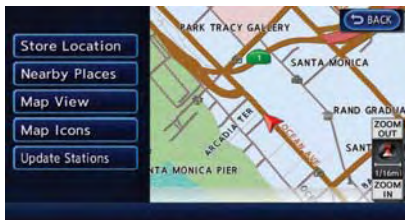

- Touch [Map Icons].



- Touch [Charging Station]. The indicator illuminates when the item is set.

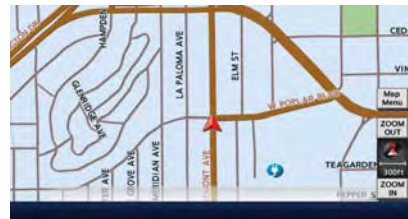

- Push the **MAP** button to return to the current location map screen. The charging station icons are displayed on the map.



Normal charge icon



Quick charge icon (for vehicle equipped for quick charging)

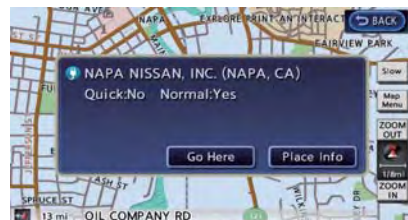

INFO:

When a charging icon on the map is touched, a pop-up screen will appear.

- Touch [Go Here] to set the destination.
- Touch [Place Info] to display charging station information.

Other settings

The charging station icon can be also set by performing the following procedure.

1. Push the  (Zero Emission menu) button and touch [Settings].

2. Touch [Map icons for charging stations].

or

1. Push the **MENU** button and touch [Settings].

2. Touch [Navigation].

3. Touch [Map Icons].

INFO:

- The map icons are not displayed on the map screen when the map scale is set to 1/4 mile (500 m) or higher in the 2D map and the Birdview™ map.
- Display of icons for charging stations registered in the address book cannot be removed using this procedure.

2-6 Unique EV functions

 "Show Icon on Map" (page 3-60)

UPDATING CHARGING STATION INFORMATION

An active CARWINGS™ subscription is needed to update charging station information.

Information about the charging stations that are located around the current position, destination and your home is updated through connection to the NISSAN CARWINGS Data Center.

While the vehicle is connecting to the NISSAN CARWINGS Data Center, information related to charging stations in the area around your home will be automatically updated. Also, when the driving range is restricted, information related to charging stations in the area near the current vehicle location will also be automatically updated.

 "Unique EV function settings" (page 2-13)

Charging station information for the area around a location set can be updated manually by using the following procedure.

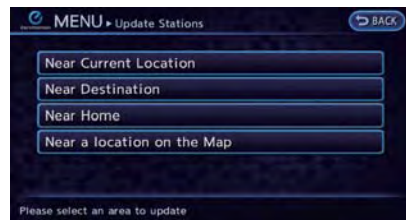

1. Push the  (Zero Emission menu) button and [Update Stations].
2. Touch the preferred setting item. The system then connects to the NISSAN CARWINGS Data Center and the update of charging station information will start.

Available settings

- [Near Current Location]:
Charging station information for the area around the current position is updated.
- [Near Destination]:
Charging station information for the area around the destination is updated.
- [Near Home]:
Charging station information for the area around your home is updated. Registration of your home in the Address Book is necessary before using this item.
 "Storing home location" (page 1-12)

- [Near a location on the Map]:
Charging station information for the area where the cross pointer is placed by moving the map is updated.



3. When [Stop] is touched while updating information, connection to the NISSAN CARWINGS Data Center is disconnected.

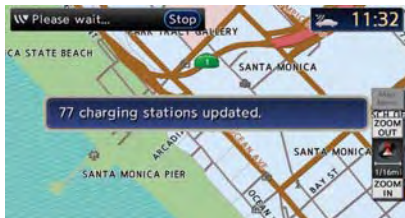

4. When the update is completed, a message is displayed.

ENERGY INFORMATION DISPLAY

Energy economy and energy usage information are displayed.

VIEWING ENERGY ECONOMY INFORMATION

Estimated driving range, average energy economy and instant energy economy are displayed.

1. Push the  (Zero Emission menu) button.
2. Touch [Energy Info.].
3. Touch [Energy Economy].



- ① Driving Range:
The possible driving distance based on the current charging status is displayed.
- ② Average:
The average energy economy from the previous to the next resets is displayed.
- ③ Instant:
The system shows the distance that the vehicle can travel using 1kWh.

- ④ [Reset]:
Touch [Reset] to reset the average energy economy. After resetting the average energy economy, it is stored in the history.

INFO:

Battery power is generated and stored by the cooperative regenerative brake while driving. When this occurs, the instant value will be displayed as the maximum. The maximum value will be displayed until the generated power is consumed.

VIEWING ENERGY ECONOMY HISTORY

The previous 10 histories of the average energy economy are displayed.

1. Push the  (Zero Emission menu) button.
2. Touch [Energy Info.].
3. Touch [History].



- ① Driving Range:
The possible driving distance based on the current charging status is displayed.
- ② Previous Reset Intervals:
The average energy economy history is displayed from along with the average for previous Reset-to-Reset period.
- ③ Current Period:
The average energy economy from the previous to the next resets is displayed.

- ① Driving Range:
The possible driving distance based on the current charging status is displayed.
- ② Variation of the possible driving distances between the climate control ON and OFF is displayed.
- ③ Electric Motor:
Energy usage by the motor and regenerated energy are displayed.
- ④ Climate Control:
Energy usage by the climate control function is displayed.
- ⑤ Other Systems:
Energy usage by other equipment (audio, etc.) is displayed.

VIEWING ENERGY USAGE INFORMATION

Estimated driving range and energy usage of various systems are displayed.

1. Push the  (Zero Emission menu) button.
2. Touch [Energy Info.].

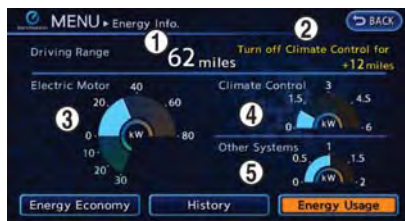

TIMER FUNCTION OPERATION

This function enables the batteries to be charged and the climate control to be turned on automatically at a regular time and day of the week.

SETTING TIMER CHARGE

Use charging timer to schedule when the Li-ion battery charges. You can save two timer settings that include the charging start time and end time. One of the timer settings can be applied to each day of the week. The vehicle automatically begins charging at the scheduled times when the charge connector is connected to the vehicle. The timers do not need to be reset each time the Li-ion battery needs charged.

1. Push the  (Zero Emission menu) button and touch [Charging Timer].



2. Touch [Set Timer 1] or [Set Timer 2]. The following explains the procedure for setting Timer 1.



- Enter the Li-ion battery charge start time. Touch [% Charge] to change the amount of charging. Touch [END Time] to change the time to stop charging.

INFO:

- Charging timer is performed according to the current time setting on the bottom right of the display. When setting the charging timer function, be sure to check that the current time displayed is correct.
- In the default setting, [100% Charge (Maximizes Driving Range)] is selected. This is called long distance mode. To extend the life span of the Li-ion battery, use long life mode by selecting [80% Charge (Improves Battery Longevity)]. For details, see the LEAF Owner's Manual.

- To set the timer charge for different days of the week, touch [Assign Days]. Select the preferred timer setting for each day of the week. When the settings are completed, touch [OK].
- When the settings are completed, touch [Save Timer]. The settings confirmation screen will be displayed.

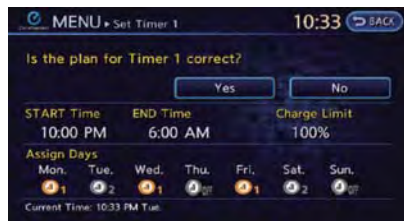

- If the settings shown on the screen are correct, touch [Yes].

- The [Timer 1] indicator illuminates after the charging timer is set. Use the same procedure to set the Timer 2 setting.
- Place the power switch in the OFF position, and then connect the charge connector to the vehicle.

INFO:

- Always place the power switch in the OFF position after setting the charging timers. When the power switch is in the ON position, the Li-ion battery will not start charging.
- The Li-ion battery may not be charged to the expected level (80% or 100%) if the charging timer start time and end time are set so there is not enough time to charge the Li-ion battery.

- When either the charge start time or charge end time is set, the charging timer function is activated.
- When only the charging timer end time is set, the system automatically determines when to begin charging based on the Li-ion battery charge level. The Li-ion battery may not be charged to the expected level (80% or 100%) if the charging timer end time is set so there is not enough time to charge the Li-ion battery.
- When only the charging timer end time is set, the system automatically stops charging when the Li-ion battery charges to the selected level (80% or 100%). Charging may stop before the scheduled end time.
- Touch [Timer 1] or [Timer 2] to turn off the charging timer function. Touch [Yes] if the settings shown on the screen are correct. After this operation has been performed, the indicator disappears and the charging timer function is turned off. The start and stop time settings are not deleted, even if the charging timer function is turned off.
- If charging timer and the Climate Ctrl. Timer are operating at the same time due to an overlap of the timer settings, you can prioritize which function receives electrical power first.

 "Unique EV function settings"
(page 2-13)

- When charging is set as the first priority, the Climate Ctrl. Timer does not start until 10 segments of the Li-ion battery available charge gauge are illuminated.
- When the climate control is set as the first priority, the climate control system will be turned on as scheduled by the Climate Ctrl. Timer regardless of the remaining battery energy.
- Even when the climate control is set as the first priority, the climate control system will be turned off when the climate control system requires more power than can be provided to the Li-ion battery for charging.
- The Li-ion battery will not charge when the charge connector is connected to the vehicle until the next scheduled charge start time when the charge timer is active. If necessary, use immediate charge or remote charge to charge the Li-ion battery.
- Some charging stations used to perform normal charge are equipped with timer functions. If the charger timer function and the vehicle timer are both set, and the two timers are not set to operate at the same time, it is possible that the charger will not start or the battery will not be charged to the

level expected.



INFO:

Models with Li-ion battery heater:

- The Li-ion battery may not charge to the expected level when the Li-ion battery heater operates while charging using the Charging Timer.
- Set only the Charging Timer End time when charging in cold weather. The vehicle automatically determines when to start charging to fully charge the Li-ion battery, even if the Li-ion battery heater operates. Charging ends before the set End time if the Li-ion battery is fully charged.

SETTING CLIMATE CTRL. TIMER

The air conditioner starts to operate at the time of day and day of the week specified in the settings. While the charger is connected to vehicle, this function pre-heats or pre-cools the passenger compartment of the vehicle to the factory preset temperature before driving. This helps reduce power consumption from the Li-ion battery.

As the temperature is set to the factory default setting, the user cannot adjust the temperature. The Climate Ctrl. Timer operates the air condi-

tioner using power from the charger. Electric power from the Li-ion battery is not used.

The Climate Ctrl. Timer function allows two different timer settings. Each timer charge function can be set to activate on a different day of the week.

Once the Climate Ctrl. Timer is set, it automatically starts when the set time is reached. It is therefore not necessary to set the Climate Ctrl. Timer everyday.

WARNING

Even if the Climate Ctrl. Timer is set, the temperature in the passenger compartment may become high if the system automatically stops. Do not leave children or adults who would normally require the support of others alone in your vehicle. Pets should not be left alone either. On hot, sunny days, temperatures in a closed vehicle could quickly become high enough to cause severe or possibly fatal injuries to people or animals.

1. Push the  (Zero Emission menu) button and touch [Climate Ctrl. Timer] .



2. Touch [Set Timer 1] or [Set Timer 2]. The following explains the procedure for setting Timer 1 .



3. Enter the departure time.



4. To set the Climate Ctrl. Timer for different days of the week, touch [Assign Days]. Select the preferred timer setting for each day of the week. After setting, touch [OK]. The previous screen is displayed.
5. When the settings are completed, touch [Save Timer]. The settings confirmation screen will be displayed.



6. If the settings shown on the screen are correct, touch [Yes].



7. The [Timer 1] indicator illuminates after the Climate Ctrl. Timer is set. Use the same procedure to set the Timer 2 setting.
8. Turn the power switch to the "OFF" position, and then connect the charge connector to the vehicle.

INFO:

- The Climate Ctrl. Timer will only start when the power switch is in the "OFF" position. Always turn the power switch to the "OFF" position after the Climate Ctrl. Timer is set.
- Touch [Timer 1] or [Timer 2] to turn off the Climate Ctrl. Timer function. After this operation has been performed, the indicator turns off and the Climate Ctrl. Timer function will be turned off. The start and stop time settings are not deleted even if the Climate Ctrl. Timer function is turned off.

- While the Climate Ctrl. Timer operates, the Climate Ctrl. Timer indicator and the charging status indicator lights flash. If the Climate Ctrl. Timer is set to activate, the Climate Ctrl. Timer indicator illuminates.
- If the timer charge function and the Climate Ctrl. Timer are in operation at the same time due to an overlap of the timer settings, either function can be set to be preferentially provided with electric power.
 - ☞ "Unique EV function settings" (page 2-13)
- The temperature in the passenger compartment may not be comfortable if entering the vehicle too soon before or too long after the scheduled time of departure.
- Air conditioning is limited to the capacity of the electric power when the charge connector is connected. Therefore, the temperature may not reach the factory default setting due to limitations in air conditioning performance, if ambient temperature is excessively high or low, or if the charge connector is connected to a 120 V plug outlet.
- While the battery is being charged, the Climate Ctrl. Timer cannot be operated until the Li-ion battery available charge gauge has reached the full mark.

When the battery is not being charged, the Climate Ctrl. Timer can be operated, even if the Li-ion battery available charge gauge has not reached the full mark.

- When the climate control is set as the first priority, the Climate Ctrl. Timer works regardless of the remaining battery energy.
- If the Climate Ctrl. Timer starts operating while the vehicle is being charged, the time required for charging will be longer.
- Operating the Climate Ctrl. Timer or remote climate control in an environment where the temperature is low may decrease the rate of battery charge.
- The Climate Ctrl. Timer settings cannot be modified while it is operating. If timer settings are modified while the Climate Ctrl. Timer is operating, these changes will be reflected the next time the Climate Ctrl. Timer operates.
- When charging is set as the first priority, the Climate Ctrl. Timer does not start until 10 segments of the Li-ion battery available charge gauge are illuminated.
- When climate control is set as the first priority, the climate control system will be turned on as scheduled by the Climate Ctrl. Timer regardless of the remaining battery energy.

- Even when the climate control is set as the first priority, the climate control system will be turned off when the climate control consumes more power than the charging Li-ion battery.
- The Li-ion battery may not charge or may even become discharged if the Climate Ctrl. Timer or remote climate control is used in low ambient temperatures.
- The Climate Ctrl. Timer operates the climate control function so that a comfortable temperature is provided in the passenger compartment at the scheduled time of departure. The climate control is set to stop at the scheduled time of departure. The temperature in the passenger compartment may not be comfortable if entering the vehicle too soon before or too long after the scheduled time of departure.



INFO:

Models with Li-ion battery heater:

- The charging status indicator lights illuminate in a specific pattern when the Li-ion battery heater operates. The charging status indicator lights use the same pattern to indicate 12-volt battery charging, Climate Ctrl. Timer operation or Remote Climate Control operation. The charging status

indicator lights do not change if the Li-ion battery heater operates at the same time as the above features. See charging status indicator lights Owner's Manual for the details.

- Climate control performance is reduced when using the Climate Ctrl. Timer or Remote Climate Control while the Li-ion battery heater operates.

UNIQUE EV FUNCTION SETTINGS

An active CARWINGS™ subscription is needed to remotely check charge status, battery status, use remote charging, remote start Heat and cooling and to receive e-mails/text messages.



1. Push the (Zero Emission menu) button and Touch [Settings].
2. Touch the item you want to set.

Available settings

- [Battery & Power Alerts]:
When an indicator light located in the meter illuminates, messages are displayed and actions are provided on the navigation screen.
 "Setting messages that are displayed on screen" (page 2-14)
- [Charging messages]:
Sends a notification to a preset e-mail address. This notification includes the charge connector status and the charge

completion.

 "CARWINGS™ settings" (page 5-10)

- [Map Icons for charging stations]:

The charging station icons are displayed on the map screen.

 "Displaying charging station icons on map" (page 2-5)

- [Other Settings]:

- [Autosave New Charging Stations]:

If charging station information you have used is not stored in the system, the location will be automatically registered in the Address Book.

Turn this setting off if you do not want the charging location to be stored automatically.

- [Auto-Update Stations]:

While the vehicle is connecting to the NISSAN CARWINGS Data Center, information related to charging stations near your home will be automatically updated.

- [Timer With Priority]:

If the timer charge function and the Climate Ctrl. Timer function are in operation at the same time due to an overlap of the timer settings, either function can be set to be preferentially provided with electric power.

- [Charging Port Types to Include in Station Searches]:

When [Quick Charge] is set to OFF, the quick charge icon will not be displayed.



INFO:

For vehicles without the quick charge port, NISSAN recommends you turn off the quick charging station icons by setting [Quick Charge] to OFF.

SETTING MESSAGES THAT ARE DISPLAYED ON SCREEN

When an indicator light located in the meter illuminates, messages are displayed and actions are provided on the navigation screen.

1. Touch [Battery & Power Alerts].



2. Touch the item you want to set. The indicator of the selected item is illuminated.

Available settings

- [Use All Battery & Power Alerts]:

Displays all information on the navigation screen.

- [Limited Power]:

Displays a message on the navigation screen to inform the driver that power output is restricted. The power limitation indicator  illuminates in the meter.

 "Limited Power Notice" (page 2-16)

- [Low Battery]:

Displays the Low Battery message when the low battery charge warning light  illuminates.

 "Low Battery" (page 2-15)

- [Dest. out of Range]:

Displays a message on the navigation screen to inform the driver that the battery should be charged soon. This will be indicated if the estimated driving range is less than the remaining distance to the destination when a route to the destination is set.

 "Charge recommendation guidance" (page 2-15)

BATTERY AND POWER INFORMATION

For detail information about the warning/indicator lights, see the LEAF Owner's Manual.

Charge recommendation guidance

If the remaining driving range is less than the distance to the destination that is entered while setting the route, the system displays a message on the navigation screen that recommends battery charging.

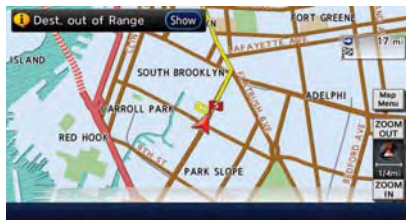

1. The notification is displayed on the upper left side of the screen. Touch [Show] to display the detailed information screen.



2. The system displays a message screen and announces the contents of the message to recommend battery charging. Check the message displayed on the screen.

Touch [Nearby Charging Station] to search all charging stations that are located near the current vehicle position.

☞ "Finding charging station" (page 3-24)



3. Touch [BACK] or push the **MAP** button to return to the current location map screen.

INFO:

- The charge recommendation guidance can be set to off.
☞ "Setting messages that are displayed on screen" (page 2-14)
- When the route is changed to avoid a traffic jam or the possible driving distance indicated in the meter is changed, the charge recommendation guidance is displayed

again.

Low Battery

When the Low battery charge warning light  and the master warning light (yellow)  illuminate, the system displays a message on the navigation screen that notices the driver that the Li-ion battery power level is low.

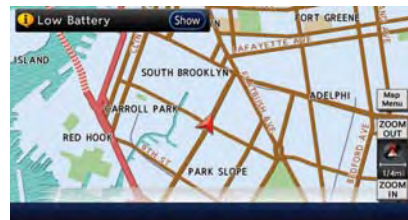

1. The notification is displayed on the upper left side of the screen. Touch [Show] to display the detailed information screen.



- The system displays a message screen and announces the contents of the message to warn that the battery power level is low. Check the message displayed on the screen.

Touch [Nearby Charging Station] to search all charging stations that are located near the current vehicle position.



 "Finding charging station" (page 3-24)

- Touch [BACK] or push the **MAP** button to return to the vehicle location screen.

INFO:

- The Low Battery message display can be set to off.
 "Setting messages that are displayed on screen" (page 2-14)
- When the Li-ion battery power level is low, the system automatically obtains charging station information.

Limited Power Notice

When the power limitation indicator  and the master warning light (yellow)  illuminate, the system displays a message on the navigation screen that notices the driver that power output is restricted for various reasons. See LEAF Owner's Manual for details of the indicator/

warning lights.

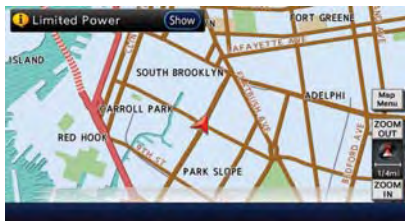

- The notification is displayed on the upper left side of the screen. Touch [Show] to display the detailed information screen.



- The system displays a message screen and announces the contents of the message to warn that power output is restricted and inform the driver of the reason for this occurrence and what action is to be taken.

INFO:

The Limited Power Notice display can be set to off.

 "Setting messages that are displayed on screen" (page 2-14)

MEMO

MEMO

3 Navigation

Map settings	3-3	Setting intersection	3-31
Map types	3-3	Setting city center	3-32
Displaying current vehicle location	3-5	Setting point on map	3-33
Moving map	3-5	Operations after setting destination	3-34
Changing scale of map	3-7	Route guidance	3-36
Changing map view	3-8	Procedures after setting route	3-36
Map view settings	3-9	About route guidance	3-38
Looking at information on map	3-12	Guidance screen settings	3-40
Map menu screen	3-14	Route screen	3-43
Map symbols	3-16	Canceling/reactivating route	3-44
Setting destination	3-17	Editing route	3-45
Destination screen	3-17	Confirming route	3-49
Changing region	3-18	Voice guidance settings	3-50
Finding address	3-19	Recalculating route	3-50
Finding place	3-21	Setting detour route	3-51
Setting home as destination	3-23	Searching for detour route using traffic information	3-51
Finding charging station	3-24	Setting conditions for route calculation	3-52
Searching from address book	3-26	Route guidance settings	3-54
Searching from history	3-27	Storing a location/route	3-55
Finding nearby place	3-28	Storing location	3-55
Setting from stored routes	3-29	Storing route	3-57
Setting by phone number	3-29	Storing avoid area	3-58
Setting freeway entrance/exit	3-30		

Editing address book.....	3-59
Deleting stored item.....	3-65
Transferring information to/from address book	3-67
Navigation settings	3-69
Speed limit indication on map.....	3-70
Other navigation settings.....	3-70
Resetting all navigation settings to default	3-73

MAP SETTINGS

MAP TYPES

Two types of map views are available: 2D map and Birdview™ (3D) map.

2D map



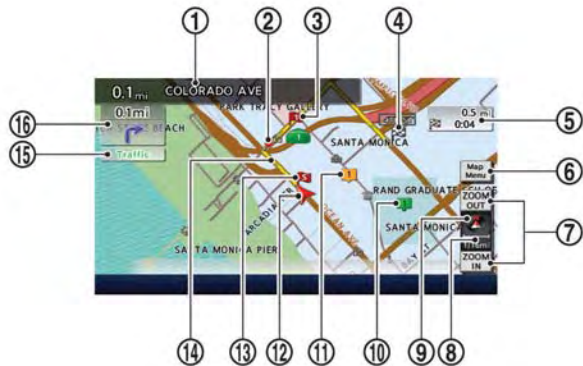





The 2D map displays the map in a 2-dimensional environment similar to a road map.



Screen information:

- ① Next street name:
Displays the name of the next street on the route.
- ② Guide point:
Indicates a guide point on the route.
- ③ Waypoint:
Displays the locations that you travel past when going to the destination. A maximum of 5 waypoints can be set.
- ④ Destination:
Indicates the destination location of the route

guidance.

- ⑤  Remaining time and distance to the destination:
Indicates the approximate remaining time and distance to the destination or waypoint. This indicator will appear when a destination or waypoint is set and route guidance is started.
When the vehicle is not driven on the suggested route, the screen displays the direction to the destination and the distance to the destination from the current vehicle position.
 "Switching estimated arrival time display" (page 3-55)
- ⑥ [Map Menu]:
Touch the icon to display the Map Menu screen.
 "Map menu screen" (page 3-14)
- ⑦ [ZOOM OUT]/[ZOOM IN]:
Touch the icon to change the map scale.
 "Changing scale of map" (page 3-7)
- ⑧ Scale indicator:
Indicates the scale of the map.
- ⑨ Direction indicator:
Indicates the directional setting of the map.
Touch the icon to switch the direction of the map.
: North always pointing up.
: Direction of the vehicle always pointing up.
 "Setting map orientation" (page 3-10)
- ⑩  Avoid Area (green or blue):
Displays the areas to avoid that are stored in the Address Book with green or blue icons. During the route search, the route guidance is performed

by searching for a route that avoids those areas.

 "Storing avoid area" (page 3-58)

⑪  Stored location (orange):

Displays the locations that are stored in the Address Book. Icons can be changed according to personal preferences.

 "Storing location" (page 3-55)

⑫  Vehicle icon:

Indicates the current vehicle location and the direction of travel.

⑬ Starting point:

Displays the vehicle location, with which the route is set, as the starting point.

⑭ Suggested route:

Appears in bold yellow during route guidance.

⑮  Traffic indicator:

Displays the reception condition of the traffic information transmitted from the provider.

Green: Reception is good.

Gray: Reception is poor.

No mark: Subscription to XM NavTraffic® service is not detected.

⑯  Arrow:

Indicates the distance to the next guide point and the turning direction at that guide point.



 **INFO:**

Note the following items about the Birdview™ display.

- "Birdview™" is a registered trademark of Clarion Co., Ltd.
- The map in Birdview™ always appears with the current forward direction facing up.

Birdview™ (3D) map

Birdview™ displays the map from an elevated perspective. In Birdview™, it is easy to recognize an image of the route because it provides a panoramic view over a long distance.

DISPLAYING CURRENT VEHICLE LOCATION

Operating with control panel



The basic map screen displays the current location (the position where the vehicle mark is located). Push the **MAP** button to display the current location on the map while on any screen.

Operating with touch panel operation

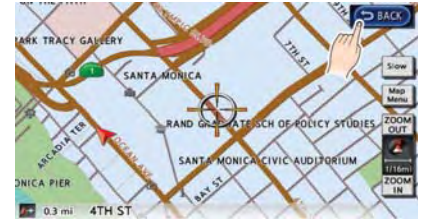

After moving the map, touch [BACK] on the map screen to display the current location map screen.

MOVING MAP

The operations for moving across the map are different between the 2D and Birdview™ maps.

2D map

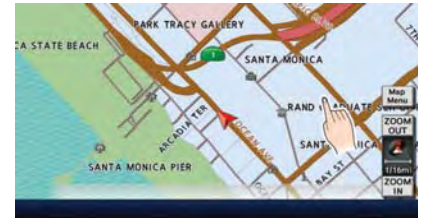

1. Touch the screen. The cross pointer is displayed, and the position touched is set as the center of the screen.

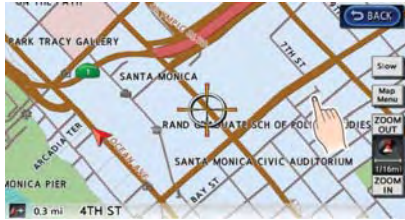

2. Touch the direction to move to. The map continues to scroll while the screen is touched.

INFO:

While driving, scrolling on the map is limited to a specified distance.

Fine-tuning the cursor position:

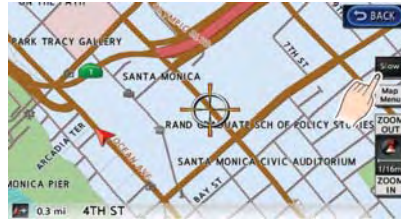

1. Touch [Slow]. The 8-directional key is displayed.

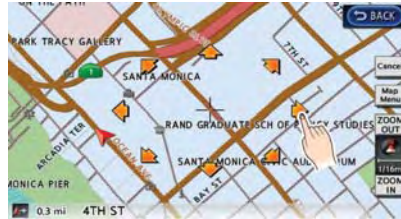

2. Touch the 8-directional key to adjust the cross pointer position.

INFO:

- When [Cancel] is touched, display of the 8-directional key will be turned off and the system will switch to normal map scrolling operation.
- Fine-tuning the cursor position is not possible while driving.

Birdview™ (3D) map



1. Touch the screen. The cross pointer and 8-directional key are displayed.



2. Touch the direction to move to. The map continues to scroll while the screen is touched.



3. Touch [🔄] or [↺] to change the direction of the map.

- 🔄 : Rotates the map clockwise.
- ↺ : Rotates the map counterclockwise.

INFO:

While driving, scrolling on the map is limited to a specified distance.

CHANGING SCALE OF MAP

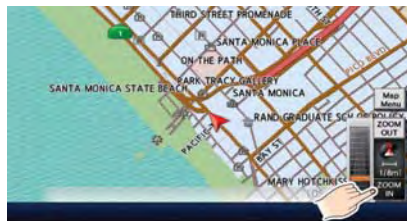

1. Touch [ZOOM IN] or [ZOOM OUT] to change the scale.

INFO:

Free zoom:

The scale can be changed in smaller steps when [ZOOM IN] or [ZOOM OUT] is touched and held than when either key is briefly touched. If briefly touched, the operation returns to normal.

Map scale

Any required map scale (map coverage) between 400 miles (640 km) and 1/32 mile (50 m) can be selected.

Scale level for 2D map and Birdview™ map (3D) display:

Normal Map	US Units	Metric Units
	320 miles	640 km
	80 miles	160 km
	32 miles	64 km
	8 miles	16 km
	5 miles	10 km
	2 miles	4 km
	1 mile	2 km
	1/2 mile	1 km
	1/4 mile	500 m
1/8 mile	200 m	
1/16 mile	100 m	
1/32 mile	50 m	

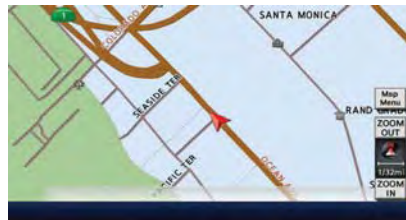

Example: The most detailed level (2D map)

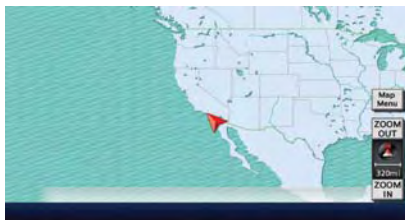

Example: The widest level (2D map)



Example: The most detailed level (Birdview™ map)



Example: The widest level (Birdview™ map)

INFO:

The traffic information icons are not displayed on the map screen when the map scale is set to 8 miles (16 km) or higher.

 “Traffic information display and scale levels” (page 6-9)

CHANGING MAP VIEW

The map view can be changed between the 2D and Birdview™ maps. The map can also be displayed in the split screen mode.

1. Touch [Map Menu] while the current location map screen is displayed.

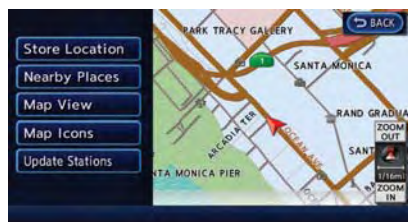

2. Touch [Map View].



3. Touch the preferred map view. The indicator of the selected preferred map view illuminates.
4. The display automatically returns to the current location map screen.

Available views

- [2D Map]:
Switches to the 2D map.
- [Birdview (3D)]:
Switches to the Birdview™ map.
- [Split: 2D Map]:
Changes to the split screen mode and both halves display maps in 2D.
- [Split: Birdview Map]:
Changes to the split screen mode and the left half displays the map in 2D and the right half displays the map in Birdview™.

INFO:

- When the split screen mode is selected, the map settings for the left screen can be changed independently.

 “Setting left screen display”
(page 3-12)

- If the split screen mode is selected, the normal map scrolling and scale adjustment are set in the right screen.

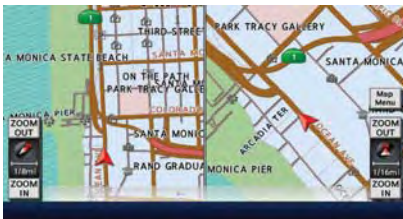

Split: 2D Map

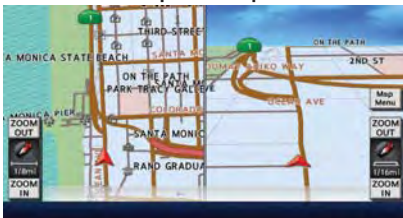

Split: Birdview™ Map

Other settings

The map view can also be set by performing the following procedure.

1. Push the **MENU** button and touch [Settings].
2. Touch [Navigation].
3. Touch [Map View].

MAP VIEW SETTINGS

Other settings are also available for the map screen, such as changing the map direction, Birdview™ angle, etc.

1. Touch [Map Menu] while the current location map screen is displayed.

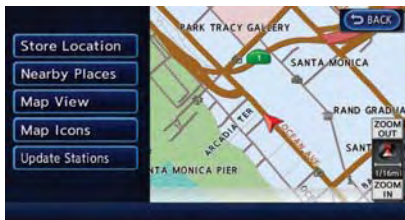

2. Touch [Map View].





3. Touch [Map Settings].



4. Touch the item you would like to set.

Available settings

- [Map Orientation]: Sets the map direction to North Up or Heading Up.
 “Setting map orientation” (page 3-10)
- [Long Range]: Sets the long range map view display on/off.
 “Settings long range map view”
(page 3-11)

- [Birdview Angle]:
Changes the Birdview™ angle.
☞ “Changing Birdview™ angle”
(page 3-11)
- [Left Split Map Settings]:
Sets the map settings for the left screen of the split map.
☞ “Setting left screen display”
(page 3-12)
- [Show all Freeway Exits on Route]:
Sets the display of the freeway exit information on/off.
☞ “Show exit information on freeways”
(page 3-41)
- [Auto. Show Turn List on Freeway]:
The turn list can be set on or off to be displayed automatically while driving on a freeway.

Other settings:

The orientation of the map can also be set by performing the following procedure.

1. Push the **MENU** button and touch [Settings].
2. Touch [Navigation].
3. Touch [Map View].
4. Touch [Map Settings].

Setting map orientation

The map direction (orientation) can also be changed in the 2D map. These settings are available only in the 2D map or 2D/2D split map.



1. Touch [Map Orientation].





2. Touch the preferred map orientation. The indicator of the selected map orientation illuminates.
3. Push the **MAP** button to return to the current location map screen.

Available map orientations

- [North Up]:
The top of the map remains oriented to the north.
- [Heading Up]:
The top of the map follows the traveling direction.

INFO:

The direction of the map can also be changed by touching the icon on the map. The method for changing the direction of the map by touching an icon can only be used when the current location map is displayed. If the map orientation is switched, the icon displayed in the lower right corner is also switched.

-  : North Up
-  : Heading Up

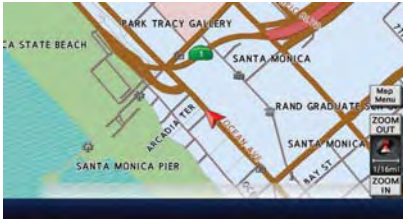

North Up



Heading Up

Settings long range map view

The position of the vehicle icon can be changed to view a wider area in the direction that the vehicle is traveling. If this function is activated, the vehicle icon is located slightly lower than the center of the screen.



1. Touch [Long Range]. The indicator illuminates when the item is set.
2. Push the **MAP** button to return to the current location map screen.

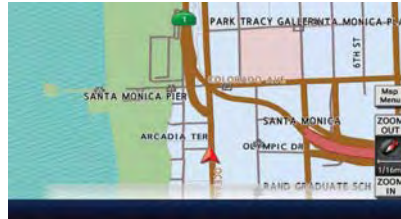

Long Range Map View

INFO:

[Long Range] is displayed only when [Heading Up] is selected.

Changing Birdview™ angle

The Birdview™ angle can be changed. This setting is available only in the Birdview™ map or 2D/Birdview™ split map.



1. Touch [Birdview Angle].



- Adjust the Birdview™ angle by touching [Raise] or [Lower].
- Push the **MAP** button to return to the current location map screen.

Setting left screen display

When the split screen is displayed, the map settings of the left screen can be changed.

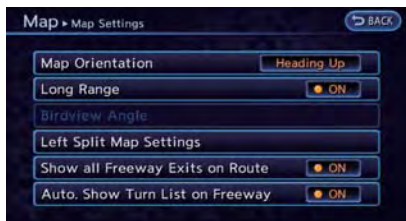

- Touch [Left Split Map Settings].



- Touch the preferred map setting.

- Push the **MAP** button to return to the current location map screen.

Available settings

- [Map Orientation]:
The map direction can be selected as follows.
 - [North Up]:
The top of the map remains oriented to the north.
 - [Heading Up]:
The top of the map follows the direction in which the vehicle is traveling.
- [Long Range]:
Positions the vehicle icon slightly lower than the center of the screen. This offers a wider view in the traveling direction.
- [Map Scale]:
Displays a scale on the left side of the screen. Use this to change the scale of a map.



INFO:

- The settings of the right screen are the same as the settings of the full screen map.
- The scale of the map can also be changed by touching [ZOOM OUT] or [ZOOM IN].

LOOKING AT INFORMATION ON MAP

Icons can be displayed on the map, and information about destinations and landmarks can be displayed.

Displaying map icons

The map icons can be displayed or hidden by type.

- Touch [Map Menu] while the current location map screen is displayed.

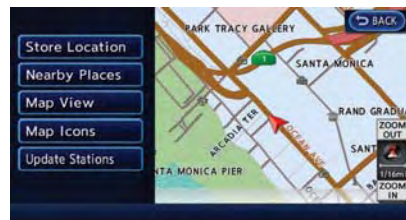

- Touch [Map Icons].





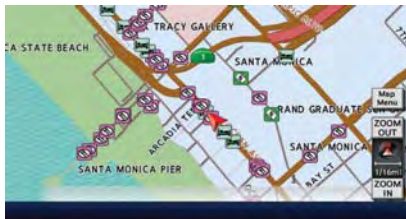

3. Touch the preferred icon. The indicator of the selected icon illuminates.



4. Push the **MAP** button to return to the current location map screen. The activated icons are displayed on the map.

The following map items can be displayed.

-  : Restaurant
-  : Charging Station
-  : Hotel
-  : ATM
-  : Rest Area

INFO:

- **The map icons are not displayed on the map screen when the map scale is set to 1/4 mile (500 m) or higher in the 2D and Birdview™ map.**
- If they are registered in the map data, the brand icons will be displayed on the map instead of the general map icons listed

below.

Other settings

The map icons can also be set by performing the following procedure.

1. Push the **MENU** button and touch [Settings].
2. Touch [Navigation].
3. Touch [Map Icons].

Map scrolling information

Information about the location, on which the center of the cross pointer is placed by scrolling on the map, can be set to be displayed.

1. Push the **MENU** button and touch [Settings].
2. Touch [Navigation].

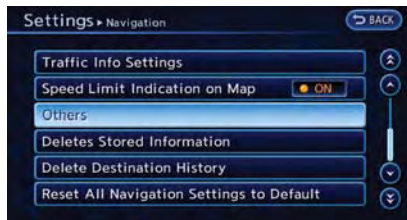

3. Touch [Others].

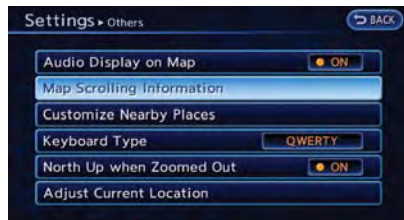

4. Touch [Map Scrolling Information].



5. Touch the preferred information item. The indicator of the selected information item illuminates.

The following information items are available.

- [Address Book Icons]
- [Destination/Waypoint Icons]
- [Latitude/Longitude Info.]
- [CARWINGS Icons]

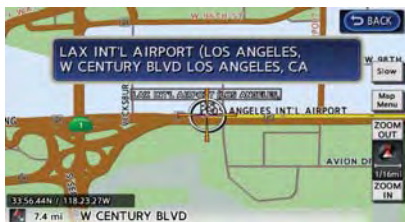

6. Push the **MAP** button to return to the current location map screen. Move the cross pointer to the set location to display the information.

MAP MENU SCREEN

Touch [Map Menu] while the current location map screen or a scrolled map screen is displayed to display the menu corresponding to that screen.

This menu can be used to access helpful functions quickly, such as setting a destination and searching for points of interest nearby.

Current location map screen

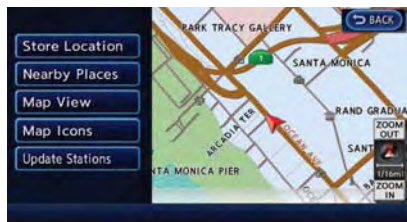

If [Map Menu] is touched while the current location map screen is displayed, the following options are available.

- [Store Location]:
Stores the current vehicle location in the Address Book. The stored location can be retrieved as necessary to set it as a destination (waypoint).
☞ "Storing location" (page 3-35)
- [Nearby Places]:
Searches for points of interest near the current vehicle location, such as restaurants and charging stations, etc.
☞ "Finding nearby place" (page 3-28)
- [Map View]:
Performs map operations such as the switching of map type and the setting of map orientation and scale.
☞ "Map settings" (page 3-3)

- [Map Icons]:
Displays map icons of certain points of interest (such as restaurants and charging stations, etc.) on the map around the current vehicle location.
☞ "Displaying map icons" (page 3-12)
- [Update Stations]:
Contact the NISSAN CARWINGS Data Center to update charging station around the current vehicle location.
☞ "Updating charging station information" (page 2-6)

Scrolled location map screen

If [Map Menu] is touched while a scrolled map screen is displayed, the following options are available.

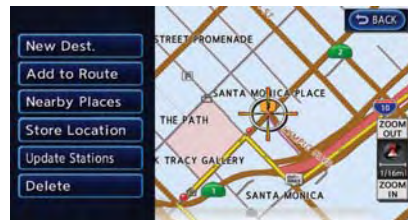

- [New Dest.]:
Sets the destination to the map location where [New Dest.] was touched. If a

destination is already set, the location will be set as the new destination.

 "Setting point on map" (page 3-33)

- [Add to Route]:

Sets the map location where [Add to Route] was touched as the destination or a waypoint. This is available only when a suggested route is already set.

 "Setting destination or waypoint" (page 3-45)

- [Nearby Places]:

Searches for points of interest such as restaurants and charging stations, etc. near the location by scrolling the map.

 "Finding nearby place" (page 3-28)

- [Store Location]:

Store the map location where [Store location] was touched in the Address Book. The stored location can be retrieved to set it as a destination or waypoint.

 "Storing location" (page 3-35)

- [Update Stations]:

Contact the NISSAN CARWINGS Data Center to update charging station around the point of the cursor.

 "Updating charging station information" (page 2-6)





























- [Delete]:

Deletes a destination, waypoint or stored location. To delete, place the cross pointer over the corresponding icon.

MAP SYMBOLS

This navigation system uses symbols to display facilities.

2-dimensional icons (Plan View)

 Airport	 Golf Course	 Museum	 Shopping Center
 Amusement Park	 Normal Charge	 Quick Charge (for vehicle if so equipped)	 Open Parking Area
 Sports Complex	 Bank	 Historical Monument	 Park & Ride
 Station	 City Hall	 Hotel or Motel	 Parking Garage
 Super Market	 Commuter Rail Station	 Library	 Police Station
 Tourist Office	 Courthouse	 Marina	 Rest Area
 University or College	 Ferry Terminal	 Military Base	 Restaurant

Road color

The road types are differentiated by colors.

Freeway:

 (Red or light red (zoomed in))

Main road:

 (Brown or dark yellow)

Narrow street:

 (Gray)

Road with incomplete map data:

 (Dark green)

Traffic information on map

With a subscription to the XM NavTraffic® service, traffic information is displayed.

 "Viewing available traffic information"
(page 6-6)

Free Flow:

 (Green)

Moderate traffic:

 (Yellow)

Heavy traffic:

 (Red)

Section affected by serious traffic event:

 (Purple)

The following traffic information icons may be

displayed

 Accident

 Closed road

 Information

 Road work

 Slippery road

 Weather

 Incident

SETTING DESTINATION



DESTINATION SCREEN

There are several methods that can be used to set a destination. Understand the advantages of each method and select the best method for finding and setting a preferred destination.



1. Push the **MENU** button and touch [Destination].
2. Touch the preferred method for setting the destination.

Available settings

- [Street Address]: Searches for a destination by address.
 "Finding address" (page 3-19)
- [Places]: Searches for a destination from various categories of businesses or locations.
 "Finding place" (page 3-21)

- [Home]:
Searches for a route from the current location to the previously stored home destination.
☞ "Setting home as destination" (page 3-23)
- [Nearby Charging Stations]:
Searches for charging stations located near the current vehicle location.
☞ "Finding charging station" (page 3-24)
- [Address Book]:
Searches for a destination from the list of the stored locations.
☞ "Searching from address book" (page 3-26)
- [Previous Destinations]:
Sets the previous starting point as the destination. Searches for the destination from the previous destinations.
☞ "Searching from history" (page 3-27)
- [Nearby Places]:
Searches for points of interest near the current vehicle location, such as restaurants and charging stations, etc.
☞ "Finding nearby place" (page 3-28)

Available settings (next page screen)

- [Stored Routes]:
Selects a stored route.
☞ "Setting from stored routes" (page 3-29)
- [Phone Number]:
Searches for a point of interest by a telephone number.
☞ "Setting by phone number" (page 3-29)
- [Freeway Entrance/Exit]:
Searches for a destination from a freeway entrance/exit.
☞ "Setting freeway entrance/exit" (page 3-30)
- [Intersection]:
Searches for a destination from an intersection.
☞ "Setting intersection" (page 3-31)
- [City Center]:
Sets the center of a city as the destination.
☞ "Setting city center" (page 3-32)

CHANGING REGION

When setting a destination, the location can be narrowed down by specifying the region or city.

Specifying region



1. Push the **MENU** button and touch [Destination].
2. Touch [Change Region].
3. Touch the preferred region from the list. After setting, the display automatically returns to the Destination screen.

Available settings

- US1: CA, NV
- US2: AZ, CO, ID, MT, NM, OR, UT, WA, WY
- US3: IA, KS, MN, MO, ND, NE, SD
- US4: AR, LA, MS, OK, TX
- US5: IL, IN, MI, WI

- US6: DC, DE, KY, MD, OH, PA, VA, WV
- US7: CT, MA, ME, NH, NJ, NY, RI, VT
- US8: AL, FL, GA, NC, SC, TN
- US9: AK
- US10: HI
- Canada

INFO:

- It is also possible to select a region by touching the map on the right side of the screen.
- It is not possible to search for a route from the continental United States to Hawaii.

Specifying city

When searching for a destination, the search can be narrowed down by specifying the city.



1. Touch [City]. A character input screen is displayed.



2. Enter the name of the city, touch [List]. A list screen is displayed.

INFO:

- The same screen will be displayed when a location is searched from a street.
- Touch [Last 5 Cities] to display the last 5 cities recently set as destinations.



3. Touch the city of the destination from the list.

INFO:

In some cases, when a city name has been entered, the number of matching destinations in the "Matches" column may be different from the number displayed on the list screen. If this occurs, enter more characters to further reduce the number of matches.

FINDING ADDRESS

When the address of the destination is known, use the following method to enter the address and then have the system calculate a route. A location near the preferred destination can also be searched by entering the house number if the map data contains the relevant data.

1. Push the **MENU** button and touch [Destination].
2. Touch [Street Address].



3. Touch [House No.]. A character input screen is displayed.

i **INFO:**

Touch [Region] or [City] to narrow down the specified region and city.

 "Changing region" (page 3-18)



4. Enter the house number, then touch [OK]. If the house number is not available, touch [No House #].
5. Touch [Street]. A street name input screen is displayed.



6. Enter the name of the street. After finishing the entry, touch [List]. A list of streets is displayed.

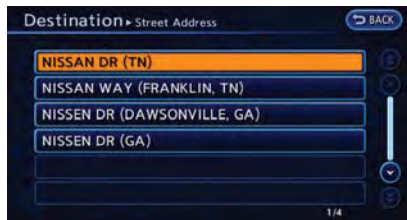

7. Touch the correct street of the destination from the list.

i **INFO:**

In some cases, when a street name has been entered, the number of matching destinations in the "Matches" column may be different from the number displayed on the list screen. If this occurs, enter more characters to further reduce the number of matches.



8. Touch [OK].



- The selected destination is displayed at the center of the map. Touch [Start] after confirming the location of the displayed destination. The system sets the destination to the selected location and starts calculating a route.

INFO:

After setting a destination, the location of the destination can be adjusted and the location can be stored in the Address Book, etc.

 "Operations after setting destination" (page 3-34)

FINDING PLACE

This allows you to find a facility by type, and then have the system calculate a route to that destination. Specify the region and city of the destination to find it more quickly.

NOTE:
Locations and business hours of facilities are subject to change, which may not be reflected in the map data. Double-check this information before you go to an emergency facility to ensure that you can receive the proper support. Otherwise, you may not receive emergency help even when you arrive at the destination.

A confirmation message also appears on the navigation screen. Follow the displayed instructions and check the items required.

Searching by a landmark name

- Push the **MENU** button and touch [Destination].
- Touch [Places].



- Touch [By Name]. A character input screen is displayed.



- Enter the name of the destination facility. After finishing the entry, touch [List]. A list screen is displayed.

INFO:

When [City] is touched, a city can be specified by typing the city name.
 "Specifying city" (page 3-19)

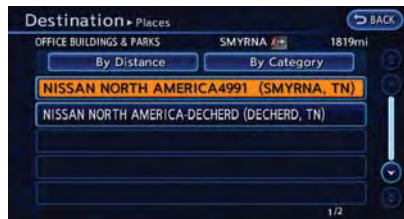

5. Touch the preferred destination facility from the list.

INFO:

- In some cases, when a POI name has been entered, the number of matching destinations in the "Matches" column may be different from the number displayed on the list screen. If this occurs, enter more characters to further reduce the number of matches.
- By selecting [By Distance], you can sort the list by the nearest distance. The position of the selected location is displayed in the preview on the right side of the screen.
- By selecting [By Category], you can display the list that summarizes the entered names into categories. Select the category to narrow down the search.

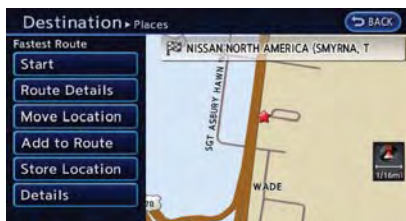

6. The selected destination is displayed at the center of the map. Touch [Start] after confirming the location of the displayed destination. The system sets the destination to the selected location and starts calculating a route.

INFO:

After setting a destination, the location of the destination can be adjusted and the location can be stored in the Address Book, etc.

"Operations after setting destination" (page 3-34)

Searching from the landmark category

1. Push the **MENU** button and touch [Destination].
2. Touch [Places]. The main category list is displayed.



3. Touch the main category. The subcategory list is displayed.



4. Touch the subcategory from the list.



5. Set the narrow down conditions for the landmarks.

An example of choosing [By Name] is explained below.

Narrow down conditions:

- [By Name]:
Input the facility name to narrow down the target facility.

- [Select a City]:

Input the city to narrow down the target city.

- [Near Current Location]:

Shows a list of facilities that are near current vehicle location.

- [Near Destination]:

When the destination is set, indicates the facility list around the destination.

6. Touch [By Name]. A character input screen is displayed.



7. Enter the name of the destination facility. After finishing the entry, touch [List]. A list screen is displayed.

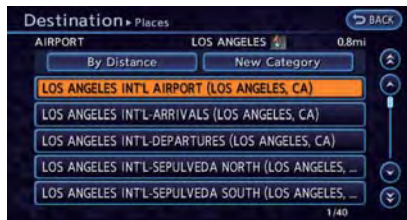

8. Touch the preferred destination facility from the list.

INFO:

- In some cases, when a POI name has been entered, the number of matching destinations in the "Matches" column may be different from the number displayed on the list screen. If this occurs, enter more characters to further reduce the number of matches.
- By selecting [By Distance], you can sort the list by the nearest distance. The position of the selected location is displayed in the preview on the right side of the screen.
- By selecting [New Category], you can perform a search from another category.

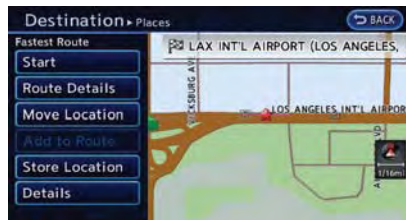

9. The selected destination is displayed at the center of the map. Touch [Start] after confirming the location of the displayed destination. The system sets the destination to the selected location and starts calculating a route.

INFO:

After setting a destination, the location of the destination can be adjusted and the location can be stored in the Address Book, etc.

 "Operations after setting destination" (page 3-34)

SETTING HOME AS DESTINATION

The home location can be set as the destination to which the system calculates a route. This function is especially useful when searching for a route to return to the home location.

1. Push the **MENU** button and touch [Destination].



2. Touch [Home].
3. The home location is displayed, and the system sets the home location as the destination.

INFO:

If the home location is not stored yet, the system will automatically display a screen for storing it.

 "Storing home location" (page 1-12)

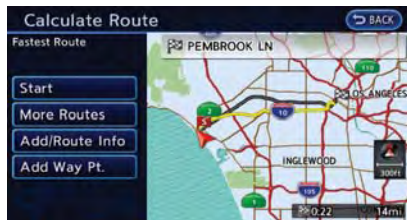

4. The entire route to the home location is shown on the map. Touch [Start] after confirming the displayed route. The system starts route guidance to the home location.

INFO:

Before starting route guidance, the route condition can be changed and the route can be stored in the Address Book, etc.

 "Procedures after setting route"
(page 3-36)

Setting by voice command

1. Push the  button located on the steering wheel.
2. After the tone sounds, speak a command.

To set the home location as the destination:

"Navigation" "Home"

FINDING CHARGING STATION

It is possible to set the destination to a charging station located near the current vehicle location, and then have the system calculate a route.

CAUTION

Detailed charging station information may not be available in all areas and current charging station locations may not be up to date. For up to date information about charging stations, such as business hours or charging equipment, NISSAN recommends that you directly access the information on your own. Additionally, always check the Li-ion battery available charge and set a reasonable driving schedule.

1. Push the **MENU** button and touch [Destination].
2. Touch [Nearby Charging Stations].

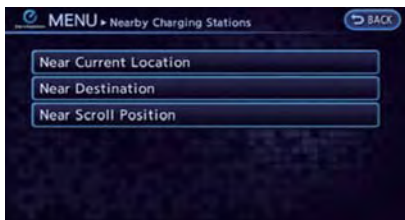

3. Select the method for searching for charging station locations.

- [Near Current Location]:

Displays a list of charging stations that are near the current vehicle location.

- [Near Destination]:

Displays a list of charging stations that are near the destination, when a destination has been set.

- [Near Scroll Position]:

Displays a list of charging stations that are near the cursor when the map has been moved.



4. A list screen is displayed. Touch the preferred charging station from the list.



INFO:

- If the suggested route is already set, when [Show Along Route] is touched, the system displays only the facilities located along the route.
- The charging station information screen is displayed when an icon is touched.

☞ "How to view charging station information" (page 3-25)

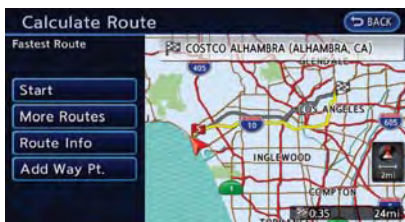

5. The entire route is shown on the map. Touch [Start] to confirm after checking the displayed route. The system starts route guidance to the selected destination.



INFO:

Before starting route guidance, the route condition can be changed and the route can be stored in the Address Book, etc.

☞ "Procedures after setting route" (page 3-36)

NOTE:

Charging stations that have been searched for using this function are not necessarily equipped with devices that can be used to charge a LEAF. Be sure to confirm this in advance before setting a charging station as the destination.

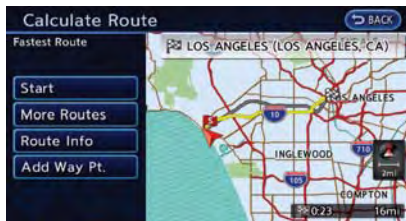

How to view charging station information

Touch any icon displayed on the list screen to show the charging station information screen. Detailed information about a charging station can be checked.



Contents of charging station information

- Facility name
- Type of charging devices

 : Normal charge icon
 : Quick charge icon (for vehicle equipped for quick charging)

- Type and number of charge connectors
- Whether this facility is open 24 hours a day, whether the business hours are fixed

Available settings

- [Show Map]:
Displays a map screen for the selected charging station. The charging station on this screen can be set as the destination.
 "Operations after setting destination" (page 3-34)
- [Call]:
Makes a call to the selected charging station. A cellular phone needs to be

connected beforehand.
 "Connecting cellular phone" (page 1-13)

- [Details]:
Displays the following information about the selected charging station.
 - Address
 - Phone number
 - Whether there is a charge for using charging equipment at this facility or not

NOTE:

Equipment that is displayed on the charging station information screen is not necessarily compatible with a LEAF. Be sure to check whether equipment can be used with a LEAF beforehand.

INFO:

As maintenance of data for charging station information is carried out periodically, detailed information for a charging station selected may not always be displayed.

SEARCHING FROM ADDRESS BOOK

Storing frequently used destinations in the Address Book makes it easy for the system to set and calculate a route. To utilize this function more effectively, destinations that are often traveled to should be stored in advance.

1. Push the **MENU** button and touch [Destination].
2. Touch [Address Book].



3. Touch the preferred location from the list.

INFO:

Selecting [Sort] displays a list of various sort functions. To use the sort functions, stored locations must be set in advance.

 "Storing location" (page 3-35)

- [Sorted By Number]:
The Address Book entries are displayed in ascending numerical order.
- [Sorted By Name]:
The Address Book entries are displayed in alphabetic order.
- [Sorted By Icon]:
By selecting a particular icon, a list that contains only the Address Book entries associated with that icon is displayed.
- [Sorted By Group]:
By selecting a particular group (family, friends, leisure, etc.), the selected group is displayed at the top of the list.



INFO:

After setting a destination, the location of the destination can be adjusted and the location can be stored in the Address Book, etc.

 "Operations after setting destination" (page 3-34)

Setting by voice command

1. Push the  button located on the steering wheel.
2. After the tone sounds, speak a command.

To set the destination from the Address Book:
"Navigation" "Address Book"

SEARCHING FROM HISTORY

It is possible to set destinations using the former route guide starting location, as well as destination lists that were set in the past. Up to 100 previous destinations will be automatically stored. If the number of previous destinations exceeds 100, the oldest one will be replaced by the newest one.

1. Push the **MENU** button and touch [Destination].
2. Touch [Previous Destinations]. A list screen is displayed.

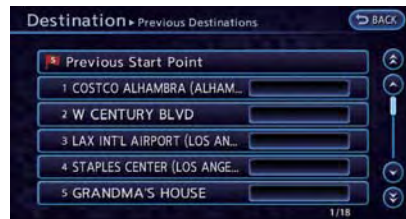

3. Touch the previous start point or the previous destination from the list.

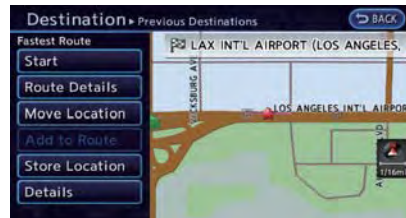

4. The selected destination is displayed at the center of the map. Touch [Start] after confirming the location of the displayed destination. The system sets the destination to the selected location and starts calculating a route.

4. The selected destination is displayed at the center of the map. Touch [Start] after confirming the location of the displayed destination. The system sets the destination to the selected location and starts calculating a route.

INFO:

After setting a destination, the location of the destination can be adjusted and the location can be stored in the Address Book, etc.

 "Operations after setting destination" (page 3-34)

Setting by voice command

1. Push the  button located on the steering wheel.

2. After the tone sounds, speak a command.

To display the previous destinations list:

"Navigation" "Previous Destinations"

FINDING NEARBY PLACE

This allows you to set the destination to a facility located near the current vehicle location or another location that you move to by scrolling the map, and then have the system calculate a route.

If there is any particular Points of Interest type that you intend to use frequently, you can store it in the list of nearby Points of Interest.

 "Customizing Nearby Places" (page 3-71)

1. Push the **MENU** button and touch [Destination].

2. Touch [Nearby Places]. The category list is displayed.

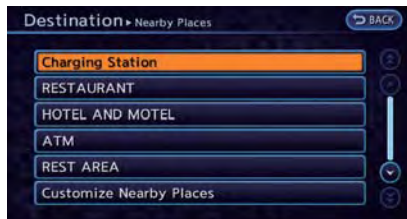

3. Touch the preferred category. A facility list screen is displayed.



4. Touch the preferred destination from the list. The position of the selected location is displayed in the preview on the right side of the screen.

INFO:

- If the suggested route is already set, by touching [Show Along Route], the system displays only the facilities located along the route.
- A maximum of 100 facilities can be displayed on the list screen.

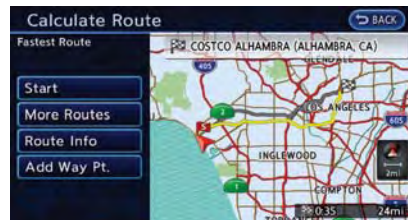

5. The entire route is shown on the map. Touch [Start] after confirming the displayed route. The system starts route guidance to the selected destination.

INFO:

- Before starting route guidance, the route condition can be changed and the route can be stored in the Address Book, etc.
 "Procedures after setting route" (page 3-36)

- If the route is already set, the selected location becomes a waypoint.
- You can also set the destination by touching [Map Menu] in the current location map screen and selecting [Nearby Places].

SETTING FROM STORED ROUTES

It is possible to select a preferred route from the stored routes.

1. Push the **MENU** button and touch [Destination].
2. Touch [Next Page].
3. Touch [Stored Routes]. A list screen is displayed.

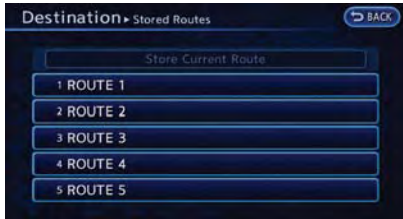

4. Touch the preferred route from the list. The route to the destination is set.



5. The entire route is shown on the map. Touch [Start] after confirming the displayed route. The system starts route guidance to the selected destination.

INFO:

- Before starting route guidance, the route condition can be changed and the route can be stored in the Address Book, etc.
 "Procedures after setting route" (page 3-36)
- The stored route only includes locations (destination and waypoints) and route calculation conditions, not the route itself. Therefore, when the destination is set using a stored route, a different route may be suggested if the current vehicle location is different from the one when the route was stored.

SETTING BY PHONE NUMBER

If the phone number of a facility is known, it is possible to search for a facility by entering the phone number, and have the system calculate a route.

INFO:

- If the area code of the specified telephone number does not exist in the map data, the system cannot search for the location.
- Only the locations included in the database in the map data can be searched by the phone number. Residential phone numbers cannot be used to search for a location.

1. Push the **MENU** button and touch [Destination].
2. Touch [Next Page].
3. Touch [Phone Number]. The telephone number input screen is displayed.



4. Enter the telephone number including the area code. After finishing the entry, touch [List].

 "Phone number input screen"
(page 1-8)

INFO:

A list screen is displayed if there are two or more search results. Touch the preferred destination from the list.

A confirmation screen for the place name and the location is displayed, and the system starts calculating.

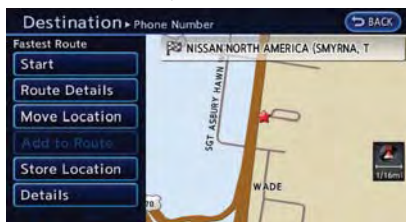

5. The selected destination is displayed at the center of the map. Touch [Start] after confirming the location of the displayed destination. The system sets the destination to the selected location and starts calculating a route.

INFO:

After setting a destination, the location of the destination can be adjusted and the location can be stored in the Address Book, etc.

 "Operations after setting destination"
(page 3-34)

SETTING FREEWAY ENTRANCE/ EXIT

It is possible to set the destination to an entrance or exit of a freeway and have the system calculate a route.

1. Push the **MENU** button and touch [Destination].
2. Touch [Next Page].
3. Touch [Freeway Entrance/Exit]. A character input screen is displayed.



4. Enter the name of the freeway. After finishing the entry, touch [List].



5. Touch the freeway of the destination from the list.



6. Touch [Entrance] or [Exit]. A list screen is displayed.



7. Select the preferred destination from the list. The position of the selected location is displayed in the preview on the right side of the screen.

INFO:

Select [By Distance] to sort the list by the nearest distance.



8. The selected destination is displayed at the center of the map. Touch [Start] after confirming the location of the displayed

destination. The system sets the destination to the selected location and starts calculating a route.

INFO:

After setting a destination, the location of the destination can be adjusted and the location can be stored in the Address Book, etc.

☞ “Operations after setting destination” (page 3-34)

SETTING INTERSECTION

It is possible to set an intersection of any two streets as the destination and have the system calculate a route.

1. Push the **MENU** button and touch [Destination].
2. Touch [Next Page].
3. Touch [Intersection].



4. Touch [1st Street]. A character input screen is displayed.

INFO:

Touch [Region] or [City] to narrow down the specified region and city.



5. Enter the name of the 1st street. After finishing the entry, touch [List]. A list screen is displayed.



6. Touch a street as the 1st street from the list.



7. Touch [2nd Street.]. A character input screen is displayed.



8. Enter the name of the 2nd street. After finishing the entry, touch [List]. A list screen is displayed.



9. Touch a street as the 2nd street from the list.



10. Touch [OK].



11. The select destination is displayed at the center of the map. Touch [Start] after confirming the location of the displayed destination. The system sets the selected location as the destination and starts calculating a route.

INFO:

After setting a destination, the location of the destination can be adjusted and the location can be stored in the Address Book, etc.

 "Operations after setting destination" (page 3-34)

SETTING CITY CENTER

It is possible to set the center of a city as a destination and have the system calculate a route.

1. Push the **MENU** button and touch [Destination].
2. Touch [Next Page].
3. Touch [City Center]. A character input screen is displayed.



4. Enter the name of the city, touch [List]. A list screen is displayed.

i INFO:

Touch [Last 5 Cities] to display the last 5 cities recently set as destinations.

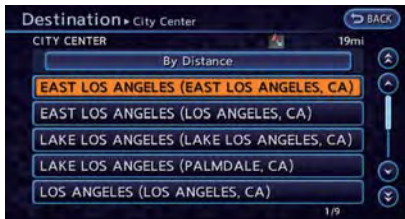

5. Touch the preferred destination from the list.

i INFO:

Select [By Distance] to sort the list by the nearest distance.

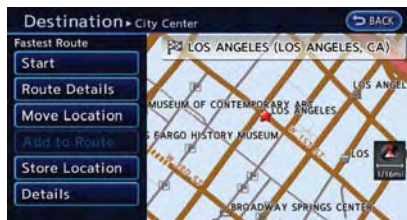

6. The selected destination is displayed at the center of the map. Touch [Start] after confirming the location of the displayed destination. The system sets the destination to the selected location and starts calculating a route.

i INFO:

After setting a destination, the location of the destination can be adjusted, the location can be stored in the Address Book, etc.

📖 "Operations after setting destination" (page 3-34)

SETTING POINT ON MAP

It is possible to set a location scrolled to on the map as the destination and have the system calculate a route.

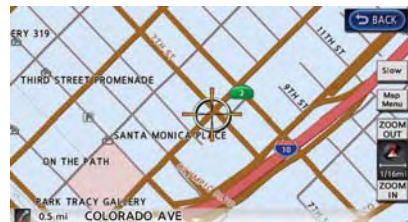

1. Scroll the map, place the cross pointer over the preferred location, and touch [Map Menu].

i INFO:

- The map scale should be adjusted to search for a location more effectively.
- The point on the blinking road where the center of the cross pointer is located can be set as a destination.

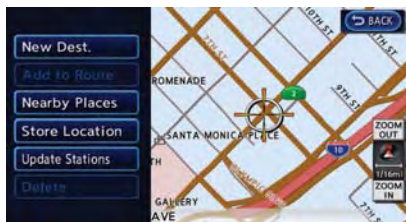

INFO:

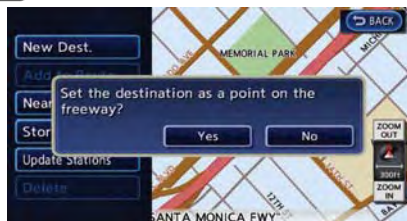

2. Touch [New Dest.].

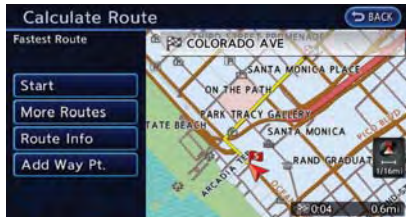

3. The entire route is shown on the map. Touch [Start] after confirming the displayed route. The system starts route guidance to the selected destination.

- If a point on a freeway is set as the destination, a confirmation message is displayed.
- Before starting route guidance, the route condition can be changed and the route can be stored in the Address Book, etc.
 - ☞ "Procedures after setting route" (page 3-36)

OPERATIONS AFTER SETTING DESTINATION

The following operations are available after you set a destination.



Available items after setting destination

- [Start]: Starts route guidance to the selected destination.
 - ☞ "Starting route guidance" (page 3-35)
- [Route Details]: Allows you to change the route search conditions or to check the route information.
 - ☞ "Procedures after setting route" (page 3-36)
- [Move Location]: Displays a map screen. The location of the destination can be adjusted.
 - ☞ "Moving location of destination" (page 3-35)
- [Add to Route]: Edits the route by adding a waypoint or a destination.
 - ☞ "Adding additional destinations to a route" (page 3-35)

- [Store Location]:
Stores the location in the Address Book.
☞ "Storing location" (page 3-35)
- [Details]:
Displays information about the facility that has been set as the destination, if it is included in the map data.
☞ "Viewing information about searched location" (page 3-36)



1. Touch [Move Location]. A map screen with the destination located on the map center is displayed.
2. Adjust the location by moving the cross pointer across the map and touch [OK]. The location of the destination is modified.

INFO:

- The screen for adjusting the location also changes when the map screen displayed on the right side of the screen is touched.
- The map scale can be changed by touching [ZOOM OUT] or [ZOOM IN].

Adding additional destinations to a route

Even after the route is already set, you can add a searched location as a new destination or waypoint to that route.

If the route has not been set, [Add to Route]

cannot be selected.

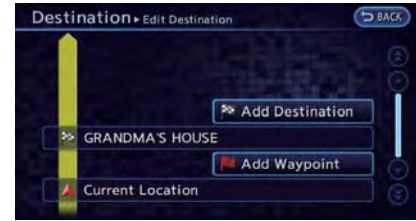

1. Touch [Add to Route].
2. Touch [Add Destination] or [Add Waypoint]. The system starts calculating a route that includes the added destination or waypoint. When the calculation is finished, the route is displayed.

Storing location

A searched location can be stored in the Address Book. Then it can be easily retrieved and set as a destination (or waypoint).

Starting route guidance



1. Touch [Start]. Route guidance starts. If the route is already set, the location becomes the new destination, and the route is recalculated.

Moving location of destination

The location of the destination can be adjusted by moving the cross pointer across the map.



1. Touch [Store Location]. A message is displayed, the location is stored in the Address Book. The corresponding icon is displayed at the set location on the map.

Viewing information about searched location

Information (street address and phone number) about places stored in the map data can be displayed.

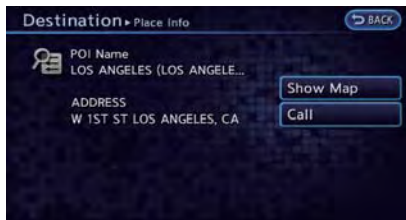

1. Touch [Details]. Information about the location is displayed.
2. Touch the item you would like to set.

Available settings

- [Show Map]:
Returns to the previous screen.
- [Call]:
Makes a call to the selected charging station. A cellular phone needs to be connected beforehand.

 "Connecting cellular phone"
(page 1-13)

- [Details]:
This appears only when a charging station is set as a destination. Displays detailed information including the type and number of charging devices existing at the selected charging station.



INFO:

Information about locations is not displayed while driving.

ROUTE GUIDANCE

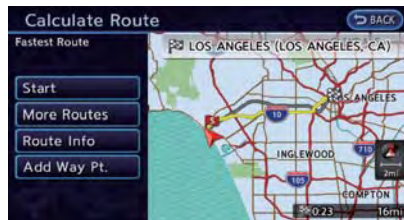

PROCEDURES AFTER SETTING ROUTE

After performing a route search, route guidance can be started. Also, it is possible to confirm or change a route.



1. Touch [Route Details].
2. Touch the item you would like to set.

Available items after setting route

- [Start]:
Starts route guidance to the selected destination.
 "Starting route guidance" (page 3-37)
- [More Routes]:
Displays 3 alternative routes.
 "Changing route condition"
(page 3-37)
- [Route Info]:
Displays the route information. A calculated route can also be stored in the Address

Book.

 "Confirming route" (page 3-37)

- [Add Way Pt.]:

Allows you to edit the route by adding a destination or waypoint.

 "Adding destination or waypoint"
(page 3-38)

Starting route guidance

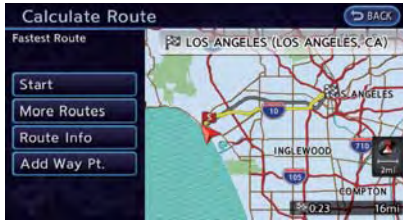

1. Touch [Start]. Route guidance starts.



INFO:

If no operations have been performed on the system for several seconds, [Start] is automatically selected, and the system starts route guidance. When the vehicle is being driven, [Start] is automatically selected and the system will start the route guidance function.

Changing route condition

1. Touch [More Routes].

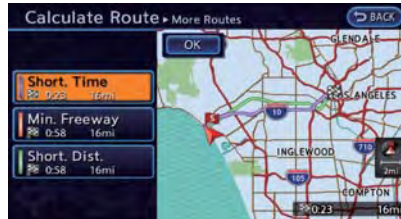

2. Touch the preferred route condition. When the route is selected, a preview is displayed on the right side of the screen. After selecting the route condition, touch [OK].

Available route conditions

- [Short. Time] (purple):
Prioritizes the shortest time.
- [Min. Freeway] (orange):
Minimizes the use of freeways.
- [Short. Dist.] (green):
Prioritizes the shortest distance.



INFO:

- The 3 routes may not always be different.
- When using waypoints, [More Routes] is disabled. After route guidance is started, change the route between each waypoint.
 "Editing route" (page 3-45)

Confirming route

1. Touch [Route Info].

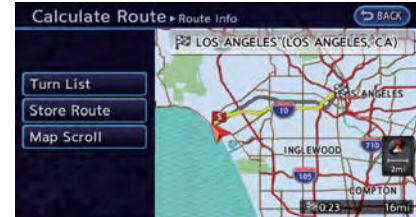

2. Touch the preferred information item.

Available information

- [Turn List]:
Displays the details of the suggested route.
 "Using turn list" (page 3-49)
- [Store Route]:
Stores a calculated route. A maximum of 5 routes can be stored. Stored routes can be easily retrieved and set as the suggested route. If no waypoints are set on the route,

the route cannot be stored.

☞ “Storing route” (page 3-57)

- [Map Scroll]:

Displays a map screen where the location of the destination can be confirmed.

INFO:

The stored route includes only locations (destination and waypoints) and route calculation conditions, not the route itself. Therefore, when the destination is set using a stored route, a different route may be suggested if the current vehicle location is different from the one when the route was stored.

Adding destination or waypoint

Before starting route guidance, destinations and/or waypoints can be added. A total of 6 destinations or waypoints can be set.

1. Touch [Add Way Pt.].

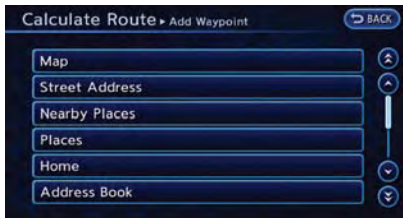

2. Set additional destinations or waypoints.

The method of searching for a location is the same as the one for a destination.

☞ “Setting destination” (page 3-17)



3. Touch [Add to Route].

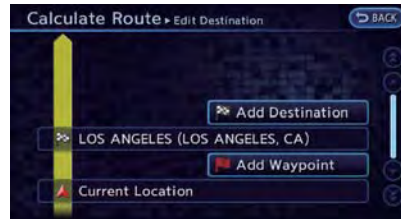

4. Touch [Add Destination] or [Add Waypoint].



5. The system starts calculating a route that includes the added destination or waypoint. When the calculation is finished, the route is displayed.

INFO:

- If a waypoint was added, [More Routes] cannot be selected.
- If a destination was added, the prior destination becomes a waypoint.

ABOUT ROUTE GUIDANCE

After setting the route, select [Start] to begin route guidance.

Throughout route guidance, the system navigates you through the guide points using visual and voice guidance.

⚠ CAUTION

- The navigation system's visual and voice guidance is for reference purposes only. The contents of the guidance may be inappropriate depending on the situation.
- Follow all traffic regulations when driving along the suggested route (e.g., one-way traffic).
👉 "Route guidance" (page 10-32)

Voice guidance during route guidance

When approaching a guide point (intersection or corner), destination, etc. during route guidance, voice guidance announces the remaining distance and/or turning direction. Push and hold the **VOICE** button to repeat voice guidance.

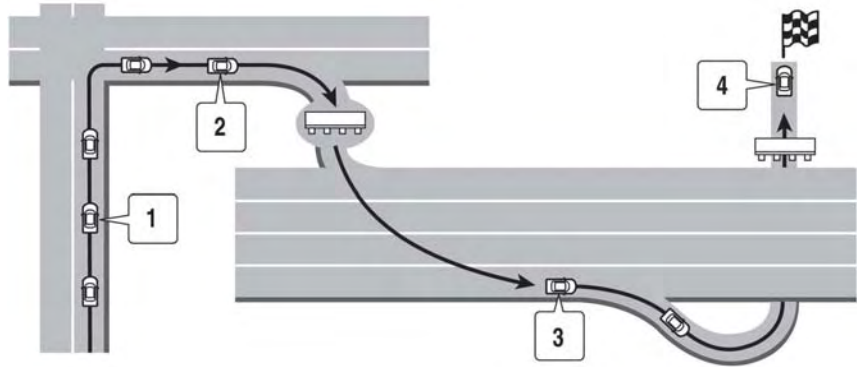

Example of voice guidance:

- ① "In about one quarter mile (400 meters), right (left) turn."
"Right (left) turn ahead."
- ② "In about one quarter mile (400 meters) freeway entrance on your right onto (road number and direction)."
"Freeway entrance on your right onto (road number and direction)."
- ③ "In about one mile (2 kilometers), exit on your right."
"Exit on your right."
- ④ "You have arrived at your destination. Ending route the guidance."

Guidance screens and preview mode

Route guidance displays map screens and various information according to the situation.

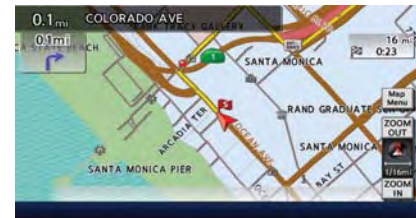

Enlarged intersection view:

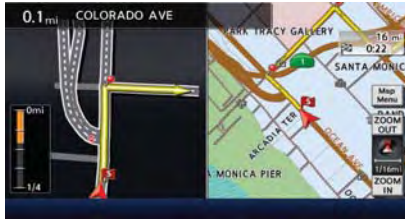

When approaching a guide point, the system automatically changes to the split screen and shows an enlarged view of the intersection on the left screen. To switch to the full screen mode while the enlarged intersection view is displayed, push the **MAP** button. Pushing the **MAP** button again displays the enlarged intersection view.

Junction guidance:



While driving on a freeway, when the vehicle is approximately 1 mile (approximately 2 km) from a junction, the system automatically switches to the split screen and displays an enlarged view of the junction on the left screen. After passing the junction, the system automatically returns to the full screen mode. To switch to the full screen mode while the enlarged junction view is displayed, push the **MAP** button. Pushing the **MAP** button again displays the enlarged junction view.

Turn list:



Depending on the setting, the system can constantly display the split screen and show the turn list on the left screen. When approaching a guide point, the left screen automatically switches to an enlarged view of the intersection. To switch to the full screen mode, push the **MAP** button. Pushing the **MAP** button again displays the turn list.

GUIDANCE SCREEN SETTINGS

The guidance screen can be displayed at all times even when the vehicle is located away from the guide point. Various types of screens can be set.

Split screen settings

The display setting on the left-hand side screen shown during route guidance can be changed.

1. Touch [Map Menu] while the current location map screen is displayed.

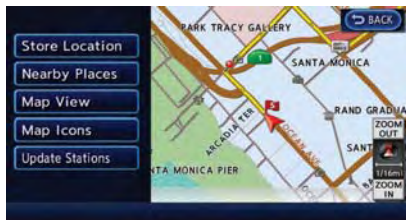

2. Touch [Map View].



3. Touch [View Settings].
4. Touch the preferred screen. The indicator of the selected screen illuminates.

- **Intersection**



The map screen and the enlarged intersection view can be displayed at the same time.

Push the **MAP** button to switch to the full map screen.

- **Turn list**

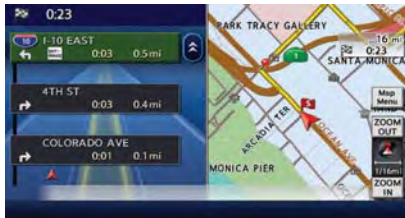

The list screen for showing the guide points to the destination and the map screen can be displayed at the same time. An enlarged intersection view is automatically displayed when the vehicle approaches the guide point.

The turn list can be scrolled by touching [⌂] or

[⌂] on the screen.

Push the **MAP** button to switch to the full map screen. Push the **MAP** button again to display the turn list.

- **Full map**

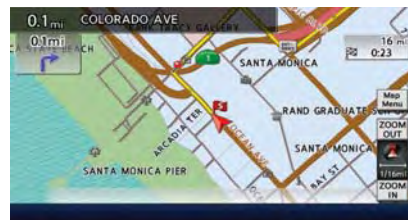

The current location map is displayed. An enlarged intersection view is automatically displayed when the vehicle approaches the guide point.

When an enlarged intersection view is displayed, pushing the **MAP** button returns to the map screen.

Show exit information on freeways

When the vehicle travels on a highway or a toll road, the display automatically provides exit information in the turn list.

1. Touch [Map Menu] while the current location map screen is displayed.

2. Touch [Map View].



3. Touch [Map Settings].



4. Touch [Show all Freeway Exits on Route]. The indicator illuminates when the item is set.
5. Push the **MAP** button to return to the current location map screen.

Showing freeway exit information:



When [Show all Freeway Exits on Route] is set to ON and the route includes the freeway or toll road, all exits along the route which have exit information will be shown in the turn list. The exit information is shown as icons.

Selecting a waypoint from the exit information list:

When exit information is displayed on the turn list, a waypoint to a facility located near the freeway exit can be set as a waypoint. The facility categories that are not shown with an icon cannot be selected.



1. Touch the exit where the exit information icon is displayed. The category list screen is displayed.



2. Touch the landmark category. The list screen for showing facilities located near the freeway exit is displayed.



INFO:

The facility categories that are not shown with an icon cannot be selected.



3. Touch the preferred facility for the waypoint.

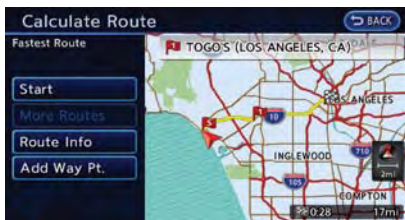

4. The waypoint is set, and the route search is performed.

"Procedures after setting route" (page 3-36)

ROUTE SCREEN



WARNING

Always stop the vehicle in a safe location before modifying the route conditions. Modifying the route conditions while driving may cause an accident.

During route guidance, the route conditions can be modified and the route information can be confirmed. Set route conditions according to personal preference.

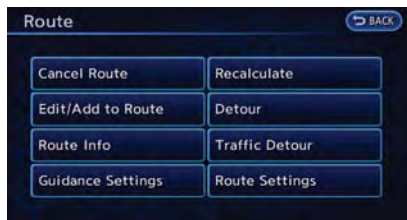

1. Push the **MENU** button and touch [Route].
2. Touch the item you would like to set.

Available settings

- [Cancel Route]/[Resume Route]: Cancels the current route guidance. A canceled route can also be reactivated. If the suggested route is canceled, [Cancel Route] changes to [Resume Route].
 "Canceling/reactivating route" (page 3-44)
- [Edit/Add to Route]: Edit or add a destination or waypoints to the route that is already set.
 "Editing route" (page 3-45)
- [Route Info]: Confirm the route by the route information or simulation. The confirmed route can also be stored.
 "Confirming route" (page 3-49)
- [Guidance Settings]: Activates or deactivates route, voice guidance and/or traffic announcement and adjust the volume level of voice guidance.
 "Voice guidance settings" (page 3-50)
- [Recalculate]: Manually search for the route again after changing the search condition and have the system calculate a route.
 "Recalculating route" (page 3-50)

- [Detour]:
A detour of a specified distance can be calculated.
☞ "Setting detour route" (page 3-51)
- [Traffic Detour]:
Manually search for an alternative detour route taking the traffic information into consideration.
☞ "Searching for detour route using traffic information" (page 3-51)
- [Route Settings]:
Changes the route calculation conditions anywhere along the route.
☞ "Setting conditions for route calculation" (page 3-52)

CANCELING/REACTIVATING ROUTE

A route that is already set can be canceled at any time. If a route is deleted, the destination and waypoints are also canceled.

It is also possible to reactivate a canceled route.

Canceling route

1. Push the **MENU** button and touch [Route].



2. Touch [Cancel Route]. A confirmation message is displayed.

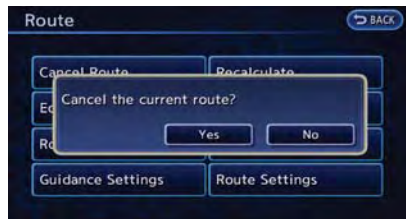

3. Touch [Yes]. The route is canceled along with the destination and waypoints.

Reactivating route

1. Push the **MENU** button and touch [Route].

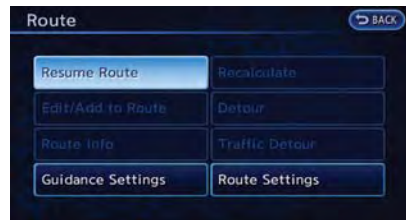

2. Touch [Resume Route]. A confirmation message is displayed.

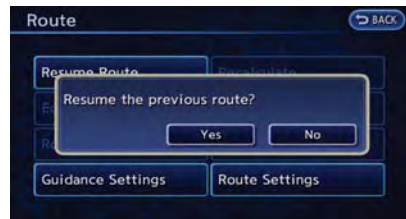

3. Touch [Yes]. The canceled route is reactivated.

INFO:

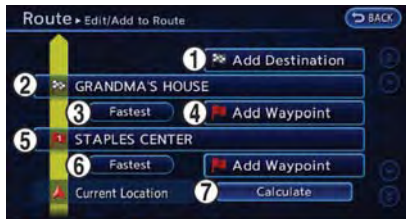

If a new route is set, the canceled route cannot be reactivated.

EDITING ROUTE







1. Push the **MENU** button and touch [Route].
2. Touch [Edit/Add to Route].
3. Touch the preferred condition.
4. After finishing the setting, touch [Calculate]. The system will recalculate the routes. After the route search is completed, the display will automatically return to the current location map screen.

Available settings

- ① Adds a destination.
 "Setting destination or waypoint"
(page 3-45)
- ② Current destination:
Changes or deletes the destination.
 "Editing/deleting destination or waypoint"

(page 3-46)

- ③ Condition for calculating a route to the destination:
Changes the conditions for calculating a route to the destination.
 "Changing route calculation conditions"
(page 3-48)
- ④ Adds a waypoint.
 "Setting destination or waypoint"
(page 3-45)
- ⑤ Current waypoint:
Changes or deletes the waypoint.
 "Editing/deleting destination or waypoint"
(page 3-46)
- ⑥ Condition for calculating a route to a waypoint:
Changes the conditions for calculating a route to a waypoint.
 "Changing route calculation conditions"
(page 3-48)
- ⑦ [Calculate]:
Manually search for the route again after changing the search conditions and have the system calculate a route.
 "Changing route calculation conditions"
(page 3-48)

INFO:

Added waypoints and search conditions will not be taken into consideration for the route calculation until [Calculate] is touched.

Setting destination or waypoint

A destination or waypoint can be added to the route that has already been set. A total of 6 destinations or waypoints can be set.

1. Push the **MENU** button and touch [Route].
2. Touch [Edit/Add to Route].



3. Touch [Add Destination] or [Add Waypoint].
If [Add Destination] is selected, the current destination changes to a waypoint.



4. Set a destination or waypoint. The method of searching for a destination or waypoint is the same as the one for a destination.

☞ “Setting destination” (page 3-17)

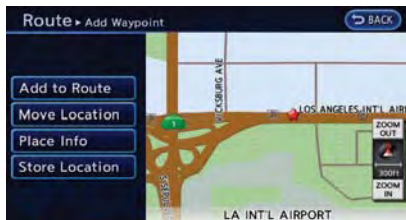

5. The selected location is displayed at the center of the map. Touch [Add to Route] after confirming the location.

INFO:

Even after setting a destination/waypoint, the destination/waypoint location can be adjusted, the route can be stored, etc.

☞ “Editing/deleting destination or waypoint” (page 3-46)



6. Return to the Edit Route screen. Set the route conditions as necessary.
7. Touch [Calculate]. The system will recalculate the routes. After the route search is completed, the display will automatically return to the current location map screen.

INFO:

- The prior route is automatically deleted.
- Added waypoints and search conditions will not be taken into consideration for the route calculation until [Calculate] is touched.

Editing/deleting destination or waypoint

The destination or waypoint that has already been set can be modified or deleted. If a location is modified or deleted when a suggested route is already set, the prior suggested route will be recalculated accordingly.

1. Push the **MENU** button and touch [Route].
2. Touch [Edit/Add to Route].



3. Touch a destination or waypoint that is already set.

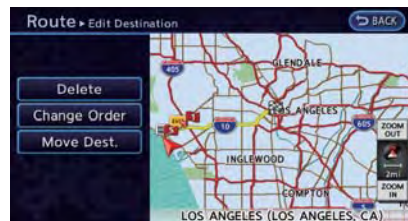
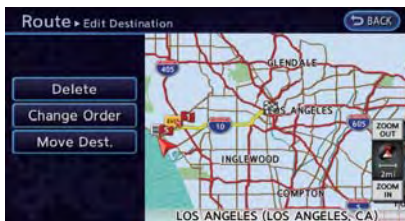

4. Touch the item you would like to set.

Available settings

- [Move Dest.]:

The location of the destination or waypoint can be adjusted by moving the cross pointer across the map.

- [Change Order]:

The order of a destination and waypoints that have already been set can be changed.

- [Delete]:

The destination or waypoint that has already been set can be deleted.

5. By touching [Calculate], the system will recalculate the routes. After the route search is completed, the display will automatically return to the current location map screen.



INFO:

If the destination is deleted, the final waypoint of the route becomes the destination.

Changing order of destination and waypoints:

1. Touch a destination or waypoint that is already set.

2. Touch [Change Order]. A list of the destination and waypoint.



3. Touch a preferred destination or waypoint to replace the previously selected destination or waypoint. A message is displayed and the order of the destination or waypoint is changed.

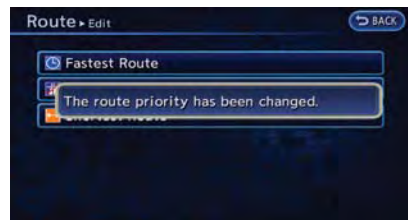
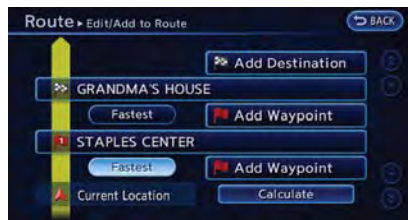
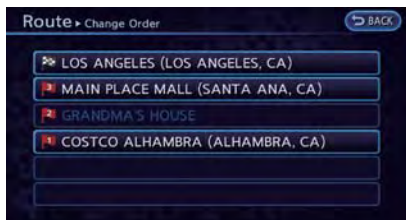

- By touching [Calculate], the system will recalculate the routes. After the route search is completed, the display will automatically return to the current location map screen.

- Touch the preferred section of the route to the destination or waypoint.

- The conditions have been changed and the display returns to the Edit Route screen.

Changing route calculation conditions

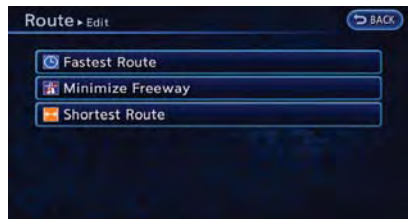

Each section of the route between waypoints can have different route calculation conditions. After setting these conditions, the entire route can be recalculated.

- Push the **MENU** button and touch [Route].
- Touch [Edit/Add to Route].



- Touch the preferred condition.

Available conditions

-  : [Fastest Route]
-  : [Minimize Freeway]
-  : [Shortest Route]



- By touching [Calculate], the system will recalculate the routes. After the route search is completed, the display will automatically return to the current location map screen.

INFO:

- The recalculated route may not be the shortest route because the system prioritizes roads that are easy to drive on for safety reasons.
- If the route conditions are set from [Route Settings], all sections in the route are subject to the same route conditions. This applies even if different route conditions have been set for different sections in [Edit/Add to Route].

CONFIRMING ROUTE

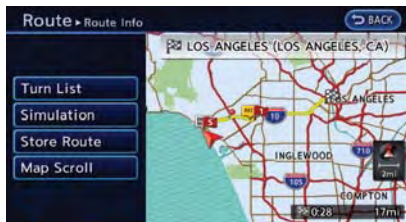

When the suggested route is displayed after calculation, the route information can be confirmed or the suggested route can be simulated.



1. Push the **MENU** button and touch [Route].
2. Touch [Route Info].

3. Touch the preferred item.

Available settings

- [Turn List]:
Displays details of the suggested route.
 "Using turn list" (page 3-49)
- [Simulation]:
Displays a simulation of the suggested route. This function provides a detailed image of the route with voice guidance.
 "Confirming route by simulation" (page 3-49)
- [Store Route]:
Stores a calculated route. A maximum of 5 routes can be stored. Stored routes can be easily retrieved and set as the suggested route.
 "Storing route" (page 3-57)
- [Map Scroll]:
Displays a map screen where the location of the destination can be confirmed.

Using turn list





1. Touch [Turn List].
2. The information (e.g., intersections) can be confirmed on the route to the destination by scrolling the screen touching [⊙] or [⊖].
3. Push the **MAP** button to return to the current location map screen.

Confirming route by simulation



1. Touch [Simulation]. Route simulation starts.

2. Touch the preferred key.

-  : Pauses the simulation.
-  : Resumes the simulation.
-  : Ends the simulation.

3. Push the **MAP** button to return to the current location map screen.

INFO:

During simulation, the map scale can be changed by touching [ZOOM IN] or [ZOOM OUT]. While the map scale is being changed, the simulation is temporarily stopped.

VOICE GUIDANCE SETTINGS

Various guidance settings can be set.

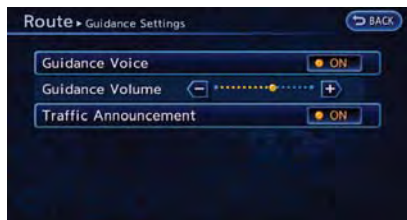

1. Push the **MENU** button and Touch [Route].
2. Touch [Guidance Settings].

3. Touch the item you would like to set.

Available settings

- [Guidance Voice]:
Activates or deactivates voice guidance. The indicator illuminates if voice guidance is activated.
- [Guidance Volume]:
Adjust the volume level of voice guidance by touching [+] or [-].
- [Traffic Announcement]:
Provides an announcement of a traffic information event on the route. The indicator illuminates if traffic announcement is activated.

INFO:

The guidance volume can also be adjusted by turning the audio system volume control button or pushing <+>/<-> on the steering wheel while voice guidance is being announced.

RECALCULATING ROUTE

A route can be manually searched again after changing the search condition.

1. Push the **MENU** button and touch [Route].

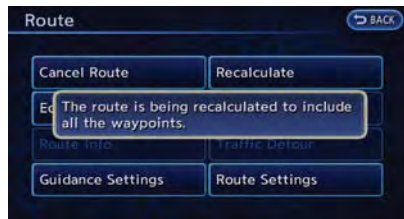

2. Touch [Recalculate]. A message is displayed, and the route is recalculated.

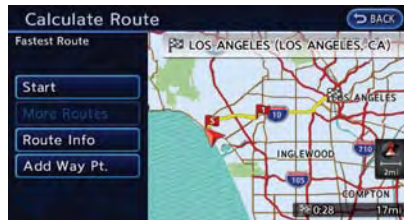

3. Set the route conditions. After finishing the setting, touch [Start].

 "Procedures after setting route"
(page 3-36)

INFO:

- When a waypoint has been set on the route, the system will search for only one route, even if route recalculation is performed.
- When the vehicle deviates from the suggested route, the route from the current location to the destination is automatically searched again.

 "Detailed route settings" (page 3-52)

SETTING DETOUR ROUTE

To detour from the suggested route, a route detouring for a specified distance can be calculated.

1. Push the **MENU** button and touch [Route].
2. Touch [Detour].



3. Touch a detour distance. After calculating the detour, the system displays the detour route on the map.

INFO:

- When the vehicle has deviated from the suggested route, [Detour] cannot be selected.
- If the system cannot calculate a detour with the specified conditions, it displays the previous suggested route.
- If the vehicle is traveling very fast, the detour route may start from a location that the vehicle has already passed.

SEARCHING FOR DETOUR ROUTE USING TRAFFIC INFORMATION

When a serious traffic event occurs on the route, or if the system finds a faster route, a detour alert will pop up automatically. If the automatic alert is not noticed, a detour can also be manually searched.

1. Push the **MENU** button and touch [Route].
2. Touch [Traffic Detour].



3. When the detour search is successful, detailed information about the detour route (left screen) and the comparison screen of the two routes (right screen) are displayed.
 - ① Detour route (pink)
 - ② Original route (yellow)
 - ③ The change of distance and estimated travel time to destination when the detour route is taken.
4. To accept the suggested detour route, touch [Yes].

INFO:

- If no route is set, or [Use Real Time Traffic Information] is turned off, this function cannot be operated.
- If a detour route is not selected and no further action is performed, the detour route will be automatically canceled.
- The detour suggestion can be retrieved even after the message disappears by manually selecting [Traffic Detour]. The system will then search for the detour again and will suggest a detour if one is available at that time.
- Without a subscription to an XM NavTraffic® broadcast, it will not be possible to get a traffic detour or apply settings for functions related to traffic information. A message

appears when a related menu item is selected.

 "Notes on XM NavTraffic® information" (page 10-36)

Automatic detour guidance

When [Auto Reroute] and [Use Real Time Traffic Information] are turned on in the detailed route settings, a message will automatically pop up when the system finds a detour.

 "Detailed route settings" (page 3-52)

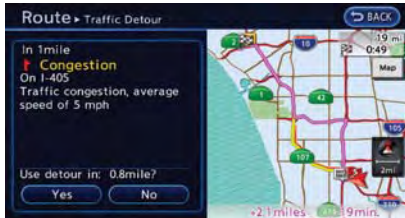

1. If a traffic jam or a serious traffic problem occurs on the route while driving along the suggested route, the automatic detour route search starts and a message pops up if a detour is found.
2. To accept the suggested detour route, touch [Yes].

INFO:

- If no operation is performed for one minute after the message is displayed, the message disappears. The detour will not be accepted, and the current suggested route will remain unchanged.
- When [Traffic Announcement] is turned on in the guidance settings, the system will announce voice guidance at the same time that the message appears on the screen.
 "Voice guidance settings" (page 3-50)

SETTING CONDITIONS FOR ROUTE CALCULATION

Search condition settings

The route can be recalculated after changing the route calculation conditions anywhere along the route.



1. Push the **MENU** button and touch [Route].
2. Touch [Route Settings].
3. Touch [Basic Route Type].
4. Touch the preferred condition. The indicator for the selected condition illuminates.
5. When the conditions are set, the system starts calculating the route with the new conditions, and the current location map screen is displayed.

Available conditions

- [Fastest Route]:
Prioritizes the fastest time.
- [Minimize Freeway]:
Minimizes the use of freeways.
- [Shortest Route]:
Prioritizes the shortest route.

INFO:

Only one of these conditions can be utilized at a time.

Detailed route settings

Detailed conditions can be set for the route calculation.

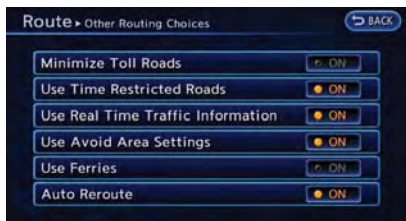

1. Push the **MENU** button and touch [Route].
2. Touch [Route Settings].
3. Touch [Other Routing Choices].
4. Touch the preferred condition. The indicator for the selected condition illuminates.
5. If [Route Settings] is exited after changing the settings, the system starts calculating the route with the new conditions.

Available settings

- [Minimize Toll Roads]:
Minimizes the use of toll roads.
- [Use Time Restricted Roads]:
Uses any roads subject to time restrictions.
- [Use Real Time Traffic Information]:
Uses the latest traffic information received via the XM broadcast.
- [Use Avoid Area Settings]:
Enables the avoid area setting.

- [Use Ferries]:
Includes the use of ferries.
- [Auto Reroute]:
If the vehicle deviates from the suggested route, the system automatically recalculates a route that leads the vehicle to the suggested route.



INFO:

- The recalculated route may not be the shortest route because the system prioritizes roads that are easy to drive on for safety reasons.
- If route conditions are set from [Route Settings], all sections in the route are subject to the same route conditions even though different route conditions have been set for different sections in [Edit/Add to Route].
- If [Use Time Restricted Roads] is deactivated, the system calculates a route without any consideration of the regulations concerning the time or day of the week. Therefore, the suggested route may include a road subject to traffic regulations concerning the time or day of the week. When driving along the route, always follow all traffic regulations regardless of whether [Use Time Restricted Roads] is set to on or off.
- If the system cannot calculate any alternative routes, it displays the previous route.
- If the vehicle greatly deviates from the suggested route, the system calculates a new route.
- Statistical traffic information is based on previous traffic data. When the traffic situation rapidly changes due to unexpected accidents, construction work, traffic restrictions, emergencies, etc., the prediction accuracy of the system may be reduced.
- Traffic jam information displayed on the map screen is not statistical traffic information.
- Even when [Use Real Time Traffic Information] is turned on, if traffic information has not been provided for the area, sometimes it is possible that a detour will not be indicated in a location where a traffic jam occurs.
- The system may not lead to a detour if traffic closure or a traffic jam occurs far from the present location.
- The system calculates to reduce the time required for the entire route from the start to the destination. If there are no appropriate routes, the system may lead to a route where a traffic jam occurs instead of leading to a detour.

ROUTE GUIDANCE SETTINGS

Various guidance information can be set to be played during route guidance and the route and/or voice guidance can be activated or deactivated.

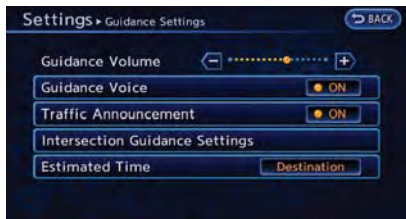

1. Push the **MENU** button and touch [Settings].
2. Touch [Navigation].
3. Touch [Guidance Settings].
4. Touch the item you would like to set.

Available settings

- [Guidance Volume]:
Adjusts the volume level of voice guidance by touching [+] or [-].
- [Guidance Voice]:
Activates or deactivates voice guidance. The indicator illuminates if voice guidance is activated. The indicator illuminates if voice guidance is activated.

- [Traffic Announcement]:
Provides an announcement of a traffic information event on the route. The indicator illuminates if traffic announcement is activated.
- [Intersection Guidance Settings]:
Sets advanced settings for the voice guidance announced at guide points.
☞ "Route guidance settings" (page 3-54)
- [Estimated Time]:
Switches the display of the estimated travel time to the destination or waypoint that is displayed on the map screen.
☞ "Switching estimated arrival time display" (page 3-55)

INFO:

The guidance volume can also be adjusted by turning the audio system volume control button or pushing <+>/<-> on the steering wheel while voice guidance is being announced.

Setting voice guidance at intersections



1. Push the **MENU** button and touch [Settings].
2. Touch [Navigation].
3. Touch [Guidance Settings].
4. Touch [Intersection Guidance Settings].
5. Touch the preferred item. The indicator for the selected item illuminates.

Available settings

- [Full]:
The system announces voice guidance twice: "1 Guide" and "2 Guide".
- [Concise]:
The system announces voice guidance once: "1 Guide".

- [Turning Point]:
Turns on the sound that chimes when a maneuver should be performed.

Switching estimated arrival time display

The display of the travel time on the map screen can be switched between the travel time to the destination and the travel time to the waypoint.

Example: Switching the display to the travel time to the waypoint

1. Push the **MENU** button and touch [Settings].
2. Touch [Navigation].
3. Touch [Guidance Settings].
4. Touch [Estimated Time].



5. Touch [Waypoint]. The indicator for the selected condition illuminates.

6. Push the **MAP** button to return to the current location map screen.



7. The icon displayed on the map screen is switched and the travel time to the waypoint is displayed.

Displayed icon



- : Display of the travel time to the destination
- : Display of the travel time to the waypoint

STORING A LOCATION/ROUTE

STORING LOCATION

Often visited locations can be stored in the Address Book. The stored addresses can be easily retrieved to set them as a destination or waypoint. The Address Book can store up to 200 locations.

INFO:

If charging station information you have used is not stored in the system, the location will be automatically registered in the Address Book.

 “Unique EV function settings” (page 2-13)

Storing location by searching

After a location is searched for once, it can be stored for future use.

1. Push the **MENU** button and touch [Settings].
2. Touch [Navigation].

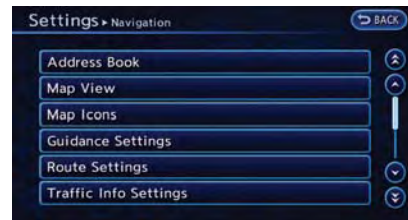

- Touch [Address Book].

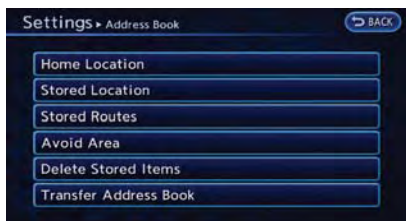

- Touch [Stored Location].



- Touch [Add New].

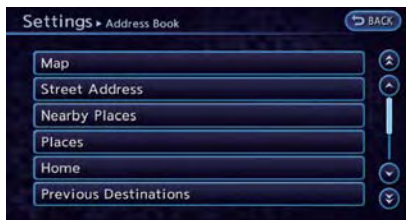

- Touch the appropriate method to search for a location.

"Setting destination" (page 3-17)

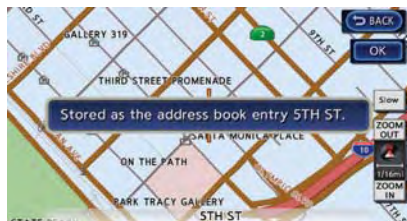

- When a preferred location is displayed at the center of the map, confirm the address of the location and touch [OK]. A message is displayed, and the address of the location is stored in the Address Book.

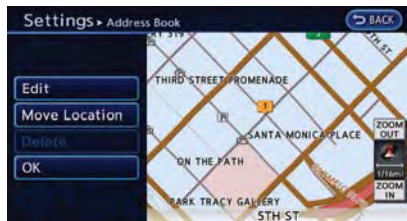

- Adjust the location of the stored item and edit the contents of the stored item as necessary. After finishing the setting, touch [OK].

INFO:

When the location is stored in the Address Book, [Address Book] can be used to search for the location.

Other settings:

An address can also be stored using the following procedure.

- Push the **MENU** button and touch [Destination].
- Touch [Address Book].
- Touch [Add New].
- Touch the appropriate method to search for a location. The address of the searched location is stored.

"Setting destination" (page 3-17)

Storing current vehicle location

- Push the **MAP** button to display the current location map screen.
- Touch [Map Menu] at the current vehicle location.

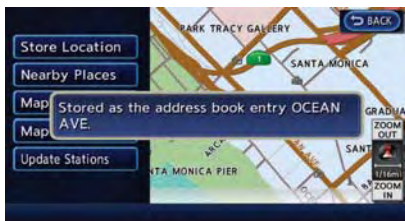

3. Touch [Store Location]. A message is displayed, and the current vehicle location is stored in the Address Book.

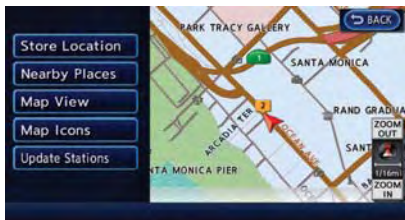

4. The icon representing the stored location is displayed on the map. Push the **MAP** button to return to the current location map screen.

INFO:

The location is stored in the first available position number in the Address Book list.

Storing location by moving map

1. Move to the preferred location on the map and touch [Map Menu].

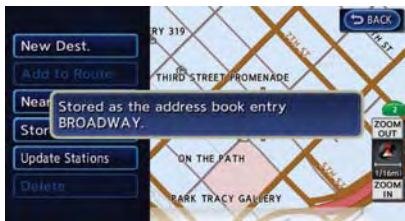

2. Touch [Store Location]. A message is displayed, and the address of the location is stored in the Address Book.

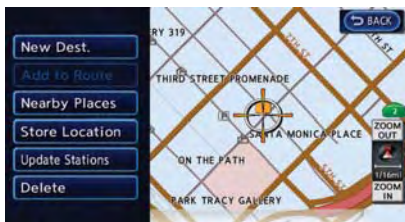

3. The icon representing the stored location is displayed on the map. Push the **MAP** button to return to the current location map screen.

INFO:

The address is stored in the first available position number in the Address Book list.

STORING ROUTE

A maximum of 5 calculated routes can be stored. Stored routes can be easily retrieved and set as the suggested route.

INFO:

Stored route includes only locations (destination and waypoints) and route calculation conditions, not the route itself.

1. Push the **MENU** button and touch [Route].



2. Touch [Route Info].

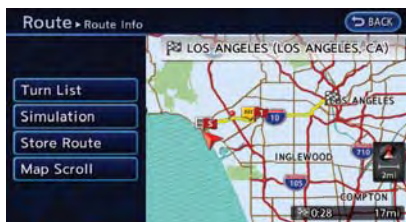

3. Touch [Store Route]. A confirmation message is displayed.

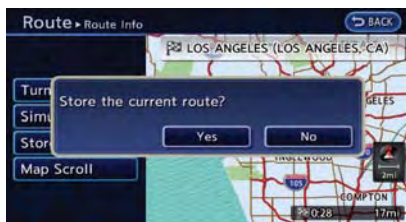

4. Confirm the contents of the message then touch [Yes]. The current route is stored.

Other settings

A route can also be stored using the following procedure.

1. Push the **MENU** button and touch [Settings].

2. Touch [Navigation].
3. Touch [Address Book].
4. Touch [Stored Routes].
5. Touch [Store Current Route]. A confirmation message is displayed.
6. Confirm the contents of the message then touch [Yes]. The current route is stored.

INFO:

- The route is stored in the first available position number in the store current route list.
- A maximum of 5 routes can be stored. When 5 routes are stored in the Address Book, a new route cannot be stored until a route is deleted.
☞ "Deleting stored item" (page 3-65)
- If any waypoints are not set on the route, the route cannot be stored.

STORING AVOID AREA

An Avoid Area can be stored. The Avoid Area is an area that can be excluded from a route, such as a road that is always congested. Once Avoid Areas are stored, the system avoids those areas when calculating a route. Up to 10 Avoid Areas can be stored.

1. Push the **MENU** and touch [Settings].
2. Touch [Navigation].

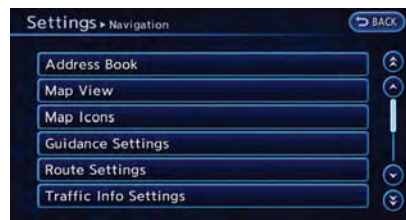

3. Touch [Address Book].

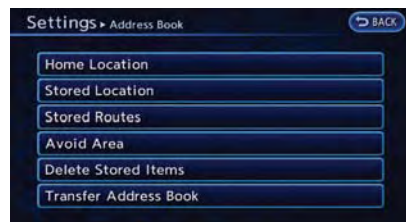

4. Touch [Avoid Area].

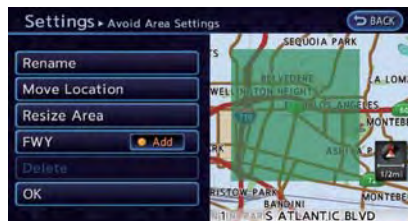

5. Touch [Add New].

INFO:

A maximum of 10 Avoid Areas can be stored. When 10 Avoid Areas are already stored, a new Avoid Area cannot be stored until a currently stored Avoid Area is deleted.

"Deleting stored item" (page 3-65)



6. Touch the appropriate method to search for a location.

"Setting destination" (page 3-17)

7. Adjust the location of the stored item and edit the contents of the stored item as necessary.

"Editing avoid area" (page 3-63)

8. After finishing the setting, touch [OK].

EDITING ADDRESS BOOK

Items stored in the Address Book can be modified. These settings can be edited to make the navigation system more useful.

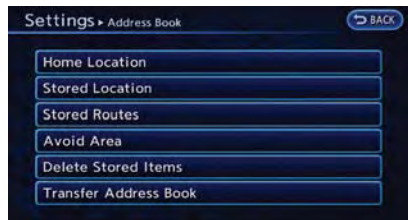

1. Push the **MENU** button and touch [Settings].
2. Touch [Navigation].
3. Touch [Address Book].
4. Touch the item you would like to edit.

Available settings

- [Home Location]:
Edits the information of a stored home.
 "Editing stored home and address" (page 3-60)
- [Stored Location]:
Edits the information of a stored location.
 "Editing stored home and address" (page 3-60)
- [Stored Routes]:
Edits the information of a stored route.
 "Editing stored route" (page 3-63)
- [Avoid Area]:
Edits the information of a stored Avoid Area.
 "Editing avoid area" (page 3-63)
- [Delete Stored Items]:
Deletes a stored location or route.
 "Deleting all stored items" (page 3-66)
- [Transfer Address Book]:
Imports or exports the data of the stored items using an SD card.
 "Transferring information to/from ad-

dress book" (page 3-67)

Editing stored home and address

1. Touch [Home Location] or [Stored Location].



2. Touch the preferred stored address from the list.



INFO:

- When [Home Location] is touched, it is not necessary to be perform "step 2".
- Touching [Sort] displays a list of various sort functions. To use the sort functions, stored addresses must be set in advance.
 - ➔ "Minor adjustment of home or stored address" (page 3-60)

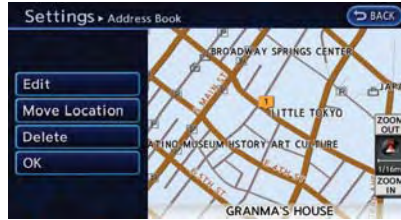

3. Touch the item you would like to set.

Available settings

- [Edit]:
Edits the stored address information.
- [Move Location]:
Adjusts the location of the stored address.
- [Delete]:
Deletes the stored address.
- [OK]:
Applies the settings.

Minor adjustment of home or stored address

When [Edit] is selected, you can edit the following items of the home or stored address can be edited.

Show Icon on Map:

Displays the home icon or the stored address icon on the map.

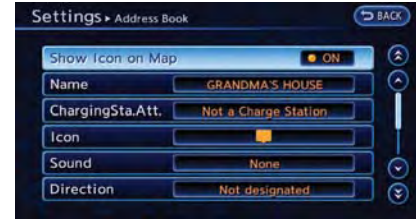

1. Touch [Show Icon on Map].
2. The indicator illuminates when the item is set. Then the system displays the icon on the map.

Name (only for stored addresses):

Changes the name of a stored address.



1. Touch [Name]. A character input screen is displayed.
2. Enter the preferred name for the stored address.
 "Character (letters and numbers) input screen" (page 1-7)
3. After finishing the entry, Touch [OK]. The name is stored.

Charging Sta. Att. (only for stored addresses):

The attributes for the charging station located in the area that is registered can be set.

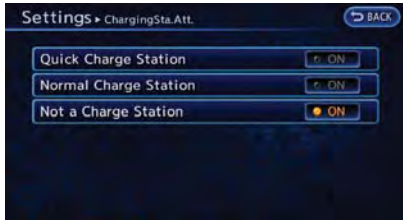

1. Touch [ChargingSta.Att.].
2. Touch the item you would like to set. The indicator illuminates when the item is set.

Available settings

- [Quick Charge Station]:
The location is a charging station that is equipped with quick charging equipment.

- [Normal Charge Station]:
The location is a charging station that is equipped with normal charging equipment.
- [Not a Charge Station]:
The location is not charging station.

Icon:

Changes the icon of the home or stored address to the preferred one. By changing the icons, the usage of the [Sorted By Icon] option of the sort function can be optimized more effectively ([Sort] menu situation).



1. Touch [Icon]. A list of icons is displayed.
2. Touch the preferred icon from the list. The icon is changed.

Sound:

Sets the tone of the alarm that sounds when the vehicle approaches the home or a stored address.

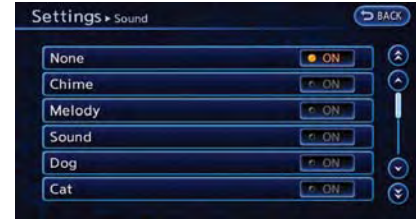

1. Touch [Sound]. A sound list is displayed.
2. Touch the preferred alarm tone. The indicator of the selected alarm tone illuminates.

Direction:

Sets the alarm to sound when approaching from a specific direction.

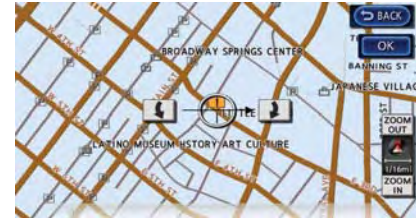

1. Touch [Direction]. A map screen with the home or stored address located on the map center is displayed.

2. Set the direction that sounds the alarm by touching [Left] or [Right].
3. Touch [OK]. The selected direction is set.

INFO:

After the direction is set and [Direction] is selected and set again, a confirmation message is displayed. Confirm the contents of the message then touch [Yes]. The set direction is overwritten.

Distance:

Sets the alarm to sound when reaching a specific distance to the home or stored address.

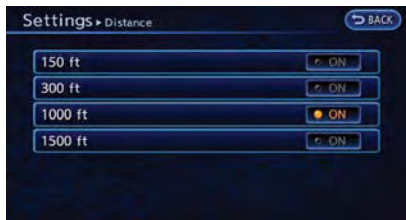

1. Touch [Distance].
2. Touch the preferred distance option. The indicator of the selected distance illuminates.

Available distance options:

- 150 feet (50 m)
- 300 feet (100 m)
- 1000 feet (300 m)
- 1500 feet (500 m)

INFO:

Once the direction and the distance to sound an alarm are set, the system will sound the alarm when the vehicle enters the triggering zone.

Phone number:

Stores the telephone number of the home or a stored address.



1. Touch [Phone No.]. The telephone number entry screen is displayed.
2. Enter the telephone number of the home or stored address.

 "Phone number input screen"
(page 1-8)

3. Touch [OK]. The telephone number is stored.

Group (only for stored addresses):

This groups the stored addresses. By grouping the stored addresses, the [Sorted By Group] option of the sort function can be used more effectively in the [Sort] mode.



1. Touch [Group].
2. Touch the preferred group. When the indicator of the selected group illuminates, the stored address is classified into the applicable group.

Entry Numbers (only for stored addresses):

Index the position numbers of any two stored addresses in the list.

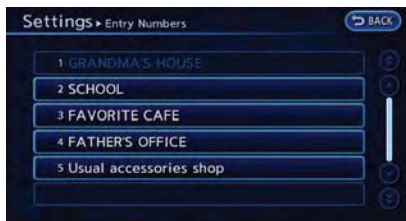

1. Touch [Entry Numbers]. A list of stored addresses is displayed.
2. Touch the stored addresses that you want to change. The position numbers of the selected stored addresses are changed.

Editing stored route

1. Touch [Stored Routes]. A list screen is displayed.



2. Touch the preferred stored route from the list. The edit screen of the selected route is displayed.

3. Touch the preferred item to edit from the list on the right side of the screen.
4. After finishing the editing, touch [OK].

INFO:

If [Store Current Route] is selected, the system stores the current route.

Available settings

- [Rename]:
Changes the name.
☞ "Character (letters and numbers) input screen" (page 1-7)
- [Replace]:
Overwrites the stored route to the current route.
- [Delete]:
Deletes the stored route.

- [OK]:
Applies the settings.

Editing avoid area

1. Touch [Avoid Area]. A list screen is displayed.



2. Touch the preferred Avoid Area from the list. The edit screen of the selected Avoid Area is displayed.

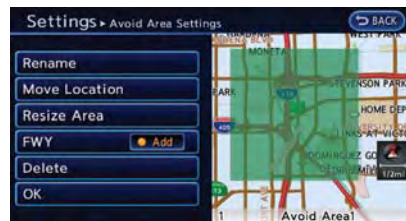

3. Touch the item you would like to set.

Available settings

- [Rename]:
Changes the name of an Avoid Area.
- [Move Location]:
Adjusts the location of the Avoid Area.
- [Resize Area]:
Adjusts the range of the Avoid Area.
- [FWY]:
Sets the route to avoid freeways.
- [Delete]:
Deletes the Avoid Area.
- [OK]:
Applies the setting.

4. After finishing the setting, touch [OK].

INFO:

An Avoid Area can be added by selecting [Add New].

 “Storing avoid area” (page 3-58)

Rename:



1. Touch [Rename]. A character input screen is displayed.
2. Enter the preferred name for the avoid area.
3. Touch [OK]. The name is stored.

Move location:

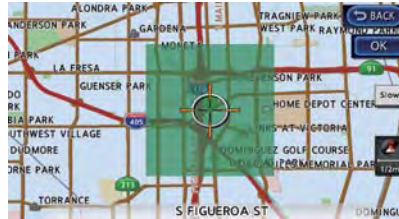

1. Touch [Move Location].
2. Adjust the location of the Avoid Area.

3. After adjusting the location, touch [OK].

Resize area:

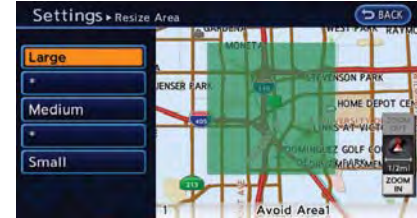

1. Touch [Resize Area].
2. Touch the range from 5 available levels.

FWY:

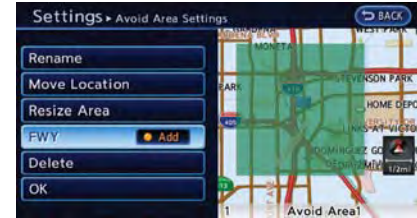

1. To include freeways in the Avoid Area, touch [FWY] to illuminate this indicator.

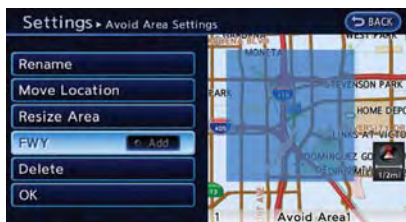

- The Avoid Area is displayed in green if it includes a freeway or in blue if it does not include a freeway.

INFO:

If the current vehicle location is set to an Avoid Area, the system will not provide route guidance.

Delete:

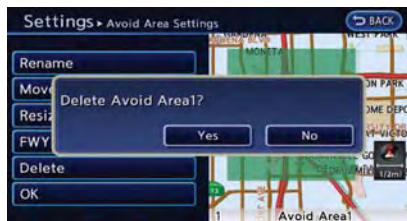

- Touch [Delete]. A confirmation message is displayed.
- Confirm the contents of the message, then touch [Yes]. The stored item is deleted from the Address Book.

DELETING STORED ITEM

The locations and routes in the Address Book can be deleted. Two deletion methods are available: deleting an individual item and deleting all stored items.

INFO:

Deleted items cannot be restored. Before deleting an item, always make sure that the item is no longer needed.

Deleting stored item individually

You can delete stored addresses, routes and avoid areas individually.

- Push the **MENU** button and touch [Settings].
- Touch [Navigation].

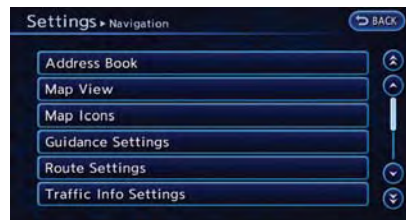

- Touch [Address Book].

Example: [Stored Location] is touched.

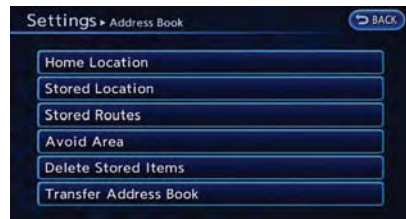

- Touch the preferred item for deletion.

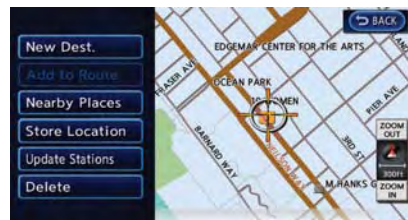

5. Touch the preferred location/route for deletion.

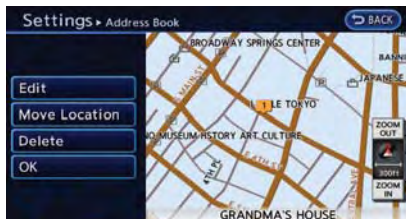

6. Touch [Delete]. A confirmation message is displayed.

7. Confirm the contents of the message, then touch [Yes]. The stored item is deleted from the Address Book.

Other settings

All stored addresses can also be deleted using the following procedure.

1. Push the **MENU** button and touch [Settings].
2. Touch [Navigation].
3. Touch [Deletes Stored Information].

Deleting individual item on map

1. Align the cross pointer over the preferred stored location for deletion by moving on the map. Then touch [Map Menu].

2. Touch [Delete]. A confirmation message is displayed.

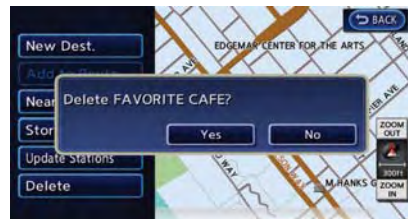

3. Confirm the contents of the message, then touch [Yes]. The stored item is deleted from the Address Book.

Deleting all stored items

1. Push the **MENU** button and touch [Settings].
2. Touch [Navigation].

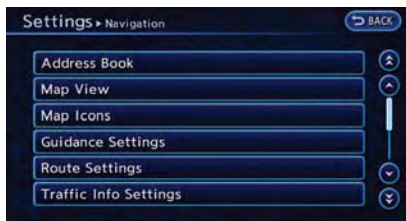

3. Touch [Address Book].

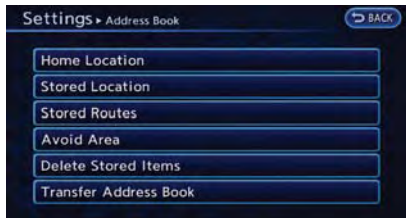

4. Touch [Delete Stored Items].

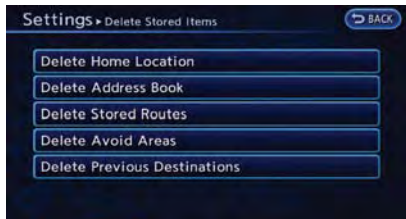

5. Touch the preferred item for deletion. A confirmation message is displayed.

Items that can be deleted

- [Delete Home Location]:
Delete the home location.
- [Delete Address Book]:
Delete all stored locations.
- [Delete Stored Routes]:
Delete all stored routes.
- [Delete Avoid Areas]:
Delete all stored Avoid Areas.
- [Delete Previous Destinations]:
 - [Delete All Previous Destinations]:
Delete all previous destinations.
 - [Delete One]:
Delete one of the previous destinations.
 - [Delete Previous Start Point]:
Delete the previous start points.



6. Confirm the contents of the message, then touch [Yes]. The stored items are deleted from the Address Book.

Other settings

All stored addresses can also be deleted using the following procedure.

1. Push the **MENU** button and touch [Settings].
2. Touch [Navigation].
3. Touch [Deletes Stored Information].

TRANSFERRING INFORMATION TO/ FROM ADDRESS BOOK

The information of the stored home and addresses can be exported and imported using an SD card.

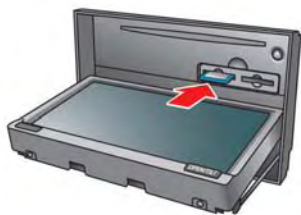

5. Touch [Address Book].

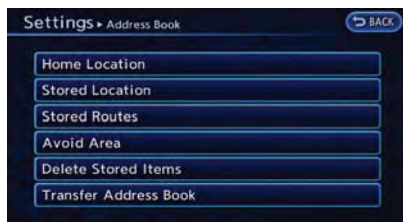

6. Touch [Transfer Address Book].

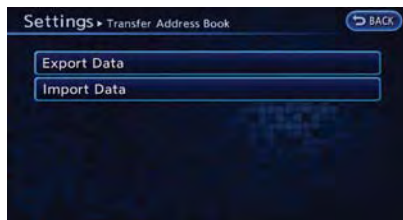

7. Touch [Export Data] or [Import Data].

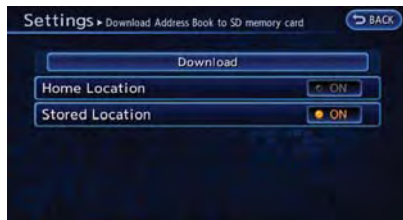

8. Touch a stored item from the list. The indicator of the selected item illuminates.



9. Touch [Download].

INFO:

- Do not remove the SD card or turn off the power while reading or writing the data. This may cause data corruption or data loss.
- Writing is impossible when the lock switch of the SD card is set to the lock position. Release the lock switch before use.
- If the SD card already has the data for a stored address, a confirmation message is displayed. Once overwritten, the original data cannot be recovered.
- An SD card to transfer data to the system is not provided with the vehicle. Use a separately purchased SD card to transfer data.

1. Push **OPEN/TILT** button to open the monitor.
2. Remove the cover to access the SD card slot. Insert an SD card into side slot on the left side.
3. Push the **MENU** button and touch [Settings].
4. Touch [Navigation].



NAVIGATION SETTINGS

The navigation system can be set in details according to the user's preference.



1. Push the **MENU** button and touch [Settings].
2. Touch [Navigation].
3. Touch the item you would like to set.

Available settings

- [Address Book]:
Store locations and routes, and edit the stored items.
☞ "Storing location" (page 3-35)
- [Map View]:
Set the display method and the direction of the map.
☞ "Changing map view" (page 3-8)
- [Map Icons]:
Set the map icons to display on the map.
☞ "Displaying map icons" (page 3-12)

- [Guidance Settings]:
Set the various functions for route guidance.
☞ "Voice guidance settings" (page 3-50)
- [Route Settings]:
Change the route preferences.
☞ "Detailed route settings" (page 3-52)
- [Traffic Info Settings]:
Set the various functions of the XM NavTraffic[®] information system.
☞ "Traffic information settings" (page 6-10)
- [Speed Limit indication on Map]:
Display speed limit information.
☞ "Speed limit indication on map" (page 3-70)
- [Others]:
Display other setting items.
☞ "Other navigation settings" (page 3-70)
- [Delete Stored Information]:
Delete stored locations and the home setting in the Address Book.
☞ "Deleting stored item" (page 3-65)
- [Delete Previous Destinations]:
Delete previous destinations and previous start points individually.
☞ "Deleting all stored items" (page 3-66)

- [Reset All Navigation Settings to Default]:
Reset all of the settings to default.
☞ “Resetting all navigation settings to default” (page 3-73)

SPEED LIMIT INDICATION ON MAP

Turn the [Speed Limit Indication on Map] display on or off. The indicator light illuminates when the speed limit display function is set to on.

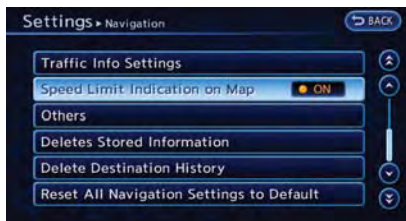

1. Touch [Speed Limit Indication on Map] to toggle the function between on and off. The indicator light illuminates when the speed limit display function is set to on.

OTHER NAVIGATION SETTINGS

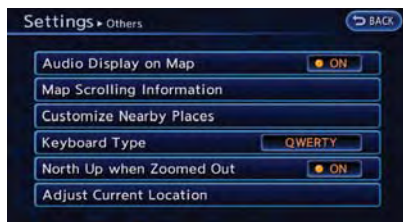

1. Push the **MENU** button and touch [Settings].
2. Touch [Navigation].
3. Touch [Others].
4. Touch the item you would like to set.

Available settings

- [Audio Display on Map]:
Allows the audio information to be displayed at all times.
☞ “Displaying audio information on map screen” (page 3-70)
- [Map Scrolling Information]:
Sets the system so that when the map scrolls the information about the location aligned at the center of the cross pointer is displayed.
☞ “Map scrolling information” (page 3-13)

- [Customize Nearby Places]:
Set the category of frequently visited nearby places.
☞ “Customizing Nearby Places” (page 3-71)
- [Keyboard Type]:
Switches the keyboard layout for the character input screen.
☞ “Settings keyboard layout of character input screen” (page 3-71)
- [North Up when Zoomed Out]:
When this setting is ON, the orientation of the map is automatically changed to North Up when the widest map scale is selected. The orientation is changed to North Up even when Heading Up is set.
- [Adjust Current Location]:
Corrects the position of the current location.
☞ “Adjusting current vehicle location” (page 3-72)

Displaying audio information on map screen

The operating status of audio functions can be displayed on the map screen.

1. Touch [Others].



2. Touch [Audio Display on Map]. The indicator illuminates when the item is set.
3. Push the **MAP** button to return to the current location map screen.

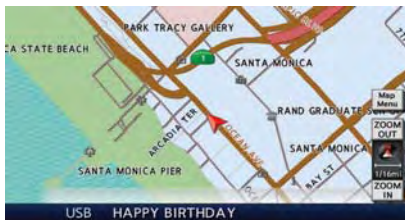

4. On the bottom of the map screen, the operating status of an audio/visual function is displayed at all times.

Customizing Nearby Places

The categories can be customized for searching places of interest nearby.

The modified list of places of interest can be used for searching for a location using [Nearby Places].

1. Touch [Others].
2. Touch [Customize Nearby Places].



3. Touch the preferred item. The main category list is displayed.



4. Touch a main category. The sub category list is displayed.



5. Touch a sub category. The category setting is modified.

Settings keyboard layout of character input screen

The keyboard layout of the character input screen can be set to either the ABC or QWERTY layout, depending on the user's preference.

Example: Switching to the QWERTY layout

1. Touch [Others].
2. Touch [Keyboard Type].

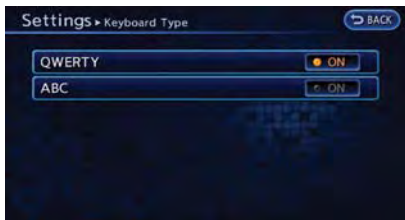

3. Touch [QWERTY]. The indicator illuminates when the item is set.



QWERTY layout



ABC layout

Adjusting current vehicle location

If the vehicle icon indicating the current vehicle location is not in the correct position, the location of the vehicle icon on the map screen can be adjusted.

INFO:

- Regardless of the map view setting, the map is displayed in Plan View when adjusting the position of the vehicle icon.
- When correcting the position of the vehicle icon, the map is automatically displayed in the North Up mode. After finishing the correction, the map restores the current orientation setting.
- The position and direction of the vehicle icon may be misaligned depending on the external conditions and environment.
- If the vehicle icon is misaligned, drive for a while in a location where GPS signals can be received. This may correct the position of the vehicle icon.

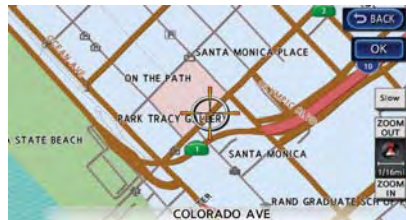

 "Vehicle icon" (page 10-9)

1. Touch [Others].
2. Touch [Adjust Current Location]. The current location map screen is displayed.



3. Adjust the position of the vehicle icon by using touch panel operation. After adjusting the position of the vehicle icon, touch [OK].



4. Adjust the direction of the vehicle icon by touching  or .

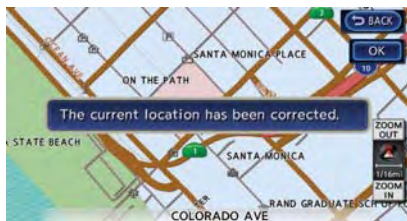

5. After adjusting the direction of the vehicle icon, touch [OK]. A message is displayed, and the adjusted vehicle location is stored.

RESETTING ALL NAVIGATION SETTINGS TO DEFAULT

This restores various settings (display, volume level, etc.) to the default settings.



INFO:

The memory contents, such as the stored locations, will not be deleted.

1. Push the **MENU** button and touch [Settings].
2. Touch [Navigation].

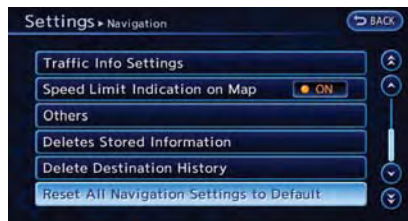

3. Touch [Reset All Navigation Settings to Default].

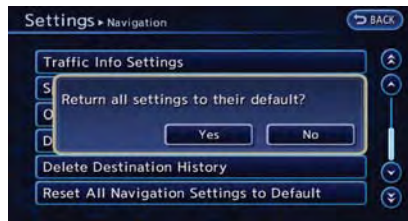

4. A confirmation message is displayed. Confirm the contents of the message, then touch [Yes].

MEMO

4 Audio system

Audio operation precautions.....	4-2	FM-AM-SAT radio with compact disc (CD) player	4-10
Radio	4-2	Audio main operation.....	4-10
Compact Disc (CD) player.....	4-3	FM-AM-SAT radio operation.....	4-11
USB (Universal Serial Bus).....	4-4	Compact Disc (CD) player operation.....	4-12
iPod® player and iPhone®	4-5	iPod® player operation	4-14
Compressed Audio Files (MP3/WMA)	4-6	USB memory operation.....	4-15
Bluetooth® streaming audio	4-9	Bluetooth® streaming audio operation.....	4-17
Antenna	4-9	Auxiliary input jack	4-20
Roof antenna.....	4-9		

AUDIO OPERATION PRECAUTIONS

RADIO

Push the power switch to the "ACC" or "ON" position and push the radio band select button to turn on the radio. If you listen to the radio with the READY to drive indicator light is OFF, the power switch should be pushed to the "ACC" position.

Radio reception is affected by station signal strength, distance from radio transmitter, buildings, bridges, mountains and other external influences. Intermittent changes in reception quality normally are caused by these external influences.

Using a cellular phone in or near the vehicle may influence radio reception quality.

Radio reception

Your NISSAN radio system is equipped with state-of-the-art electronic circuits to enhance radio reception. These circuits are designed to extend reception range, and to enhance the quality of that reception.

However there are some general characteristics of both FM and AM radio signals that can affect radio reception quality in a moving vehicle, even when the finest equipment is used. These characteristics are completely normal in a given reception area, and do not indicate any mal-

function in your NISSAN radio system.

Reception conditions will constantly change because of vehicle movement. Buildings, terrain, signal distance and interference from other vehicles can work against ideal reception. Described below are some of the factors that can affect your radio reception.

Some cellular phones or other devices may cause interference or a buzzing noise to come from the audio system speakers. Storing the device in a different location may reduce or eliminate the noise.

While charging the vehicle, radio programs may not be tuned in to because the reception of the radio becomes weak.

FM radio reception

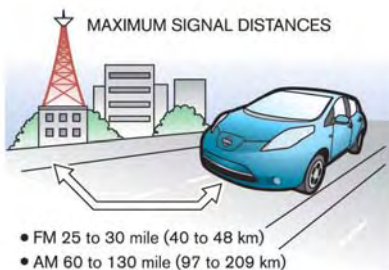

Range: FM range is normally limited to 25 to 30

miles (40 to 48 km), with monaural (single station) FM having slightly more range than stereo FM. External influences may sometimes interfere with FM station reception even if the FM station is within 25 miles (40 km). The strength of the FM signal is directly related to the distance between the transmitter and receiver. FM signals follow a line-of-sight path, exhibiting many of the same characteristics as light. For example they will reflect off objects.

Fade and drift: As your vehicle moves away from a station transmitter, the signals will tend to fade and/or drift.

Static and flutter: During signal interference from buildings, large hills or due to antenna position, usually in conjunction with increased distance from the station transmitter, static or flutter can be heard. This can be reduced by lowering the treble setting to reduce the treble response.

Multipath reception: Because of the reflective characteristics of FM signals, direct and reflected signals reach the receiver at the same time. The signals may cancel each other, resulting in momentary flutter or loss of sound.

AM radio reception

AM signals, because of their low frequency, can bend around objects and skip along the ground. In addition, the signals can bounce off the ionosphere and be bent back to earth. Because of these characteristics, AM signals are also subject to interference as they travel from transmitter to receiver.

Fading: Occurs while the vehicle is passing through freeway underpasses or in areas with many tall buildings. It can also occur for several seconds during ionospheric turbulence even in areas where no obstacles exist.

Static: Caused by thunderstorms, electrical power lines, electric signs and even traffic lights.

Satellite radio reception

When the satellite radio is used for the first time or the battery has been replaced, the satellite radio may not work properly. This is not a malfunction. Wait more than 10 minutes with the satellite radio ON and the vehicle outside of any metal or large building for the satellite radio to receive all of the necessary data.

The satellite radio mode requires an active XM[®] Satellite Radio subscription. The satellite radio is not available in Alaska, Hawaii and Guam.

The satellite radio performance may be affected if cargo carried on the roof blocks the satellite

radio signal.

If possible, do not put cargo near the satellite antenna.

A build up of ice on the satellite radio antenna can affect satellite radio performance. Remove the ice to restore satellite radio reception.

COMPACT DISC (CD) PLAYER

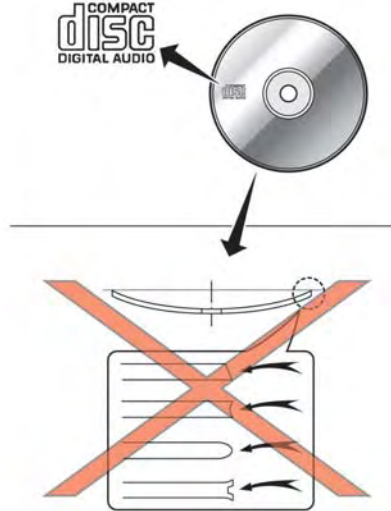

- Do not force a compact disc into the CD insert slot. This could damage the CD and/or CD player.
- Trying to load a CD with the CD door closed could damage the CD and/or CD player.
- During cold weather or rainy days, the player may malfunction due to the humidity. If this occurs, remove the CD and dehumidify or ventilate the player completely.
- The player may skip while driving on rough roads.
- The CD player sometimes cannot function when the passenger compartment temperature is extremely high. Decrease the temperature before use.
- Only use high quality 4.7 in (12 cm) round discs that have the "COMPACT disc DIGITAL AUDIO" logo on the disc or packaging.
- Do not expose the CD to direct sunlight.
- CDs that are of poor quality, dirty, scratched, covered with fingerprints, or that have pin holes may not work properly.
- The following CDs may not work properly:
 - Copy control compact discs (CCCD)
 - Recordable compact discs (CD-R)
 - Rewritable compact discs (CD-RW)

- Do not use the following CDs as they may cause the CD player to malfunction.
 - 3.1 in (8 cm) discs
 - CDs that are not round
 - CDs with a paper label
 - CDs that are warped, scratched, or have abnormal edges
- This audio system can only play prerecorded CDs. It has no capabilities to record or burn CDs.
- If the CD cannot be played, one of the following messages will be displayed.

CHECK DISC:

- Confirm that the CD is inserted correctly (the label side is facing up, etc.).
- Confirm that the CD is not bent or warped and it is free of scratches.

PUSH EJECT:

This is an error due to the temperature inside the player being too high. Remove the CD by pushing the  button, and after a short time reinsert the CD. The CD can be played when the temperature of the player returns to normal.

UNPLAYABLE:

The file is unplayable in this audio system (the system only supports CDs containing MP3 or WMA files).

USB (Universal Serial Bus)

This system supports various USB memory sticks. There are some USB devices which may not be supported with this system.

- Encrypted files and files that have copyright protection etc. cannot be played back on this system.
- The system does not support some models of USB memory.
- Make sure that the USB device is connected correctly into the USB connector.
- A USB HUB cannot be supported with this system.
- Do not force the memory stick or USB cable into the USB connector. This could damage the connector.
- During cold weather or rainy days, the player may malfunction due to humidity. If this occurs, remove the USB device and dehumidify or ventilate the USB player completely.
- The USB player sometimes cannot function when the passenger compartment temperature is extremely high. Decrease the temperature before use.
- Do not leave a USB memory in a place prone to static electricity or where the climate control blows directly. The data in

the USB memory may be damaged.

- The vehicle is not equipped with a USB memory stick.
- A USB device cannot be formatted with this system. To format a USB device, use a personal computer.
- Partitioned USB devices may not be played correctly.
- Some characters used in other languages (Chinese, Japanese, etc.) are not displayed properly on the vehicle center screen. Using English language characters with a USB device is recommended.
- Do not connect a USB device if a connector or cable is wet. Allow the cable and/or connectors to dry completely before connecting the USB device. If the connector is exposed to fluids other than water, evaporative residue may cause a short between the connector pins.

iPod® PLAYER AND iPhone®

This system supports iPod® and iPhone® models.

- A USB cable for connecting an iPod® or iPhone® is not included with this system. Use your own USB cable to connect an iPod® or iPhone®.
- Once connected to the system, operation will not be possible from an iPod® or iPhone®.
- Some functions may be limited depending on the model of iPod® or iPhone® and/or the version of the firmware currently installed.
- When connected to the system, the battery of an iPod® or iPhone® will be recharged.
- Do not use headphones or other accessories when an iPod® or iPhone® is connected to the system. Doing so could prevent the system from operating properly.
- NISSAN does not accept any responsibility for any data that may be lost from an iPod® or iPhone® while it is connected to the system.
- Please refer to the Owner's Manual of the iPod® or iPhone® that is connected to the system.

- Large video files cause slow responses in an iPod®. The vehicle center display may momentarily black out, but it will soon recover.
- If an iPod® automatically selects large video files while in the shuffle mode, the vehicle center display may momentarily black out, but it will soon recover.
- An iPod nano® (1st Generation) may remain in fast forward or rewind mode if it is connected during a seek operation. In this case, please manually reset the iPod®.
- After the Album Shuffle setting has been set when an iPod touch® 1G is connected, if the USB cable is pulled out and inserted again, or if the power switch is placed in the "ACC" or "OFF" positions from the "ON" position, the song that was last played will not be saved.
- Songs that are being played back cannot be cued using the track down operation of an iPod touch® 1G. To use this function, update the firmware of the iPod® that is being used (version 2.2.1 or later).
- After the Album Shuffle setting has been set when an iPod touch® 2G is connected, if the USB cable is pulled out and inserted again, or if the power switch is placed in the "ACC" or "OFF" positions from the "ON" position,

the song that was last played will not be saved. This can be fixed by updating the iPod®'s firmware (version 4.0 or later).

- After the Album Shuffle setting has been set when an iPhone® is connected, if the USB cable is pulled out and inserted again, or if the power switch is placed in the "ACC" or "OFF" positions from the "ON" position, the song that was last played will not be saved.
- After the Album Shuffle setting has been set when an iPhone® 3G or iPhone® 3GS is connected, if the USB cable is pulled out and inserted again, or if the power switch is placed in the "ACC" or "OFF" positions from the "ON" position, the song that was last played will not be saved. This can be fixed by updating the iPhone®'s firmware (version 4.0 or later).
- When an iPhone® 3G, iPhone® 3GS or iPhone® 4 is playing back music, if a Bluetooth® audio device is connected, or if the iPod® mode is switched to again after switching to the Bluetooth® streaming audio mode and playing back Bluetooth® audio, there may be no audio output. In this case, disconnect the iPhone® from the system and then reconnect it again.

- There may be no audio output of Bluetooth® streaming audio if an iPhone® 3G or an iPhone® 3GS and a Bluetooth® audio device are connected to the system and the audio mode is toggled back and forth between the Bluetooth® streaming audio mode and the iPod® mode. In this case, disconnect the Bluetooth® streaming audio from the system and connect again. Additionally, this can be fixed by updating the iPhone®'s firmware (version 4.0 or later).

iPod® and iPhone® are a trademark of Apple Inc., registered in the U.S. and other countries.

Compatibility

The following models are available.

- Fifth generation iPod® (firmware version 1.3 or later)
- iPod Classic® (firmware version 1.1.2 or later)
- First generation iPod touch® (firmware version 2.2.1 or later)
- Second generation iPod touch® (firmware version 2.2.1 or later)
- First generation iPod nano® (firmware version 1.3.1 or later)
- Second generation iPod nano® (firmware version 1.1.3 or later)

- Third generation iPod nano® (firmware version 1.1 or later)
- Fourth generation iPod nano® (firmware version 1.0.3 or later)
- Fifth generation iPod nano® (firmware version 1.0.1PC or later)
- iPhone® (firmware version 3.1.3 or later)
- iPhone® 3G (firmware version 3.1.3 or later)
- iPhone® 3GS (firmware version 3.1.3 or later)
- iPhone® 4 (firmware version 4.0 or later)

Make sure that the iPod® firmware version is updated.

COMPRESSED AUDIO FILES (MP3/WMA)

Explanation of terms

- MP3 — MP3 is short for Moving Pictures Experts Group Audio Layer 3. MP3 is the most well known compressed digital audio file format. This format allows for near "CD quality" sound, but at a fraction of the size of normal audio files. MP3 conversion of an audio track can reduce the file size by approximately a 10:1 ratio (Sampling: 44.1 kHz, Bit rate: 128 kbps) with virtually no perceptible loss in quality. The compression reduces certain parts of sound that seem

inaudible to most people.

- WMA — Windows Media Audio (WMA) is a compressed audio format created by Microsoft as an alternative to MP3. The WMA codec offers greater file compression than the MP3 codec, enabling storage of more digital audio tracks in the same amount of space when compared to MP3s at the same level of quality.
- Bit rate — Bit rate denotes the number of bits per second used by a digital music file. The size and quality of a compressed digital audio file is determined by the bit rate used when encoding the file.
- Sampling frequency — Sampling frequency is the rate at which the samples of a signal are converted from analog to digital (A/D conversion) per second.
- Multisession — Multisession is one of the methods for writing data to media. Writing data once to the media is called a single session, and writing more than once is called a multisession.
- ID3/WMA Tag — The ID3/WMA tag is the part of the encoded MP3 or WMA file that contains information about the digital music file such as song title, artist, album title, encoding bit rate, track time duration, etc. ID3 tag information is displayed on the

Album/Artist/Track title line on the display.
* Windows® and Windows Media® are registered trademarks or trademarks of Microsoft Corporation in the United States of America and/or other countries.

Playback order

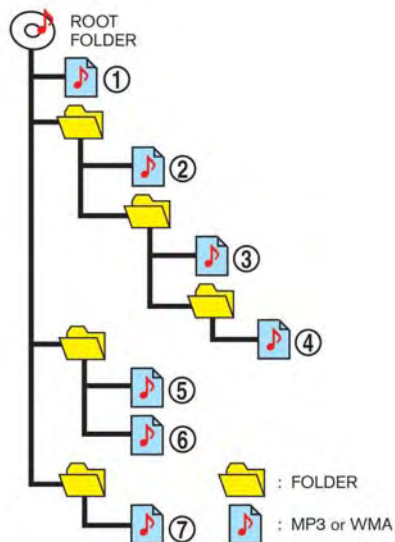

- The folder names of folders not containing compressed audio files are not shown in the display.
- If there is a file in the top level of a disc/USB, "Root Folder" is displayed.
- The playback order is the order in which the files were written by the writing software, so the files might not play in the desired order.
- Music playback order of compressed audio files is as illustrated.

Specification chart

Supported media			CD, CD-R, CD-RW, USB2.0
Supported file systems			CD, CD-R, CD-RW USB memory: FAT16, FAT32
Supported versions*1	MP3	Version	MPEG1 Audio Layer3, MPEG2 Audio Layer3
		Sampling frequency	MPEG2 Audio Layer3: 16kHz, 22.05kHz, 24kHz MPEG1 Audio Layer3: 32kHz, 44.1kHz, 48kHz
		Bit rate	8 kbps - 320 kbps
	WMA*2	Version	WMA7, WMA8, WMA9
		Bit rate/Sampling frequency	32kbps/22.05kHz, 32kHz, 44.1kHz 36kbps/32kHz 40kbps/32kHz 44kbps/32kHz 48kbps/32kHz, 44.1kHz 64kbps/32kHz, 44.1kHz 80kbps/44.1kHz 96kbps/44.1kHz 128kbps/44.1kHz, 48kHz 160kbps/44.1kHz, 48kHz 192kbps/44.1kHz, 48kHz
		Tag information (Song title and Artist name)	ID3 tag VER1.0, VER1.1, VER2.2, VER2.3, VER2.4 (MP3 only) WMA tag (WMA only)
Folder levels			CD, CD-R, CD-RW: Folder levels: 8, Folders: 255 (including root folder), Files: 510 (Max. 255 files for one folder) USB 2.0: Folder levels: 8, Folders: 512 (including root folder), Files: 8000(Max. 255 files for one folder)
Text character number limitation			CD, CD-R, CD-RW: WMA-TAG: 60 characters ID3-TAG (Ver. 1.0/1.1): 30 characters ID3-TAG (Ver. 2.2/2.3/2.4): 60 characters USB: WMA-TAG: 120 characters ID3-TAG (Ver. 1.0/1.1): 60 characters ID3-TAG (Ver. 2.2/2.3/2.4): 120 characters
Displayable character codes*3			01: SHIFT-JIS, 02: UNICODE, 03: UTF-16

*1 Files created with a combination of 48 kHz sampling frequency and 64 kbps bit rate cannot be played.

*2 Protected WMA files (DRM) cannot be played.

*3 Available codes depend on what kind of media, versions and information are going to be displayed.

*4 When VBR files are played, the playback time may not be displayed correctly.

BLUETOOTH® STREAMING AUDIO

- Some Bluetooth® audio devices may not be recognized by the in-vehicle audio system.
- It is necessary to set up the wireless connection between a compatible Bluetooth® audio device and the in-vehicle Bluetooth® module before using the Bluetooth® streaming audio.
- The Bluetooth® streaming audio may be stopped under the following conditions:
 - Receiving a hands-free call.
 - Checking the connection to the hands-free phone.
 - Connecting the hands-free phone or the audio device.
 - Downloading the phonebook memory from the connected cellular phone.
- Do not place a Bluetooth® audio device in an area surrounded by metal or far away from the in-vehicle Bluetooth® module to prevent tone quality degradation and wireless connection disruption.
- While an audio device is connected through a Bluetooth® wireless connection, the battery of the device may discharge quicker than usual.

- This system supports the Bluetooth® Audio Distribution Profile (A2DP, AVRCP).
- Wireless LAN (Wi-Fi) and the Bluetooth® functions share the same frequency band (2.4 GHz). Using the Bluetooth® and the wireless LAN functions at the same time may slow down or disconnect the communication and cause undesired noise. It is recommended that you turn off the wireless LAN (Wi-Fi) when using the Bluetooth® functions.
- Bluetooth® trademark:



Bluetooth® is a trademark owned by Bluetooth SIG, Inc., and licensed to Clarion.

ANTENNA

ROOF ANTENNA

Removing antenna



You can remove the antenna if necessary.

Hold the bottom of the antenna and remove by turning counterclockwise.



CAUTION

- **To avoid damaging or deforming the antenna, be sure to remove the antenna under the following conditions.**
 - **The vehicle enters an automatic car wash.**

FM-AM-SAT RADIO WITH COMPACT DISC (CD) PLAYER

AUDIO MAIN OPERATION

Turning audio system on/off

Push the power switch to the "ACC" or "ON" position, and then push the  button while the system is off to turn on the last audio source, that was playing immediately before the system was turned off. While the system is on, pushing the  button turns the system off.

Switching audio screen

- FM/AM radio band select:
Pushing the **FM-AM** button will change the band as follows:
AM → FM1 → FM2 → AM
 - XM satellite radio band select:
Pushing the **XM** button will change the band as follows:
XM1 → XM2 → XM3 → XM1
 - Audio mode select:
Pushing the **CD-AUX** button will switch the displays as follows:
USB memory/iPod® player → CD → Bluetooth® streaming audio^{*1} → AUX → USB memory/iPod® player
- ^{*1} The screen can only be switched when a Bluetooth® streaming audio device has been registered.

Audio settings

It is possible to adjust the speaker tone quality and sound balance.

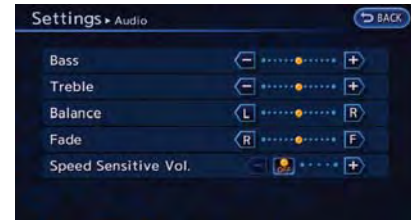

1. Push the **MENU** button and touch [Settings].
2. Touch [Audio].
3. Touch the item you would like to adjust.

Available settings

- [Bass]:
Adjust the tone quality of the bass by touching [+] or [-].
- [Treble]:
Adjust the tone quality of the treble by touching [+] or [-].
- [Balance]:
Adjust the sound level between the left and right speakers by touching [L] or [R].

— The vehicle enters a garage with a low ceiling.

— The vehicle is covered with a car cover.

- Always properly tighten the antenna rod during installation. Otherwise, the antenna rod may break during vehicle operation.

- [Fade]:
Adjust the sound level between the front and rear speakers by touching [R] or [F].
- [Speed Sensitive Vol.]:
The sound volume is increased based on the vehicle speed. Touch [+] or [-] to adjust the effect level from 0 (OFF) to 3.

FM-AM-SAT RADIO OPERATION

When the **FM-AM** button or the **XM** button is pushed while the power switch is in the "ACC" or "ON" position, the radio will turn on at the channel last played.

The last channel played will also turn on when the  button is pushed to ON. The satellite radio is not available in Alaska, Hawaii and Guam.

If another audio source is playing when the **FM-AM** button or the **XM** button is turned on, the audio source will automatically be turned off and the last radio channel played will turn on.

When the stereo broadcast signal is weak, the radio will automatically change from stereo to monaural reception.

The satellite radio mode requires an active XM Satellite Radio subscription. The satellite radio is not available in Alaska, Hawaii and Guam.

It may take some time to receive the activation signal after subscribing the XM Satellite Radio. After receiving the activation signal, an available channel list will be automatically updated in the radio. For XM, push the power switch from LOCK to ACC to update the channel list.

Selecting FM/AM/SAT radio band

FM/AM radio band select:

Pushing the **FM-AM** button will change the band as follows:

AM → FM1 → FM2 → AM

XM satellite radio band select:

Pushing the **XM** button will change the band as follows:

XM1 → XM2 → XM3 → XM1

How to view radio screen



FM/AM radio screen:

- ① Displays the broadcasting station and category currently being received.
- ② Displays the frequency currently being received.
- ③ [Info]:
Displays the broadcasting station information currently being received.
- ④ [SCAN]:
Touch to tune from low to high frequencies and stop at each broadcasting station for 5 seconds.
- ⑤ Displays the preset channel list. If 1 of the 6 preset stations listed is touched and held, the current station will be stored as the new preset.



XM satellite radio screen:

- ① Indicates the channel, category, program and title currently being received.
- ② Indicates the frequency currently being received.
- ③ [CAT]:
Displays a category list for XM radio. When a category is selected, the channel list will be displayed.

- ④ [Direct]:
Input the channel number by using a keypad.
- ⑤ [Info]:
Indicates the broadcasting station information currently being received.
- ⑥ [SCAN]:
Touch to tune from low to high frequencies and stop at each broadcasting channel for 5 seconds.
- ⑦ Displays the preset channel list. If 1 of the 6 preset stations listed is touched and held, the current station will be stored as the new preset.

Selecting channel/category

TUNE (Tuning):

For AM and FM radio:

Push the **TUNE SEEK CH** button for manual tuning.

For XM satellite radio:

Push the **TUNE SEEK CH** button to seek channels from all of the categories.

During satellite radio reception, the following messages will be displayed under certain conditions.

- No Signal (No signal is received while the SAT tuner is connected)
- Channel Off Air (Broadcasting signed off)
- Check Antenna (Antenna connection error)

- Loading (The system is receiving the music or information that is provided from the selected channel)
- Channel Not Available (No channels are searched)
- Channel Not Authorized (There is no user subscription to this channel)

SEEK tuning:

For AM and FM radio:

Push the **TUNE SEEK CH** button for less than 1.5 seconds to tune from low to high or high to low frequencies and to stop at the next broadcasting station.

When the **TUNE SEEK CH** button is pushed and held, radio frequencies will increase or decrease by skipping the broadcasting stations. When the button is released, the next broadcasting station is selected.

SCAN tuning:

Touch [SCAN] to tune from low to high frequencies and stop at each broadcasting station/channel for 5 seconds.

Touch [SCAN] again during this 5 second period to stop SCAN tuning. The radio will remain tuned to that station/channel.

If [SCAN] is not touched within 5 seconds, SCAN tuning moves to the next station/channel.

Storing stations/channels

12 stations/channels can be set for the FM band (6 each for FM1 and FM2), 18 for XM radio (6 each for XM1, XM2 and XM3) and 6 stations can be set for the AM band.

1. Choose the radio band pushing the **FM-AM** button or **XM** button.
2. Tune to the preferred station/channel pushing the **TUNE SEEK CH** button.
3. Touch and hold one of the preset lists to register the chosen broadcasting station or channel.

COMPACT DISC (CD) PLAYER OPERATION



Playing CD

1. Push the power switch to the "ACC" or "ON" position.
2. Push the **OPEN/TILT** button to open the monitor.
3. Insert a Compact Disc (CD) into the slot with the label side facing up. The CD will be guided automatically into the slot and start playing.

After loading a CD, the number of tracks on the CD and the play time will appear on the display.

If the radio is already operating, it will automatically turn off and the CD will play.

If the system has been turned off while a CD was playing, pushing the **⏮** button will start the CD.

Do not use 3.1 in (8 cm) discs.

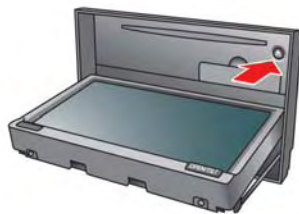

Ejecting CD:

1. Push the **OPEN/TILT** button to open the monitor.
2. When the **⏮** button is pushed with a CD loaded, the CD will be ejected.

When this button is pushed while a CD is being played, the CD will be ejected.

If the CD comes out and is not removed, it will be pulled back into the slot to protect it. Also, the monitor will be closed automatically.

How to view CD screen



- ① Indicates the following information.
CD:
Disc title, Track title, Artist
CD with compressed audio files:
Folder title, File title, Track title, Album title, Artist
- ② Indicates the play mode that is currently set. However, the play mode is not indicated when the normal mode is set.
- ③ [Mode]:
Touch the screen to set the play mode.
- ④ [Info]:
Touch the screen to indicate the track information screen.
- ⑤ [SCAN]:
Touch the screen to play the next track after playing the current track for 10 seconds. Touch the screen again to choose the last track that was played last time.
- ⑥ Folder list:
Touch the folder to indicate the track list.

Track list:

Touch the screen to play the track that is chosen.

Selecting tracks

Push ▲ of the **TUNE SEEK CH** button to play the previous track.

Push ▼ of the **TUNE SEEK CH** button to play the next track.

Touch the track on the track list to play the track that is chosen.

Touch the folder to indicate the track list.

SCAN function:

Touch [SCAN] to play the next track after playing the current track for 10 seconds. Touch [SCAN] again to choose the last track that was played last time.

Next/Previous Track and Fast Forward/Rewind

Push the **TUNE SEEK CH** button for more than 1.5 seconds while a CD is being played to fast forward or rewind through the current track. When the button is released, the CD will return to normal play speed.

When the **TUNE SEEK CH** button is pushed for less than 1.5 seconds while a CD is being played, the next track or the beginning of the current track on the CD will be played.

Select play mode

The play mode settings display will appear when [Mode] is touched.

Select the preferred play mode from the following items.

CD:

- Normal
- 1 Track Repeat
- 1 Disc Random

CD with compressed audio files:

- Normal
- 1 Folder Repeat
- 1 Track Repeat
- 1 Disc Random
- 1 Folder Random

iPod® PLAYER OPERATION

Connecting iPod®



Connect the iPod® cable to the USB connector. If the iPod® supports charging via USB, the battery of the iPod® will be charged while connected to the vehicle.

Depending on the model and firmware version of the iPod®, the display on the iPod® shows a NISSAN or Accessory Attached screen when the connection is completed. When the iPod® is connected to the vehicle, the iPod® music library can only be operated by the vehicle audio controls.

iPod® and iPhone® are a trademark of Apple Inc., registered in the U.S. and other countries.

Playing iPod®

Push the power switch to the "ACC" or "ON" position. Then, push the **CD-AUX** button repeatedly to switch to the iPod® mode. If the system has been turned off while the iPod® was playing, pushing the  button will start the iPod®.

How to view iPod® screen



- ① Indicates the following information.
Track title, Album title, Artist
- ② Indicates the play mode that is currently set.
However, the play mode is not indicated when the normal mode is set.
- ③ [Menu]:
Touch the screen to set the iPod® play method.
- ④ [Mode]:
Touch the screen to set the play mode.
- ⑤ [Info]:
Touch the screen to indicate the track information screen.

⑥ Track list:

Touch the screen to play the track that is chosen.

Next/Previous Track and Fast Forward/Rewind

Push the **TUNE SEEK CH** button for more than 1.5 seconds while an iPod® is playing to fast forward or rewind through the current track. When the button is released, the iPod® will return to the normal play speed.

When the **TUNE SEEK CH** button is pushed for less than 1.5 seconds while an iPod® is playing, the next track or the beginning of the current track on the iPod® will be played.

Select play mode

The play mode setting display will appear when [Mode] is touched.

Select the preferred play mode from the following items.

- Shuffle
Choose "Off", "Songs" or "Albums".
- Repeat
Choose "One" or "All".

iPod® settings

The following items can be chosen from the menu list screen. For further information about each item, see the iPod® Owner's Manual.

- Now Playing
- Playlists
- Artists
- Albums
- Songs
- Podcasts
- Genres
- Composers

USB MEMORY OPERATION



Connecting USB memory

Connect a USB memory as shown in the illustration. The USB screen is displayed.

Playing USB memory

Push the power switch to the "ACC" or "ON" position. Then, push the **CD-AUX** button repeatedly to switch to the USB memory mode. If the system has been turned off while the USB memory was playing, pushing the  button will start the USB memory.

How to view USB memory screen



- ① Indicates Track title, Album title and Artist Name. If there is no track title, the file name will be displayed.
- ② Indicates the play mode that is currently set. However, the play mode is not indicated when the normal mode is set.
- ③ [Mode]:
The play mode setting display will appear when [Mode] is touched.

- ④ [Info]:
Touch the screen to indicate the track information screen.
- ⑤ [SCAN]:
Touch to play the next track after playing the current track for 10 seconds. Touch again to choose the last track that was played last time.
- ⑥ Folder list:
Touch the folder to indicate the track list.
Track list:
Touch the screen to play the track that is chosen.

Selecting tracks

Push  of the **TUNE SEEK CH** button to play the previous track.

Push  of the **TUNE SEEK CH** button to play the next track.

Touch the track on the track list to play the track that is chosen.

Touch the folder to indicate the track list.

SCAN function:

Touch [SCAN] to play the next track after playing the current track for 10 seconds. Touch [SCAN] again to choose the last track that was played last time.

Next/Previous File and Fast Forward/Rewind

Push the **TUNE SEEK CH** button for more than 1.5 seconds while a USB memory is being played to fast forward or rewind though the current track.

When the **TUNE SEEK CH** button is released, the USB memory will return to normal play speed.

When the **TUNE SEEK CH** button is pushed for less than 1.5 seconds while a USB memory is being played, the next track or the beginning of the current track on the USB memory will be played.

Select play mode

The play mode setting display will appear when [Mode] is selected.

Select the preferred play mode from the following items.

- Normal
- 1 Folder Repeat
- 1 Track Repeat
- All Random
- 1 Folder Random

BLUETOOTH® STREAMING AUDIO OPERATION

Your vehicle is equipped with Bluetooth® Streaming Audio.

If you have a compatible Bluetooth® device with streaming audio (A2DP profile), you can set up a wireless connection between your Bluetooth® device and the in-vehicle audio system. This connection allows you to listen to the audio from the Bluetooth® device using your vehicle speakers. It also may allow basic control of the device for playing and skipping audio files using the AVRCP Bluetooth® profile. Not all Bluetooth® devices have the same level of controls for AVRCP. Please consult the manual for your Bluetooth® device for more details.

Wireless LAN (Wi-Fi) and the Bluetooth® functions share the same frequency band (2.4 GHz). Using the Bluetooth® and the wireless LAN functions at the same time may slow down or disconnect the communication and cause undesired noise. It is recommended that you turn off the wireless LAN (Wi-Fi) when using the Bluetooth® functions.

Regulatory information

FCC Regulatory information:

- **CAUTION:** To maintain compliance with FCC's RF exposure guidelines, use only the supplied antenna. Unauthorized antenna, modification, or attachments could damage the transmitter and may violate FCC regulations.
- Operation is subject to the following two conditions:
 - This device may not cause interference and
 - This device must accept any interference, including interference that may cause undesired operation of the device

IC Regulatory information:

- Operation is subject to the following two conditions:
 - This device may not cause interference, and
 - This device must accept any interference, including interference that may cause undesired operation of the device.
- This Class B digital apparatus meets all requirements of the Canadian Interference-Causing Equipment Regulations.

Bluetooth® trademark:



Bluetooth® is a trademark owned by Bluetooth® SIG, Inc., and licensed to Clarion.

Connecting procedure

1. Push the **MENU** and touch [Settings].



2. Touch [Bluetooth].



3. Touch [Connect Bluetooth]. A confirmation message is displayed.



4. Confirm the contents of the message, then touch [No].

INFO:

Selecting [Yes] will only connect the hands-free phone portion of a Bluetooth® device.



5. Choose a PIN code to use with the compatible Bluetooth® audio device using the number input screen. The PIN code will need to be entered into the Bluetooth® audio device after step 7.

6. Touch [OK]. The standby message screen will appear. Operate the compatible Bluetooth® audio device. Please refer to the device's Owners Manual for the Bluetooth® audio connection instructions for your specific device. When the connection is completed, the screen will return to the Bluetooth® setup display.

INFO:

It may not be possible to connect to a Bluetooth® audio profile from the system. In this case, perform connection operation from the Bluetooth® audio player, after connecting the system and the Bluetooth® audio. For details of how to perform connection, refer to the Owner's Manual of the Bluetooth® audio player that is being used.

Playing Bluetooth® streaming audio

Push the power switch to the "ACC" or "ON" position. Then, push the **CD-AUX** button repeatedly to switch to the Bluetooth® audio mode. If the system has been turned off while the Bluetooth® audio device was playing, pushing the  button will start the Bluetooth® audio device.

The ability to pause, change tracks, fast forward, rewind, randomize and repeat music may be different between devices. Some or all of these functions may not be supported on each device.

When the **CD-AUX** button is pushed with the system off and the Bluetooth® audio device connected, the system will turn on.

If another audio source is playing and the Bluetooth® audio device is connected, push the **CD-AUX** button repeatedly until the display changes to the Bluetooth® audio mode.

INFO:

- Depending on the Bluetooth® audio device that is connected, it may not be possible to perform audio operations.
- Depending on the Bluetooth® audio device that is connected, a time lag may occur before music is played back.

How to view Bluetooth® streaming audio screen



- ① Indicates Track title, Album title and Artist name.
- ② Indicates the play mode that is currently set. However, the play mode is not indicated when the normal mode is set.
- ③ [▶ Play]:
Touch to start the Bluetooth® audio device.
- ④ [⏸ Pause]:
Touch to pause the Bluetooth® audio device.
- ⑤ [Mode]:
The play mode setting screen displays when [Mode] is touched.

INFO:

Depending on the audio device that is connected to the vehicle, the name of tracks or albums may not be displayed.

Next/Previous Track and Fast Forward/Rewind

Push the **TUNE SEEK CH** button is pushed for more than 1.5 seconds while a Bluetooth® audio file is being played to fast forward or rewind through the current track. When the **TUNE SEEK CH** button is released, the Bluetooth® audio device will return to normal play speed.

When the **TUNE SEEK CH** button is pushed for less than 1.5 seconds while a Bluetooth® audio file is being played, the next track or the beginning of the current track on the Bluetooth® audio device will be played.

Select play mode

The play mode setting display will appear when [Mode] is touched.

Select the preferred play mode from the following items.

- Shuffle
Choose "Shuffle OFF", "Shuffle All Tracks" or "Shuffle Group".

- Repeat
Choose "Repeat 1 Track", "Repeat All Tracks" or "Repeat Group".

Bluetooth® settings

The Bluetooth® settings can be set in detail to according to the user's preference.



1. Push the **MENU** button and touch [Settings].
2. Touch [Bluetooth Connections].
3. Touch the item you would like to set.

Available settings

- [Bluetooth]:
If this setting is turned off, the connection between the Bluetooth® devices and the in-vehicle Bluetooth® module will be canceled.
- [Connect Bluetooth]:
Connects to the Bluetooth® device. Up to 5 devices can be registered.

- [Connected Devices]: Registered devices are shown on the list. Select a Bluetooth® device from the list. The following options are available.
- [Edit Bluetooth Info]: Change the name broadcasted by this system over Bluetooth®. Change the PIN code that is entered when connecting a hands-free device to this system.

AUXILIARY INPUT JACK

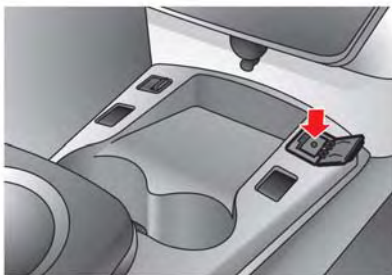

The auxiliary input jack is located on the center console.

The auxiliary input jack accepts any standard analog audio input such as from a portable cassette player, CD player or MP3 player.

Before connecting a device to the jack, turn off the power of the portable device.

When the **CD-AUX** button is pushed with the system off and a compatible device connected, the system will turn on. If another audio source is playing and a compatible device is connected, push the **CD-AUX** button repeatedly until the center display changes to the AUX mode.

INFO:

Insert a 1/4 inch (3.5 mm) stereo mini plug in the auxiliary input jack. If a cable with a mono plug is used, the audio output may not function normally.

How to view AUX screen



Select the volume settings from the following options.

- Low
- Medium

- High

5 CARWINGS™

Telematics overview	5-2	CARWINGS™ settings	5-10
CARWINGS™ overview.....	5-4	Setting messages that are received by email	5-11
About service application	5-6	Information feed setting	5-14
Notice for usage.....	5-6	Displaying unit ID information.....	5-16
Radio approval number and information	5-6	Reset all CARWINGS™ settings to default	5-17
Displaying CARWINGS™ information screen.....	5-7	Error message on communication.....	5-18
How to view information screen	5-7	Data communication settings.....	5-19
Storing favorites	5-9	Automatic carrier settings.....	5-19
Viewing CARWINGS™ records	5-10	Manual carrier settings.....	5-19

TELEMATICS OVERVIEW

In addition to Event Data Recorders (EDRs) mentioned in the LEAF Owner's Manual, this vehicle is equipped with electronic modules that monitor, control and record data concerning various vehicle systems, including the motor, batteries, braking and electrical systems. Other electronic modules record information concerning driving conditions, including idling, braking, acceleration, trip and other related data, information about your use of the car and its features such as air conditioner or headlight usage, diagnostic trouble codes, vehicle charging, vehicle speed, direction and/or location.

Some of this data is stored by the vehicle for use during vehicle servicing. Other data concerning your vehicle's operation and performance is wirelessly transmitted by cellular connection through the vehicle onboard telematics system upon vehicle start-up or at other intervals to NISSAN. This data may be used by NISSAN for various purposes, including: to provide you with CARWINGS™ services (refer to the CARWINGS™ section of this manual for details); troubleshooting; evaluation of your vehicle's quality, functionality and performance; analysis and research by NISSAN designed to, among other things, optimize performance of future electric vehicles including improvements in future battery life; to offer you new or additional products or services; and as otherwise may be

required by law. Such data may be shared with NISSAN's parents, subsidiaries, affiliates, successors or assignees; authorized NISSAN certified LEAF dealers; NISSAN's marketing partners; your fleet company, if your vehicle is a fleet vehicle; your rental company, if your vehicle is a rental vehicle; and third party service providers such as cellular, information systems and data management providers.

State laws allow access and use of data recorded by vehicle devices with the consent of the vehicle owner or pursuant to subscription agreement. While you are not required to allow such access and use, if you do not so agree NISSAN may be unable under applicable law to activate the vehicle telematics system in your vehicle, and certain features of your vehicle which are dependent on vehicle telematics will not operate as intended or designed. These may include features such as automatic charging station map updates, remote battery state of charge check, charging complete notice, remote plug in reminder, remote charging on, remote climate control on, drive route planning, driving tips to improve range, driving history, billing simulation, ECO ranking, ECO forest, maintenance reminders, etc. Other features that may be developed and offered by NISSAN in the future may also not function without telematics data transmission.

CARWINGS™ telematics services are provided by NISSAN pursuant to a subscription services agreement covering your vehicle. This agreement is necessary for all owners. This agreement, and an explanation of its terms and conditions, can be found at the NISSAN Owner's Portal webpage. Further, the operator of the vehicle must also touch [OK] on the Navi screen to indicate assent each time he or she starts the car. If you decide at any time that you do not want your vehicle to transmit data to NISSAN, you can deactivate the telematics account associated with this vehicle by canceling the subscription services agreement by visiting the NISSAN Owner's Portal Webpage or calling NISSAN at 1-877-NOGASEV (1-877-664-2738). The service can be reactivated later upon request if you choose. Simply visit the same website or call the number above. Alternatively, you can turn off the transmission of certain categories of data through the use of settings found in the Navigation system under Menu, CARWINGS™, Vehicle Information Sharing with NISSAN. Note, turning off "Vehicle Information Sharing with NISSAN" will only disable the automatic sharing of information at vehicle start-up. Certain categories of data may still be transmitted if vehicle telematics features are accessed either in the vehicle or remotely.

Your agreement to the transmission and use of

data by NISSAN can be provided in various ways. The vehicle is equipped with a “pop up” screen on the vehicle navigation system that will ask for your consent to this data transfer. A version of the following message will appear: “Pursuant to subscription agreement, your vehicle wirelessly transmits recorded vehicle data to NISSAN for various purposes, including CARWINGS™ services, product evaluation, research and development. By touching [OK], you consent to the transmission and use of your vehicle data. See Owner’s Manual or NISSAN Owner’s portal webpage for terms and details.” If you touch [OK], your vehicle will transmit data as designed in connection with the vehicle telematics system. If you touch [Decline] your vehicle will not transmit data. However, the telematics features referenced above, and perhaps others, will not be available to you. The vehicle’s static navigation system will remain operational, and you will be able to access your radio and climate controls.

Telematics features are dependent on cellular data transmission. Some areas may have limited or no cellular connectivity, resulting in a loss or interruption of data transmission and, as a result, certain features may be temporarily unavailable. Even if areas with good signal reception, cellular connectivity can be adversely affected by things such as tall buildings, apartments, tunnels,

underground parking, mountainous areas, etc. Even if the signal strength bar of the in-vehicle data communication module indicates good reception, connectivity may be disrupted. This does not indicate a malfunction. Operate the system again after a few minutes to restore connectivity. CARWINGS™ telematics features are offered as a convenience to the vehicle owner. NISSAN is not responsible for, and owner assumes all risk of, interruptions in service or errors based on incomplete or inaccurate data. CARWINGS™ communications may be received at a verified e-mail address or by SMS/text messaging-enabled mobile phone. Standard text rates and/or data usage may apply depending on your carrier.

If your vehicle’s telematics account is active, and you are not the original owner, please contact NISSAN at the website or phone number above as soon as possible to update the telematics enrollment information. Upon sale of the vehicle, please contact NISSAN at the website or phone number above so that NISSAN’s records may be updated. CARWINGS™ subscription services will automatically terminate at the end of the initial free term if you do not wish to renew your subscription agreement at the prices then in effect.

CARWINGS™ OVERVIEW



This vehicle incorporates a communication device that is called a TCU (Telematics Communication Unit). The communication connection between this unit and the NISSAN CARWINGS Data Center allows for various services.

When the system connects to the NISSAN CARWINGS Data Center, an antenna icon will appear on the screen. Use the service in a location where the symbol representing good signal reception appears on the screen.



: When the signal reception is good



: When the signal reception is bad



INFO:

You can check driving records for your vehicle online at the Nissan Owner's Portal website.

However, if [Share Vehicle Information] is set to OFF, vehicle data will not be uploaded. Make sure that this setting is ON.

When [Service Reminder] is set to ON, communication with the NISSAN CARWINGS Data Center will be performed once daily. NISSAN recommends that you set [Service Reminder] to ON.

 "CARWINGS™ settings" (page 5-10)

Remote functions

- **Battery status check:**

The status of the battery can be checked using your personal computer or cellular phone even if you are not in the vehicle.

- **Unplugged status, Charge status:**

By registering frequently used charging stations, notifications can be sent to your personal computer or cellular phone email address to inform you when the charging connector is disconnected or charging is stopped mid-charge at those locations.

- **Remote charge, Remote climate control:**

Remote activation of battery charging or climate control can be set using your personal computer or cellular phone.

Navigation Telematics (CARWINGS™ service)

- **Automatic update of charging stations:**

The information for the charging stations that is recorded in the map data is automatically updated.

- **All Information Feeds:**

Convenient information for driving such as weather and traffic information, ECO information shared with the LEAF users, etc. is provided.

- **Favorites:**

When the information of an Internet site is selected and it is stored in the page that is specially established in the NISSAN Owner's Portal Website, the information is converted into an appropriate format via the NISSAN CARWINGS Data Center and provided for use in the vehicle. The content of the information is automatically read out. For the registration method of information data, visit the NISSAN Owner's Portal Website.

NOTE:

- **Establishing the CARWINGS™ service is necessary before using this service.**

- **To check the Li-ion battery charging status or to use the remote heater and air conditioner using an internet enabled smart phone or personal computer, the following conditions must be met:**

- **The vehicle must be located in a cellular phone or smart phone coverage area.**
- **The internet enabled cellular phone or smart phone must be located in a cellular phone or smart phone coverage area.**

- **The computer must be connected to the internet.**

- **A cellular phone must be used to communicate with the vehicle.**

- **A cellular phone capable of text messaging must be used to receive text message regarding vehicle charge status.**

- **When the remote heater and air conditioner is set, the system operates the heater and air conditioner to adjust the in-cabin temperature to a factory pre-set temperature.**
- **When the charge connector is disconnected from the vehicle, the heater and air conditioner operates using vehicle Li-ion battery electric power.**
- **If the remote heater and air conditioner function and Li-ion battery charging are performed at the same time, Li-ion battery charging will take longer than usual due to the power used to heat or cool the vehicle.**
- **Certain remote functions require a compatible smart phone, which is not included with vehicle.**
- **CARWINGS™ information system features are included through a subscription service which requires owner**

consent to activate. The subscription must be active to use these features.

- **CARWINGS™ communications may be received at a verified e-mail address or by SMS/text messaging-enabled cellular phone.**
- **Standard text rates and/or data usage may apply depending on your carrier.**

ABOUT SERVICE APPLICATION

Registering for the CARWINGS™ service is necessary before using this service. For detailed information, access the NISSAN Owner's Portal Website. Confirm the terms of service and complete the user registration form. After registration is completed, a user ID and password are provided.

 "Inputting user ID and password"
(page 1-11)

CAUTION

If the vehicle is sold to another person, this service must be canceled and all data stored in the device must be deleted to avoid having personal data inadvertently disclosed.

NOTICE FOR USAGE

- The CARWINGS™ service uses the TCU (Telematics Communication Unit). Even if the signal strength bar of the in-vehicle data communication module indicates good reception, connection to the NISSAN CARWINGS Data Center may be disabled. This does not indicate a malfunction. Operate the system again after a few minutes.
- The CARWINGS™ service cannot be used under the following conditions:
 - The vehicle moves outside the service area of the TCU (Telematics Communication Unit) connection to the system.
 - The vehicle is in a location with poor signal reception such as a tunnel, underground parking, behind a building or in a mountainous area.

RADIO APPROVAL NUMBER AND INFORMATION

WARNING

- **The TCU antenna is installed inside the upper central part of the instrument panel. An occupant should not get any closer to the antenna than specified by the pacemaker manu-**

facturer. The radio waves from the TCU antenna may adversely affect the operation of the pacemaker while using the CARWINGS™ service.

- **Radio waves could adversely affect electric medical equipment. Those who use a pacemaker should contact the electric medical equipment manufacturer regarding the possible influences before use.**

- FCC ID: LHJGNOV1N

The antenna(s) used for this transmitter must not be co-located or operating in conjunction with any other antenna or transmitter.

- IC ID: 2807E-GNOV1N

DISPLAYING CARWINGS™ INFORMATION SCREEN

1. Push the **MENU** button and touch [CARWINGS].



2. Touch [All Information Feeds].



3. Touch the preferred folder. An information feed list is displayed.



4. Touch the preferred information feed. An information feed screen is displayed.

INFO:

- Touch [Stop] while communicating with the NISSAN CARWINGS Data Center to cancel the communication.
- A message is displayed when the communication is disconnected while downloading information due to poor communication status. Touch [Yes] to restart the download.

HOW TO VIEW INFORMATION SCREEN

When the information screen is displayed, the contents are shown with images and sounds.



Screen when Auto-play is on

- ① When the selected feed includes image data, the images are displayed. If not, only titles are shown.
- ② [Pause]:
Touch to stop the voice announcement function that reads out the information that is currently displayed.
- ③ [▲]/[▼]:
Touch [▲] to have the system announce the previous information. Touch [▼] to have the system announce the next information.
- ④ The page number, the number of information items, location data information and telephone data information are displayed.

Auto-play function:

This function receives feeds from the NISSAN CARWINGS Data Center, displays them on the screen, and then automatically reads out the contents.



Screen when Auto-play is off

When [Pause] is touched during Auto-play, the Auto-play function stops and the settings appear on the screen. The items displayed on the screen vary depending on the feeds that are received.

Available settings

- [Play]:
The system will resume reading out the information.
- [Show Map]:
If a feed received includes information about shops etc., it may also include map data. Touch to display the map on the screen.
- [New Dest.]:
If a feed received includes map data, the location can be set as a destination.
- [Add to Route]:
If a route is already set, the location of the feed received can be added to the route as

a destination or a waypoint.

- [Call]:
If a feed received includes a telephone number, it will be displayed on the screen. Touch to make a phone call. A cellular phone must be connected to the vehicle before making a phone call.
- [Show Pic.]:
If a feed received includes image data, it will be displayed on the screen. Touch to display the image on the screen.
- [Details]:
Displays detailed information for a selected feed.
- [Store Loc.]:
If a feed received includes map data, the location can be registered as a registered location in the address book .
- [Current Loc.]:
Displays the map for the current position.
- [Lock Channel]:
Protects one of the feeds that are stored in the history from being deleted.
- [Unlock chn]:
This will be displayed only when a selected feed is already protected. Touch to cancel protection.

- [Delete Chnl]
Deletes the feeds that are stored in the history.

INFO:

- Some images are not displayed depending on the contents.
- Some words such as personal names, place names, special terms, symbols, etc. may not be pronounced correctly. This does not indicate a malfunction.
- The system will pause announcements when voice guidance given by the navigation system occurs. When the voice guidance finishes, the system will restart the announcement.
- The volume can be adjusted when the system announces the information.
 "Volume settings" (page 1-16)

STORING FAVORITES

A maximum of 16 favorite feeds selected from the information feeds can be stored in a folder.

1. Push the **MENU** button and touch [CARWINGS].



2. Touch [Favorites].

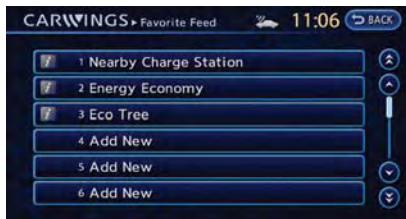

3. Touch [Add New]. A folder list is displayed.



4. Touch the preferred folder from the list. An information feed list is displayed.



5. Touch a favorite feed to be stored.



6. Check the contents of the message, then touch [Yes]. When the contents of the information are sent to the NISSAN CARWINGS Data Center, the registration is completed.

INFO:

- The contents that are entered in the favorites folder need to be transmitted to the NISSAN CARWINGS Data Center. Registration of the contents is not completed until the data is transmitted to the NISSAN CARWINGS Data Center.
- A message is displayed if communication is interrupted while downloading information. Touch [Yes] to restart the download.

VIEWING CARWINGS™ RECORDS

The information feeds that were referred to previously are displayed. A maximum of 3 feeds are stored in the history.

1. Push the **MENU** button and touch [CARWINGS].



2. Touch [History]. An Information feed list is displayed.

INFO:



- When the number of feeds stored in the history reaches the limit, the system deletes the oldest feed and saves a new feed.
- One feed that should not be deleted can be protected. To protect history of information feeds visited, display the screen for the information feed you want to protect and after auto-play has been paused, touch [Lock chan.].
 "How to view information screen" (page 5-7)

CARWINGS™ SETTINGS



1. Push the **MENU** button and touch [CARWINGS].
2. Touch [CARWINGS Settings].
3. Touch the item you would like to set.

Available settings

- [Charging Message]:
Sends a notification to a preset e-mail address. This notification includes the charge connector status and the charge completion.
 "Setting messages that are received by email" (page 5-11)
- [Sign in]:
The user ID and password can be entered.
 "Inputting user ID and password" (page 1-11)
- [Auto-Update Stations]:
When information for new charging stations is received while the vehicle is connecting to

the NISSAN CARWINGS Data Center, the information is automatically downloaded and the map data is updated.

- [Service Reminders]:
The information that is sent from the NISSAN CARWINGS Data Center is displayed.
- [Information Feed Setting]:
Set the timing of the connection to the NISSAN CARWINGS Data Center, or edit the list of the information feeds.
📖 "Information feed setting" (page 5-14)
- [Vehicle Information Sharing with Nissan]:
 - [Share Vehicle Information]:
Vehicle information (driving history, etc.) is automatically sent to the NISSAN CARWINGS Data Center.
 - [Delete Share Vehicle Information]
Vehicle information (driving history, etc.) is deleted.
- [Unit ID Information]:
The necessary information for user registration is displayed.
📖 "Displaying unit ID information" (page 5-16)
- [Reset all CARWINGS settings to default]:
All CARWINGS™ settings are reset to the factory default setting.
📖 "Reset all CARWINGS™ settings to

default" (page 5-17)

SETTING MESSAGES THAT ARE RECEIVED BY EMAIL

Sends a notification to a preset e-mail address. This notification includes the charge connector status and the charge completion. To receive a notification to your personal computer or cellular phone, an e-mail address should be set beforehand. For details, access the NISSAN Owner's Portal Website.

Storing location for receiving charge connector disconnected notifications

A maximum of 5 regularly used charging stations can be registered. If the charging connector is disconnected in one of these locations, an email informing you of this will be sent.

1. Touch [Store charging plug reminder locations].



2. Touch [Add New].



3. Touch the appropriate method to search for a location.

📖 "Setting destination" (page 3-17)



4. When a preferred location is displayed at the center of the map, confirm the location and touch [OK]. A message is displayed, and the location is stored.

Editing charging plug reminder location:

1. Touch [Store charging plug reminder locations].



2. Touch the preferred stored location from the list.

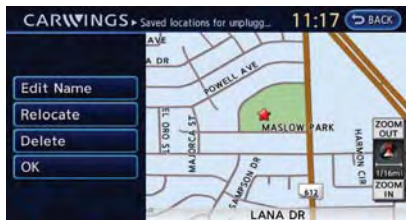

3. Touch the item you would like to set.

Available settings

- [Edit Name]:

Changes the name of a stored location.

 "How to input letters and numbers"
(page 1-7)

- [Relocate]:

Adjusts the location of the stored location.

- [Delete]:

Deletes the stored address.

- [OK]:

Applies the settings.

Setting time for receiving charge connector status notifications

This confirms the charge connector status at the set checking time. If the charge connector is then disconnected, a notification is sent to the preset e-mail address.

1. Touch [Charging Plug Reminder Time].

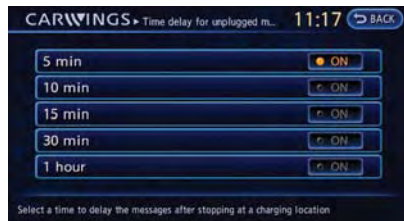

2. Touch the preferred checking time. The indicator of the selected time illuminates.

Available checking times

- 5 min
- 10 min
- 15 min
- 30 min
- 1 hour

3. When the power switch is placed in the "OFF" position from the "ON" position, the setting will be set to ON.



INFO:

When the power switch is placed in the "OFF" position from the "ACC" position, the check time setting will be reset.

Sending charge connector status information to Data Center

If the system recognizes that the charge connector is not connected to the vehicle even though the charge timer function is set, the system transmits this information to the NISSAN CARWINGS Data Center. When the NISSAN CARWINGS Data Center receives the information, it will send an e-mail to the specified address to inform you of the charge connector status.



1. Touch [Send unplugged status to Data Center]. The indicator illuminates when the item is set.

INFO:

Even if the notification service for the charge connector status is set, no notification is sent and no status can be checked under the following conditions.

- The system will check the connection status of the charge connector within the period of time set, but will not check once this period of time has been exceeded. Therefore, if the charge connector is removed from the vehicle after the period of time set, a notification is not sent.
- The charge connector status notification does not indicate the start of battery charging.

- No notification is sent if the vehicle is outside the communication service area.
- The notification does not include the reason why the charge connector is disconnected.
- If the vehicle is not used for 2 weeks, communication with the vehicle is disabled.
- If the power switch is in the "ON" position, no notification is sent.

Sending battery charge status information to Data Center

If a battery charge is interrupted before it is completed, the system recognizes this and transmits this information to the NISSAN CARWINGS Data Center. When the NISSAN CARWINGS Data Center receives the information, it will send an email to the specified address to inform you of the battery charge status.



1. Touch [Send charging status to Data Center]. The indicator illuminates when the item is set.

Emails that are received from the NISSAN CARWINGS Data Center inform you of the following:

- Interruption to battery charge
- Current battery level
- Battery capacity
- Driving range (Two values are shown: when the air conditioner is on or off)

INFO:

Even if the notification service for the charge completion is set, no notification is sent and no status can be checked under the following conditions.

- The charge interruption notification does not always indicate the completion of battery charging.
- This notification does not mean that the timer charge function did not start at the time set.
- No notification is sent if the vehicle is outside the communication service area.
- The notification does not include the reason why the battery charging was interrupted.

- If the vehicle is not used for 2 weeks, communication with the vehicle is disabled.
- If the power switch is in the "ON" position, no notification is sent.

Restoring default settings for notifications

All settings are set to the factory default settings.

1. Touch [Reset All Notifications to Default]. A confirmation message is displayed.



2. Confirm the contents of the message, then touch [Yes].

INFORMATION FEED SETTING

Set the timing of the connection to the NISSAN CARWINGS Data Center, or edit the list of the information feeds. You can also delete all the history of the information feeds used.

1. Touch [Information Feed Setting].



2. Touch the item you would like to set.

Available settings

- [Download Automatically]:

Set the timing of automatic connection to the NISSAN CARWINGS Data Center, or the channel to be automatically connected to.

- [Edit Feed List]:

Information feeds that are frequently used can be registered to the favorites list, and the information feed list can be updated or restored to the factory default setting.

- [Delete All Information Feed records]:
All information feeds stored in the history are deleted.

Download automatically

Select download interval:

Set the timing of automatic connection to the NISSAN CARWINGS Data Center.



1. Touch [Select Download Interval].



2. Touch the preferred time setting. The indicator of the selected time setting illuminates.

notes.

Available time settings

- [Never]:

The system does not automatically connect to the NISSAN CARWINGS Data Center.

- [Power on]:

When the power switch is turned to the ON position, the system will automatically connect to the NISSAN CARWINGS Data Center.

- [Every 30 min]:

When the power switch is turned to the ON position and every 30 minutes after the power switch is turned to the ON position, the system will automatically connect to the NISSAN CARWINGS Data Center.

- [Every 60 min]:

When the power switch is turned to the ON position and every 60 minutes after the power switch is turned to the ON position, the system will automatically connect to the NISSAN CARWINGS Data Center.

- [Every 120 min]:

When the power switch is turned to the ON position and every 120 minutes after the power switch is turned to the ON position, the system will automatically connect to the NISSAN CARWINGS

Data Center.

Select information feed:

Set the information feed that is displayed when the system automatically connects to the NISSAN CARWINGS Data Center. Before performing this setting, the timing of the automatic connection function needs to be set.

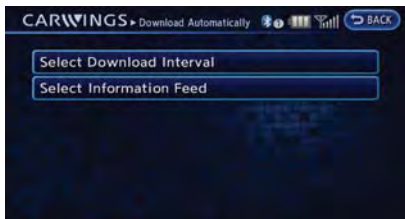

1. Touch [Select Information Feed]. A folder list is displayed.



2. Touch the preferred folder from the list. An information feed list is displayed.

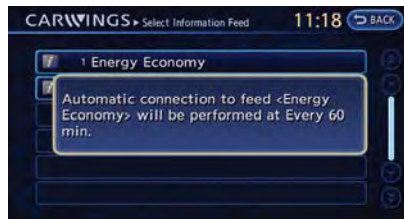

3. Touch the preferred information feed from the list. A message is displayed, and the selected information feed is set.

Edit feed list

Information feeds that are frequently used can be registered to the favorites list, and the information feed list can be updated or restored to the factory default setting.



1. Touch [Edit Feed List].



2. Touch the item you would like to set.

Available settings

- [Add to Favorites]:

A maximum of 16 favorite feeds selected from the information feeds can be stored in a folder.

 "Storing favorites" (page 5-9)

- [Update Feed List]:

Connect to the NISSAN CARWINGS Data Center and update the information feed list.

- [Initialize Feed List]:

Restore the information feed list to the factory default setting.

Delete all information feed records

All information feeds stored in the history are deleted.



1. Touch [Delete All Information Feed records]. A confirmation message is displayed.



2. Confirm the contents of the message, then touch [Yes].



INFO:

Once the information feeds are deleted from the history, the deleted items cannot be restored.

DISPLAYING UNIT ID INFORMATION

1. Push the **MENU** button and touch [CARWINGS].
2. Touch [CARWINGS Settings].
3. Touch [Unit ID Information]. The unit information screen is displayed.



Available information

- Unit ID
 - TCU ID
 - TCU Phone No.
 - SIM ID
 - VIN
4. Touch [BACK] to return to the previous screen.

RESET ALL CARWINGS™ SETTINGS TO DEFAULT

All CARWINGS™ are reset to the factory default setting.



1. Touch [Reset all CARWINGS settings to default]. A confirmation message is displayed.

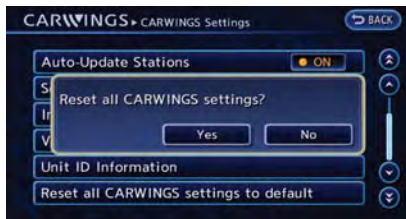

2. Confirm the contents of the message, then touch [Yes].

ERROR MESSAGE ON COMMUNICATION

The display may show the following messages on the screen while using the CARWINGS™ service. If the messages is displayed, follow the on screen instructions. Otherwise, contact a NISSAN certified LEAF dealer.

Error message	Possible solution
Downloading...	Data downloading from the NISSAN CARWINGS Data Center. Please wait.
Connection is need to store Favorite Feed Settings. Connect now?	Connection to the NISSAN CARWINGS Data Center is necessary to store your favorite feeds. To connect to the data center, touch [Yes] on the message screen.
There is additional content remaining. Download now?	To download, touch [Yes] on the message screen.
System Busy.	The system is busy. Please wait.
Connecting...	Connecting to the NISSAN CARWINGS Data Center. Please wait.
Connecting to Center	Connecting to the NISSAN CARWINGS Data Center. Please wait.
No service.	The service is not available in the area. Please try again in an area where connection to the NISSAN CARWINGS Data Center is possible.
The connection to the center failed.	Connection to the NISSAN CARWINGS Data Center failed. Please try again later.
Please proceed to the Data Communication setting menu.	Data connection setting is necessary. Touch [Phone & CARWINGS] to complete the data connection setting.
Telematics unit is not connected.	TCU is not connected. Please contact a NISSAN certified LEAF dealer.
Telematics communication is currently busy. Please try again later.	The line is busy. Please try again later.
Would you like to connect to the center again?	To reconnect to the NISSAN CARWINGS Data Center, touch [Yes] on the message screen.
Subscription is required to receive service. Please confirm subscription and password.	Please check if your CARWINGS™ subscription is active, and if the password you entered is correct.

DATA COMMUNICATION SETTINGS

AUTOMATIC CARRIER SETTINGS

1. Push the **MENU** button and touch [Settings].
2. Touch [Phone & CARWINGS].



3. Touch [Data Communication].

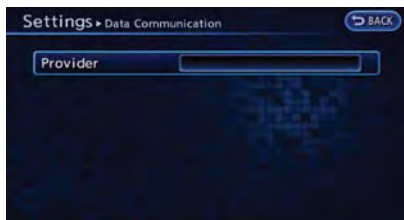

4. Touch [Select Carrier].



5. Touch [Automatic Setup]. The indicator illuminates when the item is set.

MANUAL CARRIER SETTINGS

1. Push the **MENU** button and touch [Settings].
2. Touch [Phone & CARWINGS].



3. Touch [Data Communication].

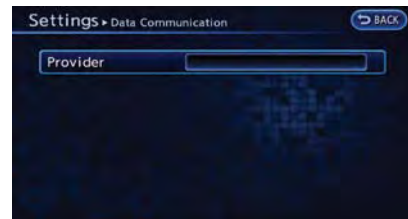

4. Touch [Select Carrier].



5. Touch [Manual Setup]. The indicator illuminates, and then [Select Carrier] can be touched.
6. Touch [Select Carrier]. A list screen is displayed.



7. Touch the preferred carrier from the list. The indicator illuminates when the item is set.

6 Viewing technical information

Information screen	6-2	Viewing available traffic information	6-6
Viewing vehicle information	6-3	Info on route	6-7
Viewing maintenance information	6-3	Nearby traffic info.	6-7
Comfort & convenience settings	6-4	Display urgent traffic information	6-8
Viewing information about current vehicle location	6-4	Traffic information on map	6-8
Viewing Charging Station information	6-5	Traffic information settings	6-10
		Viewing GPS current location information	6-11
		Viewing navigation system version information	6-12

INFORMATION SCREEN

This screen sets or displays various information that is helpful for using the vehicle. Available items include the vehicle information, Traffic Info. setup, current location information, GPS information, Voice Recognition list and navigation software version.



1. Push the **MENU** button and touch [Info.].
2. Touch the item you would like to set.

Available settings

- [Energy Info.]:
Energy information is displayed on the screen.
☞ "Energy information display" (page 2-7)
- [Maintenance]:
Displays the vehicle maintenance information.
☞ "Viewing maintenance information" (page 6-3)
- [Where am I?]:
Displays information regarding the current vehicle location.
☞ "Viewing information about current vehicle location" (page 6-4)
- [Charging Station Info]:
Displays charging station information for the current location.
☞ "Viewing Charging Station information" (page 6-5)
- [Traffic Info]:
Allows Traffic Info. setup.
☞ "Viewing available traffic information" (page 6-6)
- [Voice Recognition]:
Displays the voice command list.
☞ "Displaying command list" (page 8-6)
- [GPS Position]:
Displays GPS information regarding the current vehicle location.
☞ "Viewing GPS current location information" (page 6-11)
- [Navigation Version]:
Displays the current navigation system version.
☞ "Viewing navigation system version information" (page 6-12)



An XM NavTraffic[®] subscription is necessary to view Traffic Info.

VIEWING VEHICLE INFORMATION

VIEWING MAINTENANCE INFORMATION

The maintenance intervals can be displayed for your preferred maintenance items.



1. Push the **MENU** button and touch [Info.].
2. Touch [Maintenance].
3. Select the maintenance interval for the battery, air conditioner filter, tire and other reminders.

You can also set the system to display a message to remind you that the maintenance needs to be performed.

The following example shows how to set the battery maintenance information. Use the same steps to set the other maintenance information items.



1. Reset the driving distance to the new maintenance schedule.
2. Set the interval (mileage) of the maintenance schedule. To determine the recommended maintenance interval, refer to the "NISSAN Service and Maintenance Guide".
3. To display the reminder automatically when the set trip distance is reached, touch [Reminder].
4. To return the display to MAINTENANCE INFO., touch [BACK].

The unit can be converted between "US" and "Metric".

 "Unit settings" (page 1-17)



The Reminder will be automatically displayed as shown when both of the following conditions are met:

- the vehicle is driven the set distance and the power switch is pushed to the "LOCK" position.
- the power switch is pushed to the "ACC" or "ON" position the next time you drive the vehicle after the set value has been reached.

To return to the previous screen after the maintenance reminder screen is displayed, touch [OK].

The maintenance reminder screen is displayed each time the power switch is pushed to the ON position unless one of the following operations is performed:

- [Reset Distance] is touched.
- [Reminder] is set to OFF.

- the maintenance interval is set again.

COMFORT & CONVENIENCE SETTINGS

This key does not appear on the display until the power switch is pushed to the "ON" position.

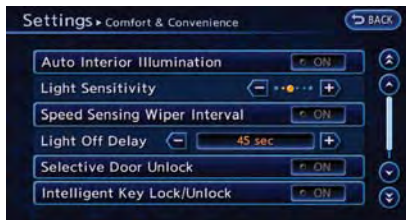

1. Push the **MENU** button and touch [Settings].
2. Touch [Comfort & Convenience].
3. Touch the item you would like to set.

Available settings

- [Auto Interior Illumination]:
When this item is turned on, the interior lights will illuminate if any door is unlocked.
- [Speed Sensing Wiper Interval]:
When this item is turned to ON, the wiper interval is adjusted automatically according to the vehicle speed.

- [Light Sensitivity]:
Adjust the sensitivity of the automatic headlight by touching [+] or [-].
- [Light Off Delay]:
Select the duration of the automatic headlight off timer from 0, 30, 45, 60, 90, 120, 150 and 180 second periods.
- [Selective Door Unlock]:
When this item is turned on, only the driver's door is unlocked first after the door unlock operation. When the door handle request switch on the driver's or front passenger's side door is pushed to be unlocked, only the corresponding door is unlocked first. All the doors can be unlocked if the door unlock operation is performed again within 60 seconds. When this item is turned to OFF, all the doors will be unlocked after the door unlock operation is performed once.
- [Intelligent Key Lock/Unlock]:
When this item is turned to ON, door lock/unlock function by pushing the door handle request switch will be activated.
- [Return All Settings to Default]:
Touch this item and touch [Yes] if you want to return all settings to the default.

VIEWING INFORMATION ABOUT CURRENT VEHICLE LOCATION

This displays information about the vehicle location on the route when driving according to route guidance.



1. Push the **MENU** button and touch [Info.].
2. Touch [Where am I?].

Contents of vehicle location information

- ① Next Street:
Displays the next street on the route.
- ② Displays the distance to the next intersection on the route.
- ③ Current Street:
Displays the current street on the route.
- ④ Previous Street:
Displays the previous street on the route.
- ⑤ Displays the distance traveled from the previous intersection on the route.

VIEWING CHARGING STATION INFORMATION

Location information about the charging stations near the current vehicle position or the destination can be checked. The searched charging stations can be used for the route search function.

CAUTION

Charging station information may not be detailed in all areas or reflect current charging station locations. For up to date information about charging stations, such as business hours or charging equipment, NISSAN recommends that you directly access the information on your own. Additionally, always check the Li-ion battery available charge and set a reasonable driving schedule.

1. Push the **MENU** button and touch [Info.].



2. Touch [Charging Station Info].



3. Touch the preferred setting. A list screen is displayed.

Available settings

- [Near Current Location]:
The charging stations located near the current vehicle position are displayed.
- [Near Destination]:
The charging stations located near the destination are displayed.
- [Near Scroll Position]:
The map screen is displayed and the charging stations located near the area where the cross pointer is placed are displayed.

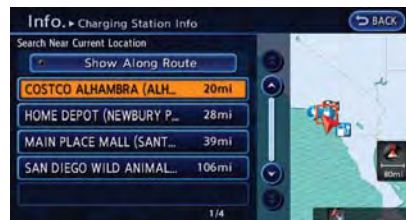

4. Touch the preferred charging station from the list. Information about the charging station is displayed.



5. Touch the confirmation items. Touch [BACK] to return to the previous screen.

Available confirmation items

- [Show Map]:
Displays the selected charging station and sets it as the destination.
 "Operations after setting destination" (page 3-34)

VIEWING AVAILABLE TRAFFIC INFORMATION

XM NavTraffic[®] information is a subscription service offered by Sirius XM[®] Radio, Inc.

This service provides real-time information regarding traffic flow, accidents, road construction and other incidents, where available.

XM NavTraffic[®] combines information from commercial and public traffic data providers including government departments of transportation, police, emergency services, road sensors, cameras and aircraft reports. The traffic information is broadcast to the vehicle by the XM[®] satellites. Available traffic information on the route the driver selected is shown on the navigation screen so traffic conditions between you and the destination are known. Three types of real-time traffic information for major roadways are shown on the navigation system:

- * Unscheduled traffic data for example, accidents and disabled vehicles.
- * Scheduled traffic data, for example road construction and road closures.
- * Traffic flow information (rate of speed data).

- [Call]:
Makes a call for the selected charging station. A cellular phone should be connected beforehand.
 "Connecting cellular phone"
(page 1-13)
- [Details]:
Displays detailed information including the type and number of charging devices existing at the selected charging station.

WARNING

XM NavTraffic[®] information is not a substitute for attentive driving. Traffic conditions change constantly and emergency situations can arise without warning. Relying only on XM NavTraffic[®] information may lead to a collision and could result in serious personal injury.

INFO:

- Flow information is provided only for roads equipped with traffic sensors and is not available in all markets covered by the service. Flow data may not be available on portions of a road that is under construction.
- If a contract is not completed for XM NavTraffic[®] traffic information service, a message appears, and it will not be possible to check the information on the traffic information menu.

XM NavTraffic[®] information is available in limited markets. To subscribe or to check if this service is available in the area:

call 1-800-XM-RADIO (1-800-967-2346) or see www.xmradio.com/navtraffic



1. Push the **MENU** button and touch [Info.].
2. Touch [Traffic Info.].
3. Touch the preferred information setting.

Available settings

- [Info on Route]:
Displays the list of traffic information found on the recommended route from the current vehicle location to the destination.
- [Nearby Traffic Info]:
Displays the list of traffic information around the current vehicle location.

INFO ON ROUTE

This is only available when a route is set.

The list of traffic information found on the recommended route from the current vehicle location to the destination is displayed. Detailed information about displayed events can also be checked.

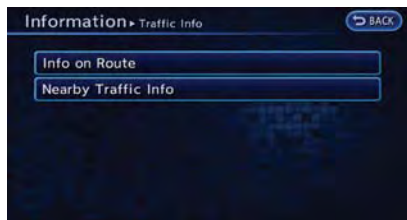

1. Touch [Info on Route]. A list screen is displayed.



2. Touch the event to check the detailed information.

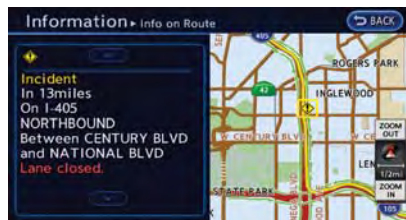

3. The map screen centered around the selected event is displayed. On the left screen, detailed information about the event is displayed.

The message can be scrolled by touching [↶] or [↷].

4. Touch [BACK] to return to the previous screen.

NEARBY TRAFFIC INFO.

The list of available traffic information near the current vehicle location is displayed.

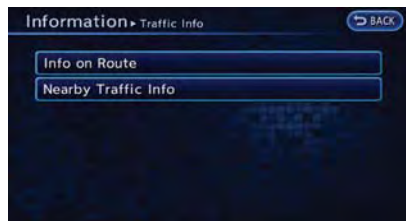

1. Touch [Nearby Traffic Info]. A list screen is displayed.

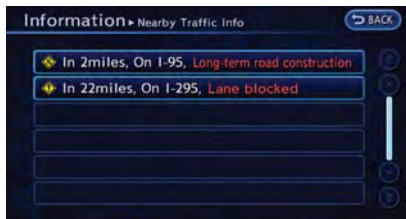

2. Touch the event to check detailed information.

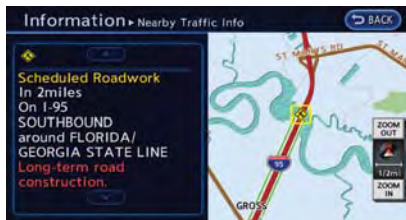

3. The map screen centered around the selected event is displayed. On the left screen, detailed information about the event is displayed. The message can be scrolled touch [⬆] or [⬇].

4. Touch [BACK] to return to the previous screen.

DISPLAY URGENT TRAFFIC INFORMATION

When an urgent event is found near the current vehicle location, a message pops up automatically with a voice announcement.



The message includes the icon, event type, event information and the direct distance from the current location to the event.

INFO:

- Urgent traffic information is displayed regardless of whether the traffic information setting is on or off.
- When there are multiple urgent events, the event with the shortest direct distance from the current location is displayed.

- If the urgent event is on the recommended route, and if a detour is found, the detour route notification screen is displayed when the vehicle approaches the detour point.

TRAFFIC INFORMATION ON MAP





With subscription to XM NavTraffic® service, traffic information is displayed on both Plan View and Birdview™ map screen.

See "Notes on Traffic Information" for further information.







-  "Notes on XM NavTraffic® information" (page 10-36)

Screen information



- ①  Traffic indicator:
Displays the reception condition of traffic information transmitted from the provider.
Green: Reception condition is good.
Gray: Reception condition is poor.
No mark: Subscription to XM NavTraffic® service is not detected.
- ② Road conditions
Free Flow:  (Green)
Moderate traffic:  (Yellow)
Heavy traffic:  (Red)
Section affected by serious traffic event: 

- (Purple)
- ③ Estimated travel time to destination calculated taking traffic information on route info consideration.
- ④ Traffic information icon:
If the route is not already set, all of the traffic information icons on the map screen are displayed in color. When the route is already set, the icons on the route are displayed in color, and the icons outside the route are displayed in gray.
- : Accident

- : Closed road
- : Information
- : Road work
- : Slippery road
- : Weather
- : Incident

Traffic information display and scale levels

2D map and Birdview Map	
5 miles	10 km
2 miles	4 km
1 mile	2 km
1/2 mile	1 km
1/4 mile	500 m
1/8 mile	200 m
1/16 mile	100 m
1/32 mile	50 m
1/64 mile	25 m

Checking detailed information for traffic information icons on map

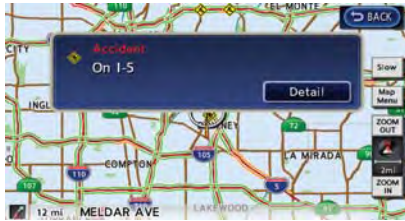

1. Place the cross pointer over the traffic information icon. The general description of the icon is displayed.
2. Touch [Detail]. The screen for showing detailed information for the traffic information icon is displayed.

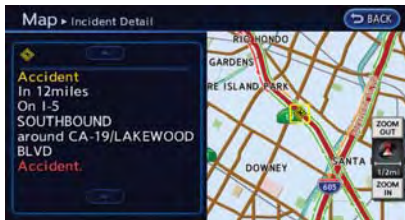

3. The map screen centered around the selected event is displayed. On the left screen, detailed information about the event

is displayed. You can scroll the message by touching [▲] or [▼].

4. Push the **MAP** button to return to the current location map screen.

TRAFFIC INFORMATION SETTINGS

This displays or changes the settings for the traffic information related functions.

1. Push the **MENU** button and touch [Settings].
2. Touch [Navigation].

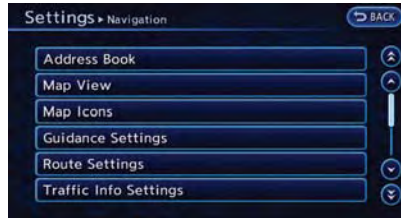

3. Touch [Traffic Info Settings].

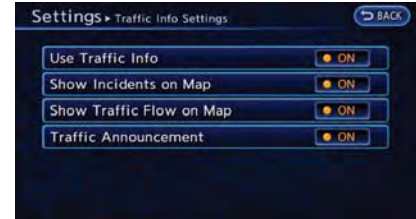

4. Touch the preferred setting. The indicator for the selected setting illuminates.

Available settings

- [Use Traffic Info]: Enables all traffic information related functions.
- [Show Incidents on Map]: Displays the traffic incidents (e.g., accident) on the map screen.
- [Show Traffic Flow on Map]: Displays the traffic flow with an arrow on the map screen.
- [Traffic Announcement]: Announces the traffic information event on the route.



INFO:

- Even when [Show Traffic Flow on Map] and [Show Incidents on Map] are set to OFF, the list display of [Info on Route] and [Nearby Traffic Info] will not be affected.
- Even when [Traffic Announcement] is set to OFF, the route guidance will not be affected. Also, the announcement of emergency information will not be turned off.

VIEWING GPS CURRENT LOCATION INFORMATION

This displays GPS information, such as the positioning status, latitude/longitude, altitude and satellite locations.



1. Push the **MENU** button and touch [Info.].
2. Touch [GPS Position].
3. Push the **MAP** button to return to the current location map screen.

Contents of GPS information

- ① The number of satellites:
 - (green): Satellites are available.
 - (gray): Satellites are being searched for.
- ② Calculation:
 - Displays the GPS positioning method.
 - 3 dimension:
 - Calculates the latitude, longitude and altitude by four or more satellites.
 - 2 dimension:
 - Calculates the latitude, longitude and altitude by three or more satellites.
 - Out of range:

Cannot calculate because no GPS satellites can be located.

- ③ Latitude:
 - Displays the latitude.
- ④ Longitude:
 - Displays the longitude.
- ⑤ Approx. Altitude:
 - Displays the approximate altitude.

VIEWING NAVIGATION SYSTEM VERSION INFORMATION

This displays the map version information.



1. Push the **MENU** button and touch [Info.].
2. Touch [Navigation Version].
3. Push the **MAP** button to return to the current location map screen.

7 Bluetooth® Hands-Free Phone System

Bluetooth® Hands-Free Phone System	7-2	Receiving a call	7-5
Regulatory information	7-3	During a call	7-6
Control button and microphone	7-3	Storing vehicle phonebook	7-6
Connecting procedure	7-4	Phone settings	7-8
Phone selection	7-4	Car phone or CB radio	7-10
Making a call	7-5		

BLUETOOTH® HANDS-FREE PHONE SYSTEM

WARNING

- **Use a phone after stopping your vehicle in a safe location. If you have to use a phone while driving, exercise extreme caution at all times so full attention may be given to vehicle operation.**
- **If you find yourself unable to devote full attention to vehicle operation while talking on the phone, pull off the road to a safe location and stop your vehicle before doing so.**

CAUTION

To avoid draining the vehicle battery, use a phone after the READY to drive indicator light is ON.

Your vehicle is equipped with Bluetooth® Hands-Free Phone System. If you are an owner of a compatible Bluetooth® enabled cellular phone, you can set up the wireless connection between your cellular phone and the in-vehicle phone module. With Bluetooth® wireless technology, you can make or receive a telephone call with your cellular phone in your pocket.

7-2 Bluetooth® Hands-Free Phone System

Once a cellular phone is connected to the in-vehicle phone module, the procedure for connecting the phone does not need to be performed again. Your phone is automatically selected with the in-vehicle phone module when the power switch is pushed to the "ON" position with the selected cellular phone turned on and carried in the vehicle.

You can register up to 5 different Bluetooth® cellular phones in the in-vehicle phone module. However, you can talk on only one cellular phone at a time.

The NISSAN Voice Recognition system supports phone commands, so dialing a phone number using your voice is possible.

 "8. Voice recognition"

Before using the Bluetooth® Hands-Free Phone System, refer to the following notes.

- Wireless LAN (Wi-Fi) and the Bluetooth® functions share the same frequency band (2.4 GHz). Using the Bluetooth® and the wireless LAN functions at the same time may slow down or disconnect the communication and cause undesired noise. It is recommended that you turn off the wireless LAN (Wi-Fi) when using the Bluetooth® functions.

- Set up the wireless connection between a compatible cellular phone and the in-vehicle phone module before using the Bluetooth® Hands-Free Phone System.

- Some Bluetooth® enabled cellular phones may not be recognized by the in-vehicle phone module.

Please visit www.nissanusa.com/bluetooth for a recommended phone list.

- You will not be able to use a hands-free phone under the following conditions:

- Your vehicle is outside of the telephone service area.

- Your vehicle is in an area where it is difficult to receive radio waves; such as in a tunnel, in an underground parking garage, behind a tall building or in a mountainous area.

- Your cellular phone is locked in order to prevent dialing.

- When the radio wave condition is not ideal or ambient sound is too loud, it may be difficult to hear the other person's voice during a call.

- Immediately after the power switch is pushed to the "ON" position, it may be impossible to receive a call for a short period of time.

- Do not place the cellular phone in an area surrounded by metal or far away from the in-vehicle phone module to prevent tone quality degradation and wireless connection disruption.
- While a cellular phone is connected through the Bluetooth® wireless connection, the battery power of the cellular phone may discharge quicker than usual.
- If the Bluetooth® Hands-Free Phone System seems to be malfunctioning, please visit www.nissanusa.com/bluetooth for troubleshooting help.
- Some cellular phones or other devices may cause interference or a buzzing noise to come from the audio system speakers. Storing the device in a different location may reduce or eliminate the noise.
- Refer to the cellular phone Owner's Manual regarding the telephone pairing procedure specific to your phone, battery charging, cellular phone antenna, etc.
- The antenna display on the monitor will not coincide with the antenna display of some cellular phones.
- The battery display on the monitor will not coincide with the battery display of some cellular phones.

- Keep the interior of the vehicle as quiet as possible to hear the caller's voice clearly as well as to minimize its echoes.
- If reception between callers is unclear, adjusting the incoming or outgoing call volume may improve the clarity.

REGULATORY INFORMATION

FCC Regulatory information

- **CAUTION:** To maintain compliance with FCC's RF exposure guidelines, use only the supplied antenna. Unauthorized antenna, modification, or attachments could damage the transmitter and may violate FCC regulations.
- Operation is subject to the following two conditions:
 - this device may not cause interference and
 - this device must accept any interference, including interference that may cause undesired operation of the device

IC Regulatory information

- Operation is subject to the following two conditions:
 - this device may not cause interference, and

- this device must accept any interference, including interference that may cause undesired operation of the device.
- This Class B digital apparatus meets all requirements of the Canadian Interference-Causing Equipment Regulations.

Bluetooth® trademark:



Bluetooth® is a trademark owned by Bluetooth® SIG, Inc., and licensed to Clarion.

CONTROL BUTTON AND MICROPHONE



- ① Microphone
- ②  button on the steering wheel

CONNECTING PROCEDURE

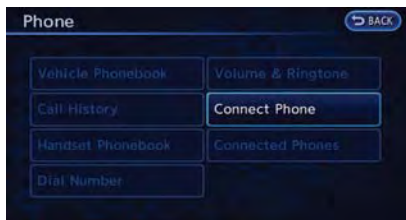

1. Push the  button on the steering wheel and touch [Connect Phone].



2. When a PIN code appears on the screen, operate the Bluetooth[®] compatible cellular phone to enter the PIN code.

The procedure for connecting of the cellular phone varies according to each cellular phone. See the cellular phone Owner's

Manual for the details.

You can also visit www.nissanusa.com/bluetooth or call NISSAN Consumer Affairs Department for instructions on pairing NISSAN recommended cellular phones.

When the connection process is completed, the screen will return to the Phone menu display.

PHONE SELECTION

Up to 5 cellular phones can be registered to the system.

1. Push the **MENU** button and touch [Phone].

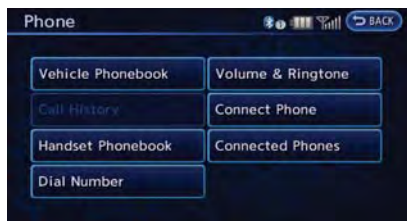

2. Touch [Connected Phones]. The list of the registered cellular phones is displayed.



3. Touch one of the registered cellular phones from the list.



4. Touch [Connect]. If you select a cellular phone that is different from the one currently connected, the newly selected phone will be connected to the system.

MAKING A CALL

To make a call, follow this procedure.

1. Push the  button on the steering wheel.



2. Touch a method for making a call.

Available methods

- [Vehicle Phonebook]:

Select a telephone number from the phonebook, and then make a call. Before making a call, the telephone number must be registered in the phonebook.

- [Call History]:

Select a telephone number from the incoming or outgoing history lists, and then make a call.

- [Handset Phonebook]:

Download the phonebook from a cellular phone that is connected to the vehicle, select a telephone number from the phonebook, and then make a call. Phonebook data should be registered in the

system after downloading the phonebook from the cellular phone that is connected to the vehicle. If the phonebook is not registered, a message that reminds you of phonebook data download will be displayed.

- [Dial Number]:

Input the phone number manually using the keypad displayed on the screen.

 "How to input letters and numbers" (page 1-7)

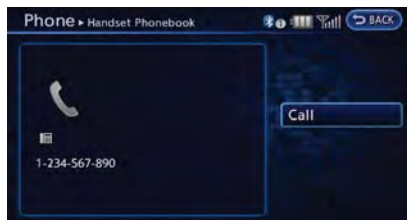

3. Dialing will start and the screen will change to the call in progress screen.
4. After the call is over, perform one of the following actions to finish the call.
 - Push the  button on the steering wheel.
 - Touch [Hang up].

RECEIVING A CALL

When you hear a phone ring, the display will change to the incoming call mode. To receive a call, perform one of the following procedures listed below.

- Push the  button on the steering wheel.
- Touch [Answer].



There are some options available when receiving a call. Select one of the following displayed on the screen.

- [Answer]:
Accept an incoming call to talk.
- [Hold Call]:
Put an incoming call on hold.
- [Reject Call]:
Reject an incoming call.

To finish the call, perform one of the following procedures listed below.

- Push the  button on the steering wheel.
- Touch [Hang up].

DURING A CALL



There are some options available during a call. Select one of the following displayed on the screen if necessary.

- [Hang up]:
Finish the call.
- [Use Handset]:
Transfer the call to the cellular phone.
- [Mute]:
Mute your voice to the person.
- [Cancel Mute]:
This will appear after [Mute] is touched. Mute will be canceled.
- [Keypad]:
Using the touch tone, send digits to the connected party for using services such as

voicemail.

- [Switch Call]:

Answer another incoming call. The person you are talking to will be placed on hold. Push once more to speak to the person on hold again.

By selecting [Hang up], you can end a call and can speak to a caller who is on hold again.

This function may not be usable, depending on the model of phone.

To adjust the person's voice to be louder or quieter, push the  button on the steering wheel while talking on the phone. This adjustment is also available in the SETTING menu.

 "Volume settings" (page 1-16)

STORING VEHICLE PHONEBOOK

By registering the frequently dialed phone numbers, you can easily call these numbers.

1. Push the **MENU** button and touch [Phone].
2. Touch [Vehicle Phonebook].



3. Touch [Add New] at the top of the screen.



4. Select the method for entering the phonebook entry.

Available methods

- [Copy from Call History]:
The system will show a list of incoming or outgoing calls. Select one of these entries to save in the vehicle phonebook.
- [Copy from the Handset]:
The system will show the connected cellular phone's phonebook that was downloaded (depending on the phone's

compatibility). Select one of these entries to save in the vehicle phonebook.

- [Enter Number by Keypad]:

Input the phone number to save in the vehicle phonebook.



5. Touch [OK] at the top of the screen.



6. After the phonebook entry is saved, it will show a screen to indicate that is ready to call the number. Touch [BACK] to return to the Vehicle Phonebook.

Editing Vehicle Phonebook

1. Push the **MENU** button and touch [Settings].
2. Touch [Phone & CARWINGS].
3. Touch [Phone].

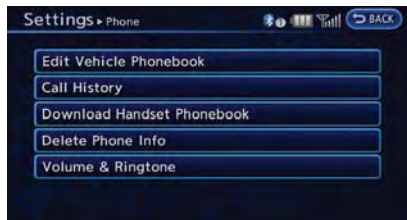

4. Touch [Edit Vehicle Phonebook].



5. Select the desired entry from the displayed list.



6. Touch [Edit].



7. Select the desired item to change.

Available settings

- [Entry #]:

Changes the displayed number of the selected entry.

- [Name]:

Edit the name of the entry using the keypad displayed on the screen.

- [Number]:
Edit the phone number using the keypad displayed on the screen.
- [Type]:
Select an icon from the icon list.

8. After finishing the setting, touch [OK].

PHONE SETTINGS

The Bluetooth® Hands-Free Phone System can be set in detail according to the user's preference.

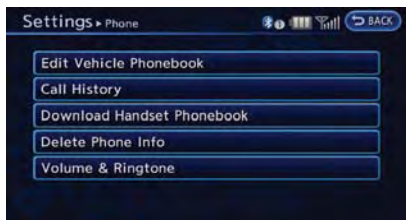

1. Push the **MENU** button and touch [Settings].
2. Touch [Phone & CARWINGS].
3. Touch [Phone].
4. Touch the item you would like to set.

Available settings

- [Edit Vehicle Phonebook]:
Phonebook registration and editing/deleting the registered phonebook can be performed.
- [Call History]:
The call history lists of the incoming calls and outgoing calls are displayed. The phone numbers that are stored in the incoming or outgoing history lists can be registered.
- [Download Handset Phonebook]:
Phonebook data should be registered in the system after downloading the phonebook from a cellular phone that is connected to the vehicle. A maximum of 5 phonebook can be registered from cellular phones.
- [Delete Phone Info]:
The phone information (phonebook or history) can be deleted all at the same time or one by one.
- [Volume & Ringtone]:
Adjust various phone volume settings.

Downloading phonebook memory

1. Push the **MENU** button and touch [Settings].

2. Touch [Phone & CARWINGS].
3. Touch [Phone].



4. Touch [Download Handset Phonebook].



5. Touch the method for downloading the phonebook memory. A message screen is displayed.

Available methods

- [Download Entire Phonebook]:
All of the phone numbers that are stored in a phonebook of a cellular phone that is

connected to the vehicle are downloaded at once.

- [Download 1 Entry]:

Each of the phone numbers that are stored in the phonebook of a cellular phone that is connected to the vehicle is downloaded one by one.

- [Downloaded List]:

The downloaded phonebook data is displayed.



6. Touch [Yes].



7. When a PIN code appears on the screen, operate the connected cellular phone to enter the PIN code. The downloading procedure of the cellular phone varies according to each cellular phone. See the cellular phone Owner's Manual for the details.

Deleting phone information

1. Push the **MENU** button and touch [Settings].
2. Touch [Phone & CARWINGS].
3. Touch [Phone].



4. Touch [Delete Phone Info].



5. Touch the preferred item for deletion. A confirmation message is displayed.

Items that can be deleted

- [Vehicle Phonebook]:
Deletes all or one of the phone number in the vehicle phonebook.
- [Call History]:
All or each of the calls listed in the outgoing and incoming call history will be deleted. Additionally, the calls can be deleted after sorting by outgoing or incoming call history.
- [Downloaded Phonebook from Handset]:
Deletes all or one of the phone numbers in the downloaded phonebook.
- [Memory]:
Deletes all stored memories (vehicle phonebooks, call logs and downloaded phonebooks).



6. Confirm the contents of the message, then touch [Yes].

Phone volume settings



1. Push the **MENU** button and touch [Settings].
2. Touch [Phone & CARWINGS].
3. Touch [Phone].
4. Touch [Volume & Ringtone].

5. Touch the item you would like to set.

Available settings

- [Ringtone]:
Adjust the volume level of the ringtone by touching [+] or [-].
- [Incoming Call]:
Adjust the incoming call volume by touching [+] or [-].
- [Outgoing Call]:
Adjust the outgoing call volume by touching [+] or [-].
- [Automatic Hold]:
When this function is activated, an incoming phone call is automatically held.
- [Vehicle Ringtone]:
When this function is activated, a specific ringtone that is different from that of the cellular phone will sound when receiving a call.

CAR PHONE or CB RADIO

When installing a car phone or a CB radio in your vehicle, be sure to observe the following cautions, otherwise the new equipment may adversely affect the electronic control modules and electronic control system harness.

WARNING

- **A cellular phone should not be used for any purpose while driving so full attention may be given to vehicle operation. Some jurisdictions prohibit the use of cellular phones while driving.**
- **If you must make a call while your vehicle is in motion, the hands-free cellular phone operational mode is highly recommended. Exercise extreme caution at all times so full attention may be given to vehicle operation.**
- **If a conversation in a moving vehicle requires you to take notes, pull off the road to a safe location and stop your vehicle before doing so.**

 **CAUTION**

- **Keep the antenna as far away as possible from the electronic control modules.**
- **Keep the antenna wire more than 8 in (20 cm) away from the electronic control system harness. Do not route the antenna wire next to any harness.**
- **Adjust the antenna standing-wave ratio as recommended by the manufacturer.**
- **Connect the ground wire from the CB radio chassis to the body.**
- **For details, consult a NISSAN certified LEAF dealer.**

MEMO

8 Voice recognition

NISSAN voice recognition	8-2	Voice command examples	8-3
Using Voice Recognition System	8-2	Displaying command list	8-6
Before starting	8-2	Voice recognition settings	8-8
Giving voice commands	8-2		

NISSAN VOICE RECOGNITION

USING VOICE RECOGNITION SYSTEM

Initialization

When the power switch is pushed to the "ON" position, Voice Recognition is initialized, which takes a few seconds. When completed, the system is ready to accept voice commands. If the  button on the steering wheel is pushed before the initialization completes, the display will show the message: "Loading Voice Recognition system. Please wait...".

BEFORE STARTING



To get the best recognition performance from Voice Recognition, observe the following items.

- The interior of the vehicle should be as quiet as possible. Close the windows to eliminate the surrounding noises (traffic noise and vibration sounds, etc.), which may prevent the system from correctly recognizing the voice commands.
- Wait until the tone sounds before speaking a command.
- Speak in a natural conversational voice without pausing between words.

GIVING VOICE COMMANDS

1. Push the  button located on the steering wheel.









2. A list of commands appears on the screen, and the system provides the voice menu prompt "Would you like to access Phone or Navigation?".
3. After the tone sounds and the icon on the screen changes from  to , speak a command.
4. Continue to follow the voice menu prompts and speak after the tone sounds until the preferred operation is completed.

Operating tips

- Speak a command after the tone.
- Commands that are available are always shown on the display and spoken through voice menu prompts. Commands other than those that are displayed are not accepted.

Follow the prompts given by the system.

- If the command is not accepted, the system announces, "Please say again". Repeat the command in a clear voice.
- Push the  button once to return to the previous screen.
- To cancel the command, push and hold the  button or the  button on the steering wheel. The message, "Voice recognition is canceled" will be announced.
- Push the  button on the steering wheel to stop the voice prompt and give the command at once. Remember to wait for the tone before speaking.
- To adjust the volume of the system feedback, push the   button on the steering wheel or use the audio system volume control knob while the system is making an announcement.

How to speak numbers

NISSAN Voice Recognition requires the user to a certain speak numbers in a certain way when giving voice commands. Refer to the following examples.

General rule:

Only single digits 0 (zero) to 9 can be used. (For example, if speaking 500, "five zero zero" can be used, but "five hundred" cannot.)

Examples:

1-800-662-6200

"One eight zero zero six six two six two zero zero"

Improving Recognition of Phone numbers:

Recognition of phone numbers can be improved by speaking the phone number in 3 groups of numbers. For example, to call 800-662-6200, speak "Eight Zero Zero" first, and the system will then ask to speak the next three digits. Then, speak "Six Six Two". After recognition, the system will then ask to speak the last 4 digits. Speak, "Six Two Zero Zero". Using this method of phone number digit entry can improve recognition performance.



INFO:

For best recognition, speak "zero" for the number "0" and "oh" for the letter "o".

VOICE COMMAND EXAMPLES

To use the voice recognition function, speaking one command is sometimes sufficient, but at other times it is necessary to speak two or more commands.

As examples, some additional basic operations that can be performed by voice commands are described here.

Example 1: Setting destination by address book

1. Push the  button located on the steering wheel.



2. The system announces, "Would you like to access Phone or Navigation?".
3. Speak "Navigation".



4. Speak "Address Book".

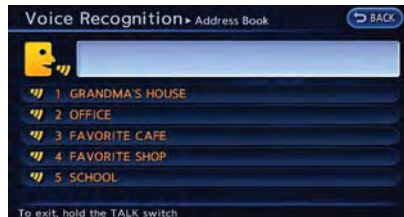

5. Voice feedback will be provided when the command is accepted, and the list of address book is displayed.
6. After the tone sounds and the icon on the screen changes again, speak "Two".



7. Voice feedback will be provided when the command is accepted, and the system starts calculating a route to the selected location.

Example 2: Placing call to phone number 800-662-6200

1. Push the  button located on the steering wheel.



2. The system announces, "Would you like to access Phone or Navigation?".

3. Speak "Phone".



4. Speak "Dial Number".



5. Speak "800".



6. The system announces, "Please say either the next three digits, dial, or say change number". Speak "662".



7. The system announces, "Please say the last four digits or say change number". Speak "6200".



8. The system announces, "Dial or Change Number?". Speak "Dial".



9. The system makes a call to 800-662-6200.

INFO:

- If the area code is not required, speaking "800-662-6200" (10 continuous digits) or "662-6200" (7 continuous digits) is acceptable. However the 3-3-4 digit grouping is recommended for improved recognition.
 "How to speak numbers" (page 8-2)
- The NISSAN voice recognition system is not limited to recognizing phone numbers of only 7 or 10 digits. To dial a number in a format other than the 3-3-4 digit grouping, use the "International Call" command.
- If "Change Number" is spoken during phone number entry, the system will automatically request that the number be repeated using the 3-3-4 format. In this case please speak the area code first and then follow the prompts. Do not add a "1" in front of the area

code when speaking phone numbers.

- If the system does not recognize a voice command, please try repeating the command using a natural voice. Speaking too slowly or too loudly may further decrease recognition performance.

Example 3: Placing international call to phone number 011-81-111-222-333

1. Push the  button located on the steering wheel.



2. The system announces, "Would you like to access Phone or Navigation?".
3. Speak "Phone".



4. Speak "International Call".



5. Speak "01181111222333".



6. Speak "Dial".



7. The system makes a call to 011-81-111-222-333.

INFO:

Any digit input format is available in the International Number input process.

DISPLAYING COMMAND LIST

When controlling the system by voice commands for the first time or if an appropriate voice command is unknown, confirm operation using the voice command lists.

1. Push the **MENU** button and touch [Info.].
2. Touch [Voice Recognition].



3. Touch [Command list]. The command list is displayed.

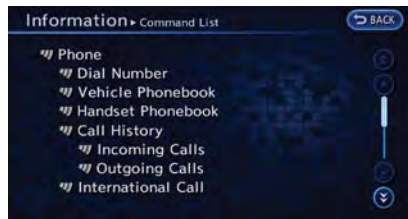

4. To confirm the list, scroll the screen using the touch panel operation.
5. Touch [BACK] to return to the previous screen.

Command List

The words in *italics* are variable.

Phone Command:

Command		Action
Dial Number		Makes a call to a spoken phone number.
Vehicle Phonebook		Makes a call to a contact that is stored in the Vehicle Phonebook.
Handset Phonebook		Makes a call to a contact that is stored in the cellular phone.
Call History	Incoming Calls	Makes a call to the incoming call number.
	Outgoing Calls	Makes a call to the dialed number.
International Call		Makes an international call by allowing more than 10 digits to be spoken.
Call <i><name></i>		Makes a call to a contact that is stored in Handset Phonebook. Please say "Call" followed by a stored name.

Navigation Command:

Command	Action
Home	Sets a route to your home location.
Address Book	Sets a route to a location stored in the Address Book.
Previous Destinations	Sets a route to a previously entered destination.

VOICE RECOGNITION SETTINGS

Detailed settings for use of the voice recognition function can be performed.



1. Push the **MENU** button and touch [Settings].
2. Touch [Others].
3. Touch [Voice Recognition].
4. Touch the item you would like to set.

Available settings

- [Command List]:
Displays the voice command list.
☞ "Displaying command list" (page 8-6)
- [Direct Command Mode]:
Switch the voice command mode from the Standard Mode to the Direct Command Mode. The Standard Mode is the factory default setting.
When [Direct Command Mode] is touched,

a confirmation message displays. If [Yes] is touched, the indicator illuminates and the Direct Command Mode switches to on.

When the Direct Command Mode is not selected, the system recognizes only the commands listed on the screen. When the Direct Command Mode is selected, the system recognizes the commands that should be performed in the following steps, in addition to the commands listed on the current screen.

- [Minimize Voice Feedback]:
It is possible to select two modes, long or short, for the announcement made by the system.
When [Minimize Voice Feedback] is touched, the indicator illuminates and the system announcement mode switches to the short mode.
- [Confirm Voice Commands]:
After speaking a command, the system requests the user to confirm that the recognized command by the system is correct. The confirmation function is set to off as the default setting.
When the system recognizes a command, a confirmation message is displayed on the screen. If the message correctly matches your command, say "Yes" and continue the

voice command operation. If the message is incorrect, say "No" and return to the previous screen.

MEMO

MEMO

9 Monitor system (if so equipped)

RearView monitor.....	9-2	How to park with predicted course lines	9-4
How to read displayed lines	9-2	Camera settings	9-6
About RearView Monitor	9-3		

REARVIEW MONITOR

When the selector lever is shifted into the "R" (Reverse) position, the monitor display shows the view to the rear of the vehicle.

The system is designed as an aid to the driver in detecting large stationary objects to help avoid damaging the vehicle. The system will not detect small objects below the bumper and may not detect objects close to the bumper or on the ground.

WARNING

- **The RearView Monitor is a convenience but it is not a substitute for proper backing up. Always turn and check that it is safe to do so before backing up. Always back up slowly.**
- **Objects viewed in the RearView Monitor differ from actual distance because a wide-angle lens is used. Objects in the RearView Monitor will appear visually opposite like ones viewed in the inside and outside mirrors.**
- **Make sure that the rear hatch is securely closed when backing up.**
- **Underneath the bumper and the corner areas of the bumper cannot be viewed on the RearView monitor**

because of its monitoring range limitation.

- **Do not put anything on the camera.**
- **When washing the vehicle with high-pressure water, be sure not to spray it around the camera. Otherwise, water may enter the camera unit causing water condensation on the lens, a malfunction, fire or an electric shock.**
- **Do not strike the camera. It is a precision instrument. Otherwise, it may malfunction or cause damage resulting in a fire or an electric shock.**

CAUTION

There is a plastic cover over the camera. Do not scratch the cover when cleaning dirt or snow from the cover.

HOW TO READ DISPLAYED LINES

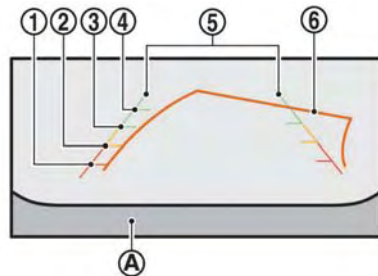

Guiding lines which indicate the vehicle width and distances to objects with reference to the bumper line (A) are displayed on the monitor.

Distance guide lines:

Indicate distances from the bumper.

- Red line ① : approx. 1.5 ft (0.5 m)
- Yellow line ② : approx. 3 ft (1 m)
- Green line ③ : approx. 7 ft (2 m)
- Green line ④ : approx. 10 ft (3 m)

Vehicle width guide lines ⑤ :

Indicate the vehicle width when backing up.

Predicted course lines ⑥ :

Indicate the predicted course when backing up. The predicted course lines will be displayed on the monitor when the selector lever is in the "R"

(Reverse) position and the steering wheel is turned. The predicted course lines will move depending on how much the steering wheel is turned and will not be displayed while the steering wheel is in the neutral position.

How to adjust RearView screen

To adjust the Brightness, Tint, Color, Contrast and Black Level of the RearView Monitor.

1. Push the **MENU** button with the RearView Monitor on.
2. Touch [Display].
3. Touch the preferred setting items.

Do not adjust the Brightness, Tint, Color, Contrast and Black Level of the RearView Monitor while the vehicle is moving.

ABOUT REARVIEW MONITOR

Difference between predicted and actual distances

The distance guide line and the vehicle width guide line should be used as a reference only when the vehicle is on a level, paved surface. The distance viewed on the monitor is for reference only and may be different from the actual distance between the vehicle and displayed objects.

Backing up on a steep uphill:

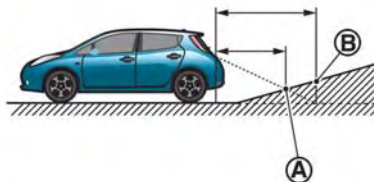
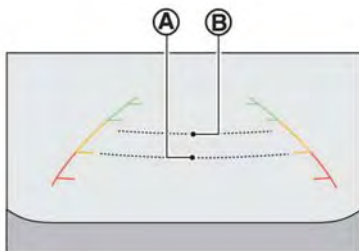

When backing up the vehicle up a hill, the distance guide lines and the vehicle width guide lines are shown closer than the actual distance. For example, the display shows 3 ft (1.0 m) to the place **(A)**, but the actual 3 ft (1.0 m) distance on the hill is the place **(B)**. Note that any object on the hill is further than it appears on

the monitor.

Backing up on a steep downhill:

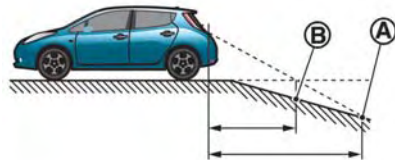
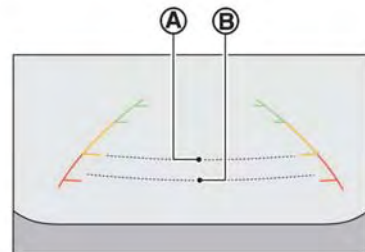

When backing up the vehicle down a hill, the distance guide lines and the vehicle width guide lines are shown further than the actual distance. For example, the display shows 3 ft (1.0 m) to the place **(A)**, but the actual 1.0 m (3 ft)

distance on the hill is the place (B). Note that any object on the hill is closer than it appears on the monitor.

Backing up near a projecting object:

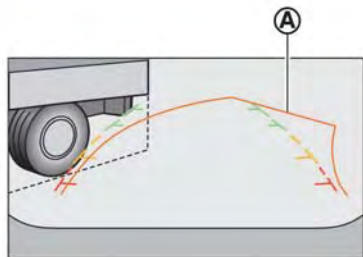

The predicted course lines (A) do not touch the object in the display. However, the vehicle may hit the object if it projects over the actual

backing up course.

Backing up behind a projecting object:

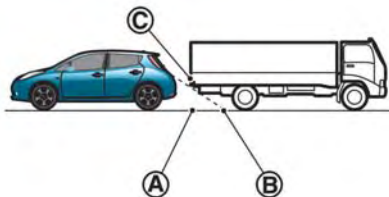
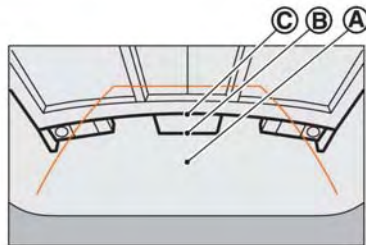

The position (C) is shown further than the position (B) in the display. However, the position (C) is actually at the same distance as the position (A). The vehicle may hit the object when backing up to the position (A) if

the object projects over the actual backing up course.

HOW TO PARK WITH PREDICTED COURSE LINES

⚠ WARNING

- Always turn and check that it is safe to park your car before backing up. Always back up slowly.
- Use the displayed lines as a reference. The lines are highly affected by the number of occupants, vehicle position, road condition and road grade.
- If the tires are replaced with different sized tires, the predicted course line may not be displayed correctly.
- On a snow-covered or slippery road, there may be a difference between the predicted course line and the actual course line.
- If the battery is disconnected or becomes discharged, the predicted course lines may not be displayed correctly. If this occurs, perform the following procedures.

— Turn the steering wheel from lock to lock while the READY to drive indicator light is ON.

— Drive the vehicle on a straight road for more than 5 minutes.

- When the steering wheel is turned with the power switch in the ACC position, the predicted course lines may be displayed incorrectly.
- The distance guide line and the vehicle width guide line should be used as a reference only when the vehicle is on a level paved surface. The distance viewed on the monitor is for reference only and may be different than the actual distance between the vehicle and displayed objects.
- When backing up the vehicle up a hill, objects viewed in the monitor are further than they appear. When backing up the vehicle down a hill, objects viewed in the monitor are closer than they appear. Use the inside mirror or glance over your shoulder to properly judge distances to other objects.

The vehicle width and predicted course lines are wider than the actual width and course.

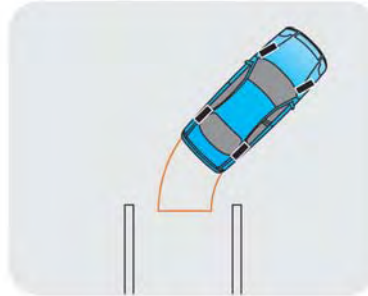
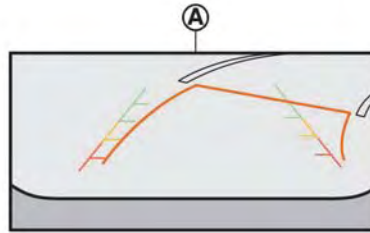

1. Visually check that the parking space is safe before parking your vehicle.
2. The RearView of the vehicle is displayed on the screen (A) as illustrated when the selector lever is moved to the "R" (Reverse)

position.

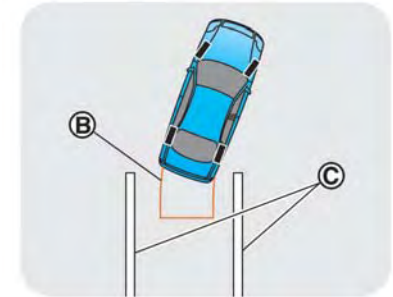
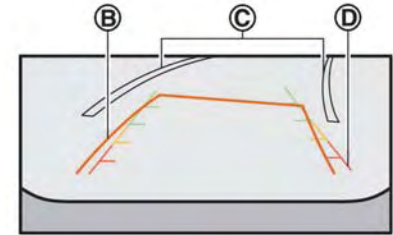

3. Slowly back up the vehicle, adjusting the steering wheel so that the predicted course lines (B) enter the parking space (C) .
4. Maneuver the steering wheel to make the vehicle width guide lines (D) parallel to the parking space (C) while referring to the predicted course lines.

- When the vehicle is parked in the space completely, push the "P" (Park) button and apply the parking brake.

Operating tips

- When the selector lever is shifted to the "R" (Reverse) position, the monitor screen automatically changes to the RearView Monitor mode.
- It may take some time until the RearView Monitor is displayed after the selector lever has been shifted to "R" from another position or to another position from "R". Objects may be distorted momentarily until the RearView Monitor screen is displayed completely.
- When the temperature is extremely high or low, the screen may not clearly display objects. This is not a malfunction.
- When strong light directly enters the camera, objects may not be displayed clearly. This is not a malfunction.
- Vertical lines may be seen in objects on the screen. This is due to strong reflected light from the bumper. This is not a malfunction.
- The screen may flicker under fluorescent light. This is not a malfunction.

- The colors of objects on the RearView Monitor may differ somewhat from those of the actual object.
- Objects on the monitor may not be clear in a dark place or at night. This is not a malfunction.
- If dirt, rain or snow attaches to the camera, the RearView Monitor may not clearly display objects. Clean the camera.
- Do not use alcohol, benzene or thinner to clean the camera. This will cause discoloration. To clean the camera, wipe with a cloth dampened with diluted mild cleaning agent and then wipe with a dry cloth.
- Do not damage the camera as the monitor screen may be adversely affected.
- Do not use wax on the camera window. Wipe off any wax with a clean cloth dampened with mild detergent diluted with water.

CAMERA SETTINGS

Display of predicted course lines can be set to ON or OFF.



If the rearview monitor is not in operation, set according to the following procedure.

- Push the **MENU** button and touch [Settings].
- Touch [Others].
- Touch [Camera].
- Touch [Predictive Course Lines]. The indicator illuminates when the item is set.

If the rearview monitor is in operation, set according to the following procedure.

- Push the **MENU** button
- Touch [Predictive Course Lines]. The indicator illuminates when the item is set.

MEMO

MEMO

10 Troubleshooting guide/General system information

Troubleshooting guide	10-2	General system information.....	10-27
Customer assistance	10-2	Current vehicle location	10-27
System unit.....	10-2	Route calculation	10-30
Unique EV functions	10-4	Route guidance.....	10-32
Navigation	10-8	Notes on XM NavTraffic® information.....	10-36
CARWINGS™	10-15	Map data.....	10-36
Audio system	10-16	How to handle display.....	10-40
Bluetooth® Hands-Free Phone System	10-22	How to handle the SD card	10-41
Voice recognition	10-25	How to handle CD and USB memory	10-41
Monitor system (if so equipped)	10-26		



TROUBLESHOOTING GUIDE

CUSTOMER ASSISTANCE

For assistance or inquiries about the NISSAN Navigation System, or to order updated map data, contact the NISSAN NAVIGATION SYSTEM HELPDESK. See the contact information on the inside front cover of this manual.

SYSTEM UNIT

Liquid crystal display

Symptom	Possible cause	Possible solution
The screen is too dark.	The cabin temperature is too low.	Wait until the cabin temperature becomes moderate.
	Screen brightness is set to the maximum darkness.	Adjust the brightness setting of the screen.  "Brightness" (page 1-15)
The screen is too bright.	Screen brightness is set to the maximum brightness.	Adjust the brightness setting of the screen.  "Brightness" (page 1-15)
A small black spot or a small bright spot appears on the screen.	This is a typical phenomenon for liquid crystal displays.	This is not a malfunction.
A dot or stripe pattern appears on the screen.	Electromagnetic waves that are generated from neon billboards, high voltage electric power cables, ham radios or other radio devices equipped to other vehicles may adversely affect the screen.	This is not a malfunction.
Image lag appears on the screen.	This is a typical phenomenon for liquid crystal displays.	This is not a malfunction.
Image motion displayed on the screen is slow.	The cabin temperature is less than 50°F (0°C).	Wait until the cabin temperature rises to within 50°F (0°C) and 122°F (50°C).
When looking at the screen from an angle, the screen lightens or darkens.	This is a typical phenomenon for liquid crystal displays.	Adjust the brightness setting of the screen.  "Brightness" (page 1-15)

SD card memory

Symptom	Possible cause	Possible solution
The screen turns blue or an error message is displayed.	A system malfunction has occurred.	Contact a NISSAN certified LEAF dealer for an inspection.

UNIQUE EV FUNCTIONS

Driving range

Symptom	Possible cause	Possible solution
The driving range cannot be displayed.	The power switch is in the "ACC" position.	The driving range can be displayed when the power switch is in the "ON" position or when the READY to drive indicator light is on.
	It cannot be displayed because the distance to empty is too short.	Charge the battery. Once the distance to empty increased it will be displayed.
The driving range is displayed in an oval shape.	As a result of the system correcting latitude and longitude, it may not be displayed as a circle.	This is not a malfunction.
The distance to empty that is displayed in the lower left hand side of the driving range and the scale of the map do not match.	As the map is displayed in 2D, the distance to empty may differ from the actual distance on the road.	This is not a malfunction. Drive using the numerical value on the lower left hand side of the screen as a guide.

Charging stations

Symptom	Possible cause	Possible solution
The charging station icon display setting is off but icons are still displayed on the map.	The charging station displayed has been set as a stored location.	This is not a malfunction.
I searched for charging stations because charge recommendation guidance and the low battery warning were displayed, but I could not find any.	In an area where the number of charging stations is low, it may not be possible to find a charging station located near the vehicle.	This is not a malfunction.
Charging station information is not displayed.	Information is not provided for all charging stations, so there may be cases when information is not displayed.	This is not a malfunction. Contact charging stations beforehand by phone to confirm whether they can be used.
Quick charging stations are not displayed.	[Quick Charge] may be set to OFF in the [Charging Port Types to Include in Station Searches] setting.	Set [Quick Charge] to ON.  "Unique EV function settings" (page 2-13)
The charging station information displayed is incorrect.	The map data is old.	Connect to the NISSAN CARWINGS Data Center and update charging station information. Alternatively, purchase new map data and update the system.
I went to the charging station that I searched for but the information was incorrect and I could not charge the battery.	The map data is old.	Connect to the NISSAN CARWINGS Data Center and update charging station information. Alternatively, purchase new map data and update the system.
	Charging station facilities have changed, or the EVSE (Electric Vehicle Supply Equipment) equipped cannot be used.	Contact the charging station by phone beforehand to check whether facilities can be used.

Energy information display

Symptom	Possible cause	Possible solution
The instant value shown on the energy economy information continues to show the maximum value.	This is due to power stored by the cooperative regenerative brake being used.	Battery power is stored by the cooperative regenerative brake while driving. While this occurs, the instant value will be displayed as the maximum. The maximum value will be displayed until the regenerated power is consumed.
The driving range increase/decrease when the air conditioner/heater is ON/OFF that is displayed in the energy usage information screen is displayed as +0 mile (+0 km) or -0 mile (-0 km).	The power used for the air conditioner/heater will decrease in response to the power used by the traction motor and the increase/decrease difference of the driving range will be under ± 1 mile (± 1 km). Also, when the Li-ion battery available charge is low, the increase/decrease of the driving range will also become smaller.	This is not a malfunction.

Timer function



Symptom	Possible cause	Possible solution
Charging does not start at the time set.	Timer charge has not been set to ON.	Check on the timer charge screen whether the indicator for [Timer 1] or [Timer 2] is on.
	The EVSE (Electric Vehicle Supply Equipment) is not connected correctly.	Check that the EVSE (Electric Vehicle Supply Equipment) is connected correctly.
	The immediate charge switch is in the ON position.	Check the immediate charge switch setting.
	The power switch is in the ON position.	Place the power switch in the OFF position when setting timer charge.
The air conditioner or heater does not operate at the time set.	The Climete Ctrl. Timer is not set to ON.	On the Climete Ctrl. Timer screen, check whether the [Timer 1] or [Timer 2] indicator is on.
	The EVSE (Electric Vehicle Supply Equipment) is not connected correctly to the vehicle.	Check whether the EVSE (Electric Vehicle Supply Equipment) is connected correctly to the vehicle.
	Timer charge priority is set and the battery will be charged while the Li-ion battery available charge gauge has not reached the full mark.	Check the Climete Ctrl. Timer priority setting.
	The power switch is in the ON position.	Place the power switch in the OFF position when setting timer charge.
The Climate Ctrl. Timer does not operate immediately.	If the departure time set has not yet been reached, or if the departure time set is after Climate Ctrl. Timer has operated.	This is not a malfunction.
The timer charge or Climate Ctrl. Timer screen cannot be displayed.	The power switch is in the "ACC" position.	This screen can be displayed when the power switch is placed in the "ON" position or when the READY to drive indicator light is on.
A message prompting me to update the time setting is displayed.	The system clock has not been set correctly.	Set the time setting correctly.
Days when you do not want the timer function to operate cannot be set.	All timer functions are set to ON.	Turn off the setting for days where the timer function is not required.

NAVIGATION

Basic operations

Symptom	Possible cause	Possible solution
No image is displayed.	The brightness is at the lowest setting.	Adjust the brightness of the display.
	The display is turned off.	Push the */> button to turn on the display.
No voice guidance is available. or The volume is too high or too low.	The volume is not set correctly, or it is turned off.	Adjust the volume of voice guidance.
	Voice guidance is not provided for certain streets (roads displayed in gray).	This is not a malfunction.
No map is displayed on the screen.	A screen other than map screen is displayed.	Push the MAP button.
The screen is too dim. The movement is slow.	The temperature in the interior of the vehicle is low.	Wait until the interior of the vehicle has warmed up.
Some pixels in the display are darker or brighter than others.	This condition is an inherent characteristic of liquid crystal displays.	This is not a malfunction.
Some menu items cannot be selected.	Some menu items become unavailable while the vehicle is driven.	Park the vehicle in a safe location, and then operate the navigation system.

Vehicle icon

Symptom	Possible cause	Possible solution
Names of roads and locations differ between Plan View and Birdview™.	This is because the quantity of the displayed information is reduced so that the screen does not become too cluttered. There is also a chance that names of the roads or locations may be displayed multiple times, and the names appearing on the screen may be different because of a processing procedure.	This is not a malfunction.
The vehicle icon is not displayed in the correct position.	The vehicle was transported after the power switch was pushed off, for example, by a ferry or car transporter.	Drive the vehicle for a period of time on a road where GPS signals can be received.
	The position and direction of the vehicle icon may be incorrect depending on the driving environments and the levels of positioning accuracy of the navigation system.	This is not a malfunction. Drive the vehicle for a period of time to automatically correct the position and direction of the vehicle icon.  "Current vehicle location" (page 10-27)
When the vehicle is traveling on a new road, the vehicle icon is located on another road nearby.	Because the new road is not stored in the map data, the system automatically places the vehicle icon on the nearest road available.	Updated road information will be included in the next version of the map data.
The screen does not switch to the night screen even after turning on the headlights.	The daytime screen was set the last time the headlights were turned on.	Set the screen to the night screen mode using the  button when turning on the headlights.  "Display adjustment" (page 1-14)
The map does not scroll even when the vehicle is moving.	The current location map screen is not displayed.	Push the MAP button.
The vehicle icon is not displayed.	The current location map screen is not displayed.	Push the MAP button.
The GPS indicator on the screen remains gray.	GPS signals cannot be received under certain conditions, such as in a parking garage, on a road with many tall buildings, etc.	Drive on an open, straight road for a period of time.
	GPS signals cannot be received because objects are placed on the instrument panel.	Remove the objects from the instrument panel.
	A sufficient number of GPS satellites is not available.	Wait for the satellites to move to locations available for the navigation system.

Symptom	Possible cause	Possible solution
The location of the vehicle icon is misaligned from the actual position.	When using tire chains or replacing the tires, speed calculations based on the speed sensor may be incorrect.	Drive the vehicle for a period of time (at approximately 19 MPH (30 km/h) for about 30 minutes) to automatically correct the vehicle icon position. If this does not correct the vehicle icon position, contact your NISSAN certified LEAF dealer.
	The map data has a mistake or is incomplete (the vehicle icon position is always misaligned in the same area).	Updated road information will be included in the next version of the map data.

Route calculation and visual guidance

Symptom	Possible cause	Possible solution
Waypoints are not included in the auto reroute calculation.	Waypoints that have been already passed are not included in the auto reroute calculation.	To go to that waypoint again, edit the route.
Route information is not displayed.	Route calculation has not yet been performed.	Set the destination and perform route calculation.
	The vehicle is not on the suggested route.	Drive on the suggested route.
	Route guidance is set to OFF.	Turn on route guidance.
	Route information is not provided for certain types of roads (roads displayed in dark green).	This is not a malfunction.
The auto reroute calculation (or detour calculation) suggests the same route as the one previously suggested.	Route calculations took priority conditions into consideration, but the same route was calculated.	This is not a malfunction.
A waypoint cannot be added.	Five waypoints are already set on the route, including ones that the vehicle has already passed.	A maximum of 5 waypoints can be set on the route. To go to 6 or more waypoints, perform route calculations multiple times as necessary.
	[Calculate] must be selected for route calculation after Waypoints are selected from the "Edit/Add to Route" screen.	Touch [Calculate] after selecting waypoints.
The suggested route is not displayed.	Roads near the destination cannot be calculated.	Reset the destination to a main or ordinary road, and recalculate the route.
	The starting point and destination are too close.	Set a more distant destination.
	The starting point and destination are too far away.	Divide the trip by selecting one or two intermediate destinations, and perform route calculations multiple times.
	There are time restricted roads (by the day of the week, by time) near the current vehicle location or destination.	Set [Use Time Restricted Roads] to OFF.  "Setting conditions for route calculation" (page 3-52)
A part of the route is not displayed.	The suggested route includes narrow streets (roads displayed in gray).	This is not a malfunction.
The part of the route that the vehicle has already passed is deleted.	A route is managed by sections between waypoints. If the vehicle passed the first waypoint, the section between the starting point and the waypoint is deleted (it may not be deleted depending on the area).	This is not a malfunction.

Symptom	Possible cause	Possible solution
An indirect route is suggested.	If there are restrictions (such as one-way streets) on roads close to the starting point or destination, the system may suggest an indirect route.	Adjust the location of the starting point or destination.
	The system may suggest an indirect route because route calculation does not take into consideration some areas such as narrow streets (gray roads).	Reset the destination to a main or ordinary road, and recalculate the route.
The landmark information does not correspond to the actual information.	This may be caused by insufficient or incorrect map data.	Updated information will be included in the next version of the map data.
The suggested route does not exactly connect to the starting point, waypoints, or destination.	There is no data for route calculation closer to these locations.	Set the starting point, waypoints and destination on a main road, and perform route calculation.



Voice guidance

Symptom	Possible cause	Possible solution
Voice guidance is not available.	Voice guidance is only available at certain intersections marked with  . In some cases, voice guidance is not available even when the vehicle makes a turn.	This is not a malfunction.
	The vehicle has deviated from the suggested route.	Go back to the suggested route or request route calculation again.
	Voice guidance is set to OFF.	Turn on voice guidance.
	Route guidance is set to OFF.	Turn on route guidance.
The guidance content does not correspond to the actual road conditions.	The content of voice guidance may vary, depending on the types of intersections at which turns are made.	Follow all traffic rules and regulations.

Traffic information

Symptom	Possible cause	Possible solution
Traffic information is not displayed.	Traffic information is not set to ON.	Set the traffic information to ON.
	The vehicle is in an area where traffic information is not available.	Scroll to an area where traffic information is available.
	The subscription to XM NavTraffic [®] is incomplete, or the subscription to XM NavTraffic [®] has expired.	Check the subscription status of XM NavTraffic [®] .
	The map scale is set at a level where the display of icons is impossible.	Check that the map scale is set at a level in which the display of icons is possible.  "Traffic information display and scale levels" (page 6-9)
With the automatic detour route search ON, no detour route is set to avoid congested areas.	There is no faster route compared to the current route, based on the road network and traffic information.	The automatic detour search is not intended for avoiding traffic jams. It searches for the fastest route taking into consideration conditions as traffic jams. Follow the current route. Also see "NOTES ON TRAFFIC INFORMATION" for further information.
The route does not avoid a road section with traffic information stating that it is closed due to road construction.	The navigation system is designed not to avoid this event because the actual period of closure may differ from the declared roadwork period.	Observe the actual road conditions and follow the instructions on the road for detour when necessary. If the road is closed, use the detour function and set the detour distance to avoid the road section that is closed.

CARWINGS™

Symptom	Possible cause	Possible solution
The system cannot connect to the NISSAN CARWINGS Data Center.	A subscription for the CARWINGS™ service has not been established.	Sign up for a subscription to the CARWINGS™ service. For details about subscriptions, contact a NISSAN certified LEAF dealer.
	The user ID and password are not entered.	Enter the user ID and password.  "Inputting user ID and password" (page 1-11)
	The communication line is busy.	Try again after a short period of time.
	The vehicle is in a location where it is difficult to receive radio waves.	When the vehicle moves to an area where radio waves can be transmitted sufficiently, communication will be restored. When the icon on the display shows that the vehicle is inside the communication area, the system can be used.
	TCU is not turned on.	If the icon does not show that the vehicle is inside the communication area despite the fact that the vehicle is in that location, contact a NISSAN certified LEAF dealer.
	Radio wave reception is not sufficient for TCU operation.	When the vehicle moves to an area where radio waves can be transmitted sufficiently, communication will be restored. When the icon on the display shows that the vehicle is inside the communication area, the system can be used.
	Communication may sometimes not be possible even when the network status is good.	Signing in again may restore the connection.
Some of the items that are displayed on the menu screen cannot be selected.	The vehicle is being driven and some menu items are disabled.	The vehicle is being driven. Stop the vehicle in a safe location and apply the parking brake before operating the functions.  "Functions disabled while driving" (page 1-6)
Some parts of the screen are not displayed.	The vehicle is being driven and some menu items are disabled.	Operate the system after stopping the vehicle in a safe location and applying the parking brake.  "Functions disabled while driving" (page 1-6)
The system does not announce information.	The volume level is set to the minimum.	Adjust the volume level by operating the VOL buttons located on the control panel or on the steering wheel switch while the system is announcing information.

AUDIO SYSTEM

Compact Disc (CD) player

Symptom	Possible cause	Possible solution
Music cannot be played back.	The disc is inserted upside down.	Insert a CD with the label side facing up.
	Moisture condensation occurs inside the unit.	Wait until the moisture evaporates. (approximately 1 hour)
	The cabin temperature is too high.	Wait until the cabin temperature becomes moderate.
	The disc is scratched or dirty. A disc is not always playable if it is scratched.	Wipe off any dirt from the disc.
	Depending on the condition in which they are stored, discs may become unreadable due to deterioration (for example, keeping the discs in the passenger compartment, etc.).	Change the disc with a deterioration-free disc. Do not use a deteriorated disc. The label surface of the disc may crack or chip, and the layer of the label surface may eventually peel off.
The compressed audio files cannot be played back.	If both music CD files (CD-DA data) and compressed audio files (MP3 data, etc.) are mixed on one disc, the audio compression files cannot be played back.	Prepare a disc that includes compressed audio files only.
	The files are not named using characters that are compliant with the specifications.	Use the character codes and the number of characters that are compliant with the specifications for folder names and file names. In addition, always use ".MP3", ".WMA", ".mp3" or ".wma" for file extensions.
It takes a long time before the music starts playing.	The disc contains a large amount of data.	Some time may be required to check the files. It is recommended that unnecessary folders or any files other than compressed audio files should not be recorded in a disc.
Sound quality is poor.	The disc is dirty.	Wipe off any dirt from the disc.
No sounds are played though CD play time is displayed.	The system plays back the first track of the mix mode disc. (Mix mode is a format in which data except music is recorded on the first track and music data is recorded on other than the first track in a session.)	Play back music data that are recorded on other than the first track.

Symptom	Possible cause	Possible solution
Music cuts off or skips.	The combination of writing software and hardware might not match; or the writing speed, writing depth, writing width, etc. might not match the specifications.	Create a disc using a different writing speed settings, etc.
The system skips the selected track and moves to the next track.	A non-MP3/WMA file is given an extension of ".MP3", ".WMA", ".mp3" or ".wma".	Prepare MP3/WMA files.
	The system plays back a file that is prohibited due to copyright protection.	Prepare playable files.
The tracks do not play back in the desired order.	The folder locations in the disc are changed by the writing software while the files are written in the disc.	Check the settings of the writing software, and create a new disc.

iPod® player

Symptom	Possible cause	Possible solution
The system does not recognize an iPod®.	A connector cable is not correctly connected, or the iPod® does not correctly operate.	Connect the connector cable again. If the system does not recognize the iPod® after performing this procedure above, reset the iPod®.
	The iPod® that is to be connected is not compatible with the system.	Check the iPod® model and firmware versions available for the system.
	A USB extension cable is not correctly connected.	Do not use a USB extension cable.
	The cable is rapidly connected to or disconnected from the USB connector.	Slowly connect or disconnect the USB cable.
An iPod® cannot be operated.	The iPod® is connected to the in-vehicle audio system while headsets, etc. are connected to the iPod®.	Remove all equipment from the iPod® after disconnecting the iPod® from the system, and then connect it to the system again.
	The iPod® is not operating normally.	Disconnect the iPod® from the in-vehicle audio system, and then connect it to the system again.
	The system plays back an album/track that includes a particular album art.	Disconnect the iPod® from the in-vehicle audio system, and then reset the iPod®. Disable the album art, and then connect the iPod® to the system.
An iPod® does not respond.	There are too many tracks in a category.	Decrease the number of tracks in a category (less than 3,000 tracks).
	The shuffle function is turned on.	Turn off the shuffle function if many tracks are stored on the iPod®.
Music cannot be played back.	A connector is not connected to the iPod®.	Firmly connect the connector until it clicks.
Playback cuts out.	The sound cuts due to vibration resulting from unstable location of the iPod®.	Place the iPod® on a stable location where it does not roll over.
Distorted sound occurs.	The EQ (equalizer) function of the iPod® is turned on.	Turn off the EQ (equalizer) function.
Battery charge of an iPod® takes longer.	Battery charge of the iPod® may take longer while an iPod® is playing back.	If the iPod® requires charging, it is recommended to stop play back.
Battery charge of an iPod® is unavailable.	The cable that is connected to the iPod® may deteriorate (cable disconnection, etc.).	Check the cable currently in use.

Symptom	Possible cause	Possible solution
Functions cannot be operated using an iPod® that is connected to the in-vehicle audio system.	-	The operation of an iPod® must be performed using the in-vehicle audio system after the iPod® is connected to the system.
Sound skips.	Surrounding circumstances (noise, etc.) may cause sound skip.	This does not indicate a malfunction.
	A USB extension cable is not correctly connected.	Do not use a USB extension cable.

USB memory

Symptom	Possible cause	Possible solution
The system does not recognize a USB device.	A USB extension cable is used.	Do not use a USB extension cable.
	A USB HUB is used.	Do not use a USB HUB.
	A USB device is rapidly connected to or disconnected from the USB connector.	Slowly connect or disconnect the USB device.

Bluetooth® streaming audio

Symptom	Possible cause	Possible solution
Registration cannot be performed.	The Bluetooth® audio device is not compatible with the in-vehicle audio system.	Check the Owner's Manual for the Bluetooth® audio device.
	The PIN code is incorrect.	Check the PIN code for the Bluetooth® audio device that is to be registered. Check that the PIN code for the Bluetooth® audio device is consistent with that for the in-vehicle audio system.
	Another Bluetooth® device is used in the vehicle.	Turn off another Bluetooth® device until the registration is completed.
Music cannot be played back.	The Bluetooth® audio device is not compatible with the in-vehicle audio system.	Check the Owner's Manual for the Bluetooth® audio device.
	The system is not set to the Bluetooth® audio mode.	Push the CD-AUX button to select the Bluetooth® audio mode.
	A Bluetooth® adapter is turned off.	Turn on a Bluetooth® adapter when it is used for a Bluetooth® audio device.
Playback stops.	The Bluetooth® audio device is not compatible with the in-vehicle audio system.	Check the Owner's Manual for the Bluetooth® audio device.
	A cellular phone is connected.	This is not a malfunction.
	Sound may cut out when a Bluetooth® audio device is operated.	Push the CD-AUX button to select the Bluetooth® audio mode, and then operate a function on the vehicle's display screen.
Audio operation cannot be performed.	Bluetooth® audio device that does not support audio operations is in use.	This is not a malfunction. Refer to the Owner's Manual of the Bluetooth® audio device.
	An error occurs when connecting to a Bluetooth® audio profile.	Turn the power source of the Bluetooth® audio player off and on, and then resume connection with the system.



BLUETOOTH® HANDS-FREE PHONE SYSTEM

Symptom	Possible cause	Possible solution
A cellular phone cannot be registered.	The cellular phone is not compatible with the in-vehicle hands free phone system.	Use a cellular phone compatible with the system. Visit the website (www.nissanusa.com/bluetooth) for model compatibility.
	Registration of the cellular phone has been performed incorrectly.	Check the registration procedure, and then register the cellular phone again.
A cellular phone cannot be connected or is disconnected after the registration is completed.	The Bluetooth® setting of the in-vehicle hands free phone system is turned off.	Turn on the Bluetooth® setting of the system.
	The Bluetooth® setting of the cellular phone is turned off.	Turn on the Bluetooth® setting of the cellular phone.
	The remaining battery level of the cellular phone is low.	Charge the battery of the cellular phone.
	The wireless Bluetooth® connection may be disrupted depending on the location of the cellular phone.	Do not place the cellular phone in an area surrounded by metal or far away from the in-vehicle hand free phone system. Do not place the cellular phone close to the seats or your body.
	Registration of the cellular phone is not completed.	Perform registration of the cellular phone.
A call to a particular phone number fails.	If the system tries to make a call several times to the same phone number (for example: the party does not respond to the call, the party is out of the service area, or the call is abandoned before the party responds), the system may reject a request to make a call to the phone number.	Turn off the cellular phone and turn it on again to reset the connection.
The system does not recognize the connection of a cellular phone. The system does not receive or make a call.	The cellular phone is not compatible with the in-vehicle hands free phone system.	Use a cellular phone compatible with the system. Visit the website (www.nissanusa.com/bluetooth) for model compatibility.
	The cellular phone is not connected.	Check the registration procedure, and then register the cellular phone again.
	The phone operation is limited by the functions (such as dial lock, etc.) of the registered cellular phone.	Remove any settings which are limiting use of the cellular phone, and then perform registration again.

Symptom	Possible cause	Possible solution
The other party cannot hear your voice. The other party can hear your voice, but it cracks or cuts out.	The cellular phone is not connected.	Check the registration procedure, and then register the cellular phone again.
	The fan speed of the air conditioner is too fast.	Decrease the fan speed of the air conditioner.
	The ambient noise level is excessive. (For example: heavy rain, construction sites, inside a tunnel, oncoming vehicles, etc.)	Close the windows to shut out ambient noise.
	The noise generated by driving the vehicle is too loud.	Reduce the vehicle speed, and then speak a command.
	The incoming or outgoing voice level is too loud.	Adjust the incoming or outgoing voice level properly.
	The voice is cut out or noise is heard during a call.	The wireless Bluetooth [®] connection may be disrupted depending on the location of the cellular phone.
Do not place the cellular phone in an area surrounded by metal or far away from the in-vehicle hands-free phone system. Do not place a cellular phone close to the seats or your body.		
When a cellular phone is operated to make a call, the hands-free function becomes unavailable.	Some models of a cellular phone do not switch to the hands-free mode when they are operated to make a call.	This is not a malfunction. Make a call again using the hands-free function.
The other party's voice cannot be heard. There is no ring tone.	The volume level is set to the minimum.	Adjust the volume level.
	A cellular phone is not connected.	Check the registration procedure, and then register the cellular phone again.
Each volume level (ring tone, incoming voice or outgoing voice) is different.	Each volume level is not adjusted properly.	Adjust each volume level properly.
The antenna display is different between the navigation screen and a cellular phone screen. Making or receiving a call is unavailable even though the antenna display that shows that it is possible to do so.	The antenna display varies depending on the model of cellular phone.	This does not indicate a malfunction. The antenna display and remaining battery level shown on the navigation screen may be different from those shown on the cellular phone screen. Use them as a reference.
A voice cannot be heard clearly when using a cellular phone behind tall buildings.	Some structures such as tall buildings, etc. may cause irregular reflection of radio waves or completely shut out radio waves that are used for cellular phones.	This is not a malfunction.

Symptom	Possible cause	Possible solution
Noise is heard when using a cellular phone under/near areas of elevated railroads, high voltage electric power cables, traffic signals, neon billboards, etc.	Electromagnetic waves that are generated from radio devices may adversely affect the cellular phone.	This is not a malfunction.
Noise is heard in the sound from the audio system while using a cellular phone.	Radio waves that are generated from a cellular phone may adversely affect the sound from the audio system.	This is not a malfunction.

VOICE RECOGNITION

Symptom	Possible cause	Possible solution
The system does not operate or fails to interpret the command correctly after speaking a voice command.	The system interprets the passenger's speech.	Ask the passenger to be as quiet as possible.
	The fan speed of the air conditioner is too fast.	Decrease the fan speed of the air conditioner.
	The ambient noise level is excessive. (For example: heavy rain, construction sites, inside a tunnel, oncoming vehicles, etc.)	Close the windows to shut out ambient noise.
	The noise generated by driving the vehicle is too loud.	Reduce the vehicle speed, and then speak the command.
	The voice command is spoken in a low voice.	Speak the command in a louder voice.
	The timing of speaking a command is too fast.	Speak the command after confirming the following: a voice guidance is announced, a tone sounds, and an icon on the screen changes from white to orange.
	The command is spoken too slowly.	Speak in a natural voice without pausing between words.
The system announces, "Please say again".	Pronunciation is unclear.	Speak clearly.
	The user starts speaking too late after the tone.	Speak the command within 5 seconds after confirming the following: a voice guidance is announced, a tone sounds, and an icon on the screen changes from white to orange.
	An improper command is spoken.	Speak the command or a number that is displayed in orange on the screen. Speak the command that is shown in the command list.
The system does not correctly recognize a number spoken.	Many numbers are spoken at once.	Place a pause between the appropriate digits for correct recognition by the system. When speaking a telephone number, place a pause between area codes, dial codes, etc.
Voice recognition does not operate and a tone sounds twice after pushing the  button.	The  button is pushed immediately after the READY to drive indicator light is ON.	Push the  button again after a short period of time.

MONITOR SYSTEM (if so equipped)

Symptom	Possible cause	Possible solution
The image on the display is not clear.	The front glass of the camera lens is dirty.	Gently wipe off the dirt with damp soft cloth.
	Moisture drops such as rain or snow form on the camera lens.	Gently wipe off the drops with soft cloth.
	Light such as sunlight or a headlight beam from another vehicle directly enters the camera.	This is not a malfunction. It will return normal when the light disappears.
	Moisture condensation occurs in the camera lens due to rapid temperature change.	This is not a malfunction. It will return normal after driving for a short period of time.
	Objects on the display may not be clear in a dark place or at night.	Adjust the brightness or the contrast settings of the screen.
The image on the display flickers.	The vehicle is under fluorescent light.	This is not a malfunction.
The colors of the object on the display look different from those of the actual object.	This is a typical phenomenon for cameras.	This is not a malfunction.
Image does not appear on the display.	The selector lever is not shifted to the "R" position.	Shift the selector lever to the "R" position.
The image appears on the display from the wrong angle.	The rear hatch opens.	Close the rear hatch.
Image on the display is not clearly visible.	Strong light or reflected light enters the camera.	This is not a malfunction.
Vertical lines appear on the image.	Strong reflected light from the bumper enters the camera.	This is not a malfunction.

GENERAL SYSTEM INFORMATION

CURRENT VEHICLE LOCATION

Display of current vehicle location

This navigation system combines the data obtained from the vehicle (by gyro sensor) and from GPS (Global Positioning System) satellites to calculate the current location of the vehicle. This position is then displayed throughout route guidance to a destination.

What is GPS (Global Positioning System)?

GPS is a position detecting system that uses satellites deployed by the U.S. government. This navigation system receives radio signals from three or more different satellites that orbit 13,049 miles (21,000 km) above the earth in space, and detects the position of the vehicle by utilizing the principle of triangulation.

Positioning adjustment:

When the system judges that the vehicle position is not accurate based on vehicle speed and gyro sensor data calculations, the system will automatically adjust the position of the vehicle icon using GPS signals.

Receiving signals from GPS satellites:

The reception of GPS signals can be weak, depending on the environment. Vehicles in the following areas/environments may not receive

GPS signals (indicator color: gray).



- Inside tunnels or parking garages



- In areas with numerous tall buildings

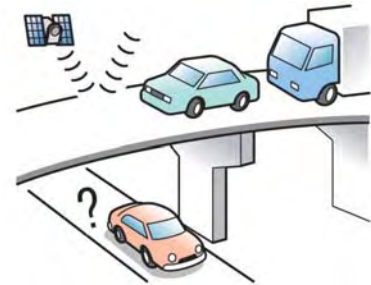

- Under multi-layered highways



- Areas with numerous tall trees



- In a canyon

INFO:

The GPS antenna is located on the instrument panel inside the vehicle. Do not place any objects, especially cellular phones or transceivers, on the instrument panel. Because the strength of the GPS signal is approximately one billionth of that of TV waves, phones and transceivers will affect or may totally disrupt the signal.

Display of GPS information:

GPS information can be displayed.

 "Viewing GPS current location information" (page 6-11)

Incorrect display of vehicle position

The following cases may affect the display accuracy of the vehicle's position or traveling direction. The accuracy will return to normal if the driving conditions return to normal.



- When there is a similar road nearby.



- When the vehicle is traveling in an area with a grid pattern road system.

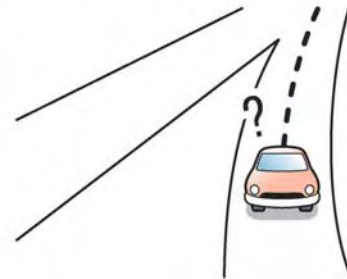

- When the vehicle is passing through a large Y-shaped intersection/junction.



- When the vehicle is traveling on a continuous, slowly curving road.



- When the vehicle is traveling on a road with repeating S-shaped curves.



- When the vehicle is on a snow-covered or unpaved road.



- When the vehicle is rotated on a parking lot turntable while the power switch is off.



- When the vehicle is on a loop bridge.



- When repeatedly turning left or right, or driving in zigzags.

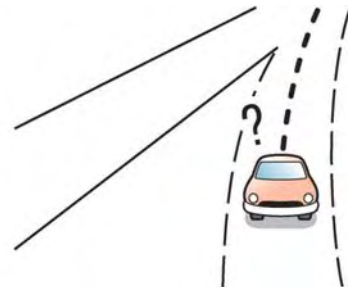

- When driving on a road not displayed on the map screen or a road that has been changed due to additional construction or other reasons.



- When the GPS positioning accuracy is low.

INFO:

- The vehicle icon may be misaligned when starting the vehicle just after the READY to drive indicator light is ON.
- The vehicle icon may also be misaligned if different sized tires or tire chains are installed.
- The system has a function that automatically corrects the vehicle icon position when it is misaligned from the actual position.
- Vehicle position correction by GPS may not function when the vehicle is stopped.
- If the vehicle icon position does not return to normal even after driving for a while, correct the vehicle icon position manually.

 "Adjusting current vehicle location"

Detailed Map Coverage Areas (MCA) for navigation system

This system is designed to help guiding to the destination, and it also performs other functions as outlined in this manual. However, the system must be used safely and properly. Information concerning road conditions, traffic signs and the availability of services may not always be up-to-date. The system is not a substitute for safe, proper and legal driving.

Map data covers select metropolitan areas in the United States and Canada.

Map data includes two types of areas: "Detailed coverage areas" providing all detailed road data and other areas showing "Main roads only".

INFO:

Detailed map data is not available in many areas and is generally limited to select major metropolitan areas.

When gray road is displayed on map

- When you are driving on a road displayed in gray after the vehicle has deviated from the suggested route during route guidance, automatic rerouting may not start immediately.

- The navigation system does not provide route guidance for roads displayed in dark green. Therefore, if the destination is set on a road displayed in dark green, the enlarged map display will return to the ordinary map screen at some point on a suggested route that is near the destination. Also, voice guidance will stop at some point on a suggested route that is near the destination.
- Places information and street names near roads displayed in gray may not be contained in the map data.

ROUTE CALCULATION

- There may be cases where carpool lanes are included on a suggested route when the automatic rerouting function is activated, even if the "Use Time Restricted Roads" is turned off.

 "Setting conditions for route calculation" (page 3-52)

- The navigation system does not provide route guidance for roads displayed in dark green.
- If the destination is set on a dark green road, the enlarged map display will switch to the ordinary map screen at some point and suggest a route that is near the destination. The distance and direction to the endpoint of the suggested route will be displayed in

the lower right corner of the screen. Also, at this time, voice guidance will announce, "The route to the destination includes roads through incomplete map areas. Voice guidance will not be provided in these areas."

When approaching the endpoint of the suggested route, voice guidance will announce, "Entering the road with incomplete map data. Use the direction arrow and distance information to proceed to your destination."

To reach the destination, refer to the map screen. Always follow actual roads and regulations and drive safely.

- The suggested route may not be the shortest, nor are other circumstances such as traffic jams considered.
- Because of the inevitable difference in road conditions and circumstances between the time you use this system and the time the information was produced for the map data, there may be discrepancies in roads and regulations. In such cases, follow the actual information available.
- During route calculation, the map will not scroll, however the vehicle icon will move with the actual vehicle's movement.
- During route calculation, buttons such as the **MAP** button and the **MENU** button will be disabled.
- In some cases, after the calculation is complete, the calculated route may not be immediately displayed.
- Waypoints that have been passed will be disregarded by rerouting calculation.
- If you scroll the map while the suggested route is being drawn, it may take more time to finish drawing.
- If waypoints are set, the system calculates multiple routes between waypoints simultaneously, and the following may result.
 - If one section between waypoints cannot be calculated, none of the route will be displayed.
 - The route may not connect completely at some waypoints.
 - The route may require a U-turn close to some waypoints.
- Route calculation may not be completed in the following cases.
 - If there is no main road within a range of 1.5 miles (2.5 km) from the vehicle, a message saying so will appear on the screen. Try recalculating when the vehicle is closer to a main road.

- If there is no main road within a range of 1.5 miles (2.5 km) from the destination or waypoint, a message saying so will appear on the screen. Try setting the location closer to a main road.
- If the vehicle is too close to the destination or if there are no roads to the destination, a message saying so will appear on the screen.
- If it is impossible to reach the destination or waypoints because of traffic regulations, etc.
- If the only route to reach the destination or waypoints is extremely complicated.
- The following may occur when the route is displayed.
 - If you calculate a route on a main road, the starting point of the route may not exactly match the current vehicle location.
 - The endpoint of the route may not exactly match the destination.
 - If you calculate a route on a main road, the system may display a route from another main road. This may be because the position of the vehicle icon is not accurate. In this case, park the vehicle in a safe location and reset the vehicle icon, or continue driving to see if the position

of the vehicle icon is automatically adjusted before recalculating the route.

- There are cases in which the system shows an indirect route to reach the destination or waypoints, if you set them from stored or facility information. In order to correct this, you must be careful about the traffic direction, especially when lanes with different travel directions are shown separately, such as interchanges and service areas.
- This system makes no distinction between limited traffic control and total control (blockage). It may show an indirect route even if the road is usable.
- Even if the freeway preference is set to OFF, a route that uses the freeway may be suggested.
- Even if the ferry preference is set to OFF, a route that uses a ferry line may be suggested.
- Ferry lines, excluding those that are only for pedestrians, bicycles and motorcycles, are stored in this system. Take into consideration the travel time required and operational condition before deciding whether to use them or not.

ROUTE GUIDANCE

INFO:

The system will only announce street names when the system language is set to English. Street names are not announced when the system is set to Français (French).

Basics of voice guidance

Voice guidance announces which direction to turn when approaching an intersection in which a turn is necessary.

INFO:

- There may be some cases in which voice guidance and actual road conditions do not correspond. This may occur because of discrepancies between the actual road and the information on the map data, or it is due to the vehicle's speed.
- In case voice guidance does not correspond to the actual road conditions, follow the information obtained from traffic signs or notices on the road.
- Route guidance provided by the navigation system does not take carpool lane driving into consideration, especially when carpool lanes are separated from other road lanes.

Directions provided and distances to guide points

Directions will differ, depending on the road type.

INFO:

Distances may vary, depending on the vehicle speed.

Notification of intersection on ordinary road:

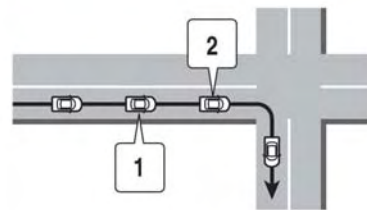

1. "In about one quarter mile (400 meters), right (left) turn."
2. "Right (left) turn ahead."

Notification of consecutive intersections on ordinary roads:

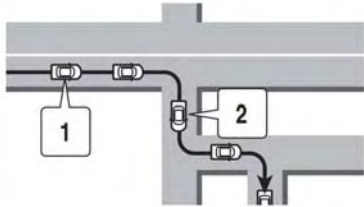

When the road has three or more consecutive intersections ahead, voice guidance will announce the following.

1. "In about one quarter mile (400 meters), right (left) turn, then in about one quarter mile (100 meters) left (right) turn."
2. "Left (right) turn ahead, then in about one quarter mile (100 meters) right (left) turn."

Notification of freeway entrance:

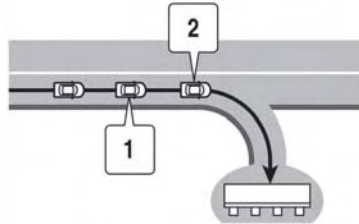

1. "In about one quarter mile (400 meters) freeway entrance on your right onto (road number and direction)."
2. "Freeway entrance on your right onto (road number and direction)."

Notification of freeway junction:

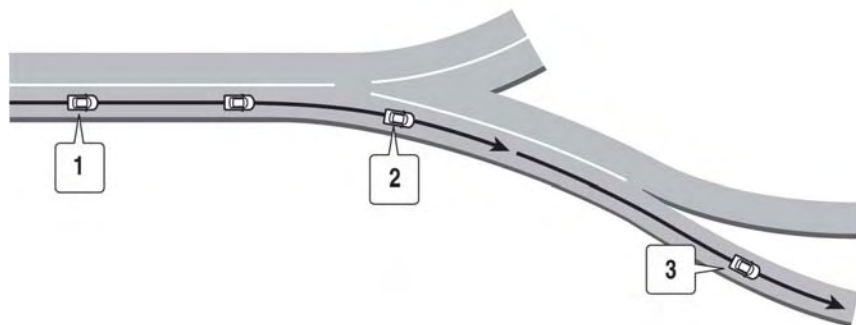

1. "In about one mile (1.6 kilometers), keep to the right (left) onto (road number and direction), then in about one quarter mile (400 meters) keep to the right (left)."
2. "Keep to the right (left) onto (road number and direction), then in about one quarter mile (400 meters) keep to the right (left) onto (road number and direction)."
3. "Keep to the right (left) onto (road number and direction)."

Notification of freeway exit:

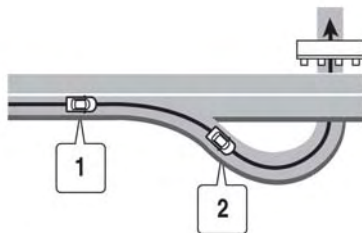

1. "In about one mile (1.6 kilometers), exit on your right."
2. "Take the second exit on your right."

Notification when approaching destination:

Ordinary road:

When approaching the destination, voice guidance will announce, "You have arrived at your destination. Ending route guidance." To finally reach your destination, refer to the map screen.

Dark green road:

After passing the last turning point on a suggested route, voice guidance will announce, "The route to your destination includes roads through incomplete map areas. Voice guidance will not be provided in these areas." When approaching the endpoint of the suggested road, voice guidance will announce, "Entering the road with incomplete map data. Please use the direction arrow and distance information to proceed to your destination."

Repeating voice guidance

This function is available throughout route guidance, from the time after the route calculation is completed until the vehicle arrives at the destination. Push and hold the **VOICE** button. Voice guidance will be repeated.





INFO:

- If the **VOICE** button is pushed and held when the vehicle is deviating from the suggested route and when the automatic reroute function is off, voice guidance will announce, "Proceed to the highlighted route."
- If the **VOICE** button is pushed and held when the vehicle is going in the wrong direction, voice guidance will announce: "Please make a legal U-turn if possible."

Notes on voice guidance

- Voice guidance in this system should be regarded as a supplementary function. When driving the vehicle, check the route on the map and follow the actual roads and traffic regulations.
- Voice guidance is activated only for intersections with certain conditions. There may be cases where the vehicle has to turn, but voice guidance is not provided.
- Voice guidance contents may vary, depending on the direction of the turn and the type of intersection.
- The voice guidance timing will vary depending on the situation.

- When the vehicle has deviated from the suggested route, voice guidance is not available. The system will not announce this. Refer to the map and recalculate the route.
 "Recalculating route" (page 3-50)
- Voice guidance may not accurately correspond with road numbers and directions at freeway junctions.
- Voice guidance may not accurately correspond to street names at freeway exits.
- The displayed street names may sometimes differ from the actual names, or "UNKNOWN STREET NAME" may be displayed.
- Voice guidance is not available when the [Guidance Voice] is turned off.
 "Volume settings" (page 1-16)
- Voice guidance will start when the vehicle enters the suggested route. Refer to the map for directions to the starting point of the route.
- When approaching a waypoint, voice guidance will announce, "You have arrived at waypoint 1 (2, 3, 4,...)." Voice guidance will switch to the next section of the route. When voice guidance is not available, refer to the map for directions.
- In some cases, voice guidance ends before arrival at the destination. Refer to the destination icon on the map to reach the destination.
- If the system recognizes on which side the destination (waypoint) is located, voice guidance will announce "on the right/left" after announcing the arrival at the destination.
- Voice guidance may be partially operational or inoperative due to the angle of roads at an intersection.
- Because freeway lane information is available only for approximately 7,000 major freeways in North America, it is not possible to display information for all junctions and exits.
- Freeway exit information may differ from the information on the actual exit signs.
- Because it is not possible to consider data concerning roads that are seasonally available or unavailable, a route may be displayed that does not match the actual traffic restrictions. Be sure to follow the actual traffic restrictions while driving.
- Canada and Alaska contain many roads with incomplete map data. As a result, when searching for a route, the route may include roads with incomplete data. In regions

where road data is not complete, voice guidance may stop for long periods of time. Be sure to follow the actual traffic restrictions while driving.

NOTES ON XM NavTraffic® INFORMATION

- The XM NavTraffic® information service is not provided for some cities. In addition, the cities for which the traffic information service is provided may be changed.
- In some cases, infrastructure problems may prevent the complete display of the traffic information. This is not a malfunction.
- Due to infrastructure problems, or due to the time when the traffic information service broadcast is received, the displayed information may differ from the actual traffic conditions.
- Depending on the traffic information, a detour route may be slower than the original route.
- XM NavTraffic® is a service of Sirius XM® Radio. XM NavTraffic® is only available in select markets and is subject to data availability. Reception of the XM® signal may vary depending on location. It requires a monthly premium subscription. The service provider is solely responsible for the quality

and accuracy of the information provided. All fees and programming are subject to change. For more details on the XM NavTraffic® service, terms and conditions, please visit

www.xmradio.com.

You can also contact XM® Radio at 1-800-XM-RADIO (1-800-967-2346).

- As of January 31, 2009, the XM NavTraffic® service covers 80 major metropolitan markets. For the most current list of markets covered, please refer to www.xmradio.com/navtraffic, or call XM® Radio customer support at 1-800-XM-RADIO (1-800-967-2346).
- Due to road maintenance, infrastructure problems (e.g. malfunction of road sensors, outage of central computer of infrastructure) or natural disasters, there are times when some or all traffic information may not be available.
- Incident information is based on human collection. Not all incidents that have happened are collected and provided.
- Due to infrastructure problems, or transmission delay, there are times when the information may differ from the actual condition. Always observe safe driving practices and follow all traffic regulations.

- Due to the coverage and quality of traffic information and road conditions, it is not always possible for the system to provide the shortest time route even when traffic information is considered.
- Traffic information that is displayed may differ from information from other media (e.g., radio), as other media may use different information sources.

MAP DATA

How to handle the Map SD card

In the right side slot, an SD card that includes the map data is inserted. When handling the Map SD card, please be careful and adhere to the following instructions:

- An SD card is inserted in the slot on the right side. This is the SDHC card that is exclusively used for this device. This card includes the map data. The SDHC card is necessary to operate the device. Do not remove this card except when update of the map data is required.
- The device does not work even if the SDHC card with the map data is inserted in the slot on the left side.
- Never analyze, modify, delete or format the map data. Doing so may cause an improper operation of the device.

- The SDHC card that is exclusively used for this device does not work properly even if it is inserted in another device.
- The map data cannot be used even if it is copied to another SDHC card.
- Do not remove the SDHC card containing map data from the system. Using the system with the SDHC card containing map data removed will prevent some functions from operating.

NOTE:

Do not remove the SD card containing map data that is inserted in the right-hand slot. When this SD card containing map data is removed the navigation system will not operate. If the SD card containing map data is accidentally removed, after reinserting the SD card containing map data into the right-hand slot, place the power switch in the OFF position and then place back in the ON position again.

How to order map data updates

To order updated map data, contact the NISSAN NAVIGATION SYSTEM HELPDESK. See the contact information on the inside front cover of this manual.

About map data

1. This map data has been prepared by HITACHI AUTOMOTIVE SYSTEMS, LTD. (HITACHI), under license from NAVTEQ. has added, processed and digitized data based on the digital road map data of NAVTEQ. Due to the production timing of the map data, some new roads may not be included in this map data or some of the names or roads may be different from those at the time you use this map data.
2. Traffic control and regulation data used in this map data may be different from those at the time you use this map data due to the data production timing. When driving your vehicle, follow the actual traffic control signs and notices on the roads.
3. Reproducing or copying this map software is strictly prohibited by law.

Published by Nissan North America, Inc.

Omaha, NE, Copyright

© 1993-2010 NAVTEQ. All Rights Reserved.

© 2010, All Rights Reserved.

WARNING

- **This navigation system should not be used to replace your own judgement. No itinerary suggested by this navigation system should ever override any highway regulations, your own judgement, or a knowledge of safe driving practices. Do not follow the navigation system's suggested itinerary if it would cause you to perform a dangerous or illegal act, place you in a dangerous situation, or take you into an area you consider unsafe.**
- **The advice provided by the navigation system is to be regarded as a suggestion only. There may be times when the navigation system displays the vehicle's location incorrectly, fails to suggest the shortest route, or fails to direct you to the your desired destination. In such instances, rely on your own driving judgement, taking into account the driving conditions at the time.**
- **Do not use the navigation system to locate emergency services. The database does not contain a complete**

listing of emergency services such as police stations, fire halls, hospitals and walk-in clinics. Please show discretion and ask for directions in such instances.

- **As the driver, you alone are responsible for your driving safety.**
 - In order to avoid a traffic accident, do not operate the system while driving.
 - In order to avoid a traffic accident, operate the system only when the vehicle is stopped at a safe place and the parking brake is on.
 - In order to avoid a traffic accident or traffic offence, remember that actual road conditions and traffic regulations take precedence over the information contained on the navigation system.
 - **The Software may contain inaccurate or incomplete information due to the passage of time, changing circumstances, and the sources of information used. Please respect current**

traffic conditions and regulations at all times while driving.

- **Where actual road conditions and highway regulations differ from the information contained on the navigation system, abide by the highway regulations.**
- **Keep the amount of time spent viewing the screen while driving to a strict minimum.**

The navigation system does not provide, nor represent in any way information on: traffic and highway regulations; technical aspects of the vehicle including weight, height, width, load and speed limits; road conditions including grade, percentage of incline and surface conditions; obstacles such as the height and width of bridges and tunnels; and other current driving or road conditions. Always rely on your own judgement when driving a car, taking into account current driving conditions.

The marks of companies displayed by this product to indicate business locations are the marks of their respective owners. The use of such marks in this product does not imply any sponsorship, approval, or endorsement by such

companies of this product.

End-user terms

The data ("Data") is provided for your personal, internal use only and not for resale. It is protected by copyright, and is subject to the following terms and conditions which are agreed to by you, on the one hand, and HITACHI AUTOMOTIVE SYSTEMS, LTD. ("HITACHI") and its licensors (including their licensors and suppliers) on the other hand.

© 2010 NAVTEQ. All rights reserved.

The Data for areas of Canada includes information taken with permission from Canadian authorities, including: © Her Majesty the Queen in Right of Canada, © Queen's Printer for Ontario, © Canada Post Corporation, Geo-Base®, © Department of Natural Resources Canada.

NAVTEQ holds a non-exclusive license from the United States Postal Service® to publish and sell ZIP+4® information.

© United States Postal Service® 2010. Prices are not established, controlled or approved by the United States Postal Service®. The following trademarks and registrations are owned by the USPS: United States Postal Service, USPS, and ZIP+4.

Terms and conditions:

Personal Use Only. You agree to use this Data together with Nissan Automotive Products for the solely personal, non-commercial purposes for which you were licensed, and not for service bureau, timesharing or other similar purposes. Accordingly, but subject to the restrictions set forth in the following paragraphs, you may copy this Data only as necessary for your personal use to (i) view it, and (ii) save it, provided that you do not remove any copyright notices that appear and do not modify the Data in any way. You agree not to otherwise reproduce, copy, modify, decompile, disassemble, create any derivative works of, or reverse engineer any portion of this Data, and may not transfer or distribute it in any form, for any purpose, except to the extent permitted by mandatory laws.

Restrictions. Except where you have been specifically licensed to do so by HITACHI, and without limiting the preceding paragraph, you may not (a) use this Data with any products, systems, or applications installed or otherwise connected to or in communication with vehicles, capable of vehicle navigation, positioning, dispatch, real time route guidance, fleet management or similar applications; or (b) with or in communication with any positioning devices or any mobile or wireless-connected electronic or

computer devices, including without limitation cellular phones, palmtop and handheld computers, pagers, and personal digital assistants or PDAs.

Warning. The Data may contain inaccurate or incomplete information due to the passage of time, changing circumstances, sources used and the nature of collecting comprehensive geographic data, any of which may lead to incorrect results.

No Warranty. This Data is provided to you "as is," and you agree to use it at your own risk. HITACHI and its licensors (and their licensors and suppliers) make no guarantees, representations or warranties of any kind, express or implied, arising by law or otherwise, including but not limited to, content, quality, accuracy, completeness, effectiveness, reliability, fitness for a particular purpose, usefulness, use or results to be obtained from this Data, or that the Data or server will be uninterrupted or error-free.

Disclaimer of Warranty: HITACHI AND ITS LICENSORS (INCLUDING THEIR LICENSORS AND SUPPLIERS) DISCLAIM ANY WARRANTIES, EXPRESS OR IMPLIED, OF QUALITY, PERFORMANCE, MERCHANTABILITY, FITNESS FOR A PARTICULAR PURPOSE OR NONINFRINGEMENT. Some States, Territories and Countries do not allow certain warranty

exclusions, so to that extent the above exclusion may not apply to you.

Disclaimer of Liability: HITACHI AND ITS LICENSORS (INCLUDING THEIR LICENSORS AND SUPPLIERS) SHALL NOT BE LIABLE TO YOU: IN RESPECT OF ANY CLAIM, DEMAND OR ACTION, IRRESPECTIVE OF THE NATURE OF THE CAUSE OF THE CLAIM, DEMAND OR ACTION ALLEGING ANY LOSS, INJURY OR DAMAGES, DIRECT OR INDIRECT, WHICH MAY RESULT FROM THE USE OR POSSESSION OF THE INFORMATION; OR FOR ANY LOSS OF PROFIT, REVENUE, CONTRACTS OR SAVINGS, OR ANY OTHER DIRECT, INDIRECT, INCIDENTAL, SPECIAL OR CONSEQUENTIAL DAMAGES ARISING OUT OF YOUR USE OF OR INABILITY TO USE THIS INFORMATION, ANY DEFECT IN THE INFORMATION, OR THE BREACH OF THESE TERMS OR CONDITIONS, WHETHER IN AN ACTION IN CONTRACT OR TORT OR BASED ON A WARRANTY, EVEN IF HITACHI OR ITS LICENSORS HAVE BEEN ADVISED OF THE POSSIBILITY OF SUCH DAMAGES. Some States, Territories and Countries do not allow certain liability exclusions or damages limitations, so to that extent the above may not apply to you.

Export Control. You agree not to export from

anywhere any part of the Data provided to you or any direct product thereof except in compliance with, and with all licenses and approvals required under, applicable export laws, rules and regulations.

Entire Agreement. These terms and conditions constitute the entire agreement between HITACHI (and its licensors, including their licensors and suppliers) and you pertaining to the subject matter hereof, and supersedes in their entirety any and all written or oral agreements previously existing between us with respect to such subject matter.

Governing Law. The above terms and conditions shall be governed by the laws of the State of Illinois, without giving effect to (i) its conflict of laws provisions, or (ii) the United Nations Convention for Contracts for the International Sale of Goods, which is explicitly excluded. You agree to submit to the jurisdiction of the State of Illinois for any and all disputes, claims and actions arising from or in connection with the Data provided to you hereunder.

Government End Users. Government End Users. If the Data is being acquired by or on behalf of the United States government or any other entity seeking or applying rights similar to those customarily claimed by the United States government, this Data is a "commercial item" as

that term is defined at 48 C.F.R. ("FAR") 2.101, is licensed in accordance with these End-User Terms, and each copy of Data delivered or otherwise furnished shall be marked and embedded as appropriate with the following "Notice of Use," and shall be treated in accordance with such Notice:

<p style="text-align: center;">NOTICE OF USE</p> <p style="text-align: center;">CONTRACTOR (MANUFACTURER/SUPPLIER) NAME: NAVTEQ</p> <p style="text-align: center;">CONTRACTOR (MANUFACTURER/SUPPLIER) ADDRESS: 425 West Randolph St., Chicago, Illinois 60606</p> <p style="text-align: center;">This Data is a commercial item as defined in FAR 2.101 and is subject to these End-User Terms under which this Data was provided.</p> <p style="text-align: center;">© 2010 NAVTEQ - All rights reserved.</p>

If the Contracting Officer, federal government agency, or any federal official refuses to use the legend provided herein, the Contracting Officer, federal government agency, or any federal official must notify NAVTEQ prior to seeking additional or alternative rights in the Data.

HOW TO HANDLE DISPLAY

The display is a liquid crystal display and should be handled with care.



Never disassemble the display. Some parts utilize extremely high voltage. Touching them may result in serious personal injury.

Characteristics of liquid crystal display

- If the temperature inside the vehicle is especially low, the display will stay relatively dim or the movement of the images may be slow. These conditions are normal. The display will function normally when the interior of the vehicle has warmed up.
- Some pixels in the display are darker or brighter than others. This condition is an inherent characteristic of liquid crystal displays, and it is not a malfunction.
- A remnant of the previous display image may remain on the screen. This screen burn is inherent in displays, and it is not a malfunction.



INFO:

The screen may become distorted by strong magnetic fields.

Maintenance of display



CAUTION

- **To clean the display, never use a rough cloth, alcohol, benzene, thinner and any kind of solvent or paper towel with a chemical cleaning agent. They will scratch or deteriorate the panel.**
- **Do not splash any liquid such as water or car fragrance on the display. Contact with liquid will cause the system to malfunction.**

To clean the display screen, use a dry, soft cloth. If additional cleaning is necessary, use a small amount of neutral detergent with a soft cloth. Never spray the screen with water or detergent. Dampen the cloth first, then wipe the screen.

HOW TO HANDLE THE SD CARD

When handling the SD card, please be careful and adhere to the following instructions:

- Always follow the instructions described in this manual and in the handbook attached to the SD card when using an SD card in this device.
- Do not handle an SD card with wet hands. Doing so may cause electric shock or a malfunction.
- Do not allow hands or metal objects to contact the terminal area of SD cards.
- Do not place SD cards on the instrument panel, on any place with direct sunlight or in moist circumstances. Doing so may damage or deform the SD card.
- Do not use any conventional cleaner, benzene, thinner or antistatic spray.
- Do not use SD cards in any place where static electricity or electric noise adversely affects SD cards. This may cause data corruption or data loss.
- SD card optimization must not be performed.
- Always place the SD card in its storage case when not in use.

- If an SD card is disposed of when it is not used, it is recommended not only to delete the stored data but also to physically break the card.

HOW TO HANDLE CD AND USB MEMORY

CD

- Handle a CD by its edges. Never touch the surface of the disc. Do not bend the disc.
 - Always place the discs in the storage case when they are not being used.
 - To clean a disc, wipe the surface from the center to the outer edge using a clean, soft cloth. Do not wipe the disc using a circular motion.
- Do not use a conventional record cleaner or alcohol intended for industrial use.
- A new disc may be rough on the inner and outer edges. Remove the rough edges by rubbing the inner and outer edges with the side of a pen or pencil.

USB memory

- Never touch the terminal portion of the USB memory.
- Do not place heavy objects on the USB memory.

- Do not store the USB memory in highly humid locations.
- Do not expose the USB memory to direct sunlight.
- Do not spill any liquids on the USB memory.

Refer to the USB memory Owner's Manual for details.

11 Index

A

About route guidance.....	3-38
Adjusting volume and others.....	1-7
Antenna.....	4-9
Audio operation precautions.....	4-2
Auxiliary input jack.....	4-20

B

Basic operation.....	1-7
Battery and power information.....	2-15
Bluetooth® Hands-Free Phone System.....	7-2
Bluetooth® streaming audio.....	4-9
Bluetooth® streaming audio operation.....	4-17

C

Camera settings.....	9-6
Canceling/reactivating route.....	3-44
Car phone or CB radio.....	7-10
CARWINGS™ overview.....	5-4
CARWINGS™ settings.....	5-10
CD-AUX screen.....	1-10
Changing map view.....	3-8
Changing region.....	3-18
Changing scale of map.....	3-7
Character (letters and numbers) input screen.....	1-7
Charge recommendation guidance.....	2-15
Charging station information.....	IT-2
Clock settings.....	1-16
Comfort & convenience settings.....	6-4
Compact Disc (CD) player.....	4-3
Compact Disc (CD) player operation.....	4-12
Compressed Audio Files (MP3/WMA).....	4-6
Confirming route.....	3-49

Connecting cellular phone.....	1-13
Connecting procedure.....	7-4
Control button and microphone.....	7-3
Control buttons and functions.....	1-2
Control panel.....	1-2
Current vehicle location.....	10-27
Customer assistance.....	10-2

D

Data communication settings.....	5-19
Deleting phone information.....	7-9
Deleting stored item.....	3-65
Destination screen.....	3-17
Display adjustment.....	1-14
Display urgent traffic information.....	6-8
Displaying CARWINGS information screen.....	5-7
Displaying charging station icons on map.....	2-5
Displaying command list.....	8-6
Displaying current vehicle location.....	3-5
Displaying estimated driving range.....	2-3
Displaying unit ID information.....	5-16
Downloading phonebook memory.....	7-8
Driving range.....	IT-2
During a call.....	7-6

E

Editing address book.....	3-59
Editing route.....	3-45
Energy information display.....	IT-3, 2-7
Error message on communication.....	5-18

F

Features of LEAF Navigation.....	IT-2
Finding address.....	3-19
Finding charging station.....	3-24
Finding nearby place.....	3-28
Finding place.....	3-21
FM-AM radio screen.....	1-10
FM-AM-SAT radio operation.....	4-11
Functions disabled while driving.....	1-6

G

Giving voice commands.....	8-2
Guidance screen settings.....	3-40

H

How to handle CD and USB memory.....	10-41
How to handle display.....	10-40
How to handle the Map SD card.....	10-36
How to handle the SD card.....	10-41
How to park with predicted course lines.....	9-4
How to read displayed lines.....	9-2
How to view information screen.....	5-7

I

Info on route.....	6-7
Information feed setting.....	5-14
Information screen.....	6-2
Inputting user ID and password.....	1-11
iPod® player and iPhone®.....	4-5
iPod® player operation.....	4-14

Items to be set initially..... 1-11

L

Language settings..... 1-17
Laser product..... 0-4
Limited Power Notice..... 2-16
Looking at information on map..... 3-12
Low battery..... 2-15

M

Making a call..... 7-5
Map data..... 10-36
Map menu screen..... 3-14
Map screen..... 1-9
Map settings..... 3-3
Map symbols..... 3-16
Map types..... 3-3
Map view settings..... 3-9
Menu screen..... 1-9
Moving map..... 3-5

N

Navigation settings..... 3-69
Navigation Telematics (CARWINGS™ service).... IT-5
Nearby traffic info..... 6-7
NISSAN voice recognition..... 8-2
Notes on XM NavTraffic® information..... 10-36

O

Operations after setting destination..... 3-34
Other navigation settings..... 3-70

P

Phone number input screen..... 1-8
Phone selection..... 7-4
Phone settings..... 7-8
Phone volume settings..... 7-10
Procedures after setting route..... 3-36

R

Radio..... 4-2
RearView monitor..... 9-2
Recalculating route..... 3-50
Receiving a call..... 7-5
Regulatory information..... 7-3
Remote functions..... IT-4
Reset all CARWINGS™ settings to default..... 5-17
Resetting all navigation settings to default..... 3-73
Restoring default settings for notifications..... 5-14
Roof antenna..... 4-9
Route calculation..... 10-30
Route guidance..... 3-36, 10-32
Route guidance settings..... 3-54
Route screen..... 3-43

S

Scrolling message or list..... 1-7
Searching for detour route using
traffic information..... 3-51
Searching from address book..... 3-26
Searching from history..... 3-27
Selecting item..... 1-7
Sending battery charge status information to Data
Center..... 5-13
Sending charge connector status information to
Data Center..... 5-12

Setting by phone number..... 3-29
Setting city center..... 3-32
Setting Climate Ctrl. Timer..... 2-10
Setting conditions for route calculation..... 3-52
Setting detour route..... 3-51
Setting freeway entrance/exit..... 3-30
Setting from stored routes..... 3-29
Setting home as destination..... 3-23
Setting intersection..... 3-31
Setting messages that are displayed
on screen..... 2-14
Setting messages that are received by email.... 5-11
Setting point on map..... 3-33
Setting time for receiving charge connector
status notifications..... 5-12
Setting timer charge..... 2-8
Speed limit indication on map..... 3-70
Start-up screen..... 1-5
Status screen..... 1-10
Steering wheel switches..... 1-4
Storing a location/route..... 3-55
Storing avoid area..... 3-58
Storing favorites..... 5-9
Storing home location..... 1-12
Storing location..... 3-55
Storing location for receiving charge connector
disconnected notifications..... 5-11
Storing route..... 3-57
Storing vehicle phonebook..... 7-6
Subscription to CARWINGS service..... 1-11

T

Telematics overview..... 5-2
Telematics service..... IT-4
Timer function operation..... 2-8
Timer functions..... IT-3

Traffic information on map.....	6-8
Traffic information settings.....	6-10
Transferring information to/from address book....	3-67

U

Unique EV function settings.....	2-13
Unique EV functions.....	IT-2
Unit settings	1-17
Updating charging station information.....	2-6
USB (Universal Serial Bus).....	4-4
USB connector and Auxiliary input jack.....	1-4
USB memory operation.....	4-15

V

Viewing available traffic information.....	6-6
Viewing CARWINGS™ records.....	5-10
Viewing Charging Station information.....	6-5
Viewing energy economy history.....	2-7
Viewing energy economy information.....	2-7
Viewing energy usage information.....	2-8
Viewing GPS current location information.....	6-11
Viewing information about current vehicle location.....	6-4
Viewing maintenance information	6-3
Viewing navigation system version information....	6-12
Viewing vehicle information.....	6-3
Voice command examples.....	8-3
Voice guidance settings.....	3-50
Voice recognition settings	8-8
Volume settings.....	1-16

X

XM satellite radio screen.....	1-10
--------------------------------	------

Z

Zero Emission menu screen.....	1-9, 2-2
--------------------------------	----------



Printing: April 2012 (07)
Publication No.: N12E-OENJU2
Printed in USA
T00NA-3NA2D

OENJ-N