



FastMile User Manual

3TG-00088-AAAA-TCZZA

Issue: 01

October 2018

Nokia is a registered trademark of Nokia Corporation. Other products and company names mentioned herein may be trademarks or tradenames of their respective owners.

The information presented is subject to change without notice. No responsibility is assumed for inaccuracies contained herein.

© 2018 Nokia.

Contains proprietary/trade secret information which is the property of Nokia and must not be made available to, or copied or used by anyone outside Nokia without its written authorization. Not to be used or disclosed except in accordance with applicable agreements.

1 Preface

This preface provides general information about the user manual for the Nokia FastMile Outdoor Unit.

1.1 Scope

This document provides an overview of the Nokia FastMile Outdoor Unit along with information about safety, installing, and troubleshooting the Nokia FastMile Outdoor Unit.

1.2 Audience

This document is intended for planners, administrators, operators, and maintenance personnel involved in installing, upgrading, or maintaining the Nokia FastMile Outdoor Unit.

Table 1 provides a summary of how the main content of this manual is organized.

Table 1 Main content of manual

Chapter number	Chapter content	Description
This chapter	Document preface	Defines the purpose, scope, and intended audience of this document; explains how information is organized in this document
5	Overview	Brief overview of the Nokia FastMile Outdoor Unit
6	Installation	Detailed installation steps for the Nokia FastMile Outdoor Unit
7	Troubleshooting	Resolutions for problems that might be faced during installation

1.3 Required knowledge

The reader must be familiar with general telecommunications principles.

1.4 Acronyms and initialisms

The expansions and optional descriptions of most acronyms and initialisms used in this document appear in the glossary at the back of the document.

1.5 Assistance and ordering phone numbers

Nokia provides global technical support through regional call centers. Phone numbers for the regional call centers are available at the following URL: <http://support.alcatel-lucent.com>.

For ordering information, contact your Nokia sales representative.

1.6 Nokia quality processes

Nokia's FastMile Outdoor Unit quality practices are in compliance with TL 9000 requirements. These requirements are documented in the Fixed Networks Quality Manual 3FQ-30146-6000-QRZZA. The quality practices adequately ensure that technical requirements and customer end-point requirements are met. The customer or its representatives may be allowed to perform on-site quality surveillance audits, as agreed upon during contract negotiations.

1.7 Safety information

For safety information, see the appropriate safety guideline chapters.

1.8 Documents

Documents are available from Nokia using ALED or OLCS.

Procedure 1 To download a ZIP file package of the customer documentation

-
- 1 Navigate to <http://support.alcatel-lucent.com> and enter your user name and password. If you are a new user and require access to this service, please contact your Nokia sales representative.

 - 2 From the Technical Content for drop-down menu, choose the product.

 - 3 Click on Downloads: Electronic Delivery.

 - 4 Choose Documentation from the drop-down menu and click Next.

5 Select the image from the drop-down menu and click Next.

6 Follow the on-screen directions to download the file.

Procedure 2 To access individual documents

Individual PDFs of customer documents are also accessible through the Nokia Customer Support website.

1 Navigate to <http://support.alcatel-lucent.com> and enter your user name and password. If you are a new user and require access to this service, please contact your Nokia sales representative.

2 From the Technical Content for drop-down menu, choose the product.

3 Click on Manuals and Guides to display a list of customer documents by title and part number. You can filter this list using the Release drop-down menu.

4 Click on the PDF to open or save the file.

1.9 Special information

The following are examples of how special information is presented in this document.



Danger — Danger indicates that the described activity or situation may result in serious personal injury or death; for example, high voltage or electric shock hazards.



Warning — Warning indicates that the described activity or situation may, or will, cause equipment damage or serious performance problems.



Caution — Caution indicates that the described activity or situation may, or will, cause service interruption.



Note — A note provides information that is, or may be, of special interest.

1.9.1 Steps with options or substeps

When there are options in a step, they are identified by letters. When there are required substeps in a step, they are identified by roman numerals.

Procedure 3 Example of options in a step

At step 1, you must choose option a or b.

1 This step offers two options. You must choose one of the following:

- a This is one option.
- b This is another option.

2 You must perform this step.

Procedure 4 Example of required substeps in a step

At step 1, you must perform a series of substeps within the step.

1 This step has a series of substeps that you must perform to complete the step. You must perform the following substeps:

- i This is the first substep.
- ii This is the second substep.
- iii This is the third substep.

2 You must perform this step.

1.10 Multiple PDF document search

You can use Adobe Reader Release 6.0 and later to search multiple PDF files for a common term. Adobe Reader displays the results in a single display panel. The results are grouped by PDF file, and you can expand the entry for each file.



Note — The PDF files in which you search must be in the same folder.

Procedure 5 To search multiple PDF files for a common term

-
- 1 Open Adobe Acrobat Reader.

 - 2 Choose Edit→Search from the Acrobat Reader main menu. The Search PDF panel appears.

 - 3 Enter the search criteria.

 - 4 Click on the All PDF Documents In radio button.

 - 5 Select the folder in which to search using the drop-down menu.

 - 6 Click on the Search button.

Acrobat Reader displays the search results. You can expand the entries for each document by clicking on the + symbol.

2 ETSI environmental and CRoHS guidelines

This chapter provides information about the ETSI environmental China Restriction of Hazardous Substances (CRoHS) regulations that govern the installation and operation of Nokia FastMile Outdoor Unit equipment. This chapter also includes environmental operation parameters of general interest.

2.1 Environmental labels

This section describes the environmental instructions that are provided with the customer documentation, equipment, and location where the equipment resides.

2.1.1 Overview

CRoHS is applicable to Electronic Information Products (EIP) manufactured or sold and imported in the territory of the mainland of the People's Republic of China. EIP refers to products and their accessories manufactured by using electronic information technology, including electronic communications products and such subcomponents as batteries and cables.

2.1.2 Environmental related labels

Environmental labels are located on appropriate equipment. The following are sample labels.

2.1.2.1 Products below Maximum Concentration Value (MCV) label

Figure 1 shows the label that indicates a product is below the maximum concentration value, as defined by standard SJ/T11363-2006 (Requirements for Concentration Limits for Certain Hazardous Substances in Electronic Information Products). Products with this label are recyclable. The label may be found in this documentation or on the product.

Figure 1 Products below MCV value label



18986

2.1.2.2 Products containing hazardous substances above Maximum Concentration Value (MCV) label

Figure 2 shows the label that indicates a product is above the maximum concentration value, as defined by standard SJ/T11363-2006 (Requirements for Concentration Limits for Certain Hazardous Substances in Electronic Information Products). The number contained inside the label indicates the Environment-Friendly User Period (EFUP) value. The label may be found in this documentation or on the product.

Figure 2 Products above MCV value label

18985

Together with major international telecommunications equipment companies, Nokia has determined it is appropriate to use an EFUP of 50 years for network infrastructure equipment and an EFUP of 20 years for handsets and accessories. These values are based on manufacturers' extensive practical experience of the design, manufacturing, maintenance, usage conditions, operating environments, and physical condition of infrastructure and handsets after years of service. The values reflect minimum values and refer to products operated according to the intended use conditions. See "[Hazardous Substances Table \(HST\)](#)" for more information.

2.2 Hazardous Substances Table (HST)

This section describes the compliance of the Nokia FastMile Outdoor Unit equipment to the CRoHS standard when the product and subassemblies contain hazardous substances beyond the MCV value. This information is found in this user documentation where part numbers for the product and subassemblies are listed. It may be referenced in other documentation that describes the Nokia FastMile Outdoor Unit equipment.

In accordance with the People's Republic of China Electronic Industry Standard Marking for the Control of Pollution Caused by Electronic Information Products (SJ/T11364-2006), customers may access the Nokia Hazardous Substance Table, in Chinese, from the following location:

- <http://www.alcatel-sbell.com.cn/wwwroot/images/upload/private/1/media/ChinaRoHS.pdf>

2.3 Other environmental requirements

Observe the following environmental requirements when handling Nokia FastMile Outdoor Unit equipment.

2.3.1 Environmental requirements

See chapter 8 in this guide for more information about temperature ranges for the Nokia FastMile Outdoor Unit equipment and other Nokia FastMile Outdoor Unit specifications.

2.3.2 Storage

According to ETS 300-019-1-1 - Class 1.1, storage of Nokia FastMile Outdoor Unit equipment must be in Class 1.1, weather-protected, temperature-controlled locations.

2.3.3 Transportation

According to EN 300-019-1-2 - Class 2.3, transportation of Nokia FastMile Outdoor Unit equipment must be in packed, public transportation.

2.3.4 Stationary use

According to EN 300-019-1-3 - Class 3.1/3.2/3.E, stationary use of Nokia FastMile Outdoor Unit equipment must be in a temperature-controlled location with no condensation allowed.

2.3.5 Thermal limitations

The thermal limitations for the Nokia FastMile Outdoor Unit equipment are:

- operating temperature (ambient): -30°C to 65°C (-22°F to 149°F)
- operating relative humidity: 5% to 85% relative humidity, non-condensing
- short-term relative humidity: 5% to 93% relative humidity, non-condensing

2.3.6 Material content compliance

European Union (EU) Directive 2002/95/EC, “Restriction of the use of certain Hazardous Substances” (RoHS), restricts the use of lead, mercury, cadmium, hexavalent chromium, and certain flame retardants in electrical and electronic equipment. This Directive applies to electrical and electronic products placed on the EU market after 1 July 2006, with various exemptions, including an exemption for lead solder in network infrastructure equipment. Nokia products shipped to the EU after 1 July 2006 comply with the EU RoHS Directive.

Nokia has implemented a material/substance content management process. The process is described in: Nokia process for ensuring RoHS Compliance (1AA002660031ASZZA). This ensures compliance with the European Union Directive 2011/65/EU on the Restriction of the Use of Certain Hazardous Substances in Electrical and Electronic Equipment (RoHS2). With the process equipment is assessed in accordance with the Harmonised Standard EN50581:2012 (CENELEC) on Technical documentation for the assessment of electrical and electronic products with respect to the restriction of hazardous substances.

2.3.7 End-of-life collection and treatment

Electronic products bearing or referencing the symbol shown in Figure 3, when put on the market within the European Union (EU), shall be collected and treated at the end of their useful life, in compliance with applicable EU and local legislation. They shall not be disposed of as part of unsorted municipal waste. Due to materials that may be contained in the product, such as heavy metals or batteries, the environment and human health may be negatively impacted as a result of inappropriate disposal.

Figure 3 Recycling/take back/disposal of product symbol



At the end of its life, Nokia FastMile Outdoor Unit equipment is subject to the applicable local legislations that implement the European Directive 2012/19EU on waste electrical and electronic equipment (WEEE).

There can be different requirements for collection and treatment in different member states of the European Union.

In compliance with legal requirements and contractual agreements, where applicable, Nokia will offer to provide for the collection and treatment of Nokia products bearing the logo shown in Figure 3 at the end of their useful life, or products displaced by Nokia equipment offers. For information regarding take-back of equipment by Nokia, or for more information regarding the requirements for recycling/disposal of product, contact your Nokia account manager or Nokia take back support at sustainability.global@nokia.com.

2.4 Additional information

See Chapter 9 for RF exposure information.

3 ETSI safety guidelines

This chapter provides information about the mandatory regulations that govern the installation and operation of Nokia FastMile Outdoor Unit equipment in the ETSI market.

3.1 Safety instructions

This section describes the safety instructions that are provided in the customer documentation and on the Nokia FastMile Outdoor Unit equipment.

3.1.1 Safety instruction boxes

The safety instruction boxes are provided in the Nokia FastMile Outdoor Unit customer documentation. Observe the instructions to meet safety requirements.

The following is an example of the Danger box.



Danger — Possibility of personal injury.

The Danger box indicates that the described activity or situation may pose a threat to personal safety. It calls attention to a situation or procedure which, if not correctly performed or adhered to, may result in death or serious physical harm.

Do not proceed beyond a Danger box until the indicated conditions are fully understood and met.

The following is an example of the Warning box.



Warning 1 — Possibility of equipment damage.

Warning 2 — Possibility of data loss.

The Warning box indicates that the described activity or situation may, or will, cause equipment damage, loss of data, or serious performance problems. It identifies a possible equipment-damaging situation or provides essential information to avoid the degradation of system operations or data.

Do not proceed beyond a warning until the indicated conditions are fully understood and met.

The following is an example of the Caution box.



Caution 1 — Possibility of service interruption.

Caution 2 — Service interruption.

The Caution box indicates that the described activity or situation may, or will, cause service interruption.

Do not proceed beyond a caution until the indicated conditions are fully understood and met.

The following is an example of the Note box.



Note — Information of special interest.

The Note box provides information that assists the personnel working with Nokia FastMile Outdoor Unit equipment. It does not provide safety-related instructions.

3.1.2 Safety-related labels

The Nokia FastMile Outdoor Unit equipment is labeled with the specific safety instructions and compliance information that is related to a product, or product variant, of the equipment. Observe the instructions on the safety labels.

Table 2 provides sample safety labels on Nokia FastMile Outdoor Unit equipment.

Table 2 Safety labels

Description	Label text
ESD warning	Caution: This assembly contains an electrostatic sensitive device.

3.2 Safety standards compliance

This section describes Nokia FastMile Outdoor Unit equipment compliance with the European safety standards.

3.2.1 EMC compliance

The Nokia FastMile Outdoor Unit equipment complies with the following EMC requirements:

- Electromagnetic compatibility of multimedia equipment - Emission requirements CISPR 32, EN 55032
- Electromagnetic compatibility of multimedia equipment - Immunity requirements CISPR 35, EN55035
- Electromagnetic Compatibility (EMC) standard for radio equipment and services; Part 1: Common technical requirements; Harmonized Standard covering the essential requirements of article 3.1(b) of Directive 2014/53/EU and the essential requirements of article 6 of Directive 2014/30/EU EN 301489-1
- Electromagnetic Compatibility (EMC) standard for radio equipment and services; Part 17: Specific conditions for Broadband Data Transmission Systems; Harmonized Standard covering the essential requirements of article 3.1(b) of Directive 2014/53/EU EN 301489-17

3.2.2 Equipment safety standard compliance

The Nokia FastMile Outdoor Unit equipment complies with the requirements of the following:

- EN 60950-1, Safety of Information Technology Equipment for use in a restricted location (per R-269)
- IEC 60950-22, EN 60950-22: Information Technology Equipment- Safety - Part 22 Equipment to be installed Outdoors

3.2.3 Environmental standard compliance

The Nokia FastMile Outdoor Unit equipment complies with the EN 300 019 European environmental standards.

3.2.4 Laser product standard compliance

The Nokia FastMile Outdoor Unit equipment is not a laser product.

3.3 Electrical safety guidelines

This section provides the electrical safety guidelines for the Nokia FastMile Outdoor Unit equipment.



Note 1 — The Nokia FastMile Outdoor Unit equipment complies with the U.S. National Electrical Code. However, local electrical authorities have jurisdiction when there are differences between the local and U.S. standards.

Note 2 — The Nokia FastMile Outdoor Unit equipment complies with BS EN 61140.

3.3.1 Power supplies

The use of any non-Nokia approved power supplies or power adapters is not supported or endorsed by Nokia. Such use will void any warranty or support contract with Nokia. Such use greatly increases the danger of damage to equipment or property.

3.3.2 Cabling

The following are the guidelines regarding cables used for the Nokia FastMile Outdoor Unit equipment:

- All cables must be approved by the relevant national electrical code.
- Cables for outdoor connection to the Nokia FastMile Outdoor Unit equipment must be suitable for outdoor use.
- The Nokia FastMile Outdoor Unit equipment must be used with the cabling supplied with the equipment.

3.3.3 Protective earth

Earthing and bonding of the Nokia FastMile Outdoor Unit equipment must comply with the requirements of local electrical codes.

3.4 ESD safety guidelines

The Nokia FastMile Outdoor Unit equipment is sensitive to ESD if opened. Operations personnel must observe the following ESD instructions when they handle the Nokia FastMile Outdoor Unit equipment.



Caution — This equipment is ESD sensitive if opened. Proper ESD protections should be used if you open the Nokia FastMile Outdoor Unit.

Service personnel are not required to wear wrist straps when performing normal installation or maintenance activities.

3.5 Environmental requirements

See chapter 8 in this guide for more information about temperature ranges for the Nokia FastMile Outdoor Unit equipment and other Nokia FastMile Outdoor Unit specifications.

During operation in the supported temperature range, condensation inside the Nokia FastMile Outdoor Unit equipment caused by humidity is not an issue because the Nokia FastMile Outdoor Unit is a sealed unit.

3.6 Additional information

See Chapter 9 for RF exposure information.

4 ANSI safety guidelines

This chapter provides information about the mandatory regulations that govern the installation and operation of the Nokia FastMile Outdoor Unit equipment in the North American or ANSI market.

4.1 Safety instructions

This section describes the safety instructions that are provided in the customer documentation and on the Nokia FastMile Outdoor Unit equipment.

4.1.1 Safety instruction boxes in customer documentation

The safety instruction boxes are provided in the Nokia FastMile Outdoor Unit customer documentation. Observe the instructions to meet safety requirements.

The following is an example of the Danger box.



Danger — Possibility of personal injury.

The Danger box indicates that the described activity or situation may pose a threat to personal safety. It calls attention to a situation or procedure which, if not correctly performed or adhered to, may result in death or serious physical harm.

Do not proceed beyond a Danger box until the indicated conditions are fully understood and met.

The following is an example of the Warning box.



Warning 1 — Possibility of equipment damage.

Warning 2 — Possibility of data loss.

The Warning box indicates that the described activity or situation may, or will, cause equipment damage, loss of data, or serious performance problems. It identifies a possible equipment-damaging situation or provides essential information to avoid the degradation of system operations or data.

Do not proceed beyond a warning until the indicated conditions are fully understood and met.

The following is an example of the Caution box.



Caution 1 — Possibility of service interruption.

Caution 2 — Service interruption.

The Caution box indicates that the described activity or situation may, or will, cause service interruption.

Do not proceed beyond a caution until the indicated conditions are fully understood and met.

The following is an example of the Note box.



Note — Information of special interest.

The Note box provides information that assists the personnel working with Nokia FastMile Outdoor Unit equipment. It does not provide safety-related instructions.

4.1.2 Safety-related labels

The Nokia FastMile Outdoor Unit equipment is labeled with specific safety compliance information and instructions that are related to a product, or product variant, of the equipment. Observe the instructions on the safety labels.

Table 3 provides examples of the text in the various Nokia FastMile Outdoor Unit equipment safety labels.

Table 3 Safety labels

Description	Label text
UL compliance	ETL/cETL
UL50E compliance	Type 3
ESD warning	Caution: This assembly contains electrostatic sensitive device.
FCC standards compliance	Tested to comply with FCC standards for home or office use.
Operation conditions	This device complies with Part 15 of the FCC Rules. Operation is subject to the following two conditions: (1) this device may not cause harmful interference, and (2) this device must accept any interference received, including interference that may cause undesired operation.
CE marking	There are various CE symbols for CE compliance.

Figure 4 shows a sample safety label for FCC and Figure 5 shows a sample safety label for ETL.

Figure 4 Sample safety label for FCC

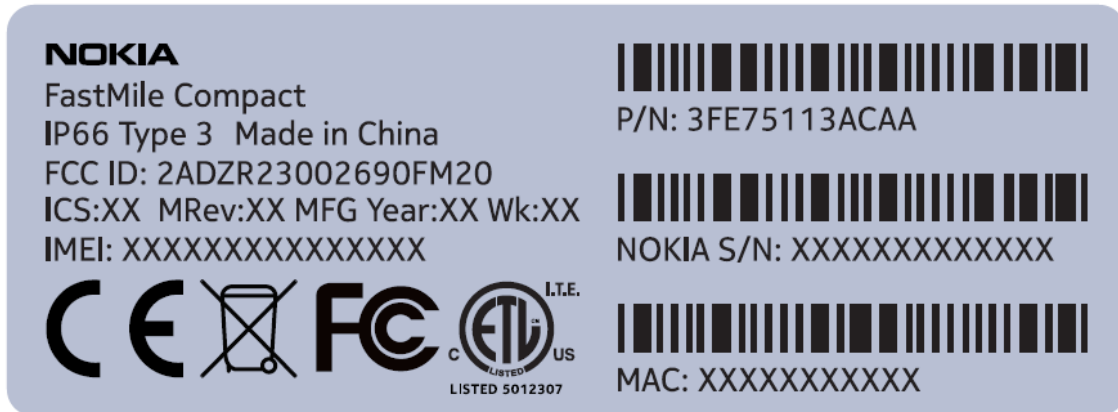

18533

Figure 5 Sample safety label for ETL



27799

4.2 Safety standards compliance

This section describes the Nokia FastMile Outdoor Unit equipment compliance with North American safety standards.



Warning — Changes or modifications to this unit not expressly approved by the party responsible for compliance could void the user's authority to operate the equipment.

4.2.1 EMC, EMI, and ESD compliance

The Nokia FastMile Outdoor Unit equipment complies with the following EMC, EMI, and ESD requirements:

- Federal Communications Commission PART 15-RADIO FREQUENCY DEVICES Subpart C-INTENTIONAL RADIATORS Title 47 CFR Part 15. Part 15.247

This equipment has been tested and found to comply with the limits for a Class B digital device, pursuant to Part 15 of the FCC Rules. These limits are designed to provide reasonable protection against harmful interference in a residential installation. This equipment generates, uses and can radiate radio frequency energy and, if not installed and used in accordance with the instructions, may cause harmful interference to radio communications.

However, there is no guarantee that interference will not occur in a particular installation. If this equipment does cause harmful interference to radio or television reception, which can be determined by turning the equipment off and on, the user is encouraged to try to correct the interference by one or more of the following measures:

- Reorient or relocate the receiving antenna.
- Increase the separation between the equipment and receiver.
- Connect the equipment into an outlet on a circuit different from that to which the receiver is needed.
- Consult the dealer or an experienced radio/TV technician for help.

4.2.2 Equipment safety standard compliance

The Nokia FastMile Outdoor Unit equipment complies with the requirements of:

- UL62368-1, Outdoor ONTs to “Communication Service Equipment” (CSE) and Indoor ONTs to Information Technology Equipment (ITE)
- Information Technology Equipment- Safety - Part 22 Equipment to be installed Outdoors
- UL 60950-22

4.3 Electrical safety guidelines

This section provides the electrical safety guidelines for the Nokia FastMile Outdoor Unit equipment.



Note — The Nokia FastMile Outdoor Unit equipment complies with the U.S. National Electrical Code. However, local electrical authorities have jurisdiction when there are differences between the local and U.S. standards.

4.3.1 Power supplies

The use of any non-Nokia approved power supplies or power adapters is not supported or endorsed by Nokia. Such use will void any warranty or support contract with Nokia. Such use greatly increases the danger of damage to equipment or property.

4.3.2 Cabling

The following are the guidelines regarding cables used for the Nokia FastMile Outdoor Unit equipment:

- All cables must be approved by the relevant national electrical code.
- Cables for outdoor connection to the Nokia FastMile Outdoor Unit equipment must be suitable for outdoor use.
- The Nokia FastMile Outdoor Unit equipment must be used with the cabling supplied with the equipment.

4.3.3 Protective earth

Earthing and bonding of the Nokia FastMile Outdoor Unit equipment must comply with the requirements of NEC article 250 or local electrical codes.

4.4 ESD safety guidelines

The Nokia FastMile Outdoor Unit equipment is sensitive to ESD if opened. Operations personnel must observe the following ESD instructions when they handle the Nokia FastMile Outdoor Unit equipment.



Caution — This equipment is ESD sensitive if opened. Proper ESD protections should be used if you open the Nokia FastMile Outdoor Unit.

Service personnel are not required to wear wrist straps when performing normal installation or maintenance activities.

4.5 Environmental requirements

See chapter 8 in this guide for more information about temperature ranges for the Nokia FastMile Outdoor Unit equipment and other Nokia FastMile Outdoor Unit specifications.

During operation in the supported temperature range, condensation inside the Nokia FastMile Outdoor Unit equipment caused by humidity is not an issue because the Nokia FastMile Outdoor Unit is a sealed unit.

4.6 Additional information

See Chapter 9 for RF exposure information.

See Chapter 10 for additional FCC compliance information.

Table of contents

1	Preface	3
1.1	Scope	3
1.2	Audience.....	3
1.3	Required knowledge	3
1.4	Acronyms and initialisms	3
1.5	Assistance and ordering phone numbers	4
1.6	Nokia quality processes.....	4
1.7	Safety information.....	4
1.8	Documents	4
1.9	Special information	5
1.9.1	Steps with options or substeps.....	6
1.10	Multiple PDF document search	7
2	ETSI environmental and CRoHS guidelines	9
2.1	Environmental labels	9
2.1.1	Overview.....	9
2.1.2	Environmental related labels	9
2.1.2.1	Products below Maximum Concentration Value (MCV) label.....	9
2.1.2.2	Products containing hazardous substances above Maximum Concentration Value (MCV) label.....	10
2.2	Hazardous Substances Table (HST).....	11
2.3	Other environmental requirements	12
2.3.1	Environmental requirements.....	12
2.3.2	Storage	12
2.3.3	Transportation	12
2.3.4	Stationary use.....	12
2.3.5	Thermal limitations	12
2.3.6	Material content compliance.....	13
2.3.7	End-of-life collection and treatment.....	13
2.4	Additional information	14
3	ETSI safety guidelines	15
3.1	Safety instructions	15
3.1.1	Safety instruction boxes	15
3.1.2	Safety-related labels.....	16
3.2	Safety standards compliance	16
3.2.1	EMC compliance	17
3.2.2	Equipment safety standard compliance.....	17
3.2.3	Environmental standard compliance	17
3.2.4	Laser product standard compliance	17
3.3	Electrical safety guidelines	18
3.3.1	Power supplies	18
3.3.2	Cabling	18
3.3.3	Protective earth	18
3.4	ESD safety guidelines	19
3.5	Environmental requirements.....	19

3.6	Additional information	19
4	ANSI safety guidelines	21
4.1	Safety instructions	21
4.1.1	Safety instruction boxes in customer documentation	21
4.1.2	Safety-related labels	22
4.2	Safety standards compliance	23
4.2.1	EMC, EMI, and ESD compliance.....	24
4.2.2	Equipment safety standard compliance.....	24
4.3	Electrical safety guidelines	25
4.3.1	Power supplies	25
4.3.2	Cabling	25
4.3.3	Protective earth	25
4.4	ESD safety guidelines	26
4.5	Environmental requirements.....	26
4.6	Additional information	26
5	Overview	35
5.1	Product overview	35
5.2	Functional overview.....	37
5.2.1	LTE characteristics	38
5.2.2	Ethernet characteristics	38
5.2.3	Power supply characteristics	38
5.3	Variant overview	38
5.3.1	Variant label information.....	39
5.4	Physical interfaces	39
5.5	LED behavior	40
5.6	Power information.....	41
5.7	Performance information	41
5.7.1	Throughput information	41
5.7.2	Power consumption information	42
5.8	Standards certification	42
6	Installation procedure	45
6.1	Safety information.....	45
6.2	Package contents	46
6.3	Installation prerequisites	46
6.3.1	Lightning protection	48
6.4	Installation steps for the Nokia FastMile Outdoor Unit	48
6.5	Post-installation of the Nokia FastMile Outdoor Unit.....	75
7	Troubleshooting	89
7.1	Potential problems during installation and startup phase	89
7.1.1	Nokia FastMile Outdoor Unit cannot attach to LTE network due to hardware mismatch	89
7.1.2	Failed to get Base Station Location.....	89
7.1.3	Subscriber has already registered a receiver with its serial number to controller.....	89
7.2	Potential problems during execution phase.....	90
7.2.1	Nokia FastMile Outdoor Unit firmware upgrade to latest build failed.....	90
7.2.2	Trace request	90

8	Appendix A: Specifications	91
8.1	Specifications	91
9	Appendix B: RF exposure	93
9.1	RF exposure	93
10	Appendix C: FCC statements and label instructions	95
10.1	FCC compliance statement	95
10.2	FCC radiation exposure statement.....	95
10.3	FCC label instructions	96
11	Glossary	97

List of figures

2	ETSI environmental and CRoHS guidelines.....9
Figure 1	Products below MCV value label..... 10
Figure 2	Products above MCV value label 11
Figure 3	Recycling/take back/disposal of product symbol 13
4	ANSI safety guidelines21
Figure 4	Sample safety label for FCC.....23
Figure 5	Sample safety label for ETL23
5	Overview35
Figure 6	Application example of the Nokia FastMile Outdoor Unit36
Figure 7	Versions of the Nokia FastMile Outdoor Unit37
Figure 8	Location of physical interfaces on the Nokia FastMile Outdoor Unit40
6	Installation procedure45
Figure 9	Splash screen.....49
Figure 10	Screen for preparing to scan the QR code50
Figure 11	QR code screen.....51
Figure 12	Screen showing the Fresh Install option.....52
Figure 13	Screen for logging in to the Nokia Altiplano FastMile Controller53
Figure 14	Screen indicating to use the Nokia Field Assistant app to start finding a nearby base station.....54
Figure 15	Screen showing to hold vertically for first person view54
Figure 16	Screen showing to check for obstructions that will block signal from a base station55
Figure 17	Screen with prompt to allow access to the device’s location.....56
Figure 18	Screen showing good location with respect to the base station57
Figure 19	Location of physical interfaces on the Nokia FastMile Outdoor Unit58
Figure 20	Attaching the mounting plate to the Nokia FastMile Outdoor Unit.....59
Figure 21	Mounting the wall-mount bracket.....60
Figure 22	Mounting the Nokia FastMile Outdoor Unit.....61
Figure 23	Location of ports on a PoE injector.....62
Figure 24	Screen showing the connect prompt63
Figure 25	Screen showing the Bluetooth enabling request64
Figure 26	Screen showing the Bluetooth pairing request65
Figure 27	Screen for enabling the VPN profile66
Figure 28	Screen showing the login prompt67
Figure 29	Screen showing that 0% of the reboot process is complete.....68
Figure 30	Screen showing that 100% of the reboot process is complete.....68
Figure 31	Screen showing connecting state.....69
Figure 32	Screen showing offline state.....70
Figure 33	Screen showing online state.....70
Figure 34	System state screen72
Figure 35	Screen that has the “Upload CA certificates” option.....73
Figure 36	Screen that lists the CA certificates.....74
Figure 37	Screen indicating that uploading of the CA certificates was successful.....75

Figure 38	Splash screen.....	76
Figure 39	Screen for preparing to scan the QR code	77
Figure 40	QR code screen.....	77
Figure 41	Screen showing the Connect to Receiver option.....	78
Figure 42	Screen showing the connect prompt	79
Figure 43	Screen showing the Bluetooth enabling request	80
Figure 44	Screen showing the Bluetooth pairing request	81
Figure 45	Screen for enabling the VPN profile	82
Figure 46	Screen showing the login prompt	83
Figure 47	System state screen	84
Figure 48	Screen that has the “Upload CA certificates” option.....	85
Figure 49	Screen that lists the CA certificates.....	86
Figure 50	Screen indicating that uploading of the CA certificates was successful.....	87

List of tables

1	Preface	3
Table 1	Main content of manual	3
3	ETSI safety guidelines	15
Table 2	Safety labels	16
4	ANSI safety guidelines	21
Table 3	Safety labels	22
5	Overview	35
Table 4	Variants of the Nokia FastMile Outdoor Unit	39
Table 5	Label information for Nokia FastMile Outdoor Unit variants	39
Table 6	Physical interfaces of the Nokia FastMile Outdoor Unit	40
Table 7	LED behavior description	40
Table 8	LTE throughput information	41
Table 9	Power consumption information	42
Table 10	Standards certifications for the Nokia FastMile Outdoor Unit.....	43
6	Installation procedure	45
Table 11	LED behavior description	63
8	Appendix A: Specifications	91
Table 12	Specifications for the Nokia FastMile Outdoor Unit	91
10	Appendix C: FCC statements and label instructions	95
Table 13	FCC ID for Nokia FastMile Outdoor Unit variants.....	95

5 Overview

5.1 Product overview

5.2 Functional overview

5.3 Variant overview

5.4 Physical interfaces

5.5 LED behavior

5.6 Power information

5.7 Performance information

5.8 Standards certification

5.1 Product overview

The Nokia FastMile Outdoor Unit is the outdoor unit (ODU) of the Nokia FastMile solution, the purpose of which is to use 3GPP based LTE radio technology to provide broadband connectivity with guaranteed high bitrates in larger service areas in a more cost-efficient manner than is possible with other existing solutions.

The Nokia FastMile solution can overcome network performance challenges faced by today's mobile networks by optimizing all of the following:

- intra site interference due to neighbor sectors in same LTE base station
- inter site interference due to neighbor base stations
- link performance due to wall penetration loss and several miles path loss

The Nokia FastMile Outdoor Unit provides high-performing, wireless broadband access over LTE to meet residential users' total home connectivity needs for urban, suburban, rural, and deep rural spots.

The Nokia FastMile Outdoor Unit supports LTE connectivity to an LTE base station in the network and provides 1 Gbps Ethernet connectivity through a pre-attached 3 m (9.8 ft) Ethernet cable to an indoor unit, such as a residential gateway like the Nokia 7368 ISAM CPE A-020W-A.

Figure 6 shows an application example of the Nokia FastMile Outdoor Unit.

Figure 6 Application example of the Nokia FastMile Outdoor Unit

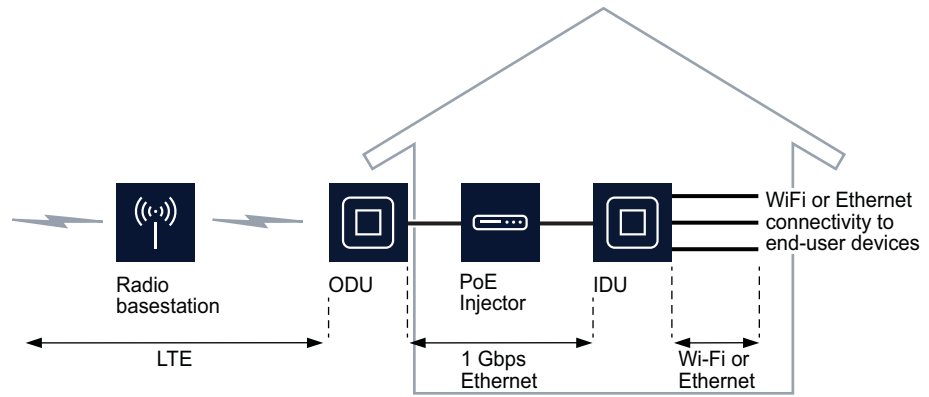

27903

The Nokia FastMile Outdoor Unit is available in two versions:

- Compact with fixed beamforming antennas
- ABA version with high gain beam steering antenna with automated beam alignment

Figure 7 shows the two versions of the Nokia FastMile Outdoor Unit.

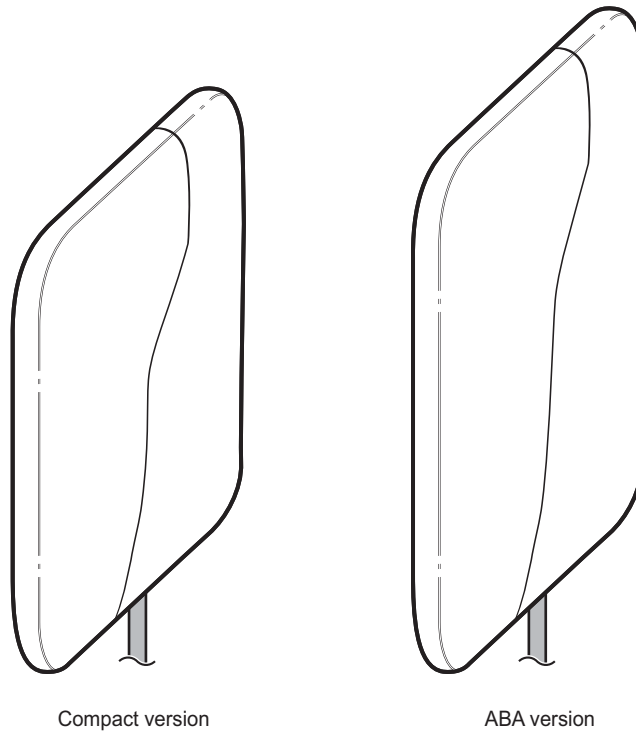
Figure 7 Versions of the Nokia FastMile Outdoor Unit

27897

The Nokia FastMile Outdoor Unit has built-in antenna and an LTE modem that provide the LTE broadband access to the network.

The Nokia FastMile Outdoor Unit is capable of withstanding outdoor environmental conditions. It has an IP rating of IP66 TYPE3 and can operate in a temperature of -30°C to 65°C (-22°F to 149°F). See chapter 8 for additional specifications of the Nokia FastMile Outdoor Unit.

5.2 Functional overview

The Nokia FastMile Outdoor Unit provides wireless broadband access in the form of LTE to meet the ever growing network needs of end users.

The Nokia FastMile Outdoor Unit lets operators use LTE to offer fixed wireless broadband to their customers. The Nokia FastMile Outdoor Unit is easy to install and user-friendly to operate. It uses a mobile phone installation application known as the Nokia Field Assistant to make sure that it is deployed in the optimal location.

The Nokia FastMile Outdoor Unit supports remote management capability, allowing management and health monitoring of it from the Nokia Altiplano FastMile Controller.

5.2.1 LTE characteristics

The following are some of the key LTE characteristics of the Nokia FastMile Outdoor Unit:

- LTE 3GPP Release 12 Compliant, UE Category 12
- has variants that support the following E-UTRA bands:
 - Band 7/41

5.2.2 Ethernet characteristics

The following are some of the key Ethernet characteristics of the Nokia FastMile Outdoor Unit:

- provides a 1 Gbps Ethernet LAN Interface
- supports IEEE802.3 1000BASE-T
- supports IEEE802.3az energy efficient Ethernet
- has a pre-attached 3 m (9.8 ft) Cat5e shielded twisted pair Ethernet cable with an RJ 45 connector at the free end; the same cable is also used for power over Ethernet (PoE) as per IEEE802.3 at type-2 and for grounding to an indoor ground

5.2.3 Power supply characteristics

The following are some of the key power supply characteristics of the Nokia FastMile Outdoor Unit:

- powered through PoE from an indoor unit, such as a residential gateway, or through a PoE injector; the same cable also provides grounding to an indoor ground
- supports PoE+ as per IEEE802.3 at type-2
- rating: 53 VDC at 600 mA

See section [5.6](#) for power information.

5.3 Variant overview

Variants are available for the Nokia FastMile Outdoor Unit to support different E-UTRA bands for LTE.

Table 4 describes the E-UTRA band and frequency support and the antenna configurations for each variant of the Nokia FastMile Outdoor Unit, and provides the orderable part number.

Table 4 Variants of the Nokia FastMile Outdoor Unit

Version and variant	E-UTRA band support and frequencies	Antenna configuration	Orderable part number
Compact B7/B41	<ul style="list-style-type: none"> Band 7: FDD, Tx 2500 MHz – 2570 MHz, Rx 2620 MHz – 2690 MHz Band 41: TDD, 2496 MHz – 2690 MHz 	Integrated with 12.5 dBi fixed beamforming antenna	3FE 75113 AC

5.3.1 Variant label information

Table 5 describes the label information for the variants of the Nokia FastMile Outdoor Unit.

Table 5 Label information for Nokia FastMile Outdoor Unit variants

Version and variant	Product details	Model
Compact B7/B41	Nokia FM compact	3FE75113ACAA

5.4 Physical interfaces

Table 6 describes the physical interfaces of the Nokia FastMile Outdoor Unit.

Table 6 Physical interfaces of the Nokia FastMile Outdoor Unit

Interface	Description
Ground point	External ground point in case a ground separate from indoor grounding provided by the Ethernet cable is required
Ethernet cable	Pre-attached 3 m (9.8 ft) Ethernet cable; the same cable is also used for power (PoE as per IEEE802.3 at type-2) and for grounding to an indoor ground. The RJ 45 connector at the free end of the cable supports connection of an additional length of cat5e shielded Ethernet cabling up to a maximum of 40 m (131 ft) in combined length.
LED	Single multifunction LED that indicates status information for the Nokia FastMile Outdoor Unit See section 5.5 for information about LED behavior
Reset button	Button to reset the Nokia FastMile Outdoor Unit
SIM slot	Slot for Nano/4FF SIM card for the Nokia FastMile Outdoor Unit

Figure 8 shows the location of the physical interfaces on the Nokia FastMile Outdoor Unit. Note that the cover for the SIM slot has been removed to show the slot.

Figure 8 Location of physical interfaces on the Nokia FastMile Outdoor Unit

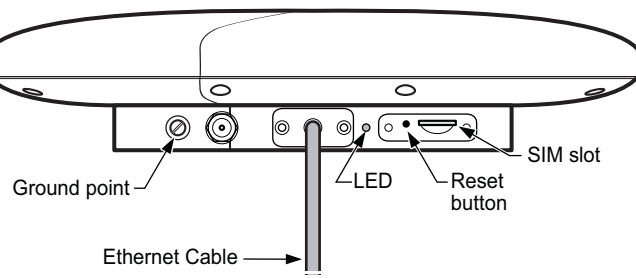

27898

5.5 LED behavior

Table 7 describes the behavior of the Nokia FastMile Outdoor Unit LED.

Table 7 LED behavior description

LED color	LED priority	LED behavior	Status information
Blue	First priority	Blinking	Bluetooth connection in progress
		Solid	Bluetooth connection established
		Off	No Bluetooth connection

(1 of 2)

LED color	LED priority	LED behavior	Status information
Red	Second priority	Blinking	Critical alarm
		Solid	Major or minor alarm
		Off	No alarm
Green	Third priority	Blinking twice per second	Kernel and application start up
		Blinking one per second	Application start up and OAM link established
		Off	OAM link established

(2 of 2)

5.6 Power information

The Nokia FastMile Outdoor Unit receives power through a CAT5e shielded Ethernet cable connected to an indoor unit, such as a residential gateway like the Nokia 7368 ISAM CPE A-020W-A, or a PoE injector.

See section [5.7.2](#) for power consumption information.

5.7 Performance information

This section provides throughput and power consumption information for the Nokia FastMile Outdoor Unit:

- section [5.7.1](#) provides throughput consumption information
- section [5.7.2](#) provides power consumption information

5.7.1 Throughput information

Table [8](#) provides LTE throughput information for the Nokia FastMile Outdoor Unit.

Table 8 LTE throughput information

Mode		UDP UL	UDP DL	TCP UL	TCP DL
FDD		73.5M	293M	73M	220M
TDD		14M	332M	14M	220M

The results in the above table are based on the following:

- Data rates can have a margin of 2%
- Packet length is 1470B for UDP
- Window is 128k for TCP
- Data rates are for IPv4 cases
- TDD based on configuration 2, subframe 7
- Data forwarding working on bridge model

The end-to-end throughput is achieved in the conductive mode with cable connected.

Ethernet throughput for the Nokia FastMile Outdoor Unit is as per standard Ethernet 1000BASE-T, with a maximum of 1000 Mbps. The Ethernet link gets negotiated at 1000 Mbps when the indoor unit, such as a residential gateway like the Nokia 7368 ISAM CPE A-020W-A, or a PoE injector is connected to the Nokia FastMile Outdoor Unit.

5.7.2 Power consumption information

Table 9 provides power consumption information for the Nokia FastMile Outdoor Unit.

Table 9 Power consumption information

Condition	Power consumption
Maximum power output	7 w
Provisioned but not activated	1 w

5.8 Standards certification

Table 10 provides standards certification information for the Nokia FastMile Outdoor Unit.

Table 10 Standards certifications for the Nokia FastMile Outdoor Unit

Category	Certifications
RF	EN 301 908-13 for Band 3, 7, 38, 40, 42, 43 of the Compact version and Band 42, 43 of the ABA version FCC 47 Parts 27 for Band 7, 41 of the Compact version
EMC	ETSI EN 301 489-1 and -52 for Band 3, 7, 38, 40, 42, 43 of the Compact version and Band 42, 43 of the ABA version FCC 47 part 2/15 for Band 7, 41 of the Compact version
RoHS	Directive 2011/65/EU
Safety	EN/IEC 60950-1; 60950-22 UL 62368-1, UL 60950-22, UL 50E, EN/IEC 60529 (IP66)

The CE mark is valid for Band 3, 7, 38, 40, 42, 43 of the Compact version and Band 42, 43 of the ABA version.

The FCC ID is valid for Band 7, 41 of the Compact version

See chapter [10](#) for FCC statements and label instructions.

6 Installation procedure

6.1 Safety information

6.2 Package contents

6.3 Installation prerequisites

6.4 Installation steps for the Nokia FastMile Outdoor Unit

6.5 Post-installation of the Nokia FastMile Outdoor Unit

6.1 Safety information

Be sure to observe the following before installing the Nokia FastMile Outdoor Unit:

- Professional installation is recommended for the Nokia FastMile Outdoor Unit. If the end-user is going to install the Nokia FastMile Outdoor Unit, appropriate safety instructions and appropriate information must be provided.
- Only use a Nokia-approved indoor unit or a Nokia-approved PoE Injector for powering the Nokia FastMile Outdoor Unit.
- Do not provide power to the Nokia FastMile Outdoor Unit before completing the hardware installation step of the installation procedure.
- Maintain at least 50 cm (20 in) distance from the front face of the Nokia FastMile Outdoor Unit while the system is operating.



Danger 1 — Lightning danger: Since cables from external environment may connect to the system and they are exposed to lightning, do not work on equipment or cables during periods of lightning activity.

Danger 2 — Height danger: Falling from high elevations can cause serious injury or death. Caution should be observed whenever performing aerial installations.

Danger 3 — Power danger:

- Hazardous electrical voltages and currents can cause serious physical harm or death. Always use insulated tools and follow proper safety precautions when connecting or disconnecting power circuits.
- Make sure all sources of power are turned off and have no live voltages present on feed lines or terminals. Use a voltmeter to measure for voltage before proceeding.
- Always contact the local utility company before connecting the equipment to power.

6.2 Package contents

The shipping package for the Nokia FastMile Outdoor Unit contains the following:

- Nokia FastMile Outdoor Unit (quantity one) with pre-attached 3 m (9.8 ft) Ethernet cable
- wall mount-bracket and mounting plate (quantity one of each), attached to each other with three fasteners when shipped
- two screws for attaching the mounting plate to the Nokia FastMile Outdoor Unit

The outside of the shipping package of the Nokia FastMile Outdoor Unit has a QR code that has system-use information for the Nokia FastMile Outdoor Unit.

6.3 Installation prerequisites

Before starting installation, it is useful to consider the following roles along with their responsibilities and interrelationships:

- mobile network operator: responsible for running the mobile network that has the LTE and EPC networks and typically provides the SIM card for the Nokia FastMile Outdoor Unit
- fixed network operator: responsible for owning the residential gateway and the ACP
- ODU installer: responsible for installing the Nokia FastMile Outdoor Unit

It is possible that more than one of the above roles could be performed by the same organization.

You need to be aware of the following before installing the Nokia FastMile Outdoor Unit. Contact your Nokia representative for additional information.

- information about route and bridge mode operation of the Nokia FastMile Outdoor Unit
- information about Nokia FastMile Outdoor Unit operation with assigned Cell List or Free Run Mode
- determine if port forwarding is required on the Nokia FastMile Outdoor Unit for residential gateway connectivity with the ACP
- the operator's EPC network should align with the following of the Nokia FastMile Outdoor Unit:
 - the Nokia FastMile Outdoor Unit's mobile subscriber profile in the HSS should be assigned by the mobile network operator as follows:
 - a specific APN should be used for the Nokia FastMile Outdoor Unit to attach the LTE network; if no specific APN is indicated, the Nokia FastMile Outdoor Unit will attach to the LTE network with the default APN that the mobile operator sets in the MME
 - for this subscriber's profile in the PCRF, the related QCI setting should be defined the same as the DSCP for the residential gateway
 - the SIM card of the Nokia FastMile Outdoor Unit should be related to a specific data service of the mobile network in the HSS; this SIM card should have the same PIN or an empty PIN, as the Nokia FastMile Outdoor Unit will not do a PIN unlock if the wrong PIN code is set on the device; if this happens, the Nokia FastMile Outdoor Unit installer needs to go onsite and replace the SIM card
- for other configuration information for the Nokia FastMile Outdoor Unit, refer to the FastMile playbook for detailed operation

Before beginning installation of the Nokia FastMile Outdoor Unit, it is important that all necessary preparation in the NAC be done according to the details and steps in the Nokia Altiplano FastMile Controller documentation.

Be sure to observe the following prerequisites before installing the Nokia FastMile Outdoor Unit:

- Installation personnel must have knowledge about installing the unit
- A valid Nano/4FF SIM card is needed for the Nokia FastMile Outdoor Unit to connect to the LTE network
- If required, a Cat5e shielded Ethernet cable that can be connected to the Ethernet cable of the Nokia FastMile Outdoor Unit to make it longer, up to a maximum of 40 m (131 ft) in combined length
- A ground cable is needed if the Nokia FastMile Outdoor Unit will be grounded separately from the indoor ground provided by the Ethernet cable; requires a hex key suitable for hex socket knurled head cup screw assemblies, ISO 4762-M5X8
- Appropriate fasteners for securing the Nokia FastMile Outdoor Unit to an outside wall
- Silicone or other waterproof sealing or caulking compound

- Mechanical tools are required (but are not included) for mounting the Nokia FastMile Outdoor Unit, including:
 - TROX T8 screwdriver to open the SIM slot
 - hex key as described above if ground cable is needed
- The Nokia Field Assistant app must be installed on an Android mobile phone through Google Play and the mobile phone must have a camera, hardware compass, rotation vector (either a groscope or an enhanced geomagnetic sensor that supports rotation vector), and Android OS 6.0 (Marshmallow) or above
- The LTE base station that will be used by the Nokia FastMile Outdoor Unit must be available and functioning
- The indoor unit, such as a residential gateway like the Nokia 7368 ISAM CPE A-020W-A, that will be connecting to the Nokia FastMile Outdoor Unit must be available and reachable; if the indoor unit cannot supply PoE power to the Nokia FastMile Outdoor Unit, then a Nokia-approved PoE injector must be used in conjunction with the indoor unit

6.3.1 Lightning protection

Be sure to observe the following lightning protection information:



Danger — If you are installing the Nokia FastMile Outdoor Unit above roof level, check that lightning rods are above the planned installation location.

PoE+ capable surge protectors should be used if the outside cabling is longer than 10 meters (32 feet). If the outside cable length is less than 10 meters (32 feet), no protection is required.

Only use a properly earthed wall socket for powering the indoor unit or PoE+ injector.

6.4 Installation steps for the Nokia FastMile Outdoor Unit

The Nokia FastMile Outdoor Unit can be installed by using the Nokia Field Assistant app in conjunction with the following steps.

The Nokia Field Assistant app must be installed on a mobile phone as indicated in section 6.3 before you start the Nokia FastMile Outdoor Unit installation procedure.

The following need to be considered before the start of Nokia FastMile Outdoor Unit installation procedure:

- Follow the installation steps with exact order described in Procedure 6
- During the installation procedure and especially during base station location, you need to avoid sending the Nokia Field Assistant app to background or press back and forth options, otherwise the procedure will fail and you won't be able to register the Subscription ID again since it will be considered already registered.
- During the installation procedure you need to ensure that the connection between the Nokia Field Assistant app and the Nokia Altiplano FastMile Controller (WiFi or LTE) and the connection between the Nokia Field Assistant app and the Nokia FastMile Outdoor Unit (Bluetooth and VPN) will not be lost otherwise installation will fail.
- You need to finish the Nokia FastMile Outdoor Unit installation procedure within two hours from the time the Nokia Field Assistant app is connected to the Nokia Altiplano FastMile Controller, otherwise the installation procedure will fail.

Procedure 6 To install the Nokia FastMile Outdoor Unit

- 1 Connect the mobile phone to the Internet and open the Nokia Field Assistant app on the phone.

A splash screen appears on screen for a few seconds.

Figure 9 shows the splash screen.

Figure 9 Splash screen



In the next screens, you can:

- learn about the Nokia Field Assistant app by tapping on the “More” option
- get information about the open source software included in Nokia Field Assistant by tapping on the “Open source licenses” option

-
- 2 After the splash screen has cleared, the Nokia Field Assistant app prompts you to scan the QR code of the Nokia FastMile Outdoor Unit so that the app can access the MAC address, unique device identifier, enterprise id, and device type of the Nokia FastMile Outdoor Unit.

Tap on “Scan” to start the scan of the QR code.

Figure 10 shows the screen for preparing to scan the QR code.

Figure 10 Screen for preparing to scan the QR code

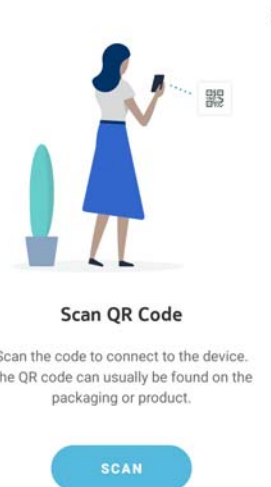

Use the viewfinder of the phone to align with the QR code on the shipping package of the Nokia FastMile Outdoor Unit.

Figure 11 shows the QR code screen.

Figure 11 QR code screen



-
- 3** After successful scan of the QR code, the Nokia Field Assistant app redirects you to the home screen so that you can start a fresh install for the Nokia FastMile Outdoor Unit.

Tap on the “Fresh Install” option from the main menu of the Nokia Field Assistant app.

Figure 12 shows the Fresh Install option.

Figure 12 Screen showing the Fresh Install option



-
- 4 After you select the Fresh Install option, the Nokia Field Assistant app needs you to log in to the Nokia Altiplano FastMile Controller.

A login screen prompts you to input the user name, password, FastMile Controller URL, and the Subscription ID.

Figure 13 shows the prompt to log in to the Nokia Altiplano FastMile Controller.

Figure 13 Screen for logging in to the Nokia Altiplano FastMile Controller

←

Enter your Field Assistant Login
Credentials

Username

Password

Controller URL
https://

Subscription Id

LOGIN

When the button is enabled (that is, it turns to blue), tap on “Login” to log in to the Nokia Altiplano FastMile Controller

-
- 5** The Nokia Field Assistant app provides instructions to find a base station.

Figure 14 shows the screen that indicates to use Nokia Field Assistant app to start finding a nearby base station.

Figure 14 Screen indicating to use the Nokia Field Assistant app to start finding a nearby base station

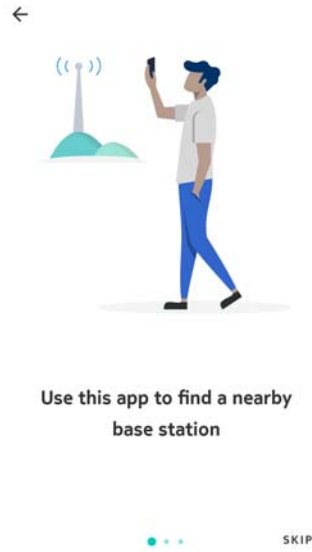

Figure 15 shows to screen to hold vertically for first person view.

Figure 15 Screen showing to hold vertically for first person view

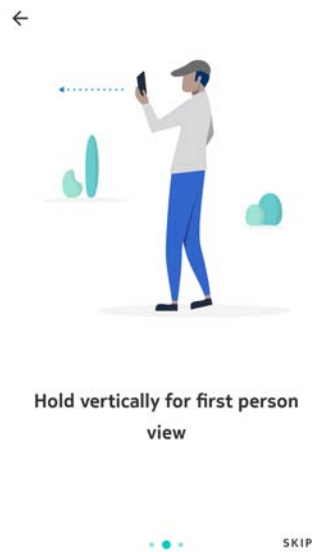
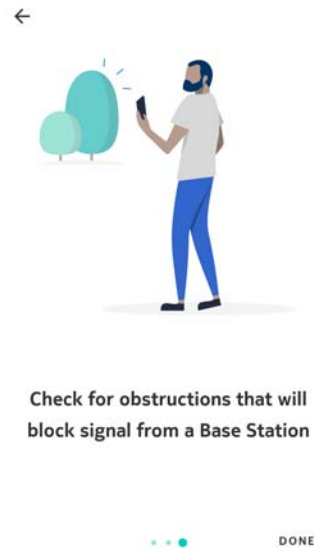

Figure 16 shows the screen indicating to check for obstructions that will block the signal from a base station.

Figure 16 Screen showing to check for obstructions that will block signal from a base station



-
- 6 The Nokia Field Assistant app sends the Subscription ID, Device Unique Identifier (DUID), Device Type, Geocoordinates of Mobile phone to the Nokia Altiplano FastMile Controller using token authorization.

The Nokia Field Assistant app retrieves the Cell ID and Geocoordinates of provided Cell ID from the Nokia Altiplano FastMile Controller.

-
- 7 The Nokia Field Assistant app prompts you to allow access to location of the Nokia FastMile Outdoor Unit.

Figure 17 shows the prompt to allow access to the device's location.

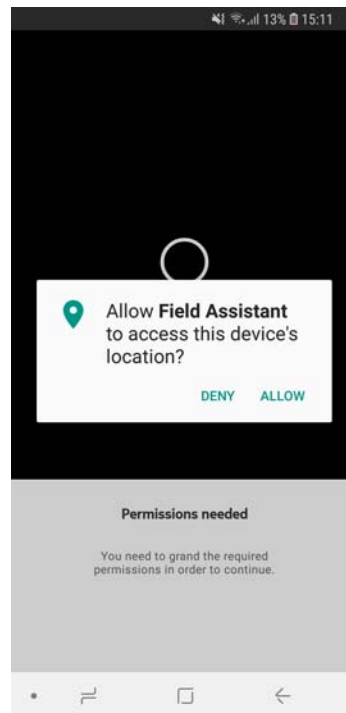
Figure 17 Screen with prompt to allow access to the device's location

Tap on “Allow” to allow access to the location of the Nokia FastMile Outdoor Unit.

- 8 The Nokia Field Assistant app uses augmented reality and the mobile phone's camera to help you identify the direction that the Nokia FastMile Outdoor Unit should be facing, based on base station location information stored by the server.



Note — Do not send the Nokia Field Assistant app to Background or press back and forth otherwise the installation will fail and you won't be able to repeat procedure for same Subscriber ID.

When the optimal direction is detected, tap on the “Done” option.

The Nokia Field Assistant app updates information on the screen dynamically to indicate the status of the process.

The Nokia Field Assistant app can do the following:

- inform you about the location status, the fetching of the base station location, and so on
- if the base station is not visible, the app prompts you with an arrow to move left or right
- if the base station is visible in the screen you need to center it in a circle that the app provides
- if the base station is centered, the app enables the “Done” option so that you can proceed with the installation
- if the direction of the phone is inaccurate, the app informs you
- if fetching of the base station location from the server went wrong, the app informs you user

Figure 18 shows the screen with a circle on the base station. The green color in the circle means that this is a good place to mount the Nokia FastMile Outdoor Unit with respect to the location of the base station.

Figure 18 Screen showing good location with respect to the base station

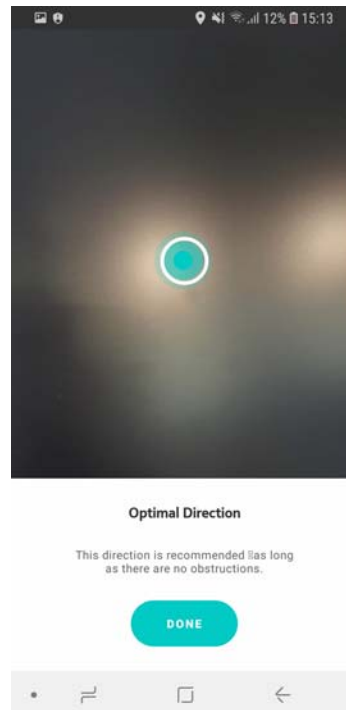

Tap on “Done”.

- 9 Use a pencil or similar device to mark the location where the Nokia FastMile Outdoor Unit is to be mounted and be sure to note the direction that the Nokia FastMile Outdoor Unit will need to face with respect to the base station.

Confirm that the location is suitable for considerations within the home, and that the Ethernet cable (with or without an additional Cat5e shielded Ethernet cable attached) can be safely and securely run through the wall and inside the home from the Nokia FastMile Outdoor Unit to the indoor unit or PoE injector or to the prospective indoor unit or PoE injector location. The indoor unit can be a residential gateway such as the Nokia 7368 ISAM CPE A-020W-A; the PoE injector must be a Nokia-approved PoE injector.

- 10** Mount the Nokia FastMile Outdoor Unit and make connections as described below.

As part of this step you will be working with most of the interfaces shown in Figure 19.

Figure 19 Location of physical interfaces on the Nokia FastMile Outdoor Unit

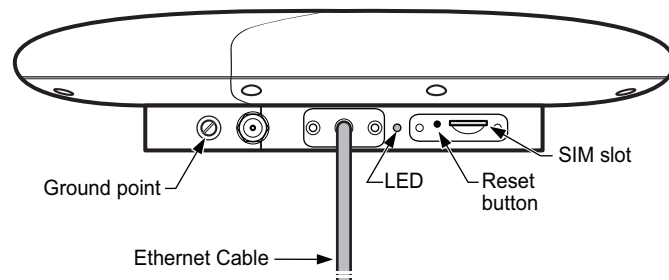

27898

- i** Unpack the following from the shipping package:
 - Nokia FastMile Outdoor Unit
 - wall-mount bracket; note that the wall mount-bracket is shipped attached to the mounting plate with three fasteners
 - two screws for attaching the mounting plate to the Nokia FastMile Outdoor Unit
- ii** Separate the mounting plate from the wall-mount bracket and save the three fasteners for securing the mounting plate to the wall-mount bracket later on in this step
- iii** Use the two supplied screws to attach the mounting plate to the back of the Nokia FastMile Outdoor Unit as shown in Figure 20.

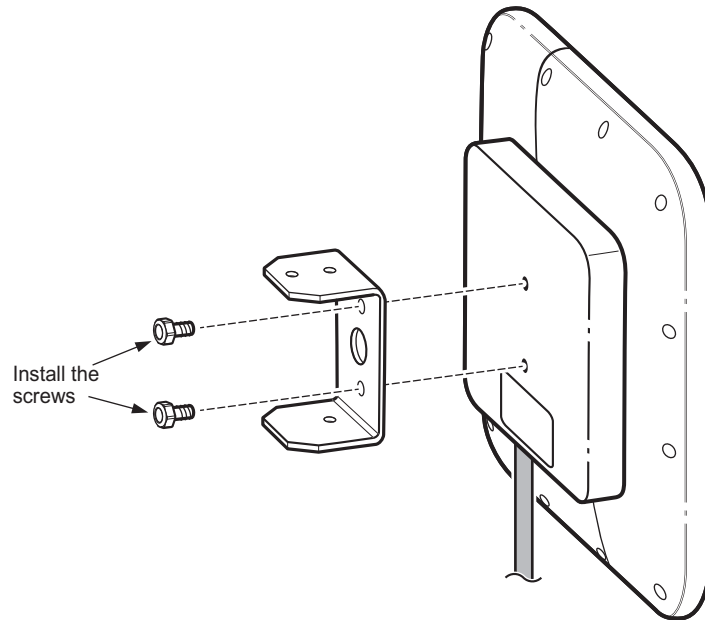
Figure 20 Attaching the mounting plate to the Nokia FastMile Outdoor Unit

27899

- iv** Use a TROX T8 screwdriver to remove the cover from the SIM slot of the Nokia FastMile Outdoor Unit, insert a valid Nano/4FF SIM card in the slot, and re-attach the cover on the SIM slot. Figure 19 shows the location of the SIM slot on the Nokia FastMile Outdoor Unit.
- v** As appropriate, drill a hole through the wall for the Ethernet cable from the Nokia FastMile Outdoor Unit to be able to pass through. It is recommended that you drill the hole for the Ethernet cable at a slight angle so that any water that might enter the hole will run down towards the outside of the home.
- vi** As appropriate, drill two anchor holes for the wall-mount bracket on the outside of the wall. The anchor holes should be one directly above the other. You can use the wall-mount bracket as a template for the anchor holes.
- vii** Mount the wall-mount bracket on the outside of the wall using two appropriate fasteners in the anchor holes drilled in the previous step, as shown in Figure 21. Ensure that the wall-mount bracket is in a vertical position on the wall.

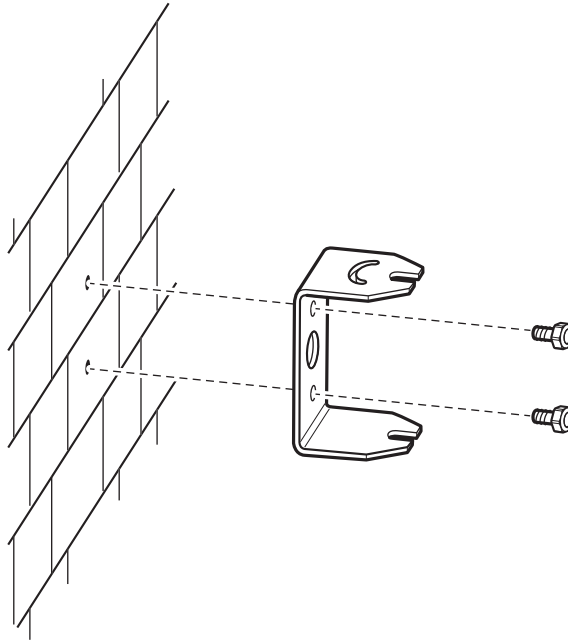
Figure 21 Mounting the wall-mount bracket

27900

- viii Line up the mounting plate (attached earlier on the back of the Nokia FastMile Outdoor Unit with the wall-mount bracket and temporarily secure in place with the three saved fasteners as shown in Figure 22. The figure shows one of the fasteners already in place.

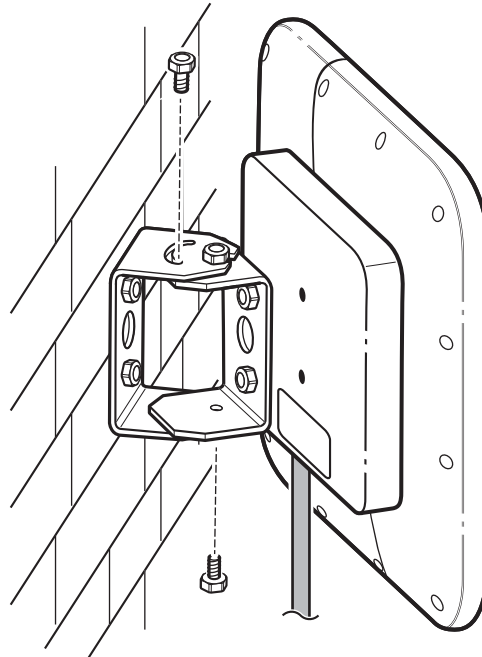
Figure 22 Mounting the Nokia FastMile Outdoor Unit

27901

- ix If the Nokia FastMile Outdoor Unit is to be connected to an outside ground, use a hex key to connect the ground cable to the ground connection point of the Nokia FastMile Outdoor Unit and ensure that the far end of the ground cable is connected to a suitable ground point. Figure 19 shows the location of the ground point on the Nokia FastMile Outdoor Unit.
- x Pass the Ethernet cable from the Nokia FastMile Outdoor Unit through the hole in the wall and use silicone or other waterproof sealing or caulking compound to seal the hole.
- xi If required, rotate the Nokia FastMile Outdoor Unit +/-35 degrees horizontally for best alignment with the LTE base station. Tighten the fasteners to securely hold the Nokia FastMile Outdoor Unit in place.
- xii If the Ethernet cable from the Nokia FastMile Outdoor Unit will not be long enough to reach the indoor unit or PoE injector, make the cable longer by attaching an additional Cat5e shielded Ethernet cable to it. The maximum combined length is 40 m (131 ft).

Do not run the cable to the indoor unit or PoE injector yet.
- xiii Confirm that the indoor unit that is going to provide service for the Nokia FastMile Outdoor Unit is installed and powered up, or install and power up the indoor unit. The indoor unit indoor unit can be a residential gateway such as the Nokia 7368 ISAM CPE A-020W-A.

- xiv If the Nokia FastMile Outdoor Unit is not going to be powered from the indoor unit, set up a Nokia-approved PoE injector that is going to provide power over Ethernet to the Nokia FastMile Outdoor Unit, including connecting the PoE injector to the indoor unit at the PoE injector's "LAN" port and to power. Figure 23 shows the location of the "LAN" port on a PoE injector. Specifics of the set up will depend on the PoE injector and indoor unit.

Figure 23 Location of ports on a PoE injector

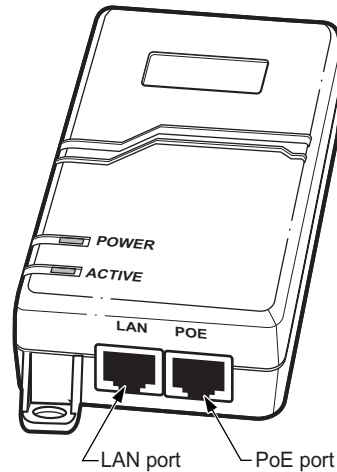

27902

- xv Connect the Nokia FastMile Outdoor Unit to its power source:
- If the Nokia FastMile Outdoor Unit is going to be powered directly by the indoor unit, safely and securely run the Ethernet cabling from the hole in the wall, through the home to the indoor unit, and make the connection at the indoor unit. The Nokia FastMile Outdoor Unit powers up when it receives power from the indoor unit.
 - If the Nokia FastMile Outdoor Unit is going to be powered by the PoE injector, safely and securely run the Ethernet cable from the hole in the wall, through the home to the PoE injector, and make the connection at the PoE injector's "POE" port. Figure 23 shows the location of the "POE" port on a PoE injector. Specifics of the set up will depend on the PoE injector. The Nokia FastMile Outdoor Unit powers up when it receives power from the PoE injector.
- xvi Check the LED on the Nokia FastMile Outdoor Unit. The LED is located on the bottom of the Nokia FastMile Outdoor Unit as shown in Figure 19. Table 11 describes the LED behavior.

Table 11 LED behavior description

LED color	LED priority	LED behavior	Status information
Blue	First priority	Blinking	Bluetooth connection in progress
		Solid	Bluetooth connection established
		Off	No Bluetooth connection
Red	Second priority	Blinking	Critical alarm
		Solid	Major or minor alarm
		Off	No alarm
Green	Third priority	Blinking twice per second	Kernel and application start up
		Blinking one per second	Application start up and OAM link established
		Off	OAM link established

11 The Nokia Field Assistant app prompts you to connect to the Nokia FastMile Outdoor Unit.

Tap on “Connect” to initiate a Bluetooth connection via MAC address to the Nokia FastMile Outdoor Unit.

Figure 24 shows the screen for the connect prompt.

Figure 24 Screen showing the connect prompt



-
- 12 If Bluetooth is not enabled, the Nokia Field Assistant app informs you than an app wants to turn Bluetooth on.

Allow the Bluetooth enabling request by tapping on “Allow”.

Figure 26 shows the screen for the Bluetooth enabling request.

Figure 25 Screen showing the Bluetooth enabling request

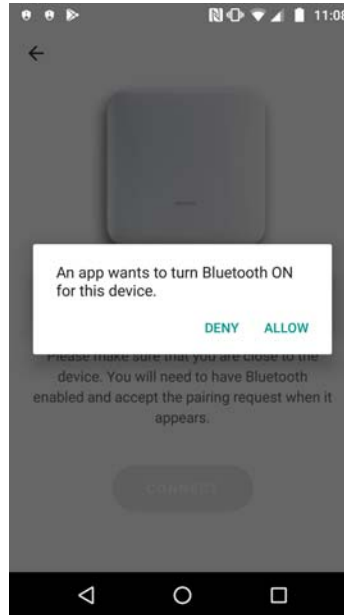

-
- 13 The Nokia Field Assistant app requests that you allow the Bluetooth pairing request.

Allow the Bluetooth pairing request by tapping on “Pair”.



Note — Only one active Bluetooth connection is allowed towards the Nokia FastMile Outdoor Unit. This means that at any one time, only one mobile phone device can have a Bluetooth connection to the Nokia FastMile Outdoor Unit. In case of a new Bluetooth connection attempt from a different mobile phone, at the same time, the new connection will not be accepted by the Nokia FastMile Outdoor Unit.

Figure 26 shows the screen for the Bluetooth pairing request.

Figure 26 Screen showing the Bluetooth pairing request

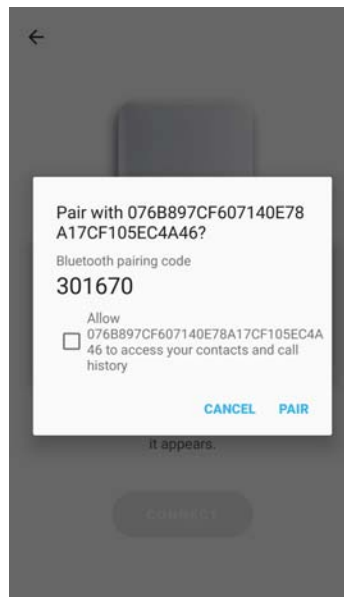

- 14** The Nokia Field Assistant app prompts you to enable the VPN profile.

Enable the VPN profile by tapping on “Connect”.



Note — Any preexisting VPN connection on the mobile phone will be deactivated when you enable the VPN profile.

Figure 27 shows the screen for enabling the VPN profile.

Figure 27 Screen for enabling the VPN profile

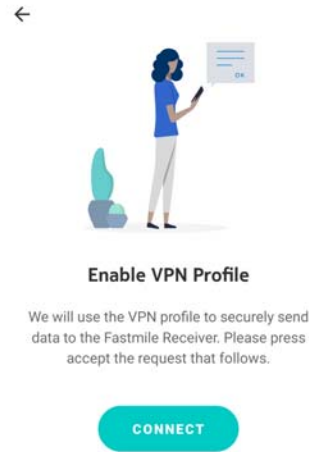

- 15** After successfully enabling the VPN profile, the Nokia Field Assistant app will log in to the Nokia FastMile Outdoor Unit to exchange certificates and apply necessary configuration.

A login screen appears and prompts you to input credentials for the Nokia FastMile Outdoor Unit.

When the button is enabled (that is, it turns to blue), you can tap on “Connect” to continue.

Figure 28 shows the login prompt.

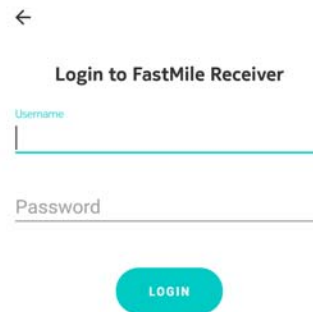
Figure 28 Screen showing the login prompt

←

Login to FastMile Receiver

Username

Password

LOGIN

-
- 16** After successful credential validation from the Nokia FastMile Outdoor Unit is done, the Nokia Field Assistant app retrieves the ODU Public Key and sends it to the Nokia Altiplano FastMile Controller along with the Subscription ID. The Nokia Altiplano FastMile Controller uses the ODU Public Key in order to encrypt the config package. The Nokia Field Assistant app retrieves the config package including the encrypted Configuration file, the Public Key (signed by Operator CA) and the Operator CA Certificate.

The Nokia Field Assistant app relays configuration file towards the Nokia FastMile Outdoor Unit.

The Nokia Field Assistant app waits for the Nokia FastMile Outdoor Unit to acknowledge that has received the configuration file.

-
- 17** After successful receipt of the configuration file from the Nokia FastMile Outdoor Unit, the Nokia Field Assistant informs you that the Nokia FastMile Outdoor Unit will be rebooted and prompts you to press “Done” in order to navigate back to main menu.

Figure 29 shows the screen when 0% of the reboot is complete.

Figure 29 Screen showing that 0% of the reboot process is complete

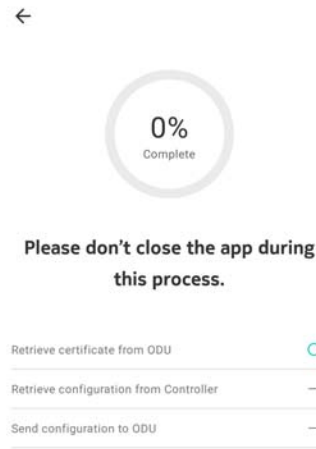

Figure 30 shows the screen when all of the reboot process is complete.

Figure 30 Screen showing that 100% of the reboot process is complete



Tap on “Done” when the Nokia Field Assistant app indicates that the setup is complete.

-
- 18** After the Nokia FastMile Outdoor Unit has finished rebooting, tap on “Connect to Receiver” on the main menu of the Nokia Field Assistant app to connect to the Nokia FastMile Outdoor Unit.

The Nokia Field Assistant app prompts you to connect again to the Nokia FastMile Outdoor Unit via Bluetooth and afterwards to enable VPN as described in earlier steps.

-
- 19** The Nokia Field Assistant shows the status of the connection to the Nokia FastMile Outdoor Unit.

There are three possible states:

- connecting: the Nokia FastMile Outdoor Unit is connecting to LTE network
- offline: the Nokia FastMile Outdoor Unit is not connected to LTE network
- online: the Nokia FastMile Outdoor Unit is connected to the LTE network and is communicating with the Nokia Altiplano FastMile Controller

Figure 31 shows the connecting state.

Figure 31 Screen showing connecting state

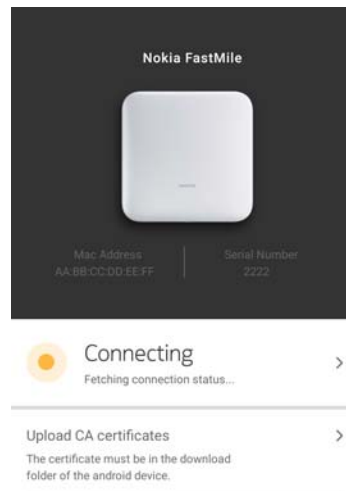

Figure 32 shows the offline state.

Figure 32 Screen showing offline state

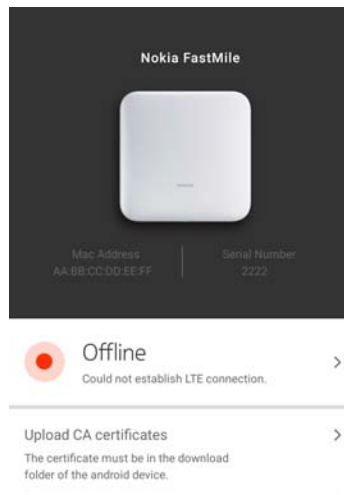
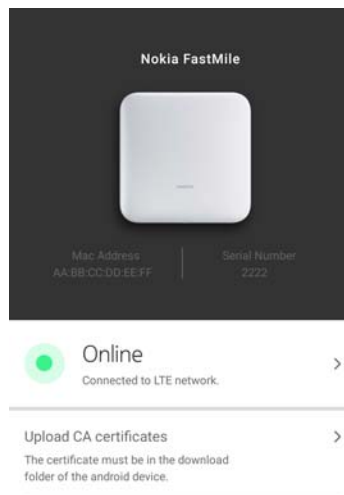

Figure 33 shows the online state.

Figure 33 Screen showing online state



20 You can view the following information by selecting the Connection Status option of the main screen:

- General stats:
 - bytes sent: the total number of bytes sent on the interface
 - bytes received: the total number of bytes received on the interface
- LTE cell stats:
 - cell ID: The External Cell Interface (ECI) of cell
 - connection state: Does the Nokia FastMile Outdoor Unit connect to this cell
 - status: The current operational state of the PDN connection
 - EARFCN: The carrier frequency in the uplink and downlink is designated by the E-UTRA. Absolute Radio Frequency Channel Number (EARFCN) in the range 0 - 65535.
 - PCI: The physical cellid of cell
 - RSRP: The average value of Reference Signal Received Power (dBm) in measured interval, resolution 1dBm.
 - RSRQ: The average value of Reference Signal Received Quality (dB) in measured interval, resolution 1dB.
 - RSSI: The average value of Received Signal Strength Indicator (dBm) in measured interval, resolution 1dBm.
 - SINR: The average value of Signal-to-Interference-plus-Noise Ratio (dB) in measured interval, resolution 1dB.

Figure 34 shows an example of the System state screen.



Note — After Fresh Installation and when LTE attach is successful, some of the values displayed will not be updated for some time (values will be zero until the first 15 minutes interval is finished).

Figure 34 System state screen

System State	
General Stats	
Bytes Sent	101
Bytes Received	100
LTE Cell stats	
Cell Id	102
Connection state	true
Status	Attached.
Earfcn	1000
PCI	150
RSRP	10
RSRQ	11

21 Additionally, the main menu of the Nokia Field Assistant app displays an additional option “Upload CA certificates” where you can transfer updated certificates (stored under download mobile phone’s directory) towards the Nokia FastMile Outdoor Unit.

- i Tap on the “Upload CA certificates” option.

Figure 35 shows the screen that has the “Upload CA certificates” option.

Figure 35 Screen that has the “Upload CA certificates” option

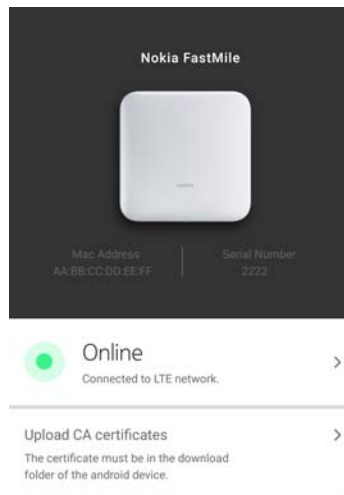

- ii Select the required Upload CA certificates and tap on “Ok”. Note that the certificates must be in the download folder of the mobile phone before you can upload them to the Nokia FastMile Outdoor Unit.

Figure 36 shows the screen that lists the CA certificates.

Figure 36 Screen that lists the CA certificates

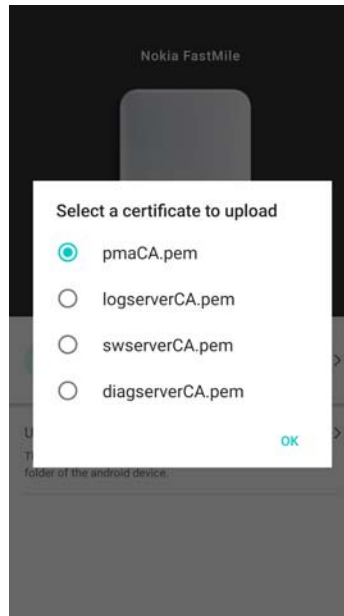

The following CA certificates are supported for the Nokia FastMile Outdoor Unit:

- pmaCA.pem (used for authenticating the Nokia Altiplano FastMile Controller)
- logserverCA.pem (used for authenticating the log server)
- swserverCA.pem (used for authenticating the software upgrade server)
- diagserverCA.pem (used for authenticating the optional diagnostics server)

iii Figure 37 shows the screen that indicates that uploading of the CA certificates was successful.

Figure 37 Screen indicating that uploading of the CA certificates was successful

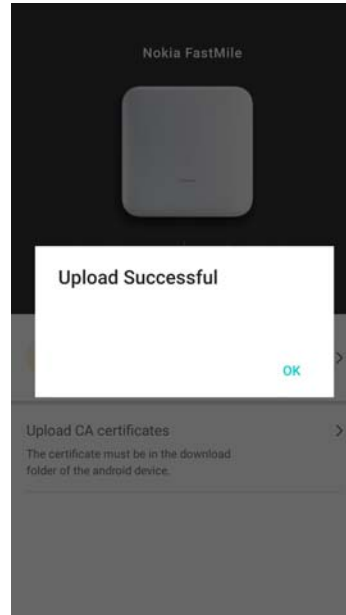

Tap on "Ok" to clear the message.

6.5 Post-installation of the Nokia FastMile Outdoor Unit

After installation, the Nokia FastMile Outdoor Unit can be accessed by using the Nokia Field Assistant app in conjunction with the following steps.

The Nokia FastMile Outdoor Unit must be installed as indicated in section 6.4 before you can do this post-installation procedure.

Procedure 7 To access an installed Nokia FastMile Outdoor Unit

- 1 Connect the mobile phone to the Internet and open the Nokia Field Assistant app on the phone.

A splash screen appears on screen for a few seconds.

Figure 38 shows the splash screen.

Figure 38 Splash screen

In the next screens, you can:

- learn about the Nokia Field Assistant app by tapping on the “More” option
- get information about the open source software included in Nokia Field Assistant by tapping on the “Open source licenses” option

-
- 2** After the splash screen has cleared, the Nokia Field Assistant app prompts you to scan the QR code of the Nokia FastMile Outdoor Unit so that the app can access the MAC address, Unique Device Identifier, enterprise id, and device type of the Nokia FastMile Outdoor Unit.

Tap on “Scan” to start the scan of the QR code.

Figure 39 shows the screen for preparing to scan the QR code.

Figure 39 Screen for preparing to scan the QR code

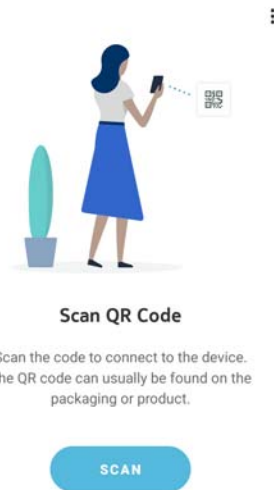

Use the viewfinder of the phone to align with the QR code on the shipping package of the Nokia FastMile Outdoor Unit.

Figure 40 shows the QR code screen.

Figure 40 QR code screen



-
- 3 After successful scan of the QR code, the Nokia Field Assistant app redirects you to the home screen so that you can connect to the Nokia FastMile Outdoor Unit.

Tap on the “Connect to Receiver” option from the main menu of the Nokia Field Assistant app.

Figure 41 shows the Connect to Receiver option.

Figure 41 Screen showing the Connect to Receiver option



-
- 4 The Nokia Field Assistant app prompts you to connect to the Nokia FastMile Outdoor Unit.
Tap on “Connect” to initiate a Bluetooth connection via MAC address to the Nokia FastMile Outdoor Unit.

Figure 42 shows the screen for the connect prompt.

Figure 42 Screen showing the connect prompt

- 5 If Bluetooth is not enabled, the Nokia Field Assistant app informs you than an app wants to turn Bluetooth on.

Allow the Bluetooth enabling request by tapping on "Allow".

Figure 43 shows the screen for the Bluetooth enabling request.

Figure 43 Screen showing the Bluetooth enabling request

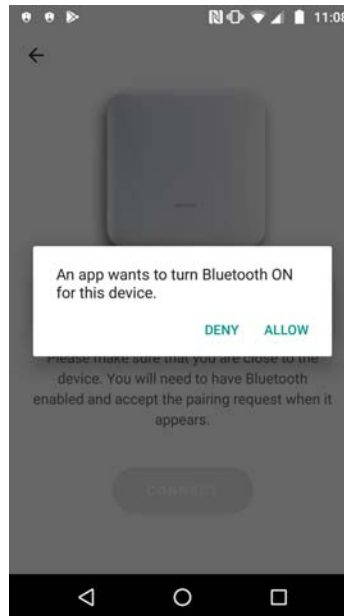

- 6 The Nokia Field Assistant app requests that you allow the Bluetooth pairing request.
Allow the Bluetooth pairing request by tapping on "Pair".



Note — Only one active Bluetooth connection is allowed towards the Nokia FastMile Outdoor Unit. This means that at any one time, only one mobile phone device can have a Bluetooth connection to the Nokia FastMile Outdoor Unit. In case of a new Bluetooth connection attempt from a different mobile phone, at the same time, the new connection will not be accepted by the Nokia FastMile Outdoor Unit.

Figure 44 shows the screen for the Bluetooth pairing request.

Figure 44 Screen showing the Bluetooth pairing request

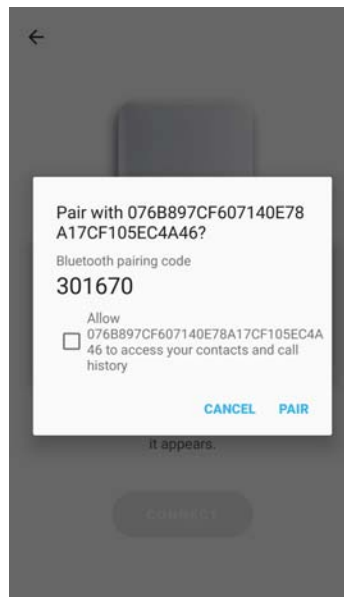

-
- 7 The Nokia Field Assistant app prompts you to enable the VPN profile.

Enable the VPN profile by tapping on “Connect”.



Note — Any preexisting VPN connection on the mobile phone will be deactivated when you enable the VPN profile.

Figure 45 shows the screen for enabling the VPN profile.

Figure 45 Screen for enabling the VPN profile

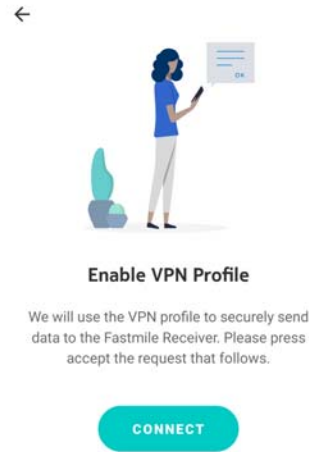

- 8 After successfully enabling the VPN profile, the Nokia Field Assistant app will log in to the Nokia FastMile Outdoor Unit to exchange certificates and apply necessary configuration.

A login screen appears and prompts you to input credentials for the Nokia FastMile Outdoor Unit.

When the button is enabled (that is, it turns to blue), you can tap on “Connect” to continue.

Figure 46 shows the login prompt.

Figure 46 Screen showing the login prompt

←

Login to FastMile Receiver

Username

Password

LOGIN

- 9 You can view the following information by selecting the Connection Status option of the main screen:
- General stats:
 - bytes sent: the total number of bytes sent on the interface
 - bytes received: the total number of bytes received on the interface
 - LTE cell stats:
 - cell ID: The External Call Interface of cell
 - connection state: Does ODU connect to this cell
 - status: The current operational state of the PDN connection
 - EARFCN: The carrier frequency in the uplink and downlink is designated by the E-UTRA. Absolute Radio Frequency Channel Number (EARFCN) in the range 0 - 65535.
 - PCI: The physical cellid of cell
 - RSRP: The average value of Reference Signal Received Power (dBm) in measured interval, resolution 1dBm.
 - RSRQ: The average value of Reference Signal Received Quality (dB) in measured interval, resolution 1dB.
 - RSSI: The average value of Received Signal Strength indicator (dBm) in measured interval, resolution 1dBm.
 - SINR: The average value of Signal-to-Interference-plus-Noise Ratio (dB) in measured interval, resolution 1dB.

Figure 47 shows an example of the System state screen.

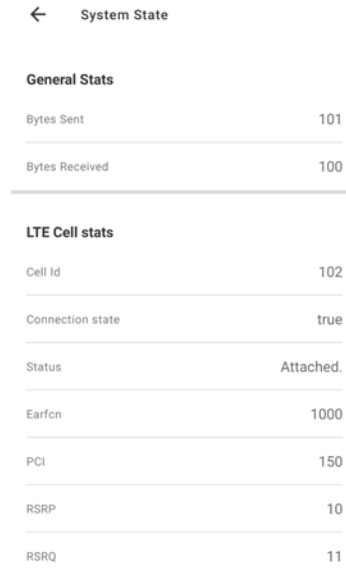
Figure 47 System state screen

System State	
General Stats	
Bytes Sent	101
Bytes Received	100
LTE Cell stats	
Cell Id	102
Connection state	true
Status	Attached.
Earfcn	1000
PCI	150
RSRP	10
RSRQ	11

10 Additionally, the main menu of the Nokia Field Assistant app displays an additional option “Upload CA certificates” where you can transfer updated certificates (stored under download mobile phone’s directory) towards the Nokia FastMile Outdoor Unit.

- i** Tap on the “Upload CA certificates” option.

Figure 48 shows the screen that has the “Upload CA certificates” option.

Figure 48 Screen that has the “Upload CA certificates” option

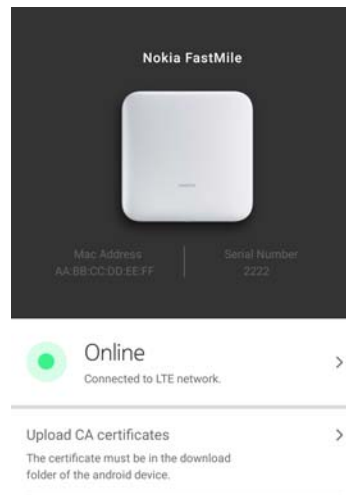

- ii Select the required Upload CA certificates and tap on “Ok”. Note that the certificates must be in the download folder of the mobile phone before you can upload them to the Nokia FastMile Outdoor Unit.

Figure 49 shows the screen that lists the CA certificates.

Figure 49 Screen that lists the CA certificates

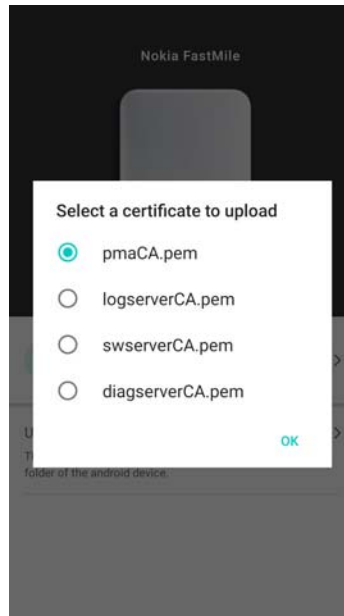

The following CA certificates are supported for the Nokia FastMile Outdoor Unit:

- pmaCA.pem (used for authenticating the Nokia Altiplano FastMile Controller)
- logserverCA.pem (used for authenticating the log server)
- swserverCA.pem (used for authenticating the software upgrade server)
- diagserverCA.pem (used for authenticating the optional diagnostics server)

iii Figure 50 shows the screen that indicates that uploading of the CA certificates was successful.

Figure 50 Screen indicating that uploading of the CA certificates was successful

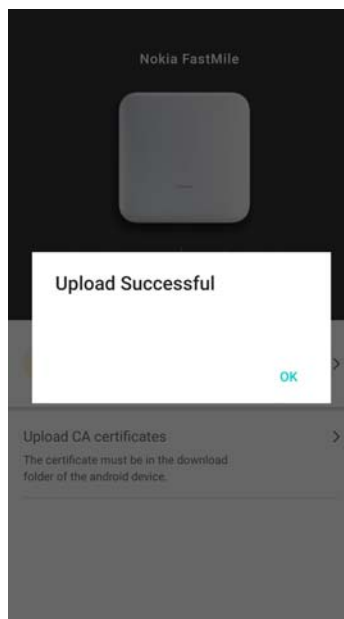

Tap on "Ok" to clear the message.

7 Troubleshooting

7.1 Potential problems during installation and startup phase

7.2 Potential problems during execution phase

7.1 Potential problems during installation and startup phase

The following are potential problems that can occur during the installation and startup phase.

7.1.1 Nokia FastMile Outdoor Unit cannot attach to LTE network due to hardware mismatch

This issue can be due to E-UTRA band support mismatch between the Nokia FastMile Outdoor Unit and LTE network because the Nokia FastMile Outdoor Unit is not the correct variant for the E-UTRA band of the LTE network.

Check the variants listed in section 5.3 to see if the variant you are installing supports the E-UTRA band of the LTE network. If there is a mismatch, change the Nokia FastMile Outdoor Unit to a variant that supports the E-UTRA band of the LTE network. If the variant is correct, contact operator.

7.1.2 Failed to get Base Station Location

One possible cause of this error, visible on Augmented Reality View, is the input of wrong Subscription ID at login step to the Nokia Altiplano FastMile Controller.

By pressing Retry button problem persists.

In order to overcome this issue, press Back option until you reach login step and enter again a valid Subscription ID.

7.1.3 Subscriber has already registered a receiver with its serial number to controller

This problem can occur when the Subscriber ID given at login step to the Nokia Altiplano FastMile Controller is already registered.

In order to overcome this issue, you need to delete the Subscriber ID registration at the Nokia Altiplano FastMile Controller side. After deletion, try logging in again with the same Subscriber ID by pressing the Back option until you reach the login step or by starting again.

7.2 Potential problems during execution phase

The following are potential problems that can occur during the execution phase.

7.2.1 Nokia FastMile Outdoor Unit firmware upgrade to latest build failed

This issue can be due to a radio signal issue in the LTE network for the Nokia FastMile Outdoor Unit.

If another LTE network is available, select it for the Nokia FastMile Outdoor Unit. When the connection to the Nokia Altiplano FastMile Controller is recovered, check the radio signal condition. If no problem, then perform the firmware upgrade again.

If problem persists, contact operator.

7.2.2 Trace request

The Nokia FastMile Outdoor Unit has a trace and log function that can be used for troubleshooting purposes and for help in performing root cause analysis.

If internet is available for the Nokia FastMile Outdoor Unit, contact Nokia to request that the trace and log function be used for the Nokia FastMile Outdoor Unit.

The trace log can be uploaded to the Nokia Altiplano FastMile Controller or other HTTP file servers.

8 Appendix A: Specifications

8.1 Specifications

8.1 Specifications

Table 12 provides some specifications for the Nokia FastMile Outdoor Unit.

Table 12 Specifications for the Nokia FastMile Outdoor Unit

Item	Description
Dimensions	Compact: 23.5 cm by 23.5 cm by 5.2 cm (9.3 in by 9.3 in by 2 in) ABA: 31.8 cm by 31.8 cm by 5.6 cm (12.5 in by 12.5 in by 2.2 in)
Weight	Compact: 1.3 kg (2.9 lb) ABA: 2 kg (4.4. lb)
Power consumption	Less than 8 w
Operating altitude	Maximum operating altitude is 3048 m (10 000 ft) above mean sea level
Non-operating altitude	Maximum non-operating altitude is 12 192 m (40 000 ft) above mean sea level
Operating temperature	−30°C to 65°C (−22°F to 149°F)
Storage temperature	−40°C to 85°C (−85°F to 185°F)
Operating humidity	5% to 85% relative humidity, non-condensing
Storage humidity	5% to 93% relative humidity, non-condensing
IP rating	IP66 TYPE3

9 Appendix B: RF exposure

9.1 RF exposure

9.1 RF exposure

The international standard used for the assessment of this device provides simple conformity assessment methods for low power electronic and electrical equipment to an exposure limit relevant to electromagnetic fields (EMF).

Based on the compliance criteria for maximum permissible exposure as in EN 50385:2017 and CE Council Recommendation Directive 2014/53/EU, there should be a minimum of 50 cm separation distance from the user

10 Appendix C: FCC statements

10.1 FCC compliance statement

10.2 FCC radiation exposure statement

10.1 FCC compliance statement

Table 13 provides the FCC ID for the variants of the Nokia FastMile Outdoor Unit.

Table 13 FCC ID for Nokia FastMile Outdoor Unit variants

Version and variant	Model	FCC ID
Compact B7/B41	3FE75113ACAA	2ADZR23002690FM20

Any Changes or modifications not expressly approved by the party responsible for compliance could void the user's authority to operate the equipment.

This device complies with part 15 of the FCC Rules. Operation is subject to the following two conditions:

- 1) This device may not cause harmful interference, and
- 2) This device must accept any interference received, including Interference that may cause undesired operation.

This equipment has been tested and found to comply with the limits for a Class B digital device, pursuant to part 15 of the FCC Rules. These limits are designed to provide reasonable protection against harmful interference in a residential installation. This equipment generates, uses and can radiate radio frequency energy and, if not installed and used in accordance with the instructions, may cause harmful interference to radio communications. However, there is no guarantee that interference will not occur in a particular installation. If this equipment does cause harmful interference to radio or television reception, which can be determined by turning the equipment off and on, the user is encouraged to try to correct the interference by one or more of the following measures:

- Reorient or relocate the receiving antenna.
- Increase the separation between the equipment and receiver.
- Connect the equipment into an outlet on a circuit different from that to which the receiver is connected.
- Consult the dealer or an experienced radio/TV technician for help.

10.2 FCC radiation exposure statement

This equipment complies with FCC radiation exposure limits set forth for an uncontrolled environment. This equipment should be installed and operated with minimum distance 50 cm between the radiator and your body.

11 Glossary

This glossary provides the expansions and optional descriptions of most acronyms and initialisms that appear in this document.

3GPP	3rd Generation Partnership Project
ABA	Automated Beam Alignment
ACS	Auto Configuration Server
ALED	Alcatel-Lucent Electronic Download
ANSI	American National Standards Institute
APN	Access Point Name
CA	Certificate authority
CRoHS	China Restriction of Hazardous Substances
DSCP	Differentiated Services Code Point
DUID	Device Unique Identifier
EARFCN	E-UTRA Absolute Radio Frequency Channel Number
ECI	External Call Interface
EPC	Evolved Packet Core
E-UTRA	Evolved Universal Terrestrial Radio Access
EIP	Electronic Information Products
EMC	Electromagnetic Compatibility
EMI	Electromagnetic Interference
EPC	Evolved Packet Core
ESD	Electrostatic Discharge
ETL	Electrotechnical Laboratory
ETSI	European Telecommunications Standards Institute
FCC	Federal Communications Commission
FDD	Frequency Division Duplex
FM	FastMile
HSS	Home Subscriber Server

IDU	Indoor Unit
IEEE	Institute of Electrical and Electronics Engineers
IP	International Protection or Internet Protocol
LAN	Local Area Network
LED	Light Emitting Diode
LTE	Long-Term Evolution
MAC	Media Access Control
MCV	Maximum Concentration Value or Minimum Concentration Value
MIMO	Multiple-Input Multiple-Output
MME	Mobility Management Entity
NAC	Network Access Control
NEC	National Electrical Code
OAM	Operations and Maintenance
ODU	Outdoor Unit
OLCS	On-line Customer Support
PCI	Physical Cell Identifier
PCRF	Policy and Charging Rules Function
PDF	Portable Document Format
PIN	Personal Identification Number
PoE	Power over Ethernet
QCI	QoS Class Identifier
QoS	Quality of Service
QR	Quick Response
RF	Radio Frequency
RoHS	Restriction of Hazardous Substances
RSRP	Reference Signal Received Power
RSRQ	Reference Signal Received Quality
RSSI	Received Signal Strength Indicator

SIM	Subscriber Identify Module
SINR	Signal-to-Interference-plus-Noise Ratio
TCP	Transmission Control Protocol
TDD	Time Division Duplex
UDP	User Datagram Protocol
UL	Underwriters' Laboratories
URL	Uniform Resource Locator
VDC	Volts Direct Current
VPN	Virtual Private Network
WiFi	Wireless Fidelity
ZIP	Compressed File

Customer document and product support

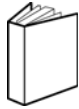

Customer documentation

[Customer Documentation Welcome Page](#)



Technical Support

[Customer Documentation Technical Support](#)



Documentation feedback

[Customer Documentation Feedback](#)