



Alcatel-Lucent 7368

INTELLIGENT SERVICES ACCESS MANAGER ONT

G-240W-B PRODUCT GUIDE

Alcatel-Lucent Proprietary
This document contains proprietary information of Alcatel-Lucent and is not to be disclosed
or used except in accordance with applicable agreements.
Copyright 2014 © Alcatel-Lucent. All rights reserved.

Alcatel-Lucent assumes no responsibility for the accuracy of the information presented, which is subject to change without notice.

Alcatel, Lucent, Alcatel-Lucent and the Alcatel-Lucent logo are trademarks of Alcatel-Lucent. All other trademarks are the property of their respective owners.

Copyright 2014 Alcatel-Lucent.
All rights reserved.

Disclaimers

Alcatel-Lucent products are intended for commercial uses. Without the appropriate network design engineering, they must not be sold, licensed or otherwise distributed for use in any hazardous environments requiring fail-safe performance, such as in the operation of nuclear facilities, aircraft navigation or communication systems, air traffic control, direct life-support machines, or weapons systems, in which the failure of products could lead directly to death, personal injury, or severe physical or environmental damage. The customer hereby agrees that the use, sale, license or other distribution of the products for any such application without the prior written consent of Alcatel-Lucent, shall be at the customer's sole risk. The customer hereby agrees to defend and hold Alcatel-Lucent harmless from any claims for loss, cost, damage, expense or liability that may arise out of or in connection with the use, sale, license or other distribution of the products in such applications.

This document may contain information regarding the use and installation of non-Alcatel-Lucent products. Please note that this information is provided as a courtesy to assist you. While Alcatel-Lucent tries to ensure that this information accurately reflects information provided by the supplier, please refer to the materials provided with any non-Alcatel-Lucent product and contact the supplier for confirmation. Alcatel-Lucent assumes no responsibility or liability for incorrect or incomplete information provided about non-Alcatel-Lucent products.

However, this does not constitute a representation or warranty. The warranties provided for Alcatel-Lucent products, if any, are set forth in contractual documentation entered into by Alcatel-Lucent and its customers.

This document was originally written in English. If there is any conflict or inconsistency between the English version and any other version of a document, the English version shall prevail.

Preface

This preface provides general information about the documentation set for optical network terminals (ONTs).

Scope

This documentation set provides information about safety, features and functionality, ordering, hardware installation and maintenance, and software installation procedures for the current release.

Audience

This documentation set is intended for planners, administrators, operators, and maintenance personnel involved in installing, upgrading, or maintaining the ONTs.

Required knowledge

The reader must be familiar with general telecommunications principles.

Acronyms and initialisms

The expansions and optional descriptions of most acronyms and initialisms appear in the glossary.

Assistance and ordering phone numbers

Alcatel-Lucent provides global technical support through regional call centers. Phone numbers for the regional call centers are available at the following URL: <http://www.alcatel-lucent.com/myaccess>.

For ordering information, contact your Alcatel-Lucent sales representative.

Alcatel-Lucent quality processes

Alcatel-Lucent's ONT manufacturing, testing, and inspecting practices are in compliance with GR-1252-CORE and TL 9000 requirements. These requirements are documented in the Operations Quality Plan 8BD-00023-4204-QRZZA, the Alcatel North American Quality Manual 8BD-00001-0000-QRZZA, and the Wireline Network Quality Manual 8AB-83179-0001-QRAAA.

The quality plans and practices adequately ensure that technical requirements and customer end-point requirements are met. The customer or its representatives may be allowed to perform on-site quality surveillance audits, as agreed upon during contract negotiations.

Safety information

For safety information, see the appropriate safety guidelines chapter.

Documents

Documents are available using ALED or OLCS.

Procedure 1 To download a ZIP file package of the customer documentation

- 1 Navigate to <http://www.alcatel-lucent.com/myaccess> and enter your user name and password. If you are a new user and require access to this service, please contact your Alcatel-Lucent sales representative.
 - 2 From the Technical Content for drop-down menu, choose the product.
 - 3 Click on Downloads: Electronic Delivery.
 - 4 Choose Documentation from the drop-down menu and click Next.
 - 5 Select the image from the drop-down menu and click Next.
 - 6 Follow the on-screen directions to download the file.
-

Procedure 2 To access individual documents

Individual PDFs of customer documents are also accessible through the Alcatel-Lucent Customer Support website.

- 1 Navigate to <http://www.alcatel-lucent.com/myaccess> and enter your user name and password. If you are a new user and require access to this service, please contact your Alcatel-Lucent sales representative.
 - 2 From the Technical Content for drop-down menu, choose the product.
 - 3 Click on Manuals and Guides to display a list of customer documents by title and part number. You can filter this list using the Release drop-down menu.
 - 4 Click on the PDF to open or save the file.
-

Special information

The following are examples of how special information is presented in this document.



Danger — Danger indicates that the described activity or situation may result in serious personal injury or death; for example, high voltage or electric shock hazards.

Danger indique que l'activité ou la situation décrite peuvent entraîner des blessures corporelles graves ou mortelles; par exemple, haute tension ou de risques d'électrocution.



Warning — Warning indicates that the described activity or situation may, or will, cause equipment damage or serious performance problems.

Warning indique que l'activité ou la situation décrite ne peut, ou la volont é des dommages matériels de cause ou de graves problèmes de performance



Caution — Caution indicates that the described activity or situation may, or will, cause service interruption.

Caution indique que l'activité ou la situation décrite peut, ou la volont é le service de la cause interruption.



Note — A note provides information that is, or may be, of special interest.

Une note fournit des informations qui est, ou peut être, d'un intérêt particulier.

Procedures with options or substeps

When there are options in a procedure, they are identified by letters. When there are required substeps in a procedure, they are identified by roman numerals.

Procedure 3 Example of options in a procedure

At step 1, you can choose option a or b. At step 2, you must do what the step indicates.

- 1 This step offers two options. You must choose one of the following:
 - a This is one option.
 - b This is another option.
 - 2 You must perform this step.
-

Procedure 4 Example of required substeps in a procedure

At step 1, you must perform a series of substeps within a step. At step 2, you must do what the step indicates.

- 1 This step has a series of substeps that you must perform to complete the step. You must perform the following substeps:
 - i This is the first substep.
 - ii This is the second substep.
 - iii This is the third substep.
 - 2 You must perform this step.
-

Multiple PDF document search

You can use Adobe Reader Release 6.0 and later to search multiple PDF files for a common term. Adobe Reader displays the results in a single display panel. The results are grouped by PDF file, and you can expand the entry for each file.



Note – The PDF files in which you search must be in the same folder.

Les fichiers PDF dans lequel vous recherchez doivent être dans le même dossier

Procedure 5 To search multiple PDF files for a common term

- 1 Open Adobe Acrobat Reader.
- 2 Choose Edit→Search from the Acrobat Reader main menu. The Search PDF panel appears.
- 3 Enter the search criteria.

- 4 Click on the All PDF Documents In radio button.
- 5 Select the folder in which to search using the drop-down menu.
- 6 Click on the Search button.

Acrobat Reader displays the search results. You can expand the entries for each document by clicking on the + symbol.

ETSI ONT safety guidelines

This chapter provides information about the mandatory regulations that govern the installation and operation of the optical network terminals (ONTs).

Safety instructions

This section describes the safety instructions that are provided in the ONT customer documentation and on the equipment.

Safety instruction boxes

The safety instruction boxes are provided in the ONT customer documentation. Observe the instructions to meet safety requirements.

The following is an example of the Danger box.



Danger – Possibility of personal injury.
Possibilit  de blessures.

The Danger box indicates that the described activity or situation may pose a threat to personal safety. It calls attention to a situation or procedure which, if not correctly performed or adhered to, may result in death or serious physical harm.

Do not proceed beyond a Danger box until the indicated conditions are fully understood and met.

The following is an example of the Warning box.



Warning 1 – Possibility of equipment damage.
Possibilit  de dommages mat riels.

Warning 2 – Possibility of data loss.
Possibilit  de perte de donn es.

The Warning box indicates that the described activity or situation may, or will, cause equipment damage, loss of data, or serious performance problems. It identifies a possible equipment-damaging situation or provides essential information to avoid the degradation of system operations or data.

Do not proceed beyond a warning until the indicated conditions are fully understood and met.

The following is an example of the Caution box.



Caution 1 – Possibility of service interruption.
Possibilit é d'interruption de service.

Caution 2 – Service interruption.
Interruption de service

The Caution box indicates that the described activity or situation may, or will, cause service interruption.

Do not proceed beyond a caution until the indicated conditions are fully understood and met.

The following is an example of the Note box.



Note – Information of special interest.
L'information d'int é r ê t sp é cial.

The Note box provides information that assists the personnel working with ONTs. It does not provide safety-related instructions.

Safety-related labels

The ONT equipment is labeled with the specific safety instructions and compliance information that is related to a variant of the ONT. Observe the instructions on the safety labels.



Table 1 provides sample safety labels on the ONT equipment.

Table 1 Safety labels

Description	Label text
ESD warning	Caution: This assembly contains an electrostatic sensitive device.
Laser classification	Class 1 laser product
PSE marking	These power supplies are Japan PSE certified and compliant with Japan VCCI emissions standards.

Figure 1 shows the PSE certification.

Figure 1 PSE certification

 Warning	<p>This is a Class B product based on the standard of the Voluntary Control Council for Interference from Information Technology Equipment (VCCI). If this is used near a radio or television receiver in a domestic environment, it may cause radio interference. Install and use the equipment according to the instruction manual.</p>
	<p>VCCI準拠クラスB機器（日本） この機器は、Information Technology EquipmentのVoluntary Control Council for Interference (VCCI)の規格に準拠したクラスB製品です。この機器をラジオやテレビ受信機の近くで使用した場合、混信が発生する恐れがあります。本機器の設置および使用に際しては、取扱説明書に従ってください。</p>

19841

Safety standards compliance

This section describes the ONT compliance with the European safety standards.

EMC, EMI, and ESD compliance

The ONT equipment complies with the following EMC, EMI, and ESD requirements:

- EN 300-386 V1.3.2 (2003-05): Electromagnetic Compatibility and Radio Spectrum Matters (ERM): Telecommunications Network Equipment; Electromagnetic Compatibility (EMC) requirements; Electrostatic Discharge (ESD) requirements
- EN 55022 (1998): Class B, Information Technology Equipment, Radio Disturbance Characteristics, limits and methods of measurement
- EN 55024 (1998): Information Technology Equipment, Immunity Characteristics, limits and methods of measurement
- European Council Directive 2004/108/EC
- EN 300-386 V1.4.1: 2008
- EN 55022:2006 Class B (ONTs)
- EN EN 61000-3-2:2006
- EN EN 61000-3-3:2008
- IEC 61000-4-2:2001
- IEC 61000-4-3:2006
- IEC 61000-4-4:2004
- IEC 61000-4-5:2005
- IEC 61000-4-6:2003/A1:2004/A2:2006
- IEC 61000-4-11:2004

Equipment safety standard compliance

The ONT equipment complies with the requirements of EN 60950-1, Safety of Information Technology Equipment for use in a restricted location (per R-269).

Environmental standard compliance

The ONT equipment complies with the EN 300 019 European environmental standards.

Laser product standard compliance

For most ONTs, the ONT equipment complies with EN 60825-1 and IEC 60825-2 for laser products. If there is an exception to this compliance regulation, you can find this information in the standards compliance section of the unit data sheet in this Product Guide.

Resistibility requirements compliance

The ONT equipment complies with the requirements of ITU Recommendation K.21 for resistibility of telecommunication equipment installed in customer premises to over voltage and overcurrents.

Acoustic noise emission standard compliance

The ONT equipment complies with EN 300 753 acoustic noise emission limit and test methods.

Electrical safety guidelines

This section provides the electrical safety guidelines for the ONT equipment.



Note 1 – The ONTs comply with the U.S. National Electrical Code. However, local electrical authorities have jurisdiction when there are differences between the local and U.S. standards.

Les ONT sont conformes à la US National Electrical Code. Cependant, les autorités locales électriques ont compétence quand il ya des différences entre les normes locales et américaines.

Note 2 – The ONTs comply with BS EN 61140.

Les ONT sont conformes à la norme BS EN 61140

Power supplies

The use of any non-Alcatel-Lucent approved power supplies or power adapters is not supported or endorsed by Alcatel-Lucent. Such use will void any warranty or support contract with Alcatel-Lucent. Such use greatly increases the danger of damage to equipment or property.

Cabling

The following are the guidelines regarding cables used for the ONT equipment:

- All cables must be approved by the relevant national electrical code.
- The cables for outdoor installation of ONTs must be suitable for outdoor use.
- POTS wiring run outside the subscriber premises must comply with the requirements of local electrical codes. In some markets, the maximum allowed length of the outside run is 140 feet (43 m). If the outside run is longer, NEC requires primary protection at both the exit and entry points for the wire.

Protective earth

Earthing and bonding of the ONTs must comply with the requirements of local electrical codes.

ESD safety guidelines

The ONT equipment is sensitive to ESD. Operations personnel must observe the following ESD instructions when they handle the ONT equipment.



Caution — This equipment is ESD sensitive. Proper ESD protections should be used when you enter the TELCO Access portion of the ONT.

Cet équipement est sensible ESD. Protections relatives aux décharges électrostatiques doivent être utilisées lorsque vous entrez dans la partie d'accès TELCO de l'ONT

During installation and maintenance, service personnel must wear wrist straps to prevent damage caused by ESD.

Laser safety guidelines

Observe the following instructions when you perform installation, operations, and maintenance tasks on the ONT equipment.

Only qualified service personnel who are extremely familiar with laser radiation hazards should install or remove the fiber optic cables and units in this system.



Danger — There may be invisible laser radiation at the fiber optic cable when the cable is removed from the connector. Avoid direct exposure to the laser beam.

Il peut y avoir un rayonnement laser invisible sur le câble à fibre optique lorsque le câble est retiré du connecteur. Éviter l'exposition directe au rayon laser.

Observe the following danger for laser hazard. Eyes can be damaged when they are exposed to a laser beam. Take necessary precautions before you plug in the optical modules.



Danger — Possibility of equipment damage. Risk of eye damage by laser radiation.

Possibilité de dommages matériels. Risque de lésions oculaires par un rayonnement laser.

Laser classification

The ONT is classified as a Class 1 laser product based on its transmit optical output.

Laser warning labels

The following figures show the labels related to laser product, classification and warning.

Figure 2 shows a laser product label.

Figure 2 Laser product label

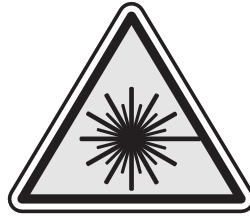

18455

Figure 3 shows a laser classification label. Laser classification labels may be provided in other languages.

Figure 3 Laser classification label

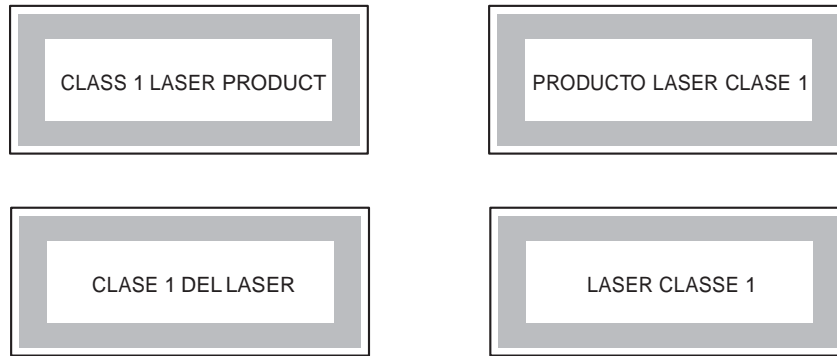

18992

Figure 4 shows a laser warning label and an explanatory label for laser products. Labels and warning may be provided in other languages. The explanatory label provides the following information:

- a warning that calls attention to the invisible laser radiation
- an instruction against staring into the beam or viewing directly with optical instruments
- wavelength
- normal output power
- maximum output power

Figure 4 Laser warning labels

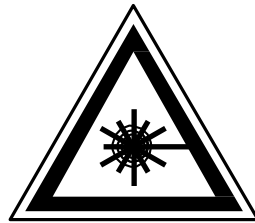

Laser Warning Label

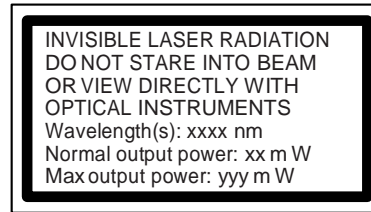

Laser Warning Label

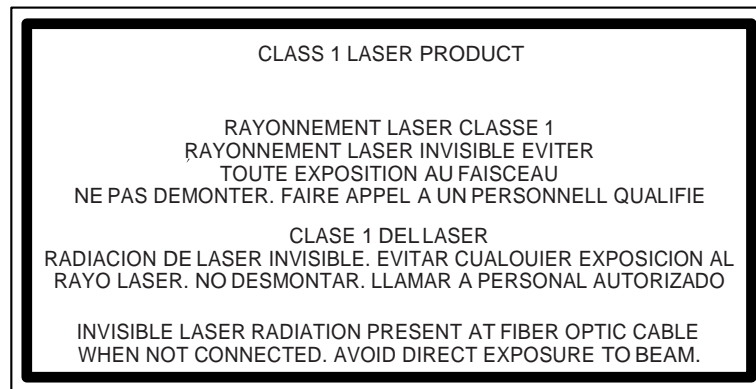

Laser Warning Label

18993

Transmit optical output

The maximum transmit optical output of an ONT is +5 dBm.

Normal laser operation

In normal operation, fiber cable laser radiation is always off until it receives signal from the line terminal card.

Eyes can be damaged when they exposed to a laser beam. Operating personnel must observe the instructions on the laser explanatory label before plugging in the optical module.



Danger — Risk of eye damage by laser radiation.

Risque de lésions oculaires par un rayonnement laser.

Location class

Use cable supports and guides to protect the receptacles from strain.

Environmental requirements

See the ONT technical specification documentation for more information about temperature ranges.

During operation in the supported temperature range, condensation inside the ONT caused by humidity is not an issue. To avoid condensation caused by rapid changes in temperature and humidity, Alcatel-Lucent recommends:

- The door of the ONT not be opened until temperature inside and outside the enclosure has stabilized.
- If the door of the ONT must be opened after a rapid change in temperature or humidity, use a dry cloth to wipe down the metal interior to prevent the risk of condensation.
- When high humidity is present, installation of a cover or tent over the ONT helps prevent condensation when the door is opened.

ETSI environmental and CRoHS guidelines

This chapter provides information about the ETSI environmental China Restriction of Hazardous Substances (CRoHS) regulations that govern the installation and operation of the optical line termination (OLT) and optical network termination (ONT) systems. This chapter also includes environmental operation parameters of general interest.

Environmental labels

This section describes the environmental instructions that are provided with the customer documentation, equipment, and location where the equipment resides.

Overview

CRoHS is applicable to Electronic Information Products (EIP) manufactured or sold and imported in the territory of the mainland of the People's Republic of China. EIP refers to products and their accessories manufactured by using electronic information technology, including electronic communications products and such subcomponents as batteries and cables.

Environmental related labels

Environmental labels are located on appropriate equipment. The following are sample labels.

Products below Maximum Concentration Value (MCV) label

Figure 1 shows the label that indicates a product is below the maximum concentration value, as defined by standard SJ/T11363-2006 (Requirements for Concentration Limits for Certain Hazardous Substances in Electronic Information Products). Products with this label are recyclable. The label may be found in this documentation or on the product.

Figure 1 Products below MCV value label

18986

Products containing hazardous substances above Maximum Concentration Value (MCV) label

Figure 2 shows the label that indicates a product is above the maximum concentration value, as defined by standard SJ/T11363-2006 (Requirements for Concentration Limits for Certain Hazardous Substances in Electronic Information Products). The number contained inside the label indicates the Environment-Friendly User Period (EFUP) value. The label may be found in this documentation or on the product.

Figure 2 Products above MCV value label



18985

Together with major international telecommunications equipment companies, Alcatel-Lucent has determined it is appropriate to use an EFUP of 50 years for network infrastructure equipment and an EFUP of 20 years for handsets and accessories. These values are based on manufacturers' extensive practical experience of the design, manufacturing, maintenance, usage conditions, operating environments, and physical condition of infrastructure and handsets after years of service. The values reflect minimum values and refer to products operated according to the intended use conditions. See “[Hazardous Substances Table \(HST\)](#)” for more information.

Hazardous Substances Table (HST)

This section describes the compliance of the OLT and ONT equipment to the CRoHS standard when the product and subassemblies contain hazardous substances beyond the MCV value. This information is found in this user documentation where part numbers for the product and subassemblies are listed. It may be referenced in other OLT and ONT documentation.

In accordance with the People’s Republic of China Electronic Industry Standard Marking for the Control of Pollution Caused by Electronic Information Products (SJ/T11364-2006), customers may access the Alcatel-Lucent Hazardous Substance Table, in Chinese, from the following location:

- <http://www.alcatel-sbell.com.cn/wwwroot/images/upload/private/1/media/ChinaRoHS.pdf>

Other environmental requirements

Observe the following environmental requirements when handling the P-OLT or ONT equipment.

ONT environmental requirements

See the ONT technical specification documentation for more information about temperature ranges.

Storage

According to ETS 300-019-1-1 - Class 1.1, storage of OLT equipment must be in Class 1.1, weather-protected, temperature-controlled locations.

Transportation

According to EN 300-019-1-2 - Class 2.3, transportation of the OLT equipment must be in packed, public transportation with no rain on packing allowed.

Stationary use

According to EN 300-019-1-3 - Class 3.1/3.2/3.E, stationary use of OLT equipment must be in a temperature-controlled location, with no rain allowed, and with no condensation allowed.

Thermal limitations

When the OLT is installed in the CO or CEV, install air filters on the P-OLT. The thermal limitations for OLT operation in a CO or CEV are:

- operating temperature: 5°C to 40°C (41°F to 104°F)
- short-term temperature: -5°C to 50°C (23°F to 122°F)
- operating relative humidity: 5% to 85%
- short-term relative humidity: 5% to 95%, but not to exceed 0.024 kg of water/kg

Material content compliance

European Union (EU) Directive 2002/95/EC, “Restriction of the use of certain Hazardous Substances” (RoHS), restricts the use of lead, mercury, cadmium, hexavalent chromium, and certain flame retardants in electrical and electronic equipment. This Directive applies to electrical and electronic products placed on the EU market after 1 July 2006, with various exemptions, including an exemption for lead solder in network infrastructure equipment. Alcatel-Lucent products shipped to the EU after 1 July 2006 comply with the EU RoHS Directive.

Alcatel-Lucent has implemented a material/substance content management process. The process is described in: Alcatel-Lucent process for ensuring RoHS Compliance (1AA002660031ASZZA). This ensures compliance with the European Union Directive 2011/65/EU on the Restriction of the Use of Certain Hazardous Substances in Electrical and Electronic Equipment (RoHS2). With the process equipment is assessed in accordance with the Harmonised Standard EN50581:2012 (CENELEC) on Technical documentation for the assessment of electrical and electronic products with respect to the restriction of hazardous substances.

End-of-life collection and treatment

Electronic products bearing or referencing the symbol shown in Figure 3, when put on the market within the European Union (EU), shall be collected and treated at the end of their useful life, in compliance with applicable EU and local legislation. They shall not be disposed of as part of unsorted municipal waste. Due to materials that may be contained in the product, such as heavy metals or batteries, the environment and human health may be negatively impacted as a result of inappropriate disposal.



Note – In the European Union, a solid bar under the symbol for a crossed-out wheeled bin indicates that the product was put on the market after 13 August 2005.

Dans l'Union européenne, un bar solide sous le symbole d'une poubelle sur roues barrée d'une croix indique que le produit a été mis sur le marché après le 13 Août 2005.

Figure 3 Recycling/take back/disposal of product symbol



At the end of their life, the OLT products are subject to the applicable local legislations that implement the European Directive 2002/96EC on waste electrical and electronic equipment (WEEE).

There can be different requirements for collection and treatment in different member states of the European Union.

In compliance with legal requirements and contractual agreements, where applicable, Alcatel-Lucent will offer to provide for the collection and treatment of Alcatel-Lucent products bearing the logo shown in Figure 3 at the end of their useful life, or products displaced by Alcatel-Lucent equipment offers. For information regarding take-back of equipment by Alcatel-Lucent, or for more information regarding the requirements for recycling/disposal of product, contact your Alcatel-Lucent account manager or Alcatel-Lucent take back support at takeback@alcatel-lucent.com.

ANSI ONT safety guidelines

This chapter provides information about the mandatory regulations that govern the installation and operation of the optical network terminals or units (ONTs or ONUs) in the North American or ANSI market.

Safety instructions

This section describes the safety instructions that are provided in the ONT customer documentation and on the equipment.

Safety instruction boxes in customer documentation

The safety instruction boxes are provided in the ONT customer documentation. Observe the instructions to meet safety requirements.

The following is an example of the Danger box.



Danger – Possibility of personal injury.
Possibilit é de blessures

The Danger box indicates that the described activity or situation may pose a threat to personal safety. It calls attention to a situation or procedure which, if not correctly performed or adhered to, may result in death or serious physical harm.

Do not proceed beyond a Danger box until the indicated conditions are fully understood and met.

The following is an example of the Warning box.



Warning 1 – Possibility of equipment damage.
Possibilit e de dommages mat riels

Warning 2 – Possibility of data loss.
Possibilit e de perte de donn es.

The Warning box indicates that the described activity or situation may, or will, cause equipment damage, loss of data, or serious performance problems. It identifies a possible equipment-damaging situation or provides essential information to avoid the degradation of system operations or data.

Do not proceed beyond a warning until the indicated conditions are fully understood and met.

The following is an example of the Caution box.



Caution 1 – Possibility of service interruption.
Possibilit  d'interruption de service

Caution 2 – Service interruption.
Interruption de service.

The Caution box indicates that the described activity or situation may, or will, cause service interruption.

Do not proceed beyond a caution until the indicated conditions are fully understood and met.

The following is an example of the Note box.



Note – Information of special interest.
L'information d'int r t sp cial.

The Note box provides information that assists the personnel working with ONTs. It does not provide safety-related instructions.

Safety-related labels

The ONT equipment is labeled with specific safety compliance information and instructions that are related to a variant of the ONT. Observe the instructions on the safety labels.

Table 1 provides examples of the text in the various ONT safety labels.

Table 1 Safety labels

Description	Label text
UL compliance	Communication service equipment US listed. Type 3R enclosure - Rainproof.
TUV compliance	Type 3R enclosure - Rainproof.
ESD warning	Caution: This assembly contains electrostatic sensitive device.

Description	Label text
Laser classification	Class 1 laser product
Laser product compliance	This laser product conforms to all applicable standards of 21 CFR 1040.10 at date of manufacture.
FCC standards compliance	Tested to comply with FCC standards for home or office use.
CDRH compliance	Complies with 21 CFR 1040.10 and 1040.11 except for deviations pursuant to Laser Notice No. 50, dated June 24, 2007
Operation conditions	This device complies with Part 15 of the FCC Rules. Operation is subject to the following two conditions: (1) this device may not cause harmful interference, and (2) this device must accept any interference received, including interference that may cause undesired operation.
Canadian standard compliance (modular ONT)	This Class A digital apparatus complies with Canadian ICES-003.
Canadian standard compliance (outdoor ONT)	This Class B digital apparatus complies with Canadian ICES-003.
CE marking	There are various CE symbols for CE compliance.

(2 of 2)

Figure 1 shows a sample safety label on the ONT equipment.

Figure 1 Sample safety label on the ONT equipment

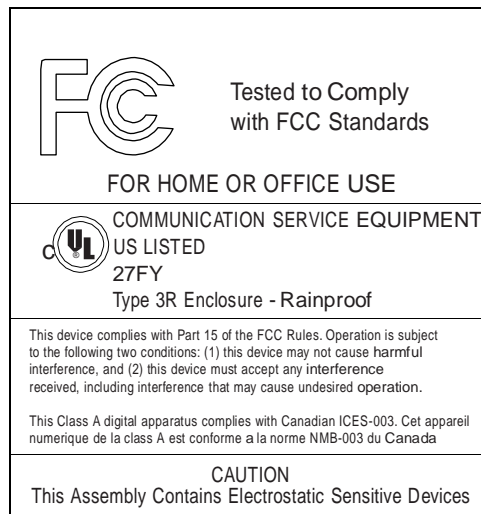

18533

Safety standards compliance

This section describes the ONT compliance with North American safety standards.



Warning — Changes or modifications to this unit not expressly approved by the party responsible for compliance could void the user's authority to operate the equipment.

Les changements ou modifications de cette unité non expressément approuvés par la partie responsable de la conformité pourraient annuler l'autorité de l'utilisateur à utiliser l'équipement.

EMC, EMI, and ESD standards compliance

The ONT equipment complies with the following requirements:

- Federal Communications Commission (FCC) CFR 47, Part 15, Subpart B, Class A requirements for OLT equipment
- GR-1089-CORE requirements, including:
 - Section 3 Electromagnetic Interference, Emissions Radiated and Conducted
 - Section 3 Immunity, Radiated and Conducted
 - Section 2 ESD Discharge Immunity: System Level Electrostatic Discharge and EFT Immunity: Electrically Fast Transients

This equipment has been tested and found to comply with the limits for a Class B digital device, pursuant to Part 15 of the FCC Rules. These limits are designed to provide reasonable protection against harmful interference in a residential installation. This equipment generates, uses and can radiate radio frequency energy and, if not installed and used in accordance with the instructions, may cause harmful interference to radio communications.

However, there is no guarantee that interference will not occur in a particular installation. If this equipment does cause harmful interference to radio or television reception, which can be determined by turning the equipment off and on, the user is encouraged to try to correct the interference by one or more of the following measures:

- Reorient or relocate the receiving antenna.
- Increase the separation between the equipment and receiver.
- Connect the equipment into an outlet on a circuit different from that to which the receiver is needed.
- Consult the dealer or an experienced radio/TV technician for help.

Equipment safety standard compliance

The ONT equipment complies with the requirements of UL60950-1, Outdoor ONTs to “Communication Service Equipment” (CSE) and Indoor ONTs to Information Technology Equipment (ITE).

Environmental standards compliance

The ONT equipment complies with the following standards:

- GR-63-CORE (NEBS): requirements related to operating, storage, humidity, altitude, earthquake, office vibration, transportation and handling, fire resistance and spread, airborne contaminants, illumination, and acoustic noise
- GR-487-CORE: requirements related to rain, chemical, sand, and dust
- GR-487 R3-82: requirements related to condensation
- GR-3108: Requirements for Network Equipment in the Outside Plant (OSP)
- TP76200: Common Systems Equipment Interconnections Standards

Laser product standards compliance

The ONT equipment complies with 21 CFR 1040.10 and CFR 1040.11, except for deviations pursuant to Laser Notice No. 50, dated June 24, 2007” or to 21 CFR 1040.10 U.S. Center for Devices and Radiological Health (CDRH) of the Food and Drug Administration (FDA) Laser Notice 42 for ONTs containing Class 1 Laser modules certified by original manufactures.

Per CDRH 21 CFR 10.40.10 (h) (1) (iv) distributors of Class 1 laser products, such as ALU ONTs shall leave the following Laser Safety cautions with the end user.

- a) “Class 1 Laser Product”
- b) “Caution – Use of controls or adjustments or performance of procedures other than those specified herein may result in hazardous radiation exposure.”

Figure 2 shows a laser product label.

Figure 2 Sample laser product label showing CDRH 21 CFR compliance

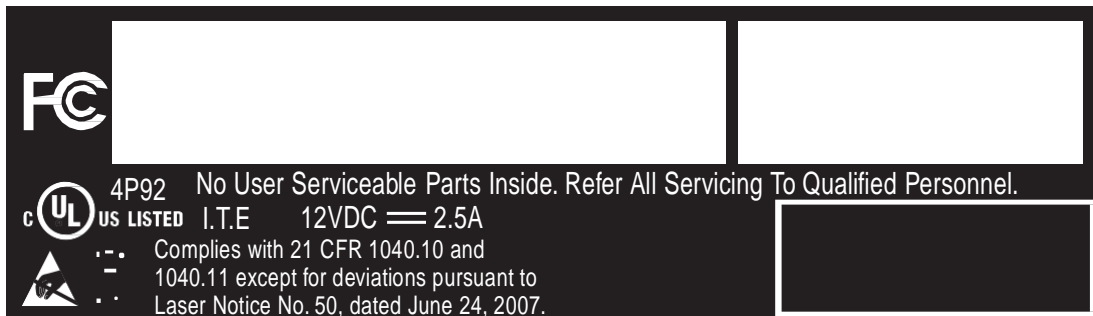

22813

Resistibility requirements compliance

The ONT equipment complies with the requirements of ITU Recommendation K.21 for resistibility of telecommunication equipment installed in customer premises to overvoltage and overcurrents.

Laser safety guidelines

Only qualified service personnel who are extremely familiar with laser radiation hazards should install or remove the fiber optic cables and units in this system.

Observe the following warnings when you perform installation, operations, and maintenance tasks on the ONT equipment.



Danger – There may be invisible laser radiation at the fiber optic cable when the cable is removed from the connector. Avoid direct exposure to beam.

Il peut y avoir un rayonnement laser invisible sur le câble à fibre optique lorsque le câble est retiré du connecteur. Éviter l'exposition directe au rayon

Observe the following danger for a laser hazard. Eyes can be damaged when they are exposed to a laser beam. Take necessary precautions before you plug in the optical modules.



Danger – Possibility of equipment damage. Risk of eye damage by laser radiation.

Possibilit e de dommages mat riels. Risque de l sions oculaires par un rayonnement laser.

Per CDRH 21 CFR 10.40.10 (h) (1) (iv) distributors of Class 1 laser products, such as ALU ONTs shall leave the following Laser Safety cautions with the end user.

a) “Class 1 Laser Product”

b) “Caution – Use of controls or adjustments or performance of procedures other than those specified herein may result in hazardous radiation exposure.”

Laser warning labels

The following figures show sample labels related to laser product, classification and warning.

Figure 3 shows a laser product label.

Figure 3 Laser product label

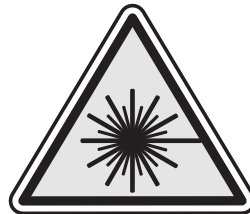

18455

Figure 4 shows a laser classification label. Laser classification labels may be provided in other languages.

Figure 4 Laser classification label

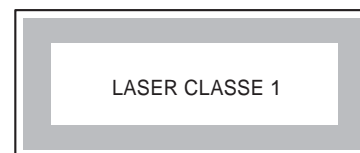
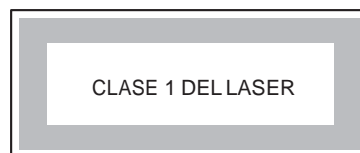
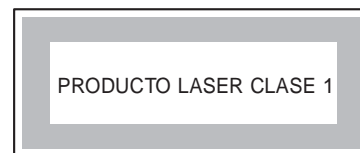
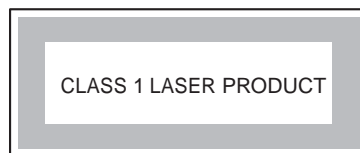

18992

Figure 5 shows a laser warning label and an explanatory label for laser products. Explanatory labels may be provided in other languages. The explanatory label provides the following information:

- a warning that calls attention to the invisible laser radiation
- an instruction against staring into the beam or viewing directly with optical instruments
- wavelength
- normal output power
- maximum output power

Figure 5 Laser warning labels



18993

Laser classification

The ONT is classified as a Class 1 laser product based on its transmit optical output.

For Class 1 laser products, lasers are safe under reasonably foreseeable conditions of operation, including the use of optical instruments for intrabeam viewing.

Figure 6 shows a sample laser product safety label on the ONT equipment.

Figure 6 Sample laser product safety label on the ONT equipment

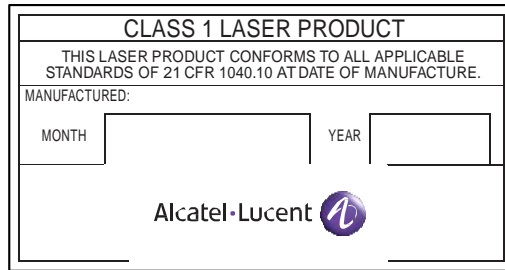

18532

Transmit optical output

The maximum transmit optical output of an ONT is +5 dBm.

Normal laser operation

In normal operation, fiber cable laser radiation is always off until it receives signal from the line terminal card.

Operating personnel must observe the instructions on the laser explanatory label before plugging in the optical module.



Danger — Risk of eye damage by laser radiation.
 Risque de lésions oculaires par un rayonnement laser.

Location class

Use cable supports and guides to protect the receptacles from strain.

Electrical safety guidelines

This section provides the electrical safety guidelines for the ONT equipment.



Note — The ONTs comply with the U.S. National Electrical Code. However, local electrical authorities have jurisdiction when there are differences between the local and U.S. standards.

Les ONT sont conformes à la US National Electrical Code. Cependant, les autorités locales électriques ont compétence quand il ya des différences entre les normes locales et américaines.

Power supplies

The use of any non-Alcatel-Lucent approved power supplies or power adapters is not supported or endorsed by Alcatel-Lucent. Such use will void any warranty or support contract with Alcatel-Lucent. Such use greatly increases the danger of damage to equipment or property.

Cabling

The following are the guidelines regarding cables used for the ONT equipment:

- Use only cables approved by the relevant national electrical code.
- Use cables suitable for outdoor use for outdoor installation of ONTs.
- The ONTs have been evaluated for use with external POTS wiring without primary protection that may not exceed 140 ft (43 m) in reach. However, the power cable must not exceed 100 ft (31 m).

Protective earth

Earthing and bonding of the ONTs must comply with the requirements of NEC article 250 or local electrical codes.

ESD safety guidelines

The ONT equipment is sensitive to ESD. Operations personnel must observe the following ESD instructions when they handle the ONT equipment.



Caution — This equipment is ESD sensitive. Proper ESD protections should be used when entering the TELCO Access portion of the ONT.

Cet équipement est sensible ESD. Protections ESD appropriées doivent être utilisées lors de l'entrée de la partie TELCO accè s de l'ONT

During installation and maintenance, service personnel must wear wrist straps to prevent damage caused by ESD.

Alcatel-Lucent recommends that you prepare the site before you install the ONT equipment. In addition, you must control relative humidity, use static dissipating material for furniture or flooring, and restrict the use of air conditioning.

Environmental requirements

See the ONT technical specification documentation for temperature ranges for ONTs.

During operation in the supported temperature range, condensation inside the ONT caused by humidity is not an issue. To avoid condensation caused by rapid changes in temperature and humidity, Alcatel-Lucent recommends:

- The door of the ONT not be opened until temperature inside and outside the enclosure has stabilized.
- If the door of the ONT must be opened after a rapid change in temperature or humidity, use a dry cloth to wipe down the metal interior to prevent the risk of condensation.
- When high humidity is present, installation of a cover or tent over the ONT helps prevent condensation when the door is opened.

Contents

Preface	iii
Scope	iii
Audience	iii
Required knowledge	iii
Acronyms and initialisms	iii
Assistance and ordering phone numbers	iv
Alcatel-Lucent quality processes	iv
Safety information	iv
Documents	iv
Procedure 1 To download a ZIP file package of the customer documentation.....	iv
Procedure 2 To access individual documents	v
Special information.....	v
Procedures with options or substeps	v
Procedure 3 Example of options in a procedure.....	vi
Procedure 4 Example of required substeps in a procedure	vi
Multiple PDF document search.....	vi
Procedure 5 To search multiple PDF files for a common term	vi
ETSI ONT safety guidelines	ix
Safety instructions.....	ix
Safety instruction boxes	ix
Safety-related labels	x
Safety standards compliance.....	xi
EMC, EMI, and ESD compliance.....	xi
Equipment safety standard compliance	xi
Environmental standard compliance	xii
Laser product standard compliance	xii

Contents

Resistibility requirements compliance	xii
Acoustic noise emission standard compliance	xii
Electrical safety guidelines.....	xii
Power supplies.....	xii
Cabling.....	xii
Protective earth	xiii
ESD safety guidelines.....	xiii
Laser safety guidelines.....	xiii
Laser classification.....	xiii
Transmit optical output	xv
Normal laser operation	xv
Location class	xv
Environmental requirements.....	xvi

ETSI environmental and CRoHS guidelines xvii

Environmental labels	xvii
Overview	xvii
Environmental related labels.....	xvii
Hazardous Substances Table (HST).....	xix
Other environmental requirements	xix
ONT environmental requirements	xx
Storage.....	xx
Transportation	xx
Stationary use	xx
Thermal limitations	xx
Material content compliance	xx
End-of-life collection and treatment	xxi

ANSI ONT safety guidelines xxiii

Safety instructions.....	xxiii
Safety instruction boxes in customer documentation	xxiii
Safety-related labels	xxiv
Safety standards compliance.....	xxv
EMC, EMI, and ESD standards compliance	xxvi
Equipment safety standard compliance	xxvi
Environmental standards compliance	xxvi
Laser product standards compliance	xxvii
Resistibility requirements compliance	xxvii
Laser safety guidelines	xxvii
Laser warning labels	xxviii
Laser classification.....	xxix
Transmit optical output	xxx
Normal laser operation	xxx
Location class	xxx

Electrical safety guidelines.....	xxx
Power supplies.....	xxx
Cabling	xxxix
Protective earth.....	xxxix
ESD safety guidelines.....	xxxix
Environmental requirements.....	xxxix
1 — G-240W-B unit data sheet	1-1
1.1 G-240W-B part numbers and identification	1-2
1.2 G-240W-B general description	1-3
1.3 G-240W-B software and installation feature support.....	1-4
1.4 G-240W-B interfaces and interface capacity	1-4
G-240W-B connections and components.....	1-5
1.5 G-240W-B LEDs	1-6
1.6 G-240W-B detailed specifications	1-7
1.7 G-240W-B GEM ports and T-CONTs	1-8
1.8 G-240W-B performance monitoring statistics.....	1-9
1.9 G-240W-B functional blocks	1-11
1.10 G-240W-B standards compliance	1-13
FCC statement.....	1-13
FCC Radiation Exposure Statement	1-13
1.11 G-240W-B special considerations	1-14
Wi-Fi service	1-14
G-240W-B ONT considerations and limitations	1-14
2 — Install a G-240W-B indoor ONT	2-1
2.1 Purpose	2-2
2.2 General	2-2
2.3 Prerequisites.....	2-2
2.4 Recommended tools	2-2
2.5 Safety information	2-3
2.6 Procedure	2-4
3 — Replace a G-240W-B indoor ONT	3-1
3.1 Purpose	3-2
3.2 General	3-2
3.3 Prerequisites.....	3-2
3.4 Recommended tools	3-2
3.5 Safety information	3-3
3.6 Procedure	3-4
4 — Configure a G-240W-B indoor ONT	4-1
4.1 General	4-2
4.2 HGU mode GUI configuration.....	4-2
Login	4-2
Procedure 4-1 Login to web-based GUI	4-2
Device and connection status	4-3
Procedure 4-2 Device information retrieval.....	4-4

Contents

	Procedure 4-3 LAN status retrieval	4-5
	Procedure 4-4 WAN status retrieval	4-6
	Procedure 4-5 WAN status IPv6 retrieval	4-8
	Procedure 4-6 Home networking information retrieval	4-9
	Procedure 4-7 Optics module status retrieval	4-10
	Network configuration.....	4-11
	Procedure 4-8 LAN networking configuration	4-12
	Procedure 4-9 LAN IPv6 networking configuration	4-13
	Procedure 4-10 WAN networking configuration.....	4-15
	Procedure 4-11 WiFi 2.4G networking configuration	4-16
	Procedure 4-12 WiFi 5G networking configuration	4-18
	Procedure 4-13 Routing configuration	4-19
	Procedure 4-14 DNS configuration	4-20
	Procedure 4-15 TR-069 configuration	4-21
	Security configuration	4-22
	Procedure 4-16 Firewall configuration.....	4-23
	Procedure 4-17 MAC filter configuration	4-24
	Procedure 4-18 IP filter configuration	4-25
	Procedure 4-19 DMZ and ALG configuration.....	4-26
	Application configuration	4-27
	Procedure 4-20 Port forwarding configuration	4-27
	Procedure 4-21 DDNS configuration	4-28
	Procedure 4-22 NTP configuration.....	4-29
	Procedure 4-23 USB storage configuration	4-30
	Maintenance	4-31
	Procedure 4-24 Password configuration	4-31
	Procedure 4-25 SLID configuration	4-32
	Procedure 4-26 Device management	4-33
	Procedure 4-27 Backup and restore	4-34
	Procedure 4-28 Upgrade firmware.....	4-34
	Procedure 4-29 Reboot ONT	4-35
	Procedure 4-30 Restore factory defaults	4-36
	Procedure 4-31 Diagnose connections.....	4-37
	Procedure 4-32 View log files	4-38
4.3	SFU mode GUI configuration	4-39
	Login	4-39
	Procedure 4-33 Login to web-based GUI.....	4-39
	Device and connection status	4-40
	Procedure 4-34 Device information retrieval	4-41
	Maintenance	4-42
	Procedure 4-35 Password configuration	4-42
	Procedure 4-36 LOID configuration	4-43
	Procedure 4-37 SLID configuration	4-44
4.4	Operator ID.....	4-44
	Procedure 4-38 Modify the operator ID using OLT	4-45

List of figures

Figure 1 PSE certification	xi
Figure 2 Laser product label	xiv
Figure 3 Laser classification label	xiv
Figure 4 Laser warning labels	xv
Figure 1 Products below MCV value label	xviii
Figure 2 Products above MCV value label	xix
Figure 3 Recycling/take back/disposal of product symbol	xxi
Figure 1 Sample safety label on the ONT equipment.....	xxv
Figure 2 Sample laser product label showing CDRH 21 CFR compliance	xxvii
Figure 3 Laser product label	xxviii
Figure 4 Laser classification label	xxviii
Figure 5 Laser warning labels	xxix
Figure 6 Sample laser product safety label on the ONT equipment.....	xxx
Figure 1-1 G-240W-B indoor ONT physical connections	1-5
Figure 1-2 G-240W-B indoor ONT LEDs.....	1-6
Figure 1-3 Single-residence Wi-Fi ONT with Gigabit Ethernet and POTS and without RF video	1-11
Figure 1-4 G-240W-B ONT hardware block	1-12
Figure 2-1 Wall mounting keyholes on G-240W-B indoor ONTs	2-4
Figure 2-2 G-240W-B indoor ONT connections (back view)	2-5
Figure 3-1 G-240W-B indoor ONT connections.....	3-4
Figure 4-1 Web login window	4-3
Figure 4-2 Device Information window	4-4
Figure 4-3 LAN status window.....	4-5
Figure 4-4 WAN status window	4-6
Figure 4-5 WAN status IPv6 window	4-8
Figure 4-6 Home networking information window	4-9
Figure 4-7 Optics module status window	4-10
Figure 4-8 LAN network window	4-12
Figure 4-9 LAN IPv6 network window	4-13
Figure 4-10 WAN network window.....	4-15
Figure 4-11 WiFi 2.4G network window	4-16
Figure 4-12 WiFi 5G network window	4-18
Figure 4-13 Routing network window	4-19
Figure 4-14 DNS network window.....	4-20
Figure 4-15 TR-069 network window.....	4-21
Figure 4-16 Firewall window	4-23
Figure 4-17 MAC filter window	4-24
Figure 4-18 IP filter window	4-25
Figure 4-19 DMZ and ALG window	4-26
Figure 4-20 Port forwarding window	4-27
Figure 4-21 DDNS window.....	4-28
Figure 4-22 NTP window	4-29
Figure 4-23 USB storage window.....	4-30
Figure 4-24 Password window	4-31
Figure 4-25 SLID configuration window	4-32
Figure 4-26 Device management window	4-33
Figure 4-27 Backup and Restore window	4-34
Figure 4-28 Firmware upgrade window	4-34

Contents

Figure 4-29 Reboot window	4-35
Figure 4-30 Factory default window	4-36
Figure 4-31 Diagnose window	4-37
Figure 4-32 Log window	4-38
Figure 4-33 Web login window	4-40
Figure 4-34 Device Information window	4-41
Figure 4-35 Password window	4-42
Figure 4-36 LOID configuration window	4-43
Figure 4-37 SLID configuration window	4-44

List of tables

Table 1 Safety labels	x
Table 1 Safety labels	xxiv
Table 1-1 Identification of G-240W-B indoor ONTs	1-2
Table 1-2 G-240W-B power supply	1-3
Table 1-3 G-240W-B indoor ONT interface connection capacity	1-5
Table 1-4 G-240W-B indoor ONT physical connections.....	1-5
Table 1-5 G-240W-B indoor ONT LEDs	1-7
Table 1-6 G-240W-B indoor ONT physical specifications.....	1-8
Table 1-7 G-240W-B indoor ONT power consumption specifications	1-8
Table 1-8 G-240W-B indoor ONT environmental specifications.....	1-8
Table 1-9 G-240W-B indoor ONT capacity for GEM ports and T-CONTs.....	1-8
Table 1-10 Package P ONTs ONTENET performance monitoring statistics	1-9
Table 1-11 Package P ONTs ONTL2UNI performance monitoring statistics	1-10
Table 1-12 Package P ONTs PONONTTC, PONONTMCTC, PONONTTCHSI, PONONTTCCES, PONONTTCFLOW, PONONTTCVOIP performance monitoring statistics	1-10
Table 1-13 Package P ONTs PONONTTC aggregate performance monitoring statistics	1-10
Table 1-14 G-240W-B ONT considerations and limitations	1-15
Table 4-1 Device Information parameters	4-4
Table 4-2 LAN status parameters.....	4-5
Table 4-3 WAN status parameters.....	4-7
Table 4-4 WAN status IPv6 parameters	4-8
Table 4-5 Home networking parameters	4-9
Table 4-6 Optics module status parameters	4-10
Table 4-7 LAN network parameters	4-12
Table 4-8 LAN IPv6 network parameters	4-13
Table 4-9 WAN network parameters	4-15
Table 4-10 WiFi 2.4G network parameters	4-17
Table 4-11 WiFi 5G network parameters	4-18
Table 4-12 Routing network parameters	4-20
Table 4-13 DNS network parameters.....	4-21
Table 4-14 TR-069 network parameters	4-21
Table 4-15 Firewall parameters	4-23
Table 4-16 MAC filter parameters	4-24
Table 4-17 IP filter parameters	4-25
Table 4-18 DMZ and ALG parameters	4-26

Table 4-19 Port forwarding parameters	4-27
Table 4-20 DDNS parameters.....	4-28
Table 4-21 NTP parameters	4-29
Table 4-22 USB storage parameters.....	4-30
Table 4-23 Password parameters.....	4-32
Table 4-24 SLID configuration parameters.....	4-32
Table 4-25 Device management parameters	4-33
Table 4-26 Device Information parameters.....	4-41
Table 4-27 Password parameters.....	4-42
Table 4-28 SLID configuration parameters.....	4-44

1 – G-240W-B unit data sheet

- 1.1 G-240W-B part numbers and identification 1-2**
- 1.2 G-240W-B general description 1-3**
- 1.3 G-240W-B software and installation feature support 1-4**
- 1.4 G-240W-B interfaces and interface capacity 1-4**
- 1.5 G-240W-B LEDs 1-6**
- 1.6 G-240W-B detailed specifications 1-7**
- 1.7 G-240W-B GEM ports and T-CONTs 1-8**
- 1.8 G-240W-B performance monitoring statistics 1-9**
- 1.9 G-240W-B functional blocks 1-11**
- 1.10 G-240W-B standards compliance 1-13**
- 1.11 G-240W-B special considerations 1-14**

1.1 G-240W-B part numbers and identification

Table 1-1 provides part numbers and identification information for the G-240W-B indoor ONT.

Table 1-1 Identification of G-240W-B indoor ONTs

Mnemonic	Ordering kit part number	Provisioning number	Description	CLEI	CPR	ECI/Bar code
G-240W-B	3FE 56636 AA	3FE 56756 BAAA	Package P 2 POTS ports, 4 10/100/1000 Base-T Ethernet interfaces, and 802.11b/g/n/ac Wi-Fi radio with on/off switch. This ONT also has 2 USB ports, 1 USB 3.0 and 1 USB 2.0. Includes 3-pin wall-mounted US AC/DC adapter.	—	—	—
	3FE 56636 BA	3FE 56756 AABA	Package P 2 POTS ports, 4 10/100/1000 Base-T Ethernet interfaces, and 802.11b/g/n/ac Wi-Fi radio with on/off switch. This ONT also has 2 USB ports, 1 USB 3.0 and 1 USB 2.0. Includes 2-pin wall-mounted European (EU) AC/DC adapter.	—	—	—
	3FE 56636 CA	3FE 56756 AABA	Package P 2 POTS ports, 4 10/100/1000 Base-T Ethernet interfaces, and 802.11b/g/n/ac Wi-Fi radio with on/off switch. This ONT also has 2 USB ports, 1 USB 3.0 and 1 USB 2.0. Includes 3-pin wall-mounted British (UK) AC/DC adapter.	—	—	—
	3FE 56636 CB Customer-specific	3FE 56756 ABBA	Package P 2 POTS ports, 4 10/100/1000 Base-T Ethernet interfaces, and 802.11b/g/n/ac Wi-Fi radio with on/off switch. This ONT also has 2 USB ports, 1 USB 3.0 and 1 USB 2.0. Includes 3-pin wall-mounted British (UK) AC/DC adapter.	—	—	—

Table 1-2 provides power supply ordering information about the G-240W-B ONT. For more information on power supplies, see the *7368 ISAM ONT Power Supply and UPS Guide*.

Table 1-2 G-240W-B power supply

Power model	Power information	Customer category or country compliance tested for	Notes
Mass Power	36 Watt AC/DC power adapter	ANSI municipality United States, Canada	

1.2 G-240W-B general description

G-240W-B indoor ONTs provide the subscriber interface for the network by terminating the PON interface and converting it to user interfaces that directly connect to subscriber devices. The ONT is compatible with all existing subscriber equipment, including analog phones with both tone and rotary dial capabilities, cordless phones, modems, fax machines, and caller ID boxes (Type I, Type II, and Type III).

G-240W-B indoor ONTs provide the following functions:

- Single fiber GPON interface with 1.244Gbit/s upstream and 2.488Gbit/s downstream data rates
- Advanced data features such as VLAN tag manipulation, classification, and filtering.
- Traffic classification and QoS capability
- Analog Telephone Adapter (ATA) function integrated based on SIP (RFC3261) and H.248, with various CLASS services supported, including Caller ID, Call Waiting, Call Forwarding, and Call Transfer
- 5 REN per line
- Multiple voice Codec
- MDI/MDIX auto-negotiation
- Line Rate L2 traffic
- Internal Switch
- UPnP IGD1.0 support
- Bridged mode or routed mode per LAN port
- Optics that support received signal strength indication (RSSI)
- Internal DHCP server, with configurable DHCP pool and gateway
- WPS on wireless authorization support
- Configurable Wi-Fi tx power from 100mw to 500mw, in 100mw increments.
- Enhanced ONT; SSH-Telnet-FTP and http server are disabled from the WAN side
- Concurrent 802.11n 3x3 MIMO in 2.4GHz and 802.11ac 4x4 MIMO in 5GHz
- 64/128 WEP encryption
- WPA, WPA-PSK/TKIP
- WPA2, WPA2-PSK/AES

- support for multiple SSIDs (private and public instances); contact your ALU representative for further details.
- WLAN on/off push button
- WPS/PBC buttons (for 2.4G and 5G)
- Ethernet-based Point-to-Point (PPPoE)
- Network Address Translation (NAT)
- Network Address Port Translation (NAPT)
- ALG and UpnP port forwarding
- DMZ
- IP/MAC filter
- Multi-level firewall
- DNS server
- DHCP client/server
- support for HT40 mode for increased channel bandwidth
- support for up to 20 simultaneous wireless connections
- External USB HD (Hard Drive) support, accessible to all LAN devices

1.3 G-240W-B software and installation feature support

For information on installing or replacing the G-240W-B see:

- [Install a G-240W-B indoor ONT](#)
- [Replace a G-240W-B indoor ONT](#)

For information on the following topics, see the *7368 ISAM ONT Product Overview Guide*:

- ONT and MDU general descriptions of features and functions
- Ethernet interface specifications
- POTS interface specifications
- RSSI specifications
- Wi-Fi specifications
- ONT optical budget
- SLID entry via Ethernet port
- ONT management using an ONT interface

1.4 G-240W-B interfaces and interface capacity

Table 1-3 describes the supported interfaces and interface capacity for G-240W-B indoor ONTs.

Table 1-3 G-240W-B indoor ONT interface connection capacity

ONT type and model	Maximum capacity								
	POTS	10/100 BASE-T	10/100/1000 BASE-T	RF video (CATV)	MoCA	VDSL2	E1/T1	Local craft	GPON SC/APC
G-240W-B ⁽¹⁾	2	–	4	–	–	–	–	–	1

Note

(1) The G-240W-B ONTs provide Wi-Fi service that is enabled and disabled using a Wi-Fi on/off switch.

G-240W-B connections and components

Figure 1-1 shows the physical connections for G-240W-B indoor ONTs,

Figure 1-1 G-240W-B indoor ONT physical connections

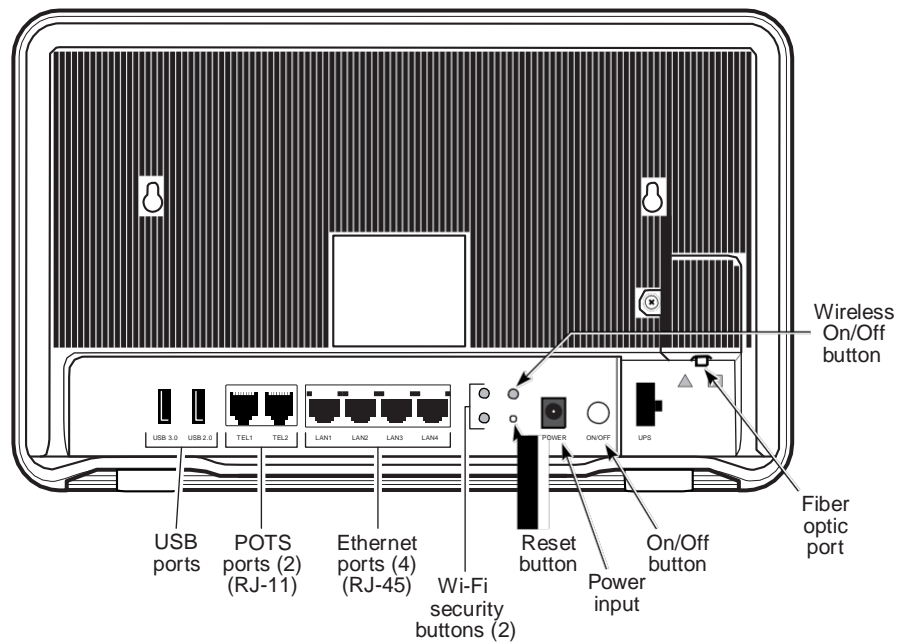

24614

Table 1-4 describes the physical connections for G-240W-B indoor ONTs.

Table 1-4 G-240W-B indoor ONT physical connections

Connection ⁽¹⁾	Description
USB ports	This connection is provided through 2 USB ports, 1 USB 3.0 and 1 USB 2.0. The ONT supports external USB hard drives that can be made accessible to all LAN devices.

(1 of 2)

Connection ⁽¹⁾	Description
POTS ports	This connection is provided through RJ-11 ports. Up to two POTS connections are supported. The POTS ports support voice services.
Ethernet ports	This connection is provided through Ethernet RJ-45 connectors. Up to four 10/100/1000 Base-T Ethernet interfaces are supported. The Ethernet ports can support both data and in-band video services on all four interfaces.
WPS buttons	The Wi-Fi Protected Setup buttons are labeled WPS2.4G and WPS5G. These buttons enable and disable WLAN data encryption.
WLAN button	Wi-Fi service is compliant with IEEE 802.11 standards and is enabled and disabled using the WLAN button.
Reset button	This button resets the ONT to the factory defaults.
Power input	This connection is provided through the power connector. A power cable fitted with a barrel connector is used to make the connection.
On/Off button	This button turns the ONT on or off.

(2 of 2)

Note

⁽¹⁾ The primary path for the earth ground for these ONTs is provided by the 12V Return signal in the power connector.

1.5 G-240W-B LEDs

Figure 1-2 shows the G-240W-B indoor ONT LEDs.

Figure 1-2 G-240W-B indoor ONT LEDs

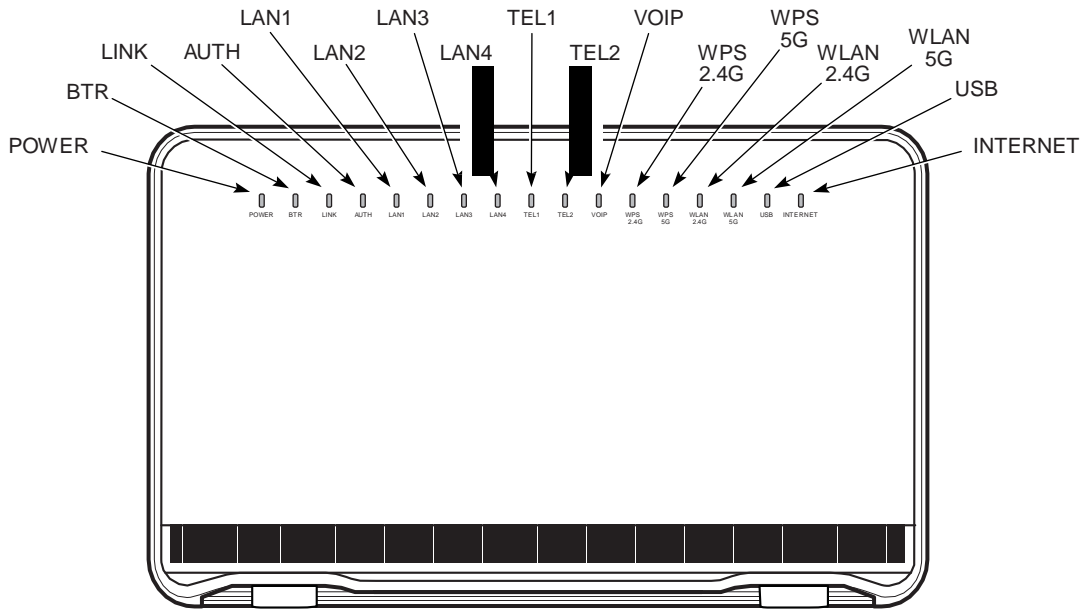

24615

Table 1-5 provides LED descriptions for G-240W-B indoor ONTs.

Table 1-5 G-240W-B indoor ONT LEDs

Indicator	LED color and behavior	LED behavior description
Power	Green solid Red solid Off	Power on Light failed on startup (for example corrupt flash), or self test failed on startup, or self test failed during regular operation or when executed over OMCI Power off
BTR	Off Green	Battery alarm set or battery not provisioned (not affected by AC power failure) Battery charged; no battery alarms
Link	Green solid Off	GPON link between ONT and OLT is operating normally GPON link is down or no link connected
Auth	Green solid Green flashing Off	ONT is authorized ONT is process of ranging or synchronizing on OMCI ONT is not authorized
LAN 1 to 4	Green solid Green flashing Off	Ethernet is linked LAN activity is present (in either direction) ONT power is off or Ethernet is not connected
TEL 1 to 2	Green solid Green flashing Off	Off hook Call in or talking On hook
VOIP	Green solid Off	VOIP service is OK VOIP service is not OK
WPS 2.4G and 5G	Green solid Green flashing Off	Wireless LAN link is up Wireless LAN link activity Wireless LAN link is down or no link is connected
WLAN 2.4G and 5G	Green solid Green flashing Off	Wireless is enabled There is traffic on wireless interface Wireless is down or no link is connected
USB	Green solid Green flashing Off	At least one USB device is connected There is traffic activity on at least on USB device No USB device is connected
INTERNET	Green solid Green flashing Off	HSI WAN is connected: a) the device has an IP address assigned from IPCP, DHCP, or static, and no traffic has been detected; b) the session is dropped due to idle timeout but the PON link is still present. PPPoE or DHCP connection in progress HSI WAN is not connected: a) there is no physical interface connection; b) the device is in bridged mode without an assigned IP address; c) the session has been dropped for reasons other than idle timeout.

1.6 G-240W-B detailed specifications

Table 1-6 lists the physical specifications for G-240W-B indoor ONTs.

Table 1-6 G-240W-B indoor ONT physical specifications

Description	Specification
Length	11.8 in. (300 mm)
Width	7.3 in. (185 mm)
Height	1.4 in. (36 mm)
Weight [within \pm 0.5 lb (0.23 kg)]	1.33 lb (0.61 kg)

Table 1-7 lists the power consumption specifications for G-240W-B indoor ONT.

Table 1-7 G-240W-B indoor ONT power consumption specifications

Mnemonic	Maximum power (Not to exceed)	Condition	Minimum power	Condition
G-240W-B (3FE 56525 AAAA)	30 W	2 POTS off-hook, 4 10/100/1000 Base-T Ethernet, Wi-Fi operational	12 W	2 POTS on-hook, other interfaces/services not provisioned

Table 1-8 lists the environmental specifications for G-240W-B indoor ONT.

Table 1-8 G-240W-B indoor ONT environmental specifications

Mounting method	Temperature range and humidity	Altitude
On desk or wall mounted	Operating: 23°F to 113°F (-5°C to 45°C) ambient temperature 10% to 90% relative humidity, non-condensing	Contact your Alcatel-Lucent technical support representative for more information
	Storage: Contact your Alcatel-Lucent support representative for more information	

1.7 G-240W-B GEM ports and T-CONTs

Table 1-9 lists the maximum number of supported T-CONTs and GEM ports. See the appropriate release Customer Release Notes for the most accurate list of supported devices.

Table 1-9 G-240W-B indoor ONT capacity for GEM ports and T-CONTs

ONT or MDU	Maximum	Notes
Package P ONTs		
GEM ports per indoor or outdoor ONT	64	—

(1 of 2)

ONT or MDU	Maximum	Notes
T-CONTs per indoor or outdoor ONT	32	–

(2 of 2)

1.8 G-240W-B performance monitoring statistics

The following section identifies the supported performance monitoring statistics for G-240W-B ONTs. A check mark indicates the statistic is supported on that ONT. An empty cell indicates the statistic is not supported. The following tables are categorized by supported alarm types:

- Table 1-10 provides statistics for ONTENET type counters
- Table 1-11 provides statistics for ONTL2UNI type counters
- Table 1-12 provides statistics for PONONTTC, PONONTMCTC, PONONTTCHSI, PONONTTCES, PONONTTCFLOW, and PONONTTCVOIP type counters
- Table 1-13 provides statistics for PONONTTC aggregate type counters



Note – If you have trouble accessing G-240W-B ONTs performance monitoring statistics using TL1, please contact your Alcatel-Lucent support representative for more information about how to access and retrieve performance monitoring type counters.

Si vous avez des difficultés à accéder aux statistiques de suivi de la performance G-240W-B ONT utilisant TL1, veuillez contacter votre représentant de support d'Alcatel-Lucent pour plus d'informations sur la façon d'accéder et de récupérer des compteurs de performance de type de surveillance.

Table 1-10 Package P ONTs ONTENET performance monitoring statistics

ONT	ONTENET statistics													
	FCSE	EC	LC	RBO	SCF	MCF	DT	IMTE	CSE	AE	IMRE	FTL	TBO	SQE
G-240W-B ⁽¹⁾	✓	✓	✓	✓	✓	✓	✓	✓	✓	✓	✓	✓	✓	✓

Note

- ⁽¹⁾ A 5 second polling window limitation exists on the ONT, therefore the margin of error for each 15-min window is 5 seconds

Table 1-11 Package P ONTs ONTL2UNI performance monitoring statistics

ONT	ONTL2UNI statistics										
	FRAMES	BYTES	MCFRAMES	DSDRPDFRMS	USDRPDFRMS	USFRAMES	DSFRAMES	USBYTES	DSBYTES	USMCFRAMES	DSMCFRAMES
G-240W-B (1)	✓	✓	✓	✓	✓	✓	✓	✓	✓	✓	✓

Note

- (1) A 5 second polling window limitation exists on the ONT, therefore the margin of error for each 15-min window is 5 seconds

Table 1-12 Package P ONTs PONONTTC, PONONTMCTC, PONONTTCHSI, PONONTTCCES, PONONTTCFLOW, PONONTTCVOIP performance monitoring statistics

ONT	PONONTTC, PONONTMCTC, PONONTTCHSI, PONONTTCCES, PONONTTCFLOW, PONONTTCVOIP statistics					
	TXBLOCKS	TXFRAGS	RXBLOCKS	RXFRAGS	LOSTFRAGS	BADGEMHDRS
G-240W-B (1)	✓	✓	✓	✓	✓	

Note

- (1) A 5 second polling window limitation exists on the ONT, therefore the margin of error for each 15-min window is 5 seconds

Table 1-13 Package P ONTs PONONTTC aggregate performance monitoring statistics

ONT	PONONTTC (aggregate) statistics					
	TXBLOCKS	TXFRAGS	RXBLOCKS	RXFRAGS	LOSTFRAGS	BADGEMHDRS
G-240W-B (1)	✓	✓	✓	✓	✓	

Note

- (1) A 5 second polling window limitation exists on the ONT, therefore the margin of error for each 15-min window is 5 seconds

1.9 G-240W-B functional blocks

G-240W-B indoor ONTs are single-residence ONTs that support Wireless (Wi-Fi) service. Wi-Fi service on these ONTs is compliant with the IEEE 802.11 standard and enabled or disabled using a WLAN button. In addition to the Wi-Fi service, these ONTs transmit Ethernet packets to four RJ-45 Ethernet ports and voice traffic to two RJ-11 POTS ports. These ONTs also feature fiber optic, USB, and power connectors.

Figure 1-3 shows the functional blocks for G-240W-B indoor ONT.

Figure 1-3 Single-residence Wi-Fi ONT with Gigabit Ethernet and POTS and without RF video

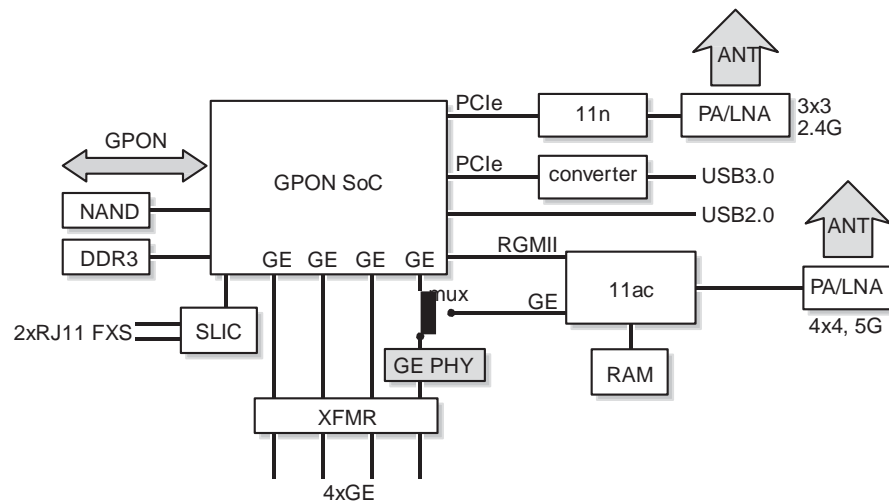

ONT SoC technology serves as the main hardware block for these ONTs; see Figure 1-4.

Figure 1-4 G-240W-B ONT hardware block

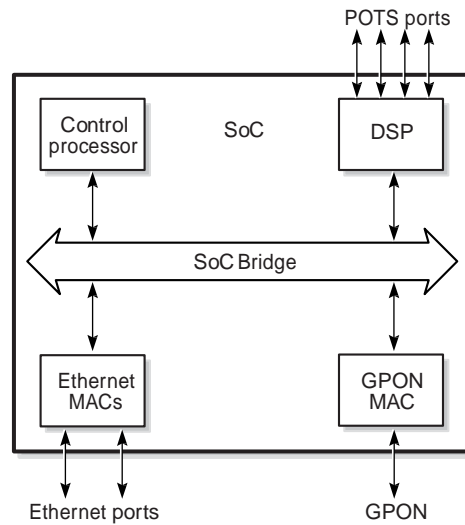

19421

ONT SoC technology consists of five key elements:

- **GPON MAC**
The Gigabit Passive Optical Network Media Access Control (GPON MAC) element on the SoC terminates the GPON interface using an optical diplexer. This interface supports GPON as described in G.984.3 (GPON TC Layer) ITU specification.
- **Ethernet MAC**
The SoC provides up to four GE MACs.
- **DSP interface**
The Digital Signal Processor (DSP) provides voice processing for 2 POTS lines with 3-way calling. The DSP has a dedicated 64 kbyte instruction cache and shares a 32 kbyte data cache with the Control Processor. It provides up to 4 network processor cores, each at 800MHz.
- **Control Processor**
The Control Processor features an integral memory management unit that supports a dedicated 64 kbyte instruction cache and shares a single 32 kbyte data cache with the DSP. The Control Processor and DSP also include a single channel Data Management Application (DMA) controller with a 4 kbyte read ahead low-latency Dynamic Random Access Memory (DRAM) access port. The processors typically run at 500 MHz.
- **Switch matrix**
The Switch matrix provides an integrated data channel between the four GE MACs, the GPON MAC, the DSP, the control processor, and the other integrated elements such as flash memory, DRAM, and the local bus controller.

These ONTs can also interact with additional hardware components to support functionality not provided by the SoC technology.

1.10 G-240W-B standards compliance

G-240W-B indoor ONTs are compliant with the following standards:

- 802.1p marking and VLAN based pbit is supported
- G.711 support for FAX and modem connection
- G.984 support GPON interface (framing)
- G.984.2 support for Amd1, class B+
- G.984.3 support for activation and password functions
- G.984.3 support for AES with operator enable/disable on per port-ID level
- G.984.3 support for FEC in both upstream and downstream directions
- G.984.3 support for multicast using a single GEM Port-ID for all video traffic
- G984.4 and G.983.2 support for OMCI v1 and v2 interface for ONT management and provisioning

FCC statement

This equipment has been tested and found to comply with the limits for a Class B digital device, pursuant to part 15 of the FCC Rules. These limits are designed to provide reasonable protection against harmful interference in a residential installation. This equipment generates, uses and can radiate radio frequency energy and, if not installed and used in accordance with the instructions, may cause harmful interference to radio communications. However, there is no guarantee that interference will not occur in a particular installation. If this equipment does cause harmful interference to radio or television reception, which can be determined by turning the equipment off and on, the user is encouraged to try to correct the interference by one or more of the following measures:

- Reorient or relocate the receiving antenna.
- Increase the separation between the equipment and receiver.
- Connect the equipment into an outlet on a circuit different from that to which the receiver is connected.
- Consult the dealer or an experienced radio/TV technician for help.

FCC Radiation Exposure Statement

This device complies with FCC radiation exposure limits set forth for an uncontrolled environment and it also complies with Part 15 of the FCC RF Rules. This equipment must be installed and operated in accordance with provided instructions and the antenna(s) used for this transmitter must be installed to provide a separation distance of at least 20 cm from all persons and must not be co-located or operating in conjunction with any other antenna or transmitter. End-users and installers must be provided with antenna installation instructions and consider removing the no-collocation statement.

This device complies with Part 15 of the FCC Rules. Operation is subject to the following two conditions:

- 1 this device may not cause harmful interference, and
- 2 this device must accept any interference received, including interference that may cause undesired operation.



Caution – Any changes or modifications not expressly approved by the party responsible for compliance could void the user's authority to operate the equipment.

Les changements ou modifications non expressément approuvés par la partie responsable de la conformité pourraient annuler l'autorité de l'utilisateur à utiliser l'équipement.

1.11 G-240W-B special considerations

G-240W-B is a package P ONT.

Wi-Fi service

G-240W-B indoor ONTs feature Wi-Fi service as well as voice and data services. Wi-Fi is a wireless networking technology that uses radio waves to provide wireless HSI and network connections. This ONT complies with the IEEE 802.11 standards, which the Wi-Fi Alliance defines as the basis for Wi-Fi technology.

Wi-Fi physical features

G-240W-B indoor ONTs have the following physical features that assist in providing Wi-Fi service:

- WLAN button for enabling and disabling Wi-Fi service
- two internal antennae
- two Wi-Fi Protected Setup (WPS) push buttons (one each for 2.4G and 5G) for adding WPS-enabled wireless devices

Wi-Fi standards and certifications

The Wi-Fi service on G-240W-B indoor ONTs supports the following IEEE standards and Wi-Fi Alliance certifications:

- compliant with IEEE 802.11 standards
- certified for IEEE 802.11b/g/n standards
- WPA support including WPA-PSK
- certified for WPA2-Personal and WPA2-Enterprise

Wi-Fi GUI features

G-240W-B indoor ONTs have HTML-based Wi-Fi configuration GUIs.

G-240W-B ONT considerations and limitations

Table 1-14 lists the considerations and limitations for Package P G-240W-B ONTs.

Table 1-14 G-240W-B ONT considerations and limitations

Considerations and limitations
Call History Data collection (ONTCALLHST) is supported, except for the following parameters: RTP packets (discarded), far-end RTCP and RTCP-XR participation, RTCP average and peak round trip delay, MOS, average jitter, number of jitter-buffer over-runs and under runs.
Some voice features are configurable on a per ONT basis, including Call Waiting, Call Hold, 3-Way Calling, and Call Transfer.
The following voice features / GSIP parameters are configurable on a per-Client/ per-ONT basis (not per-Subscriber): <ul style="list-style-type: none"> • Enable Caller ID and Enable Caller Name ID • Digitmap and the associated Interdigit and Critical timers and Enter key parameters • Warmline timer is enabled per subscriber, but the warmline timer value is configured per ONT and must have a lower value than the Permanent time • Miscellaneous timers: Permanent, Timed-release, Reanswer, Error-tone, and CW-alert timers • Features / functions: Message waiting mode, WMWI refresh interval, DTMF volume level • Service Codes for the following features: CCW, Call Hold and Warmline
The Molex interface is not operational.

2 – *Install a G-240W-B indoor ONT*

- 2.1 Purpose 2-2**
- 2.2 General 2-2**
- 2.3 Prerequisites 2-2**
- 2.4 Recommended tools 2-2**
- 2.5 Safety information 2-3**
- 2.6 Procedure 2-4**

2.1 Purpose

This chapter provides the steps to install a G-240W-B indoor ONT.

2.2 General

The steps listed in this chapter describe mounting and cabling for G-240W-B indoor ONTs.

2.3 Prerequisites

You need the following items before beginning the installation:

- all required cables

2.4 Recommended tools

You need the following tools for the installation:

- #2 Phillips screwdriver
- 1/4 in. (6 mm) flat blade screwdriver
- wire strippers
- fiber optic splicing tools
- RJ-45 cable plug crimp tool
- voltmeter or multimeter
- optical power meter
- drill and drill bits
- paper clip

2.5 Safety information

Read the following safety information before installing the unit.



Danger 1 – Hazardous electrical voltages and currents can cause serious physical harm or death. Always use insulated tools and follow proper safety precautions when connecting or disconnecting power circuits.

Tensions et courants électriques dangereuses peuvent causer des dommages ou la mort physique grave. Toujours utiliser des outils isolés et suivre les précautions de sécurité adéquates pour connecter ou déconnecter les circuits de puissance.

Danger 2 – Make sure all sources of power are turned off and have no live voltages present on feed lines or terminals. Use a voltmeter to measure for voltage before proceeding.

Assurez-vous que toutes les sources d'alimentation sont éteints et ne ont pas de tensions vivants présents sur les lignes d'alimentation ou de terminaux. Utilisez un voltmètre pour mesurer la tension avant de procéder.

Danger 3 – Always contact the local utility company before connecting the enclosure to the utilities.

Toujours contacter la compagnie d'électricité locale avant de brancher l'enceinte pour les services publics.



Warning – This equipment is ESD sensitive. Proper ESD protections should be used when removing the fiber access cover of the indoor ONT.

Cet équipement est sensible ESD. Protections ESD appropriées doivent être utilisées pour retirer le couvercle de l'ONT à l'intérieur d'accès en fibre.



Caution – Keep indoor ONTs out of direct sunlight. Prolonged exposure to direct sunlight can damage the unit.

Gardez ONT intérieur hors du soleil direct. Une exposition prolongée aux rayons du soleil peut endommager l'appareil.



Note 1 – Observe the local and national laws and regulations that may be applicable to this installation.

Respecter les lois et réglementations locales et nationales qui peuvent être applicables à cette installation.

Note 2 – Observe the following:

- The indoor ONT should be installed in accordance with the applicable requirements of the NEC or CEC. Local authorities and practices take precedent when there is conflict between the local standard and the NEC or CEC.
- The indoor ONT must be installed by qualified service personnel.
- Indoor ONTs must be installed with cables that are suitably rated and listed for indoor use.
- See the detailed specifications in the [G-240W-B unit data sheet](#) for the temperature ranges for these ONTs.

Respectez les consignes suivantes:

-
- L'ONT intérieure doit être installée en conformité avec les exigences applicables de la NEC ou CEC. Les autorités et les pratiques locales prennent prééminent quand il ya conflit entre la norme locale et le NEC ou CEC.
 - L'ONT intérieure doit être installée par un personnel qualifié
 - L'ONT intérieure doit être installée avec des câbles qui sont convenablement évalués et classés pour une utilisation intérieure.
 - Voir les spécifications détaillées dans la fiche de données de l'unité G-240W-B pour les plages de température pour ces ONT.

2.6 Procedure

Use this procedure to install a G-240W-B indoor ONT.

- 1 Place the indoor ONT unit:
 - a On the flat surface, such as a desk; go to step 3.



Note — The G-240W-B cannot be stacked with another ONT or with other equipment. The ONT mounting requirements are:

- allow a minimum 100 mm clearance above the top cover
- allow a minimum 50 mm clearance from the side vents
- do not place any heat source directly above the top cover or below the bottom cover

Le G-240W-B ne peut être empilé avec un autre ONT ou avec d'autres équipements. Les exigences de montage ONT sont:

- Laisser un espace minimum de 100 mm au-dessus du capot supérieur
- Laisser un espace minimum de 50 mm à partir des prises d'air latérales
- Ne placez pas une source de chaleur directement au-dessus du capot supérieur ou inférieur à la couverture inférieure

- b On a wall, go to step 2.
- 2 Mount the G-240W-B indoor ONT on a wall.
 - i The G-240W-B indoor ONT can be mounted in either a horizontal or vertical position, as shown in Figure 2-1. If possible, mount the ONT on a wall stud.

Figure 2-1 Wall mounting keyholes on G-240W-B indoor ONTs

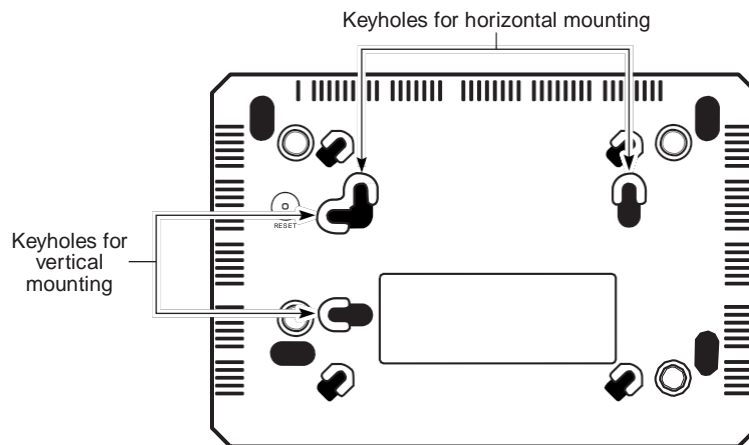

24111

- ii Mark the wall with the location of the mounting holes. These holes should be the same distance apart as the distance between the centers of the keyholes on the ONT.
 - iii Drill the two holes in the wall where the ONT will be mounted and then drive the mounting screws into the holes.

The recommended length of mounting screw is 1.15 in. (3.8 cm).

Do not drive the screw into the wall completely. Leave approximately 1/8 in. (6 mm) between the screw head and the wall surface.

- iv Slide the wall mount keyholes on the ONT enclosure or fiber storage tray down over the mounting screws until the ONT is securely seated.
- 3 Review the connection locations as shown in Figures 2-2.

Figure 2-2 G-240W-B indoor ONT connections (back view)

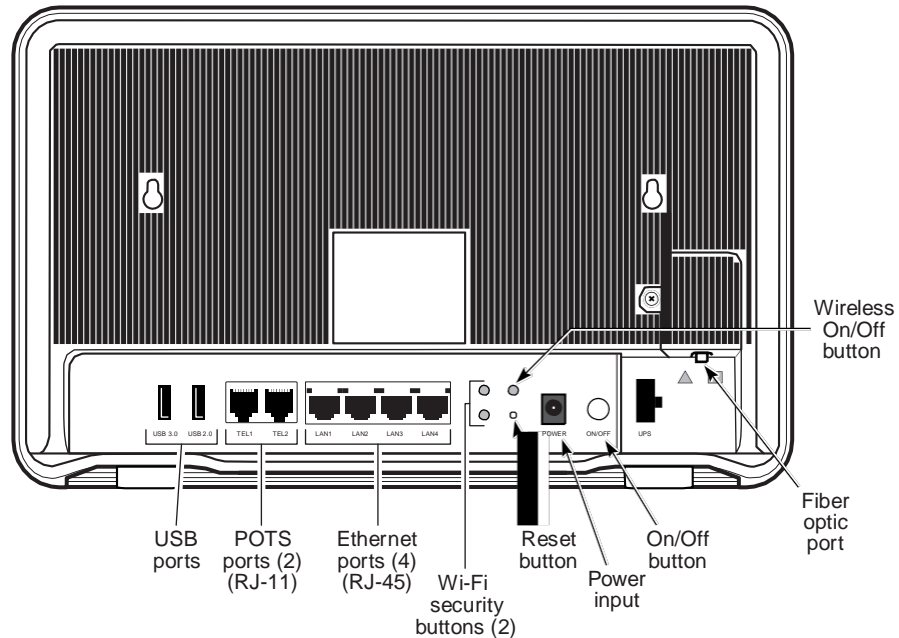

24614

- 4 Connect the Ethernet cables to the RJ-45 ports; see Figure 2-2 for the location of the RJ-45 ports.
- 5 Route the POTS cables directly to the RJ-11 ports as per local practices.
The POTS port to the left is labeled 1 for Line 1 while the port on the right is labeled 2 for Line 2, as shown in Figure 2-2.
- 6 Connect the fiber optic cable with SC/APC adapter into the SC/APC connector; see Figure 2-2 for the location of the SC/APC connector.



Danger — Fiber cables transmit invisible laser light. To avoid eye damage or blindness, never look directly into fibers, connectors, or adapters.

Câbles de fibres transmettent la lumière laser invisible. Pour éviter des lésions oculaires ou la cécité, ne jamais regarder directement dans les fibres, les connecteurs ou adaptateurs.



Warning — Be careful to maintain a bend radius of no less than 1.5 in. (3.8 cm) when connecting the fiber optic cable. Too small of a bend radius in the cable can result in damage to the optic fiber.

Veillez à maintenir un rayon de courbure d'au moins 1,5 po. (3,8 cm) lors de la connexion du câble de fibre optique. Trop petit d'un rayon de courbure dans le câble peut entraîner des dommages à la fibre optique.

2 – Install a G-240W-B indoor ONT



Note — Fiber cable preparation varies depending on the type and size of the inside or outside plant fiber cable being spliced to the SC/APC fiber optic pigtail cable.

Préparation du câble de fibres varie en fonction du type et de la taille de l'intérieur ou de câble de fibres de plante extérieur étant assemblés bord à bord pour la SC/APC câble en queue de cochon à fibres optiques.

- 7 Install the power supply according to manufacturer specifications.



Note — Observe the following:

- Units must be powered by a Listed or CE approved and marked limited power source power supply with a minimum output rate of 12 V dc, 1.25 A.

Respectez les onsignes suivantes:

- Les unités doivent être alimentés par une alimentation de source d'alimentation limitée répertoriés ou homologués CE et sont marqués d'un taux de sortie minimum de 12 V cc, 1,25 A

- 8 Connect the power cable to the power connector.
- 9 Power up the ONT unit by using the power switch.
- 10 If used, enable the Wi-Fi service.
 - i Locate the WLAN button on the ONT; see Figure 2-2 for location of the WLAN button.
 - ii Press the WLAN button to change the status of the Wi-Fi service.
- 11 Verify the ONT LEDs, voltage status, and optical signal levels; see the *7368 Hardware and Cabling Installation Guide*.
- 12 Activate and test the services; see the *7368 Hardware and Cabling Installation Guide*.
- 13 If used, configure the SLID; see the *7368 ISAM ONT Configuration, Management, and Troubleshooting Guide*.
- 14 If necessary, reset the ONT.
 - i Locate the Reset button on a G-240W-B indoor ONT as shown in Figure 2-2.
 - ii Insert the end of a straightened paper clip or other narrow object into the hole in the Reset button to reset the ONT.
- 15 STOP. This procedure is complete.

3 — *Replace a G-240W-B indoor ONT*

- 3.1 Purpose 3-2**
- 3.2 General 3-2**
- 3.3 Prerequisites 3-2**
- 3.4 Recommended tools 3-2**
- 3.5 Safety information 3-3**
- 3.6 Procedure 3-4**

3.1 Purpose

This chapter provides the steps to replace G-240W-B indoor ONTs.

3.2 General

The steps listed in this chapter describe mounting and cabling for G-240W-B indoor ONTs.

3.3 Prerequisites

You need the following items before beginning the installation:

- all required cables

3.4 Recommended tools

You need the following tools for replacing the ONT:

- #2 Phillips screwdriver
- 1/4 in. (6 mm) flat blade screwdriver
- wire strippers
- fiber optic splicing tools
- RJ-45 cable plug crimp tool
- voltmeter or multimeter
- optical power meter
- drill and drill bits

3.5 Safety information

Read the following safety information before replacing the unit.



Danger 1 – Hazardous electrical voltages and currents can cause serious physical harm or death. Always use insulated tools and follow proper safety precautions when connecting or disconnecting power circuits.

Tensions et courants électriques dangereuses peuvent causer des dommages ou la mort physique grave. Toujours utiliser des outils isolés et suivre les précautions de sécurité adéquates pour connecter ou déconnecter les circuits de puissance.

Danger 2 – Make sure all sources of power are turned off and have no live voltages present on feed lines or terminals. Use a voltmeter to measure for voltage before proceeding.

Assurez-vous que toutes les sources d'alimentation sont éteintes et ne ont pas de tensions vivants présents sur les lignes d'alimentation ou de terminaux. Utilisez un voltmètre pour mesurer la tension avant de procéder.

Danger 3 – Always contact the local utility company before connecting the enclosure to the utilities.

Toujours contacter la compagnie d'électricité locale avant de brancher l'enceinte pour les services publics.



Warning – This equipment is ESD sensitive. Proper ESD protections should be used when removing the fiber access cover of the indoor ONT.

Cet équipement est sensible ESD. Protections ESD appropriées doivent être utilisées pour retirer le couvercle de l'ONT à l'intérieur d'accès en fibre.



Caution – Keep indoor ONTs out of direct sunlight. Prolonged exposure to direct sunlight can damage the unit.

Gardez ONT intérieur hors du soleil direct. Une exposition prolongée aux rayons du soleil peut endommager l'appareil.



Note 1 – Observe the local and national laws and regulations that may be applicable to this installation.

Respecter les lois et réglementations locales et nationales qui peuvent être applicables à cette installation.

Note 2 – Observe the following:

- The indoor ONT should be installed in accordance with the applicable requirements of the NEC or CEC. Local authorities and practices take precedent when there is conflict between the local standard and the NEC or CEC.
- The indoor ONT must be installed by qualified service personnel.
- Indoor ONTs must be installed with cables that are suitably rated and listed for indoor use.
- See the detailed specifications in the [G-240W-B unit data sheet](#) for the ONT temperature ranges for these ONTs.

Respectez les consignes suivantes:

- L'ONT intérieure doit être installée en conformité avec les exigences applicables de la NEC ou CEC. Les autorités et les pratiques locales prennent prééminent quand il ya conflit entre la norme locale et le NEC ou CEC.
- L'ONT intérieure doit être installée par un personnel qualifié
- L'ONT intérieure doit être installée avec des câbles qui sont convenablement évalués et classés pour une utilisation intérieure.
- Voir les spécifications détaillées dans la fiche de données de l'unité G-240W-B pour les plages de température pour ces ONT.

3.6 Procedure

Use this procedure to replace a G-240W-B indoor ONT.

- 1 Deactivate the ONT services at the P-OLT.

If you are using the SLID feature, this step is not required. The ONT and the services can remain in service (IS).

- i Use the RTRV-ONT command to verify the ONT status and the associated services. Record the serial number or the SLID of the ONT displayed in the command output.

Example:

```
RTRV-ONT::ONT-1-1-1-1-1;
```

- ii If the ONT is in service, place the ONT in OOS state.

Example:

```
ED-ONT::ONT-1-1-1-1-1;
```

- 2 If used, disable the Wi-Fi service by pressing the WLAN button; see Figure 3-1 for the location of the WLAN button.

Figure 3-1 G-240W-B indoor ONT connections

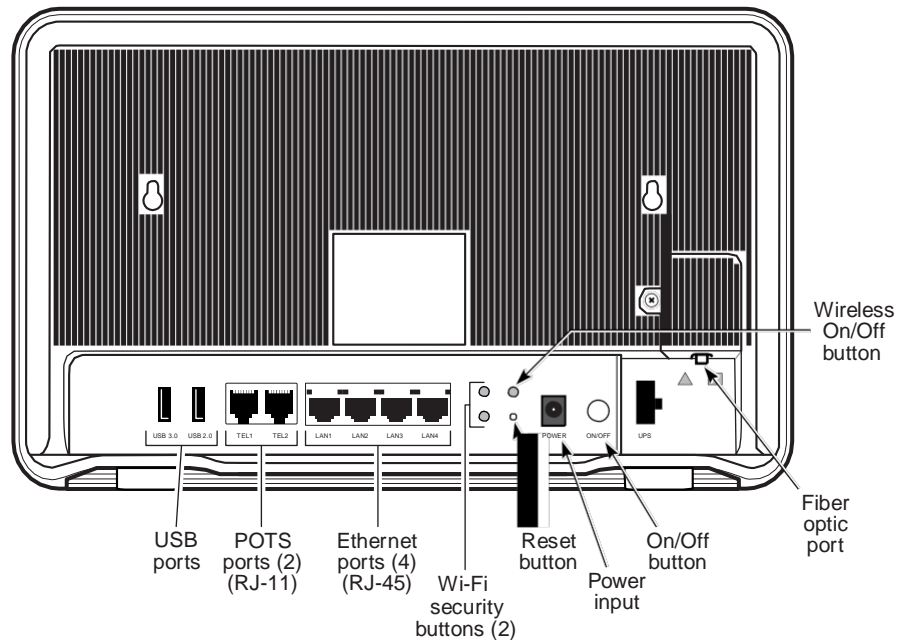

24614

- 3 Power down the unit by using the on/off power switch.
- 4 Disconnect the POTS, Ethernet, and power cables from the ONT; see Figure 3-1 for the connector locations on the G-240W-B indoor ONT.

5 Disconnect the fiber optic cables.



Danger — Fiber cables transmit invisible laser light. To avoid eye damage or blindness, never look directly into fibers, connectors, or adapters.

Câbles de fibres transmettent la lumière laser invisible. Pour éviter des lésions oculaires ou la cécité, ne jamais regarder directement dans les fibres, connecteurs ou adaptateurs

- i Unplug the fiber optic cable with SC/APC connector from the ONT; see Figure 3-1 for the location of the fiber optic port.
- ii Attach a fiber dust cover to the end of the SC/APC connector.

6 Replace the ONT with a new unit:

- a On a flat surface, such as a desk, substitute the new ONT for the old ONT on a flat surface, horizontally resting on its four feet.
- b On a wall.
 - i Slide the old ONT off of the mounting screws until the ONT is free of the wall.
 - ii Slide the wall mount holes on the ONT enclosure over the mounting screws until it is securely seated.

7 Connect the Ethernet cables directly to the RJ-45 ports; see Figure 3-1 for the location of the RJ-45 ports.

8 Connect the POTS cables directly to the RJ-11 ports as per local practices; see Figure 3-1 for the location of the RJ-11 ports.

The RJ-11 port to the left is labeled 1 for Line 1 while the port on the right is labeled 2 for Line 2.

9 If required, have approved service personnel who are trained to work with optic fiber clean the fiber optic connection. See the *7368 ISAM ONT Configuration, Management, and Troubleshooting Guide* for more information about fiber optic handling, inspection, and cleaning.



Danger — Fiber optic cables transmit invisible laser light. To avoid eye damage or blindness, never look directly into fibers, connectors, or adapters.

Câbles de fibre optique transmettent la lumière laser invisible. Pour éviter des lésions oculaires ou la cécité, ne jamais regarder directement dans les fibres, les connecteurs ou adaptateurs.

10 Connect the fiber optic cable with SC/APC adapter into the SC/APC connector. Figure 3-1 shows the location of the SC/APC connector.



Danger — Fiber cables transmit invisible laser light. To avoid eye damage or blindness, never look directly into fibers, connectors, or adapters.

Câbles de fibre optique transmettent la lumière laser invisible. Pour éviter des lésions oculaires ou la cécité, ne jamais regarder directement dans les fibres, les connecteurs ou adaptateurs.



Warning — Be careful to maintain a bend radius of no less than 1.5 in.

(3.8 cm) when connecting the fiber optic cable. Too small of a bend radius in the cable can result in damage to the optic fiber.

Veillez à maintenir un rayon de courbure d'au moins 1,5 po. (3,8 cm) lors de la connexion du câble de fibre optique. Trop petit d'un rayon de courbure dans le câble peut entraîner des dommages à la fibre optique.

3 – Replace a G-240W-B indoor ONT



Note — Fiber cable preparation varies depending on the type and size of the inside or outside plant fiber cable being spliced to the SC/APC fiber optic pigtail cable.

Préparation du câble de fibres varie en fonction du type et de la taille de l'intérieur ou de câble de fibres de plante extérieur étant assemblés bord à bord pour la SC/APC câble en queue de cochon à fibres optiques.

- 11 Install the power supply according to manufacturer specifications.



Note — Observe the following:

- Units must be powered by a Listed or CE approved and marked limited power source power supply with a minimum output rate of 12 V dc, 1.25 A.

Respectez les consignes suivantes:

- Les unités doivent être alimentées par une alimentation de source d'alimentation limitée répertoriées ou homologuées CE et sont marquées d'un taux de sortie minimum de 12 V cc, 1,25 A.

- 12 Connect the power cable to the power connector.
- 13 Power up the unit by using the power switch.
- 14 If used, enable the Wi-Fi service by pressing the WLAN button; see Figure 3-1 for the location of the WLAN button.
- 15 If used, configure the SLID; see the *7368 ISAM ONT Configuration, Management, and Troubleshooting Guide* for more information.



Note — A new SLID or the old SLID may be used with the replacement ONT. If a new SLID is used, the new SLID must also be programmed at the P-OLT using TL1 or a network manager. If the old SLID is used, no changes need to be made at the P-OLT; see the operations and maintenance documentation for the OLT for more details.

Une nouvelle EDTR ou le vieux EDTR peut être utilisé avec l'ONT de remplacement. Si une nouvelle EDTR est utilisé, le nouveau EDTR doit également être programmé à la classe P-OLT utilisant TL1 un gestionnaire de réseau. Si l'ancien EDTR est utilisé, aucune modification ne est à apporter à la classe P-OLT; voir les opérations et la documentation de maintenance pour le BTA pour plus de détails.

- 16 Verify the ONT LEDs, voltage status, and optical signal levels; see the *7368 Hardware and Cabling Installation Guide*.
- 17 Activate and test the services; see the *7368 Hardware and Cabling Installation Guide*.
- 18 If necessary, reset the ONT.
- Locate the Reset button on a G-240W-B indoor ONT as shown in Figure 3-1.
 - Insert the end of a straightened paper clip or other narrow object into the hole in the Reset button to reset the ONT.
- 19 STOP. This procedure is complete.

4 — *Configure a G-240W-B indoor ONT*

- 4.1 General 4-2**
- 4.2 HGU mode GUI configuration 4-2**
- 4.3 SFU mode GUI configuration 4-39**
- 4.4 Operator ID 4-44**

4.1 General

Please refer to the configuration information provided with your OLT for the software configuration procedure for a G-240W-B ONT.

For HTTP configuration procedures, please refer to the *7368 ISAM ONT Configuration, Management, and Troubleshooting Guide*.

4.2 HGU mode GUI configuration

Use the procedures below to use the web-based GUI for the G-240W-B in HGU mode. This mode is preset at delivery.

A home gateway unit (HGU) is a home networking device, used as a gateway to connect devices in the home through fiber to the Internet. An HGU provides a variety of features for the home network including routing and firewall capability. By using the HGU, users can connect all smart equipment in their home, including personal computers, set-top boxes, mobile phones, and other consumer electronics devices, to the Internet.

Login

Use the procedure below to login to the web-based GUI for the G-240W-B.

Procedure 4-1 Login to web-based GUI

- 1 Open a web browser and enter the IP address of the ONT in the address bar.

The login window appears.

The default gateway IP address is `http://192.168.1.1`. You can connect to this IP address using your web browser after connecting your PC to one of Ethernet ports of the ONT. The static IP address of your PC must be in the same subnet as the ONT.

- 2 Enter your username and password in the Log in window, as shown in Figure 4-1.

The default username and password are printed on the ONT. The default user name is `userAdmin`. The default superuser name is `adminGPON`. Contact Alcatel-Lucent for the superuser password.

Figure 4-1 Web login window

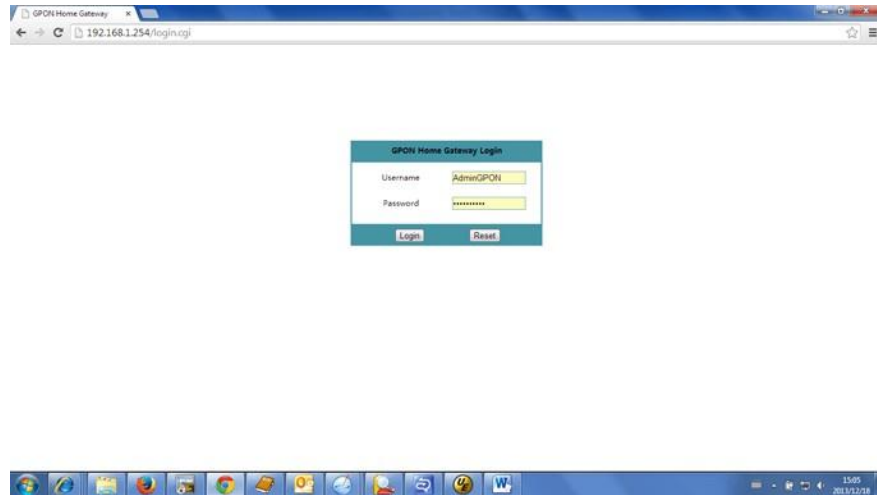

Caution — If you reset the router to recover the default username and password, all other router configuration settings will also be restored to their factory default values.

Si vous réinitialisez le routeur pour récupérer le nom d'utilisateur et mot de passe par défaut, tous les autres paramètres de configuration du routeur seront aussi restaurés à leurs valeurs par défaut d'usine.



Note — If you forget the current username and password, press the reset button for 5 s and the default values for the username and password will be recovered at startup.

Si vous oubliez le nom d'utilisateur et mot de passe actuel, appuyez sur le bouton de réinitialisation pendant 5 s et les valeurs par défaut pour le nom d'utilisateur et mot de passe seront récupérés au démarrage.

- 3 Click Login.
- 4 STOP. This procedure is complete.

Device and connection status

G-240W-B ONTs support the retrieval of a variety of device and connection information, including:

- device information
- LAN status
- WAN status
- WAN status IPv6
- Home networking information
- Optics module status

4 – Configure a G-240W-B indoor ONT

Procedure 4-2 Device information retrieval

- 1 Select Status > Device Information from the top-level menu in the GPON Home Gateway window, as shown in Figure 4-2.

Figure 4-2 Device Information window

Table 4-1 describes the fields in the Device Information window.

Table 4-1 Device Information parameters

Field	Description
Device Name	Name on the ONT
Vendor	Name of the vendor
Serial Number	Serial number of the ONT
Hardware version	Hardware version of the ONT
Boot version	Boot version of the ONT
Software version	Software version of the ONT
Chipset	Chipset of the ONT
Device Running Time	Amount of time the device has run since last reset in hours, minutes, and seconds

- 2 Click Refresh to update the displayed information.
- 3 STOP. This procedure is complete.

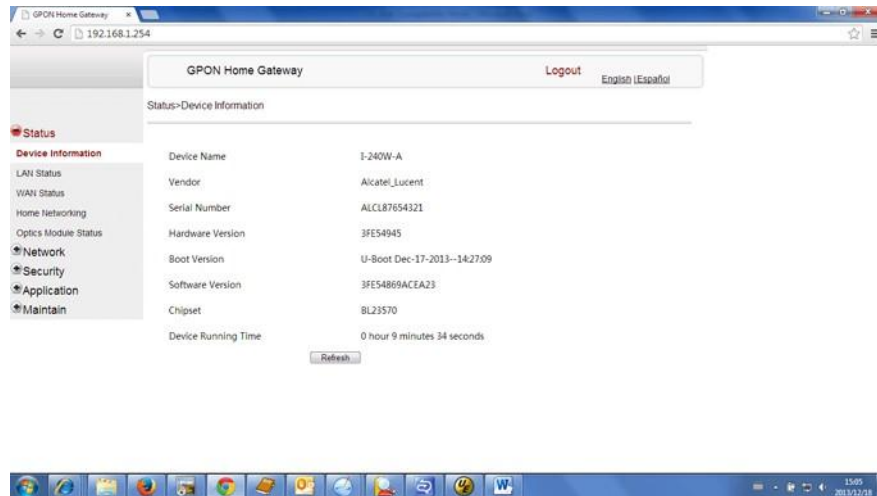
Procedure 4-3 LAN status retrieval

- 1 Select Status > LAN Status from the top-level menu in the GPON Home Gateway window, as shown in Figure 4-3.

Figure 4-3 LAN status window

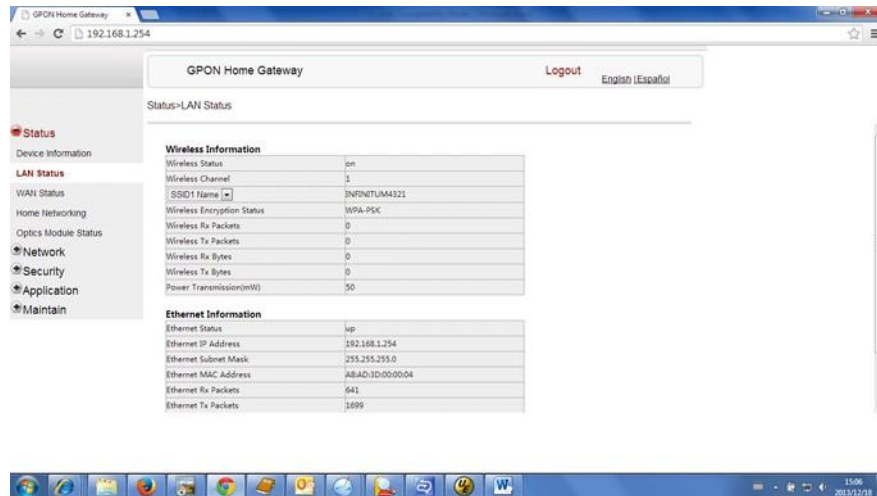

Table 4-2 describes the fields in the LAN status window.

Table 4-2 LAN status parameters

Field	Description
Wireless Information	
Wireless Status	Indicates whether the wireless is on or off
Wireless Channel	Wireless channel number
SSID Name	Name of each SSID
Wireless Encryption Status	Encryption type used on the wireless connection
Wireless Rx Packets	Number of packets received on the wireless connection
Wireless Tx Packets	Number of packets transmitted on the wireless connection
Wireless Rx Bytes	Number of bytes received on the wireless connection
Wireless Tx Bytes	Number of bytes transmitted on the wireless connection
Power Transmission (mW)	Power of the wireless transmission, in mW
Ethernet Information	
Ethernet Status	Indicates whether the Ethernet connection is on or off
Ethernet IP Address	IP address of the Ethernet connection

(1 of 2)

4 – Configure a G-240W-B indoor ONT

Field	Description
Ethernet Subnet Mask	Subnet Mask of the Ethernet connection
Ethernet MAC Address	MAC address of the Ethernet connection
Ethernet Rx Packets	Number of packets received on the Ethernet connection
Ethernet Tx Packets	Number of packets transmitted on the Ethernet connection
Ethernet Rx Bytes	Number of bytes received on the Ethernet connection
Ethernet Tx Bytes	Number of bytes transmitted on the Ethernet connection

(2 of 2)

- 2 Click Refresh to update the displayed information.
- 3 STOP. This procedure is complete.

Procedure 4-4 WAN status retrieval

- 1 Select Status > WAN Status from the top-level menu in the GPON Home Gateway window, as shown in Figure 4-4.

Figure 4-4 WAN status window

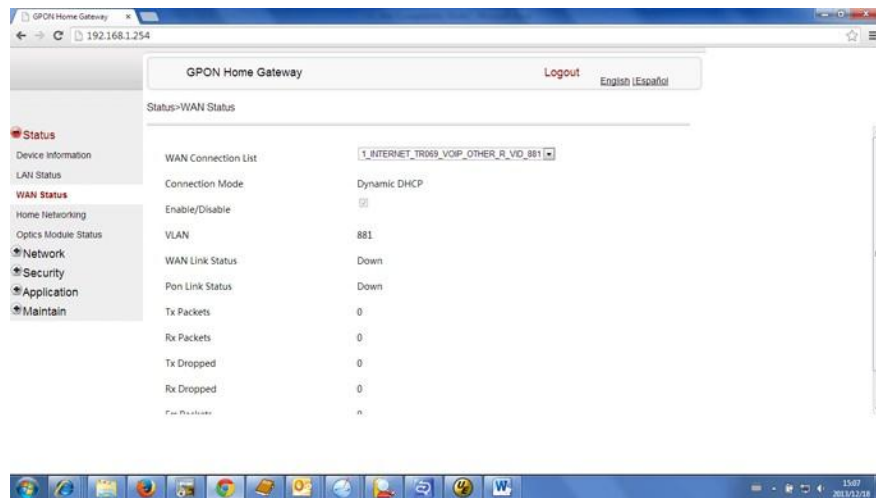

Table 4-3 describes the fields in the WAN status window.

Table 4-3 WAN status parameters

Field	Description
WAN connection list	Drop-down menu listing all WAN connections. The connection shown is the connection for which WAN status will be shown.
Connection Mode	Connection mode of the WAN connection
Enable/Disable	Select this checkbox to enable the WAN connection
VLAN	VLAN ID
WAN Link Status	Whether the WAN link is up or down
Pon Link Status	Whether the PON link is up or down
Tx Packets	Number of packets transmitted on the WAN connection
Rx Packets	Number of packets received on the WAN connection
Tx Dropped	Number of packets dropped on the transmit WAN connection
Rx Dropped	Number of packets dropped on the receive WAN connection
Err Packets	Number of errored packets on the WAN connection

- 2 Click Refresh to update the displayed information.
- 3 STOP. This procedure is complete.

Procedure 4-5 WAN status IPv6 retrieval

- 1 Select Status > WAN Status IPv6 from the top-level menu in the GPON Home Gateway window, as shown in Figure 4-5.

Figure 4-5 WAN status IPv6 window

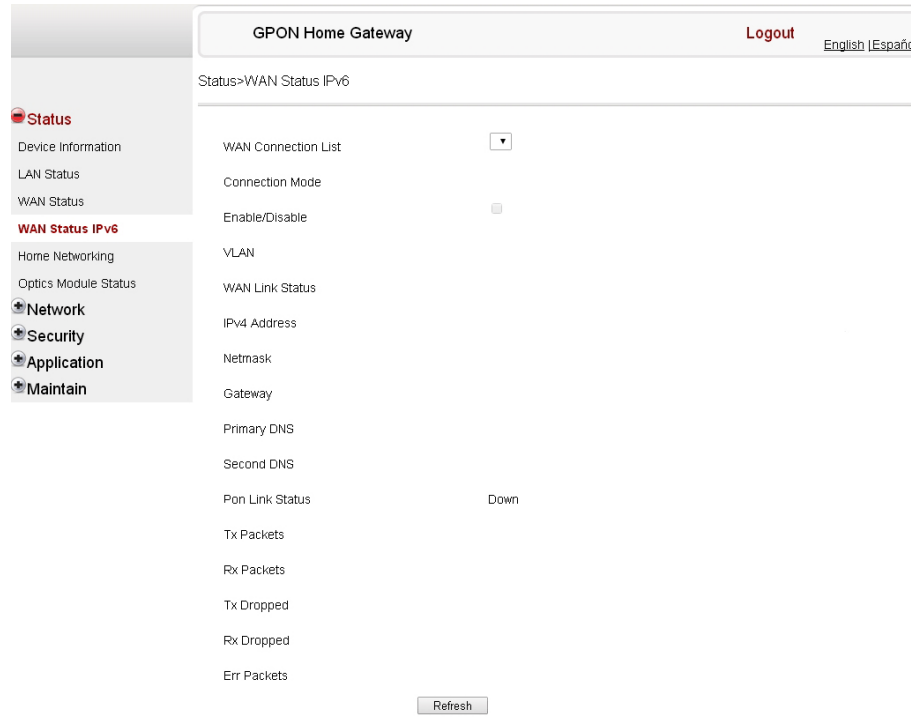

Table 4-4 describes the fields in the WAN status IPv6 window.

Table 4-4 WAN status IPv6 parameters

Field	Description
WAN connection list	Drop-down menu listing all WAN connections. The connection shown is the connection for which WAN status will be shown.
Connection Mode	Connection mode of the WAN connection
Enable/Disable	Select this checkbox to enable the WAN connection
VLAN	VLAN ID
WAN Link Status	Whether the WAN link is up or down
IPv6 Address	IPv6 address that identifies the device and its location
Netmask	Network mask
Gateway	Gateway address
Primary DNS	Primary Domain Name Server
Second DNS	Secondary Domain Name Server
Pon Link Status	Whether the PON link is up or down

(1 of 2)

Field	Description
Tx Packets	Number of packets transmitted on the WAN connection
Rx Packets	Number of packets received on the WAN connection
Tx Dropped	Number of packets dropped on the transmit WAN connection
Rx Dropped	Number of packets dropped on the receive WAN connection
Err Packets	Number of errored packets on the WAN connection

(2 of 2)

2 Click Refresh to update the displayed information.

3 STOP. This procedure is complete.

Procedure 4-6 Home networking information retrieval

- 1 Select Status > Home Networking from the top-level menu in the GPON Home Gateway window, as shown in Figure 4-6.

Figure 4-6 Home networking information window

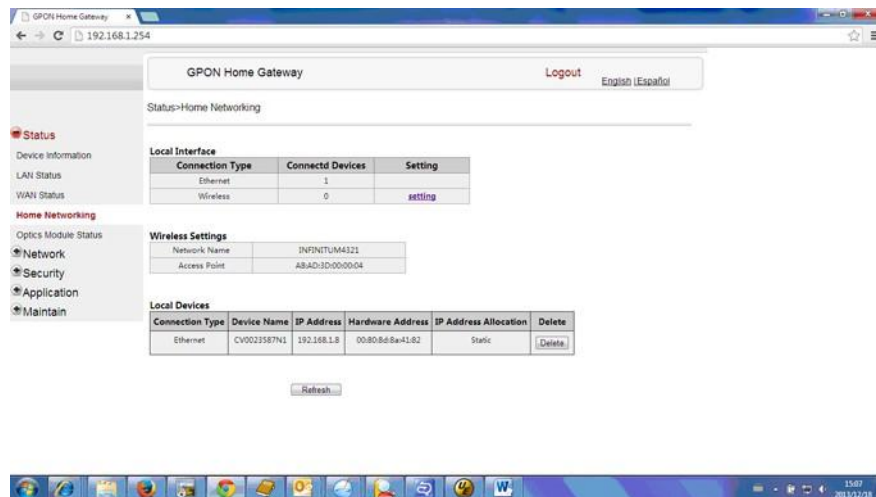

Table 4-5 describes the fields in the Home networking window.

Table 4-5 Home networking parameters

Field	Description
Local Interface	
Ethernet	Table displays the number of Ethernet connections and their settings
Wireless	Table displays the number of wireless connections and their settings
Wireless Settings	

(1 of 2)

4 – Configure a G-240W-B indoor ONT

Field	Description
Network Name	Name of the wireless network
Access Point	Hexadecimal address of the wireless access point
Local Devices	
Table entry	Each entry indicates the connection type, device name, IP address, hardware address, and IP address allocation of each connected local device.

(2 of 2)

- 2 Click Delete to delete a particular local device connection.
- 3 Click Refresh to update the displayed information.
- 4 STOP. This procedure is complete.

Procedure 4-7 Optics module status retrieval

- 1 Select Status > Optics Module Status from the top-level menu in the GPON Home Gateway window, as shown in Figure 4-7.

Figure 4-7 Optics module status window

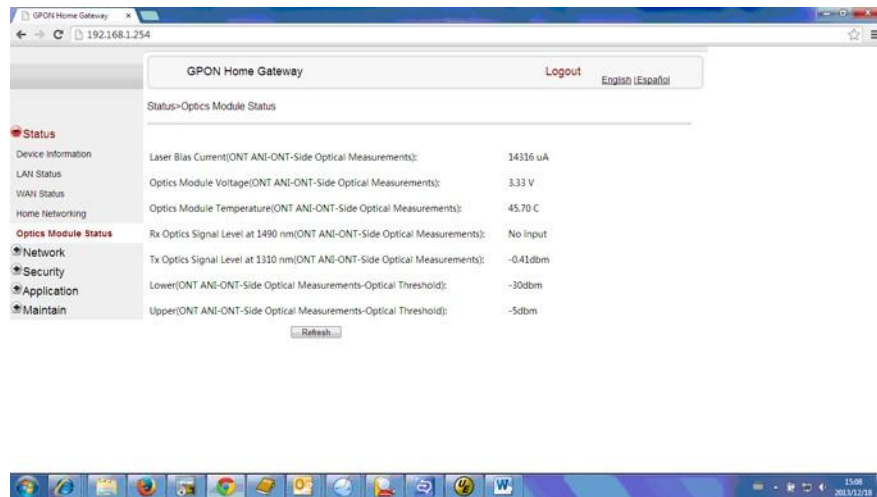

Table 4-6 describes the fields in the Optics module status window.

Table 4-6 Optics module status parameters

Field	Description
Laser Bias Current (ONT ANI-ONT-Side Optical Measurements)	Laser bias current, measured in uA
Optics Module Voltage (ONT ANI-ONT-Side Optical Measurements)	Optics module voltage, measured in V

(1 of 2)

Field	Description
Optics Module Temperature (ONT ANI-ONT-Side Optical Measurements)	Optics module temperature, measured in C
Rx Optics Signal Level at 1490 nm (ONT ANI-ONT-Side Optical Measurements)	Received optics signal level at 1490 nm, measured in dBm
Tx Optics Signal Level at 1310 nm (ONT ANI-ONT-Side Optical Measurements)	Transmitted optics signal level at 1310 nm, measured in dBm
Lower (ONT ANI-ONT-Side Optical Measurements-Optical Threshold)	Lower optical threshold, measured in dBm
Upper (ONT ANI-ONT-Side Optical Measurements-Optical Threshold)	Lower optical threshold, measured in dBm

(2 of 2)

- 2 Click Refresh to update the displayed information.
- 3 STOP. This procedure is complete.

Network configuration

G-240W-B ONTs also support network configuration, including:

- LAN
- LAN IPv6
- WAN
- WiFi 2.4G
- WiFi 5G
- Routing
- DNS
- TR-069

4 – Configure a G-240W-B indoor ONT

Procedure 4-8 LAN networking configuration

- 1 Select Network > LAN from the top-level menu in the GPON Home Gateway window, as shown in Figure 4-8.

Figure 4-8 LAN network window

Table 4-7 describes the fields in the LAN network window.

Table 4-7 LAN network parameters

Field	Description
Port Mode: All Port to L2 Mode	Select this checkbox to set all ports to L2 mode
Port Mode Port 1 - 4	Drop-down port mode for each port: Route mode or bridge mode
IPv4 Address	IP Address of the ONT
Subnet Mask	Subnet mask of the ONT
DHCP enable	Select this checkbox to enable DHCP
DHCP Start IP Address	Starting DHCP IP address
DHCP End IP Address	Ending DHCP IP address
DHCP Lease Time	DHCP lease time (in min)
Bind MAC Address	MAC address to associate to the LAN
Bind IP Address	IP address to associate to the bound MAC address

- 2 Select the mode for each port.
- 3 Click Save.
- 4 Enter the DHCP configuration information.

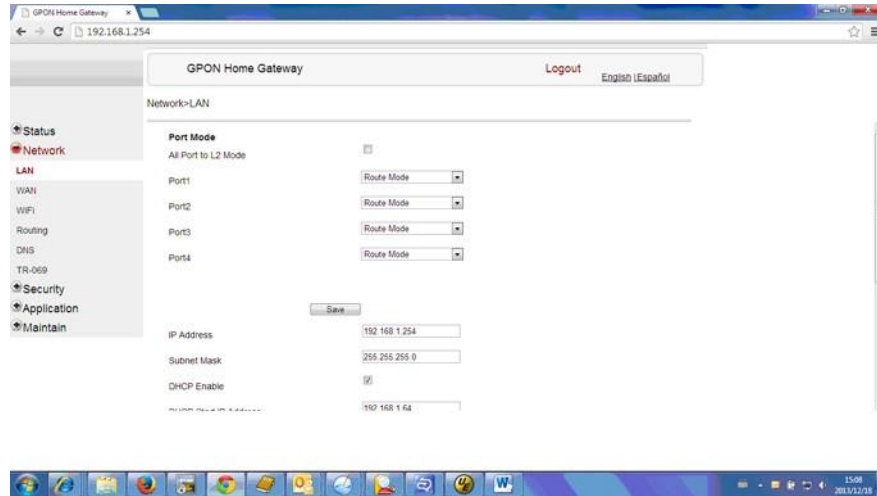
- 5 Click Save.
- 6 Bind a MAC address to the LAN by entering the MAC and IP addresses and then clicking Add. Repeat for all MAC addresses to be bound.
- 7 STOP. This procedure is complete.

Procedure 4-9 LAN IPv6 networking configuration

- 1 Select Network > LAN_IPv6 from the top-level menu in the GPON Home Gateway window, as shown in Figure 4-9.

Figure 4-9 LAN IPv6 network window

Table 4-8 describes the fields in the LAN IPv6 network window.

Table 4-8 LAN IPv6 network parameters

Field	Description
DNS Server	Choose a DNS server from the drop-down menu.
prefix config	Choose a prefix config option from the drop-down menu, either WANConnection (prefix will be obtained from the WAN) or Static (enables you to enter the prefix).
prefix	This field appears if you selected the “Static” option for the “prefix config” field. Type a connection.
Interface	This field appears if you selected the Wan Connection option for the “prefix config” field. Choose a WAN connection interface from the drop-down menu.

(1 of 2)

4 – Configure a G-240W-B indoor ONT

Field	Description
DHCPv6 Server Enable	Select this checkbox to enable DHCP IPv6 server.
DHCP Start IP Address	Enter the starting DHCP IP address.
DHCP End IP Address	Enter the ending DHCP IP address.
Whether the address info through DHCP	Select this checkbox to enable address information retrieval through DHCP.
Whether other info obtained through DHCP	Select this checkbox to enable retrieval of other information through DHCP.
Maximum interval for periodic RA messages	Enter the maximum interval (in seconds) for periodic Router Advertisement messages. The interval range is from 4 to 1800.
Minimum interval for periodic RA messages	Enter the minimum interval (in seconds) for periodic Router Advertisement messages. The interval range is from 4 to 1800.

(2 of 2)

- 2 Choose a DNS server, prefix config, and interface.
 - 3 Select or enter the DHCP configuration information.
 - 4 Enter the maximum and minimum intervals for RA messages.
 - 5 Click Save/Apply.
 - 6 STOP. This procedure is complete.
-

Procedure 4-10 WAN networking configuration

- 1 Select Network > WAN from the top-level menu in the GPON Home Gateway window, as shown in Figure 4-10.

Figure 4-10 WAN network window

Table 4-9 describes the fields in the WAN network window.

Table 4-9 WAN network parameters

Field	Description
WAN Connection List	Choose a WAN connection from the drop-down menu to set the connection parameters
Connection Type	Select a connection type: IPoE or PPPoE
IP Mode	Choose an IP mode from the drop-down menu: IPv4 or IPv6
Enable/Disable	Select this checkbox to enable the WAN connection
NAT	Select this checkbox to enable NAT
Service	Select the checkboxes to enable service types for this connection
Enable VLAN	Select this checkbox to enable VLAN
VLAN ID	Enter the VLAN ID
VLAN PRI	Enter the VLAN PRI
WAN IP Mode	Choose an IP mode from the drop-down menu

(1 of 2)

4 – Configure a G-240W-B indoor ONT

Field	Description
Connection Type	Choose a connection type from the drop-down menu
Username	Enter the username
Password	Enter the password
Keep Alive Time	Enter the Keep Alive Time (from 5 to 60 seconds)

(2 of 2)

- 2 Configure a specific WAN connection.
- 3 Click Save.
- 4 STOP. This procedure is complete.

Procedure 4-11 WiFi 2.4G networking configuration

- 1 Select Network > WiFi 2.4G from the top-level menu in the GPON Home Gateway window, as shown in Figure 4-11.

Figure 4-11 WiFi 2.4G network window

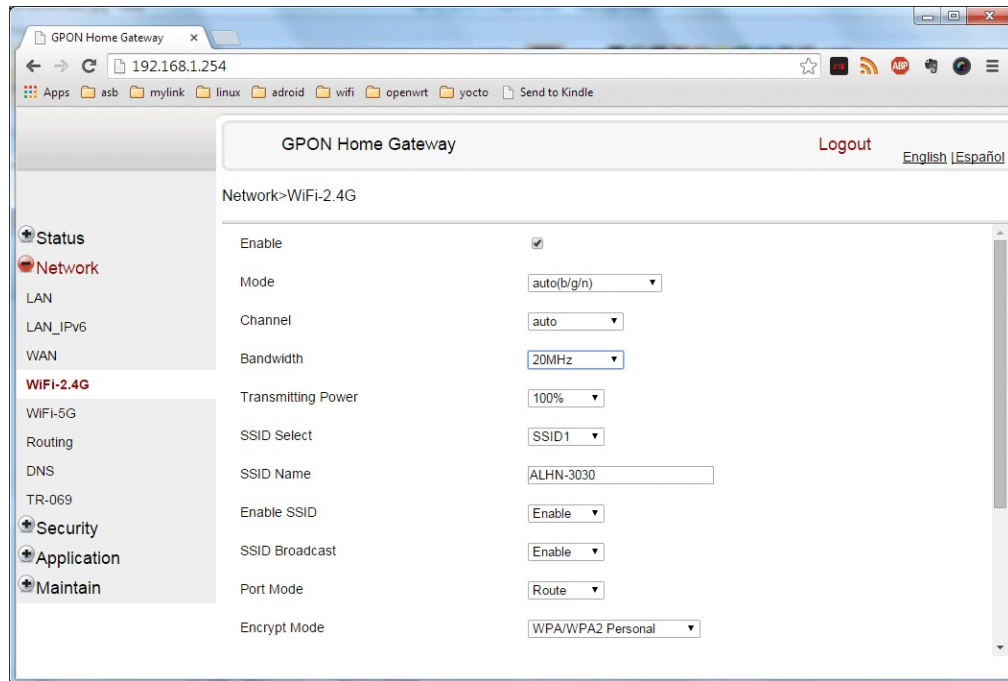

Table 4-10 describes the fields in the WiFi 2.4G network window.

Table 4-10 WiFi 2.4G network parameters

Field	Description
Enable	Select this checkbox to enable WiFi
Mode	Choose a wi-fi mode from the drop-down menu: <ul style="list-style-type: none"> • auto (b/g/n) • b • g • n • b/g
Channel	Choose a channel from the drop-down menu or choose Auto to have the channel automatically assigned
Bandwidth	Choose 20 MHz or 40 MHz from the drop-down menu.
Transmitting Power	Choose the percentage transmitting power from the drop-down menu
SSID Select	Choose the SSID from the drop-down menu
SSID Name	Enter the SSID name
Enable SSID	Enable or disable SSID from this drop-down menu
SSID Broadcast	Enable or disable SSID broadcast from this drop-down menu
Port Mode	Choose a port mode from the drop-down menu: <ul style="list-style-type: none"> • Route • Bridge
Encrypt Mode	Choose an encryption mode from the drop-down menu: <ul style="list-style-type: none"> • OPEN • WEP • WPA/WPA2 Personal • WPA/WPA2 Enterprise
WPA Version	Choose a WPA version from the drop-down menu: <ul style="list-style-type: none"> • WPA1 • WPA2 • WPA1/WPA2
WPA Encryption Mode	Choose a WPA encryption mode from the drop-down menu: <ul style="list-style-type: none"> • TKIP • AES • TKIP/AES
WPA Key	Enter the WPA key
Enable WPS	Enable or disable WPS from this drop-down menu

- 2 Configure the WiFi connection.
- 3 If you have enabled and configured WPS, click WPS connect.
- 4 Click Save.
- 5 STOP. This procedure is complete.

Procedure 4-12 WiFi 5G networking configuration

- 1 Select Network > WiFi 5G from the top-level menu in the GPON Home Gateway window, as shown in Figure 4-12.

Figure 4-12 WiFi 5G network window

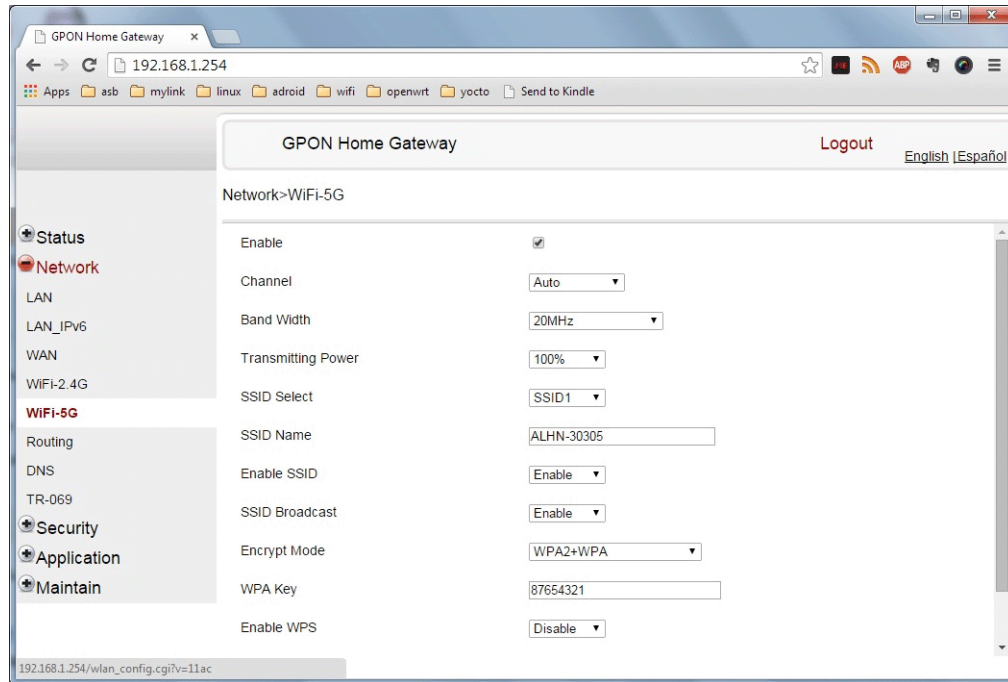

Table 4-11 describes the fields in the WiFi 5G network window.

Table 4-11 WiFi 5G network parameters

Field	Description
Enable	Select this checkbox to enable WiFi
Channel	Choose a channel from the drop-down menu or choose Auto to have the channel automatically assigned
Bandwidth	Choose 20 MHz or 40 MHz from the drop-down menu
Transmitting Power	Choose the percentage transmitting power from the drop-down menu
SSID Select	Choose the SSID from the drop-down menu
SSID Name	Enter the SSID name
Enable SSID	Enable or disable SSID from this drop-down menu
SSID Broadcast	Enable or disable SSID broadcast from this drop-down menu

(1 of 2)

Field	Description
Encrypt Mode	Choose an encryption mode from the drop-down menu: <ul style="list-style-type: none"> • OPEN • WEP • WPA/WPA2 Personal • WPA/WPA2 Enterprise
WPA Key	Enter the WPA key
Enable WPS	Enable or disable WPS from this drop-down menu

(2 of 2)

- 2 Configure the WiFi connection.
- 3 If you have enabled and configured WPS, click WPS connect.
- 4 Click Save.
- 5 STOP. This procedure is complete.

Procedure 4-13 Routing configuration

- 1 Select Network > Routing from the top-level menu in the GPON Home Gateway window, as shown in Figure 4-13.

Figure 4-13 Routing network window

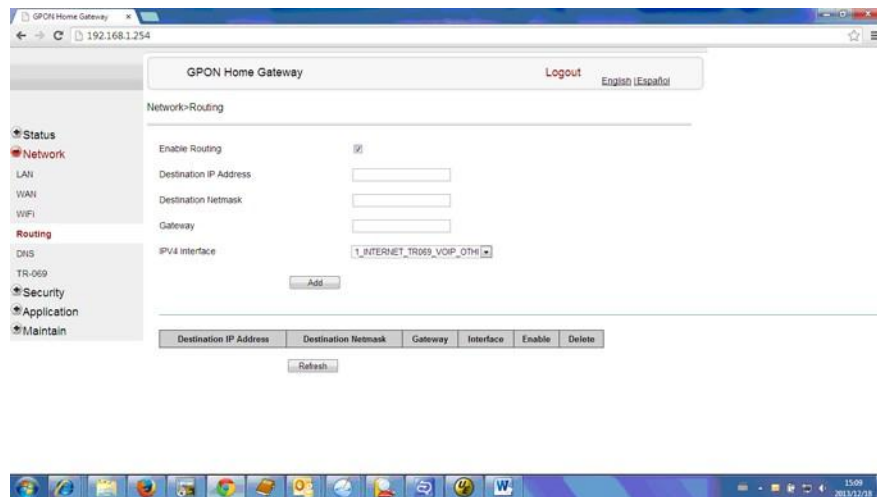

Table 4-12 describes the fields in the Routing network window.

4 – Configure a G-240W-B indoor ONT

Table 4-12 Routing network parameters

Field	Description
Enable Routing	Select this checkbox to enable routing
Destination IP Address	Enter the destination IP address
Destination Netmask	Enter the destination network mask
Gateway	Enter the gateway address
IPv4 Interface	Choose a WAN connection previously created in the WAN network window from the drop-down menu

- 2 Enter the routing information.
- 3 Click Add.
- 4 STOP. This procedure is complete.

Procedure 4-14 DNS configuration

- 1 Select Network > DNS from the top-level menu in the GPON Home Gateway window, as shown in Figure 4-14.

Figure 4-14 DNS network window

Table 4-13 describes the fields in the DNS network window.

Table 4-13 DNS network parameters

Field	Description
Domain Name	Domain name
IPv4 Address	Domain IP address
Origin Domain	Origin domain name
New Domain	New domain name

- 2 Enter the domain name and IP address and click Add.
- 3 If required, associate an origin domain with a new domain, click Add.
- 4 STOP. This procedure is complete.

Procedure 4-15 TR-069 configuration

- 1 Select Network > TR-069 from the top-level menu in the GPON Home Gateway window, as shown in Figure 4-15.

Figure 4-15 TR-069 network window

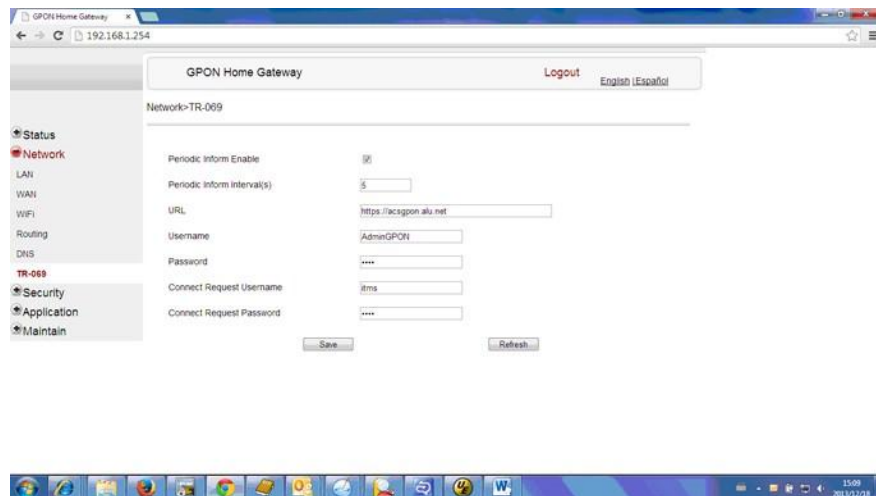

Table 4-14 describes the fields in the TR-069 network window.

Table 4-14 TR-069 network parameters

Field	Description
Periodic Inform Enable	Select this checkbox to enable periodic inform updates

(1 of 2)

4 – Configure a G-240W-B indoor ONT

Field	Description
Periodic Inform Interval(s)	Time between periodic inform updates, in seconds
URL	URL of the auto-configuration server
Username	Username used to log in to the ONT
Password	Password used to log in to the ONT
Connect Request Username	Username used to log in to the auto-configuration server
Connect Request Password	Password used to log in to the auto-configuration server

(2 of 2)

- 2 Configure TR-069 by entering the required information.
 - 3 Click Save.
 - 4 STOP. This procedure is complete.
-

Security configuration

G-240W-B ONT also supports security configuration, including:

- firewall
- MAC filter
- IP filter
- DMZ and ALG

Procedure 4-16 Firewall configuration

- 1 Select Security > Firewall from the top-level menu in the GPON Home Gateway window, as shown in Figure 4-16.

Figure 4-16 Firewall window

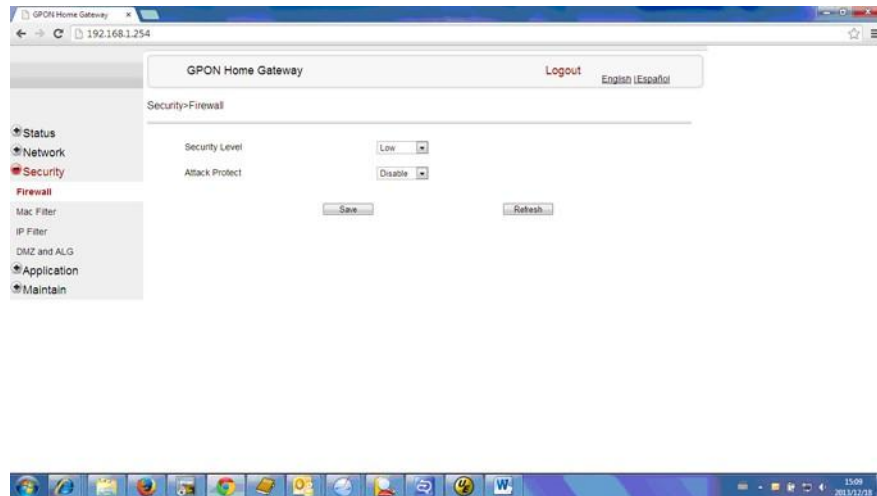

Table 4-15 describes the fields in the firewall window.

Table 4-15 Firewall parameters

Field	Description
Security level	Choose the security level from the drop-down menu
Attack Protect	Enable or disable attack protect from the drop-down menu

- 2 Configure the firewall.
- 3 Click Save.
- 4 STOP. This procedure is complete.

4 – Configure a G-240W-B indoor ONT

Procedure 4-17 MAC filter configuration

- 1 Select Security > Mac Filter from the top-level menu in the GPON Home Gateway window, as shown in Figure 4-17.

Figure 4-17 MAC filter window

Table 4-16 describes the fields in the MAC filter window.

Table 4-16 MAC filter parameters

Field	Description
Enable MAC filter	Select this checkbox to enable the MAC filter
Mac Address	MAC address
Mac Filter Mode	Choose the MAC filter mode from this drop-down menu

- 2 Configure a MAC filter.
- 3 Click Add.
- 4 STOP. This procedure is complete.

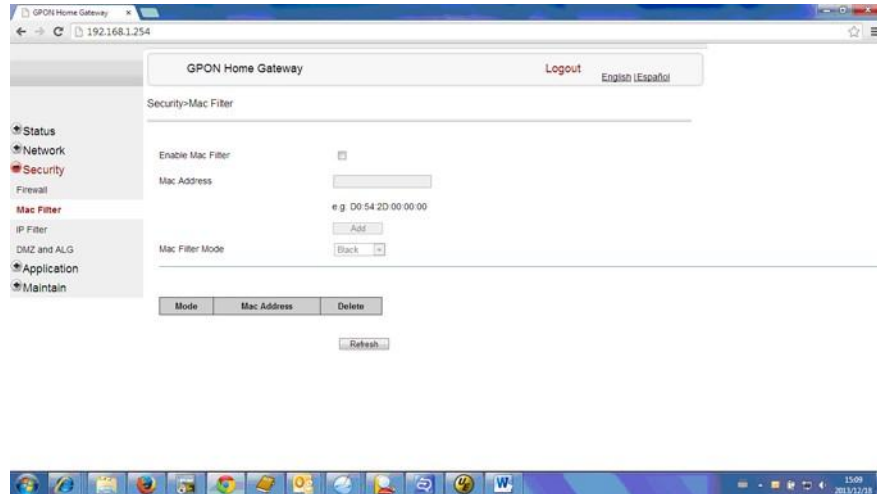
Procedure 4-18 IP filter configuration

- 1 Select Security > IP filter from the top-level menu in the GPON Home Gateway window, as shown in Figure 4-18.

Figure 4-18 IP filter window

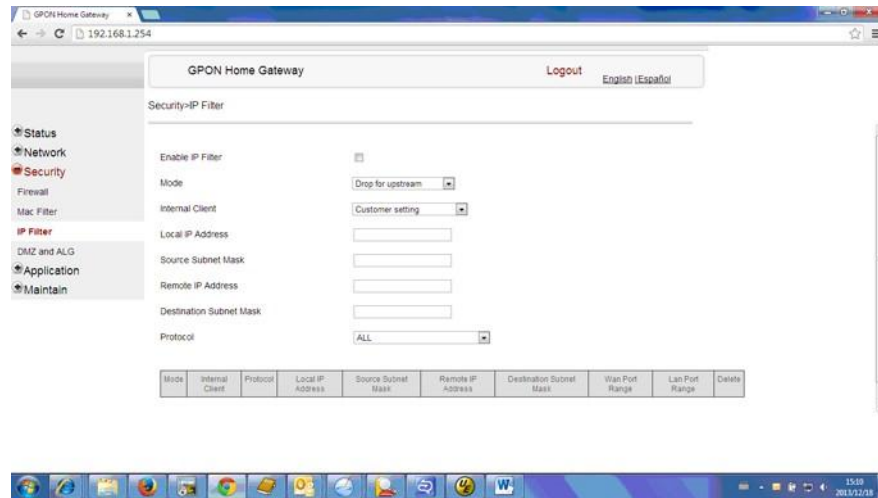

Table 4-17 describes the fields in the IP filter window.

Table 4-17 IP filter parameters

Field	Description
Enable IP Filter	Select this checkbox to enable an IP filter
Mode	Choose an IP filter mode from the drop-down menu: <ul style="list-style-type: none"> • Drop for upstream • Drop for downstream
Internal Client	Choose an internal client from the drop-down menu: <ul style="list-style-type: none"> • Customer setting - uses the IP address input below • IP - uses the connecting devices' IP to the ONT
Local IP Address	Local IP address
Source Subnet Mask	Source subnet mask
Remote IP Address	Remote IP address
Destination Subnet Mask	Destination subnet mask
Protocol	Choose an application protocol or all from the drop-down menu

- 2 Configure the IP filter.

4 – Configure a G-240W-B indoor ONT

- 3 Click Add.
- 4 STOP. This procedure is complete.

Procedure 4-19 DMZ and ALG configuration

- 1 Select Security > DMZ and ALG from the top-level menu in the GPON Home Gateway window, as shown in Figure 4-19.

Figure 4-19 DMZ and ALG window

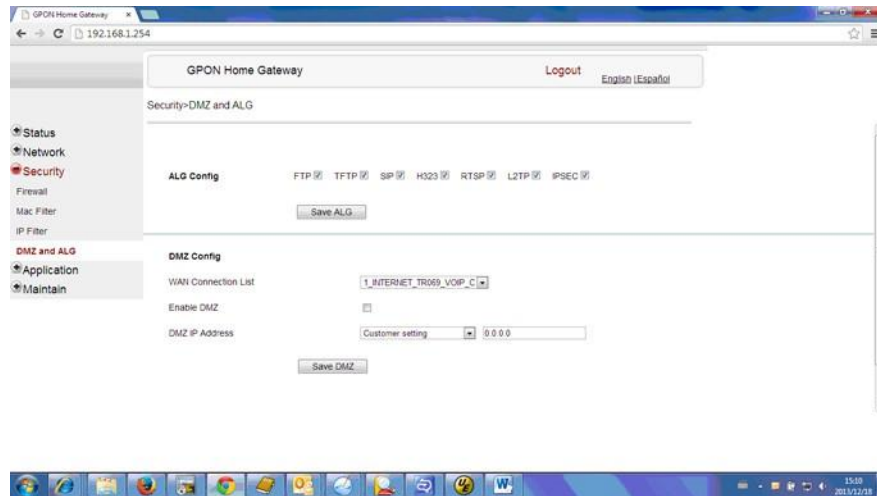

Table 4-18 describes the fields in the DMZ and ALG window.

Table 4-18 DMZ and ALG parameters

Field	Description
ALG Config	Select the checkboxes to enable the protocols to be supported by the ALG
DMZ Config	
WAN Connection List	Choose a WAN connection from the drop-down menu
Enable DMZ	Select this checkbox to enable DMZ on the chosen WAN connection
DMZ IP Address	Choose Customer Setting and enter the DMZ IP address or choose the IP address of a connected device from the drop-down menu

- 2 Configure ALG.
- 3 Click Save ALG.
- 4 Configure DMZ.

- 5 Click Save DMZ.
- 6 STOP. This procedure is complete.

Application configuration

G-240W-B ONT also supports application configuration, including:

- port forwarding
- DDNS
- NTP
- USB storage

Procedure 4-20 Port forwarding configuration

- 1 Select Application > Port forwarding from the top-level menu in the GPON Home Gateway window, as shown in Figure 4-20.

Figure 4-20 Port forwarding window

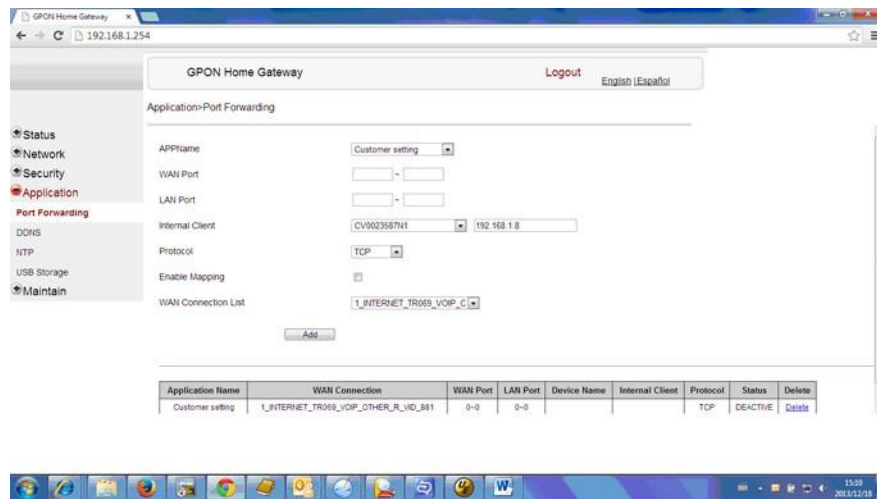

Table 4-19 describes the fields in the port forwarding window.

Table 4-19 Port forwarding parameters

Field	Description
APPName	Choose an application name from the drop-down menu
WAN Port	WAN port range
LAN Port	LAN port range
Internal Client	Choose a connected device from the drop-down menu and enter the associated IP address

(1 of 2)

4 – Configure a G-240W-B indoor ONT

Field	Description
Protocol	Choose the port forwarding protocol from the drop-down menu: <ul style="list-style-type: none"> • TCP • UDP • TCP/UDP
Enable Mapping	Select this checkbox to enable mapping
WAN Connection List	Choose a WAN connection from the drop-down menu

(2 of 2)

- 2 Configure port forwarding.
- 3 Click Add.
- 4 STOP. This procedure is complete.

Procedure 4-21 DDNS configuration

- 1 Select Application > DDNS from the top-level menu in the GPON Home Gateway window, as shown in Figure 4-21.

Figure 4-21 DDNS window

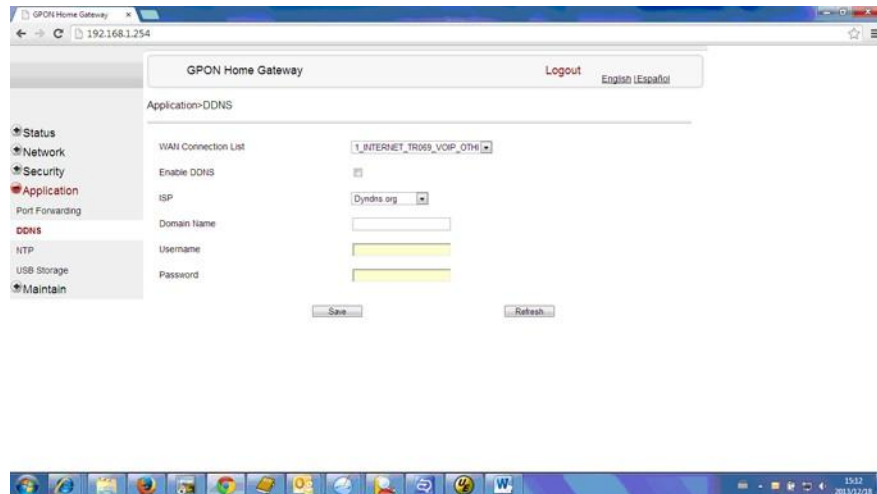

Table 4-20 describes the fields in the DDNS window.

Table 4-20 DDNS parameters

Field	Description
WAN Connection List	Choose a WAN connection from the drop-down menu

(1 of 2)

Field	Description
Enable DDNS	Select this checkbox to enable DDNS on the chosen WAN connection
ISP	Choose an ISP from the drop-down menu.
Domain Name	Domain name
Username	Username
Password	Password

(2 of 2)

- 2 Configure DDNS.
- 3 Click Save.
- 4 STOP. This procedure is complete.

Procedure 4-22 NTP configuration

- 1 Select Application > NTP from the top-level menu in the GPON Home Gateway window, as shown in Figure 4-22.

Figure 4-22 NTP window

Table 4-21 describes the fields in the NTP window.

Table 4-21 NTP parameters

Field	Description
Enable NTP Service	Select this checkbox to enable NTP service
Current Time	Enter the current local date and time
First Time Server	Choose a time server from the drop-down menu or choose Customer setting and enter the address of the time server.

(1 of 2)

4 – Configure a G-240W-B indoor ONT

Field	Description
Second Time Server	Choose a time server from the drop-down menu or choose Customer setting and enter the address of the time server.
Interval Time	Interval at which to get the time from the time server, in seconds
Time Zone	Choose the local time zone from the drop-down menu

(2 of 2)

- 2 Configure NTP.
- 3 Click Save.
- 4 STOP. This procedure is complete.

Procedure 4-23 USB storage configuration

- 1 Select Application > USB storage from the top-level menu in the GPON Home Gateway window, as shown in Figure 4-23.

Figure 4-23 USB storage window

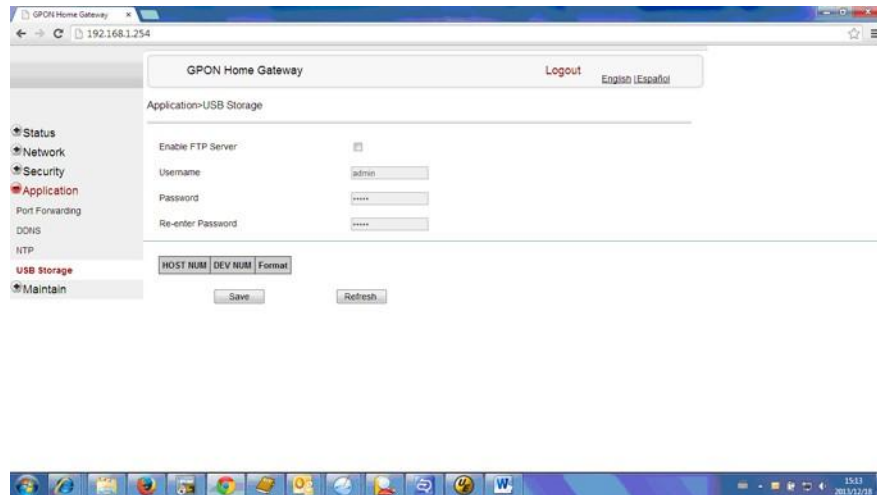

Table 4-22 describes the fields in the USB storage window.

Table 4-22 USB storage parameters

Field	Description
Enable FTP server	Select this checkbox to enable using an FTP server for data storage
Username	Username for FTP server
Password	Password for FTP server
Re-enter Password	Password for FTP server

- 2 Configure USB storage.
- 3 Click Save.
- 4 STOP. This procedure is complete.

Maintenance

G-240W-B ONT also supports maintenance tasks, including:

- password change
- SLID configuration
- device management
- backup and restore
- firmware upgrade
- device reboot
- restore factory defaults
- diagnose
- log

Procedure 4-24 Password configuration

- 1 Select Maintain > Password from the top-level menu in the GPON Home Gateway window, as shown in Figure 4-24.

Figure 4-24 Password window

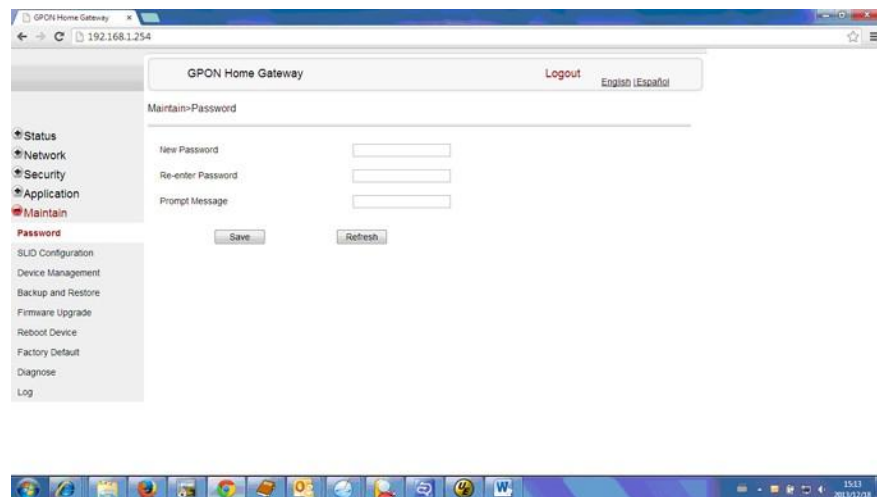

Table 4-23 describes the fields in the password window.

4 – Configure a G-240W-B indoor ONT

Table 4-23 Password parameters

Field	Description
New Password	New password
Re-enter password	Password must match password entered above
Prompt message	Password prompt message

- 2 Configure the new password.
- 3 Click Save.
- 4 STOP. This procedure is complete.

Procedure 4-25 SLID configuration

- 1 Select Maintain > SLID Configuration from the top-level menu in the GPON Home Gateway window, as shown in Figure 4-25.

Figure 4-25 SLID configuration window

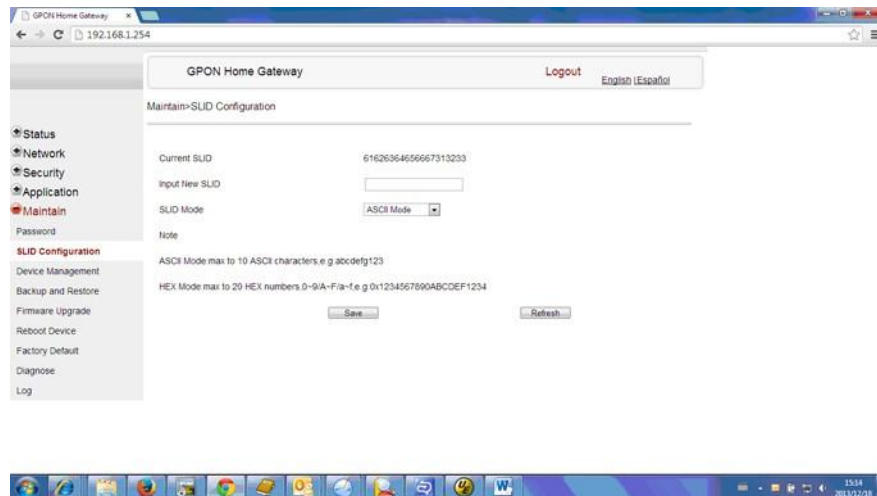

Table 4-24 describes the fields in the SLID configuration window.

Table 4-24 SLID configuration parameters

Field	Description
Current SLID	Displays current SLID
Input new SLID	Enter new SLID
SLID Mode	Choose a SLID mode from the drop-down menu.

- 2 Configure the new SLID.
- 3 Click Save.
- 4 STOP. This procedure is complete.

Procedure 4-26 Device management

- 1 Select Maintain > Device Management from the top-level menu in the GPON Home Gateway window, as shown in Figure 4-26.

Figure 4-26 Device management window

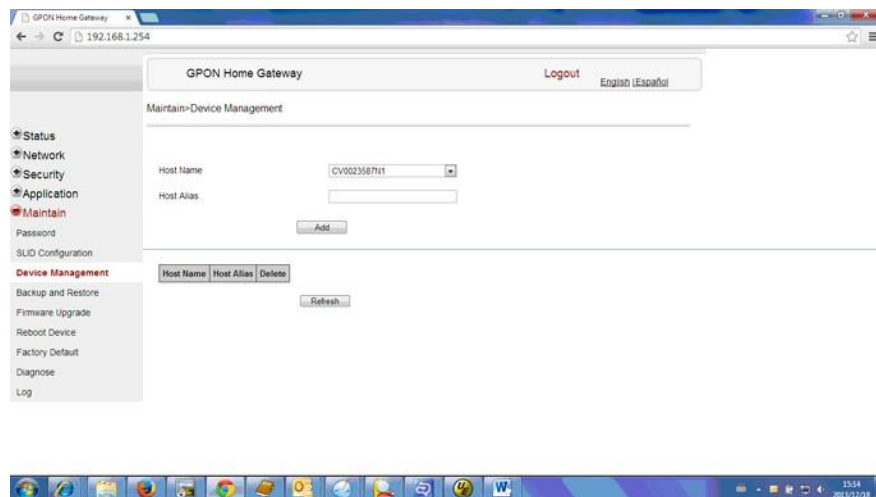

Table 4-25 describes the fields in the Device management window.

Table 4-25 Device management parameters

Field	Description
Host name	Choose a host from the drop-down menu
Alias	Enter an alias for the chosen host

- 2 Configure an alias for a specific host.
- 3 Click Add.
- 4 STOP. This procedure is complete.

4 – Configure a G-240W-B indoor ONT

Procedure 4-27 Backup and restore

- 1 Select Maintain > Backup and Restore from the top-level menu in the GPON Home Gateway window, as shown in Figure 4-27.

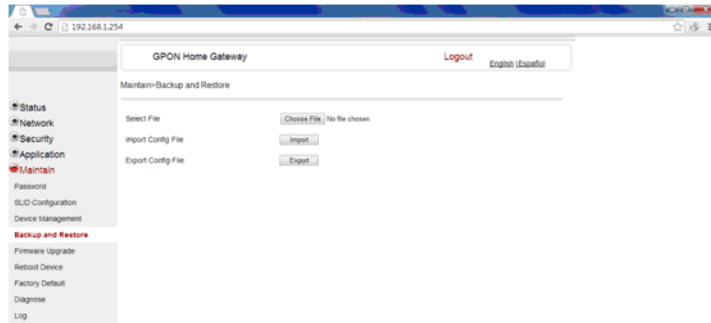
Figure 4-27 Backup and Restore window

- 2 Click Select File and choose the backup file.
- 3 Click Import Config File to restore the ONT to the saved backup or click Export Config File to export the current ONT configuration to the backup file.
- 4 STOP. This procedure is complete.

Procedure 4-28 Upgrade firmware

- 1 Select Maintain > Firmware Upgrade from the top-level menu in the GPON Home Gateway window, as shown in Figure 4-28.

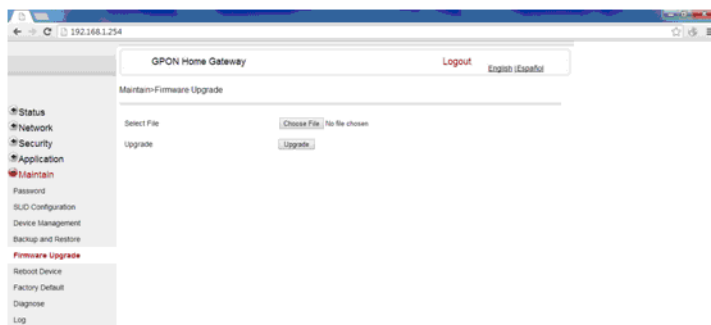
Figure 4-28 Firmware upgrade window

- 2 Click Select File and choose the firmware file.

- 3 Click Upgrade to upgrade the firmware.
 - 4 STOP. This procedure is complete.
-

Procedure 4-29 Reboot ONT

- 1 Select Maintain > Reboot Device from the top-level menu in the GPON Home Gateway window, as shown in Figure 4-29.

Figure 4-29 Reboot window

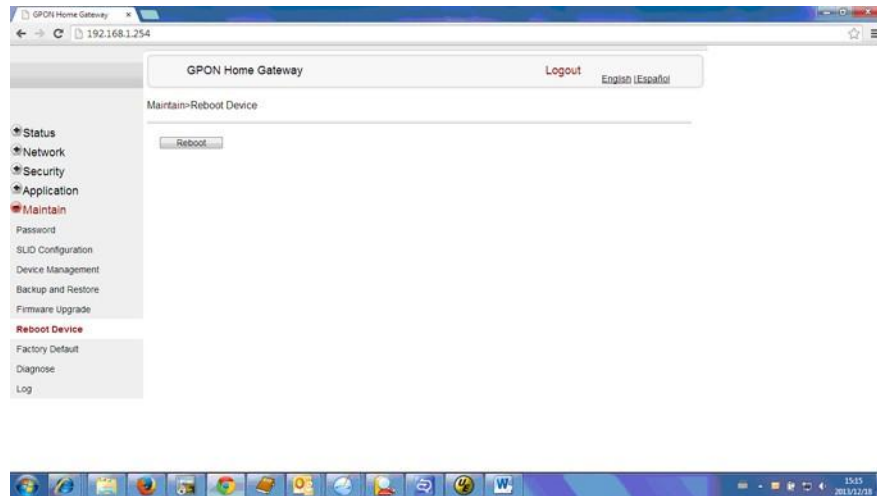

- 2 Click Reboot to reboot the ONT.
 - 3 STOP. This procedure is complete.
-

4 – Configure a G-240W-B indoor ONT

Procedure 4-30 Restore factory defaults

- 1 Select Maintain > Factory Default from the top-level menu in the GPON Home Gateway window, as shown in Figure 4-30.

Figure 4-30 Factory default window

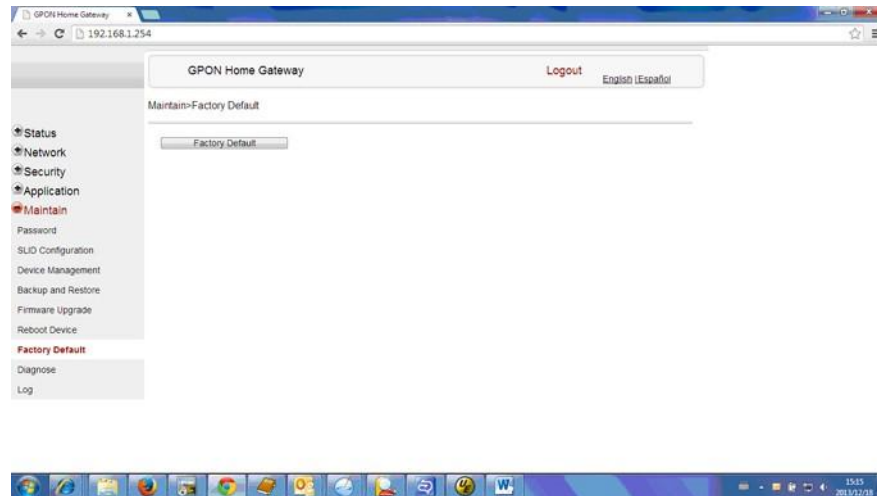

- 2 Click Factory Default to reset the ONT to its factory default settings.
 - 3 STOP. This procedure is complete.
-

Procedure 4-31 Diagnose connections

- 1 Select Maintain > Diagnose from the top-level menu in the GPON Home Gateway window, as shown in Figure 4-31.

Figure 4-31 Diagnose window

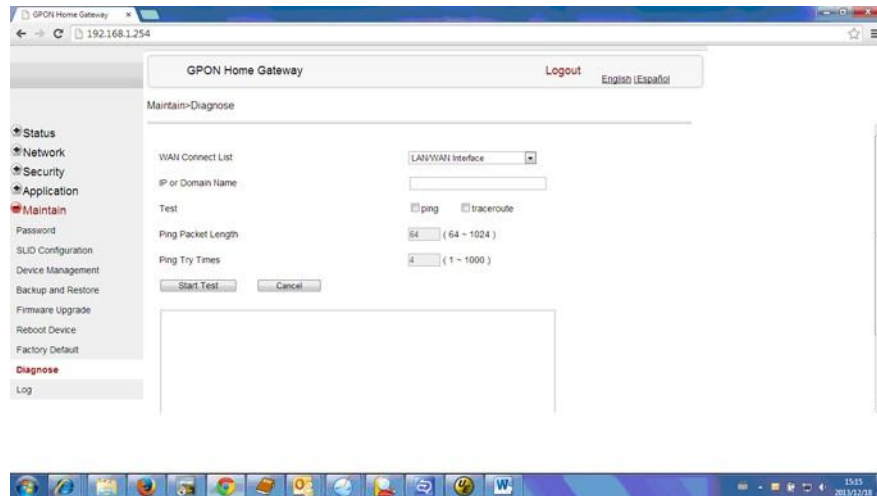

- 2 Choose a WAN connection to diagnose from the drop-down menu.
- 3 Enter the IP address or domain name.
- 4 Select the test type by selecting either ping or traceroute.
- 5 Enter a ping packet length (64-1024).
- 6 Enter the number of ping attempts to perform (1 - 1000).
- 7 Click Start Test. Results will be displayed at the bottom of the window.
- 8 STOP. This procedure is complete.

4 – Configure a G-240W-B indoor ONT

Procedure 4-32 View log files

- 1 Select Maintain > Log from the top-level menu in the GPON Home Gateway window, as shown in Figure 4-32.

Figure 4-32 Log window

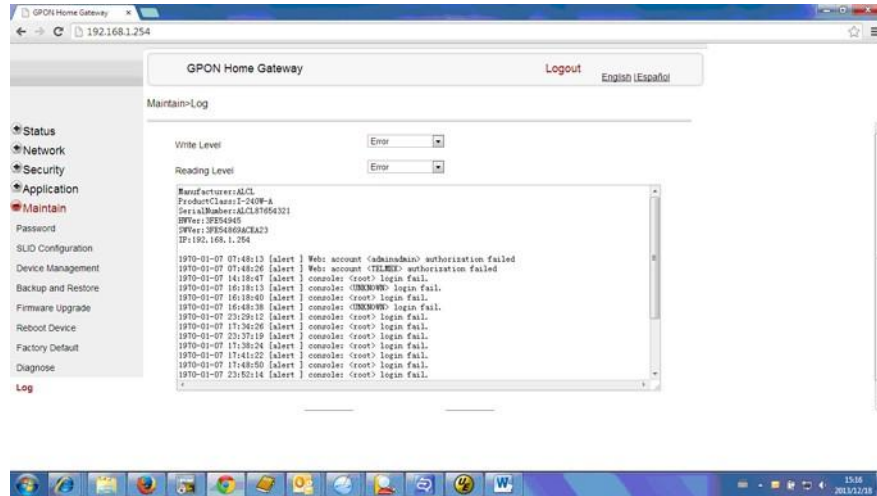

- 2 Choose a write level from the drop-down menu to determine which types of events are recorded in the log file:
 - Emergency
 - Alert
 - Critical
 - Error
 - Warning
 - Notice
 - Informational
 - Debug
- 3 Choose a reading level from the drop-down menu to determine which types of events to display from the log file:
 - Emergency
 - Alert
 - Critical
 - Error
 - Warning
 - Notice
 - Informational
 - Debug

- 4 The log file is displayed at the bottom of the window.
 - 5 STOP. This procedure is complete.
-

4.3 SFU mode GUI configuration

Use the procedures below to use the web-based GUI for the G-240W-B in SFU mode. This mode is preset at delivery.

SFU customer premise devices are designed for single indoor residential applications. These ONTs address the demand for bandwidth intensive services, such as high definition television (HDTV), video-on-demand (VOD) and online games. The ONT can be configured to seamlessly deliver voice-over-IP and high speed Internet access via a single fiber optic connection to the home.

Login

Use the procedure below to login to the web-based GUI for the G-240W-B.

Procedure 4-33 Login to web-based GUI

- 1 Open a web browser and enter the IP address of the ONT in the address bar.

The login window appears.

The default gateway IP address is `http://192.168.1.254`. You can connect to this IP address using your web browser after connecting your PC to one of Ethernet ports of the ONT. The static IP address of your PC must be in the same subnet as the ONT.

- 2 Enter your username and password in the Log in window, as shown in Figure 4-33.

The default username and password are printed on the ONT. The default superuser username is `adminGPON`. Contact Alcatel-Lucent for the superuser password.

4 – Configure a G-240W-B indoor ONT

Figure 4-33 Web login window



Caution — If you reset the router to recover the default username and password, all other router configuration settings will also be restored to their factory default values.

Si vous réinitialisez le routeur pour récupérer le nom d'utilisateur et mot de passe par défaut, tous les autres paramètres de configuration du routeur seront aussi restaurés à leurs valeurs par défaut d'usine.



Note — If you forget the current username and password, press the reset button for 5 s and the default values for the username and password will be recovered at startup.

Si vous oubliez le nom d'utilisateur et mot de passe actuel, appuyez sur le bouton de réinitialisation pendant 5 s et les valeurs par défaut pour le nom d'utilisateur et mot de passe sera récupéré au démarrage.

- 3 Click Login.
 - 4 STOP. This procedure is complete.
-

Device and connection status

G-240W-B ONTs support the retrieval of a variety of device information.

Procedure 4-34 Device information retrieval

- 1 Select Status > Device Information from the top-level menu in the GPON Home Gateway window, as shown in Figure 4-34.

Figure 4-34 Device Information window

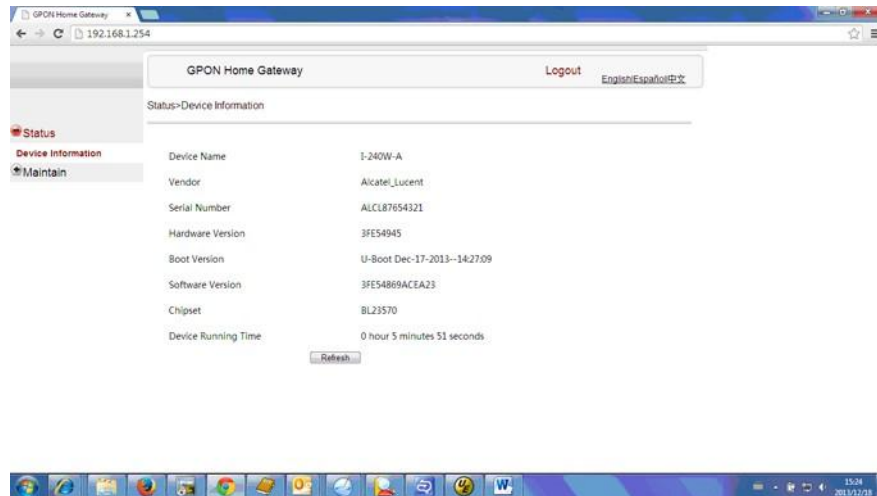

Table 4-26 describes the fields in the Device Information window.

Table 4-26 Device Information parameters

Field	Description
Device Name	Name on the ONT
Vendor	Name of the vendor
Serial Number	Serial number of the ONT
Hardware version	Hardware version of the ONT
Boot version	Boot version of the ONT
Software version	Software version of the ONT
Chipset	Chipset of the ONT
Device Running Time	Amount of time the device has run since last reset in hours, minutes, and seconds

- 2 Click Refresh to update the displayed information.
- 3 STOP. This procedure is complete.

4 – Configure a G-240W-B indoor ONT

Maintenance

G-240W-B ONT also supports maintenance tasks, including:

- password change
- LOID configuration
- SLID configuration

Procedure 4-35 Password configuration

- 1 Select Maintain > Password from the top-level menu in the GPON Home Gateway window, as shown in Figure 4-35.

Figure 4-35 Password window

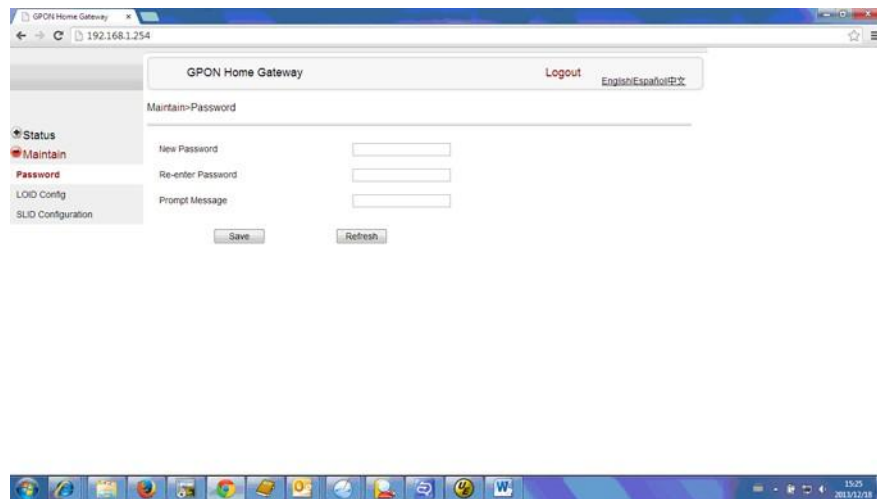

Table 4-27 describes the fields in the password window.

Table 4-27 Password parameters

Field	Description
New Password	New password
Re-enter password	Password must match password entered above
Prompt message	Password prompt message

- 2 Configure the new password.
- 3 Click Save.
- 4 STOP. This procedure is complete.

Procedure 4-36 LOID configuration

- 1 Select Maintain > LOID Config from the top-level menu in the GPON Home Gateway window, as shown in Figure 4-36.

Figure 4-36 LOID configuration window



- 2 Enter the LOID.
- 3 Enter the password, if applicable.
- 4 Click Save/Apply.
- 5 STOP. This procedure is complete.

4 – Configure a G-240W-B indoor ONT

Procedure 4-37 SLID configuration

- 1 Select Maintain > SLID Configuration from the top-level menu in the GPON Home Gateway window, as shown in Figure 4-37.

Figure 4-37 SLID configuration window

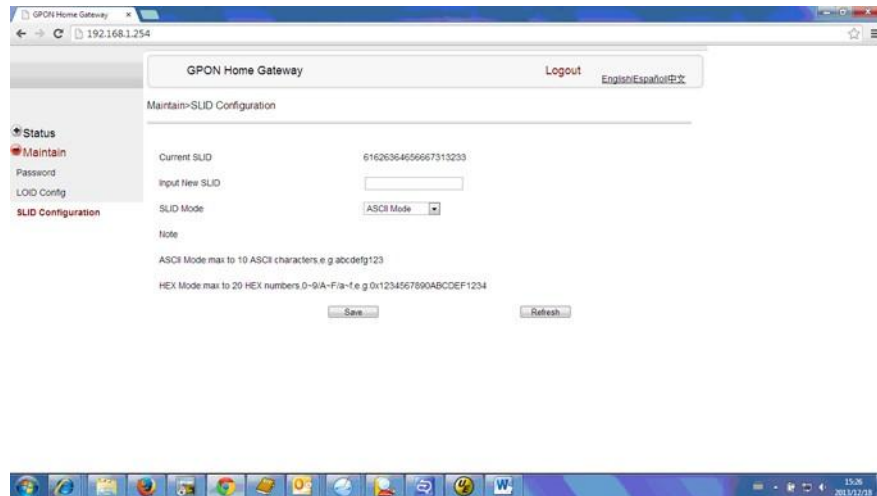

Table 4-28 describes the fields in the SLID configuration window.

Table 4-28 SLID configuration parameters

Field	Description
Current SLID	Displays current SLID
Input new SLID	Enter new SLID
SLID Mode	Choose a SLID mode from the drop-down menu.

- 2 Configure the new SLID.
- 3 Click Save.
- 4 STOP. This procedure is complete.

4.4 Operator ID

Use the procedure below to modify the operator ID for the G-240W-B.

Procedure 4-38 Modify the operator ID using OLT

- 1 Create a new .xml file named OntConfig.xml.
 - a For AONT releases AONTR2.4.02 and higher, add the following content to the OntConfig.xml file:

```
<OperatorObject version="1.0">
<OperatorObject="xxxx">
</OperatorObject>
```

where xxxx is the correct operator ID, such as PTXX.

- b For AONT releases prior to AONTR2.4.02, add the following content to the OntConfig.xml file:

```
<OpertaorObject version="1.0">
<OpertaorObject="xxxx">
</OpertaorObject>
```

where xxxx is the correct operator ID, such as PTXX.

- 2 Use a TFTP client tool to transfer OntConfig.xml to the OLT's ONT directory and change the filename to the software version number, for example, FE54869201410.xml.
- 3 Using TL1 commands, configure ONUSWCTRL:

```
ENT-ONTSWCTRL::1:::HWVER=hwver, VARNT=, PLNDSWVER=UNPLANNED,
PLNDSWVERCONF=UNPLANNED, DLDSWVER=swver;
```

where:

hwver is the hardware version number, for example 3FE54945ABBA.

swver is the software version number used as the filename in step 2, for example 3FE54869201410.

- 4 Download the .xml file to update the operator ID:

```
ED-ONT::ONT-1/1/3/1/19:::DLSW=AUTO;
```
 - 5 Restart the ONT, then connect to the LAN and access the web-based to check the operator ID default setting.
 - 6 Using TL1 commands, disable further downloads:

```
ED-ONT::ONT-1/1/3/1/19:::DLSW=DISABLED;
```
 - 7 STOP. This procedure is complete.
-

Customer documentation and product support

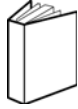

Customer documentation

<http://www.alcatel-lucent.com/myaccess>

Product manuals and documentation updates are available at [alcatel-lucent.com](http://www.alcatel-lucent.com). If you are a new user and require access to this service, please contact your Alcatel-Lucent sales representative.



Technical Support

<http://support.alcatel-lucent.com>



Documentation feedback

documentation.feedback@alcatel-lucent.com

