



CPE i 890  
Series



*User Manual*

# Contents

## **Chapter 1: Desktop CPE/ 890 User Guide**

Overview .....	1-1
Powerful Features in a Single Unit .....	1-2
Front of the CPE .....	1-2
Back of the CPE .....	1-3
Operating Information .....	1-3

## **Chapter 2: Installation**

Overview .....	2-1
Before you Begin .....	2-1
Easy Setup .....	2-1
Advanced Setup .....	2-2
Procedure to Log into the CPE .....	2-2
Setup Wizard and Authentication .....	2-3

## **Chapter 3: Basic Configuration**

Personalize Menu .....	3-1
Password Tab .....	3-2
Device Time Tab .....	3-2
Device Name Tab .....	3-2
Restore Factory Settings Tab .....	3-3
Internet Menu .....	3-3
WiMAX Security Tab .....	3-4
Firewall Tab .....	3-4
Dynamic DNS Tab .....	3-5
Status Menu .....	3-5
Telephony Menu .....	3-6
Wi-Fi .....	3-13
Wi-Fi Menu .....	3-13

## **Chapter 4: Advanced Configuration**

Port Forwarding Menu .....	4-1
Forwarding Tab .....	4-2
Local Address Menu .....	4-2
DHCP Server Tab .....	4-3
Lease Status Tab .....	4-4
Lease Reservation Tab .....	4-4
Control Panel .....	4-5
Software Tab .....	4-6

Certificate Tab .....	4-6
System Tab .....	4-6
About Tab .....	4-7
Wi-Fi Advanced .....	4-7
<b>Chapter 5: Configuring TCP/IP</b>	
Configuring TCP/IP in Windows XP .....	5-1
Configuring TCP/IP in Windows Vista .....	5-5
<b>Chapter 6: Troubleshooting</b>	
Power .....	6-1
A Computer Cannot Log On to the CPE .....	6-1
Cannot Connect to the Internet .....	6-1
Additional Troubleshooting Help .....	6-1
<b>Chapter 7: Important Safety and Legal Information</b> .....	7-1

# Chapter 1: Desktop CPE*i* 890 User Guide

## Overview

Thank you for purchasing the Motorola CPE Indoor CPE*i* 890 desktop device. The Desktop CPE*i* 890 allows you to connect to the wireless world easily and seamlessly without complicated installation and setup procedures. In addition, it offers you the ability to make Voice over Internet Protocol (VoIP) calls.

The Desktop CPE indoor CPE*i* 890 device provides the user:

- Convenience - with easy plug and play functionality. Compact design.
- Control - remote management capability allows easy detection and authentication once the unit is set up.
- VoIP - two RJ11 ports allow for Voice over IP calls using your CPE*i* 890.
- Wi-Fi - wireless LAN

The features and the physical appearance of your Desktop CPE*i* 890 device may differ slightly from the illustration.

**Figure 1-1:** CPE*i* 890



For the most recent documentation, visit the Product Documentation page on [www.motorola.com/wimaxmanuals](http://www.motorola.com/wimaxmanuals).

## Powerful Features in a Single Unit







The CPE device provides the following features:

- WiMAX Authentication
- WAN DHCP Client
- LAN DHCP Server
- Home Gateway Functions
- Firewall Protection
- Port Forwarding
- Wi-Fi

## Front of the CPE

The front of the CPE unit contains LED Link/Activity indicators. The LEDs show the status of the initialization during and network connections during power up. The LEDs also indicate the signal strength, and if Wi-Fi is enabled.

**Table 1-1** LED Indicator Interface

LED	Status
 (Wi-Fi)	Indicates if Wi-Fi is enabled or disabled. LED on, Wi-Fi is enabled.
 (Signal Strength)	Full WiMAX Signal Strength is detected when all WiMAX Signal Strength LEDs are lit. <ul style="list-style-type: none"> <li>• One to two WiMAX Signal Strength LEDs are lit - low signal detected.</li> <li>• Three to five WiMAX Signal Strength LEDs are lit - high signal detected.</li> </ul>
 (WiMAX Status)	While acquiring access to the WiMAX Network: <ul style="list-style-type: none"> <li>• All WiMAX Signal Strength LEDs vary between ON, OFF and/or BLINKING status.</li> </ul>
 (VoIP Status) 1/2	Indicates the status of the VoIP connection.
 (LAN Status) 1/2	Indicates the status of the Ethernet connection and activity
 (Power)	Indicates if the device is powered or not.



## Back of the CPE

The back of the CPE unit contains the RESET switch, WPS switch, DC Power Connector, Ethernet connector, Ethernet LED, Line 1 and Line 2 telephone ports.

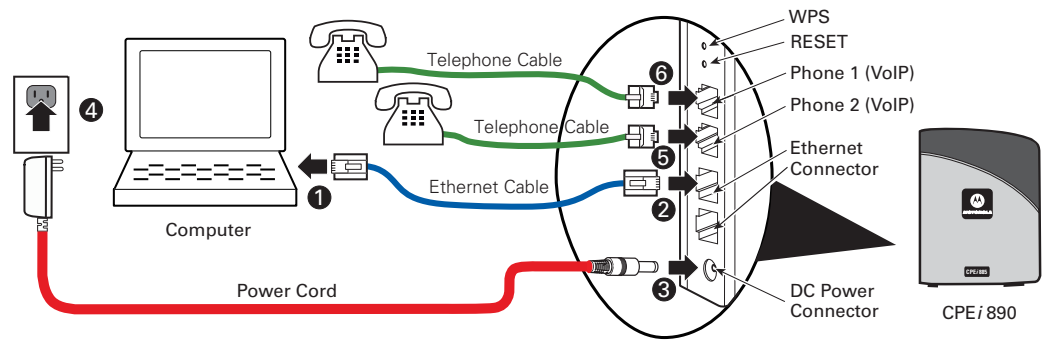
**Figure 1-2:** CPE Ports and Connections



**Table 1-2** Port Descriptions

Port	Port Description
 (Ethernet)	Ethernet Ports 1 and 2.
 (Power)	DC Power Connector.
 (Phone Line)	RJ-11 ports for use with VoIP.
Reset	Hardware Reset Button (A paperclip is recommended for accessing this button).
WPS	Wi-Fi protected setup button.

## Operating Information

Operating temperature for this unit is 0-40°C (32-104°F).

This page intentionally left blank.

# Chapter 2: Installation

## Overview

To install the Desktop CPE*i* 890 Series, review the following sections:

- Before You Begin
- Easy Setup

## Before you Begin

Before you begin installation, check that you have received the following items with your Desktop CPE*i* 890:

**Table 2-1** In the box with your CPE, you should have

Item	Description
AC Power Adapter	Power adapter cord connects the Desktop CPE to an AC electrical outlet.
Ethernet Cable	The Ethernet cable connects the Internet port on your Desktop CPE to your PC or laptop computer.
Desktop CPE <i>i</i> 890 Quick Start Guide	Desktop CPE <i>i</i> 890 Quick Start Guide

In addition, you need:

- A computer
- An RJ-11 telephone cable (optional). Two RJ-11 telephone cables are required if your service provider has supplied you with two telephone numbers.

## Easy Setup

The CPE is easily set up in your home. Basic installation equipment needed are the power adapter, Ethernet cable, a PC or laptop computer and the CPE device. If you want to use the VoIP functionality, you need an RJ-11 phone cable and a telephone.

Perform the following tasks before attaching the power cord or powering up the unit:

- Stand the CPE on a flat surface.
- Plug the AC power adapter cord into an AC outlet.
- Plug one end of the Ethernet cable into the Ethernet connector on the back of the unit.
- Plug the other end of the Ethernet cable into the Ethernet connector of your computer.
- To use VoIP functionality of the phone, plug one end of the phone line into the activated phone connector on the back of the unit. Phone line activation is dependent upon your service contract.
- Plug the other end of the phone line into the phone line connector of your telephone.



## Advanced Setup

The CPE can also be used to connect to a multi-port switch (hub) - purchased separately from the CPE. Connecting the CPE device to a hub allows you to connect more than one computer to your CPE device.

## Procedure to Log into the CPE

### Before you Begin Configuration

Some settings on your computer need to be verified or changed to ensure that your computer configuration can support the Desktop CPE.

Verify that the IP addresses and DNS settings are automatically generated in your Local Area connection of your Internet Protocol (TCP/IP) properties. Refer to the chapter titled "Configuring TCP/IP" for additional information.

### Logging in to the CPE

Use the following procedure to log into the Desktop CPE:

1. On a computer that is connected to the Desktop CPE, open a web browser.
2. In the Address or Location field, type **http://mywimax.** and press **ENTER** to display the login screen.  
Include the period (.) after http://mywimax. in order to access the login screen.

#### NOTE

Alternatively, you may enter the IP address: http://192.168.15.1 into the address field in order to gain access to your CPE. If you cannot access the CPE, refer to the chapter titled: Configuring TCP/IP for more information.

3. The Welcome to Motorola WiMAX CPE screen is displayed and prompts you for a password.

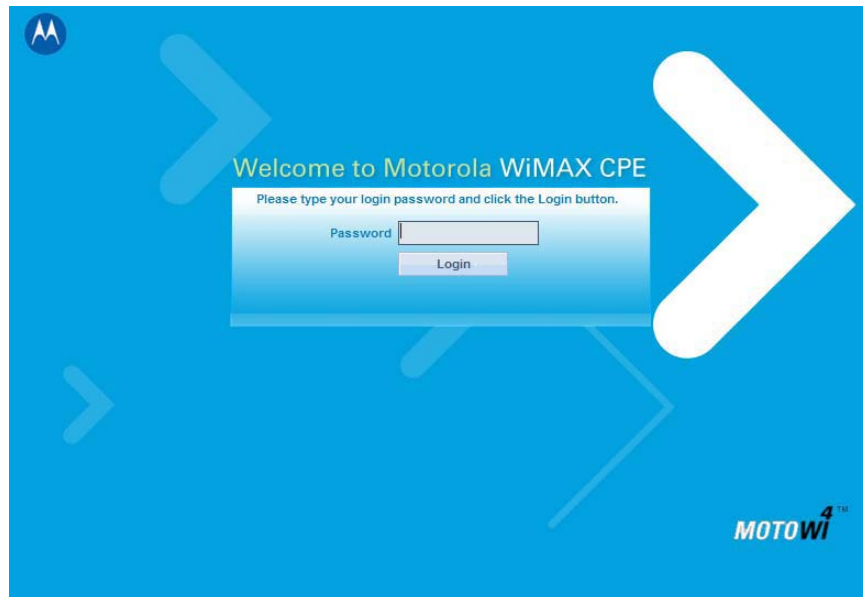
**Figure 2-1:** Login Screen

4. In the **Password** field, type the password (default is **motorola**).
5. Click **Login**.
6. First time users see a pop-up box that states: “The Wizard application will guide you through for the first time configuration”. Click **OK** button to continue.
7. Click the **OK** button to launch the wizard application.

## Setup Wizard and Authentication

### Step 1 - Change Password

Once you have launched the setup wizard, you are prompted to change your password. Motorola recommends using a password to protect your home network and CPE device. Passwords are case sensitive.

To change your password:

- Ensure the “Enable Login Password Protection” box is checked.
- Enter a New Login Password in the box. Passwords can be no more than 20 characters in length.
- Re-type your new password in the Confirm New Login Password box.
- Click **Next**.

If you forget your password, you can reset it back to the default (motorola) password. To reset the password, press and hold the reset button on the back of your CPE for 5 or more seconds. Before resetting the CPE, ensure that the power is ON.

### Step 2 - Device Time

This screen allows you to set the time zone and to enable Daylight Savings Time (when applicable) for your location.

- Select the appropriate time zone for your location from the drop-down box.

- Check the box that is called “Auto Adjust for Daylight Savings Time” if you live in a region that observes Daylight Savings Time. This box is checked by default.
- Click the **Next** button.

### Step 3 - WiMAX Security

The WiMAX Security tab contains your authentication method. Check with your service provider to determine if they require a user name and password for authentication purposes.

- If the Authentication Method is EAP-TLS, no User Name and Password are required. Enter the Realm information supplied by your service provider. Click the **Next** button.
- If the Authentication Method is EAP-TTLS/MS-CHAPv2, enter a User Name and Password, and Realm information supplied by your Service Provider. Once you have entered the User Name/Password/Realm information, click the **Next** button.
- If you are unsure of the Authentication Method, select EAP-TLS (which is the default) and click the **Next** button.

### Step 4 - Account

The Account tab allows you to manage Voice over IP (VoIP) related services. Please consult with your telephony service provider for these settings.

Click the **Apply** button when finished.

Congratulations! You have now completed the setup of your WiMAX connection.

Click **OK** on the Congratulations! dialog box.

A status screen appears that shows Network status and telephony status. The Network Status screen provides any status associated with your WiMAX Wireless Broadband connection. The Telephony Status screen provides status of your telephony service.

- The **Restart** button is used to restart the device. The restart button is available on every screen.
- The **Wizard** button starts the set-up wizard over again.
- The **Refresh** button refreshes the screen with the current status.
- The **Auto Refresh** button allows the web browser to automatically refresh at the interval determined in the Control Panel menu.

**Figure 2-2:** Status Screen

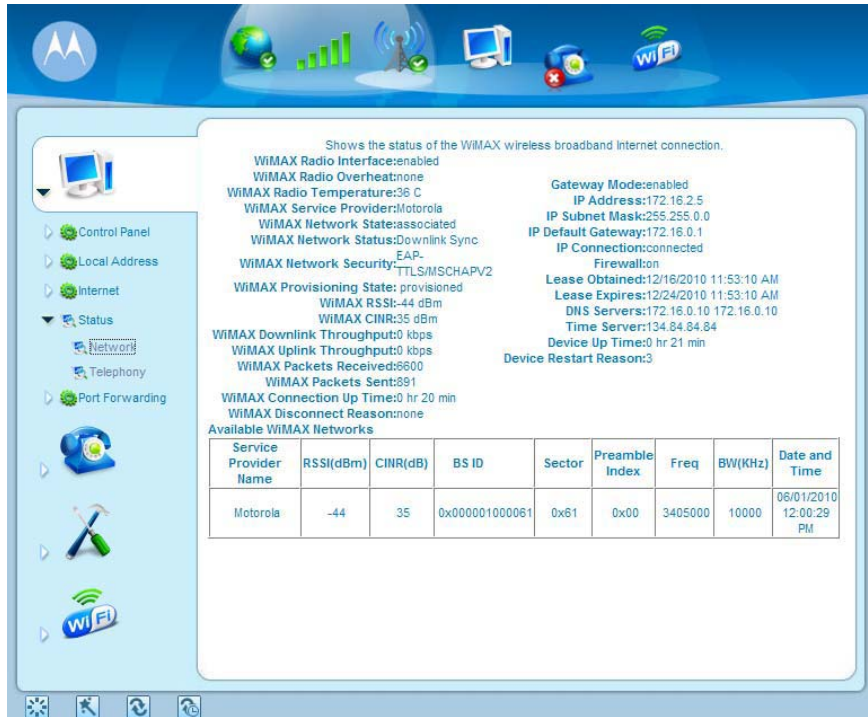

## Restart Button

**Figure 2-3:** Restart Button

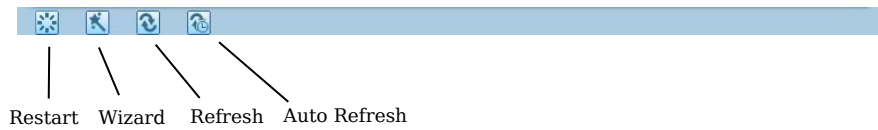

This page intentionally left blank.

## Chapter 3: Basic Configuration

Once the CPE setup has been completed, you can log in to your CPE from any computer on your home network. To log in type the device name in the address bar on your computer. The default device name is mywimax.

This section describes the PERSONALIZE, INTERNET, STATUS, and Wi-Fi basic Menus that are available.

### Personalize Menu

The Personalize menu provides the following tabs:

- Password
- Device Time
- Device Name
- Restore Factory Settings

**Figure 3-1:** Personalize Menu

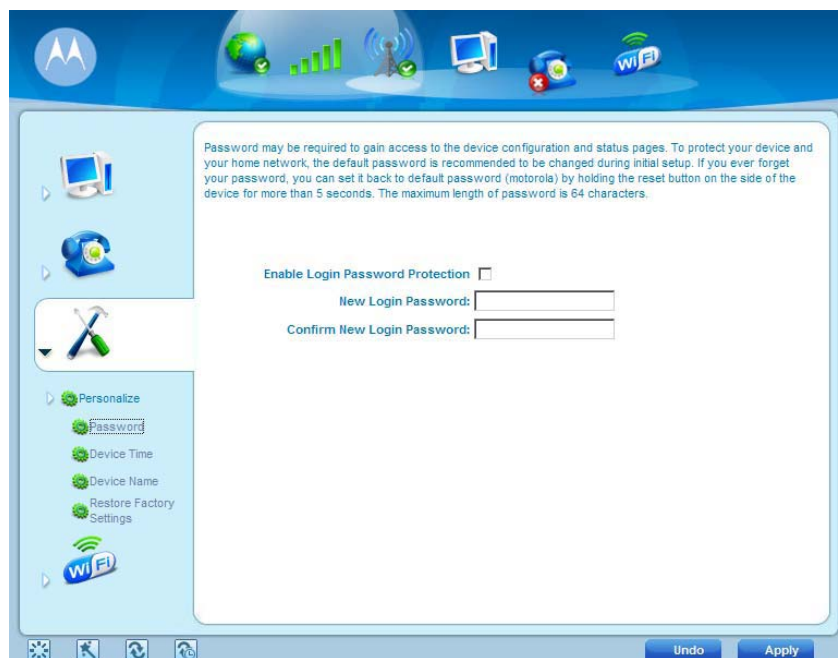

To Access the Personalize menu, click on the Tools symbol, then click on Personalize.

## Password Tab

The password tab allows you to enable/disable password protection. You can also change your password here. Be sure to click the **Apply** button when finished

**Table 3-1** Password Tab

Field or Button	Description
Enable Login Password Protection	Checking this box requires login password protection.
New Login Password	Enter your new password here. Maximum 20 characters. Passwords are case sensitive.
Confirm New Login Password	Re-enter your new password here, exactly as entered in the previous step.

## Device Time Tab

The Device Time tab allows you to establish the time zone for your location. It also allows you to automatically adjust for Daylight Savings Time if necessary. Be sure to click the **Apply** button when finished.

**Table 3-2** Device Time Tab

Field or Button	Description
Current Local Time	Current Local Time
Time Zone	Select your local time zone from the drop-down box.
Auto Adjust for Daylight Saving Time	Check this box if your location observes Daylight Savings Time. (Default is checked)

## Device Name Tab

The Device Name tab allows you to rename your CPE device. The Device Name is the name you enter on an internet browser address bar to access your CPE device. Be sure to click the **Apply** button when finished.

**Table 3-3** Device Name Tab

Field or Button	Description
New Device Name	Enter the new name for the CPE device. Maximum 20 characters.

## Restore Factory Settings Tab

The Restore Factory Settings Tab resets your CPE to the manufacturers default settings. Be sure to click the **Apply** button if you are sure that you want to reset factory settings.

**Table 3-4** Restore Factory Settings Tab

Field or Button	Description
Restore Factory Settings	Checking this box restores the CPE to factory default settings. The device restarts when you click <b>Apply</b> .

## Internet Menu

The Internet menu provides the following tabs:

- WiMAX Security
- Internet Protocol
- Firewall
- Dynamic DNS

**Figure 3-2:** Internet Menu

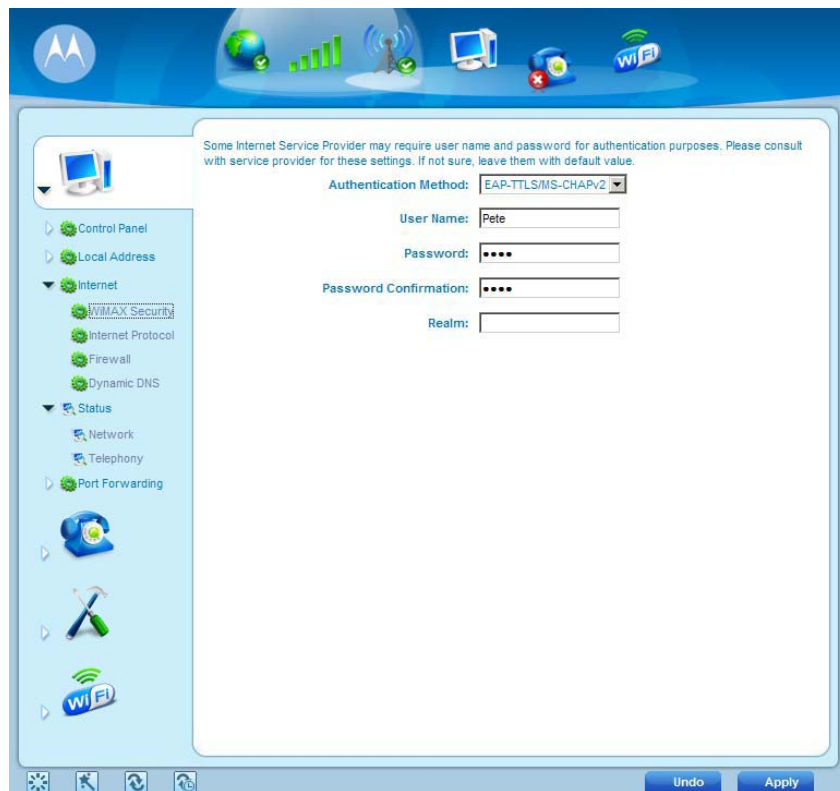

To access the Internet menu, click on the Computer icon, then click on Internet.



## WiMAX Security Tab

The WiMAX Security tab contains your authentication method. Check with your service provider to determine a user name and password are required for authentication purposes.

**Table 3-5** WiMAX Security Tab

Field or Button	Description
Authentication Method	Drop down box allows you to select either EAP-TLS (default) or EAP-TTLS/MS-CHAPv2.
User Name (EAP-TTLS/MS-CHAPv2 only)	Enter the User Name supplied by your service provider.
Password (EAP-TTLS/MS-CHAPv2 only)	Enter the Password supplied by your service provider.
Realm	Supplied by your service provider.

If your authentication method is EAP-TLS, then a User Name and Password are not necessary.

Click the **Apply** button.

## Internet Protocol Tab

Please check with your service provider for these settings. If you are unsure of the settings, leave the default values set and click the **Apply** button.

If your service provider has instructed you to change any of these settings, be sure to click the **Apply** button when you are finished.

## Firewall Tab

A firewall helps to protect your home network from unauthorized access. It also helps to manage authorized access from the internet to your CPE.

**Table 3-6** Firewall Tab

Field or Button	Description
Enable Firewall	Check this box to enable the firewall for your home network.
Enable Web Login from Internet	(Grayed out if Enable Firewall is not selected). Check this box to enables you to access your CPE device from a network other than your own.
Web Login Port from Internet	Choose a port number to connect to when logging in from a network other than your own. The default is 8080.

**Table 3-6** Firewall Tab

Field or Button	Description
Enable ping from Internet	Enables the CPE to respond to a ping from the Internet. This option would be enabled to allow testing only. Do not leave this enabled.

Be sure to click the **Apply** button once you are finished.

## Dynamic DNS Tab

Dynamic Domain Name Service (DDNS) allows a user with a non-static IP address to keep their domain name associated with an ever changing IP address. As an example, DDNS is used when you are hosting your own website.

**Table 3-7** Dynamic DNS Tab

Field or Button	Description
Enable DDNS	Check this box to Enable DDNS (default is unchecked).
DDNS Service Provider	Select DDNS Service Provider that you belong to from the drop-down box.
DDNS User Name	Only valid if Enable DDNS is checked. Enter your DDNS account user name.
DDNS Password	Only valid if Enable DDNS is checked. Enter your DDNS account password.
DDNS Host Name	Only valid if Enable DDNS is checked. Enter the DDNS Host Name. This is assigned by the DDNS service.

Be sure to click the **Apply** button once you are finished.

## Status Menu

The Status menu provides the following tabs:

- Network
- Telephony

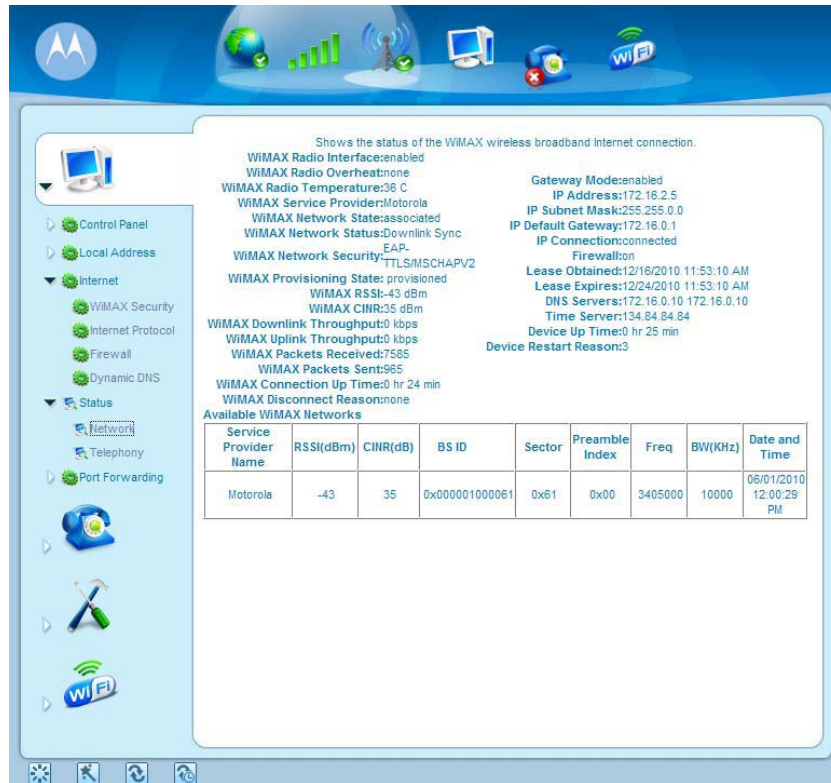
**Figure 3-3:** Status Menu

## Network Tab

The Network tab provides any status associated with your WiMAX Wireless Broadband connection.

## Telephony Tab

The Telephony tab provides any status associated with your telephony connection.

## Telephony Menu

The telephony menu allows you to manage your Voice over Internet Protocol (VoIP) services.

 **NOTE** Contact your service provider to obtain VoIP service, if you do not already have this service.

The Telephony menu provides the following tabs:

- Account
- Ring Tone
- Caller ID
- Call Forwarding
- Voice Mail
- Special Numbers

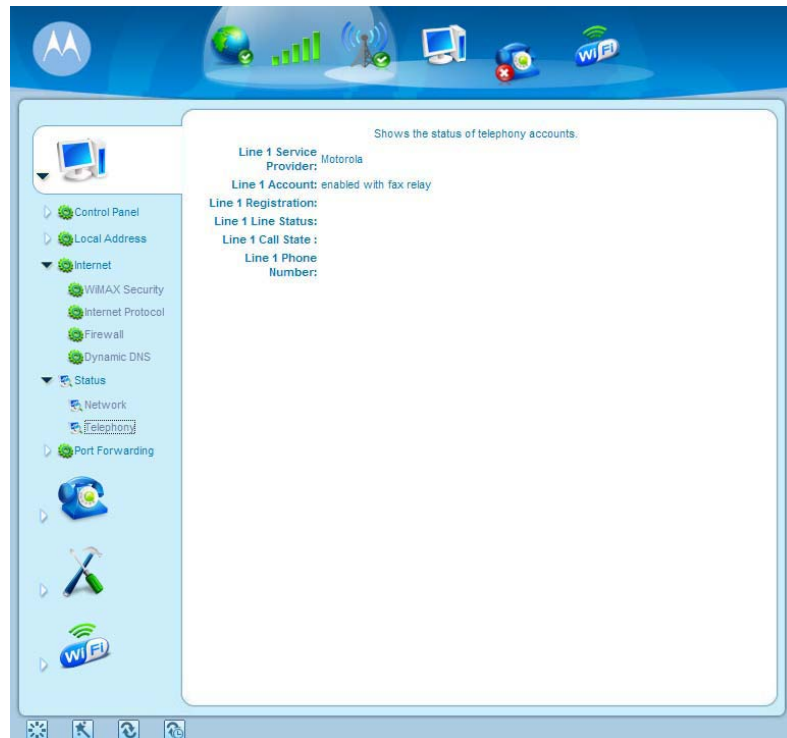
**Figure 3-4:** Telephony Menu

## Account Tab

Please consult with your service provider for these settings. The Account Tab contains the following settings:

**Table 3-8** Account Tab

Field or Button	Description
Line 1 User Name	If Line 1 is an active VoIP, enter the User Name as provided by your service provider.
Line 1 Password	Enter the Line 1 password as provided by your service provider. Passwords are case sensitive.
Confirm Line 1 Password	Reenter your Line 1 password exactly as entered in the field from the previous step.
Line 2 User Name	If Line 2 is an active VoIP, enter the User Name as provided by your service provider.
Line 2 Password	Enter the Line 2 password as provided by your service provider. Passwords are case sensitive.
Confirm Line 2 Password	Re-enter your Line 2 password exactly as entered in the field from the previous step.

Be sure to click the **Apply** button once you have made changes.

 **NOTE**

Support for the following VoIP features is dependent upon your service contract.

## Ring Tone Tab

The Ring Tone tab allows you to customize ring tones for your telephone(s).

 **NOTE**

You need a phone connected to your CPE to hear ring tones.

**Table 3-9** Ring Tone Tab

Field or Button	Description
Default Line 1 Ring Type	Use the drop-down box to select a ring tone for Line 1. The default is ringtone R0.
Test	Click to hear how the selected ring tone sounds.
Default Line 2 Ring Type	Use the drop-down box to select a ring tone for Line 2. The default is ringtone R0.
Test	Click to hear how the selected ring tone sounds.

Be sure to click the **Apply** button once you have made changes.

## Caller ID Tab

The Caller ID tab allows you to manage the Caller ID functions for your telephones:

**Table 3-10** Caller ID Tab

Field or Button	Description
Enable Line 1 Anonymous Incoming Call Rejection	If Line 1 is your active telephone port, check this box if you would like to reject telephone calls from anonymous incoming callers. The default is checked.
Enable Line 1 Permanent Anonymous Outgoing Call	If Line 1 is your active telephone port, check this box if you would like to permanently block your telephone number from appearing on others' Caller ID. The default is unchecked.
Enable Line 2 Anonymous Incoming Call Rejection	If Line 2 is your active telephone port, check this box if you would like to reject telephone calls from anonymous incoming callers. The default is checked.

**Table 3-10** Caller ID Tab

Field or Button	Description
Enable Line 2 Permanent Anonymous Outgoing Call	If Line 2 is your active telephone port, check this box if you would like to permanently block your telephone number from appearing on others' Caller ID. The default is unchecked.

Be sure to click the **Apply** button once you have made changes.

## Call Forwarding Tab

The Call Forwarding tab allows you to manage the call forwarding features for your telephone(s). The Call Forwarding tab contains the following:

**Table 3-11** Call Forwarding Tab

Field or Button	Description
Enable Line 1 Basic Forwarding	Check this box to enable basic call forwarding on Line 1. The default is unchecked.
Line 1 Basic Forwarding to Number	If "Enable Line 1 Basic Forwarding" is checked, enter the telephone number you would like to forward calls to.
Enable Line 1 Forwarding on No Answer	Check this box to forward calls received on Line 1 if there is no answer. This function is not available if "Enable Line 1 Basic Forwarding" is checked.
Line 1 No Answer Forwarding to Number	If "Line 1 No Answer Forwarding to Number" is checked, enter the telephone number you would like to forward calls to when there is no answer on Line 1. This function is not available if "Enable Line 1 Basic Forwarding" is checked.
Line 1 No Answer Forwarding Ring Count	Enter the number of rings allowed before the call forwards to the number identified above. The default is six rings.
Enable Line 1 Forwarding on Busy	Check this box to forward calls received while Line 1 is in use.
Line 1 Busy Forwarding To Number	If "Enable Line 1 Forwarding on Busy" is checked, enter the telephone number you would like calls forwarded to when Line 1 is in use.
Enable Line 2 Basic Forwarding	Check this box to enable basic call forwarding on Line 2. The default is unchecked.
Line 2 Basic Forwarding to Number	If "Enable Line 2 Basic Forwarding" is checked, enter the telephone number you would like to forward calls to.

**Table 3-11** Call Forwarding Tab

Field or Button	Description
Enable Line 2 Forwarding on No Answer	Check this box to forward calls received on Line 2 if there is no answer. This function is not available if "Enable Line 2 Basic Forwarding" is checked.
Line 2 No Answer Forwarding to Number	If "Line 2 No Answer Forwarding to Number" is checked, enter the telephone number you would like to forward calls to when there is no answer on Line 2. This function is not available if "Enable Line 2 Basic Forwarding" is checked.
Line 2 No Answer Forwarding Ring Count	Enter the number of rings allowed before the call forwards to the number identified above. The default is six rings.
Enable Line 2 Forwarding on Busy	Check this box to forward calls received while Line 2 is in use.
Line 2 Busy Forwarding To Number	If "Enable Line 2 Forwarding on Busy" is checked, enter the telephone number you would like calls forwarded to when Line 2 is in use.

Be sure to click the **Apply** button once you have made changes.

## Voice Mail Tab

The voice mail tab allows you to see the status of your voice mail.

Please contact your service provider to activate the voice mail feature if it is not already active. The Voice Mail Tab contains the following:

**Table 3-12** Voice Mail Tab

Field or Button	Description
Line 1 Server Based Voice Mail Status	Shows the status of Line 1 voice mail as either enabled or disabled.
Line 1 Number of New Voice Mails	Shows the number of new, unheard voice mails on Line 1.
Line 1 Number of Old Voice Mails	Shows the number of previously heard voice mails on Line 1.
Line 2 Server Based Voice Mail Status	Shows the status of Line 2 voice mail as either enabled or disabled.
Line 2 Number of New Voice Mails	Shows the number of new, unheard voice mails on Line 2.
Line 2 Number of Old Voice Mails	Shows the number of previously heard voice mails on Line 2.

Be sure to click the **Apply** button once you have made changes.

## Special Number Tab

The Special Number tab provides a list of special dialing numbers for your VoIP Phone Service. The Special Number Tab contains the following:

**Table 3-13** Special Number Tab

Field or Button	Description
Service Provider Contact Number	Use this number to contact customer service for your service provider.
Emergency Number	Dial this number to reach local emergency services.
Redial	Dial this number to redial the last number called.
Blind Call Transfer	Dial this number to transfer a call directly to a third party.
Consultation Call Transfer	Dial this number to speak with the third party before you transfer the call to them.
Call Hold	Dial this number to place your current call on hold.
Automatic Recall Activate	Dial this number to call back the number of the last incoming call.
Automatic Recall Deactivate	Dial this number to automatically call back the last number dialed when that number becomes available.
Call Forwarding Activate	Dial this number to forward your calls to a different number.
Call Forwarding Deactivate	Dial this number to deactivate call forwarding.
Call Forwarding Busy Activate	Dial this number to forward calls to a different number when the line is busy.
Call Forwarding Busy Deactivate	Dial this number to de-activate calls from forwarding to a different number when the line is busy.
Call Forwarding Busy Change Number	Dial this number to change the phone number to which calls will be forwarded when the line is busy.
Call Forwarding No Answer Activate	Dial this number to forward calls to a different number when there is no answer on Line 1 or Line 2.
Call Forwarding No Answer Deactivate	Dial this number to de-activate calls from forwarding to a different number when there is no answer on Line 1 or Line 2.
Call Forwarding No Answer Change Number	Dial this number to change the phone number to which calls will be forwarded when there is no answer on Line 1 or Line 2.



**Table 3-13** Special Number Tab

<b>Field or Button</b>	<b>Description</b>
Automatic Callback Activate	Dial this number to hear the most recent call you missed and to return the call. If the number is busy, you can hang up. When the number is available, your phone will ring. Pick up your phone and the call will be connected.
Automatic Callback Deactivate	Dial this number to de-activate automatic callback.
Do Not Disturb Activate	Dial this number to have calls automatically routed to voice mail.
Do Not Disturb Deactivate	Dial this number to cancel automatic call routing to voice mail.
Calling Number Delivery Blocking	Dial this number to block your number from appearing on the Caller ID of the people you call. Your calls may appear as Private or Anonymous.
Line Blocking Deactivate	Dial this number to unblock your telephone number from appearing on Caller ID.
Call Waiting Toggle	Dial this number to toggle between call waiting ON and call waiting OFF.
Anonymous Call Rejection Activate	Dial this number to have anonymous calls rejected.
Anonymous Call Rejection Deactivate	Dial this number to allow anonymous calls to go through.

## Wi-Fi

The Wi-Fi basic menu helps manage the Wi-Fi related configurations. This menu includes Basic, and Security menus. For the Advanced settings, refer to the Advanced Configuration chapter “Wi-Fi Advanced” on page 4 - 7.

**Figure 3-5:** Wi-Fi Basic Menu

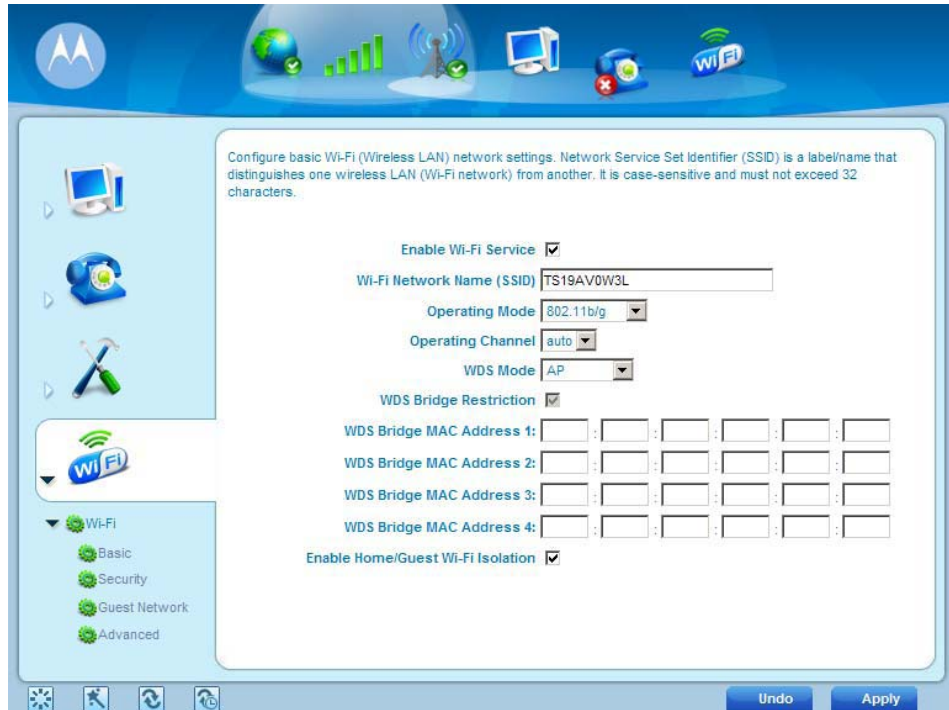

## Wi-Fi Menu

Wi-Fi Basic (Wireless LAN) network settings are configured at this menu which includes:

**Table 3-14** Wi-Fi Basic

Field or Button	Description
Enable Wi-Fi Wireless Service	Enable Wi-Fi service of the device by clicking the box to place a check mark. This function is disabled by clicking the box to remove the check mark.
Wi-Fi Network SSID	Network Service Set Identifier (SSID) is a label/name that distinguishes one wireless LAN (Wi-Fi network) from another. The field is case-sensitive and must not exceed 32 characters. For added security, changing the default SSID (Wi-Fi) to a unique name is recommended.

To access the Wi-Fi menu, click on the Wi-Fi icon, then click on Wi-Fi.

**Table 3-14** Wi-Fi Basic

Field or Button	Description
Operating Mode	<p>A pull-down list with the choices of:</p> <ul style="list-style-type: none"> <li>• 802.11b only (default)</li> <li>• 802.11g only</li> <li>• 802.11b/g</li> <li>• 802.11n</li> </ul> <p>Select 802.11 b/g to set the device to operate the Wi-Fi network with both 802.11b and 802.11g wireless devices.</p>
Operating Channels	<p>A pull-down list with choices from one to fourteen (1 through 14) depending upon the country/region setting. The default range is one to eleven (1 through 11). The default channel is six (6).</p> <p>The Wi-Fi operating mode channel settings can be modified if there are problems with nearby wireless devices.</p> <p>The operating channel selection is as follows:</p> <ul style="list-style-type: none"> <li>• 1 - 11: United States, Canada, and other</li> <li>• 1 - 13: Europe, Australia, Venezuela</li> <li>• 1 - 14: Japan (channels 1 - 14 if selecting 802.11b, channels 1 - 13 if 802.11b/g or 802.11g is selected)</li> <li>• 3 - 9: Israel</li> </ul>

## Wi-Fi Security

The Wi-Fi Security menu enables you to choose the wireless LAN security protocol to enable authentication and secure data transmission on the Wi-Fi network.

### NOTE

- Make sure the selected network security protocol is supported by the wireless devices on the network.
- Wi-Fi security is disabled by default. Use this Wi-Fi Security menu to manually enable Wi-Fi security.

## WEP Configuration

**Table 3-15** WEP Configuration

Field or Button	Description
Authentication Type	<p>A pull-down list with choices of:</p> <ul style="list-style-type: none"> <li>• Automatic</li> <li>• Shared</li> <li>• Open</li> </ul> <p>The default is Automatic. Two methods of authentication can be used with WEP: Open System authentication and Shared Key authentication. Choose Automatic to allow the device to automatically switch to the WEP authentication type used by the wireless device entering the network.</p>
Encryption Strength	<p>A pull-down list with choices of 64-bits Key and 128-bits Key. The default is 64-bits Key. Data transmission on the Wireless LAN is encrypted when WEP is enabled. Data encryption key is either 64bits or 128 bits.</p>
Passphrase	<p>Choices for the passphrase are:</p> <ul style="list-style-type: none"> <li>• Key Index - pull down menu lets you choose the type of key generation.</li> <li>• Automatic Key Generation - this feature generates 4 keys where one can be chosen to for use as the network security passphrase. Click the <b>Generate Key</b> button.</li> </ul> <p>If a 64-bit encryption key is used, enter 10 hexadecimal digits (any combination of 0-9, a-f, or A-F). 128-bit WEP encryption key, enter 26 hexadecimal digits (any combination of 0-9, a-f, A-F).</p>

## WPA/WPA2 Configuration

Manage WPA/WPA2 security protocol settings. Underneath WPA/WPA2 Configuration.

**Table 3-16** WPA/WPA2 Menu Selections

Field or Button	Description
Group Key Renewal	<p>This setting determines how often the group key is going to change. The group key renewal interval range is 300 to 7200. Default setting is 3600 seconds.</p>
Security Type	<p>Authentication keys can be generated either automatically or entered manually. The types of authentication selections are:</p> <ul style="list-style-type: none"> <li>• Remote (Radius) - Radius Server IP address where the field is broken into 4 sub-fields with each limited to 3 digits and the default is empty.</li> <li>• Shared (local) - a preshared key that includes the PSK passphrase where the default is an empty field.</li> </ul>

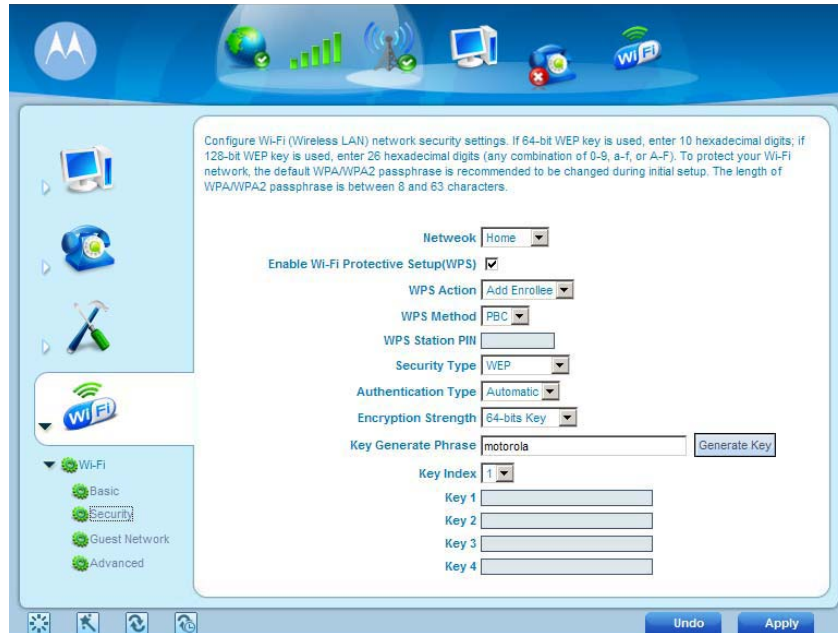
**Figure 3-5: Wi-Fi Security**

## Wi-Fi Protected Setup (WPS)

Your CPEi 890 supports Wi-Fi Protected Setup (WPS) to simplify the setup of your wireless security. WPS can be used to configure client devices such as wireless adapters in laptop computers that support WPS. If your client devices do not support WPS, you will have to manually configure those devices. In order to use WPS to set up your client devices, access the security section of the Wi-Fi configuration by clicking on the Wi-Fi icon, then clicking on Security. Before you begin, you should configure the security settings in the CPEi 890 as described in the section above before continuing.

**NOTE** If you have client devices that do not support Wi-Fi Protected Setup, note the wireless settings, and then manually configure those client devices.

There are two primary options available when utilizing WPS. Use the option below that applies to the client device you are configuring. NOTE: WPS configures one client device at a time. Repeat the procedure for each client device that supports WPS.

### Option #1, Push Button Control (PBC)

Use this method if your client device has a WPS button. Note that the button may be a physical button located on the client device or a software button located on the client device setup screen.

- There are two options available with the PBC method on the CPEi 890, hardware button and software button.
- Hardware button PBC on the CPEi 890
  - Locate the WPS button on the back of the CPEi 890 and client device.

**NOTE** Note that the button may be a physical button located on the client device or a software button located on the device setup screen.

- Press the WPS button on the back of the CPE*i* 890.
- Press the WPS button on the client device.
- The connection will be automatically established.
- Software button PBC on the CPE*i* 890
  - Navigate to the Security page of the Wi-Fi section of the CPE*i* 890 GUI as detailed above.
  - Select “PBC” at the WPS Method dialog box and select “Apply”.
  - Press the WPS button on the client device.
  - The connection will be automatically established.

### **Option #2, Personal Identification Number (PIN)**

Use this method if your client device has a WPS PIN number.

- Initiate the WPS PIN procedure on the client device per the manufacturer’s instructions.
- Navigate to the Security page of the Wi-Fi section of the CPE*i* 890 GUI as detailed above.
- Make sure the “PIN” option is selected in the WPS Method dialog box in the Wi-Fi Security Screen.
- Enter the PIN number of the client device in the field on this screen.
- Click “Apply” on the CPE*i* 890 GUI screen. This must be completed within 2 minutes of starting the procedure on the client device.
- The connection will be automatically established.

This page intentionally left blank.

# Chapter 4: Advanced Configuration

The Advanced Configuration section describes the Port Forwarding, Local Address, and Control Panel menus.

## Port Forwarding Menu

Port forwarding enables you to direct incoming traffic to specific LAN hosts (computers on your network) based on the protocol and port number. It is used to play Internet games or provide local services (such as web hosting) for a LAN group. To access the Port Forwarding menu, click on the Computer icon, then click on Port Forwarding. The Port Forwarding menu provides the following tabs:

- Basic
- Forwarding

**Figure 4-1:** Port Forwarding

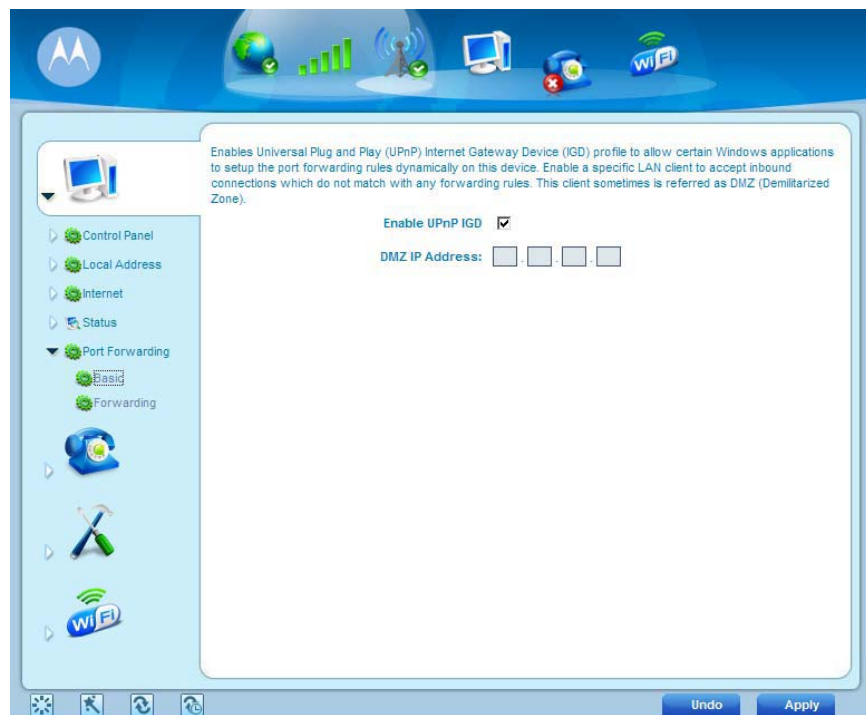

**Table 4-1** Port Forwarding Menu

Field or Button	Description
Enable UPnP IGD	Enables the Universal Plug and Play (UPnP) Internet Gateway Device (IGD) profile to allow certain Windows applications to set up the port forwarding rule dynamically when NAT is enabled on this device.
DMZ (DeMilitarized Zone) IP Address	Enter the DMZ IP Address.

Be sure to click the **Apply** button once you have made changes.



## Forwarding Tab

Click the **ADD** button to create additional Port Forwarding rules. The Forwarding tab contains the following selections:

**Table 4-2** Forwarding Tab

Field or Button	Description
Select	Select a box when you want to delete the specific row.
Protocol	Select TCP (Transmission Control Protocol) or UDP (User Datagram Protocol).
WAN Port Start	Enter the beginning port range for external network access.
WAN Port End	Enter the ending port range for external network access.
LAN IP Address	Enter the IP address to host the service.
LAN Port Start	Enter the beginning port range for internal network access.
LAN Port End	Enter the ending port range for internal network access.
Enabled	Check to enable specific port forwarding.

Be sure to click the **Apply** button once you have made changes.

## Local Address Menu

The Local Address menu allows you to configure your Local Area Network (LAN) connections.

The Local Address menu provides the following tabs:

- DHCP Server
- Lease Status
- Lease Reservation

To access the Local Address menu, click on the Computer icon, then click on the Local Address.

**Figure 4-2:** Local Address Menu

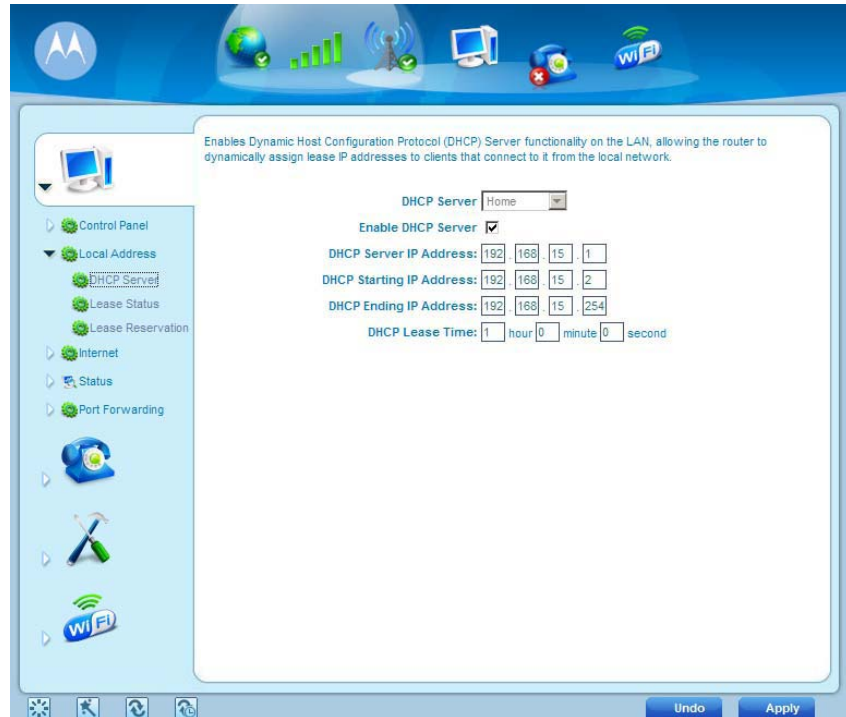

## DHCP Server Tab

The DHCP Server tab enables Dynamic Host Configuration Protocol (DHCP) server functionality on the LAN, allowing the router to dynamically assign lease IP addresses to clients that connect to it from the local network. The DHCP Server Tab contains the following selections:

**Table 4-3** DHCP Server Tab

Field or Button	Description
Enable DHCP Server	If selected, the DHCP server on the gateway assigns IP addresses to the computers and other hosts on your network if they have DHCP enabled. By default, the gateway server is enabled. If there is another DHCP server running on your network (on another router), disable one of the DHCP servers.
DHCP Server IP Address	Enter the default port forwarding LAN Client IP Address.
DHCP Starting IP Address	Sets the first IP address assigned by the DHCP server, in dotted-decimal format. It must be greater than the IP address value of the gateway. For example, if the IP address of the gateway is 192.168.15.1 (default), the starting IP address must be 192.168.15.2 (or higher).

**Table 4-3** DHCP Server Tab

Field or Button	Description
DHCP Ending IP Address	Sets the final IP address assigned by the DHCP server. If the DHCP server runs out of DHCP addresses, users cannot access network resources. If this happens, increase the Ending IP or reduce the Lease Time.
DHCP Lease Time	Sets the time, in seconds, that a network computer remains connected to the gateway using its current assigned IP address. At the end of this time, the DHCP server renews the lease or assigns the computer a new IP address. The default is 3600 seconds (one hour). The maximum is 999999 seconds (about 278 hours).

Be sure to click the **Apply** button once you have made changes.

## Lease Status Tab

The Lease Status tab in the Local Address menu displays the active DHCP leases since the last reboot. The Lease Status Tab contains the following selections:

**Table 4-4** Lease Status Tab

Field or Button	Description
Client Host Name	Displays the client host name. The Name field is limited to 20 characters (only 5 appear in display).
MAC Address	Media Access Control (MAC) address.
IP Address	Shows the IP Address for each active lease.
Remaining Lease Duration	Shows the amount of time, in seconds, remaining in the lease.

Be sure to click the **Apply** button once you have made changes.

## Lease Reservation Tab

This tab allows you to manage the lease reservation so that the same client receives the same IP address each time. The Lease Reservation Tab contains the following selections:

**Table 4-5** Lease Reservation Tab

Field or Button	Description
Select	Select this box if you want to delete an established lease reservation. Be sure to click the <b>Delete</b> button once you have selected the exception to be deleted.
Client Host Name	Enter the client host name. The Name field is limited to 20 characters (only 5 appear in display)
MAC Address	Media Access Control (MAC) address. Enter the MAC address of the device.
IP Address	Enter the IP address that you want assigned to the MAC Address.
Enabled	Clicking this box enables the lease reservation.

Be sure to click the **Apply** button once you have made changes.

## Control Panel

The Control Panel sections allows you to view/update your software information.

The Control menu provides the following tabs:

- Software
- Certificate
- System
- About

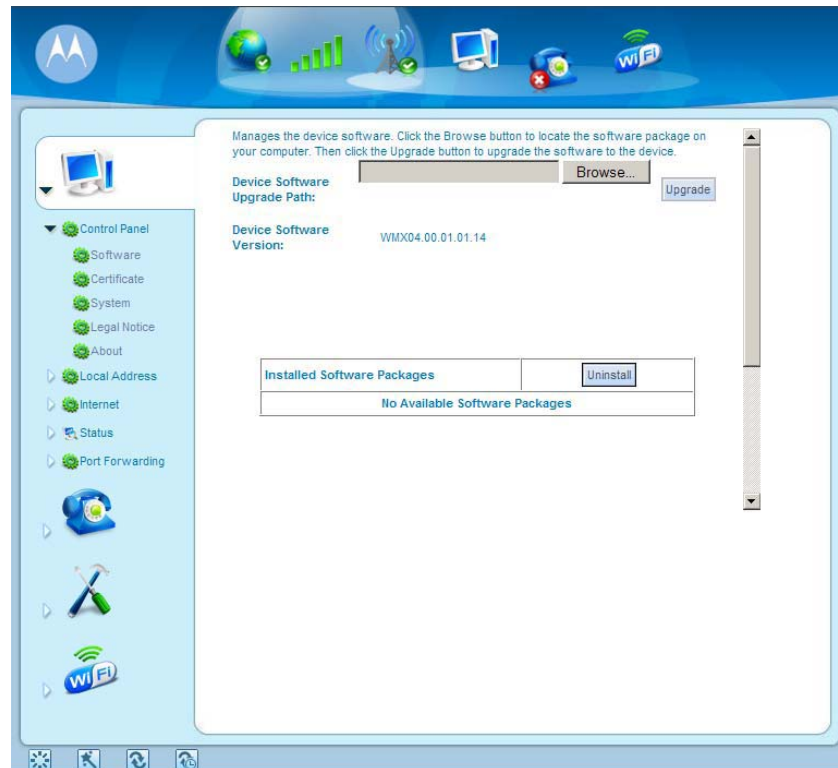
**Figure 4-3:** Control Panel Menu

## Software Tab

The Software tab manages the software on your CPE device. It is also where you can upgrade device software.

Use the **BROWSE** button to browse your computer for additional software packages. Once you have located the software package/update you would like to add to your device, click the **Upgrade** button.

Select the software you would like to install and click the **Install** button.

If you would like to remove software, select the software package you would like to remove and click **Uninstall**.

## Certificate Tab

The Certificate tab is where you view the certificates that are stored on the device.

## System Tab

This tab allows you to manage additional features of your CPE device.

**Table 4-6** System Tab

Field or Button	Description
Language Used in User Interface	Select the desired language for the user interface. The default language is English.
Enable WiMAX Radio Interface	Check this box to enable the WiMAX Radio Interface.
Auto Refresh Interval	Enter, in seconds, the interval for status Auto Refresh. Valid range is 2 seconds - 9999 seconds. The default value is 3 seconds.
Background	Select the desired background color for the user interface.

## About Tab

The About Tab displays basic properties of your CPE device such as: Product Name, Model ID, Hardware Version, Serial Number, and the WiMAX MAC Address.

## Wi-Fi Advanced

The Wi-Fi Advanced menu provides the following field settings:

**Table 4-7** Wi-Fi Advanced Menu

Field or Button	Description
Enable SSID broadcast	Check the box to disable the SSID of your wireless LAN network to be broadcast by the device. The wireless client on the wireless LAN will have to know the SSID of the device in order to connect to the network if this option is checked.
Transmit Rate	Select the basic transfer rates based on the speed of wireless device on the wireless LAN. It is strongly recommended to keep this setting to Auto.
Transmit Power	Set the transmit power level of the Wi-Fi radio. Available options are low, medium and high.

**Table 4-7** Wi-Fi Advanced Menu

Field or Button	Description
Beacon Interval	Enter a value between 1 and 65,535 milliseconds. The Beacon Interval value indicates the frequency interval of the beacon. A beacon is a packet broadcast by the device to synchronize the other wireless network.
RTS Threshold	This value should remain at its default setting of 2347. The range is 0-2347 bytes. Should you encounter inconsistent data flow, only minor modifications are recommended. If a network packet is smaller than the preset RTS threshold size, the RTS/CTS mechanism will not be enabled. The device sends Request to Send (RTS) frames to a particular receiving wireless client on the network and negotiates the sending of a data frame. After receiving an RTS, the wireless client responds with a Clear to Send (CTS) frame to acknowledge the right to begin transmission.
Preamble Type	The Preamble defines the length of the CRC block (Cyclic Redundancy Check is a common technique for detecting data transmission errors) for communication between the wireless router and the roaming wireless network adapters. Note: High network traffic areas should use the shorter preamble type.
Fragmentation Threshold	The range is 256-2346 bytes. It specifies the maximum size for a packet before data is fragmented into multiple packets. If you experience a high packet error rate, you may slightly increase the Fragmentation Threshold. Setting the Fragmentation Threshold too low may result in poor network performance. Only minor modifications of this value are recommended.
DTIM Interval	The default value is 3. This value, between 1 and 255 milliseconds, indicates the interval of the Delivery Traffic Indication Message (DTIM). A DTIM field is a countdown field informing clients of the next window for listening to broadcast and multicast messages. When the router has buffered broadcast or multicast messages for associated clients, it sends the next DTIM with a DTIM Interval value. Its clients hear the beacons and awaken to receive the broadcast and multicast messages.
CTS Protection Mode	CTS (Clear To Send) is a function used to minimize collisions among wireless devices on a wireless LAN. CTS will make sure the wireless network is clear before a wireless client attempts to send wireless data. Enabling CTS will add overhead and may lower wireless throughput. None: CTS is typically used in a pure 802.11g environment. If CTS is set to "Disable" in a mixed mode environment populated by 802.11b clients, wireless collisions may occur frequently. If set to <b>Enable</b> , CTS will always be used to make sure the wireless LAN is clear before sending data. If set to <b>Auto</b> , CTS will monitor the wireless network and automatically decide whether to implement CTS based on the amount of traffic and collisions that occurs on the wireless LAN.

**Table 4-7** Wi-Fi Advanced Menu

<b>Field or Button</b>	<b>Description</b>
WMM	Wi-Fi Multimedia is QoS (Quality of Service) for the wireless LAN. Enable this option to improve the quality of video and voice applications for the wireless clients on the network.
Wireless Client Access List	This option is to increase the wireless LAN network security. If checked, only the wireless client with the MAC address listed in the Wireless Client Access table can connect to the wireless LAN.



This page intentionally left blank.

## Chapter 5: Configuring TCP/IP

This section contains two examples of configuring TCP/IP in a Windows environment. Most computers already have the TCP/IP configuration enabled. Use the following procedures to verify that the configuration is set up. Configure all client computers on your network for TCP/IP (the protocol that controls communication among computers). Two examples are provided in this document:

- Configuring TCP/IP in Windows XP
- Configuring TCP/IP in Windows Vista

### NOTE

Follow the instructions in your computer user manual for other Operating Systems.

### Configuring TCP/IP in Windows XP

1. On the Windows desktop, click **Start** to display the Start window:

**Figure 5-1:** Windows XP Start Window

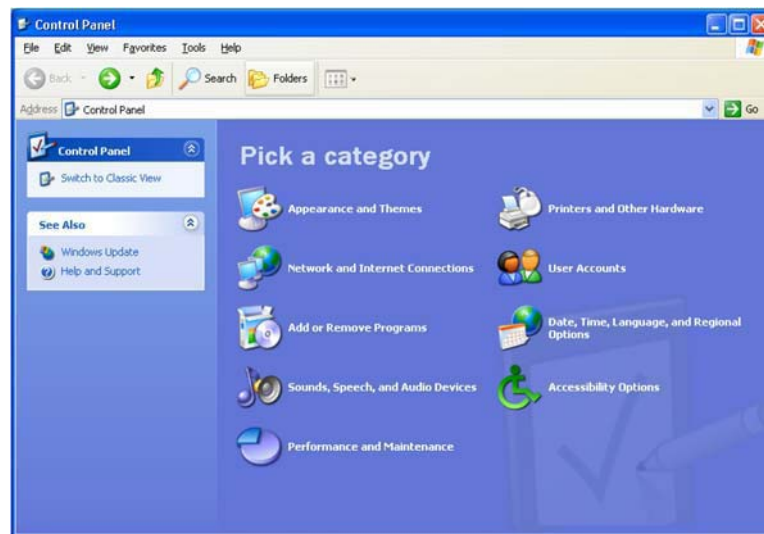

2. Click **Control Panel** to display the Control Panel window. The display varies, depending on your Windows XP view options. If the display is a Category view as shown in Figure 5-2, continue with Step 3. Otherwise, skip to Step 5.

**Figure 5-2:** Control Panel

3. Click **Network and Internet Connections** to display the Network and Internet Connections window:

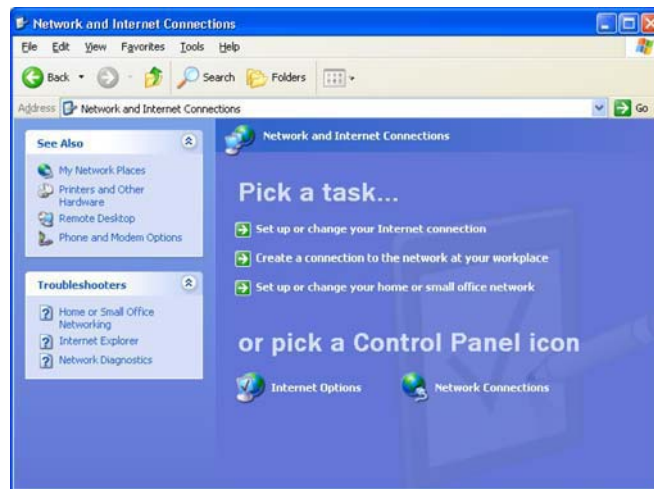
**Figure 5-3:** Network and Internet Connections

4. Click **Network Connections**. Skip to Step 6.
5. If a classic view like Figure 5-4 is displayed, double-click **Network Connections** to display the LAN or High-speed Internet connections.

**Figure 5-4:** Control Panel Classic View

6. Right-click the **Local Area Connection**. If more than one connection is displayed, be sure to select the one for your network interface.

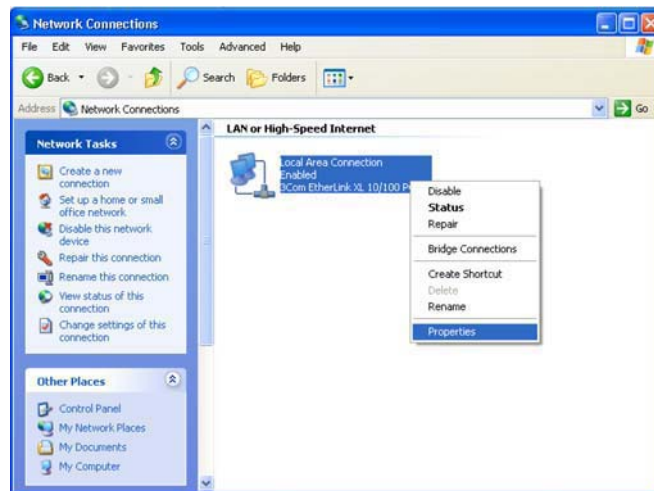
**Figure 5-5:** Network Connections

7. Select **Properties** from the pop-up menu to display the Local Area Connection Properties window:

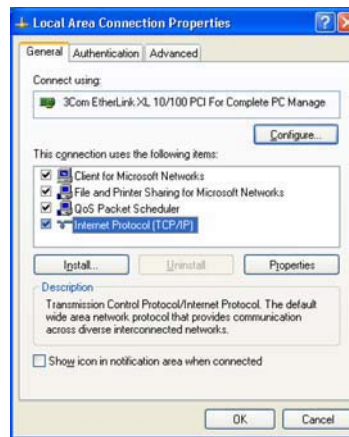
**Figure 5-6:** Local Area Connection Properties

8. On the Local Area Connection Properties window, select **Internet Protocol (TCP/IP)** if it is not selected.
9. Click **Properties** to display the Internet Protocol (TCP/IP) Properties window.

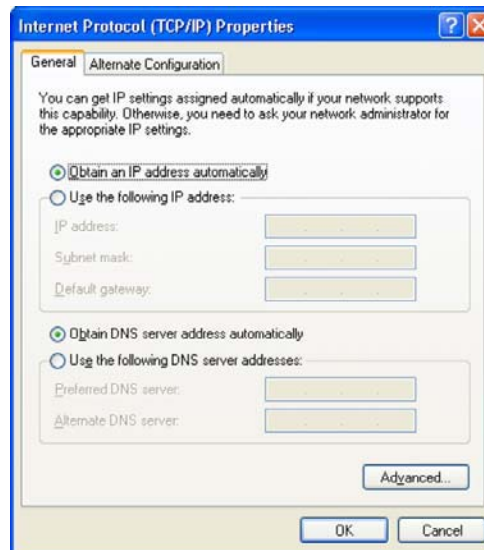
**Figure 5-7:** Internet Protocol (TCP/IP) Properties

10. Be sure Obtain IP address automatically and Obtain DNS server address automatically are selected.
11. Click **OK** to close the TCP/IP Properties window.

## Configuring TCP/IP in Windows Vista

1. On the Windows desktop, click the **Windows Logo** on the left bottom corner to display the Start window. Then click **Network**.

**Figure 5-8:** Network selection

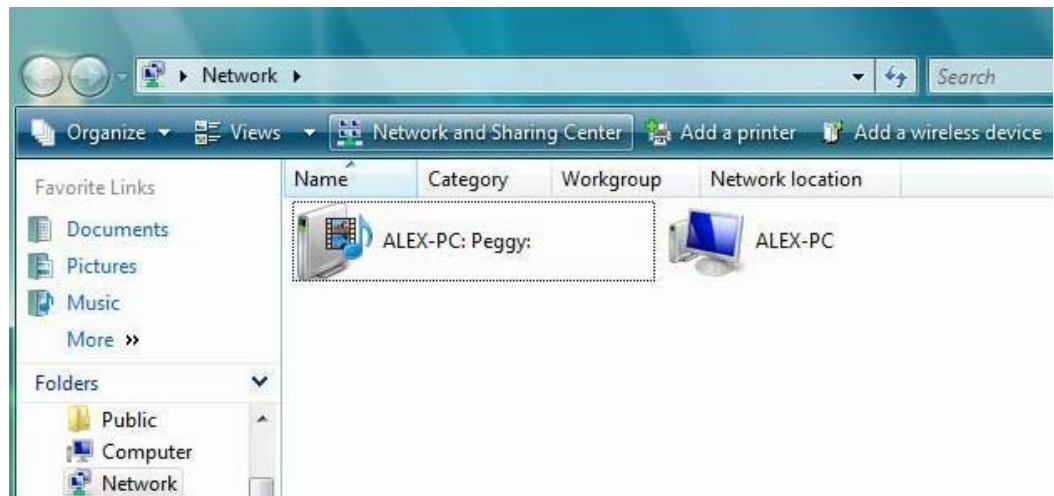

2. When the Network windows appears, click the **Network and Sharing Center** from the action bar on the top of the window.

**Figure 5-9:** Network and Sharing Center

3. After you click the **Network and Sharing Center**, the Network and Sharing Center window displays. Follow by clicking the **Manage Network Connection** from the task bar.

**Figure 5-10:**

4. The network connections appear. Drag your mouse to the **Local Area Connection** and right click the mouse button. A series of tasks display. Click **Properties**.

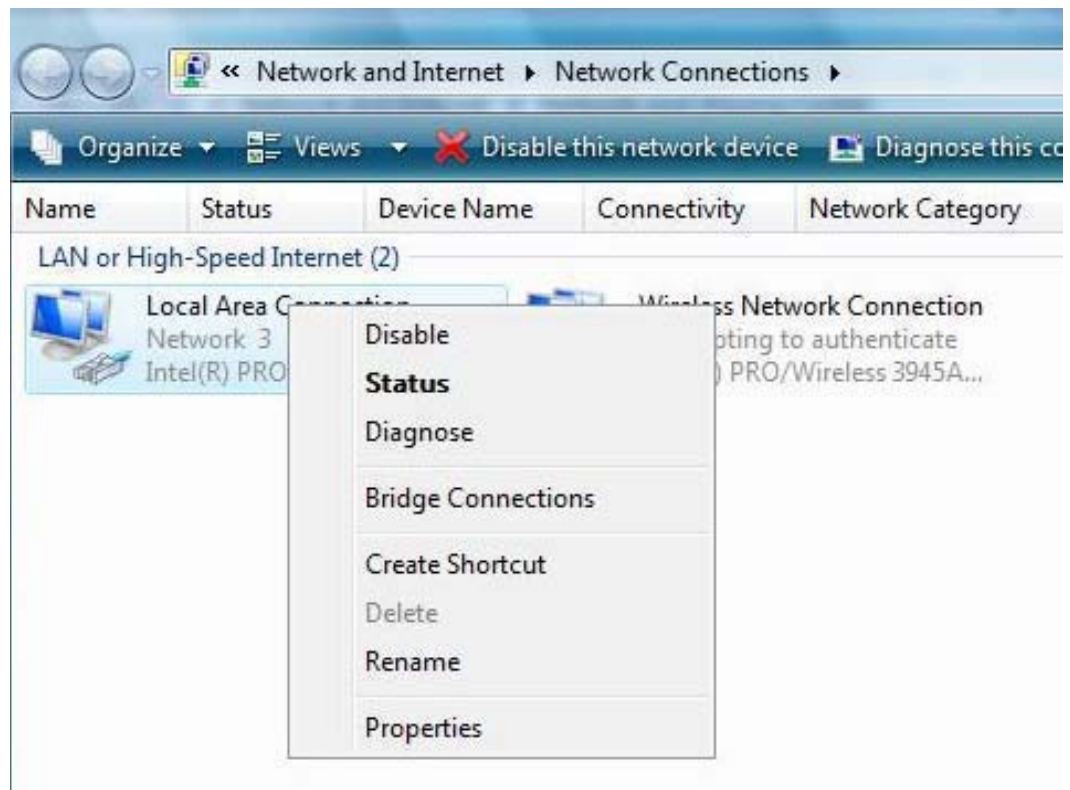
**Figure 5-11:** Local Area Connection selection**Figure 5-12:** Properties selection

5. A series of protocols appear. Among them, check the **Internet Protocol Version 4 (TCP/IPv4)** and click **Properties**.



**Figure 5-13:** Internet Protocol Version 4 (TCP/IPv4) properties selection

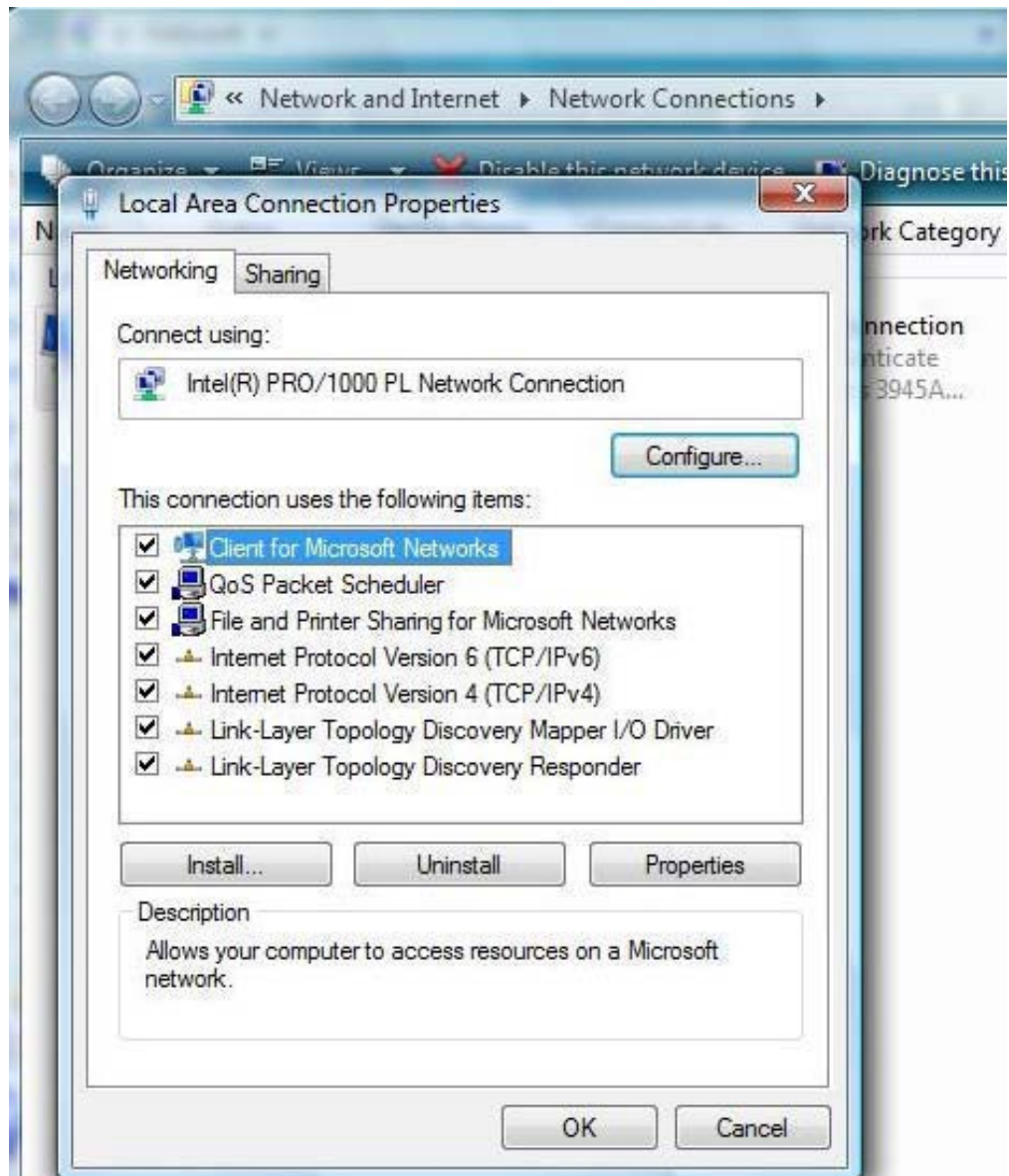

6. At TCP/IPv4 Properties window, check **Obtain an IP address automatically**, and **Obtain DNS server address automatically**. Click **OK** to save the settings.

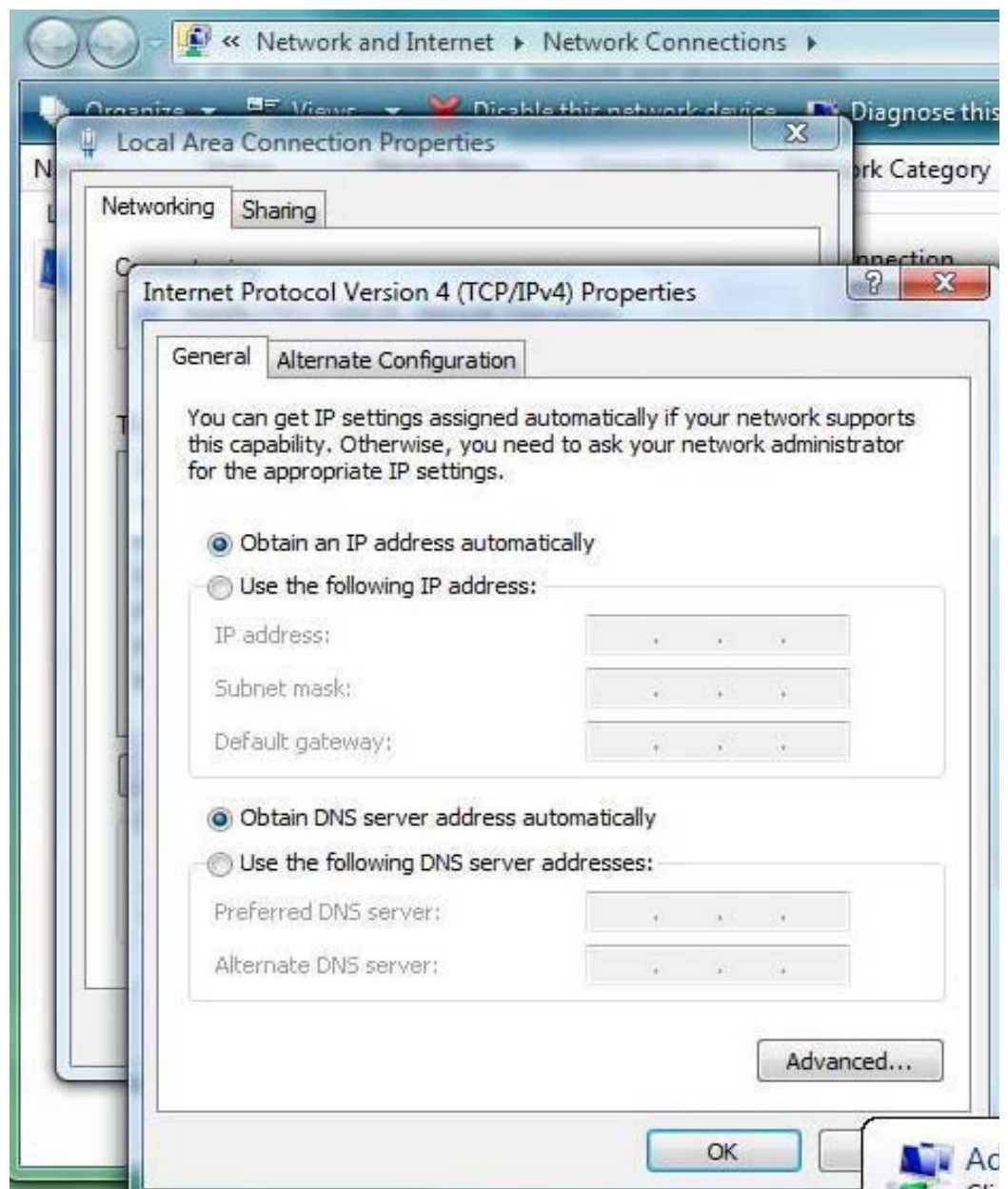
**Figure 5-14:** Internet Protocol Version 4 (TCP/IPv4) Properties window

7. When you have completed the setting updates, click **OK** to exit.

This page intentionally left blank.

# Chapter 6: Troubleshooting

## Power

- Check that the AC power adapter is properly plugged into the electrical outlet and into the Desktop CPE.
- Check that the electrical outlet is working.

## A Computer Cannot Log On to the CPE

Check that the Ethernet cable is properly connected to the Desktop CPE unit and the computer.

## Cannot Connect to the Internet

- Check the Desktop CPE connection status from the Web Interface, refer to the Connection Status section to verify the connection status.
- If the Desktop CPE connection is down, and the gateway has not received an IP for 5 minutes to 10 minutes:
  - Re-Run the Setup Wizard.
  - If the Setup Wizard does not help, then reset the Desktop CPE using the reset button.

## Additional Troubleshooting Help

Contact your service provider for additional help.

This page intentionally left blank.

## **Chapter 7: Important Safety and Legal Information**

Your Motorola WiMAX Wireless Broadband Gateway is designed and tested to comply with a number of national and international standards and guidelines (listed below) regarding human exposure to RF electromagnetic energy. Please see the Regulatory Guide included in the device packaging.



**MOTOROLA**

MOTOROLA and the Stylized M Logo are registered in the US Patent & Trademark Office.  
All other product or service names are the property of their respective owners.  
© 2011 Motorola, Inc.