



MOTOROLA

Cellular Networks

APPLICANT: MOTOROLA

FCC ID: IHET4KJ1

Users Manual Exhibit

LTE WBR FDD Frame Based Radio @ 700MHz

LTE eNodeB Indoor Hardware Installation

Accuracy

While reasonable efforts have been made to assure the accuracy of this document, Motorola, Inc. assumes no liability resulting from any inaccuracies or omissions in this document, or from use of the information obtained herein. Motorola, Inc. reserves the right to make changes to any products described herein to improve reliability, function, or design, and reserves the right to revise this document and to make changes from time to time in content hereof with no obligation to notify any person of revisions or changes. Motorola, Inc. does not assume any liability arising out of the application or use of any product, software, or circuit described herein; neither does it convey license under its patent rights or the rights of others. It is possible that this publication may contain references to, or information about Motorola products (machines and programs), programming, or services that are not announced in your country. Such references or information must not be construed to mean that Motorola intends to announce such Motorola products, programming, or services in your country.

Copyrights

This document, Motorola products, and 3rd Party Software products described in this document may include or describe copyrighted Motorola and other 3rd Party supplied computer programs stored in semiconductor memories or other media. Laws in the United States and other countries preserve for Motorola, its licensors, and other 3rd Party supplied software certain exclusive rights for copyrighted material, including the exclusive right to copy, reproduce in any form, distribute and make derivative works of the copyrighted material. Accordingly, any copyrighted material of Motorola, its licensors, or the 3rd Party software supplied material contained in the Motorola products described in this document may not be copied, reproduced, reverse engineered, distributed, merged or modified in any manner without the express written permission of Motorola. Furthermore, the purchase of Motorola products shall not be deemed to grant either directly or by implication, estoppel, or otherwise, any license under the copyrights, patents or patent applications of Motorola or other 3rd Party supplied software, except for the normal non-exclusive, royalty free license to use that arises by operation of law in the sale of a product.

Restrictions

Software and documentation are copyrighted materials. Making unauthorized copies is prohibited by law. No part of the software or documentation may be reproduced, transmitted, transcribed, stored in a retrieval system, or translated into any language or computer language, in any form or by any means, without prior written permission of Motorola, Inc.

License Agreements

The software described in this document is the property of Motorola, Inc and its licensors. It is furnished by express license agreement only and may be used only in accordance with the terms of such an agreement.

High Risk Materials

Components, units, or 3rd Party products used in the product described herein are NOT fault-tolerant and are NOT designed, manufactured, or intended for use as on-line control equipment in the following hazardous environments requiring fail-safe controls: the operation of Nuclear Facilities, Aircraft Navigation or Aircraft Communication Systems, Air Traffic Control, Life Support, or Weapons Systems (High Risk Activities). Motorola and its supplier(s) specifically disclaim any expressed or implied warranty of fitness for such High Risk Activities.

Trademarks



MOTOROLA

Motorola and the Stylized M Logo are registered in the US Patent & Trademark Office. All other product or service names are the property of their respective owners.



The CE mark confirms Motorola, Inc. statement of compliance with EU directives applicable to this product. Copies of the Declaration of Compliance and installation information in accordance with the requirements of EN50385 can be obtained from the local Motorola representative or by contacting the Customer Network Resolution Center (CNRC). The 24 hour telephone numbers are listed at <https://mynetworksupport.motorola.com>. Select **Customer Network Resolution Center contact information**. Alternatively if you do not have access to CNRC or the internet, contact the Local Motorola Office.

Contents

LTE eNodeB Indoor Hardware Installation

Revision history	2
Version information	2
Release information	2
Resolution of Service Requests	2
General information	3
Purpose	3
Cross references	3
Document banner definitions	3
Text conventions	4
Contacting Motorola	5
24-hour support	5
Ordering documents and CD-ROMs	5
Questions and comments	5
Errors	5

Chapter 1: Introduction

Overview	1-2
Not a planning guide	1-2
Follow the site plan	1-2
Prerequisites	1-2
System shipped unassembled	1-2
Product Description	1-3
Major Components with Call-outs	1-5
Configurations supported	1-7

Chapter 2: Site preparation

Overview	2-2
Preparing the site for equipment arrival	2-2
LTE eNodeB Component Dimensions	2-4
Frame dimensions and clearances	2-5
Electrical Requirements	2-7
Cabinet voltage	2-7
DC supply equipment, Main circuit breaker, and DC input cable	2-7
Site grounding	2-9
Environment Requirements	2-10
Operating temperature range	2-10
Cable Requirements	2-11
eNodeB Cable Descriptions (min 90C insulation rating)	2-13
Tools required for installing the eNodeB components	2-15

Chapter 3: Frame-based eNodeB Installation

- Overview 3-2
- Unpacking Equipment 3-5
- Installation of the rack 3-6
 - Rack and ground cable installation 3-6
- Installing the +27 V dc (PDU) 3-9
 - Required materials and tools. 3-9
 - Installing the PDU 3-9
- Installation of the BCUII 3-14
 - Required materials and tools. 3-14
 - BCUII installation 3-15
- Installation of Radio/Filter Shelf (RFS) and Frame Mounted Radio Head 3-19
 - RFS power cable installation. 3-22
 - RFS Ground Cable Installation. 3-23
- Installation of the GPS 3-25
 - Installing RFGPS antenna and cable 3-25
- Optional equipment 3-28
 - Quartz-high stability oscillator 3-28

Chapter 4: Installation of the indoor portions of the Remote RF based eNodeB

- Installation of the BCUII 4-2
 - Required materials and tools. 4-2
 - BCUII installation 4-3

Chapter 5: Installation of the RRH

- Installing the Remote Radio Head 5-2
 - Installing the 700 MHz RRH 5-2
 - 700 MHz RRH pole mount configuration. 5-9
 - 700 MHz RRH connections 5-16
 - Installation of 2.1/2.6 GHz RRH 5-17
 - 2.1/2.6 GHz RRH pole mount configuration 5-19
 - 2.1 / 2.6 GHz RRH 5-21

Chapter 6: Cabling of the RRH

- Inter-cabling – between major components 6-2
 - Safety when handling Fiber/Power Supply and Earth Cables 6-2
 - RRH ground connections 6-3
 - RRH power connections 6-3
 - RRH to BCUII interconnect 6-10
 - Installing RF cables from antennas to RRH 6-16
 - Customer I/O cable installation 6-16
 - Ethernet cable installation 6-17
- RRH head –48 V dc power cabling installation 6-19
 - RRH –48 Vdc power when using a BCUII 6-19
 - Circuit breaker for dc output to head 6-19
 - Connecting –48 V dc Power 6-19
- Cabling of RRH 6-22
 - 2.1/2.6 GHz RRH. 6-22

Chapter 7: Power-up sequence

- Power Up Sequence 7-2

Chapter 8: Field Replaceable Units

List of Field Replaceable Units (FRUs)	8-2
BCUII Flex4 Modem Replacement	8-3
Objectives	8-3
Preparation	8-3
Replacement Procedure	8-3
BCUII Site Controller Card Replacement	8-6
Objectives	8-6
Preparation	8-6
Replacement Procedure	8-6
eNode Frame Based Radio Replacement.	8-10
Objectives	8-10
Preparation	8-10
eNodeB Frame Based Radio Replacement Procedure	8-10
Filter/Duplexer Replacement.	8-12
Objectives	8-12
Preparation	8-12
Filter/Duplexer Replacement Procedure	8-12
Radio/Filter Shelf Fan Tray Replacement	8-14
Objective.	8-14
Preparation	8-14
Radio/Filter Shelf Fan Tray replacement procedure	8-14
Q-HSO (Quartz High Stability Oscillator) Replacement	8-17
Q-HSO (Quartz High Stability Oscillator) Replacement	8-17
Preparation	8-17
Required tools	8-17
Torque requirements.	8-18
Required item	8-18
Q-HSO replacement procedure	8-18
Reference diagram.	8-18
BCUII card cage assembly replacement procedures	8-20
Objectives	8-20
Introduction	8-20
Preparation	8-20
BCUII Fan Tray Replacement	8-25
Objectives	8-25
Introduction	8-25
Preparation	8-25
Replacement Procedure	8-26
eNodeB PDU Replacement.	8-30
Objective.	8-30
Preparation	8-30
eNodeB PDU replacement procedure	8-31

List of Figures

Figure 1-1: Major components	1-5
Figure 1-2: Radio Frame Shelf	1-6
Figure 2-1: Frame dimensions and clearances	2-6
Figure 2-2: System Power Cabling	2-12
Figure 2-3: System Data Cabling	2-13
Figure 3-1: Indoor system	3-3
Figure 3-2: Radio Frame Shelf	3-4
Figure 3-3: Location of ground terminals on a Motorola rack	3-8
Figure 3-4: PDU power connection	3-12
Figure 3-5: PDU Front	3-13
Figure 3-6: BCUII physical design	3-14
Figure 3-7: Cabling Power to +27 V dc BCUII	3-16
Figure 3-8: BCUII Grounding	3-18
Figure 3-9: Radio/Filter Shelf	3-19
Figure 3-10: Installing Duplexer	3-20
Figure 3-11: Tying power cables to the cable tie brackets	3-23
Figure 3-12: RFS ground cable connection	3-24
Figure 3-13: RFGPS installation and components diagram.	3-27
Figure 3-14: BCUII Q-HSO unit	3-28
Figure 4-1: BCUII physical design	4-2
Figure 4-2: Cabling Power to -48 Vdc BCUII.	4-4
Figure 4-3: BCUII Grounding	4-5
Figure 5-1: 700 MHz RRH connections	5-17
Figure 5-2: LTE 2.1/2.6 GHz RRH Wall Mount Bracket Mounting Hole Locations	5-19
Figure 5-3: LTE 2.1/2.6 GHz RRH Mounting Bracket	5-21
Figure 5-4: 2.1 GHz RRH	5-22
Figure 6-1: System Power Cabling	6-6
Figure 6-2: 2.6 GHz RRH connections	6-7
Figure 6-3: RRH power cabling	6-8
Figure 6-4: Fiber Cable	6-11
Figure 6-5: BCUII Fiber Optic Cable Grommet Location	6-12
Figure 6-6: Fiber Optic Cable Brackets	6-13
Figure 6-7: Fiber Optic Cable Clip Installation.	6-14
Figure 7-1: BCUII Power Switch	7-3
Figure 8-1: RFS fan tray in unlocked position	8-15
Figure 8-2: RFS fan tray in locked position	8-16
Figure 8-3: Q-HSO removal and installation	8-19
Figure 8-4: BCUII Fiber Cover.	8-23
Figure 8-5: Fan tray removal and installation	8-29
Figure 8-6: PDU	8-32

List of Tables

Table 1-1: PDU	1-4
Table 1-2: Configurations Supported.	1-7
Table 2-1: LTE eNodeB component dimensions	2-4
Table 2-2: Wire AWG (min 90C insulation rating) and circuit breaker sizing for +27 V dc frame systems	2-7
Table 2-3: Wire AWG (min 90C insulation rating) and circuit breaker sizing for -48 V dc remote RF based eNodeB (for systems using the Motorola -48 V PDU)	2-8
Table 2-4: eNodeB Cable Descriptions	2-13
Table 3-1: Frame-based eNodeB cable connections to PDU breakers	3-13
Table 3-2: Lug criteria	3-13
Table 5-1: LED configurations	5-17
Table 6-1: Fiber cables routing	6-15
Table 6-2: Lug criteria	6-21
Table 8-1: eNodeB FRU Information	8-2

LTE eNodeB Indoor Hardware Installation

What is covered in this manual?

This document provides the physical hardware installation procedures for the LTE frame and radio units. It is not a system or site planning document.

Revision history

The following sections show the revision status of this document.

Version information

The following table describes the changes made to this document:

Version	Date of issue	Description
1	OCT 2009	Initial release.
2	NOV 2009	Removed FCC Requirements. Updated Chapter 6. Added several figures and split Procedure 6-2 into two separate procedures: connecting to the BCUII and connecting to the RRH.
3	NOV 2009	Added PDU Connection figure in Chapter 3.
4	DEC 2009	Added RRH Power cable detail. Corrected FTR issues.
5	FEB 2010	Updated eNodeB FRU Information.
6	FEB 2010	Updates from review comments.

Release information

This is the first release of this document.

Resolution of Service Requests

The following Service Requests are resolved in this document:

Service Request	CMBP Number	Description
NA	NA	Initial release

General information

Purpose

Motorola documents provide the information to operate, install, and maintain Motorola equipment. It is recommended that all personnel engaged in such activities be properly trained by Motorola.

Motorola disclaims all liability whatsoever, implied or expressed, for any risk of damage, loss or reduction in system performance arising directly or indirectly out of the failure of the customer, or anyone acting on the customer's behalf, to abide by the instructions, system parameters, or recommendations made in this document.

These documents are not intended to replace the system and equipment training offered by Motorola. They can be used to supplement and enhance the knowledge gained through such training.

NOTE

If this document was obtained when attending a Motorola training course, it is not updated or amended by Motorola. It is intended for TRAINING PURPOSES ONLY. If it was supplied under normal operational circumstances, to support a major software release, then Motorola automatically supplies corrections and posts on the Motorola customer website.

Cross references

References made to external publications are shown in italics. Other cross references, emphasized in blue text in electronic versions, are active links to the references.

This document is divided into numbered chapters that are divided into sections. Sections are not numbered, but are individually named at the top of each page, and are listed in the table of contents.

Document banner definitions

A banner indicates that some information contained in the document is not yet approved for general customer use. A banner is oversized text on the bottom of the page, for example, **PRELIMINARY – UNDER DEVELOPMENT**

Text conventions

The following conventions are used in Motorola documents to represent keyboard input text, screen output text, and special key sequences.

Input

Characters typed in at the keyboard are shown like this sentence.
Items of interest within a command appear like this sentence.

Output

Messages, prompts, file listings, directories, utilities, and environmental variables that appear on the screen are shown like this sentence.
Items of interest within a screen display appear like this sentence.

Special key sequences

Special key sequences are represented as follows:

CTRL-c or CTRL+C	Press the Ctrl and C keys at the same time.
CTRL-SHIFT-c or CTRL+SHIFT+C	Press the Ctrl , Shift , and C keys at the same time.
ALT-f or ALT+F	Press the Alt and F keys at the same time.
ALT+SHIFT+F11	Press the Alt , Shift and F11 keys at the same time.
 	Press the pipe symbol key.
RETURN or ENTER	Press the Return or Enter key.

Contacting Motorola

Motorola appreciates feedback from the users of our documents.

24-hour support

If you have problems regarding the operation of your equipment, contact the Customer Network Resolution Center (CNRC) for immediate assistance. The 24-hour telephone numbers are listed at <https://mynetworksupport.motorola.com>. Select **Customer Network Resolution Center contact information**. Alternatively if you do not have access to CNRC or the internet, contact the Local Motorola Office.

Ordering documents and CD-ROMs

With internet access available, to view, download, or order documents (original or revised), visit the Motorola customer web page at <https://mynetworksupport.motorola.com>, or contact your Motorola account representative.

Without internet access available, order hard-copy documents or CD-ROMs from your Motorola Local Office or Representative.

If Motorola changes the content of a document after the original printing date, Motorola publishes a new version with the same part number but a different revision character.

Questions and comments

Send questions and comments regarding user documentation to the email address: mydocs@motorola.com.

Errors

To report a documentation error, call the CNRC (Customer Network Resolution Center) and provide the following information to enable CNRC to open an SR (Service Request):

- The document type
- The document title, part number, and revision character
- The page number with the error
- A detailed description of the error and if possible the proposed solution

Introduction

Overview

This document provides information pertaining to the hardware and cabling installation for the frame-based eNodeB and Remote RF-based eNodeB versions of the Motorola LTE eNodeB Hardware. The specific hardware units discussed in this manual are as follows:

- Power Distribution Unit (PDU)
- BCUII
- Radio Heads
- GPS

Not a planning guide

Do not use this manual as a planning guide. Complete all site-specific plans and information before starting the installation. The site-specific information determines the exact placement of the frames, FRUs, and cables.

Follow the site plan

Items and cables are covered in the installation procedure that may not apply to a specific site configuration. Refer to the site plan to determine which items and cables are installed. Skip over those procedures for items and cables that are not required.

Prerequisites

The following are the three major prerequisites:

- A Structural Engineer has specified the procedure, tools, and equipment to mount the frame to the floor.
- All the site preparations (including power) are completed according to the site plan.
- All site planning and configuration information is available.

System shipped unassembled

The eNodeB is shipped unassembled in several cartons/boxes. The eNodeB is assembled at the customer's site.

Product Description

The eNodeB versions described in this manual provide air interface support to user equipment while also terminating signaling and bearer packets and communicating with other eNodeB peers in the network. The eNodeB supports FDD in a range of frequencies, including: 700 MHz, 2.1 GHz, and 2.6 GHz. The eNodeB has two configurations. The first is a frame-based eNodeB which consists of a standard 19-inch rack, BCUII, Radio Filter Shelf (contains frame radio and duplexer), and a +27 V PDU. The second is a Remote RF-based eNodeB which consists of a standard 19-inch rack, BCUII, Remote Radio Heads, and an optional -48V PDU.

Racks

Motorola provides racks, designed to meet seismic zone 4 loading, in three sizes:

- Indoor 19-inch rack (925 mm)
- Indoor 19-inch rack (1325 mm)
- Indoor 19-inch rack (1769 mm)

Base Control Unit II

The BCUII is a small, self-contained rack mountable unit. It can have one or two modems, a fan, a PSU, and an optional Q-HSO.

Remote Radio Head

The LTE eNodeB Remote Radio Head (RRH) is a frequency-dependent Radio Resource Unit (RRU) that can be mounted remotely from the indoor frame. It is a standalone naturally convection cooled outdoor product that can also be installed indoors.

Radio Filter Shelf

The radio filter shelf is a rack mountable unit. It includes a fan assembly, and a filter/duplexer. Also, the LTE eNodeB frame based radio (FBR) is mounted in the radio filter shelf.

Frame Based Radio

The LTE eNodeB frame based radio (FBR) is a frequency-dependent radio resource unit that is mounted in the radio filter shelf. It requires forced convection cooling and is installed indoors.

Power Distribution Unit

The PDU is available in a +27 V dc version for frame-based eNodeB or a -48 V dc version for Remote RF-based eNodeB. The customer can choose to provide their own PDU function for the Remote RF-based eNodeB configurations.

Table 1-1 PDU

Power	Amperage	Supports
+27 V dc	175A input from customer	3 Radios via 3x 40A breakers 1x BCUII via 1x 30A breaker
-48V dc	100A input from customer	3x Aux via 1x 15A breaker

Manual Order

Chapter 1 — Introduction This chapter provides scope of the manual, an overview of manual chapters, and identification of the eNodeB major components. Also described are the different configurations that are supported and how all the components interact.

Chapter 2 — Site Preparation This chapter provides the procedures and information to verify that the site is ready to have the frames and other equipment installed.

Chapter 3 — Frame-based eNodeB Installation This chapter provides information for unpacking, installing, and grounding the rack, and installing major components of the frame-based eNodeB.

Chapter 4 — Installation of the indoor portions of the Remote RF based eNodeB This chapter provides information for installing the BCUII.

Chapter 5 — Installation of the RRH This chapter provides information for installing the Remote Radio Head (RRH).

Chapter 6 — Cabling of the RRH This chapter provides cabling instructions for the RRH and interconnect from the indoor rack mounted equipment to the building I/O point for the Remote RF Based eNodeB.

Chapter 7 — Power-up sequence This chapter provides the power-up sequence for the eNodeB.

Chapter 8 — Field Replaceable Units This chapter provides procedures for removal and replacement of FRUs.

Major Components with Call-outs

Figure 1-1 Major components

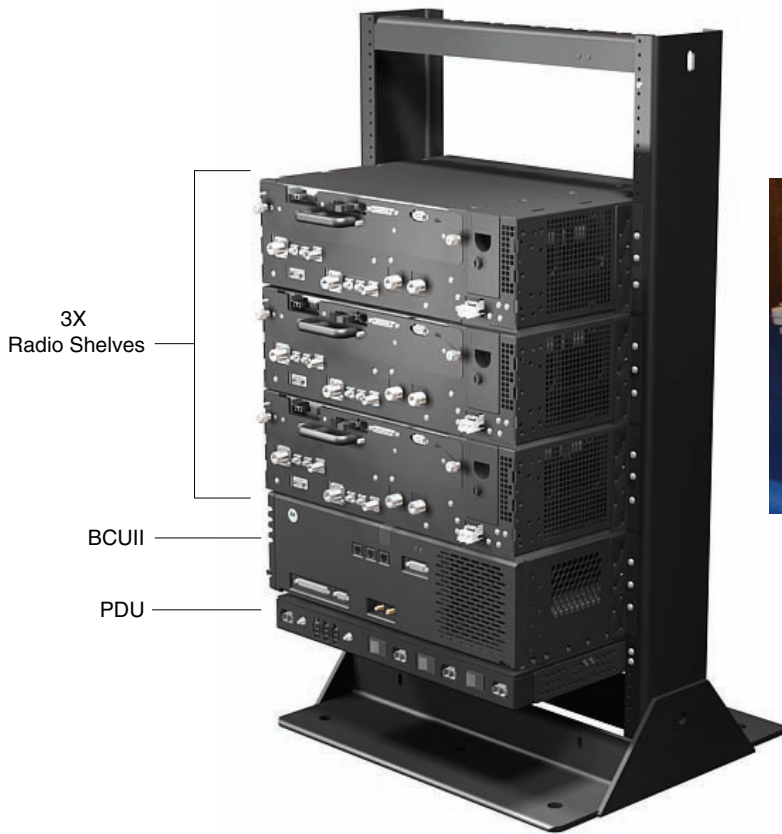

Remote Radio Head

E1_majorcomponents_eNodeB.eps

Figure 1-2 Radio Frame Shelf

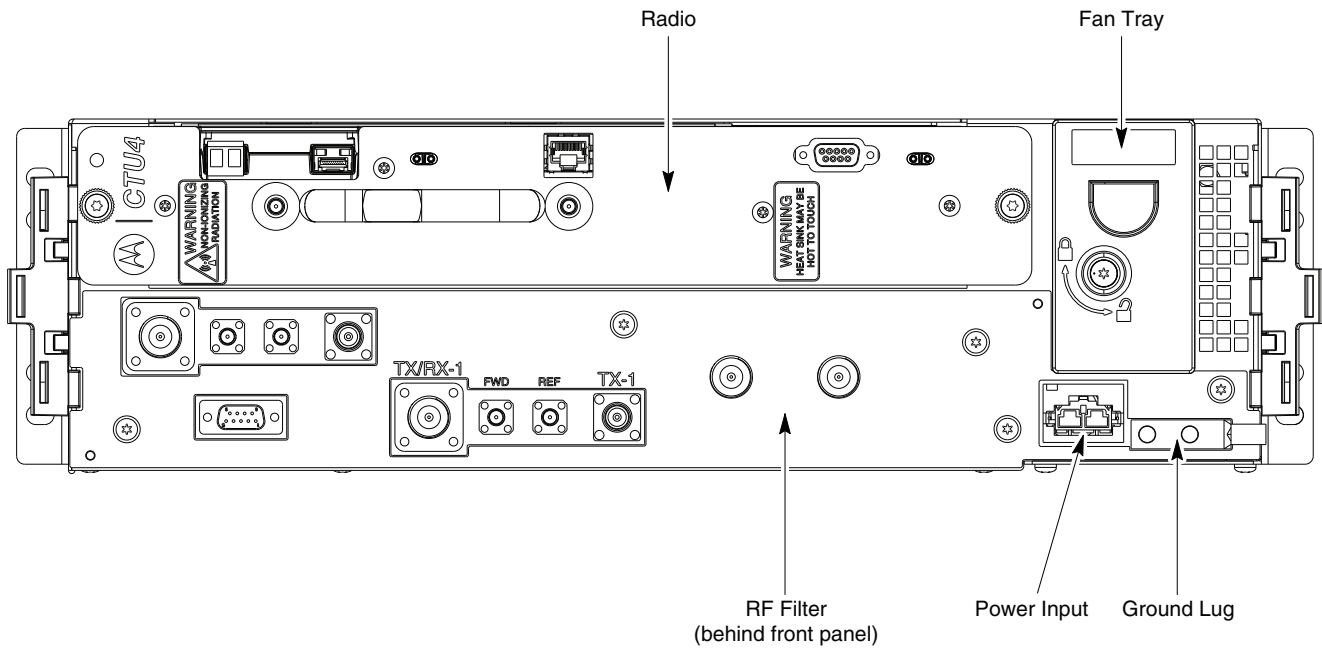

Configurations supported

The following configurations are supported:

Table 1-2 Configurations Supported

Radio	BCU	Power Supply	Frequency Band	Configuration Type
Frame Mounted	BCUII	+27 V dc	700 MHz	Frame-based eNodeB
Remote Radio Head	BCUII	-48V dc	2.1 GHz	Remote RF-based eNodeB
Remote Radio Head	BCUII	-48V dc	2.6 GHz	Remote RF-based eNodeB
Remote Radio Head	BCUII	-48V dc	700 MHz	Remote RF-based eNodeB

Site preparation

Overview

The Site preparation section provides the procedures and information to verify that the site is ready to have the frames and other equipment installed.

Preparing the site for equipment arrival

Based on the site characteristics, execute the steps that apply to the site.

Preparing the outdoor site for the equipment

A detailed layout of the site is provided with the site-specific documentation. Before installing the hardware, compare the information presented here to the site-specific documentation layout and verify the following with the site manager:

- Site is clean.
- Site-specific documentation covering all site-dependent installation information is available.
- The installation area has restricted access. Equipment is meant to be installed and operated in a restricted access location.
- All building/site AC or DC power cabling has been installed.
- The screen (outer shield) of the RF antenna coaxial cable must be connected to earth (grounded) at the entrance to the building. Connecting ground should be done in accordance with applicable national electrical installation codes (Section 820.93 of the National Electrical Code, ANSI/NFPA 70).
- This equipment shall be connected directly to the dc supply system earthing electrode conductor or to a bonding jumper from an earthing terminal bar or bus to which the dc supply system earthing electrode conductor is connected.
 - This equipment shall be connected directly to the dc supply system earthing electrode conductor or to a bonding jumper from an earthing terminal bar or bus to which the dc supply system earthing electrode conductor is connected.
 - This equipment shall be located in the same immediate area (such as adjacent cabinets) as any other equipment that has a connection between the earthed conductor of the same dc supply circuit and the earthing conductor, and also the point of earthing of the dc system. The dc system shall not be earthed elsewhere.
 - The dc supply source shall be located within the same premises as this equipment.
 - Switching or disconnecting devices shall not be in the earthed circuit conductor between the dc source and the point of connection of the earthing electrode conductor.
- Verify that the Master Ground Bar is connected to a solid earth ground. Connecting the Master Ground Bar is required to ensure protection from hazardous voltages by providing a high integrity protective earthing circuit when the frame is later grounded to the Master Ground Bar.

- The site can maintain the operating temperature range.
- The building meets the voltage and amperage requirements shown in [DC supply equipment, Main circuit breaker, and DC input cable on page 2-7](#).
- The site can meet the chassis dimensions (as shown in [LTE eNodeB Component Dimensions on page 2-4](#)) and not violate any of the required clearances (as shown in [Figure 2-1](#)).
- The DC supply equipment, Main circuit breaker, and DC input cable called out in [Table 2-2](#) for the LTE frame DC input are either installed or available to be installed.
- The mounting location can support the weight of the LTE frame as stated in [Table 2-1](#).
- To comply with UL/60950-1 second edition safety requirements, cables connected to AISG and Customer I/O must be no more than 42 meters (140 feet) and the frame ground conductor size must be a minimum of 6 AWG.

Procedure 2-1 Preparing the outdoor site for the equipment

1	<p>Locate the demarcation blocks for external utilities.</p> <p>Verify that they are shown on the Site Engineering documents and determine the required cable routing back to the equipment frames.</p>
2	<p>Verify the following:</p> <ul style="list-style-type: none"> ● Availability of appropriate electrical ground connections for the equipment. ● Compliance with any site engineering documentation and specifications. ● DC power is available and meets the site documentation specifications. ● Pole and/or wall mounting structures are adequate. Ensure that a qualified structural engineer verifies the RRH wall or pole structure and wall-mount or pole-mount installation for the weight of the installation under adverse conditions in the installation area. ● Outdoor cable runs are installed and meet local building codes. ● Customer input termination tie points are available. ● Availability of lighting and power for installation.

Preparing the indoor site for the equipment

Perform the following steps:

Procedure 2-2 Preparing the indoor site for the equipment

1	<p>Locate the demarcation blocks for internal utilities.</p>
----------	--

Continued

Procedure 2-2 Preparing the indoor site for the equipment (Continued)

	Verify that they are shown on the Site Engineering documents, and determine the required cable routing back to the equipment frames.
2	<p>Verify the following:</p> <ul style="list-style-type: none"> • Availability of lighting and power for installation. • Availability of appropriate electrical ground connections for the equipment. • Access to, and routing of; input power, RF output, and general interconnection cabling space. • DC power is available and meets the site documentation specifications. • Level surface and floor support to handle the weight of the eNodeB equipment, frame, and cabling. • Compliance with any site engineering documentation and specifications.

LTE eNodeB Component Dimensions

Table 2-1 shows component dimensions for both Frame-based eNodeB and Remote RF-based eNodeB configurations.

Table 2-1 LTE eNodeB component dimensions

Item	Description	Width (mm)	Depth (mm)	Height (mm)	Weight (in lbs)	Mass (in Kg)	Height (Rack units)	Quantity	
								Frame	Remote
STHN4146	19" Rack	530	430	925	66.14	30.00	18	Either Frame or Remote	
STHN4121	19" Rack	530	430	1325	77.16	35.00	27		
STHN4120	19" Rack	565	430	1769	125.66	57.00	37		
STLN6905	Power Distribution Unit - +27 V dc	485	295	44	8.82	4.00	1	1	—
STLN6906	Power Distribution Unit - -48V	485	295	44	8.82	4.00	1	—	1
SG1756	BCUII	485	330	132	17.60	8.00	3	1	1
STLN6903	Radio/Duplexer Shelf	485	330	132	17.64	8.00	3	1 to 3	—

Continued

Table 2-1 LTE eNodeB component dimensions (Continued)

Item	Description	Width (mm)	Depth (mm)	Height (mm)	Weight (in lbs)	Mass (in Kg)	Height (Rack units)	Quantity
STFF4046	Dual Duplexer (Upper C Band)	215	290	63	11.02	5.00	—	1 to 3
STWF4000	LTE Indoor Radio (Upper C Band)	356	305	60	14.33	6.50	—	1 to 3
	2.6 GHz RRH	325	174	409	41	18.8	—	1 to 3
	2.1 GHz RRH	325	189	409	43	19.8	—	1 to 3
	700 MHz RRH	346	210	344	40	18.0	—	1 to 3

 **NOTE**

Height, Width, Depth dimensions do not include connectors or cables that may be attached. These dimensions also do not include the removal handles or the hinge.

Frame dimensions and clearances

Figure 2-1 shows the footprint of the rack.

Figure 2-1 Frame dimensions and clearances

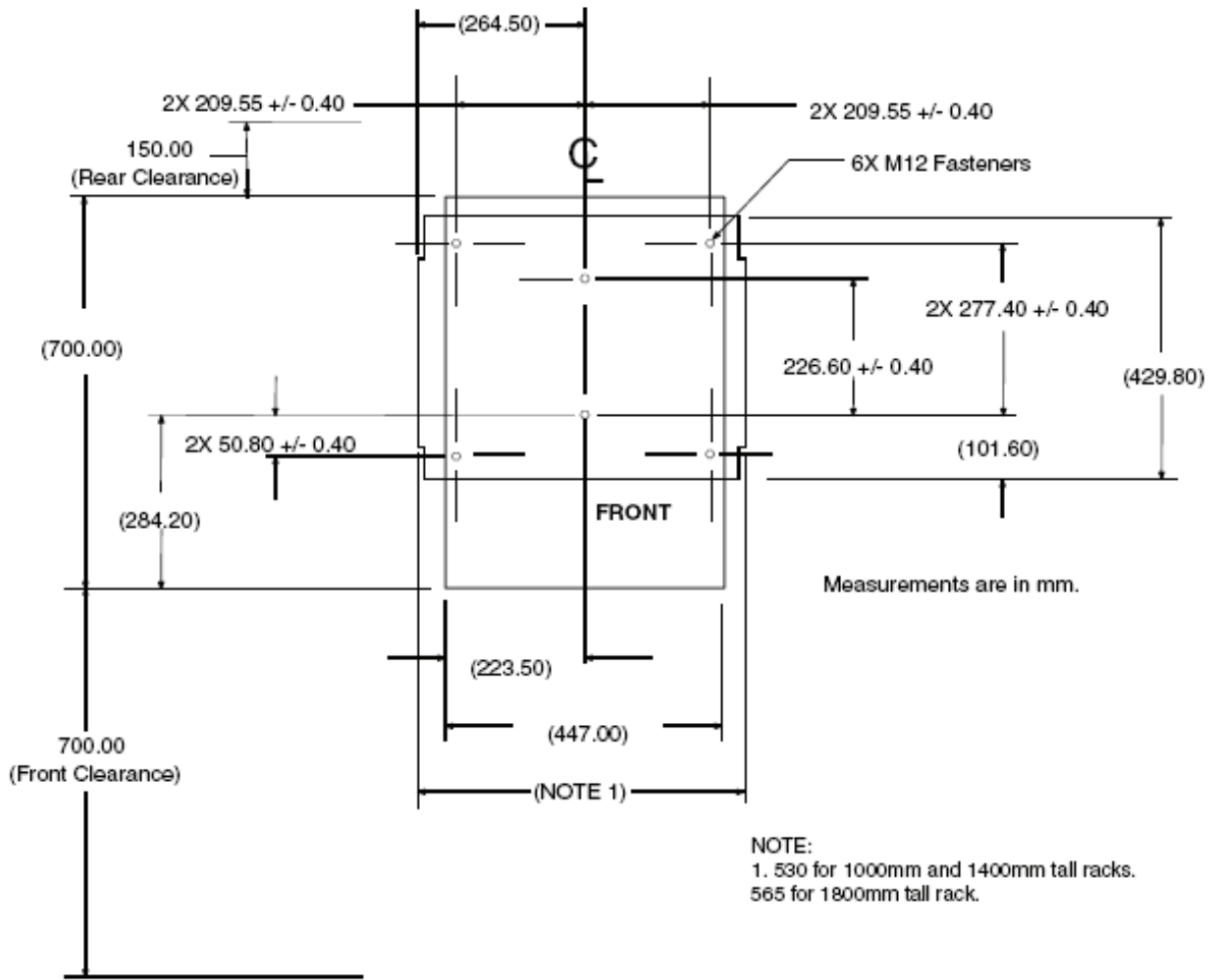

NOTE

An insulating pad is attached to the base of the rack to electrically isolate the rack from the floor.

Electrical Requirements

Cabinet voltage

There are two basic power system types:

- Remote RF-based eNodeB: -48 V dc RRH 700 MHz, 2.1 GHz, 2.6 GHz— for this type, the customer can use the optional -48 V dc PDU from Motorola or their own circuit breakers.
- Frame-based eNodeB: +27 V dc frame radio 700 MHz — for this type, the +27 V dc PDU, frame radios, and BCUII are all co-located in the same rack.

DC supply equipment, Main circuit breaker, and DC input cable

The DC supply equipment, main circuit breaker, and DC input cables are determined by the site characteristics.

Table 2-2 Wire AWG (min 90C insulation rating) and circuit breaker sizing for +27 V dc frame systems

LTE FDD	Number of Radios	Breaker size (A)	Wire size (AWG)	Maximum cable length (m)
LTE Frame	3	175	3/0 AWG	16
LTE Frame	2	175	3/0 AWG	20
LTE Frame	2	150	2/0 AWG	16
LTE Frame	2	125	1/0 AWG	13
LTE Frame	1	175	3/0 AWG	29
LTE Frame	1	150	2/0 AWG	23
LTE Frame	1	125	1/0 AWG	18
LTE Frame	1	100	1 AWG	14
LTE Frame	1	90	2 AWG	11

Table 2-3 Wire AWG (min 90C insulation rating) and circuit breaker sizing for -48 V dc remote RF based eNodeB (for systems using the Motorola -48 V PDU)

LTE FDD	Number of Radios	Breaker size (A)	Wire size (AWG)	Maximum cable length (m)
LTE RRH	3	175	3/0 AWG	69
LTE RRH	3	150	2/0 AWG	55
LTE RRH	3	150	2/0 AWG	55
LTE RRH	3	125	1/0 AWG	44
LTE RRH	3	100	1 AWG	35
LTE RRH	3	90	2 AWG	27
LTE RRH	3	80	3 AWG	22
LTE RRH	2	175	3/0 AWG	89
LTE RRH	2	150	2/0 AWG	70
LTE RRH	2	125	1/0 AWG	56
LTE RRH	2	100	1 AWG	44
LTE RRH	2	90	2 AWG	35
LTE RRH	2	80	3 AWG	28
LTE RRH	2	70	4 AWG	22
LTE RRH	1	175	3/0 AWG	124
LTE RRH	1	150	2/0 AWG	98
LTE RRH	1	125	1/0 AWG	78
LTE RRH	1	100	1 AWG	62
LTE RRH	1	90	2 AWG	49
LTE RRH	1	80	3 AWG	39
LTE RRH	1	70	4 AWG	31

Wire AWG (min 90C insulation rating) and circuit breaker sizing for –48 VDC RRH systems without PDU option (customer-provided PDU function)

For BCUII powered directly from the –48 V dc branch circuit, where the PDU is optional:

- BCUII DC branch circuit protection: Single pole 20 A rated circuit breaker for nominal –48 V dc
- BCUII DC cable: Customer-supplied DC power cable, VW-1 #8 – #10 AWG, 10 m (32.8 feet), UL temperature rating 105°C (167°F).

For RRH powered directly from the –48 V dc branch circuit, where the PDU is optional:

- RRH DC branch circuit protection: Single pole 30 A rated circuit breaker for nominal –48 V dc.
- DC cable #1 (branch circuit breaker to building I/O point): Customer-supplied DC power cable, VW-1 #8, 10 m (32.8 feet) or less, UL temperature rating 105°C (167°F).
- DC cable #2 (building I/O point to RRH): Motorola supplied AB, as per [Table 2-4](#).

Site grounding

Site grounding is according to *Grounding Guidelines for Cellular Radio Installations* (Motorola part number 68P81150E62).

Environment Requirements

Operating temperature range

The minimum airflow clearances for the product under which it must operate through the entire temperature range with at least one vertical face open are described.

The operating temperature range is as follows:

- Operating Temperature Range – Install the equipment in an environment compatible with the maximum ambient temperature of the equipment. The frame-based eNodeB and indoor components of the remote RF based eNodeB operate over the following temperature ranges within the altitudes shown:
 - -5°C to +55°C from -100 m to 1500 m
 - -5°C to +40°C from 1500 m to 3500 m
 - -5°C to +35°C from 3500 m to 4000 m

The LTE Remote Radio Head operates over the following temperature ranges within the altitudes shown:

- -40°C to +55°C from -100 m to 1500 m
- -40°C to +40°C from 1500 m to 3500 m
- -40°C to +35°C from 3500 m to 4000 m

Cable Requirements

[Figure 2-2](#) and [Figure 2-3](#) show the power cabling and data cabling for the eNodeB system.

Figure 2-2 System Power Cabling

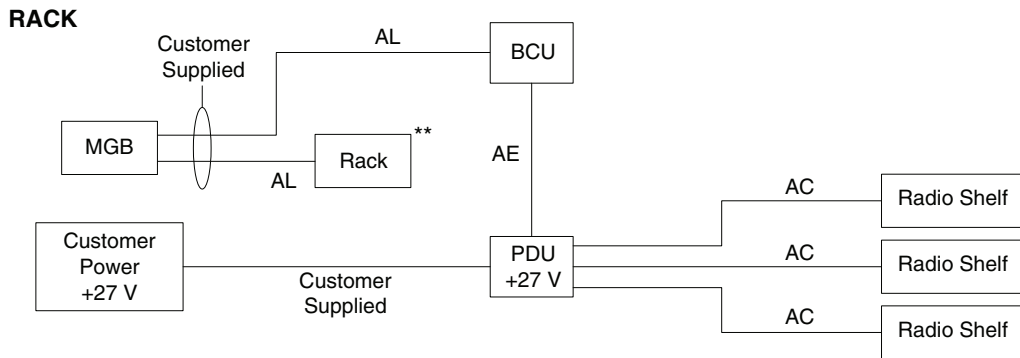

** When using a Motorola rack, only the BCU and the frame need to be cabled to the MGB. When using a non-Motorola rack, all items must be cabled to the MGB.

RRH STYLE 1

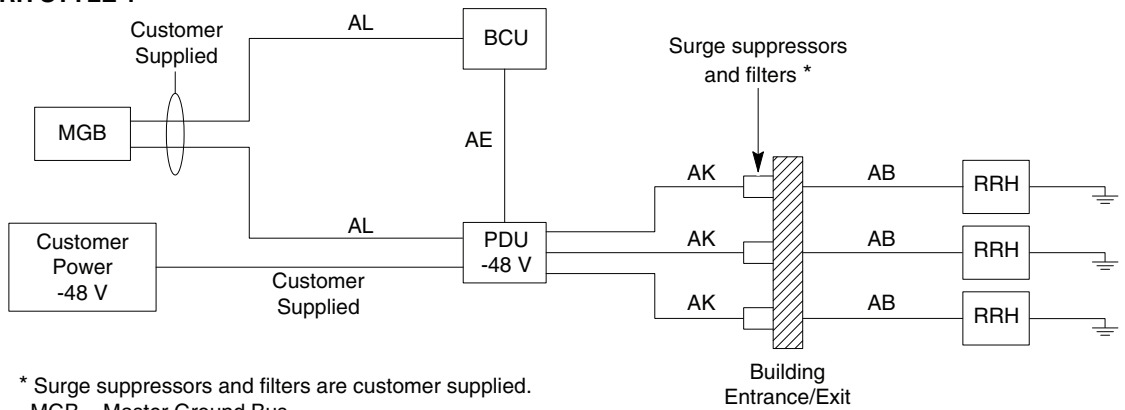

* Surge suppressors and filters are customer supplied. MGB = Master Ground Bus

RRH STYLE 2

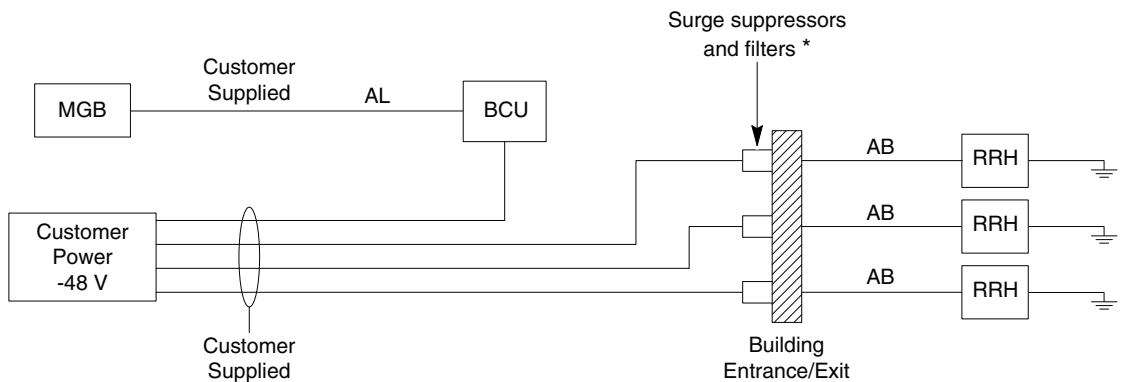

* Surge suppressors and filters are customer supplied. MGB - Master Ground Bus

E1_SysPwrCabling1.eps

Figure 2-3 System Data Cabling

RACK

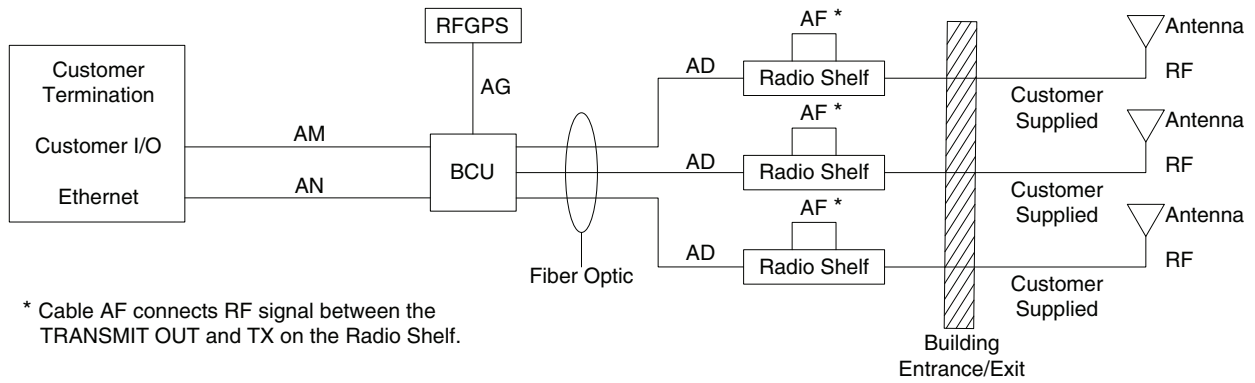

RRH

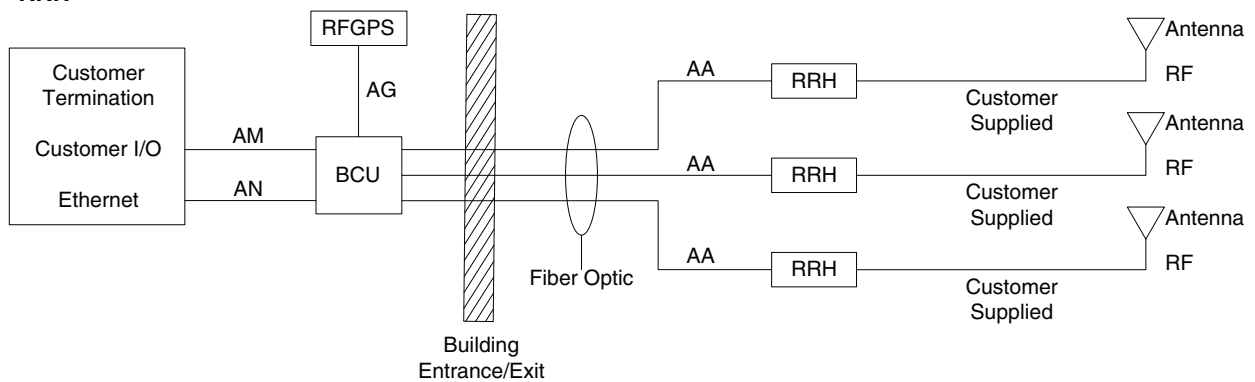

E1_eNodeB_SysdataCable1.eps

eNodeB Cable Descriptions (min 90C insulation rating)

Table 2-4 eNodeB Cable Descriptions

Cable label	Part number	Description	Where used
AA	SYKN8904	6 m (19.68 ft), Fiber Optic Cable	Remote Based eNodeB
	SYKN8905	20 m (65.6 ft), Fiber Optic Cable	
	SYKN8906	40 m (131.2 ft), Fiber Optic Cable	
	SYKN8907	60 m (196.8 ft), Fiber Optic Cable	
	SYKN8908	80 m (262.4 ft), Fiber Optic Cable	
	SYKN8909	100 m (328.0 ft), Fiber Optic Cable	

Continued

Table 2-4 eNodeB Cable Descriptions (Continued)

Cable label	Part number	Description	Where used
AB	SYKN8859	20 m (65.6 ft), 8 AWG — RRH DC Power Cable (105C rated)	Remote Based eNodeB
	SYKN8860	6 m (19.68 ft), 10 AWG — RRH DC Power Cable (105C rated)	
	SYKN8864	40 m (131.2 ft), 8 AWG — RRH DC Power Cable (105C rated)	
	SYKN8863	60 m (196.8 ft), 6 AWG — RRH DC Power Cable (105C rated)	
	SYKN8862	80 m (262.4 ft), 6 AWG — RRH DC Power Cable (105C rated)	
	SYKN8861	100 m (328.0 ft), 6 AWG — RRH DC Power Cable (105C rated)	
AC	STKN4129	Radio Power Cables —Pwr Cable to connect Radio Shelf to PDU	frame-based eNodeB
AD	STKN4134	Radio Fiber Cables / Transceivers — 3-foot fiber cable with two optical transceivers used to interconnect the BCU to each RF Radio	frame-based eNodeB
AE	STKN4128	BCUII Power cable	frame-based eNodeB, Remote Based eNodeB
AF	STKN4130	Radio RF Cables — Transmit cable from the radio to the filter/duplexer	frame-based eNodeB
AG	SGKJ4000	50-Foot GPS Cable — 50-Foot RFGPS Cable	frame-based eNodeB, Remote Based eNodeB
AH	T472AC	76 m (250 ft), RGPS cable — Includes receiver and cables in pre-cut lengths	frame-based eNodeB, Remote Based eNodeB
	T472AE	304 m (998 ft), RGPS cable — Includes receiver and cables in pre-cut lengths.	
AI	Customer	DC power cable, VW-1 #8 - #10 AWG, 10 m (32.8 ft), UL temperature rating 105°C (167 °F).	Remote Based eNodeB
AK	3088961T10	Power cable, female connector on one end with two wires on the other end, 1000 mm +/-200 mm, 2 stranded cables/wires (black and red), 8 AWG	Remote Based eNodeB
AL	Customer	Ground cable, 6 AWG, length need determined by site configuration	frame-based eNodeB, Remote Based eNodeB
AM	CGDS19797321	Customer I/O cable, part of SGLN8484, connector on one end and loose wires on the other	frame-based eNodeB, Remote Based eNodeB
AN	Customer	Ethernet, RJ45 connectors, straight-through, shielded CAT5e, 90 m, max. 24 AWG solid conductor	frame-based eNodeB, Remote Based eNodeB

Tools required for installing the eNodeB components

The following tools are required to perform the installation of eNodeB components:

Torque wrenches:

- SMA Torque Wrench
- Type N connector torque wrench
- Torque driver capable of driving bits 1.1 N-m (10 in-lb), 1.3 N-m (12 in-lb), 1.8 N-m (16 in-lb), 4.7 N-m (42 in-lb), and 5.1 N-m (45 in-lb)
- Torque driver capable of torquing 10 mm socket to 5.1 N-m (45 in-lb)

Bit driver and bits:

- Bit driver
- T15 Torx bit
- T20 Torx bit
- T25 Torx bit
- T30 Torx bit
- T20 Torx security bit
- T30 Torx security bit
- Flat blade screwdriver bit

General tools:

- 10 mm socket
- 13 mm socket (to install M8 nuts on RRH)
- 19 mm socket (for M12 bolts)
- 3-inch socket extension
- 10 mm nut driver
- Wire strippers
- Cable insulation stripping tool (example: Greenlee 1900)

Recommended tools:

- Side cutters
- 6-inch bit driver extension

Frame-based eNodeB Installation

The procedures described in this chapter relate to the frame-based eNodeB system which is +27 V dc only.

Overview

- Operating Temperature – [Operating temperature range on page 2-10](#). Install the equipment in an environment compatible with the maximum ambient temperature of the equipment.
- Reduced Air Flow – Install the equipment in the rack such that the amount of air flow required for safe operation of the equipment is not compromised.
- Mechanical Loading – Mount the equipment in the rack to prevent a hazardous condition due to uneven mechanical loading.
- Circuit Overloading – Use appropriate equipment nameplate ratings when connecting the equipment to the supply circuit. Consider the effect that overloading of the circuits may have on over current protection and supply wiring.
- Reliable Grounding – Grounding of the rack-mounted equipment must be reliable. Pay attention to the supply connections other than the direct connections to the branch circuit (for example, use of power strips).

Plan the location of the LTE eNodeB system within the rack.

Figure 3-1 Indoor system

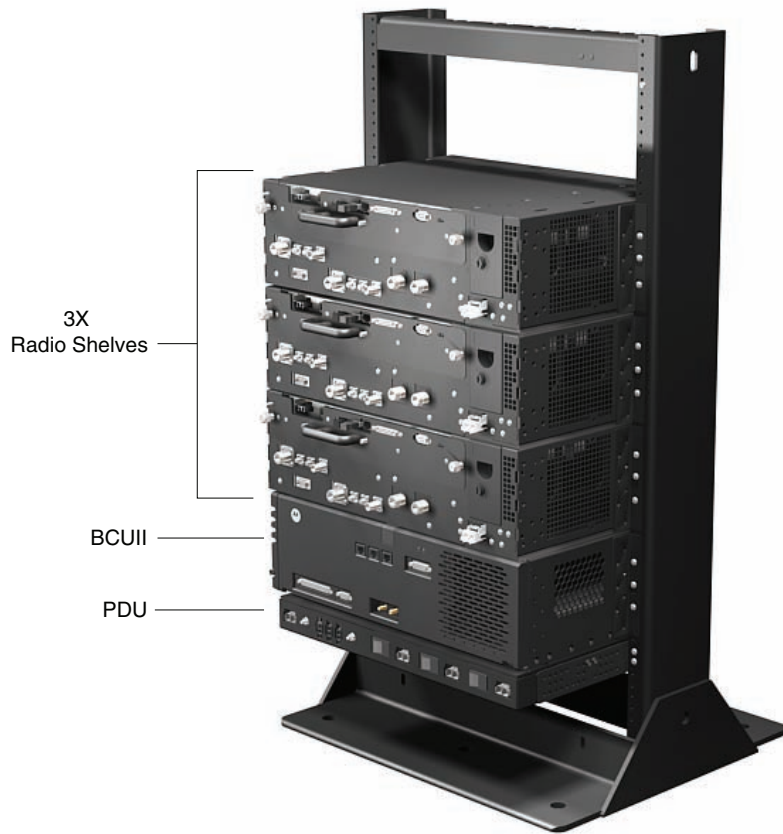

E1_majorcomponents_eNodeB.eps

Figure 3-2 Radio Frame Shelf

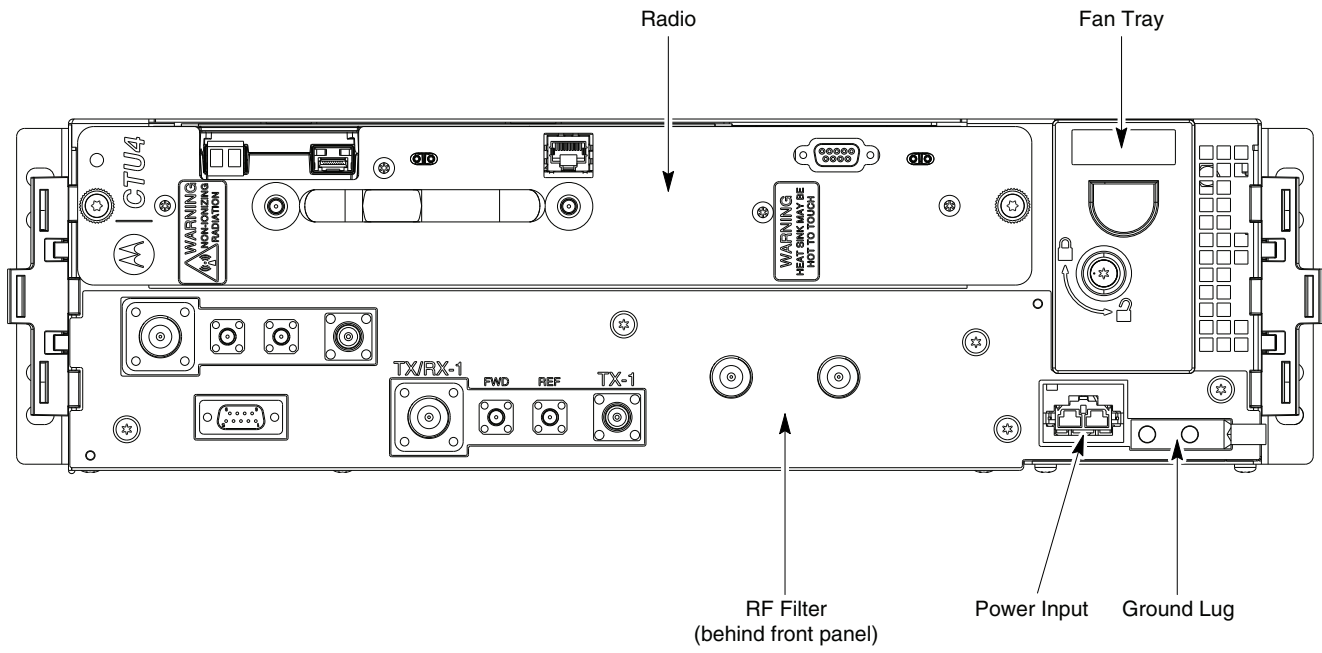

Unpacking Equipment

Verify the contents of all shipments for completeness, accuracy, and serviceability of all components before installation. The equipment is shipped with a packing list, listing all the parts shipped. On receiving the equipment, check the packing list to verify that all items are received. Check all cables for damage and all hardware for scratches and dents. Download or retrieve the appropriate documentation to install the product. Contact Motorola if any discrepancy exists between the packing list and the delivered material.

Installation of the rack

The Installation of the rack section provides procedures to install and ground the rack.

Rack and ground cable installation

The Rack and ground cable installation section provides the procedure to mount the standard 19-inch rack to the floor and install the ground cable.

The LTE system can be installed in a 19-inch rack supplied by Motorola or a customer-supplied rack. The Motorola rack is recommended, as it ensures that the proper ground path is achieved through chassis grounds through the PDU and Radio Filter Shelf mechanics without the use of separate ground cables. If a non-Motorola rack is used, a ground cable must be used for each of these components plus the BCUII, which requires a ground cable with any rack type.

An insulating pad is attached to the base of the rack to electrically isolate the rack from the floor.

Structural engineer prerequisite

Ensure that the procedure, tools, and equipment required to mount the rack to the floor are specified by a Structural Engineer.

Required items

The following items are required:

- Rack
- 10 mm socket
- 19 mm socket
- 6 plastic shoulder washers
- Torque driver
- Crimper tool - Anderson Power Products part number 1368 - Hydraulic hand tool, maximum cable size of 300 MCM.
- 6 carbon steel grade 8.8 bolts M12 or other bolts as determined by structural engineer - customer supplied.
- Other items, specified by the structural engineer, that are required to install the rack.
- Customer supplied ground cable, 6 AWG or larger diameter.
- Two-hole ground lug and mounting nuts - part of rack hardware kit.

Installing rack and ground cable

Perform the steps in [Procedure 3-1](#) to install the rack and ground cable.

Procedure 3-1 Installing rack and ground cable



1	<p>Mount the rack to the floor using the hardware, tools, and procedures defined by the structural engineer.</p> <p> NOTE</p> <p style="text-align: center;">Motorola recommends using carbon steel grade 8.8 M12 bolts.</p>
2	<p>Route the ground cable between the Master Ground Bar (MGB) and the rack.</p> <p> NOTE</p> <p style="text-align: center;">Ground cables must not have sharp bends.</p>
3	Strip insulation from the frame end of the ground cable.
4	<p>Attach the 2-hole lug to the rack-end of the ground cable.</p> <p style="text-align: center;">Either use the appropriate crimping tool or solder the lug to the cable.</p>
5	<p>Attach the end of the ground cable with the 2-hole lug to the two terminal studs at the top of the rack. Using 2 nuts, 10 mm socket and ratchet, tighten the nuts to 5.1 N-m (45 in-lb).</p> <p style="text-align: center;">Refer to Figure 3-3 for location of ground terminal studs on the rack.</p>
6	Cut the ground cable to length and connect it to the Master Ground Bar.
7	Verify that the Master Ground Bar is connected to a solid earth ground.

Figure 3-3 Location of ground terminals on a Motorola rack



Installing the +27 V dc (PDU)

The Installation of the Power Distribution Unit (PDU) section provides the procedure to install the PDU.

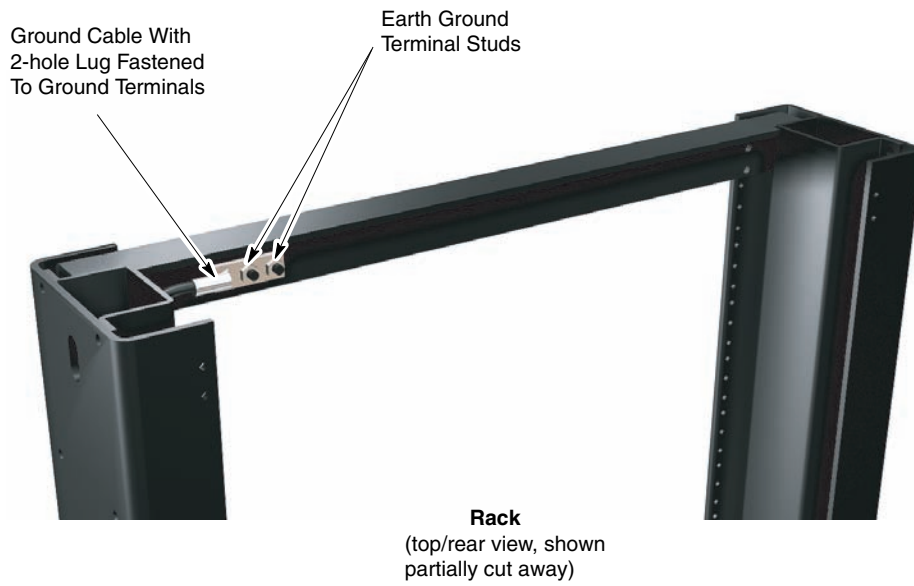
The connecting +27 V dc power section provides the following information:

- Attaching the contact/lugs, connector, and cable clamp on the +27 V dc power input cable wires.
- Connecting the +27 V dc input power cable to the rear of the PDU.
- Routing the loose ends of the wires to the site +27 V dc source for connection.

Required materials and tools

The following materials and tools are required:

- One +27 V dc Power Input Cable (DC) - customer supplied.

NOTE

Motorola recommends the use of Red wire for feed (+V) and Black wire for return (-V).

- Crimp tool appropriate for wire size and lug being used.
- Wire stripper/cutters.
- Digital Multi-Meter (DMM) Fluke Model 8062A with Y8134 test lead kit or equivalent; used for precision DC and AC measurements, requiring 4-1/2 digits.

Installing the PDU

Perform the following procedures in to install the PDU in the 19-inch rack.

Procedure 3-2 Adjusting Mounting Ears

1

NOTE

Use +27 V dc power PDU with the part number STLN6905

Continued

Procedure 3-2 Adjusting Mounting Ears (Continued)

2 Adjust the side ears as follows:

 **NOTE**

The PDU and all other LTE frame equipment can be mounted into the rack in a forward or rearward position. The PDU, BCUII, and Radio Filter Shelf are provided with mounting ears installed, so that these components are in the forward position in the rack.

If desired, the mounting ears can be changed, so the PDU resides in the rear position within the rack.

1. Disassemble the left and right mounting ears from the PDU side brackets using a T20 driver.
2. Reinstall the left and right mounting ears on the PDU side bracket at the front position using a T20 driver. Torque the M4 screws to 1.8 N-m (16 in-lb).

Perform the following procedure to install the PDU.

Procedure 3-3 Mounting PDU into Rack

1 Mount the PDU into the 19-inch rack as follows:
Use the screws provided with the PDU. If other screws are to be used, then obtain four screws which are at least 10 mm (3/8 inch) long.

 **NOTE**

The M5 screws are attached in a bag to the rear bracket.

2 Mount the PDU in the bottom most Rack Unit. Install two screws per side using a T25 Torx bit and torque to 4.7 N-m (42 in-lb).

Perform the following procedure to ground the PDU.

Procedure 3-4 Grounding PDU

1

 **NOTE**

Perform this step only if a non-Motorola rack is used. 19-inch racks that are painted on the 19-inch mounting rail front face require an external PDU ground cable.



Continued

Procedure 3-4 Grounding PDU (Continued)

	<p>The PDU is supplied with 2-hole crimp lugs for 1/0 AWG standard or 2 AWG high-strand count flex wire. If another type of cable is required, order a new lug as needed. The new lug and ground cable must equal the size determined for the DC Input Cables in the preceding steps. Ensure that the lug meets the criteria in Table 3-2.</p> <p>The expected load condition and cable length determines the wire gauge required for your system. See Table 2-2.</p>
2	Crimp the two-hole lug onto the Ground Cable.
3	Install the lug onto the PDU Rear Bracket. Secure the lug with two M6 Nylock nuts torqued to 5.1 N-m (45 in-lb).
4	Cut the ground cable to length and connect it to Master Ground Bar.

Perform the following procedure to connect power to the PDU.

Procedure 3-5 Connect the PDU to power

1	Ensure that the ground cable is connected between the rack and the Master Ground Bar.
2	Ensure that the +27 V dc Power Input Cable (DC) is not connected to the main +27 V dc power source. Turn off the main +27 V dc power source. Confirm that the power is switched OFF using a DVM.
3	<p>The PDU is supplied with 2-Hole crimp on lugs for 1/0 AWG standard or 2 AWG high-strand count flex cable. If you require another type of cable, order new lugs as needed. Ensure that the lugs meet the criteria in Table 3-2</p> <p> NOTE</p> <p>The expected load condition and cable length determine the wire gauge required for the system. See Table 2-2.</p>
4	Remove the lug cover and service cover using their respective snaps.
5	Insert the two-hole lugs through the rear of the PDU, so that the holes in the lugs align with the holes in the lug mounting plates.
6	<p>Install two M6 flat washers and two M6 x 16 screws into each lug (4 washers and 4 nuts total for the 2 lugs) using a T30 Torx driver.</p> <p> NOTE</p> <p>The flat washers and screws are supplied in the bags zip tied to the PDU rear bracket. Leave the screws loose so that the lugs can be adjusted side-to-side.</p>

Continued

Procedure 3-5 Connect the PDU to power (Continued)

7	Replace the lug cover while adjusting the cables to ensure that the cover can be snapped into position.
8	Tighten the lug screws to 5.1 N-m (45 in-lb) and replace the service cover.
9	Install zip ties around the cables through the rear bracket and pull tight for sufficient strain relief.
10	Connect the other end of the +27 Vdc power and return wires to the power source.

 **NOTE**

Do not turn on the power source at this time. This must be done after the installation and cabling is complete.

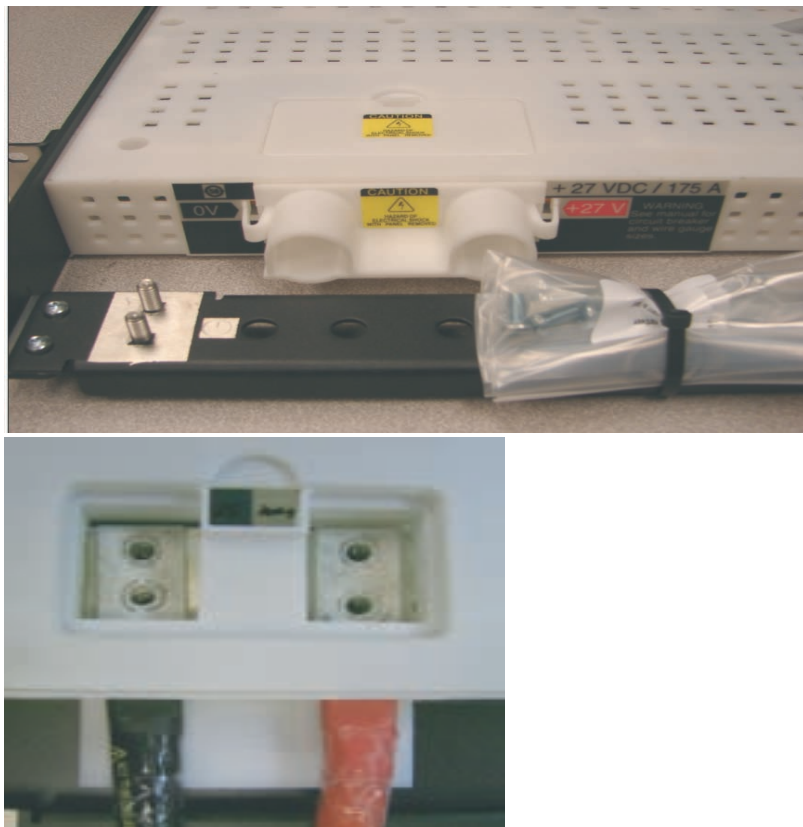
Figure 3-4 PDU power connection

ti-cdma-05694.eps

Table 3-1 Frame-based eNodeB cable connections to PDU breakers

Connector	Load
BKR 1	BCUII
BKR 2A	Auxiliary Equipment #1
BKR 2B	Auxiliary Equipment #2
BKR 2C	Auxiliary Equipment #3
BKR 3	Radio Sector 1
BKR 4	Radio Sector 2
BKR 5	Radio Sector 3

Figure 3-5 PDU Front



PDU front.eps

Table 3-2 Lug criteria

PDU input	LTE PDU input label text	Crimp lug's center – to – center spacing of M6 (1/4”) screw holes	Wire gauge compatibility for supplied lugs
+27 V dc	+27 V dc (red arrow)	19 mm (3/4 inch)	1/0 standard cable
	0V (black arrow)	16 mm (5/8 inch)	
Ground	Frame ground	16 mm (5/8 inch)	

Installation of the BCUII

The Installation of the BCUII section provides general information and procedures for installing a Base Control Unit II (BCUII).

BCUII is designed as an indoor component that can be mounted on a standard 19-inch rack. [Figure 3-6](#) shows the BCUII.

Figure 3-6 BCUII physical design

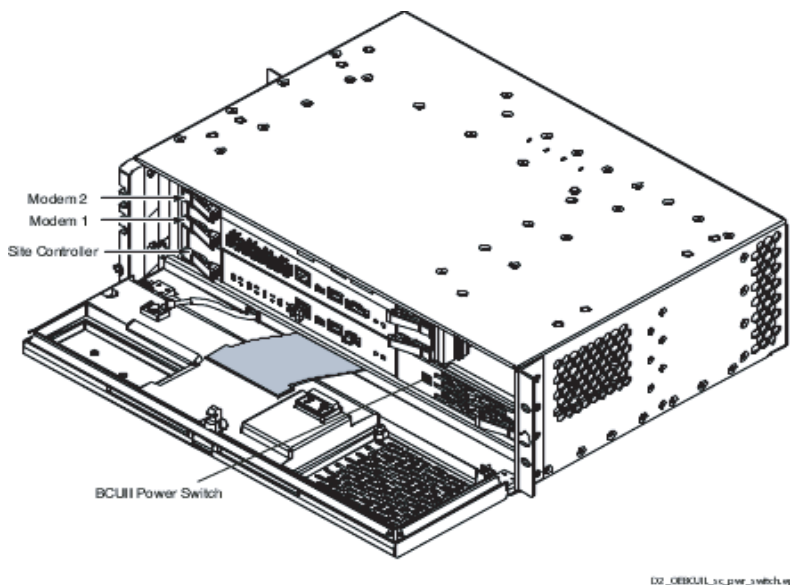

D2_OBBUII.sc.pwr_switch.ies

ti-odma-05694.eps

Required materials and tools



The following materials and tools are required:

- BCUII SG1756
- T15 driver
- T10 driver
- T25 torx bit
- 10 mm socket
- Customer supplied ground cable, length determined by distance from the unit to the master ground.

- Wire stripper/cutters.
- Digital Multi-Meter (DMM) Fluke Model 8062A with Y8134 test lead kit or equivalent; used for precision DC and AC measurements, requiring 4-1/2 digits.

BCUII installation

Procedure 3-6 Adjusting Mounting Ears

1	<p>Adjust the side ears as follows:</p> <p> NOTE</p> <p>The BCUII and all other LTE frame equipment can be mounted into the rack in a forward or rearward position. The PDU, BCUII, and Radio Filter Shelf are provided with mounting ears installed, so that these components are in the forward position in the rack.</p> <p>If desired, the mounting ears can be changed, so the BCUII resides in the rear position within the rack.</p> <ol style="list-style-type: none"> 1. Disassemble the left and right mounting ears from the BCUII side brackets using a T10 driver. 2. Reinstall the left and right mounting ears on the BCUII side bracket at the front position using a T10 driver. Torque the M3 screws to 1.12 N-m (10 in-lb). <p> NOTE</p> <p>Left mounting ear goes to the right side and the right mounting ear goes to the left side.</p>
----------	---

Perform the steps in [Procedure 3-7](#) to install power cables to the BCUII.

Procedure 3-7 Cabling Power to BCUII

1	Strip each wire 12.7 mm (1/2 inch).
2	Insert wires according to the color code on the back of the BCUII. Tighten the screws to 1.3 N-m (12 in-lb). See Figure 3-7 .
3	Plug the black 2-pin connector into the front of the PDU Brkr 1. Route the cable with the green screw terminal connector towards the rear over the left mounting ear.

Continued

Procedure 3-7 Cabling Power to BCUII (Continued)

4	Thread the cable through the slot in the left side bracket just behind the plastic housing and across the rear of the PDU.
5	Install the BCUII in the rack.  NOTE The power cable must be plugged into BCUII during the BCUII installation procedure.

Figure 3-7 Cabling Power to +27 V dc BCUII



-27V.eps

Perform the steps in [Procedure 3-8](#) to install the BCUII.

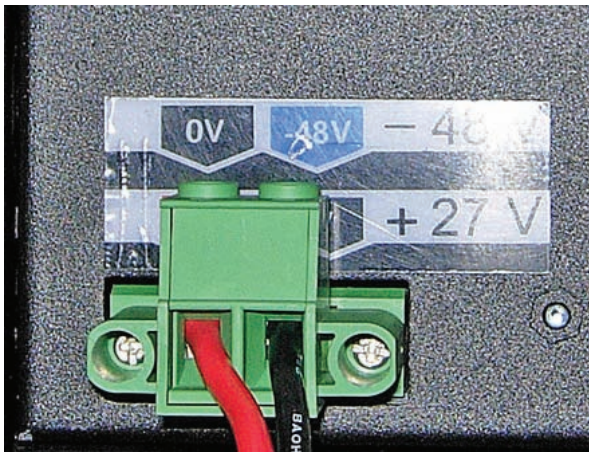
Procedure 3-8 BCUII Installation

1	Place a rack mounting screw in the fifth hole above the PDU right ear bracket. Leave the screw head spaced out from the rack face to allow for the BCUII mounting ear to be installed over the screw head.
2	Place a rack mounting screw in the fifth or sixth hole above the PDU left ear bracket. Leave the screw head spaced out from the rack face to allow the BCUII mounting ear to be installed over the screw head.

Continued

Procedure 3-8 BCUII Installation (Continued)

3	Hang the BCUII on the two mounting screws and mate the green two-position Screw Terminal Connector into the BCUII Power Supply on the rear. Tighten the two retaining screws into the mating connector to 1.3 N-m (12 in-lb).
4	Use a T25 torx bit to install the remaining (two screws per side) rack mounting screws. Torque all rack mounting screws to 4.7 N-m (42 in-lb).

Connecting Ground to BCUII

Perform the steps in [Procedure 3-9](#) to connect the ground cable to BCUII.

Procedure 3-9 Connecting ground to BCUII

1	Remove the ground lug from the left inside wall using a 10 mm socket or nut driver.
2	Crimp the BCUII ground lug onto a 6 AWG wire.
3	Attach the ground wire double hole lug to the threaded studs located at the BCUII card cage front left corner. Secure the ground wire lug to the threaded studs with the two M6 nuts. Using a 10 mm socket and torque driver, tighten the nuts to 5.1 N-m (45 in-lb).
4	Connect the other end of the ground wire to the master ground bar.



NOTE
 Do not reinstall fiber cover (feed through plate) at this time. Set it aside for safe keeping until the fiber installation is completed later.

Figure 3-8 BCUII Grounding

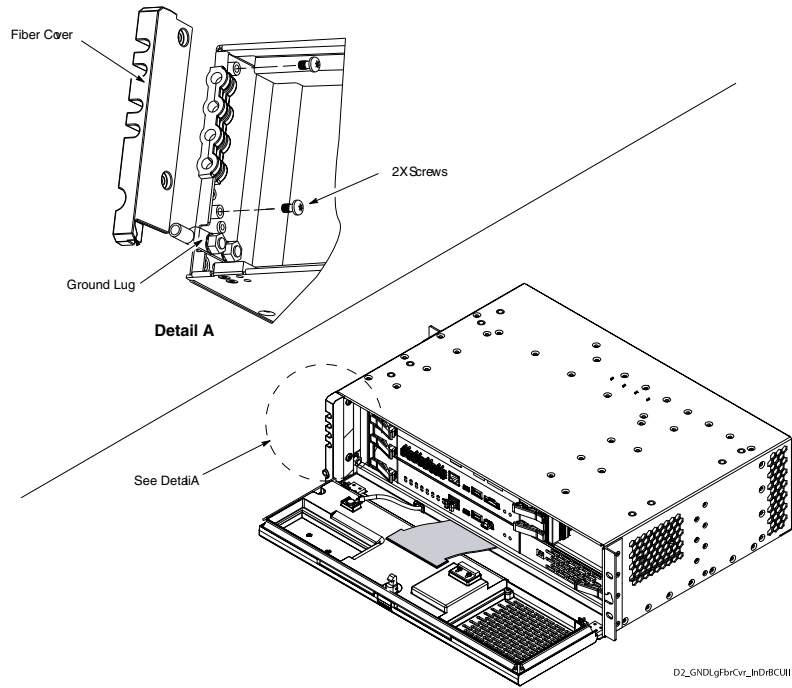
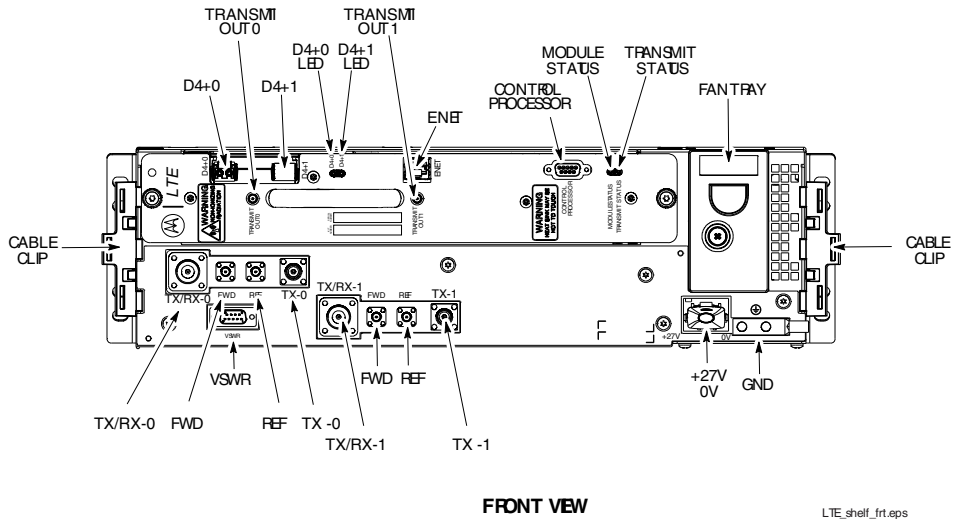

Installation of Radio/Filter Shelf (RFS) and Frame Mounted Radio Head

Figure 3-9 Radio/Filter Shelf



This section provides the procedure to install the Radio/Filter Shelf (RFS).

The following materials and tools are required:

- RFS STLN6903
- RF Head STWF 4000
- Customer supplied ground cable, length determined by distance from the unit to the master ground (required only if not using the Motorola provided rack).
- T20 Torx bit
- 10 mm socket
- T25 Torx bit
- Wire stripper/cutters

Perform the following procedure to install the RFS Duplexer.

Procedure 3-10 Installing RFS Duplexer

1	Move the two RF cables out of the way. Insert the Duplexer into the RFS.
2	Pull the Duplexer towards the front, so the Duplexer body rests against the inside front face of the RFS chassis.
3	Using a T20 Torx, screw two M4 screws through the front face of the RFS into the Duplexer body. Torque to 2.25 N-m (20 in-lb).
4	With a 10 mm socket and 3-inch socket extension, secure the Duplexer to the two M6 studs in the bottom of the RFS shelf with two M6 nuts. Torque to 5.1 N-m (45 in-lb).
5	Mate the two RF cables at the rear of the Duplexer. Ensure that the cable bends are no less than 6 mm (1/4 inch) radius.



Figure 3-10 Installing Duplexer



e1_eNodeB_RFS_insert_duplexer.tif

The RFS can be mounted into the rack in a forward or rearward position. The RFS is provided with the mounting ears installed so that it is in the forward position in the rack.

Procedure 3-11 Adjusting Mounting Ears

1	 NOTE Use RFS with the part number STLN6903.
2	Adjust the side ears as follows:  NOTE The Radio Filter Shelf and all other LTE frame equipment can be mounted into the rack in a forward or rearward position. The PDU, BCUII, and RFS are provided with mounting ears installed, so that these components are in the forward position in the rack. If desired, the mounting ears can be changed, so the RFS resides in the rear position within the rack. <ol style="list-style-type: none"> 1. Disassemble the left and right mounting ears from the RFS side brackets using a T20 driver. 2. Reinstall the left and right mounting ears on the PDU side bracket at the front position using a T20 driver. Torque the M4 screws to 2.25 N-m (20 in-lb).  NOTE The left mounting ear goes to the right side and the right mounting ear goes to the left side.

Procedure 3-12 Installing RFS

1	For both the left and right side of the 19-inch rack, install one rack mounting screw in the fifth hole above the BCUII Mounting Ear Bracket. Leave the screw head spaced out from the rack face to allow the BCUII Mounting Ear to be installed over the screw head.
2	With the RFS oriented so that the Duplexer is towards the bottom, install the RFS so that the center keyhole in the Side Mounting Bracket slips over the rack mounting screws installed in step 1 .
3	Secure the RFS to the rack. Use a T25 Torx bit to install the remaining rack mounting screws to 4.7 N-m (42 in-lb).

Perform the following procedure to install the Fame Mounted Radio Head.

Procedure 3-13 Installing Frame Mounted Radio Head

1	With the Radio oriented with the handle to the left, slide the Radio into the RFS until fully seated.
2	Using a T20 Torx, screw the two black thumbscrews on the front of the Radio into the RFS. Torque to 2.25 N-m (20 in-lb).

RFS power cable installation

One power cable is required per RFS.

Perform the steps in [Procedure 3-14](#) to install the DC power cable to the RFS.

Procedure 3-14 Installing RFS power cable

1	Plug the RFS cables into the PDU breakers 4, 5, and 6. Make the connections per the information in Table 3-1 , where sector 1 is the bottom-most RFS in the frame.
2	Install cable tie brackets to the radio filter shelf (snap in place). Use zip ties to tie the power cables to the cable tie brackets as shown in Figure 3-11 .

Figure 3-11 Tying power cables to the cable tie brackets

RFS Ground Cable Installation

Perform the steps in [Procedure 3-15](#) to add an external ground cable to the RFS.

NOTE

Execute [Procedure 3-15](#) only if the rack is not a Motorola rack. The Motorola rack has no paint on the 19-inch mounting rail front face. Ground current can travel through the PDU chassis to the frame ground lug. Other 19-inch racks that have paint on the 19-inch mounting rail front face require an external RFS ground cable.

Procedure 3-15 Installing RFS ground cable

1	Crimp the 2-hole crimp lug onto the customer supplied ground cable. NOTE The RFS is supplied with 2-hole crimp lugs for 6 AWG standard wire.
2	Install the lug onto the RFS.
3	Using a 10 mm socket and driver, secure the lug with 2 M6 nuts torqued to 5.1 N-m (45 in-lb).

Figure 3-12 RFS ground cable connection

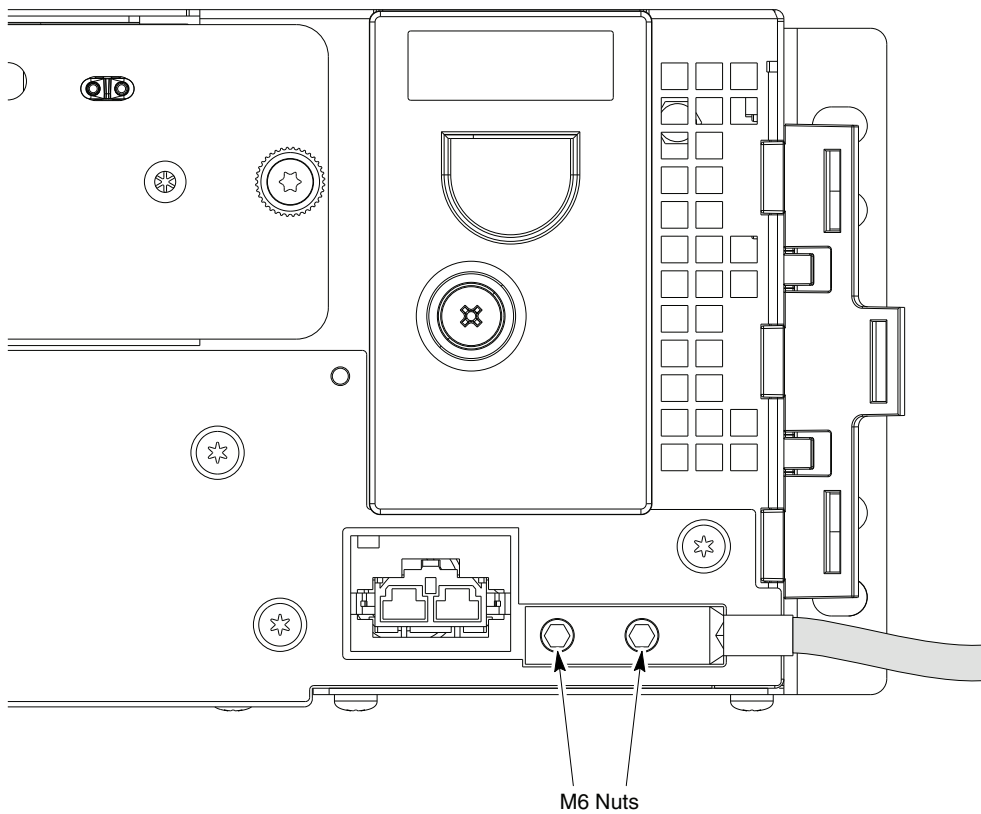

Installation of the GPS

Installing RFGPS antenna and cable

Figure 3-13 shows the components of the RFGPS (RFGPS).

When mounting the RFGPS Antenna consider the following items:

- The mounting pipe for the RFGPS head is mounted vertically with less than five (5) degrees of tilt.
- The RFGPS head requires a clear view of the sky, preferably within ten (10) degrees of the horizon in all directions.
- The more sky that is observed increases the number of potential satellites that can be tracked, resulting in better RFGPS performance.
- During normal operation, the RFGPS head continuously tracks a minimum of four (4) GPS satellites. However, it is theoretically possible to operate the BTS by tracking only one (1) GPS satellite. Motorola does not recommend tracking only one (1) GPS satellite unless there has been an accurate site survey.
- Place the RFGPS head where RF obstructions of the sky are minimal. The sky includes everything within ten (10) degrees of the horizon in all directions. RF obstructions include buildings, towers, natural rock formations, snow, foliage, and debris.

Perform the following procedure to install local GPS (RFGPS):

Procedure 3-16 Installing RFGPS antenna and cabling

1	Determine the location for the RFGPS Surge Protection device (preferably at the entrance to the building).
2	Connect the RFGPS Surge Protection device to the master ground bus (MGB).
3	Determine the mounting location.
4	<div style="border: 1px solid black; padding: 5px;">  CAUTION <p>Ensure that a qualified structural engineer verifies the roof structure on which the mounting pole is attached for the weight of the RFGPS engine and mounting hardware under adverse conditions in the installation area.</p> <p>Install the mounting kit at the RFGPS location. Use the appropriate mounting bolts for mounting surface.</p> </div>

Continued

Procedure 3-16 Installing RFGPS antenna and cabling (Continued)

5	Attach the RFGPS antenna assembly to the mounting bracket and secure the washer and custom nut supplied. See Figure 3-13 .
6	Attach the grounding kit to the mounting pole with U-bolts and secure using the washers and nuts supplied. See Figure 3-13 .
7	Connect the N connector of the 50 ft (15.24 m) superflex cable to the RFGPS antenna cable.
8	Route the other end of the superflex cable down the pole and to the RFGPS Surge Protection device. Connect the cable to the RFGPS Surge Protection device. Secure cable using cable ties where appropriate.
9	Attach one end of a cable (customer supplied) to the RFGPS Surge Protection device and the other end to the RFGPS connector on the BCUII. The BCUII connector is an SMA style connector. Secure cable using cable ties where appropriate.

Figure 3-13 RFGPS installation and components diagram

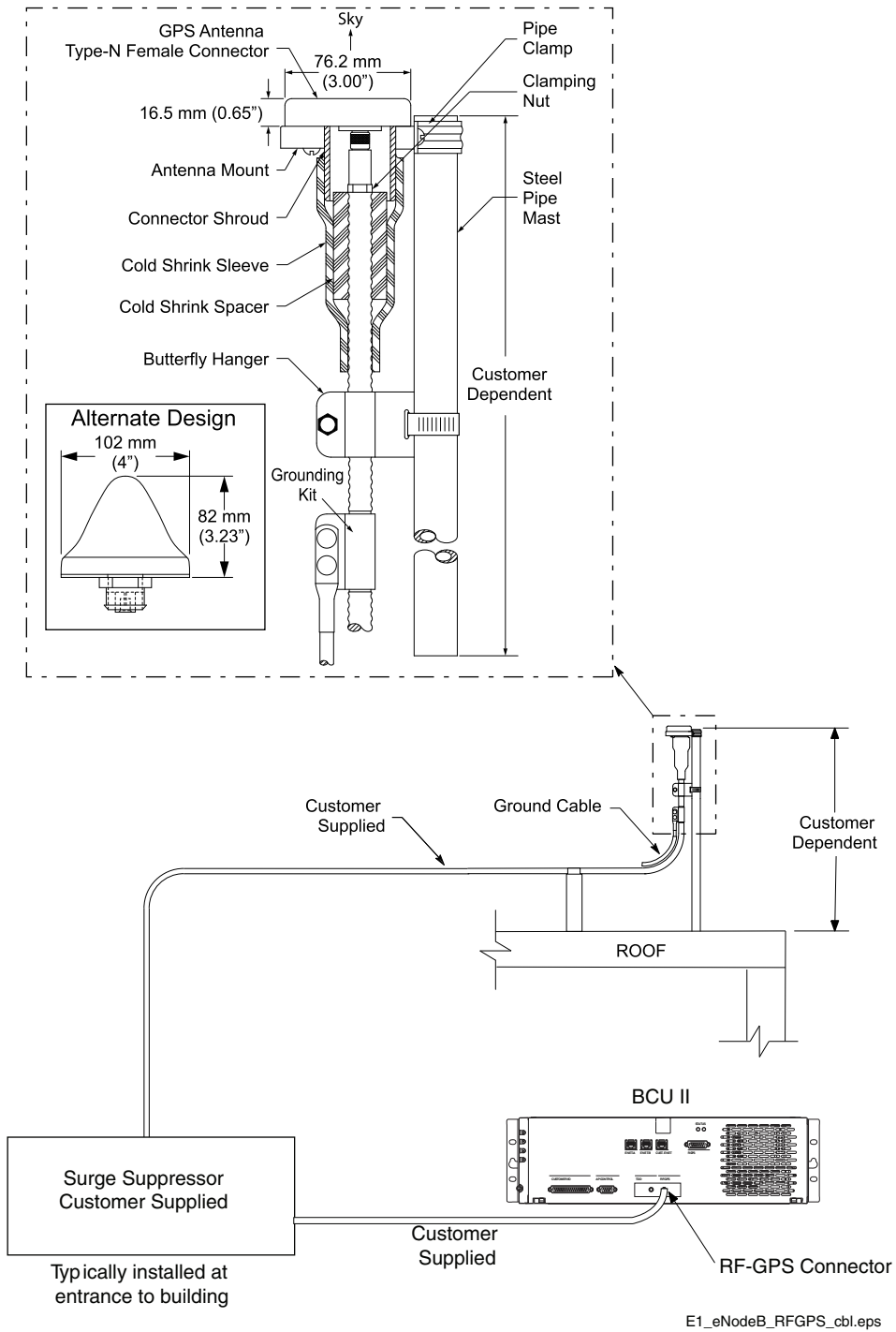

Optional equipment

This section contains general information and procedures for installing the optional equipment.

Quartz-high stability oscillator

The Quartz high stability oscillator (Q-HSO) is available as an optional equipment to accommodate customers with the backup timing module. Since it is optional, the Q-HSO may not be present in all installations. However, if it is initially ordered it is installed at the factory.

Figure 3-14 BCUII Q-HSO unit

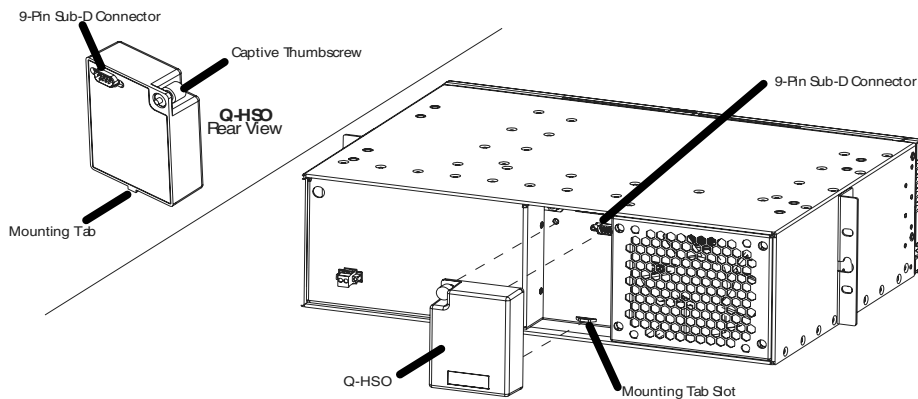

ti-cdma-05694.eps

ti-cdma-05694.eps

If the Q-HSO is not factory installed, perform the steps [Procedure 3-17](#) to install the unit.

Procedure 3-17 Q-HSO installation

1	Install the Q-HSO by inserting the tab into the slot in the BCUII. Refer to Figure 3-14 . Push the Q-HSO until it seats in the D-type connector at the rear of the tray.
2	Use a T20 Torx bit to install the Q-HSO. Torque to 2.25 N-m (20 in-lb)
3	<div style="display: flex; align-items: flex-start;"> <div style="margin-right: 10px;">  </div> <div> <p>NOTE</p> <p>The Q-HSO must warm up for 60 minutes to reach a steady state before it can take over for a failed GPS signal. If the active site controller card reboots during the 60 minute warm-up period, the timer is reset, and the Q-HSO must warm up for another 60 minutes before use.</p> <p>The REF FAULT LED on the BCUII controller card lights when the Q-HSO is first installed but turns off by the time it is warmed up.</p> </div> </div>

Installation of the indoor portions of the Remote RF based eNodeB

Installation of the BCUII

The Installation of the BCUII section provides general information and procedures for installing a Base Control Unit II (BCUII).

BCUII is designed as an indoor component that can be mounted on a standard 19-inch rack. [Figure 4-1](#) shows the BCUII.

Figure 4-1 BCUII physical design

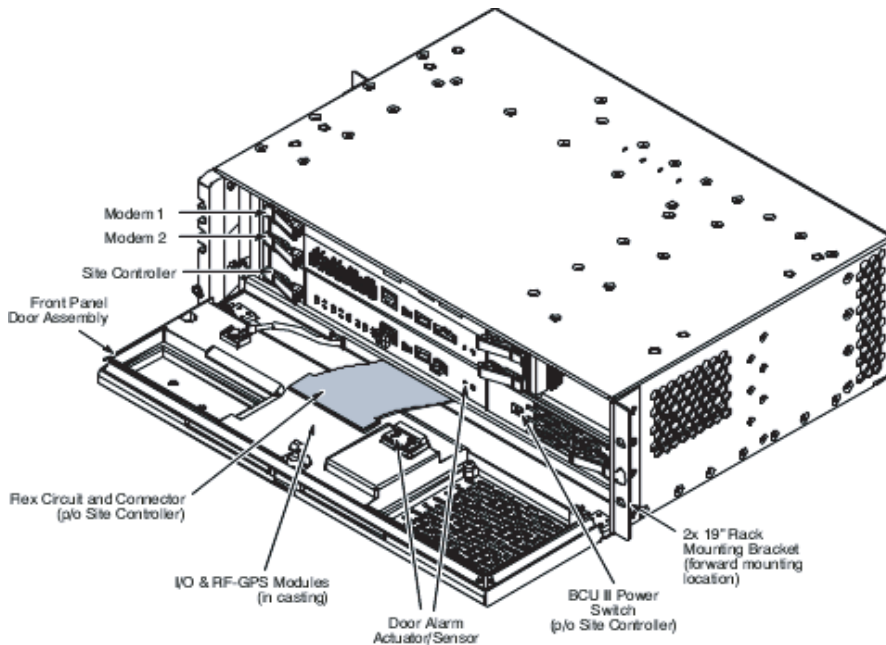

ti-cdma-05694.eps



Required materials and tools

The following materials and tools are required:

- BCUII SG1756
- T15 driver
- Customer supplied ground cable, length determined by distance from the unit to the master ground.
- Wire stripper/cutters.
- Digital Multi-Meter (DMM) Fluke Model 8062A with Y8134 test lead kit or equivalent; used for precision DC and AC measurements, requiring 4-1/2 digits.

BCUII installation

Procedure 4-1 Adjusting Mounting Ears

1	<p>Adjust the side ears as follows:</p> <p> NOTE</p> <p>The BCUII and all other LTE frame equipment can be mounted into the rack in a forward or rearward position. The PDU, BCUII, and Radio Filter Shelf are provided with mounting ears installed, so that these components are in the forward position in the rack.</p> <p>If desired, the mounting ears can be changed, so the BCUII resides in the rear position within the rack.</p> <ol style="list-style-type: none"> 1. Disassemble the left and right mounting ears from the BCUII side brackets using a T10 driver. 2. Reinstall the left and right mounting ears on the BCUII side bracket at the front position using a T10 driver. Torque the M3 screws to 1.12 N-m (10 in-lb) . <p> NOTE</p> <p>The left mounting ear goes to the right side and the right mounting ear goes to the left side.</p>
----------	--

Perform the steps in [Procedure 4-2](#) to install power cables to the BCUII.

Procedure 4-2 Cabling Power to BCUII

1	Strip each wire 12.7 mm (1/2 inch).
2	Insert wires according to the color code on the back of the BCUII. Tighten the screws to 1.3 N-m (12 in-lb). See Figure 4-2
3	Plug the black 2-pin connector into the front of the PDU Brkr 1. Route the cable with the green screw terminal connector towards the rear over the left mounting ear.
4	Thread the cable through the slot in the left side bracket just behind the plastic housing and across the rear of the PDU.
5	<p>Install the BCUII in the rack.</p> <p> NOTE</p> <p>The power cable must be plugged into BCUII during the BCUII installation procedure.</p>

Figure 4-2 Cabling Power to -48 Vdc BCUII



-48V.eps

Perform the steps in [Procedure 4-3](#) to install the BCUII.

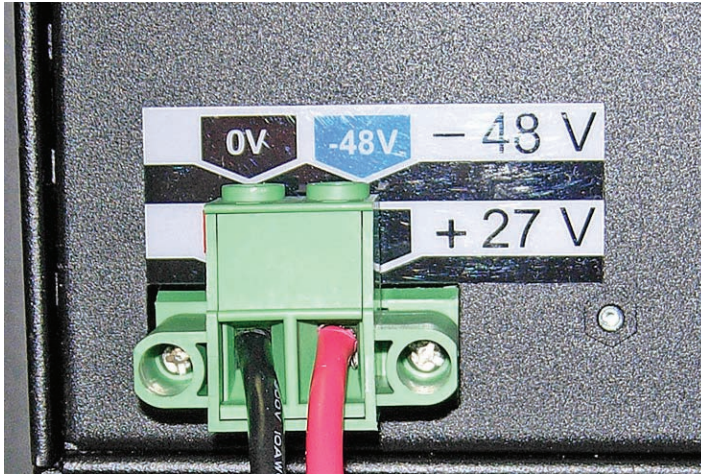
Procedure 4-3 BCUII Installation

1	Place a rack mounting screw in the fifth hole above the PDU right ear bracket. Leave the screw head spaced out from the rack face to allow for the BCUII mounting ear to be installed over the screw head.
2	Place a rack mounting screw in the fifth or sixth hole above the PDU left ear bracket. Leave the screw head spaced out from the rack face to allow the BCUII mounting ear to be installed over the screw head.
3	Hang the BCUII on the two mounting screws and mate the green two-position Screw Terminal Connector into the BCUII Power Supply on the rear. Tighten the two retaining screws into the mating connector to 1.3 N-m (12 in-lb).
4	Use a T25 torx bit to install the remaining (two screws per side) rack mounting screws. Torque all rack mounting screws to 4.7 N-m (42 in-lb).

Connecting Ground to BCUII

Perform the steps in [Procedure 4-4](#) to connect the ground cable to BCUII.

Procedure 4-4 Connecting ground to BCUII

1	Remove the ground lug from the left inside wall using a 10 mm socket or nut driver.
2	Crimp the BCUII ground lug onto a 6 AWG wire.

Continued

Procedure 4-4 Connecting ground to BCUII (Continued)

3	<p>Attach the ground wire double hole lug to the threaded studs located at the BCUII card cage front left corner.</p> <p>Secure the ground wire lug to the threaded studs with the two M6 nuts. Using a 10 mm socket and torque driver, tighten the nuts to 5.1 N-m (45 in-lb).</p>
4	<p>Connect the other end of the ground wire to the master ground bar.</p> <p> NOTE</p> <p style="padding-left: 40px;">Do not reinstall fiber cover (feed through plate) at this time. Set it aside for safe keeping until the fiber installation is completed later.</p>

Figure 4-3 BCUII Grounding



Installation of the RRH

Installing the Remote Radio Head

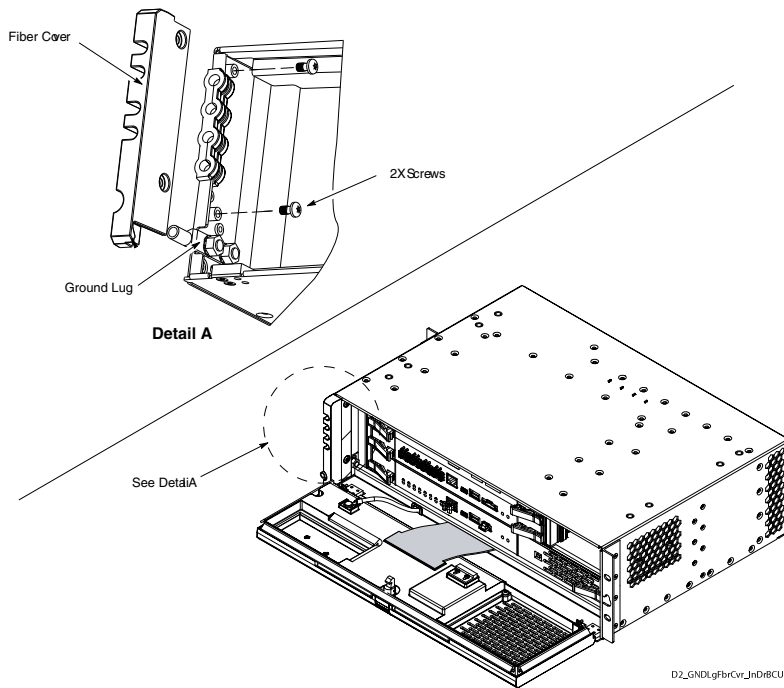
The Remote Radio Head (RRH) is available in three models:

- 700 MHz
- 2.1 GHz
- 2.6 GHz

Installing the 700 MHz RRH

The 700 MHz RRH can be configured in two ways:

- Wall mount configuration
- Pole mount configuration

Perform the following procedure to install the 700 MHz RRH to a wall.

Procedure 5-1 700 MHz RRH wall mount configuration

-
- | | |
|----------|---|
| 1 | Drill four holes of the appropriate size into the wall for the wall mount anchors as recommended by the structural engineer. Drill the holes in the locations as shown. |
|----------|---|

Continued

Procedure 5-1 700 MHz RRH wall mount configuration (Continued)

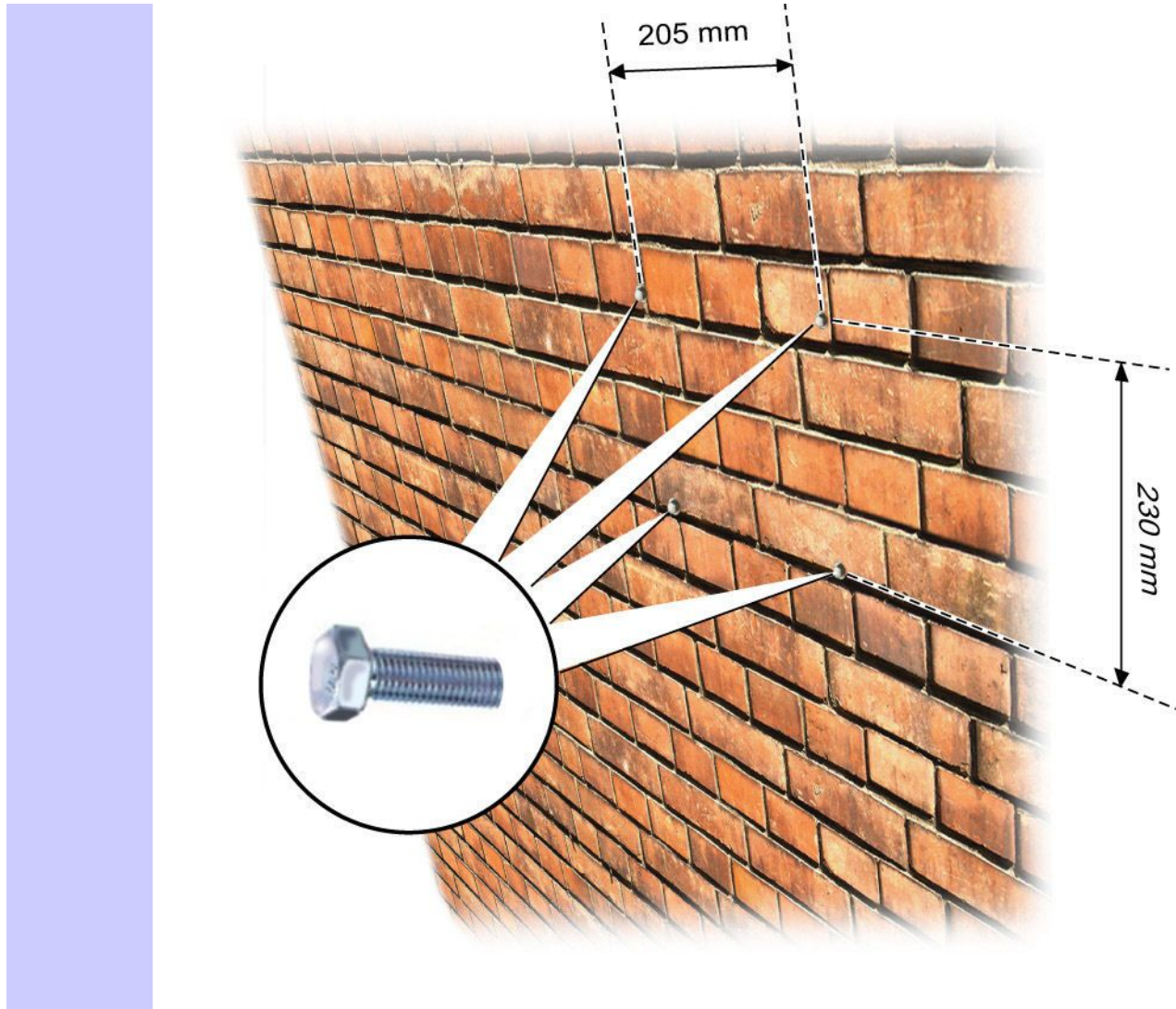

- 2 Install the top two M8 bolts in the top two slots on the wall. Bolts should not be tightened. Bolt heads should be spaced at least 15 mm from the wall. **Continued**

Procedure 5-1 700 MHz RRH wall mount configuration (Continued)**NOTE**

Ensure that a qualified structural engineer verifies the wall structure and wall-mount installation for the weight of the installation under adverse conditions in the installation area.

- 3** Hang the wall mount bracket, inserting the two M8 bolts into the keyhole slots. Slide the bracket into the final location.
- 4** Insert two M8 bolts in the bottom two slots and tighten them using a 13 mm socket. Tighten the initial two bolts installed in [step 2](#) using a 13 mm socket.

NOTE

Torque setting for bolts must comply with the value recommended by the manufacturer of the wall anchors.

M8 x 50 bolts are provided. However, other fasteners may be necessary per the recommendations of the structural engineer.

Continued

Procedure 5-1 700 MHz RRH wall mount configuration (Continued)

- 5 Fix the 700 MHz securing plate to the back of the 700 MHz unit. Using a T30 security Torx driver, tighten the captive M6 fastener to a minimum torque of 5.1 N-m (45 in-lbs).

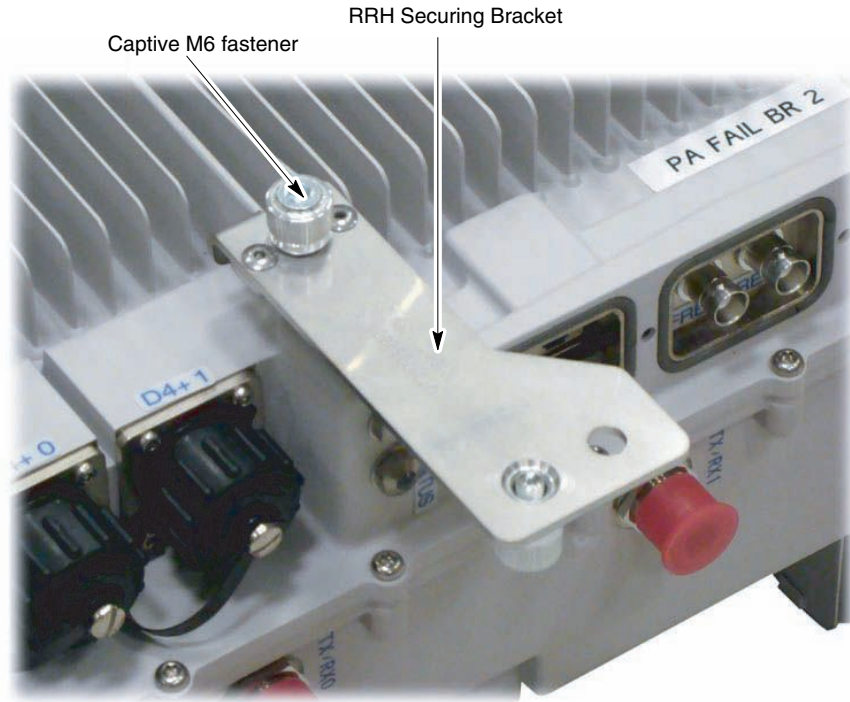

NOTE

The securing bracket is shipped in the same packaging as the wall mounting bracket.

Continued

Procedure 5-1 700 MHz RRH wall mount configuration (Continued)

- 6** Insert the RRH into keyholes on the bracket using the mounting feet.

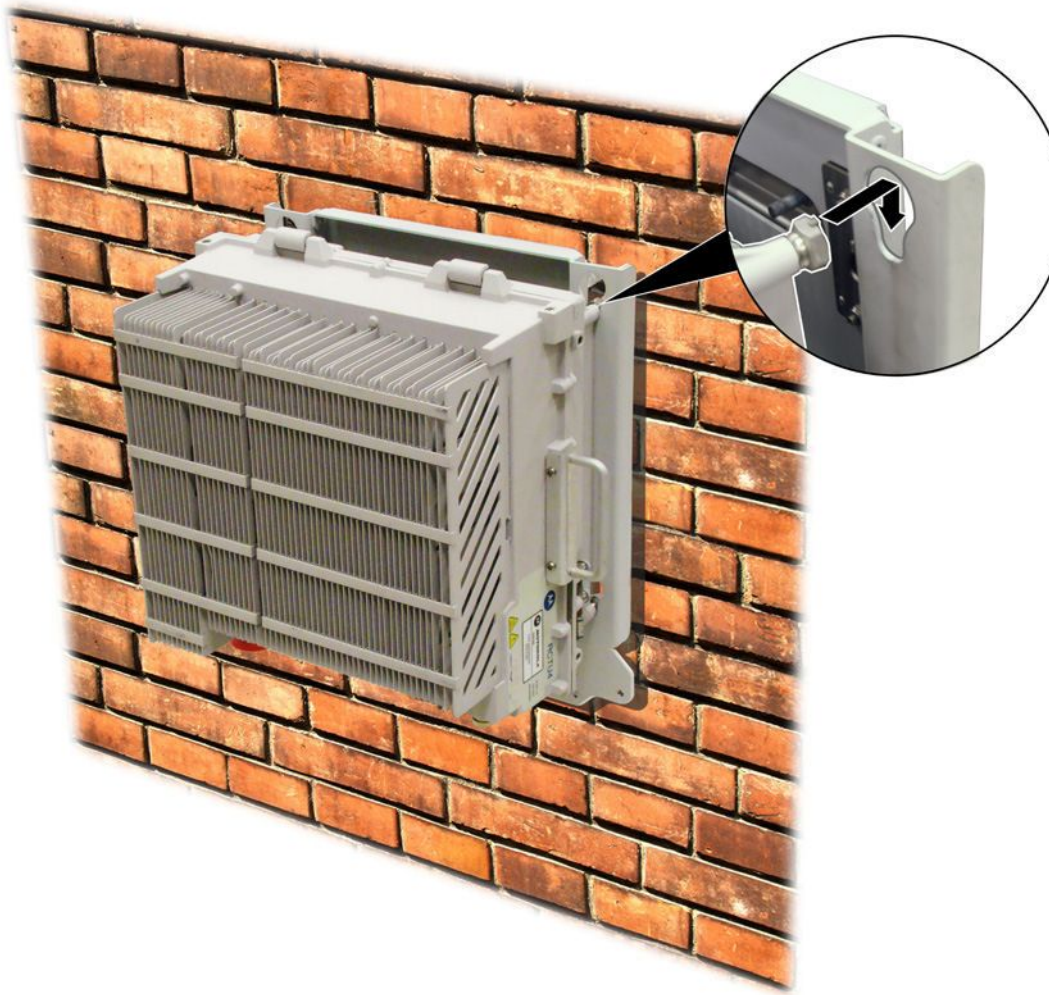

Continued

Procedure 5-1 700 MHz RRH wall mount configuration (Continued)

- 7** Fix the securing bracket to the wall mount bracket. Tighten the captive M6 fastener using a T30 security TORX driver to a minimum torque of 5.1 N-m (45 in-lbs).

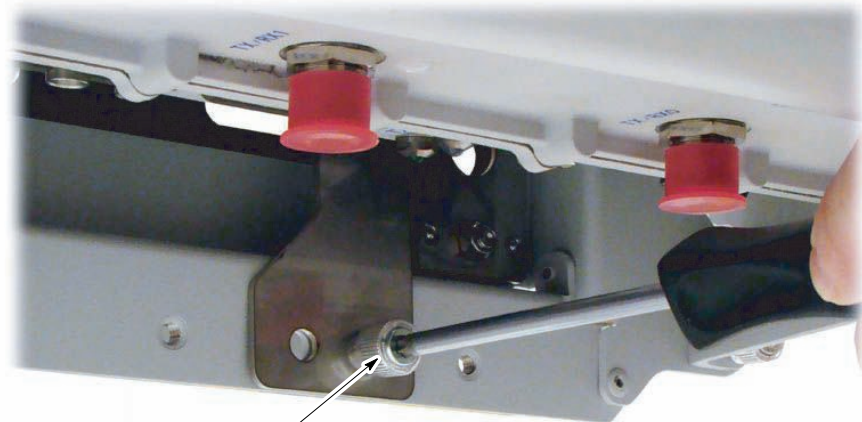

Captive M6 fastener

- 8** Using a T25 Torx driver, remove the handles after installation of the RRH.

Continued

Procedure 5-1 700 MHz RRH wall mount configuration (Continued)

- 9** Fit the solar cover by inserting the hinges on the RRH into the recesses in the top panel of the cover.



- 10** Secure the solar cover with M6 captive fasteners located in each bottom corner. Tighten the fastener using a T30 security TORX driver to a minimum torque of 5.1 N-m (45 in-lbs).

Continued

Procedure 5-1 700 MHz RRH wall mount configuration (Continued)

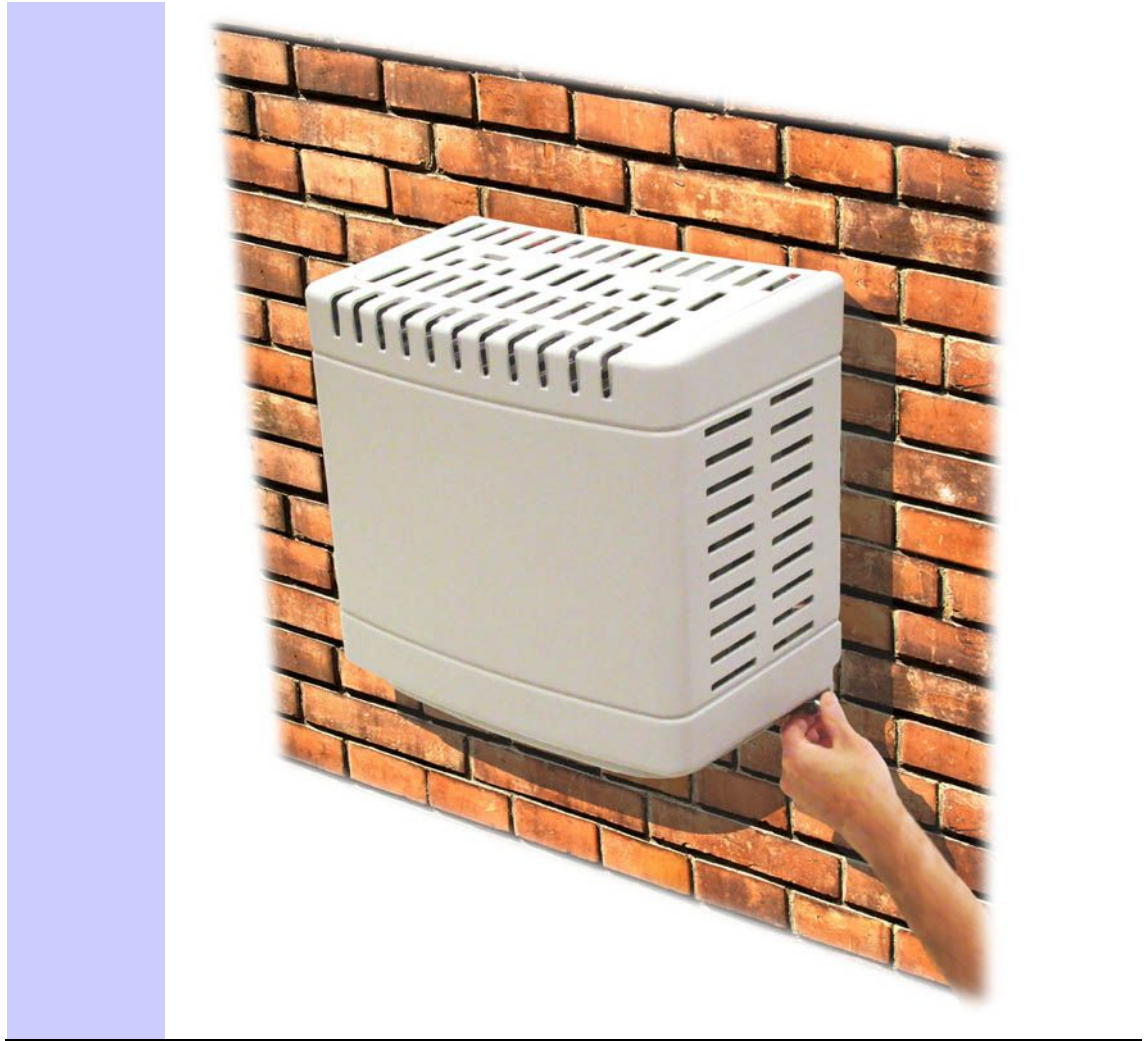

700 MHz RRH pole mount configuration

Perform the following procedure to install the 700 MHz RRH to a pole.

Procedure 5-2 700 MHz RRH pole mount configuration

- | | |
|---|--|
| 1 | <p>Fix the pole mounting brackets to the pole with U-bolts or banding straps. If banding straps are used:</p> <ul style="list-style-type: none"> • Install each pole mount bracket with a steel strap. Tighten the steel straps with banding tools. Follow the instructions of the specified banding tool from BAND-IT to tighten the steel straps. |
|---|--|

Continued

Procedure 5-2 700 MHz RRH pole mount configuration (Continued)

- Motorola recommends the BAND-IT C00169 tool.

NOTE

Ensure that a qualified structural engineer verifies the pole structure and pole-mount installation for the weight of the installation under adverse conditions in the installation area.

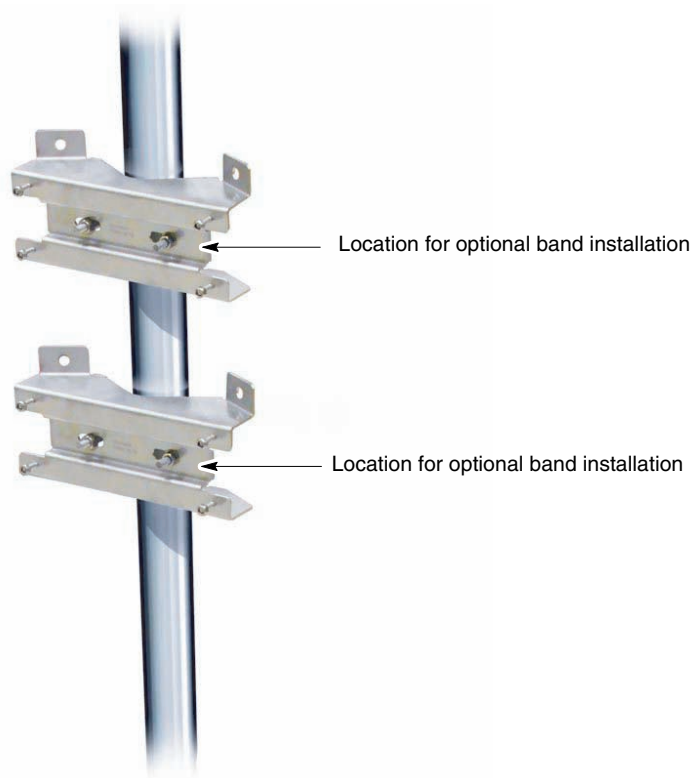

Continued

Procedure 5-2 700 MHz RRH pole mount configuration (Continued)

-
- | | |
|---|---|
| 2 | Secure the pole mount brackets with eight M6 bolts to the wall mounting bracket. Torque to 5.1 N-m (45 in-lb) using a 10 mm socket. |
|---|---|
-

Continued

Procedure 5-2 700 MHz RRH pole mount configuration (Continued)

- 3** Fix the 700 MHz securing bracket to the back of the 700 MHz unit. Using a T30 security Torx driver, tighten the captive M6 fastener to a minimum torque of 5.1 N-m (45 in-lbs).

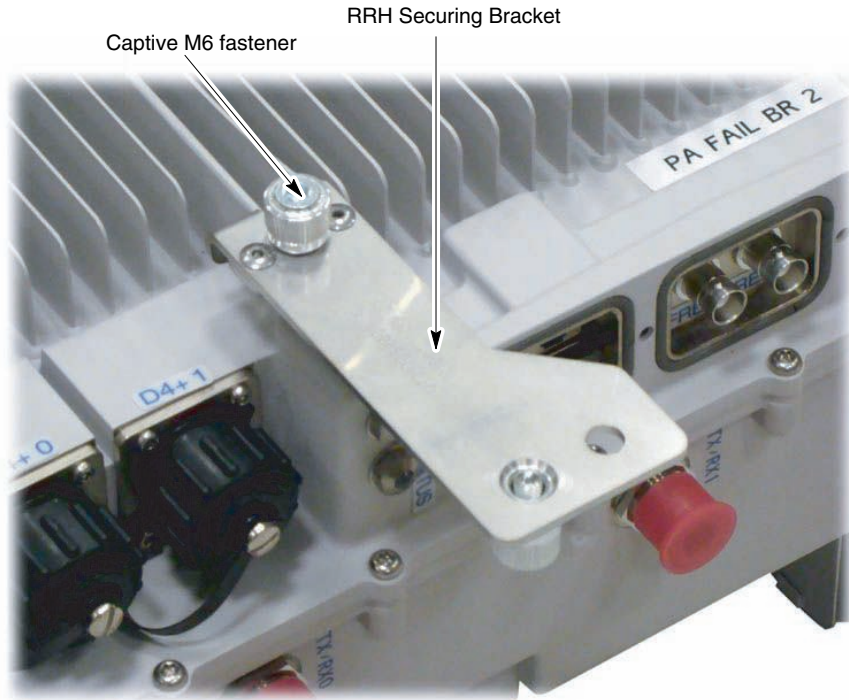

NOTE

The securing bracket is shipped in the same packaging as the 700 MHz RRH and wall mount bracket.

Continued

Procedure 5-2 700 MHz RRH pole mount configuration (Continued)

- 4** Insert the 700 MHz RRH into keyholes on the bracket using the mounting feet.

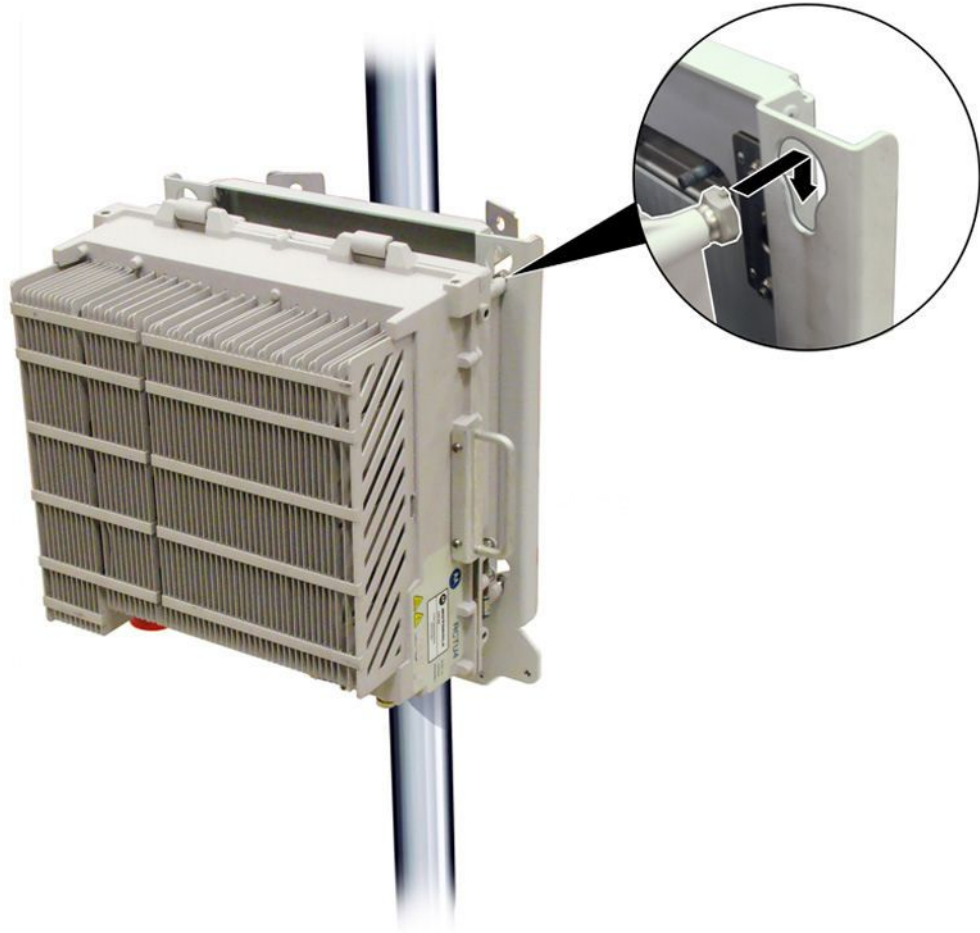

- 5** Fix the securing brackets to the pole mount bracket. Using a 10 mm socket TORX driver, tighten the eight captive M6 fasteners to a minimum torque of 5.1 N-m (45 in-lbs).

Continued

Procedure 5-2 700 MHz RRH pole mount configuration (Continued)

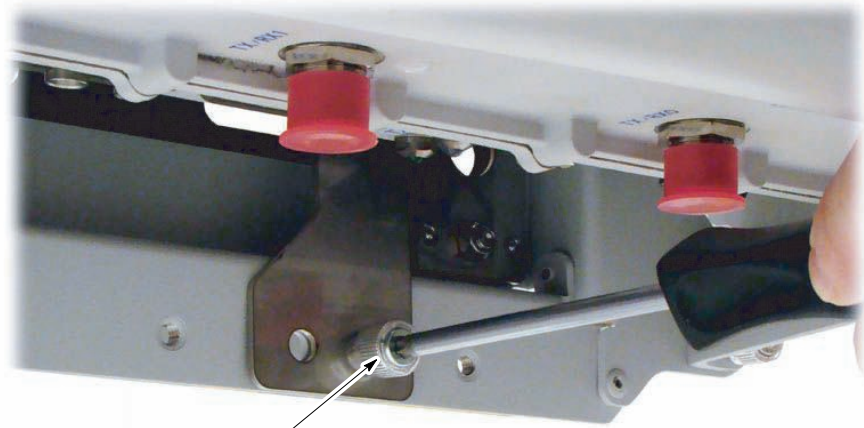

Captive M6 fastener

- 6 Using a T25 Torx driver, remove the handles on both sides of the RRH after installation.

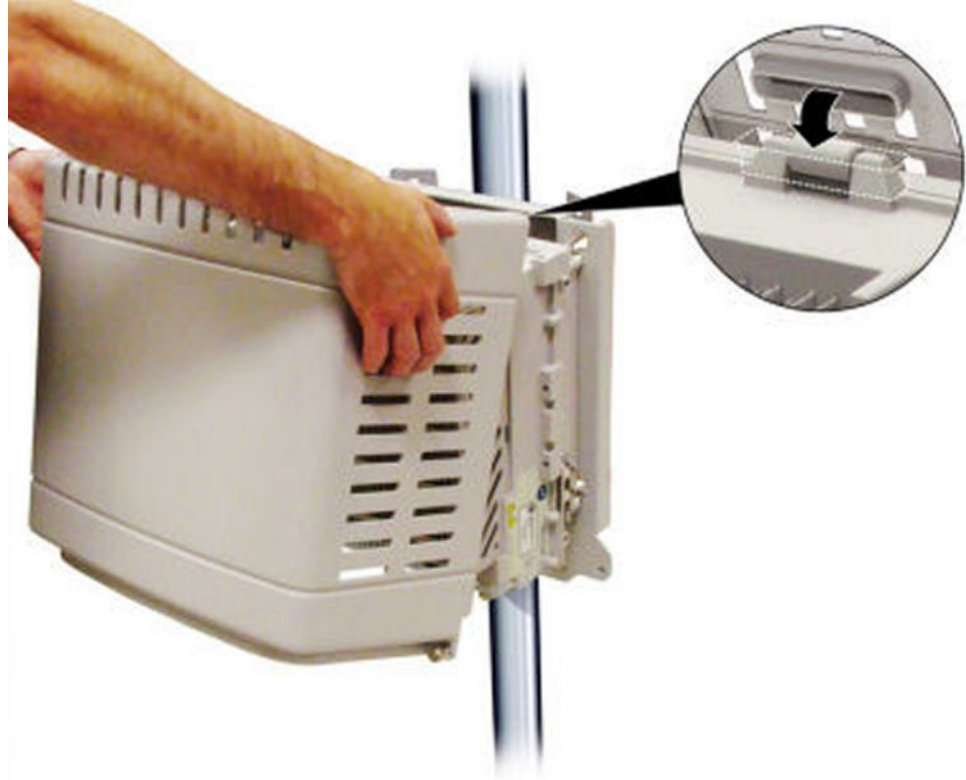

Continued

Procedure 5-2 700 MHz RRH pole mount configuration (Continued)

- 7 Fit the solar cover by inserting the hinges on the RRH the recesses in the top panel of the cover.



- 8 Secure the solar cover with M6 captive fasteners located in each bottom corner. Tighten the fastener using a T30 security TORX driver to a minimum torque of 5.1 N-m (45 in-lbs).

Continued

Procedure 5-2 700 MHz RRH pole mount configuration (Continued)

700 MHz RRH connections

Figure 5-1 shows the connections on the under side of an RRH. The RS232/MMI and the Ethernet connections are placed underneath a protective weather-sealed access cover.

Figure 5-1 700 MHz RRH connections

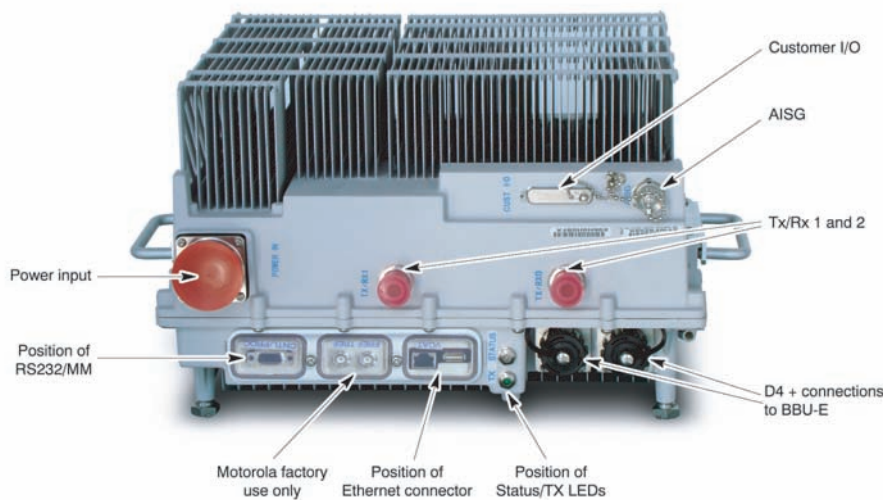

⚠ WARNING

The power input connection is not weather sealed until the mating cable is installed. Weather sealing is only maintained if the mating cable is installed properly.

A protective cover must be placed over the RS232 / factory timing ports / Ethernet connectors to ensure proper weather sealing.

Table 5-1 LED configurations

Status LED	Transmit LED	State
Slow Flashing Green		Bootstrap (Code load) state.
Green		Active standby/call processing state.
Red		Power Alarm Indication.
Red		RF Alarm Indication.
Alternate Flashing Red Green		Flash reprogramming state.
	Yellow	RRH is transmitting.

For cabling requirements for RRH products, see [eNodeB Cable Descriptions \(min 90C insulation rating\) on page 2-13](#). The SFP module that fits in the D4+ socket on the RRH has to be ordered separately.

Installation of 2.1/2.6 GHz RRH

This section provides procedures to install the 2.1/2.6 GHz RRH.

The 2.1/2.6 GHz RRH can be configured in two ways:

- Wall mount configuration
- Pole mount configuration

The chassis for both 2.1 GHz RRH and 2.6 GHz are similar.

The mounting brackets can accommodate a 2-inch to 4.5-inch diameter pole or be mounted directly to a flat wall by omitting clamps and threaded rods and using four 7/16-inch diameter corner holes. A Security Torx T45 driver is required to fix the M8 Security Torx Pan Head screw.

Perform the steps in [Procedure 5-3](#) to install the 2.1/2.6 GHz RRH to a wall.

Procedure 5-3 2.1/2.6 GHz RRH wall mount configuration

1	<div style="background-color: yellow; padding: 2px; display: inline-block;"> CAUTION</div> <p style="margin-left: 20px;">Ensure that a qualified structural engineer verifies the wall structure and wall-mount installation for the weight of the installation under adverse conditions in the installation area.</p> <p>Drill four holes of the appropriate size into the wall for the wall mount anchors as recommended by the structural engineer. Drill the holes in the locations as shown in Figure 5-2.</p>
2	Install wall anchors into the drilled holes.
3	Align the four mounting holes in the wall mount bracket with the four holes drilled into the wall, and install screws through the mounting bracket into the wall anchors installed in step 1 .
4	Tighten the four screws to the torque value recommended by the manufacturer of the wall anchors.
5	Insert the M8 cap screws into two upper mounting holes on the sides of the RRH. Engage 2 to 3 threads of each fastener.
6	Insert the RRH into the bracket and support by positioning the threaded shanks of the two partially installed M8 cap screws into the open slots at the top of the bracket.
7	Pivot the lower portion of the RRH until the lower two mounting holes of the bracket align with the threaded lower two mounting holes at the sides of the RRH. Insert the remaining two M8 cap screws and tighten to 24.3 +/-1.3 N-m (18+/-1 foot-pounds). Tighten the top two M8 cap screws to 24.3 +/-1.3 N-m (18+/-1 foot-pounds).
8	Connect the frame ground cable to the designated pad on the bottom surface of RRH using the two ¼-20 threaded studs, lock washers, and hex nuts provided with the RRH. Tighten hex nuts to 10.8 +/-1.3 N-m (8+/-1 foot-pounds).

Figure 5-2 LTE 2.1/2.6 GHz RRH Wall Mount Bracket Mounting Hole Locations

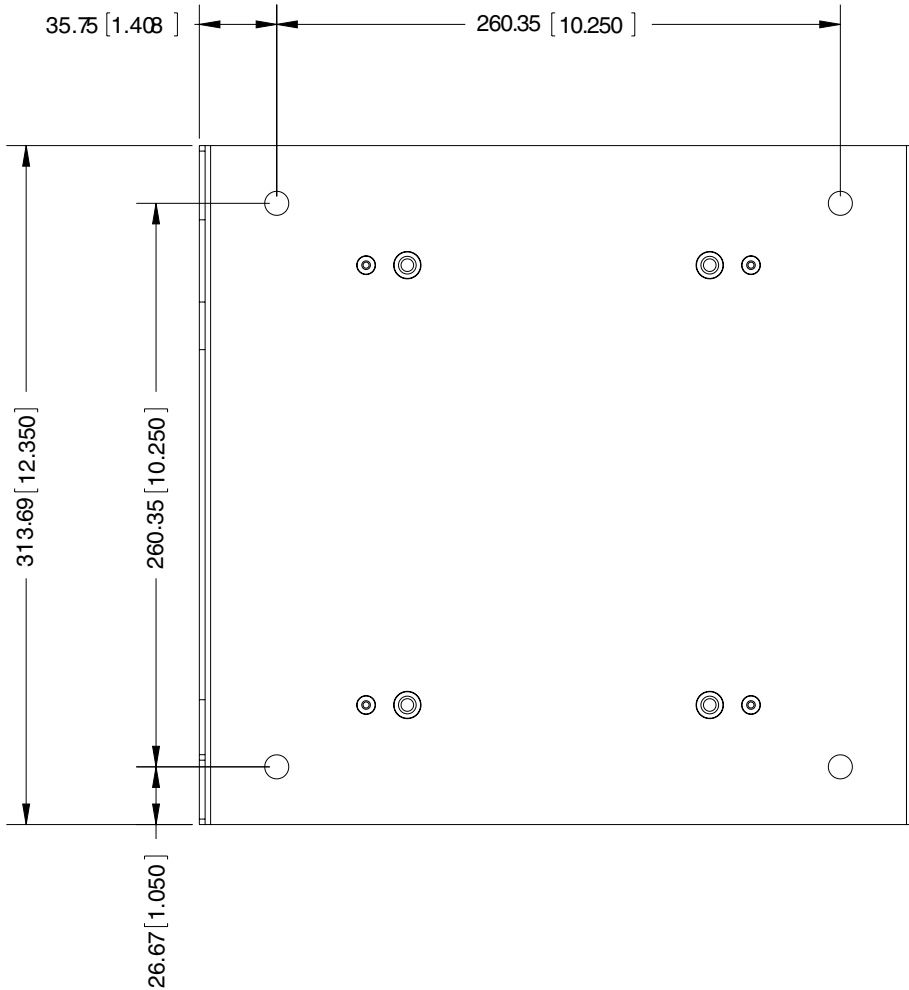

2.1/2.6 GHz RRH pole mount configuration

Perform the steps in [Procedure 5-4](#) to install the 2.1/2.6 GHz RRH to a pole.

Procedure 5-4 2.1/2.6 GHz RRH pole mount installation

- | | |
|----------|---|
| 1 | Attach a 50.8 mm (2-inch) pole clamp to the rear surface of the support bracket. Support in two locations as shown in Figure 5-3 . Fasten with M5 x 12 mm long Hex Head screws and tightened to 4.5 +/- .22 N-m (40 +/- 2 inch-pounds). |
|----------|---|

Continued

Procedure 5-4 2.1/2.6 GHz RRH pole mount installation (Continued)

2	Insert four M8 x 200 mm long threaded studs through holes in the previously mounted pole clamp. Thread into the support bracket until studs protrude 1.524 mm-3.175 mm (.06-0.1250 inches) beyond the M8 clinch nuts .
3	Position the previously assembled mounting bracket against a 50.8 mm (2-inch minimum) to 114.3 mm (4.5-inch maximum) outside diameter pole, so that the serrated features capture the pole and the M8 threaded studs straddle the pole. The assembly must be oriented with the RRH mounting slots facing upward as shown in Figure 5-3 .
4	Slide the remaining pieces of the 50.8 mm (2-inch) pole clamp onto the M8 threaded studs, on the opposite side of the pole from the previously installed 50.8 mm (2-inch) pole clamp pieces, again capturing the pole within the serrated features of each piece.
5	Install the M8 split lock washer and the M8 hex nut onto each M8 threaded stud, and evenly tighten to 24.3 +/-1.3 N-m (18+/-1 foot-pounds).
6	Insert the M8 cap screws into two upper mounting holes on the sides of the RRH. Engage 2 to 3 threads of each fastener.
7	Insert the RRH into the bracket and support by positioning the threaded shanks of the two partially installed M8 cap screws into the open slots at the top of the bracket.
8	Pivot the lower portion of the RRH until the lower two mounting holes of the bracket align with the threaded lower two mounting holes at the sides of the RRH. Insert the remaining two M8 cap screws and tighten to 24.3 +/-1.3 N-m (18+/-1 foot-pounds). Tighten the top two M8 cap screws to 24.3 +/-1.3 N-m (18+/-1 foot-pounds).
9	Connect the frame ground cable to the designated pad on the bottom surface of RRH using the two ¼-20 threaded studs, lock washers, and hex nuts provided with the RRH. Tighten hex nuts to 10.8 +/-1.3 N-m (8+/-1 foot-pounds).

LTE 2.1/2.6 GHz RRH Mounting Bracket

[Figure 5-3](#) shows the LTE 2.1/2.6 GHz RRH mounting bracket and [Figure 5-2](#) illustrates the mounting bracket in a wall mount configuration along with the necessary mounting hole locations.

Figure 5-3 LTE 2.1/2.6 GHz RRH Mounting Bracket

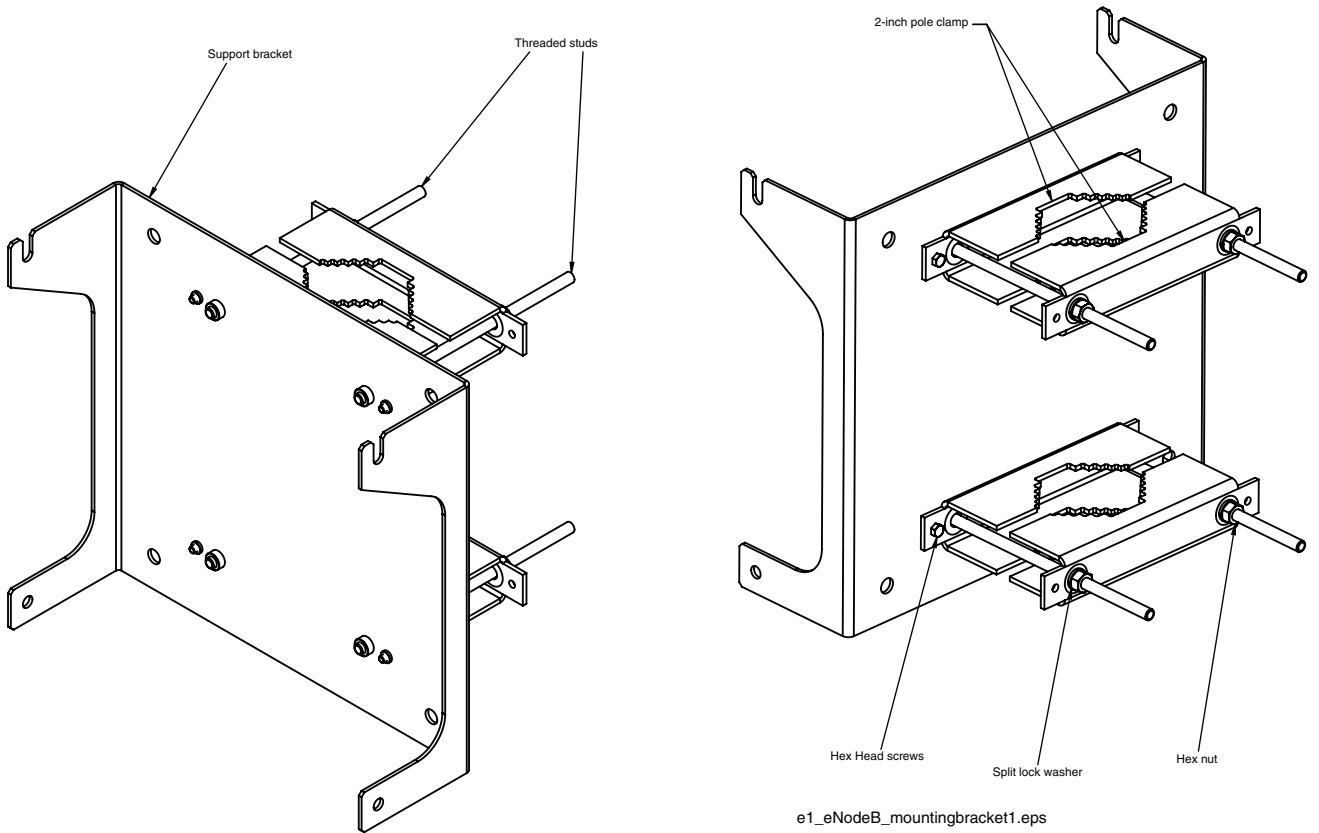

2.1 / 2.6 GHz RRH

Figure 5-4 shows the 2.1 GHz RRH.

Figure 5-4 2.1 GHz RRH

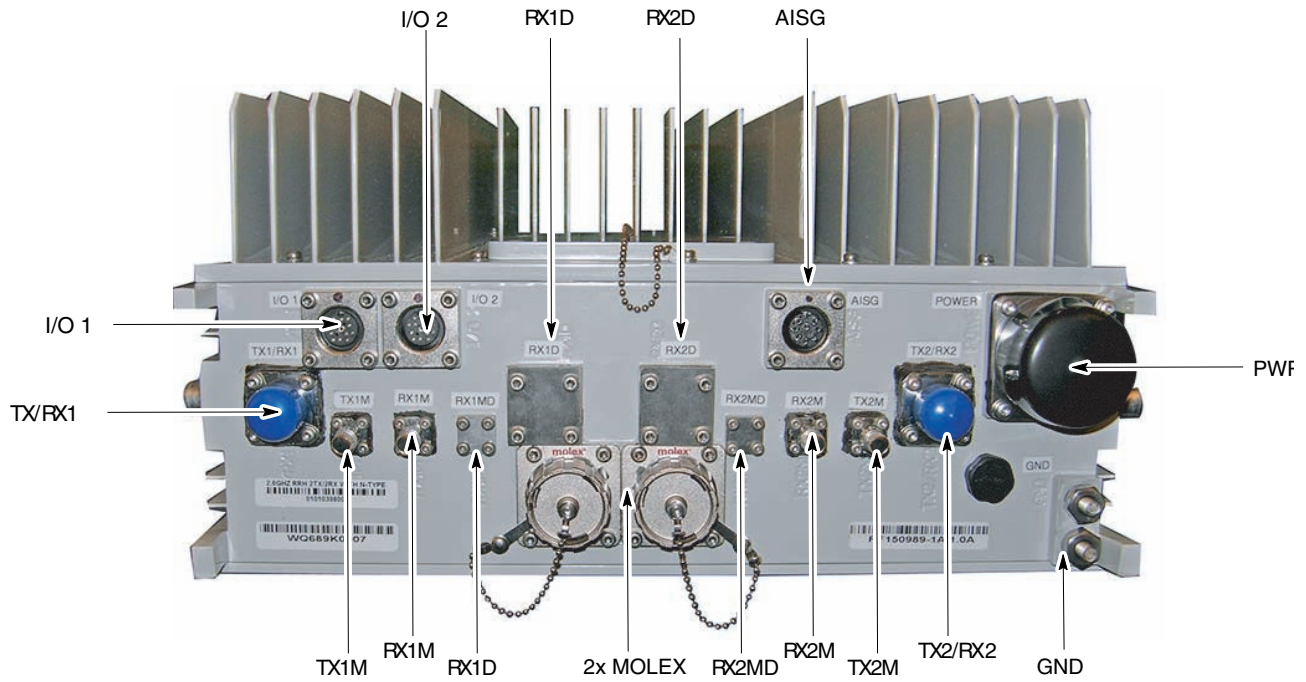

E1_radiohd_frt.eps

Cabling of the RRH

This chapter provides cabling instructions for the RRH, and interconnect from the indoor rack mounted equipment to the building I/O point for the Remote RF-Based eNodeB.

Inter-cabling – between major components

Safety when handling Fiber/Power Supply and Earth Cables

Handling Instructions for Fiber Cables

WARNING

Do not look directly into fiber optic cables or data in/out connectors. Either the data in/out connectors or the un-terminated fiber optic cables connected to data in/out connectors can emit laser radiation.

The following special handling procedures should be followed for all fiber cables:

- Do not remove dust caps except during operation.
- Do not touch the end surface of the connectors. Protect it from damage at all times. If cleaning is necessary, use isopropyl alcohol and a cleaning tissue only.
- Make connections carefully and slowly, being sure to note the anti-rotation key if applicable.
- When bending, be aware of the minimum bend radius allowed. Do not kink or squeeze the cable.
- Prevent the cable from twisting. Be careful when unwinding.

Safety when installing the power supply and earth cables

WARNING

Observe the following power supply and earth cables pre-installation warnings:

- Ensure a complete primary earth path by connecting the earth cable to the RRH before connecting the power supply cable to the main power source.
- Select the earth cable ratings in accordance with the national and regional wiring regulations.
- Ensure that the enclosure earth cable is a 6 AWG.
- RRH equipment operates at potentially hazardous voltages. Ensure only trained and competent personnel work on this equipment in accordance with the local regulations.
- Exercise caution when installing, commissioning, and removing the protective covers for any purpose.
- Avoid wearing anti static wrist strap while servicing the power supplies or power distribution cabling to prevent serious personal injury.

RRH ground connections

Perform the following procedure to connect RRH to ground.

Procedure 6-1 Connecting RRH to ground

1	Using a T30 security Torx driver, loosen and remove the earth ground lug on the RRH.
2	Obtain a 6 AWG earth cable for the RRH earth lug and remove the outer sheath to expose the correct length of the bare copper.
3	Reattach the ground lug onto the RRH. Using a T30 security Torx driver, tighten the captive screws to 5.1 N-m (45 in-lbs).
4	Connect the opposite end of the earth cable to an effective earthing point.

RRH power connections

This section contains the procedure for connecting the RRH power cables.

RRH power connection considerations

NOTE

Always check with the local building authorities for the wire size requirements for your environment.

NOTE

When interfacing with the BCUII, the customer is responsible for providing dc power to the RRH. The following information is a reminder of the customers responsibilities. The customer is ultimately responsible to ensure that all grounding guidelines and customer-supplied Power Cabinet or service bay connections meet local electrical codes.

Consult the site planning documents to determine if the wire colors have been previously specified. Consult the *Standards and Guidelines for Communication Site, Motorola part number 68P81089E50* for further power cabling information.

If the dc power cable length between the customer-supplied Power Cabinet or service bay and the RRH exceeds 3 meters, verify that the power source meets Conducted Emissions requirements from ETSI EN 301 489-1 Clause 8.3 DC Power Input and Output Ports. This action is to maintain the regulatory type approval requirement for those markets requiring a CE mark on the equipment.

RRH external power supply

Proper safe guards must be in place to insure compliance with regulatory specifications for the region of the install. Two areas of concern are Electromagnetic Interference (EMI) and Surge protection.

Surge protection of the dc output

The specifications for surge protection are:

- Must be compliant to IEC61000-4-5, Class X 5 KV at 2.5 KA Common Mode and 500 V at 250 A Differential Mode IEC combined waveform.
- Physically locate the protection unit as close as possible to where the dc line comes into the structure.
- Must meet electrostatic discharge per IEC61000-4-2 Level 4.

Motorola recommended surge protectors:

- Transtector, part number 12R ICP
- Emerson Power, part number DCB-48

One surge protector is used for each sector.

DC power filter (EMI protection)

The specifications for the DC power filter are:

- Limits for the conducted disturbance at the mains ports of Class B ITE equipment meet the limits specified in EN 55022:2006 (derived from CISPR 22:2005)
- DC series, 15 A to 125 A
- General-purpose application
- Supports bulkhead and rack mounting

Motorola recommends the following power filter:

- Tyco Electronics (CORCOM), part number 10VN1 (6609052-2)

One power filter is used for each sector.

RRH dc power cable connection

The following procedure assumes:

- The customer is using the Motorola supplied RRH dc power cables.
- The DC Power Filter and the DC Surge Suppressor units are located inside the customer location.
- The DC Power Filter and the DC Surge Suppressor units are already installed and cabled.

Refer to [Figure 6-3](#) for the location of the power connector on the RRHs. There can be two methods of supplying power to the BCUII and RRH:

- Two separate power sources are used. One for the BCUII (-48 V dc) and one for the RRH (+54 V dc).
- A single power source (-48 V dc) supplies power to both the BCUII (-48 V dc) and the RRH (+54 V dc). The polarity must be reversed when connecting the cables to the head to convert the power source to +54 V dc. Refer to [Figure 6-1](#) for a generic system power cabling diagram of this method.

Figure 6-1 System Power Cabling

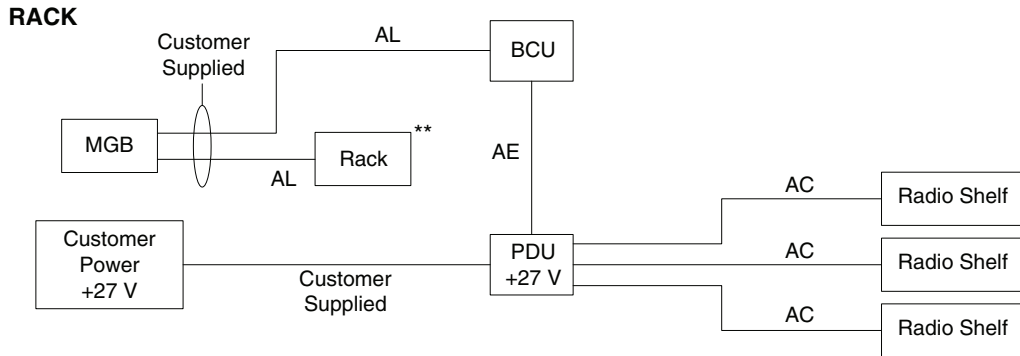

** When using a Motorola rack, only the BCU and the frame need to be cabled to the MGB. When using a non-Motorola rack, all items must be cabled to the MGB.

RRH STYLE 1

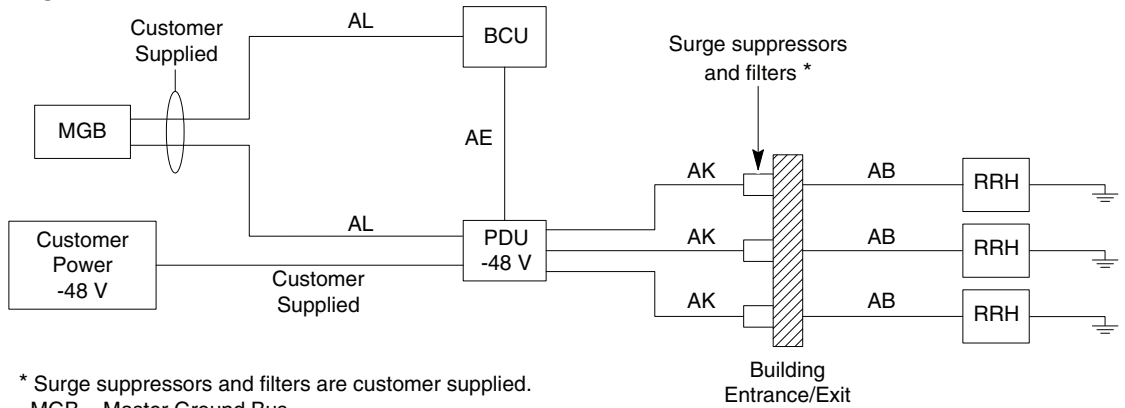

* Surge suppressors and filters are customer supplied. MGB = Master Ground Bus

RRH STYLE 2

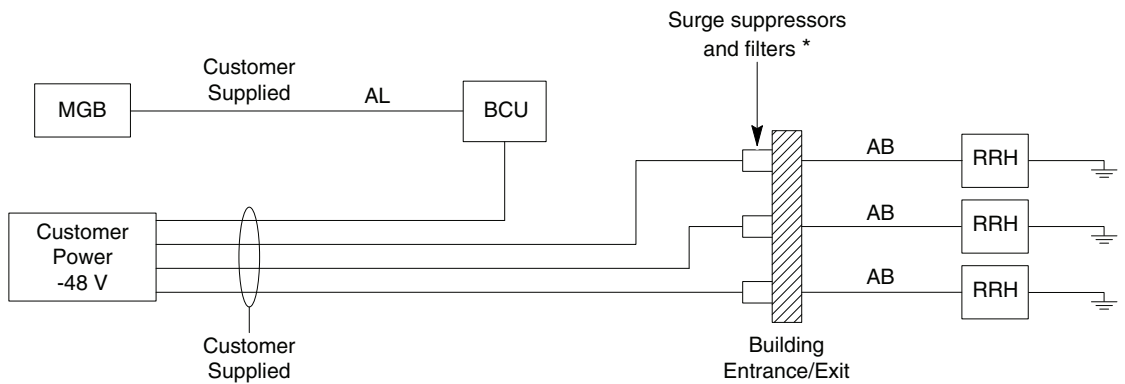

* Surge suppressors and filters are customer supplied. MGB - Master Ground Bus

E1_SysPwrCabling1.eps

Figure 6-2 2.6 GHz RRH connections

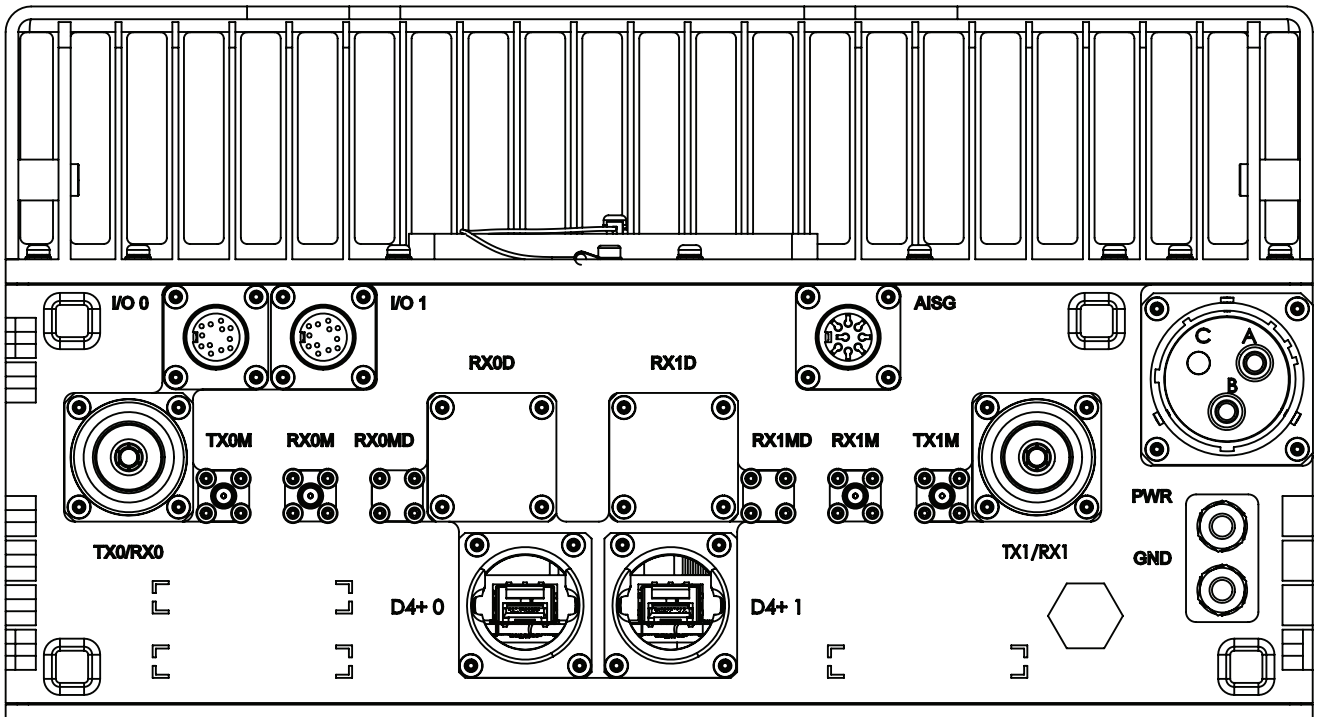
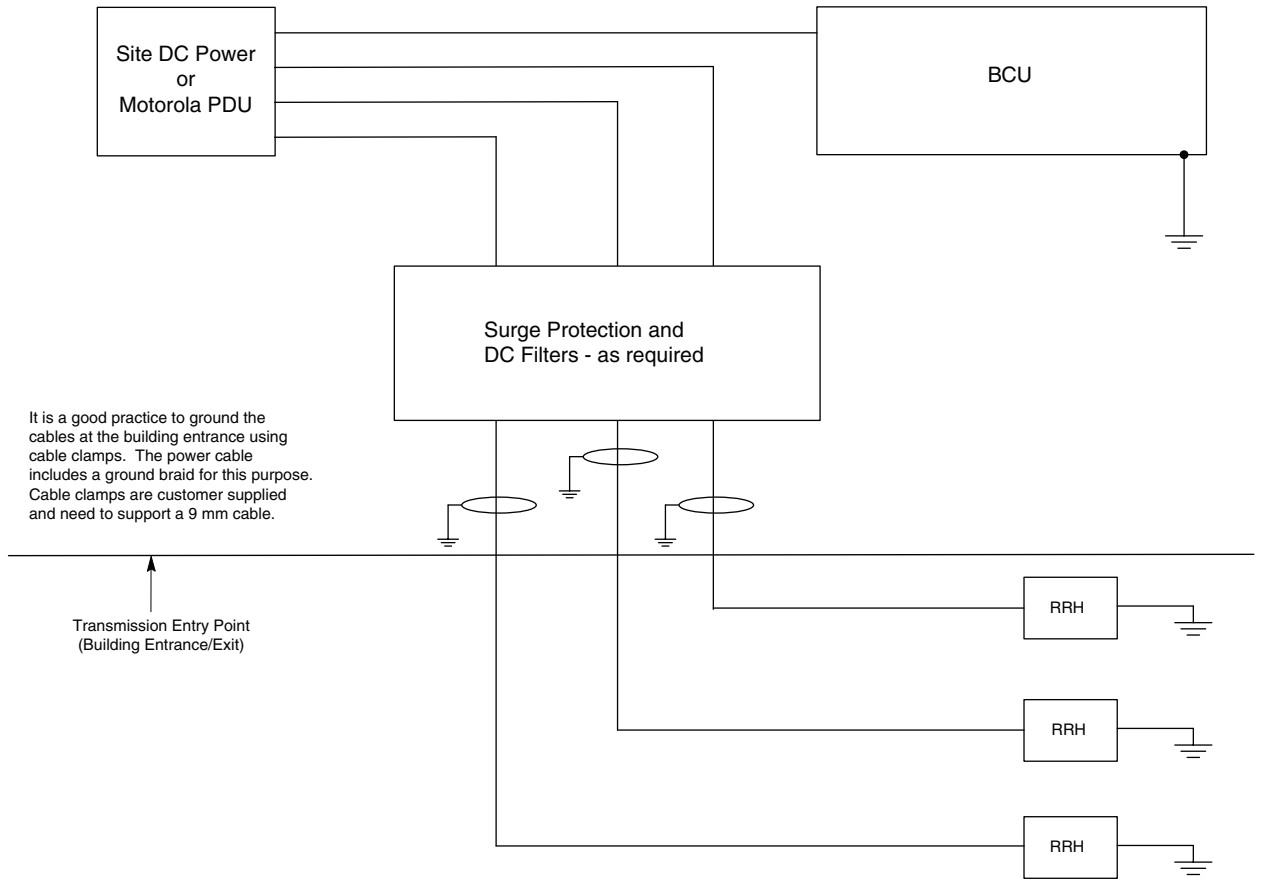

Figure 6-3 RRH power cabling



Note: Head is designed to use -48 V dc.
EMI Filter and Surge Protector are customer supplied.

E1_Head_IndoorBCUII_PWR1.eps

Procedure 6-2 RRH power cabling

- | | |
|----------|---|
| 1 | Ensure that customer supplied dc power source (+54 V dc or -48 V dc) is disengaged. |
|----------|---|

Continued

Procedure 6-2 RRH power cabling (Continued)

2	<p>Before routing the dc power cable, verify that it is properly color coded. If more than oneRRH is in use, ensure that they are all properly color coded. The colors are as follows:</p> <ul style="list-style-type: none"> ● RFU 1 – RED ● RFU 2 – BLUE ● RFU 3 – YELLOW ● RFU 4 – GREEN <p>Place a corresponding colored adhesive backed label on the RRH (1-4) chassis in the area labeled RFU ID.</p>
3	<p>At the customer location, locate the terminal block which supplies power to the heads.</p>
4	<p>Ensure that there is enough cable inside the customer location so that:</p> <ul style="list-style-type: none"> ● The Red wire of the cable can connect to the DC Surge Suppressor. ● The Black wire can connect to the terminal block.
5	<p>At the transmission entry point (customer building exit/entrance), ground the cables by:</p> <ul style="list-style-type: none"> ● Stripping the power cable of its outer jacket to expose the shield and inner conductors. ● Strip back the shield to a length such that it can be properly grounded using a cable clamp. <p>Securely clamp the outer cable jacket with enough length for the power conductors to reach the correct terminal block and the DC Surge Suppressor without excessive strain. Ensure that there is proper grounding between the shield, braid, and grounding contacts of the cable clamp.</p>
6	<p>Terminate the power conductors with ferrules (PN 2987529D01) @ 2X using the proper crimp tool (Tyco P/N 47387-7). Ensure that there are no loose strands that might come in contact with a metallic surface, tool, or other conductor.</p>

Continued



Procedure 6-2 RRH power cabling (Continued)

7	<p>Connect the Black cable to the terminal block. Connect the Red cable to the DC Surge Suppressor. Tighten the connectors.</p> <div style="background-color: #ffff00; padding: 5px; margin: 10px 0;">  CAUTION </div> <ul style="list-style-type: none"> • Ensure that the ferrules do not contact each other, other metallic structure, tools, or any other conductive media after final installation. Care must be taken to ensure that the circuit is isolated and complete. • Do not engage the RRH Circuit Breakers until a complete and proper connection has been made at the RRH end of the conductor, and the RRH is in its final mounted position. • Do not over torque the terminal block of the customer supplied power when tightening the cable connections. The customer supplied power terminal block must not twist.
8	<p>Route the power cable up the pole to the appropriate heads. Ground the cable along its length using the shield and braid of the cable for ground connection to the tower structure or other main ground point or structure. If conduit is being used, route the power cables through the conduit.</p>
9	<p>Connect the power cable to the dc input connector on the RRH. Tie-wrap cable as necessary. Ensure that there is sufficient strain relief.</p>

RRH to BCUII interconnect

Perform the steps in [Procedure 6-3](#) to connect the digital cable to the BCUII.

Procedure 6-3 Connecting the digital cable to the BCUII

1	<p>Open the BCUII front door and install one fiber transceiver module per Radio into the BCUII, starting with SFP port A.</p> <div style="background-color: #add8e6; padding: 5px; margin: 10px 0;">  NOTE </div> <p style="text-align: center;">The SFP slots are labeled A, B, C, and D. Populate Slot A first.</p>
2	<p>Using a T20 Torx bit, remove two screws to remove the fiber cable feed through plate from the left inside wall of the BCUII.</p> <div style="background-color: #add8e6; padding: 5px; margin: 10px 0;">  NOTE </div> <p style="text-align: center;">The feed through plate may already be off per the previous procedures to install the BCUII in the rack.</p>
3	<p>Position the cable such that the cable is in the lowest position and that the grommet is in the location indicated in Figure 6-4.</p>

Continued

Procedure 6-3 Connecting the digital cable to the BCUII (Continued)

4	Remove the protective caps from the fiber cable connector and the fiber transceiver module.
5	Mate the fiber cable to the left-most fiber transceiver, which is marked A under the fiber transceiver module.
6	<p>Repeat step 1 – step 5 for the second and third fiber cable until they are routed as shown in Figure 6-6 and Figure 6-7.</p> <p>Connect the second and third fiber cables as follows:</p> <ul style="list-style-type: none"> ● Second fiber cable – Connect to the second grommet, position up and mate to fiber transceiver B. ● Third fiber cable – Connect to the third grommet, position up and mate to fiber transceiver C. <p>Grommet locations are shown in Figure 6-5</p>

Figure 6-4 Fiber Cable

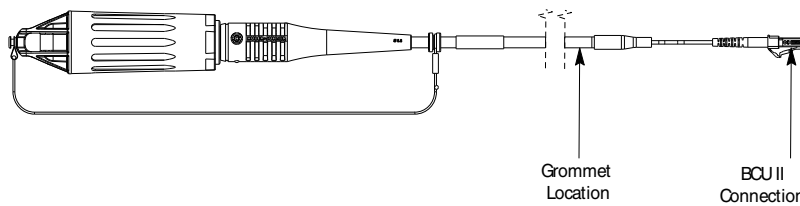

EI_XCR_cable.eps

Figure 6-5 BCUII Fiber Optic Cable Grommet Location

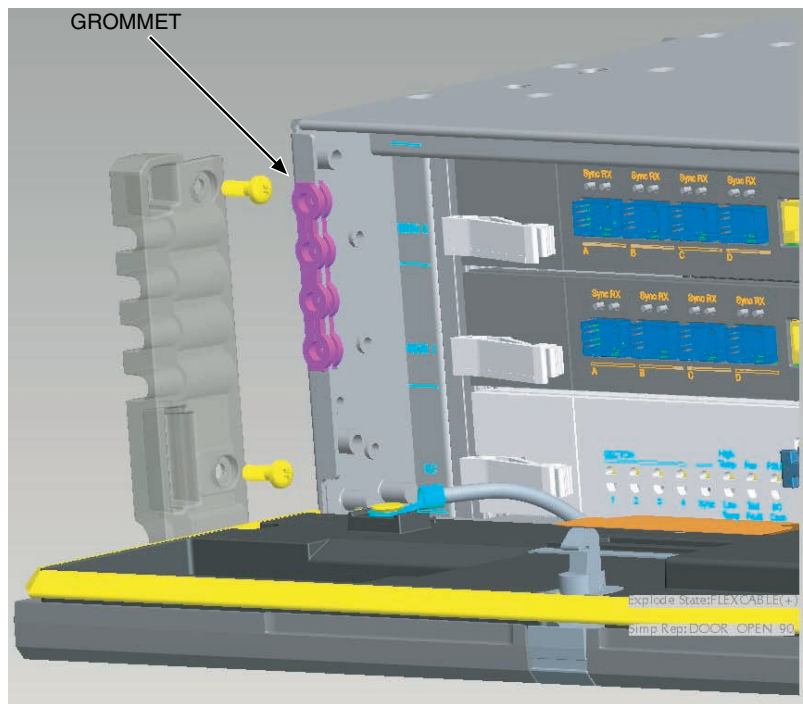

D2_BCUII_Grommet_Location.eps

Figure 6-6 Fiber Optic Cable Brackets

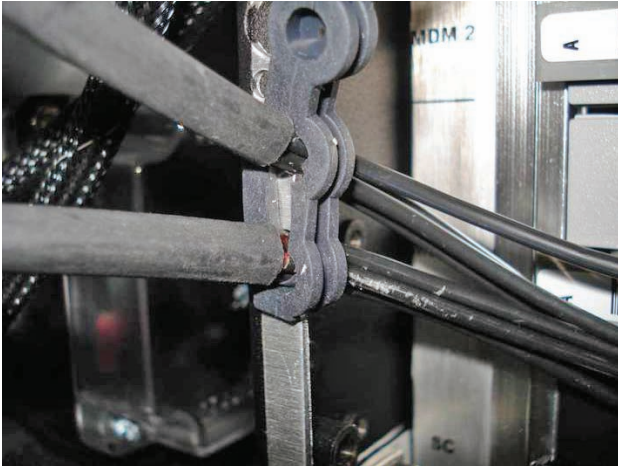

View A

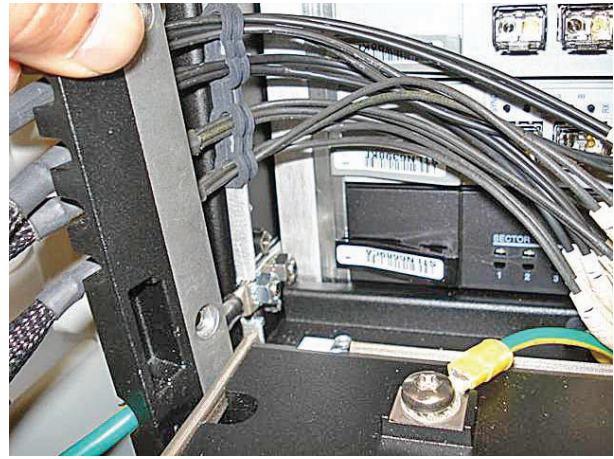

View B

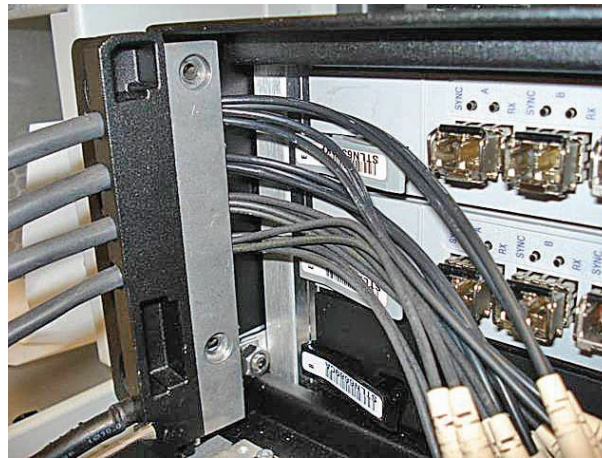

View C

D2_BCUII_FO_Clip_1.eps

Figure 6-7 Fiber Optic Cable Clip Installation



Fiber Clip

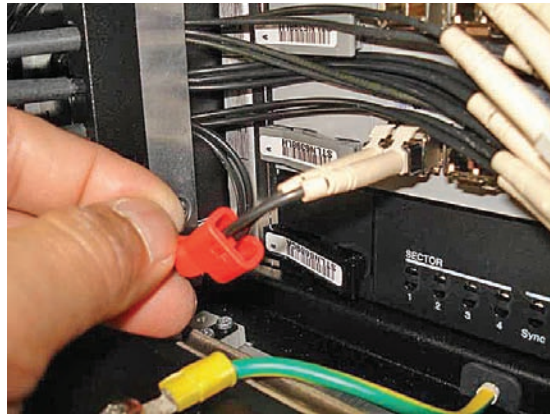

View A

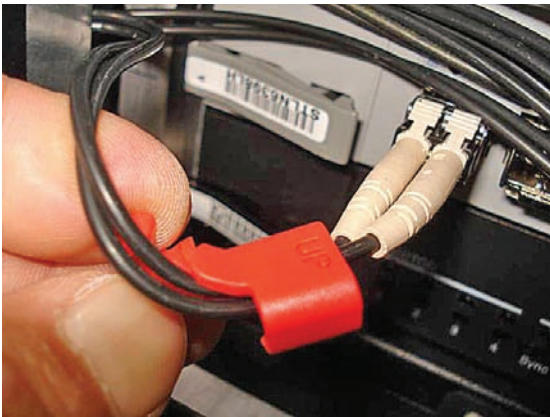

View B

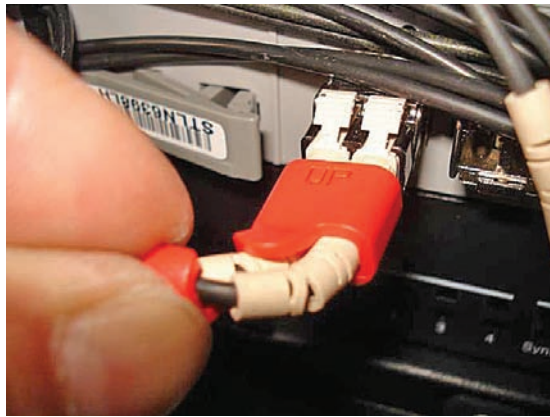

View C

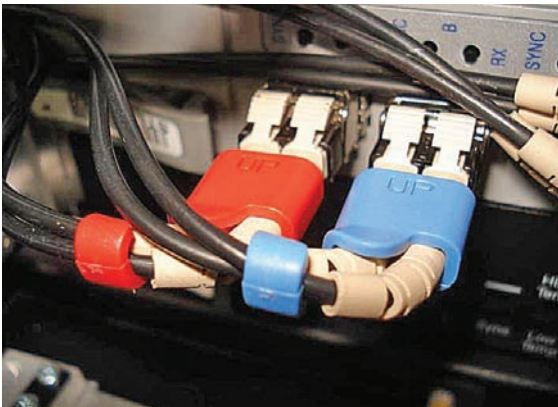

View D

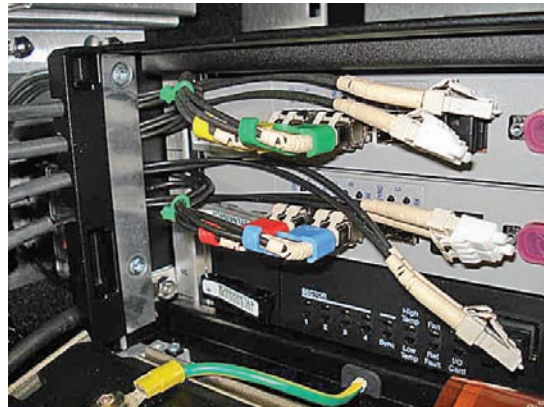

View E

D2_BCUII_FO_Clip_2.eps

Use [Table 6-1](#) to identify the routing for the cables running between the BCUII slots and the RRH sectors.

Table 6-1 Fiber cables routing

BCUII fiber transceiver	Radio fiber transceiver
A	RRH sector 1
B	RRH sector 2
C	RRH sector 3
D	None

Perform the steps in [Procedure 6-4](#) to connect the digital cable to the RRH.

Procedure 6-4 Connecting the digital cable to the RRH

1	<div style="background-color: #f4a460; padding: 5px; display: inline-block;"> WARNING</div> <p style="text-align: center;">Check that the dc power has not been connected or isolate the dc power before commencing the following procedure.</p> <p>Route the fiber cable out of the building and to the RRHs as follows:</p> <ol style="list-style-type: none"> 1. Fit one supplied ferrite clip over a pair of D4+ cables, inside the cable entry box, connecting to the T43 module. Ensure all the D4+ cable pairs have one ferrite clip fitted. 2. Feed the BCUII cable ends up through the cable gland at the rear of the cabinet. 3. Route the cables up inside the rear of the rack and across the top from rear to front until they appear at the front just above the BCUII card. 4. Insert SFP fiber transceiver modules into the BCUII (follow step 2). Connect the fiber LC connector to the SFP fiber transceiver module.
2	<p>Install the RRH D4+ cable as follows:</p> <ol style="list-style-type: none"> 1. Remove the protective covers from the D4+ sockets on the RRH. 2. Unpack the SFP fiber transceiver modules and insert them into the D4+ connectors. 3. Secure the SFP fiber transceiver modules by pushing them firmly home into the sockets taking care not to damage the extraction handle. The extraction handle must be folded against the body of the SFP fiber transceiver module before the D4+ cable can be fitted.

Continued

Procedure 6-4 Connecting the digital cable to the RRH (Continued) **CAUTION**

- Failure to ensure that the SFP fiber transceiver module is inserted correctly and mated might result in a connection failure.
 - The D4+ cable can be secured into position even if the SFP fiber transceiver module is not fully inserted, which results in what looks like a firm connection externally but internally no connection is made.
4. With the fiber connector held out of the way, insert the two cable latches to the socket.
 5. Holding the fiber connector, remove the two small protective caps and insert the connector into the SFP fiber transceiver module.
 6. Ensure that the fiber cable is fully latched into the SFP fiber transceiver module.
 7. Move the cable housing forward to cover the fiber connection and secure in to position by screwing it hand-tight on to the socket.

Installing RF cables from antennas to RRH

Perform the steps in [Procedure 6-5](#) to install RF cables from antennas to RRH.

Procedure 6-5 Installing RF cables from antennas to RRH

1	Remove the protective covers from the TX/RX0 and TX/RX1 ports on the RRH.
2	Connect the RF antenna cables to the TX/RX0 and TX/RX1 N-type connectors on the RRH. Using a 19 mm torque wrench, tighten the N-type connections to 4.3 N-m (38 in-lbs).
3	Secure the RF cables connecting the RRH to the antenna using cable ties as appropriate to reduce the chance of damage to the cables.

Customer I/O cable installation

Cable AB, listed in [Table 2-4](#), is required for this installation. Perform the following steps to install the Customer I/O cable.

Procedure 6-6 Installing Customer I/O cable

1	Install the Customer I/O cable (AB) to the front panel of the BCUII.
2	Route the opposite end of the Customer I/O cable to the termination equipment.
3	Secure the cable with appropriate strain relief using the tie wraps as necessary. Ensure that the fiber optic and earth ground cables are installed and the BCUII front panel is latched properly.

Ethernet cable installation

Ethernet ports

The Ethernet ports for the BCUII are located on the front panel. There are three ports available:

- ENET-A
- ENET-B
- Cust. ENET

The Ethernet ports are used as follows:

- Non-redundant Ethernet Backhaul (BH)- the typical connection is to ENET A, but ENET B can be used.
- Redundant Ethernet Backhaul - the typical connection is the primary BH to ENET A and redundant to ENET B. Redundant BH is not supported at this time.
- Ethernet Backhaul Diagnostics - the typical connection to ENET A or ENET B is a local computer with Ethernet trace (Wireshark). This allows backhaul traffic to be monitored or tested.
- Customer ENET - Allows access to the backhaul when the ENETA and B ports are being used.

Ethernet cable installation

Cable AG, listed in [Table 2-4](#) is required for this installation. Perform the steps in [Procedure 6-7](#) to install the Ethernet cable.

Procedure 6-7 Installing the Ethernet cable

1	Open the package containing the Ethernet cables.
----------	--

Continued

Procedure 6-7 Installing the Ethernet cable (Continued)

2	Connect the Ethernet cables to the Ethernet ports ENET-A and ENET-B on the BCUII front panel.
3	Route the opposite end to the Router. The router provides additional primary surge protection. Secure the cables with appropriate strain relief using the tie wraps as necessary. Ensure that the fiber optic and earth ground cables are installed and the front panel is latched properly.

RRH head –48 V dc power cabling installation

This section contains the procedure for installing the RRH head –48 Vdc power cables.

RRH –48 Vdc power when using a BCUII

When interfacing with the BCUII, the customer is responsible for providing dc power to the RRH. The customer has the option of using the Motorola –48 VPDU or providing their own PDU function. The following information is a reminder of the customer's responsibilities. The customer is ultimately responsible to ensure that all grounding guidelines and Customer Supplied Power Cabinet or service bay connections meet local electrical codes. The following procedure assumes that the customer is using the Motorola supplied RRH dc power cables.

If the dc power cable length between the Customer Supplied Power Cabinet or service bay and the RRH exceeds 3 meters, verify that the power source meets Conducted Emissions requirements from ETSI EN 301 489-1 Clause 8.3 DC Power Input and Output Ports. This verification is to maintain the regulatory type approval requirement for those markets requiring a CE mark on the equipment.

Proper safe guards must be in place to insure compliance with regulatory specifications for the region of the install. Two areas of concern are Electromagnetic Interference (EMI) and Surge protection.

Circuit breaker for dc output to head

For circuit breaker and wire gauge requirements for RRH products, see [DC supply equipment, Main circuit breaker, and DC input cable on page 2-7](#).

Connecting –48 V dc Power

The Connecting –48 V dc Power section provides the following information on routing the loose ends of the wires to the site –48 V dc source for connection to the source.

To minimize current imbalance between the feed (-V) and return (+V) wires used in the cable, ensure that the wire size, length, and gauge of each wire used in the cable are the same.

NOTE

This section applies for sites with optional Motorola-provided PDU only.

Required materials and tools

The following materials and tools are required:

- One -48 V dc Power Input Cable - customer supplied.
- Wire stripper/cutters.
- Digital Multi-Meter (DMM) Fluke Model 8062A with Y8134 test lead kit or equivalent; used for precision DC and AC measurements, requiring 4-1/2 digits.

Power cabling and tie down requirements

To control the inductance at the eNodeB DC power input due to the spacing between wires used in the - 48 V dc Power Input Cable (DC), bind the feed (-V) and return (+V) wires together at intervals of one meter or less.

Connecting -48 V dc power to the -48 V dc LTE eNodeB .

Perform the steps in [Procedure 6-8](#) to connect -48 V dc power to the -48 V dc LTE eNodeB.

WARNING

- Do not wear a wrist strap when servicing the power supplies or power distribution cabling.
- Ensure that the source for the DC power is in the OFF position.
- Ensure that all the PDU circuit breakers are OFF.

For the -48 Vdc Remote RF based eNodeB LTE system, the customer has the option of using the Motorola-provided -48 Vdc PDU or their own circuit breakers. If the Motorola—provided PDU is used, perform the steps in [Procedure 6-8](#) to install and connect the PDU. Wire AWG / breaker information is provided [Wire AWG \(min 90C insulation rating\) and circuit breaker sizing for -48 VDC RRH systems without PDU option \(customer-provided PDU function\) on page 2-9](#).

Procedure 6-8 Connecting -48 V dc Power

1	Ensure that the ground cable is connected between the rack and the Master Ground Bar.
2	Ensure that the -48 V dc Power Input Cable is not connected to the main -48 V dc power source. Turn off the main -48 V dc power source. Confirm that the power is switched OFF using a DVM.
3	The PDU is supplied with 2-Hole crimp on lugs for 1/0 AWG standard or 2 AWG high-strand count flex cable. If you require another type of cable, order new lugs as needed. Ensure that the lugs meet the criteria in Table 3-2 .

Continued

Procedure 6-8 Connecting -48 V dc Power (Continued)



	 NOTE The expected load condition and cable length determines the wire gage required for the system. See Table 2-2 .
4	Remove the lug cover and service cover using their respective snaps.
5	Insert the two-hole lugs through the rear of the PDU, so that the holes in the lugs align with the holes in the lug mounting plates.
6	Install two M6 flat washers and two M6 x 16 screws into each lug (4 washers and 4 nuts total for the 2 lugs) using a T30 Torx driver.
	 NOTE The flat washers and screws are supplied in the bags zip tied to the PDU rear bracket. Leave the screws loose so that the lugs can be adjusted side-to-side.
7	Replace the lug cover while adjusting the cables to ensure that the cover can be snapped into position.
8	Tighten the lug screws to 5.1 N-m (45 in-lb) and replace the service cover.
9	Install zip ties around the cables through the rear bracket and pull tight for sufficient strain relief.
10	Connect the other end of the -48 V dc power and return wires to the power source.
	 NOTE Do not turn on the power source at this time. This must be done after the installation and cabling is complete.

Table 6-2 Lug criteria

PDU input	LTE PDU input label text	Crimp lug's center – to – center spacing of M6 (1/4") screw holes	Wire gage compatibility for supplied lugs
-48 V dc	-48 Vdc (blue arrow)	19 mm (3/4 inch)	1/0 standard cable
	0V (black arrow)	16 mm (5/8 inch)	
Ground	Frame ground	16 mm (5/8 inch)	

Cabling of RRH

2.1/2.6 GHz RRH

Chassis mounting hardware

The chassis for both 2.1 GHz RRH and 2.6 GHz are similar.

The chassis grounding location is a double stud/hex nut. The installer supplies the lug. Panduit has double 1/4-inch hole 5/8-inch spacing compression lugs that handle wires ranging from 2/0 to 8 AWG.

Connector types

Following are the connector types used on the 2.1 GHz RRH, 2.6 GHz RRH, and mounting bracket:

- I/01 and I/02 — 12 Pin Circular Female
- AISG — eight Pin Circular Female
- Power — 2 pin connector Male
- TX1/RX1 and TX2/RX2 — N-Type Female on 2.1 GHz and 7/16 connectors on 2.6 GHz
- TX1M, RX1M, TX2M, and RX2 — SMA Female

Connecting power and the RF to the RRH

For instructions to connect power and the RF to the RRH, see [Procedure 6-2](#). For instruction to connect RF cables from antennas to the RRH, see [Procedure 6-5](#)

Power-up sequence

This chapter provides the power-up sequence for the eNodeB.

Power Up Sequence

Procedure 7-1 Power Up Sequence

1	Turn on the circuit breaker for the customer supplied power.
2	Close the eNodeB main disconnect circuit breaker on the external power feed to power the PDU.
3	If a Motorola PDU is used, close the BCUII circuit breaker on the PDU. If a non-Motorola PDU is used, close the customer-provided circuit breaker.
4	Open the BCUII front panel by performing the following: <ul style="list-style-type: none"> • At the front panel door, push in on the door latch release button and grasp the top edge of the front panel door. • Pull the door open and pivot it downward to the 90 degree position.
5	Power up the BCUII by momentarily pressing the BCUII Power Switch so that the switch is in the IN/ON position.
6	Switch power on to each radio unit by closing its associated circuit breaker.
7	Verify that the Green STATUS LED is on for the Site Controller. Verify that the Green STATUS LED is on or flashing (waiting for a sector assignment) on the modem cards.
	 NOTE On the modem, the lights remain red until the D4 (fiber) links to the radio units are operating and synchronized.

Figure 7-1 BCUII Power Switch



D2_OEBCUII_sc_pwr_switch.eps

Field Replaceable Units

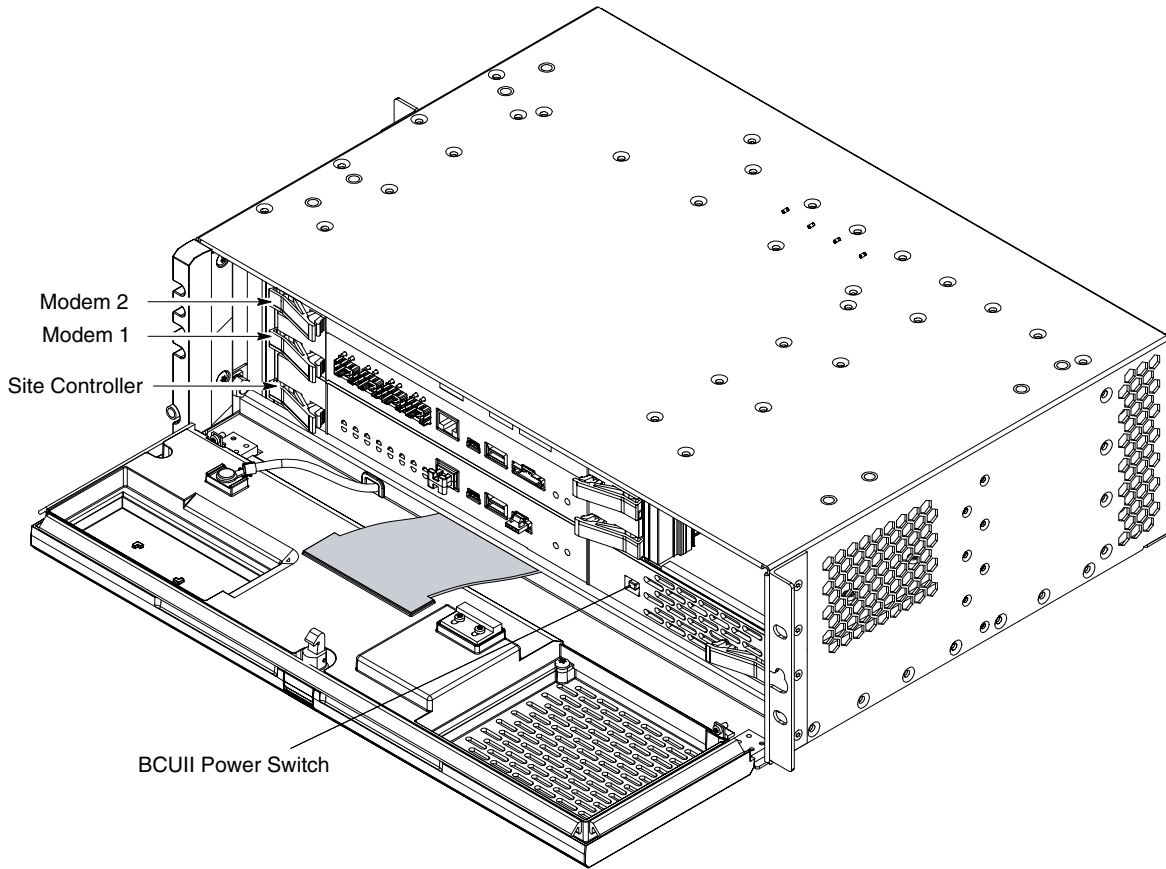
This chapter provides procedures for removal and replacement of components that are deemed FRU.

List of Field Replaceable Units (FRUs)

This section lists the items designated by Motorola as Field Replaceable Units (FRUs) for the eNodeB. The following tables give various information about the FRUs.

Table 8-1 eNodeB FRU Information

Item Description	Motorola Part Number	Notes
BCUII Flex4 Modem (See Notes column.)	STLN6724	Requires use of Modem Card Duplex Optical Transceivers. Contact your Motorola service representative for more information.
BCUII Site Controller Card	STLN6725	
BCUII I/O Card	STLN6704	
BCUII Power Supply	STPN4058	
Q-HSO (Quartz High Stability Oscillator)	SGLA4017	
BCUII Fan	SGLN1946	
eNodeB PDU +27 V dc	STLN6905	
eNodeB PDU -48 V dc	STLN6906	
Frame Based Radio (FBR)	STWF4000	The indoor 700 MHz radio.
RFS Fan	STLN6904	
Filter/Duplexers	STFF4046	
BCUII to FBR Fiber Cable Kit	STKN4134	
Remote Radio Head (RRH)	STWK4000	A Remote Mount Radio for 2600 MHz band operation. Includes the wall mount bracket (STLN7037A).
Remote Radio Head (RRH)	STWF4001	A Remote Mount Radio for 700 MHz Upper C band operation. Includes the wall mount bracket (SYLF8377).
Remote Radio Head (RRH)	STWG4003	A Remote Mount Radio for 2100 MHz band operation.
Optical Transceivers for RRH	SYLN8961	This fiber transceiver can be used for multi-mode fiber installations up to 100 m.
Optical Transceivers - Modem card and frame-based radio (radio shelf)	STKN4134	Part number is for the kit containing a fiber cable and optical transceivers used in the frame-based system.

BCUII Flex4 Modem Replacement

Objectives

The primary objective is as follows:

- Remove the failed Flex4 Modem card from the BCUII card cage.
- Install a replacement Flex4 Modem card in the BCUII card cage.

Preparation

Required tools

No tools are required to remove and install the Flex4 Modem card.

Required item

The following replacement unit is required:

- BCUII Flex4 Modem STLN6724

Replacement Procedure

Perform the following procedure to remove the Flex4 Modem.

Procedure 8-1 Removal of Flex4 Modem

1	Perform lock-out card procedure.
2	<div style="border: 1px solid black; padding: 5px; margin-bottom: 5px;">  </div> <p style="text-align: center;">ESD handling precautions must be adhered to when handling the BCUII plug-in cards. Wear a conductive, high impedance wrist strap.</p> <p>Open the front panel door to the 90 degrees position.</p>
3	Locate the failed Modem card.

Continued

Procedure 8-1 Removal of Flex4 Modem (Continued)

4	 NOTE <p>Multiple cables must be disconnected from connectors. If necessary, use masking tape and a marker and temporarily tag each cable as to the proper connector before disconnection.</p> <p>Disconnect the fiber-optic cabling from the front of the failed Modem card. For fiber-optic cable connections perform the following:</p> <ol style="list-style-type: none"> 1. Grasp the LC duplex connector and depress the release to remove the fiber cables from the fiber optic transceiver. 2. Remove the fiber optic transceiver from the modem: pull down on the fiber optic transceiver latch and pull it out of the slot.
5	Dress all disconnected cables out of the way.
6	Simultaneously press the locking tabs on both card ejector latches. Rotate both card ejector latches out from the card to disengage the card from the BCUII cage.
7	Grasp the Modem card front panel. Pull the card away from the BCUII card cage. Slide the card out of the BCUII card cage.

Perform the following procedure to install the Flex4 Modem.

Procedure 8-2 Installing the Flex4 Modem

1	<p>Insert the Modem card into the BCUII card cage as follows:</p> <ol style="list-style-type: none"> 1. Insert the Modem card side-edges into the card slot rails. 2. Rotate the card ejector latches completely out from the card front panel. 3. Slide the card completely into the BCUII card cage. 4. Make sure that the card rear-edge connectors fully engage with the mating backplane connectors. 5. Simultaneously press both card ejector latches into the card front panel. A click is heard and felt when each ejector latch locking tab engages the card front panel and seats the card into the cage.
2	<p>Reconnect all fiber-optic cabling to the corresponding connectors on the front of the Flex4 Modem. If the optical transceiver is being replaced, perform the following:</p> <ul style="list-style-type: none"> • Grasp the optical transceiver in one hand and the fiber-optic cable connector in the hand. Depress the fiber-optic cable connector release and pull the cable connector out of the transceiver.

Continued

Procedure 8-2 Installing the Flex4 Modem (Continued)

	<ul style="list-style-type: none"> • Plug the fiber-optic cable connector into the transceiver. Repeat this for each optical transceiver being replaced <p>Grasp the optical transceiver with the cable connected, and plug the optical transceiver into the appropriate receptacle on the Flex4 Modem card.</p>
<p>3</p>	<p>The Modem card should automatically initialize and become active. Note the following indication for Modem initialization:</p> <p> NOTE</p> <p>LEDs go solid green when the links are active or in-service.</p>

BCUII Site Controller Card Replacement

Objectives

The primary objective is as follows:

- Remove the failed BCUII Site Controller card from the BCUII card cage.
- Install a replacement BCUII Site Controller card in the BCUII card cage.

Preparation

Required tools

The following tools are required to remove and install a BCUII Site Controller Card.

- T10 TORX bit
- Torque driver
- ESD (Electro-Static Discharge) conductive, high impedance wrist strap

Torque requirements

When installing the BCUII Site Controller card, tighten the flex-circuit connector mounting M3 screws to:

- 1.1 N-m (10 in-lbs)

Required item



The following replacement unit is required:

- BCUII Site Controller Card STLN6725

Replacement Procedure

Perform the following procedure to remove the BCUII Site Controller card.

Procedure 8-3 Removing the BCUII Site Controller card

1	Working at the front of the frame, unlatch the front panel door of the BCUII and swing the door open.
2	<div style="background-color: yellow; border: 1px solid black; padding: 2px; display: inline-block;"> CAUTION</div> <p>The front panel door must not be pivoted open beyond 120 degrees from the closed position. A mechanical stopper pin indicates this 120 degrees position. To prevent damaging the door and the flex-circuit, DO NOT force the door open beyond the 120 degrees position.</p> <p>Working at the front of the frame, open the BCUII front panel door as follows:</p> <ol style="list-style-type: none"> 1. While holding the door latch release button depressed, grasp the top edge of the front panel door. 2. Pull the door away from the BCUII and pivot it downward to open. 3. Open the front panel door to the 90 degrees position.
3	Power down the BCUII.
4	Observe that all of the BCUII front panel LEDs are OFF.
5	<div style="background-color: yellow; border: 1px solid black; padding: 2px; display: inline-block;"> CAUTION</div> <p>ESD handling precautions must be adhered to when handling the BCUII plug-in cards. Wear a conductive, high impedance wrist strap.</p> <p>Plug the end of the ESD wrist strap into the BCUII ESD jack. This jack is located in the front of the BCUII at the right end of the Site Controller card slot. Attach the wrist strap to your wrist.</p>
6	Using a T10 TORX bit and driver, completely loosen and remove the two screws that secure the flex-circuit connector to the inside of the front panel door assembly.
7	Grasp the flex-circuit connector and disconnect it from the front panel door assembly.
8	<p>Open the front panel door to the 120 degrees position. This is the maximum open limit for the door. There is a mechanical stopper pin that indicates this 120 degrees position.</p> <div style="background-color: #0070C0; color: white; padding: 2px; display: inline-block;"> NOTE</div> <p>The power cables attached to the front of the PDU interfere with opening the BCUII front panel far enough to replace the controller. Disconnect these power cables before removing the controller.</p>
9	Locate the failed Site Controller card.



Continued

Procedure 8-3 Removing the BCUII Site Controller card (Continued)

10	Simultaneously press the locking tabs on both card ejector latches. Rotate both card ejector latches out from the card to disengage the card from the BCUII cage.
11	Grasp the Site Controller card front panel. Pull the card away from the BCUII card cage. Slide the card along with the flex-circuit out of the BCUII card cage.

Perform the following procedure to install the BCUII Site Controller card.

Procedure 8-4 Installing the BCUII Site Controller card

1	<div style="background-color: yellow; border: 1px solid black; padding: 2px; display: inline-block;"> CAUTION</div> <p>The front panel door must not be pivoted open beyond 120° from the closed position. There is a mechanical stopper pin that indicates this 120-degree position.</p> <p>To prevent damaging the door and the flex-circuit, DO NOT force the door open beyond the 120-degree position.</p> <p>Open the front panel door to the 120-degree position. This is the maximum open limit for the door.</p>
2	<div style="background-color: yellow; border: 1px solid black; padding: 2px; display: inline-block;"> CAUTION</div> <p>ESD handling precautions must be adhered to when handling the BCUII plug-in cards. Wear a conductive, high impedance wrist strap.</p> <p>Plug the end of the ESD wrist strap into the BCUII ESD jack. This jack is located in the front of the BCUII at the right end of the Site Controller card slot. Attach the wrist strap to your wrist.</p>
3	<p>Insert the Site Controller card into the BCUII card cage as follows:</p> <ol style="list-style-type: none"> 1. Insert the Site Controller card side-edges into the card slot rails. 2. Rotate the card ejector latches completely out from the card front panel. 3. Slide the card, along with the flex-circuit, completely into the BCUII card cage. 4. Make sure that the card rear-edge connectors fully engage with the mating backplane connectors. 5. Simultaneously press both card ejector latches into the card front panel. You should feel and hear a click when each ejector latch locking tab engages the card front panel and seats the card into the cage.

Continued

Procedure 8-4 Installing the BCUII Site Controller card (Continued)

4	<p>Connect the Site Controller card flex-circuit connector to the front panel door assembly as follows:</p> <ol style="list-style-type: none">1. While holding the open front panel door in the 90-degree position, connect the flex-circuit connector to the front panel door assembly.2. Insert the two M3 screws that secure the flex-circuit connector to the front panel door assembly.3. Using a T10 Torx bit and torque driver, tighten the two screws to 1.1 N-m (10 in-lbs).
5	<p>Power up the BCUII by momentarily depressing the Site Controller card power switch so that the switch actuator is in the IN/ON position.</p>
6	<p> CAUTION</p> <p>DO NOT dress the flex-circuit down into the door jam to prevent damage to the flex-circuit. The flex-circuit folds properly when the door is closed.</p> <p>Close the BCUII front panel door. Make sure that the door latch engages.</p>

eNode Frame Based Radio Replacement

Objectives

The primary objective is as follows:

- Remove the failed eNodeB Frame Based Radio.
- Install a replacement eNodeB Frame Based Radio.

Preparation

Required tools

The following tools are required to remove and install an eNodeB Frame Based Radio

- T20 TORX bit
- Torque driver
- SMA torque wrench

Required item

eNodeB Frame Based Radio

eNodeB Frame Based Radio Replacement Procedure

Perform the following procedures to replace the eNodeB Frame Based Radio

Procedure 8-5 Removing the eNodeB Frame Based Radio

1

 **NOTE**

Multiple cables must be disconnected from connectors. If necessary, use masking tape and a marker and temporarily tag each cable as to the proper connector before disconnection.

Disconnect the fiber-optic cabling from the front of the failed FBR. For fiber-optic cable connections perform the following:

Continued

Procedure 8-5 Removing the eNodeB Frame Based Radio (Continued)

	<ol style="list-style-type: none"> 1. Grasp the LC duplex connector and depress the release to remove the fiber cables from the fiber optic transceiver. 2. Remove the fiber optic transceiver from the frame based radio: pull down on the fiber optic transceiver latch and pull it out of the slot.
2	Remove the two RF connections at the front of the FBR using SMA wrench.
3	Using a T20 TORX bit and driver, completely loosen the two screws that secure the FBR.
4	Slide FBR out of the Radio / Filter Shelf.

Procedure 8-6 Installing the eNodeB Frame Based Radio

1	Insert FBR into the Radio / Filter Shelf.
2	Using a T20 TORX bit and driver, tighten the two screws that secure the FBR to 2.2 N-m (20 in-lbs).
3	Reconnect the two RF connections at the front of the FBR using SMA torque wrench.
4	Install fiber optic transceivers in to the FBR and reconnect the fiber optic cables.
5	Perform recommissioning tasks to place the unit back in service.

Filter/Duplexer Replacement

Objectives

The primary objective is as follows:

- Remove Filter/Duplexer
- Install Filter/Duplexer

Preparation

Required tools

The following tools are required to remove and install a Filter/Duplexer.

- T20 TORX bit
- Torque driver
- 10 mm hex socket
- SMA torque wrench
- N-connector torque wrench

Torque requirements

- M4 screws to 2.2 N-m (20 in-lb)
- M6 nuts to 5.1 N-m (45 in-lb)

Required item

700 MHz Upper C band Filter/Duplexer STFF4046

Filter/Duplexer Replacement Procedure

Perform the following procedures to replace the Filter/Duplexer.

Procedure 8-7 Removing the Filter/Duplexer

1	Remove Radio/Filter Shelf.
2	Remove the 2 RF cables (RxA and RxB) at the rear of the Duplexer.
3	Using a 10 mm socket and 3-inch socket extension, remove the two M6 nuts at the bottom of the Radio/Filter shelf.
4	Using a T20 Torx, remove the two M4 screws at the front face of the Radio/Filter Shelf Duplexer body.
5	Remove the Filter/Duplexer unit from the Radio/Filter Shelf.

Procedure 8-8 Installing Filter/Duplexer

1	Insert the Filter/Duplexer into the Radio/Filter Shelf avoiding the 2 RF cables.
2	Pull the Filter/Duplexer towards the front so the Filter/Duplexer body rests against the inside front face of the Radio/Filter Shelf chassis.
3	Using a T20 Torx, screw two M4 screws through the front face of the Radio/Filter Shelf into the Duplexer body. Torque to 1.8 N-m (16 in-lb).
4	Using a 10 mm socket and 3-inch socket extension, secure the Filter/Duplexer to the two M6 studs at the bottom of the Radio/Filter Shelf with two M6 nuts. Torque to 5.1 N-m (45 in-lb).
5	Mate the 2 RF cables at the rear of the Filter/Duplexer. Ensure that the cable bends are no less than 6 mm (1/4 inch) diameter.

Radio/Filter Shelf Fan Tray Replacement

Objective

The objective is as follows:

- Remove Radio/Filter Shelf Fan Tray
- Install Radio/Filter Shelf Fan Tray

Preparation

Required tools

The following tools are required to remove and install the Radio/Filter Shelf Fan Tray.

- T25 TORX bit
- Driver

Required item

The following replacement unit is required:

- RFS Fan Tray Motorola model STLN6904

Radio/Filter Shelf Fan Tray replacement procedure

Perform the following procedures to replace the RFS Fan Tray

Procedure 8-9 Replacing the RFS Fan tray

1	Insert the T25 TORX bit into the recess in the locking cam on the front of the fan tray.
2	Using driver, rotate cam 90 degrees counter clockwise (orientation dot aligns with the unlocked lock feature on the front of the fan tray. See Figure 8-1).
3	Slide the fan tray assembly out of the front of the radio shelf.
4	Slide the new fan tray assembly into the radio shelf.
5	Insert the T25 TORX bit into the recess in the locking cam on the front of the fan tray.
6	Using a driver, rotate cam 90 degrees clockwise (orientation dot aligns with the locked lock feature on the front of the fan tray. See Figure 8-2).
7	Restore power to the radio shelf (if needed, fan tray is hot-pluggable).

Figure 8-1 RFS fan tray in unlocked position

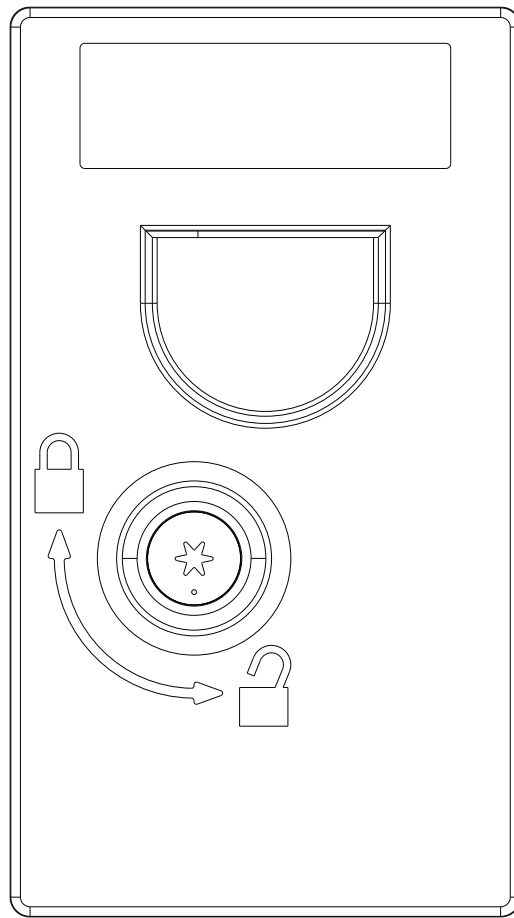
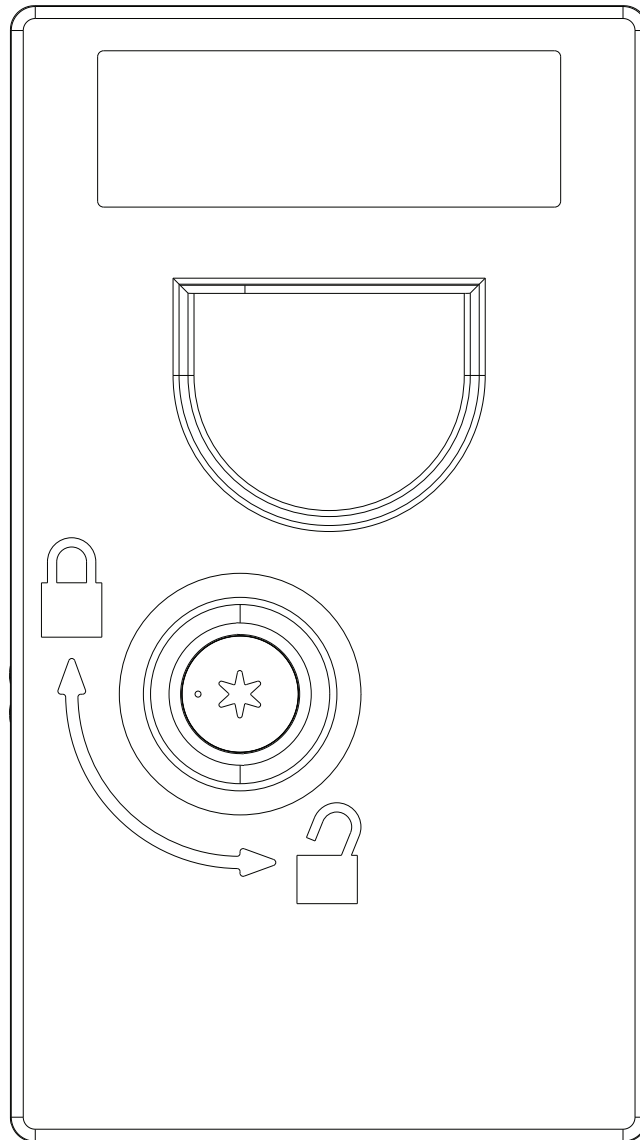

Figure 8-2 RFS fan tray in locked position



Q-HSO (Quartz High Stability Oscillator) Replacement

Q-HSO (Quartz High Stability Oscillator) Replacement

Objective

The objective is as follows:

- Remove the BCUII card cage assembly from the frame
- Replace the Q-HSO located on the rear panel of the BCUII card cage assembly
- Reinstall the BCUII card cage assembly in the frame

Introduction

The optional Q-HSO is located on the BCUII rear panel (see [Figure 8-3](#)). It is mounted in the middle of the rear panel between the fan tray and the PSU.

The Q-HSO is a backup synchronization source for maintaining BTS system timing established/sourced by either the optional RF GPS receiver module located in the front panel door assembly.

The Q-HSO contains a high stability quartz crystal oscillator.

The Q-HSO has a 9-pin D-connector that connects to the **MSO** connector on the BCUII rear panel. This connection allows the BCUII to supply DC power to the Q-HSO. In addition, control/data signals are exchanged between the BCUII Site Controller card and the Q-HSO through this connection.

The Q-HSO provides a 1 Pulse Per Second (1PPS) timing signal. This 1PPS signal is applied to the Site Controller card.

If GPS satellite tracking is lost or if the RF GPS receiver module fails, the Q-HSO maintains BTS system timing for up to 24 hours.

Preparation

Required tools

The following tools are required to remove and install a Q-HSO:

- T20 TORX bit
- Torque driver

Torque requirements

When installing the Q-HSO, tighten the Q-HSO M4 thumbscrew to:

- 2.3 N-m (20 in-lbs)

Required item

The following replacement unit is required:

- Q-HSO, Motorola model SGLA4017

Q-HSO replacement procedure

Perform the steps described in [Procedure 8-10](#) to replace the Q-HSO.

Procedure 8-10 Replacing the Q-HSO

1	Remove the BCUII card cage assembly from the frame.
2	Locate the Q-HSO on the BCUII rear panel.
3	Using a T20 TORX bit and driver, loosen the thumbscrew on the Q-HSO (see Figure 8-3). Using your thumb and finger, completely loosen the captive thumbscrew.
4	Grasp the top end (that is, the thumbscrew end) of Q-HSO and pull it away from the BCUII rear panel until the 9-pin D-connectors are fully disengaged.
5	Slide the Q-HSO until the tab on the bottom end of the Q-HSO is disengaged from the retaining slot on the BCUII rear panel.
6	With the replacement Q-HSO properly positioned, insert the tab on the bottom end of the Q-HSO under the retaining slot on the BCUII rear panel.
7	Align the Q-HSO 9-pin D-connector with the MSO connector on the BCUII rear panel. Firmly push the top end of the Q-HSO against the BCUII rear panel until the connectors are fully engaged.
8	Align the Q-HSO thumbscrew with the threaded hole. Using a T20 TORX bit and driver, tighten the thumbscrew to 2.3 N-m (20 in-lbs).
9	Reinstall the BCUII card cage assembly into the frame according the steps in Procedure 8-12 Reinstalling card cage assembly on page 8-23 .

Reference diagram

The following diagram helps clarify and support certain steps of [Procedure 8-10](#).

Figure 8-3 Q-HSO removal and installation

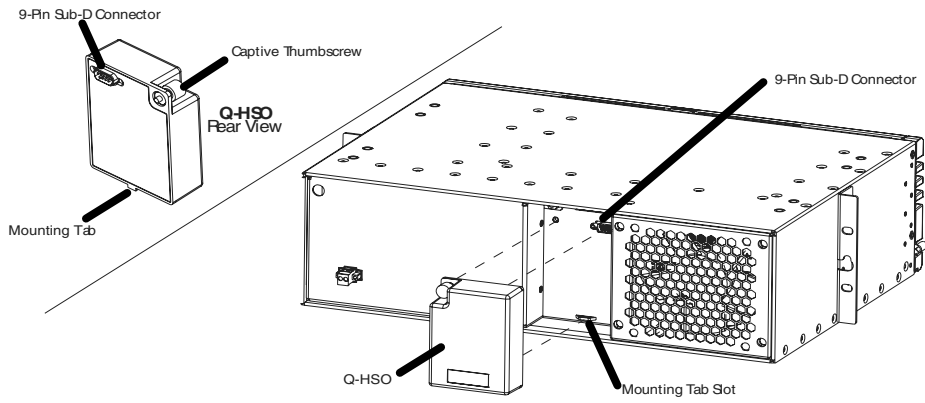

ti-cdma-05694.eps

ti-cdma-05694.eps

BCUII card cage assembly replacement procedures

Perform the following procedure to remove the BCUII card cage assembly from the frame.

Objectives

The primary objective is as follows:

- Remove the failing BCUII card cage assembly from the frame
- Replace a FRU on the rear panel of the BCUII card cage assembly
- Reinstall the BCUII card cage assembly in the frame

Introduction

The BCUII card cage assembly provides a rack mountable facility for housing all of the BCUII electronics. It also provides interconnection of the BCUII electronics as well as connection to the external customer and site equipment.

The BCUII card cage assembly includes: backplane, front panel door assembly, and fan tray; all installed.

Preparation

Required tools

The following tools are required to remove and install a BCUII card cage assembly.

- T20 TORX bit
- T30 TORX bit
- T10 TORX bit
- 10 mm socket
- 3/8 inch ratchet
- Flat-blade screwdriver
- Torque driver
- ESD (Electro-Static Discharge) conductive, high impedance wrist strap

Torque requirements

When installing the built-up BCUII card cage, tighten the corresponding fasteners as follows:

- BCUII ground wire lug M6 nuts – 4.5 N-m (39.8 in-lb)
- Fiber cover M4 screws – 2.3 N-m (20 in-lbs)

Required item

The following replacement unit is required:

- BCUII card cage assembly, Motorola part number SGLN1945

Replacement Procedure

Perform the steps in [Procedure 8-11](#) and [Procedure 8-12](#) to replace the BCUII card cage.

Procedure 8-11 Removing the BCUII card cage

1	<div style="background-color: yellow; border: 1px solid black; padding: 2px; display: inline-block;"> CAUTION</div> <p>The front panel door must not be pivoted open beyond 120 degrees from the closed position. There is a mechanical stopper pin that indicates this 120 degrees position. To prevent damaging the door and the flex-circuit, DO NOT force the door open beyond the 120 degrees position.</p> <p>Working at the front of the frame, open the BCUII front panel door as follows:</p> <ol style="list-style-type: none"> 1. While holding the door latch release button depressed, grasp the top edge of the front panel door. 2. Pull the door away from the BCUII and pivot it downward to open. 3. Open the front panel door to the 90 degrees position.
2	On the right end of the Site Controller card front panel, locate the power ON/OFF switch.
3	Power down the BCUII by momentarily depressing the power switch so that the switch actuator is in the OUT/OFF position.
4	Observe that all of the BCUII front panel LEDs are OFF.
5	Set the external BCUII power source to OFF.
6	Disconnect all of the cables connected to connectors on the outside of the BCUII front panel door. Dress these cables away from the front of the BCUII.

Continued

Procedure 8-11 Removing the BCUII card cage (Continued)

7	Remove the fiber cover attached to the BCUII card cage front left corner. The two screws securing the fiber cover are located just inside the open front panel door (see Figure 8-4). Using a T20 TORX bit and driver, loosen and remove the two screws. Grasp the fiber cover and pull it away and out from the BCUII card cage.
8	Locate the ground wire, with the double hole lug, attached to the BCUII card cage front left corner just inside the open front panel door (see). Disconnect the ground wire lug by using a 10 mm socket and ratchet to loosen and remove the two M6 nuts that secure the ground wire lug to the threaded studs.
9	<p> NOTE</p> <p>Multiple cables are being disconnected from the connectors. If necessary, use masking tape and a marker and temporarily tag each cable as to the proper connector before disconnection.</p> <p>Disconnect the fiber-optic cabling and any other cabling from the front of the Modem cards. For fiber-optic cable connections perform the following:</p> <ol style="list-style-type: none"> 1. Grasp the optical transceiver by the connector at the Modem card. 2. Depress the optical transceiver connector release and pull the transceiver, along with the cable, out of the Modem card receptacle.
10	Pull out the loose ends of fiber-optic cables through the grommet openings. Move the fiber-optic cables and the disconnected ground wire with lug out of the front of the BCUII. Dress these cables away from the front of the BCUII.
11	Remove the BCUII rack mounting screws as follows: <ol style="list-style-type: none"> 1. Using the appropriate driver, loosen and remove all but one of the screws in each side mount bracket. 2. While supporting the BCUII card cage, remove the remaining screw in each side mount bracket.
12	Grasp the BCUII card cage and pull it partially out of the frame to access the rear panel.
13	Disconnect all of the cables connected to connectors on the rear of the BCUII. These cables include: <ul style="list-style-type: none"> ● Cable connected to the input power connector located on the lower left corner of the PSU.
14	Completely pull the BCUII card cage out of the frame and move it to a work surface.

Figure 8-4 BCUII Fiber Cover



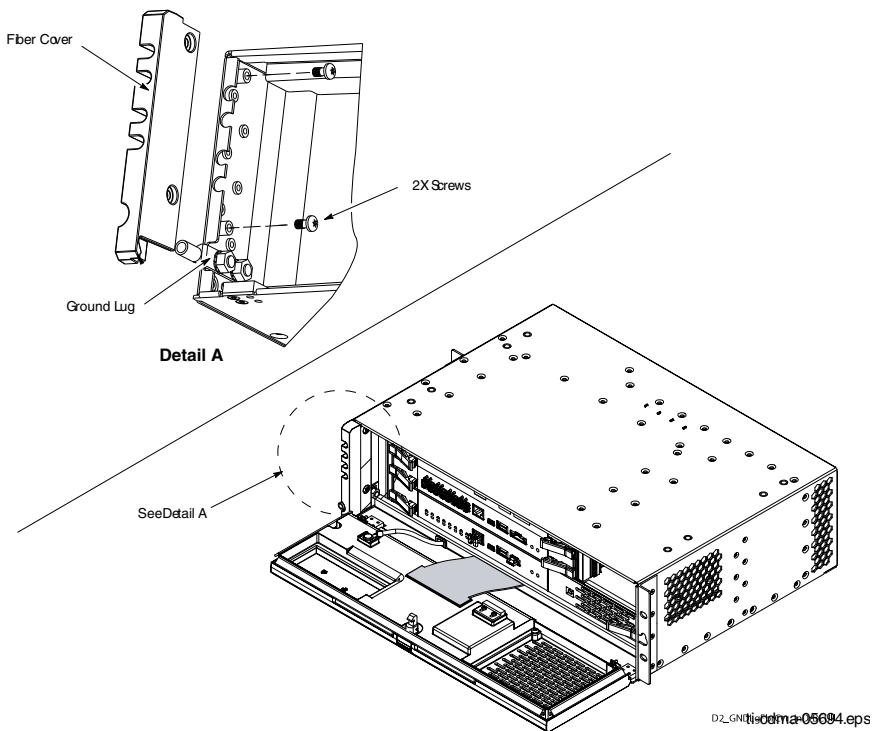

Reinstall card cage assembly

Procedure 8-12 Reinstalling card cage assembly

1	Position the built-up replacement BCUII card cage assembly in front of the frame.
2	Partially insert the BCUII card cage into the frame, so the rear panel can still be accessed.
3	<p>Reconnect the corresponding cables to the connectors on the rear of the BCUII. These cables include:</p> <ol style="list-style-type: none"> 1. Cable connection to the -48 V dc input power connector located on the lower left corner of the -48 V dc PSU (as viewed from the rear of the BCUII). 2. Using a flat-blade screwdriver, tighten the two retaining screws on the power connector.

Continued

Procedure 8-12 Reinstalling card cage assembly (Continued)

4	<p>Completely insert the BCUII card cage into the frame. Align the holes in each side mounting bracket with the applicable holes in the frame rails. While supporting the BCUII card cage, insert screws into the top and bottom holes in each side mounting bracket. Using the appropriate driver, tighten the screws to the proper torque specification.</p>
5	<p>Open the front panel door to the 90 degrees position.</p>
6	<p>Route the disconnected ground wire with the double hole lug through the appropriate cable groove, located at the BCUII card cage front left corner, and into the inside of the door panel area (see Figure 8-4).</p> <p> NOTE</p> <p style="padding-left: 40px;">If the replacement BCUII card cage already has a lug installed, remove it before proceeding to step 7.</p>
7	<p>Attach the ground wire double hole lug to the threaded studs located at the BCUII card cage front left corner. Secure the ground wire lug to the threaded studs with the two M6 nuts. Using a 10 mm socket and torque driver, tighten the nuts to 4.5 N-m (39.8 in-lb).</p>
8	<p>Route the disconnected fiber-optic cables through the appropriate openings in the grommet located at the BCUII card cage front left corner, and into the inside of the door panel area.</p>
9	<p>Reconnect all fiber-optic cabling to the corresponding connectors on the front of the Modem cards. Grasp the optical transceiver, with the cable connected, and plug the optical transceiver into the appropriate receptacle on the Modem card. Repeat this step for each fiber-optic cable.</p>
10	<p>Attach the fiber cover to the BCUII card cage front left corner (see Figure 8-4). Secure the fiber cover with the two M4 screws. Using a T20 TORX bit and torque driver, tighten the screws to 2.3 N-m (20 in-lbs).</p>
11	<p>Reconnect all of the cables to the corresponding connectors on the outside of the BCUII front panel door.</p>
12	<p>Set the external BCUII power source to ON.</p>
13	<p>Power up the BCUII by momentarily depressing the Site Controller card power switch so that the switch actuator is in the IN/ON position.</p>
14	<p> CAUTION</p> <p style="padding-left: 40px;">DO NOT dress the flex-circuit down into the door jam to prevent damage to the flex-circuit. The flex-circuit folds properly when the door is closed.</p> <p>Close the BCUII front panel door. Make sure that the door latch engages.</p>

BCUII Fan Tray Replacement

Objectives

The primary objective is as follows:

- Remove the BCUII card cage assembly from the frame
- Replace the fan tray located on the rear panel of the BCUII card cage assembly
- Reinstall the BCUII card cage assembly in the frame

Introduction

The fan tray is mounted in the right side of the BCUII rear panel as viewed from the rear of the BCUII (see [Figure 8-5](#)). The fan tray contains a single fan. The fan draws cool air in from the air intake located along the front of the BCUII. The cool air passes through the entire BCUII and over/under all of the BCUII internal circuitry. The fan exhausts the cooling air out the rear of the BCUII. The electrical connections for both DC operating power and the fan control/monitoring signals are made through a cable that is part of the fan tray. The fan tray cable connector plugs into the BCUII backplane. This connection is made manually and is accessible through the front of the BCUII after removing the Site Controller and Modem 1 cards.

Preparation

Required tools

The following tools are required to remove and install a BCUII fan tray.

- T20 TORX bit
- Torque driver
- ESD (Electro-Static Discharge) conductive, high impedance wrist strap

Torque requirements

When installing the BCUII fan tray, tighten the captive M4 mounting screws to:

- 2.3 N-m (20 in-lbs)

Required item



The following replacement unit is required:

- Fan tray, Motorola model SGLN1946

Replacement Procedure

Perform the steps described in [Procedure 8-13](#) to remove the BCUII fan tray.

Procedure 8-13 Removing the BCUII fan tray

1	Remove the BCUII card cage assembly from the frame according the steps in Replacement Procedure on page 8-3
2	Working at the front of the BCUII card cage, unlatch the front panel door of the BCUII and swing the door open.
3	<div style="background-color: #ffff00; padding: 2px; display: inline-block;"> CAUTION</div> <p>The front panel door must not be pivoted open beyond 120 degrees from the closed position. There is a mechanical stopper pin that indicates this 120 degrees position. To prevent damaging the door and the flex-circuit, DO NOT force the door open beyond the 120 degrees position.</p> <p>Working at the front of the frame, open the BCUII front panel door as follows:</p> <ol style="list-style-type: none"> 1. While holding the door latch release button depressed, grasp the top edge of the front panel door. 2. Pull the door away from the BCUII and pivot it downward to the open. 3. Open the front panel door to the 90 degrees position.
4	<div style="background-color: #ffff00; padding: 2px; display: inline-block;"> CAUTION</div> <p>ESD handling precautions must be adhered to when handling the BCUII plug-in cards. Wear a conductive, high impedance wrist strap.</p> <p>Plug the end of the ESD wrist strap into the BCUII ESD jack. This jack is located in the front of the BCUII at the right end of the Site Controller card slot. Attach the wrist strap to your wrist.</p>

Continued

Procedure 8-13 Removing the BCUII fan tray (Continued)

5	<p>Remove the Site Controller card as follows:</p> <ol style="list-style-type: none"> 1. Locate the Site Controller card. 2. Hold the open front panel door in the 90 degrees position. 3. Using a T10 TORX bit and driver, completely loosen and remove the two screws that secure the flex-circuit connector to the inside of the front panel door assembly. 4. Grasp the flex-circuit connector and disconnect it from the front panel door assembly. 5. Open the front panel door to the 120 degrees position. This is the maximum open limit for the door. There is a mechanical stopper pin that indicates this 120 degrees position. 6. Simultaneously press the locking tabs on both card ejector latches. Rotate both card ejector latches out from the card to disengage the card from the BCUII cage. 7. Grasp the Site Controller card front panel. Pull the card away from the BCUII card cage. Slide the card, along with the flex-circuit, out of the BCUII card cage.
6	Remove the Modem 1 card by performing the steps in Procedure 8-1 Removal of Flex4 Modem
7	Reach in through the vacant Site Controller card and Modem 1 card slots toward the fan tray and the left end of the BCUII cage backplane. Locate the fan tray cable connector that is plugged into the BCUII backplane.
8	Disconnect the fan tray cable connector by grasping the connector and pulling it away from the backplane.
9	Locate the fan tray on the BCUII rear panel.
10	Using a T20 TORX bit and driver, completely loosen the four captive screws that secure the fan tray to the rear of the BCUII (see Figure 8-5). There is captive screw located in each corner of the fan tray.
11	<p> NOTE</p> <p>It may be necessary to reach in through the vacant card slots and push the fan tray out the rear of the BCUII.</p> <p>Grasp the fan tray and pull it out from the rear of the BCUII.</p>

Perform the steps described in [Procedure 8-14](#) to install the fan tray.

Procedure 8-14 Installing the BCUII fan tray

1	With the replacement fan tray properly positioned, insert the fan tray and cable into the opening on the rear of the BCUII (See Figure 8-5). Be sure that the fan tray cable does not get pinched.
2	At the front of the BCUII, reach in through the vacant Site Controller card and Modem 1 card slots toward the fan tray and the left end of the BCUII cage backplane. Locate the fan tray cable connector and plug it into the BCUII backplane.
3	Secure the fan tray to the rear of the BCUII as follows (See Figure 8-5): <ol style="list-style-type: none"> 1. Using a T20 Torx bit and driver, hand tighten the four captive screws. 2. Use an alternating diagonal screw tighten pattern. 3. After hand tightening, use a T20 Torx bit and torque driver to tighten the four captive screws to 2.3 N-m (20 in-lbs).
4	Working at the front of the BCUII card cage, reinstall the Modem 1 card by performing the steps in Procedure 8-2 .
5	Reinstall the Site Controller into the BCUII card cage as follows: <ol style="list-style-type: none"> 1. Insert the Site Controller card side-edges into the card slot rails. 2. Rotate the card ejector latches completely out from the card front panel. 3. Slide the card, along with the flex-circuit, completely into the BCUII card cage. 4. Make sure that the card rear-edge connectors fully engage with the mating backplane connectors. 5. Simultaneously press both card ejector latches into the card front panel. Feel and hear a click when each ejector latch locking tab engages the card front panel and seats the card into the cage.
6	Connect the Site Controller card flex-circuit connector to the front panel door assembly as follows: <ol style="list-style-type: none"> 1. While holding the open front panel door in the 90-degree position, connect the flex-circuit connector to the front panel door assembly. 2. Insert the two M3 screws that secure the flex-circuit connector to the front panel door assembly. 3. Using a T10 Torx bit and torque driver, tighten the two screws to 1.1 N-m (10 in-lbs).
7	Reinstall the BCUII card cage assembly into the frame by performing the steps in Procedure 8-12 Reinstalling card cage assembly on page 8-23 .

Figure 8-5 Fan tray removal and installation

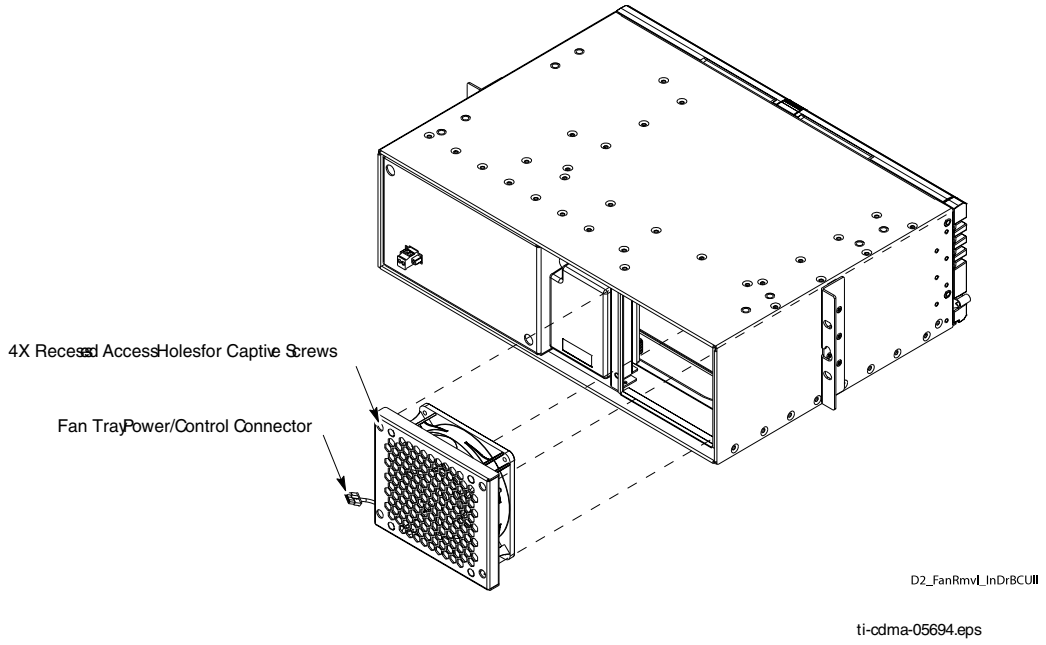

eNodeB PDU Replacement

Objective

The objective is as follows:

- Remove eNodeB PDU
- Install replacement eNodeB PDU

Preparation

Required tools

The following tools are required to remove and install the eNodeB PDU.

- Torque Wrenches
 - SMA Torque Wrench
 - Torque driver capable of driving bits at .
 - Torque driver capable of torquing 10 mm socket to 5.1 N-m (45 in-lb).
- Bit Driver and Bits
 - TORX Driver
 - T20 TORX bit
 - T25 TORX bit
 - T30 TORX bit
 - Torque driver
 - 10 mm socket
 - Flat Blade Screwdriver Bit
- Zip ties
- ESD (Electro-Static Discharge) conductive, high impedance wrist strap

Torque requirements

- 1.1 N-m (10 in-lb), 1.3 N-m (12 in-lb)
- M4 screws 1.8 N-m (16 in-lb)
- M5 screws 4.7 N-m (42 in-lb)
- M6 x 16 screws 5.1 N-m (45 in-lb)

Required item

The following replacement unit is required:

- eNodeB PDU +27 V dc, Motorola model STLN6905
- eNodeB PDU -48 V dc, Motorola model STLN6906

eNodeB PDU replacement procedure

Procedure 8-15 Replacing the eNodeB PDU

1	Remove source power.
2	Disconnect the source power cable and the ground cable (if equipped) at the source if required for adequate service loop.
3	Unplug all power cables.
4	Using a DVM, confirm that there is no voltage on the PDU.
5	Using a T25 Torx driver, loosen and remove the four rack mounting screws that secure the PDU to the rack. Remove the PDU from the rack.
6	Using a T30 Torx driver, remove the power lugs from the PDU through the access panel.

Procedure 8-16 Installing PDU to Rack

1	<p>Mount the PDU in the 19-inch rack.</p> <p> NOTE</p> <p>Mount the PDU in the same rack unit as the PDU that was removed in Procedure 8-15.</p> <p>If other equipment are mounted above the PDU, the source power cable must be connected before installing the PDU.</p>
----------	---

Continued

Procedure 8-16 Installing PDU to Rack (Continued)

2	Using the same four rack mounting screws, install two screws per side using a T25 Torx bit and torque to 4.7 N-m (42 in-lb).
3	Perform the steps in Procedure 3-5 to reconnect power to the PDU.
4	If using a non-Motorola rack, perform the steps in Procedure 3-4 to ground the PDU.

Figure 8-6 PDU

PDU front.eps