



MOTOROLA

Cellular Networks

APPLICANT: MOTOROLA

FCC ID: IHET5GX1

Installation Manual Exhibit

UBS CDMA XMI Transceiver at 800MHz

R20 1X UBS Macro BTS Hardware Installation

Accuracy

While reasonable efforts have been made to assure the accuracy of this document, Motorola, Inc. assumes no liability resulting from any inaccuracies or omissions in this document, or from use of the information obtained herein. Motorola, Inc. reserves the right to make changes to any products described herein to improve reliability, function, or design, and reserves the right to revise this document and to make changes from time to time in content hereof with no obligation to notify any person of revisions or changes. Motorola, Inc. does not assume any liability arising out of the application or use of any product, software, or circuit described herein; neither does it convey license under its patent rights or the rights of others. It is possible that this publication may contain references to, or information about Motorola products (machines and programs), programming, or services that are not announced in your country. Such references or information must not be construed to mean that Motorola intends to announce such Motorola products, programming, or services in your country.

Copyrights

This document, Motorola products, and 3rd Party Software products described in this document may include or describe copyrighted Motorola and other 3rd Party supplied computer programs stored in semiconductor memories or other media. Laws in the United States and other countries preserve for Motorola, its licensors, and other 3rd Party supplied software certain exclusive rights for copyrighted material, including the exclusive right to copy, reproduce in any form, distribute and make derivative works of the copyrighted material. Accordingly, any copyrighted material of Motorola, its licensors, or the 3rd Party software supplied material contained in the Motorola products described in this document may not be copied, reproduced, reverse engineered, distributed, merged or modified in any manner without the express written permission of Motorola. Furthermore, the purchase of Motorola products shall not be deemed to grant either directly or by implication, estoppel, or otherwise, any license under the copyrights, patents or patent applications of Motorola or other 3rd Party supplied software, except for the normal non-exclusive, royalty free license to use that arises by operation of law in the sale of a product.

A list of 3rd Party supplied software copyrights are contained in the Supplemental information section of this document.

Restrictions

Software and documentation are copyrighted materials. Making unauthorized copies is prohibited by law. No part of the software or documentation may be reproduced, transmitted, transcribed, stored in a retrieval system, or translated into any language or computer language, in any form or by any means, without prior written permission of Motorola, Inc.

License Agreements

The software described in this document is the property of Motorola, Inc and its licensors. It is furnished by express license agreement only and may be used only in accordance with the terms of such an agreement.

High Risk Materials

Components, units, or 3rd Party products used in the product described herein are NOT fault-tolerant and are NOT designed, manufactured, or intended for use as on-line control equipment in the following hazardous environments requiring fail-safe controls: the operation of Nuclear Facilities, Aircraft Navigation or Aircraft Communication Systems, Air Traffic Control, Life Support, or Weapons Systems (High Risk Activities). Motorola and its supplier(s) specifically disclaim any expressed or implied warranty of fitness for such High Risk Activities.

Trademarks



MOTOROLA

Motorola and the Stylized M Logo are registered in the US Patent & Trademark Office. All other product or service names are the property of their respective owners.



The CE mark confirms Motorola, Inc. statement of compliance with EU directives applicable to this product. Copies of the Declaration of Compliance and installation information in accordance with the requirements of EN50385 can be obtained from the local Motorola representative or by contacting the Customer Network Resolution Center (CNRC). The 24 hour telephone numbers are listed at <https://mynetworksupport.motorola.com>. Select **Customer Network Resolution Center contact information**. Alternatively if you do not have access to CNRC or the internet, contact the Local Motorola Office.

Contents

R20 1X UBS Macro BTS Hardware Installation

Revision history	3
Version information	3
Resolution of Service Requests	3
Incorporation of Change Notices	3
General information	4
Purpose	4
Cross references	4
Text conventions	5
Contacting Motorola	6
24-hour support	6
Questions and comments	6
Errors	6
Security advice	7
Warnings, cautions, and notes	8
Warnings	8
Cautions	8
Notes	8
Safety	9
General safety	9
Electromagnetic energy	9
Caring for the environment	10
In EU countries	10
In non-EU countries	10
CMM labeling and disclosure table	11
Motorola document set	12
Ordering documents and CD-ROMs	12
Document banner definitions	12
Data encryption	12
Third Party Computer Software and Trademarks	13
Computer Software	13
Trademarks	13

Chapter 1: Introduction and Frame Identification

Abbreviations and Acronyms	1-2
Abbreviations and Acronyms	1-2
Overview	1-5
Scope of manual	1-5
Prerequisites	1-5
Chapter 1 - Introduction and frame identification	1-5
Chapter 2 – UBS Macro BTS installation procedure	1-6
Chapter 3 - Low-to-Mid Capacity Frame Expansion Procedures	1-6

Chapter 4 - What's next	1-6
Equipment shipped assembled	1-6
Equipment shipped un-assembled	1-6
Follow the task sequence	1-7
Follow the site plan	1-7
Site cleanliness	1-7
Site manager.	1-7
Color coding	1-7
Rack vs. frame	1-8
Required documentation.	1-8
Equipment may vary from figures	1-8
Item identification	1-9
UBS Macro BTS frames	1-9
Items to be installed	1-15
Tools and materials	1-16
Required tools and materials.	1-16
Recommended tools	1-17
Unpacking Instructions	1-18
Unpacking the carrier strip assembly	1-18
Unpacking accessory equipment.	1-20

Chapter 2: UBS Macro BTS Installation Procedure

Overview	2-2
Introduction	2-2
Structural engineer	2-2
Required items.	2-2
Cabling and configuration options	2-2
Color coding	2-2
Cable list, diagrams and connectors	2-4
Overview.	2-4
UBS Macro BTS external I/O cable run list	2-4
Connector locations	2-6
Full installation sequence	2-11
Overview.	2-11
Prerequisites.	2-11
Verifying site and equipment.	2-11
Physical installation	2-11
Site verification	2-15
Site installation checks	2-15
Temperature range	2-16
Frame physical dimensions	2-16
Frame clearances	2-16
Frame DC input power and power cabling information	2-17
Frame positioning	2-18
Rack base description and dimensions.	2-18
Task 1: Installing RGPS Head	2-20
Objective.	2-20
RGPS head installation.	2-20
Tasks 2-3: Installing Rack & Ground Cable	2-28
Objectives	2-28
Rack requirements.	2-28
Structural engineer prerequisite.	2-28
Required items.	2-29
Location of rack earth ground terminals	2-30
Procedure	2-30
Task 4: Rack Mounting the Optional PSM Shelf	2-32
Objectives	2-32

- Required items 2-32
- Procedure 2-32
- Procedural reference diagrams 2-34
- Task 5: Rack Mounting for Low-Capacity Frame 2-36
 - Objective. 2-36
 - Required items. 2-36
 - Procedure 2-37
 - Procedural reference diagrams 2-38
- Task 6: Expanding the Low-capacity Frame 2-42
 - Objective. 2-42
 - Procedure 2-42
- Task 7: Cabling the Optional PSM Shelf 2-43
 - Objectives 2-43
 - Required items. 2-43
 - Procedure 2-43
- Tasks 8-9: Connecting TX/RX Antennas 2-44
 - Objectives 2-44
 - Required items. 2-44
 - Location of antenna connectors 2-44
 - Procedure 2-44
- Tasks 10-13: Connecting RGPS, Spans, Customer Alarms 2-46
 - Objectives 2-46
 - Cabling options 2-46
 - Required items. 2-47
 - Location of cables AA, W and X 2-47
 - Balanced T1/E1 cable (W) details 2-47
 - Customer alarm input/output (IP/OP) cable (X) details. 2-49
- Task 14: Connecting +27 V DC Power 2-55
 - Objectives 2-55
 - Frame power cables and connector information 2-55
 - Required items. 2-56
 - Power cabling and tie down requirements 2-57
 - Contact/lug, DC connector housing and PDU input power 2-57
 - Procedure 2-58
- Task 15: Connecting -48 V DC Power 2-60
 - Objectives 2-60
 - Frame power cables and connector information 2-60
 - Required items. 2-61
 - Power cabling and tie down requirements 2-62
 - Contact/lug, DC connector housing and PDU input power 2-62
 - Procedure 2-63
- Task 16: Connecting 220 V AC Power 2-65
 - Objectives 2-65
 - Frame AC power cables and wiring information 2-65
 - Required items. 2-66
 - AC PSM shelf AC power input detail 2-66
 - Procedure 2-68

Chapter 3: Low-to-Mid Capacity Frame Expansion Procedures

- Low-to-Mid Capacity Frame Expansion Overview 3-2
 - How to use this chapter 3-2
- Adding Circuit Breakers/Connectors to PDU 3-3
 - Objective. 3-3
 - Required items. 3-3
 - Procedure 3-4
 - Procedural reference diagram 3-6
- Adding an XMI 3-7

- Objective. 3-7
- Required items. 3-7
- Procedure 3-8
- Procedural reference diagram 3-9
- Adding a DMI 3-11
 - Objective. 3-11
 - Required items. 3-11
 - Prerequisite 3-12
 - Procedure 3-12
 - Procedural reference diagram 3-14
- Adding a Second Set of IDRFs 3-15
 - Objective. 3-15
 - Required items. 3-15
 - Procedure 3-16
 - Procedural reference diagram 3-17
- Adding an Optional RX Splitter 3-18
 - Objective. 3-18
 - Required items. 3-18
 - Procedure 3-18
 - Procedural reference diagram 3-19
- Adding a third PSM (-48 V or 220 V AC only) 3-20
 - Objective. 3-20
 - Required items. 3-20
 - Procedure 3-21
- Mid-capacity Expansion Interconnect Cabling 3-22
 - Objective. 3-22
 - Installing DC power cables. 3-22
 - Installing/Connecting RF cables (XMI to IDRF) 3-25
 - Installing XMI to DMI cables. 3-28
 - Installing DMI to SSI cables 3-29
 - Installing RX splitter to XMI RX RF cables or RX share cable 3-30

Chapter 4: What’s Next

- Installation completion. 4-2
 - Clean up the site 4-2
 - Fill out the installation completion checklist 4-3
 - Record “As-Built” information 4-4
 - Performing the ATPs 4-4
 - Loading the software 4-4

List of Figures

Figure 1-1: UBS Macro BTS low-tier/low-capacity frame (1000 mm rack)	1-10
Figure 1-2: Low capacity UBS Macro BTS starter frame (1800 mm rack)	1-11
Figure 1-3: UBS Macro BTS mid-capacity frame (1800 mm rack)	1-12
Figure 1-4: High capacity 800 MHz UBS Macro BTS fully expanded frame (1800 mm rack) . . .	1-13
Figure 1-5: High-capacity 1.9 GHz UBS Macro BTS fully expanded frame (1800 mm rack) . . .	1-14
Figure 1-6: Items to install.	1-15
Figure 1-7: Carrier strip assembly with inner carton support	1-19
Figure 1-8: Carrier strip assembly with inner carton support removed	1-19
Figure 2-1: 800 MHz IDRf I/O connectors	2-7
Figure 2-2: 1.9 GHz IDRf I/O connectors	2-7
Figure 2-3: SSI front panel connectors.	2-9
Figure 2-4: PSM shelf front panel connectors	2-10
Figure 2-5: Rack footprint	2-19
Figure 2-6: RGPS cabling diagram.	2-21
Figure 2-7: RGPS wiring	2-22
Figure 2-8: RGPS lightning arrestor wiring	2-23
Figure 2-9: RGPS heads	2-24
Figure 2-10: Installing the RGPS head.	2-25
Figure 2-11: Connector pin numbering for cables NN and AA	2-26
Figure 2-12: Location of ground terminals on a Motorola rack.	2-30
Figure 2-13: Hanger screw layout for the optional PSM shelf	2-34
Figure 2-14: Hanging the PSM shelf.	2-35
Figure 2-15: Hanger screw layout for UBS Macro carrier strip assembly	2-39
Figure 2-16: Lifting and hanging the carrier strip assembly on the rack.	2-40
Figure 2-17: Carrier strip assembly keyhole screw locations	2-41
Figure 2-18: T1/E1 balanced span line cable (W) pin numbering.	2-47
Figure 2-19: Customer alarm cable (X) pin numbering.	2-51
Figure 2-20: +27 V DC power input cable (DC) wire tie-wrap example	2-57
Figure 2-21: +27 V DC power input cable (DC) connector and connection to PDU.	2-58
Figure 2-22: 48 V DC power input cable (CC) wire tie-wrap example	2-62
Figure 2-23: 48 V DC power input cable (CC) connector and connection to PSM shelf.	2-63
Figure 2-24: AC PSM shelf AC power input terminal block and wiring details	2-67
Figure 3-1: Adding a Breaker Assembly Module to the PDU	3-6
Figure 3-2: Installing a 2nd XMI	3-10
Figure 3-3: Installing a 2nd DMI.	3-14
Figure 3-4: Installing the second set of IDRfS	3-17
Figure 3-5: Mounting the RX splitter	3-19

List of Tables

Table 1: Manual version history	3
Table 1-1: Abbreviations and Acronyms	1-2
Table 2-1: Color code – DC power connectors/cables	2-3
Table 2-2: Color code - RF Equipment and Connectors/Cables	2-3
Table 2-3: UBS Macro BTS external I/O cable run list	2-4
Table 2-4: Frame dimensions	2-16
Table 2-5: Minimum frame clearances for airflow	2-16
Table 2-6: Minimum frame clearances for maintenance - front access only	2-16
Table 2-7: Minimum frame clearances for maintenance - front and rear access	2-17
Table 2-8: +27 V DC and –48 V DC Frame Power Cabling and Power Supply Breaker Information	2-17
Table 2-9: List of required cables for RGPS head installation	2-20
Table 2-10: Pinout for cables NN and AA	2-26
Table 2-11: T1/E1 I/O cable W (span) signal and pin information	2-48
Table 2-12: Customer alarm cable (X) pinout for customer IP 1-12 OP 1-4	2-51
Table 2-13: Customer alarm cable (X) pinout for customer IP 13-24 OP 5-8	2-52
Table 2-14: +27 V DC connector (Orange) parts information	2-55
Table 2-15: –48 V DC connector (Blue) parts information	2-61
Table 4-1: Installation completion checklist	4-3

R20 1X UBS Macro BTS Hardware Installation



NOTE

The R20 UBS Macro BTS supports single band 800 MHz or 1.9 GHz RF band, up to two XMIs, up to two DMIs and one SSI. UBS Macro BTS frame configurations with up to four XMIs and up to five DMIs will be available in the future.

What is covered in this manual?

The UBS Macro BTS Hardware Installation manual describes the installation of Motorola supported configurations of the UBS Macro BTS system. The UBS Macro BTS system supports either the 800 MHz or the 1.9 GHz RF band and IP-packet backhaul. In addition, CDMA 1X and CDMA EV-DO channels are supported as well as Open Transport Interface (OTI) for IP-packet backhaul via Ethernet. The UBS Macro BTS frame can also be configured for +27 V DC operation, optional -48 V DC or optional 220 V AC operation.

The UBS Macro BTS air interface supports the following:

- Omni or 3-sector antenna configurations
- Single RF band operation only; 800 MHz or 1.9 GHz RF band
- Up to 120 W of total TX RF power output and up to 30 W TX RF power output per carrier
- Dual path, Main and Diversity, RX antennas

UBS Macro BTS frames are also configured for low, mid, or high capacity. Capacity is determined by the quantity of sector carriers and traffic channels supported by the frame. The quantity of sector carriers is a function of the quantity of XMIs. The quantity of traffic channels is a function of the quantity of modems. Because the modems are inside the DMI, the quantity of DMIs is a capacity factor. The capacity of a UBS Macro BTS frame is essentially based on the following:

- low capacity - one XMI and up to two DMIs
- mid capacity - two XMIs and two DMIs
- high capacity - more than two XMIs (four XMIs maximum) and more than two DMIs (five DMIs maximum)

For Software Release 2.20.x, only low and mid capacity frames are available/supported.



NOTE

High capacity UBS Macro BTS frames will be available in the future.

The manual covers the following topics:

- Chapter 1 provides a brief description of the information presented in the manual, frame identification information, installation sequence, and a list of tools.
- Chapter 2 provides illustrations displaying the location of all UBS Macro connectors for external cabling and wiring purposes, external cable run list, and a detailed installation sequence. Installation procedures cover mounting items to the rack and installing the external cabling.
- Chapter 3 provides information and procedures needed for expanding the low-capacity UBS Macro BTS starter/expansion frame to the mid-capacity frame configuration.
- Chapter 4 provides procedures for cleaning up the site and the installation completion checklist.

Revision history

The following shows the issue status of this manual since it was first released.

Version information

Table 1 Manual version history

Manual issue	Date of issue	Remarks
1	JUN 15, 2007	DRAFT version for SME review
2	AUG 10, 2007	PRELIMINARY version for SME review. Does not include E-GPS and the special recently requested SPRINT mechanics.
3	AUG 31, 2007	PRELIMINARY version for Deployment. Does not include E-GPS and the special recently requested SPRINT mechanics.

Resolution of Service Requests

The following Service Requests are resolved in this document:

Service Request	CMBP Number	Remarks
NA	NA	NA

Incorporation of Change Notices

The following Change Notices (CN) are incorporated in this document:

CN Date	CN Number	Title
NA	NA	NA

General information

Purpose

Motorola cellular communications documents are intended to instruct and assist personnel in the operation, installation and maintenance of the Motorola cellular infrastructure equipment and ancillary devices. It is recommended that all personnel engaged in such activities be properly trained by Motorola.

Motorola disclaims all liability whatsoever, implied or express, for any risk of damage, loss or reduction in system performance arising directly or indirectly out of the failure of the customer, or anyone acting on the customer's behalf, to abide by the instructions, system parameters, or recommendations made in this document.

These documents are not intended to replace the system and equipment training offered by Motorola. They can be used to supplement and enhance the knowledge gained through such training.



NOTE

If this document was obtained when attending a Motorola training course, it will not be updated or amended by Motorola. It is intended for TRAINING PURPOSES ONLY. If it was supplied under normal operational circumstances, to support a major software release, then corrections are supplied automatically by Motorola and posted on the Motorola customer website.

Cross references

References made to external publications are shown in italics. Other cross references, emphasized in blue text in electronic versions, are active links to the references.

This document is divided into numbered chapters that are divided into sections. Sections are not numbered, but are individually named at the top of each page, and are listed in the table of contents.

Text conventions

The following conventions are used in the Motorola cellular infrastructure documents to represent keyboard input text, screen output text, and special key sequences.

Input

Characters typed in at the keyboard are shown like this.

Items of interest within a command appear like this.

Output

Messages, prompts, file listings, directories, utilities, and environmental variables that appear on the screen are shown like this.

Items of interest within a screen display appear like this.

Special key sequences

Special key sequences are represented as follows:

CTRL-c or CTRL+C	Press the Ctrl and C keys at the same time.
CTRL-SHIFT-c or CTRL+SHIFT+C	Press the Ctrl , Shift , and C keys at the same time.
ALT-f or ALT+F	Press the Alt and F keys at the same time.
ALT+SHIFT+F11	Press the Alt , Shift and F11 keys at the same time.
	Press the pipe symbol key.
RETURN or ENTER	Press the Return or Enter key.

Contacting Motorola

Motorola appreciates feedback from the users of our documents.

24-hour support

If you have problems regarding the operation of your equipment, contact the Customer Network Resolution Center (CNRC) for immediate assistance. The 24-hour telephone numbers are listed at <https://mynetworksupport.motorola.com>. Select **Customer Network Resolution Center contact information**. Alternatively if you do not have access to CNRC or the internet, contact the Local Motorola Office.

Questions and comments

Send questions and comments regarding user documentation to the email address: mydocs@motorola.com.

Errors

To report a documentation error, call the CNRC (Customer Network Resolution Center) and provide the following information to enable CNRC to open an SR (Service Request):

- The document type
- The document title, part number, and revision character
- The page number with the error
- A detailed description of the error and if possible the proposed solution

Security advice

Motorola systems and equipment provide security parameters that can be configured by the operator based on their particular operating environment. Motorola recommends setting and using these parameters following industry recognized security practices. Security aspects to be considered are protecting the confidentiality, integrity, and availability of information and assets. Assets include the ability to communicate, information about the nature of the communications, and information about the parties involved.

In certain instances, Motorola makes specific recommendations regarding security practices. The implementation of these recommendations and final responsibility for the security of the system lies with the operator of the system.

Contact the Customer Network Resolution Center (CNRC) for assistance. The 24-hour telephone numbers are listed at <https://mynetworksupport.motorola.com>. Select **Customer Network Resolution Center contact information**, from the menu located to the left of the Login box. Alternatively if you do not have access to CNRC or the internet, contact the Local Motorola Office.

Warnings, cautions, and notes

The following describes how warnings and cautions are used in this document and in all documents of this Motorola document set.

Warnings

Warnings precede instructions that contain potentially hazardous situations. Warnings are used to alert the reader to possible hazards that could cause loss of life or physical injury. A warning has the following format:



WARNING

Warning text and consequence for not following the instructions in the warning.

Cautions

Cautions precede instructions and are used when there is a possibility of damage to systems, software, or individual items of equipment within a system. However, this damage presents no danger to personnel. A caution has the following format:



CAUTION

Caution text and consequence for not following the instructions in the caution.

Notes

A note means that there is a possibility of an undesirable situation or provides additional information to help the reader understand a topic or concept. A note has the following format:



NOTE

Note text.

Safety

General safety

The following general safety guidelines apply to Motorola equipment:

- The power jack and mating plug of the power cable must meet International Electrotechnical Commission (IEC) safety standards.



NOTE

Refer to *Grounding Guideline for Cellular Radio Installations – 68P81150E62*.

- Power down or unplug the equipment before servicing.
- Using non-Motorola parts for repair could damage the equipment or void warranty. Contact Motorola Warranty and Repair for service and repair instructions.
- Portions of Motorola equipment may be damaged from exposure to electrostatic discharge. Use precautions to prevent damage.

Electromagnetic energy

Relevant standards (USA and EC) applicable when working with RF equipment are:

- *ANSI IEEE C95.1-1991, IEEE Standard for Safety Levels with Respect to Human Exposure to Radio Frequency Electromagnetic Fields, 3 kHz to 300 GHz.*
- Council recommendation of 12 July 1999 on the limitation of exposure of the general public to electromagnetic fields (0 Hz to 300 GHz) (1999/519/EC) and respective national regulations.
- *Directive 2004/40/EC of the European Parliament and of the Council of 29 April 2004 on the minimum health and safety requirements regarding the exposure of workers to the risks arising from physical agents (electromagnetic fields) (18th individual Directive within the meaning of Article 16(1) of Directive 89/391/EEC).*

Caring for the environment

The following information describes national or regional requirements for the disposal of Motorola supplied equipment and for the approved disposal of surplus packaging.

Contact the Customer Network Resolution Center (CNRC) for assistance. The 24-hour telephone numbers are listed at <https://mynetworksupport.motorola.com>. Select **Customer Network Resolution Center contact information**. Alternatively if you do not have access to CNRC or the internet, contact the Local Motorola Office.

In EU countries

The following information is provided to enable regulatory compliance with the European Union (EU) directives identified and any amendments made to these directives when using Motorola equipment in EU countries.



Disposal of Motorola equipment

European Union (EU) Directive 2002/96/EC Waste Electrical and Electronic Equipment (WEEE)

Do not dispose of Motorola equipment in landfill sites. In the EU, Motorola in conjunction with a recycling partner ensures that equipment is collected and recycled according to the requirements of EU environmental law.

Disposal of surplus packaging

European Parliament and Council Directive 94/62/EC Packaging and Packaging Waste

Do not dispose of surplus packaging in landfill sites. In the EU, it is the individual recipient's responsibility to ensure that packaging materials are collected and recycled according to the requirements of EU environmental law.

In non-EU countries

In non-EU countries, dispose of Motorola equipment and all surplus packaging in accordance with national and regional regulations.

CMM labeling and disclosure table

The People’s Republic of China require that our products comply with China Management Methods (CMM) environmental regulations. (China Management Methods refers to the regulation *Management Methods for Controlling Pollution by Electronic Information Products*.) Two items are used to demonstrate compliance; the label and the disclosure table.

The label is placed in a customer visible position on the product.

- Logo 1 means the product contains no substances in excess of the maximum concentration value for materials identified in the China Management Methods regulation.
- Logo 2 means that the product may contain substances in excess of the maximum concentration value for materials identified in the China Management Methods regulation, and has an Environmental Friendly Use Period (EFUP) in years, fifty years in the example shown.



The Environmental Friendly Use Period (EFUP) is the period (in years) during which the Toxic and Hazardous Substances (T&HS) contained in the Electronic Information Product (EIP) will not leak or mutate causing environmental pollution, or bodily injury from the use of the EIP. The EFUP indicated by the Logo 2 label applies to a product and all its parts. Certain field-replaceable parts, such as battery modules, can have a different EFUP and are marked separately.

The Disclosure table is intended only to communicate compliance with China requirements. It is not intended to communicate compliance with EU RoHS or any other environmental requirements.

Disclosure table

部件名称	有毒有害物质或元素					
	铅 (Pb)	汞 (Hg)	镉 (Cd)	六价铬 (Cr ⁶⁺)	多溴联苯 (PBB)	多溴二苯醚 (PBDE)
金属部件	×	○	×	×	○	○
电路模块	×	○	×	×	○	○
电缆及电缆组件	×	○	×	×	○	○
塑料和聚合物部件	○	○	○	○	○	×

○： 表示该有毒有害物质在该部件所有均质材料中的含量均在 SJ/T11363-2006 标准规定的限量要求以下。
 ×： 表示该有毒有害物质至少在该部件的某一均质材料中的含量超出SJ/T11363-2006 标准规定的限量要求。

Motorola document set

The Motorola document sets provide the information to operate, install, and maintain the Motorola equipment.

Ordering documents and CD-ROMs

With internet access available, to view, download, or order documents (original or revised), visit the Motorola Lifecycles Customer web page at <https://mynetworksupport.motorola.com>, or contact your Motorola account representative.

Without internet access available, order hard copy documents or CD-ROMs with your Motorola Local Office or Representative.

If Motorola changes the content of a document after the original printing date, Motorola publishes a new version with the same part number but a different revision character.

Document banner definitions

A banner (oversized text on the bottom of the page, for example, **PRELIMINARY — UNDER DEVELOPMENT**) indicates that some information contained in the document is not yet approved for general customer use.

Data encryption

In order to avoid electronic eavesdropping, data passing between certain elements in the network is encrypted. In order to comply with the export and import requirements of particular countries, this encryption occurs at different levels as individually standardized, or may not be present at all in some parts of the network in which it is normally implemented. The document set, of which this document is a part, covers encryption as if fully implemented. Because the rules differ in individual countries, limitations on the encryption included in the particular software being delivered, are covered in the Release Notes that accompany the individual software release.

Third Party Computer Software and Trademarks

Computer Software

The Motorola and 3rd Party supplied Software (SW) products described in this instruction manual may include copyrighted Motorola and other 3rd Party supplied computer programs stored in semiconductor memories or other media. Laws in the United States and other countries preserve for Motorola and other 3rd Party supplied SW certain exclusive rights for copyrighted computer programs, including the exclusive right to copy or reproduce in any form the copyrighted computer program. Accordingly, any copyrighted Motorola or other 3rd Party supplied SW computer programs contained in the Motorola products described in this instruction manual may not be copied (reverse engineered) or reproduced in any manner without the express written permission of Motorola or the 3rd Party SW supplier. Furthermore, the purchase of Motorola products shall not be deemed to grant either directly or by implication, estoppel, or otherwise, any license under the copyrights, patents or patent applications of Motorola or other 3rd Party supplied SW, except for the normal non-exclusive, royalty free license to use that arises by operation of law in the sale of a product.

Vendor	Copyright
Apache Software Foundation	Copyright 2002-2003 All Rights Reserved
Artesyn	Copyright 2002-2003 All Rights Reserved
CMU *	Copyright 2002-2003 All Rights Reserved
Freeware Tools / Utilities *	Copyright 2002-2003 All Rights Reserved
Performance Technologies	Copyright 2002-2003 All Rights Reserved
Telelogic	Copyright 2002-2003 All Rights Reserved
QNX *	Copyright 2002-2003 All Rights Reserved

*= Freeware

Trademarks

Java™ Technology and/or J2ME™ : Java and all other Java-based marks are trademarks or registered trademarks of Sun Microsystems, Inc. in the U.S. and other countries.

UNIX® : UNIX is a registered trademark of The Open Group in the United States and other countries.

Introduction and Frame Identification

Abbreviations and Acronyms

Abbreviations and Acronyms

Table 1-1 identifies the equipment related abbreviations and acronyms used in this manual.

Table 1-1 Abbreviations and Acronyms

Acronym	Definition
1X	One of two bandwidths currently defined in the IS-2000 CDMA specification, which extends the capability of the IS-95A and B specifications. 1X bandwidth provides wireless packet voice and data transmission capability at up to 144 Kbps.
A	Ampere or Amp
AC	Alternating Current
ACC	Accessory
AN	Aggregation Node
ATP	Acceptance Test Plan
AWG	American Wire Gauge
BMA	Breaker Module Assembly
BSI	Baseband Switch Interface
BSS	Base Station System
BSSAN	Base Station System (BSS) Access Network. The BSSAN consists of a Radio Access Network (RAN) and an AN. It may also include a Digital Access and Cross-connect System to support split backhaul and a Selector Distribution Unit (SDU).
BTS	Base Transceiver Station or Base Transceiver Subsystem
CB	Circuit Breaker
CBSC	Centralized Base Station Controller
CCW	Counter Clockwise
CDMA	Code Division Multiple Access
CE	Channel Element
CW	Clockwise
DC	Direct Current
DIV	Diversity
DMI	Digital Module Internal
DMM	Digital Multi-Meter

Continued

Table 1-1 Abbreviations and Acronyms (Continued)

Acronym	Definition
E-GPS	External-GPS
ESD	Electro-Static Discharge
EV-DO	CDMA 1X Evolution - Data Only
FRU	Field Replaceable Unit
FWD	Forward
GND	Ground
GPS	Global Positioning System
HSO	High Stability Oscillator
IDI	Interworking DMI Interconnect
IDRF	Integrated Duplexer RX Filter
I/O	Input/Output
IP	Internet Protocol
IP/OP	Customer Alarm Input/Output
IS	Interim Standard
LAN	Local Area Network
LMF	Local Maintenance Facility
LMT	Local Maintenance Terminal
MGB	Master Ground Bar
MMI	Man Machine Interface
MMII	Mobility Manager II
MSN	Mobile Switching Network
MSO	Motorola Standard Oscillator
OMC-IP	Operations Maintenance Center - Internet Protocol
OMC-R	Operations Maintenance Center - Radio
PA	Power Amplifier
PBH	Packet Backhaul: IP-based backhaul between the BTS and the network. The UBS Macro BTS is configured for packet backhaul operation.
PC	Power Connector
PDU	Power Distribution Unit
PPS or 1PPS	1 pulse per second
PSM	Power Supply Module
QHSO	Quartz High Stability Oscillator
RAN	Radio Access Network
RF	Radio Frequency

Continued

Table 1-1 Abbreviations and Acronyms (Continued)

Acronym	Definition
RFL	Reflected
RGPS	Remote Global Positioning System
RU	Rack Unit
RX	Receive or Receiver
SDU	Selection and Distribution Unit
SPROC	Site Processor
SSI	Site Span I/O or Site/Span Interface
TCH	Traffic Channel
TX	Transmit or Transmitter
UBS	Universal Base Station
UNO	Universal Network Operations
V	Volt
VPU	Vocoder Processing Unit
W	Watt
XMI	Transceiver Module Internal

Overview

Scope of manual

This manual covers how to:

- Mount the equipment rack to the floor.
- Mount the pre-assembled/pre-cabled UBS Macro equipment on to the rack.
- Mount the optional power supply equipment on to the rack and install all of the associated interconnect cabling.
- Mount the low-to-mid capacity expansion equipment on to the rack and install all of the associated interconnect cabling.
- Install external cabling and wiring between the rack mounted UBS Macro equipment and other BTS site equipment.

This manual is not intended to be used as a planning guide. All site plans and site specific information must be decided, before starting the installation. The site specific information determines the configuration to be used and the items and cabling required to support that configuration.

This manual may be used in conjunction with site-specific configuration planning to determine the site-specific expansion.

This manual does not provide information for the Acceptance Test Procedures (ATP) or software loading.

Prerequisites

The following are the three major prerequisites:

- The procedure, tools, and equipment required for mounting the rack to the floor has been specified by a Structural Engineer.
- All site preparations (including power) have been completed according to the site plan.
- All site planning and BTS configuration information is available.

Chapter 1 - Introduction and frame identification

This chapter provides a brief description of the information presented in the manual, frame identification information, installation sequence, and a list of tools.

Chapter 2 – UBS Macro BTS installation procedure

This chapter provides figures showing the location of all UBS Macro connectors for external cabling and wiring purposes, external cable run list, and a detailed installation sequence. Installation procedures cover mounting items to the rack and installing the external cabling.

Chapter 3 - Low-to-Mid Capacity Frame Expansion Procedures

This chapter provides information and procedures needed for expanding the low-capacity UBS Macro BTS starter/expansion frame to the mid-capacity frame configuration.

Chapter 4 - What's next

This chapter provides procedures for cleaning up the site and the installation completion checklist.

Equipment shipped assembled

The low-capacity, +27 V DC UBS Macro BTS is shipped pre-assembled on carrier strips with all internal cabling installed. This pre-assembled equipment is delivered in a crate. After the crate is unpacked, the low-capacity +27 V DC UBS Macro BTS assembly is ready to be rack mounted. The carrier strips allow four people to carefully lift the assembly off the crate packing onto the rack. The assembly can also be lifted via some mechanical aid (hoist, etc.) attached to the lifting loops on the ends of the carrier strips. The carrier strips also provide easy rack mounting. After the UBS Macro equipment is rack mounted, cables are connected between the UBS Macro equipment and external site inputs/outputs.

Equipment shipped un-assembled

The low-to-mid capacity expansion equipment and associated cables are shipped in separate individual containers. The additional expansion equipment is mounted into the low-capacity frame and then the associated interconnect cables are installed.

For -48 V DC or 220 V AC UBS Macro BTS applications, either a -48 V DC or a 220 V AC PSM (Power Supply Module) shelf is required. The PSM shelf comes assembled, but without PSMs installed in the shelf. For a low capacity frame, either two -48 V DC or two 220 V AC PSMs are installed in the shelf. The second PSM is for redundancy. The PSM shelf without PSMs is delivered in a single box. Each PSM is delivered in a single box. The PSM shelf is mounted at the bottom of the rack. Then the PSMs are installed in the PSM shelf. The +27 V DC UBS Macro assembly is mounted just above the PSM shelf. The PSM +27 V DC output cable is connected to the +27 V DC input cable on the +27 V DC UBS Macro assembly. The site -48 V DC or 220 V AC power source is cabled/wired to the PSM shelf.

The Remote GPS (RGPS) head and associated cable are shipped un-assembled. The cable has to be connected to the RGPS head along with the customer supplied mounting mast.

Most of the cable/wire connectors that are required to connect with the UBS Macro equipment external site input/output connectors are supplied, but need to be assembled onto cables/wires. Most of the cables/wires are supplied by the customer.

Follow the task sequence

The installation of the BTS is a defined sequence where one task relies on the previous task being completed. Figures are used to aide in understanding cable and item placement.

Follow the site plan

Items and cables are covered in the installation procedure that may not apply to a specific site configuration. Refer to the site plan to determine which items and cables are to be installed. Skip over those procedures for items and cables that are not required.

Site cleanliness

While performing the procedures provided in this document, ensure that:

- The site is kept clean and free of dirt. Dust can circulate in the air for several days and settle on all horizontal surfaces. Site equipment cooling fans can draw in dust particles, causing damage to electrical contacts.
- All packing materials are removed from the equipment.
- All the tools that are not currently in use are picked-up as the installation progresses.
- All trash is removed from the site at the end of each day and after the installation is complete.
- Equipment is covered with tarpaulin whenever possible.
- A shop vacuum is used, when a procedure is performed that generates dust, such as drilling or cutting.

Site manager

The site manager is in-charge of and responsible for the full site. The installer verifies a variety of conditions with the site manager.

Color coding

Many of the RF connectors and cables are color coded. When the cables are installed, the cable color code should match the color code of the connector.

The +27 V DC input/output cable connectors are color coded Orange while the -48 V DC input/output cable connectors are color coded Blue. When these power connections are made, make sure that the color of the mating connectors match.

**NOTE**

- Not all cables and connectors are color coded.
- Some, but not all, of the color coding is called out in the installation procedures.

Rack vs. frame

For purposes of this manual, the Rack is the piece of iron (metal) that the items are mounted on. The Frame is the Rack with all the items mounted on it.

Required documentation

The following additional documents are required to install the BTS:

- *Grounding Guidelines for Cellular Radio Installations (Motorola part number 68P81150E62)*
- *Site description* (as built) documents
- *Demarcation (Scope of Work Agreement)* document
- *Equipment manuals* for non-Motorola equipment including:
 - c *Acutime™ Gold GPS Smart Antenna Kit User Guide* — Supplied with STLN6594 RGPS Head.
- *UBS (800 MHz) BTS Specification (B1)* or *UBS (1.9 GHz) BTS Specification (B1)* document, whichever is applicable.

Equipment may vary from figures

The equipment shown in many of the figures is typical. The actual equipment appearance may vary slightly.

Item identification



NOTE

The R20 UBS Macro BTS supports single band 800 MHz or 1.9 GHz RF band, up to two XMIs, up to two DMIs and one SSI. UBS Macro BTS frame configurations with up to four XMIs and up to five DMIs will be available in the future.

UBS Macro BTS frames

UBS Macro BTS frames are configured for either +27 V DC operation, -48 V DC operation, or 220 V AC operation.

UBS Macro BTS frames are also configured for low, mid or high capacity. Low capacity frames, like the starter frame shown in [Figure 1-2](#), can be expanded to add more capacity. Mid-capacity frames, like the frame shown in [Figure 1-3](#), can be expanded to add more capacity. A high capacity frame, like the expanded frames shown in [Figure 1-4](#) and [Figure 1-5](#) can be expanded to add more capacity, if it is not already fully expanded. A BTS site with a fully expanded high capacity frame may be further expanded by adding a second frame for more capacity.



NOTE

High capacity UBS Macro BTS frames and BTS sites with multiple UBS Macro BTS frames are not currently available.

Figure 1-1 shows a UBS Macro BTS low-tier/low-capacity frame. The capacity of this configuration is not expandable.

Figure 1-1 UBS Macro BTS low-tier/low-capacity frame (1000 mm rack)

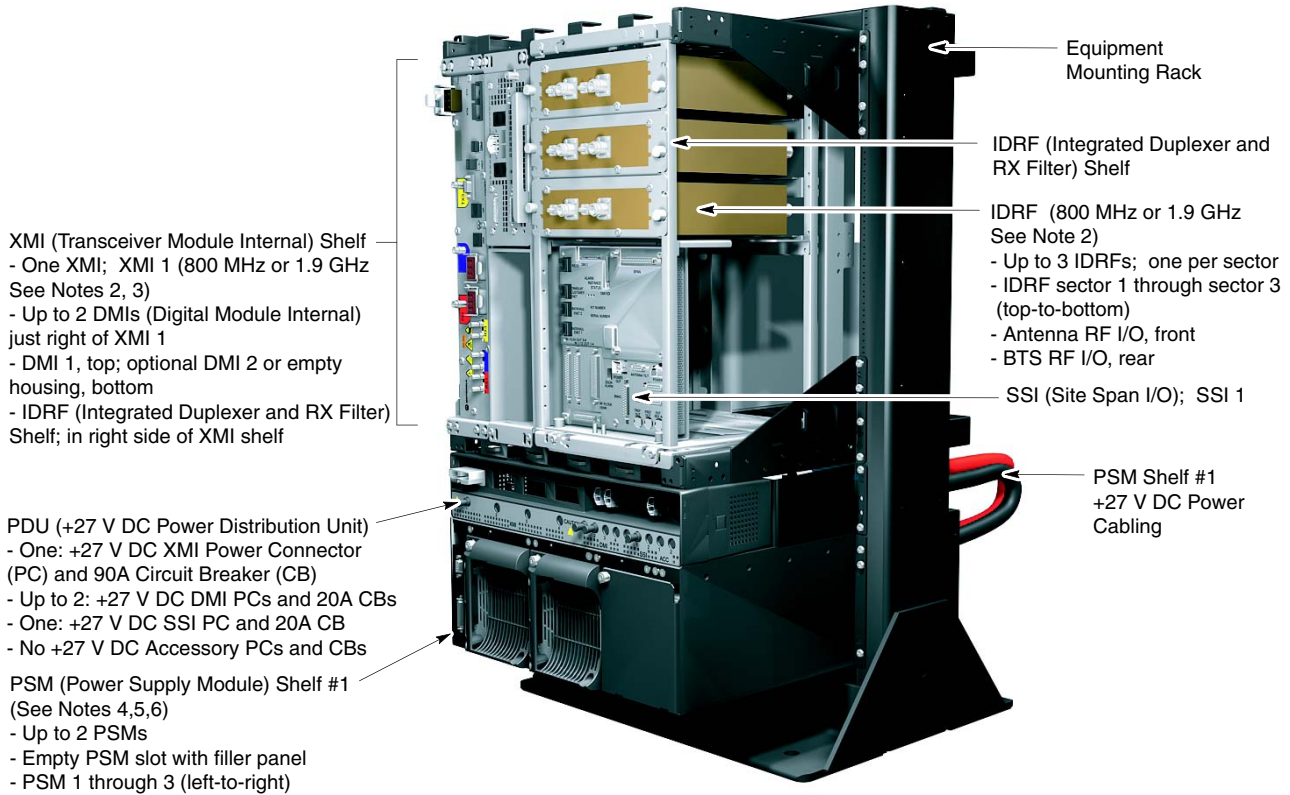

NOTES:

1. Interconnect cabling not shown for clarity.
2. 800 MHz equipment shown; 1.9 GHz similar.
3. 800 MHz XMI is 86 mm wide. 1.9 GHz XMI is 106.3 mm wide.
4. PSM shelf is optional and used instead of +27 V DC power Input.
5. PSM shelf is either -48 V DC or AC.
6. Only -48 V DC PSMs can be used in -48 V DC PSM shelf. Only AC PSMs can be used in AC PSM shelf.

ti-cdma-05993.eps

Figure 1-2 shows a typical low capacity UBS Macro BTS expandable frame. This frame is expandable to mid-capacity configuration. Expansion to high-capacity configuration is not currently available.

Figure 1-2 Low capacity UBS Macro BTS starter frame (1800 mm rack)

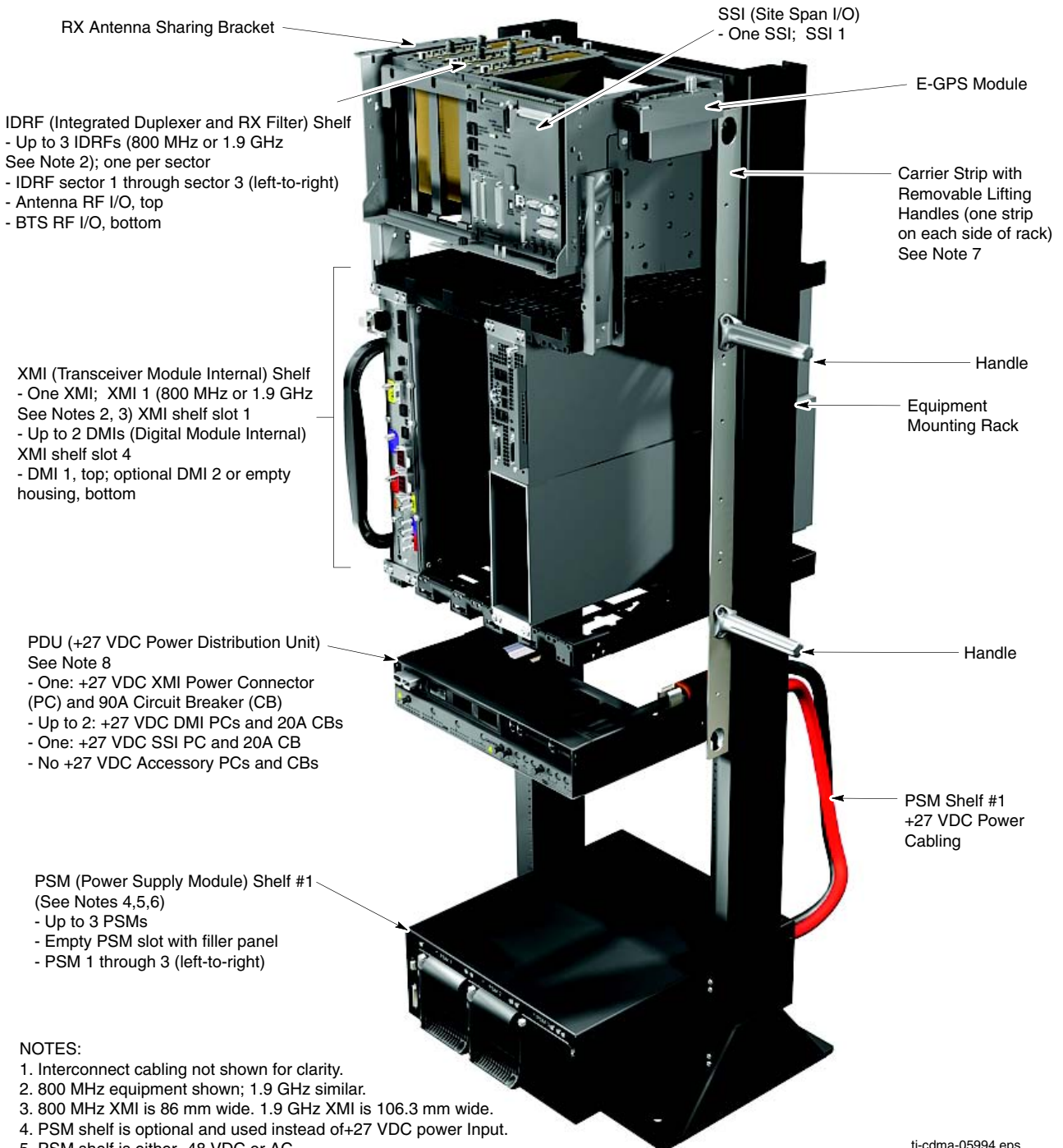

NOTES:

1. Interconnect cabling not shown for clarity.
2. 800 MHz equipment shown; 1.9 GHz similar.
3. 800 MHz XMI is 86 mm wide. 1.9 GHz XMI is 106.3 mm wide.
4. PSM shelf is optional and used instead of +27 VDC power Input.
5. PSM shelf is either -48 VDC or AC.
6. Only -48 VDC PSMs can be used in -48 VDC PSM shelf. Only AC PSMs can be used in AC PSM shelf.
7. Carrier strips are removable.
8. PDU may be moved down 6 rack units to ease future expansion.

ti-cdma-05994.eps

Figure 1-3 shows a UBS Macro BTS mid-capacity frame. The mid-capacity configuration is an expansion of the low-capacity configuration. This frame is expandable to high-capacity configuration, but the high-capacity configuration is not currently available.

Figure 1-3 UBS Macro BTS mid-capacity frame (1800 mm rack)

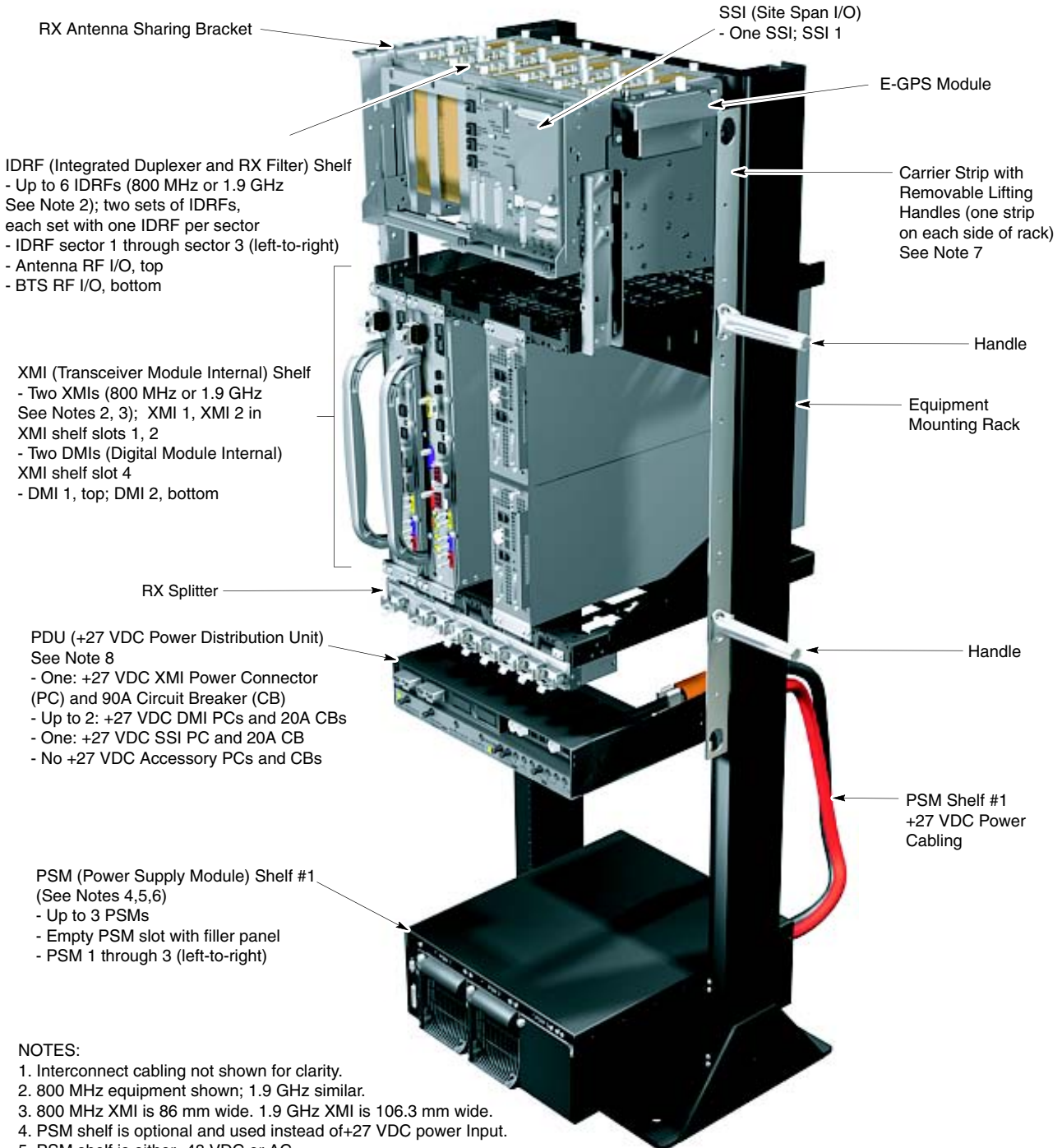

NOTES:

- 1. Interconnect cabling not shown for clarity.
- 2. 800 MHz equipment shown; 1.9 GHz similar.
- 3. 800 MHz XMI is 86 mm wide. 1.9 GHz XMI is 106.3 mm wide.
- 4. PSM shelf is optional and used instead of +27 VDC power Input.
- 5. PSM shelf is either -48 VDC or AC.
- 6. Only -48 VDC PSMs can be used in -48 VDC PSM shelf. Only AC PSMs can be used in AC PSM shelf.
- 7. Carrier strips are removable.
- 8. PDU may be moved down 6 rack units to ease future expansion.

ti-cdma-05995.eps

Figure 1-4 shows a typical fully expanded high capacity 800 MHz UBS Macro BTS frame.

Figure 1-4 High capacity 800 MHz UBS Macro BTS fully expanded frame (1800 mm rack)

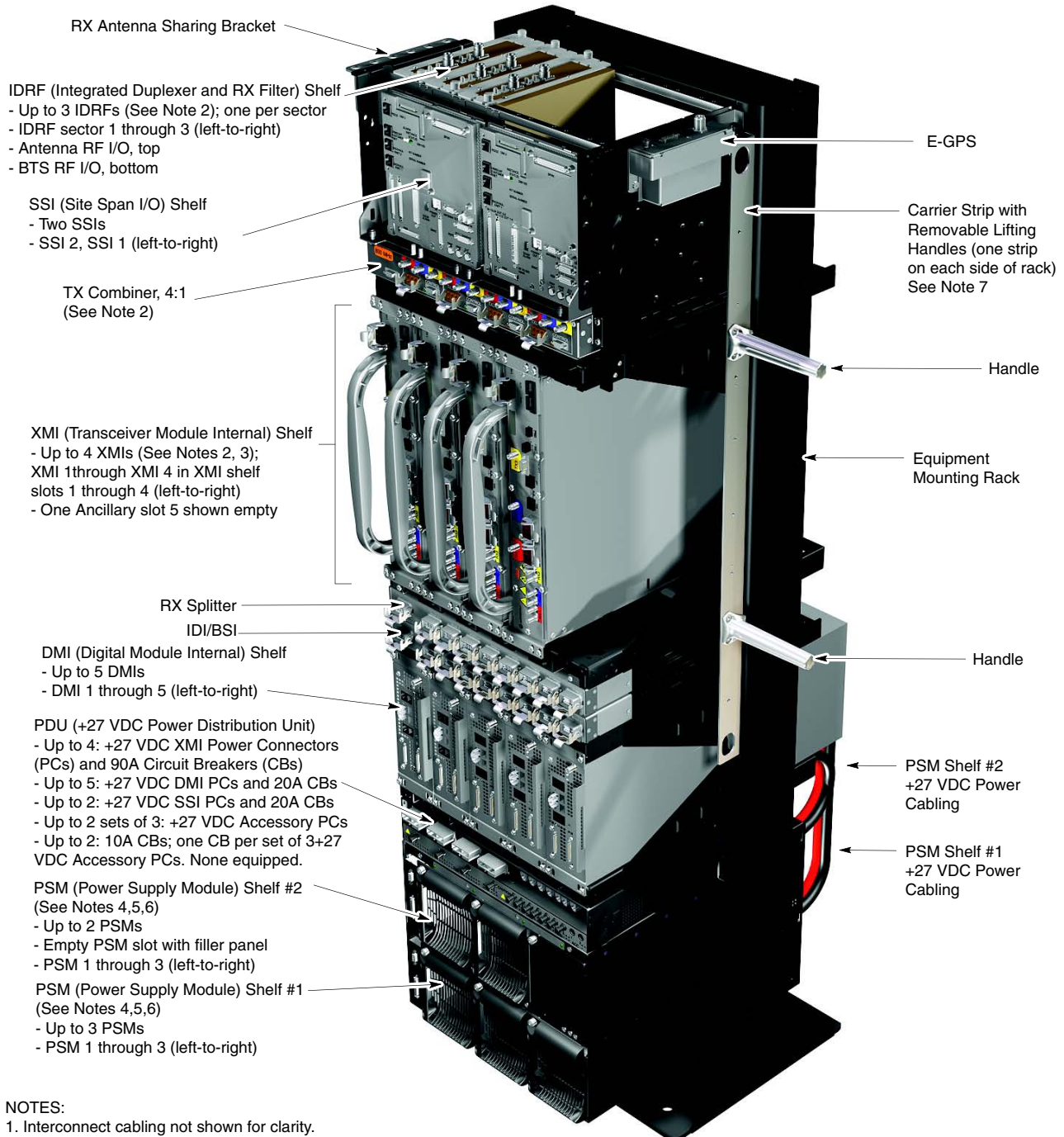

NOTES:

- 1. Interconnect cabling not shown for clarity.
- 2. 800 MHz equipment shown.
- 3. 800 MHz XMI is 86 mm wide.
- 4. PSM shelves are optional and used instead of +27 VDC power Input.

- 5. Both PSM shelves are either -48 VDC or AC.
- 6. Only -48 VDC PSMs can be used in -48 VDC PSM shelf. Only AC PSMs can be used in AC PSM shelf.
- 7. Carrier strips are removable

ti-cdma-05996.eps

Figure 1-5 shows a typical fully expanded high-capacity 1.9 GHz UBS Macro BTS frame.

Figure 1-5 High-capacity 1.9 GHz UBS Macro BTS fully expanded frame (1800 mm rack)

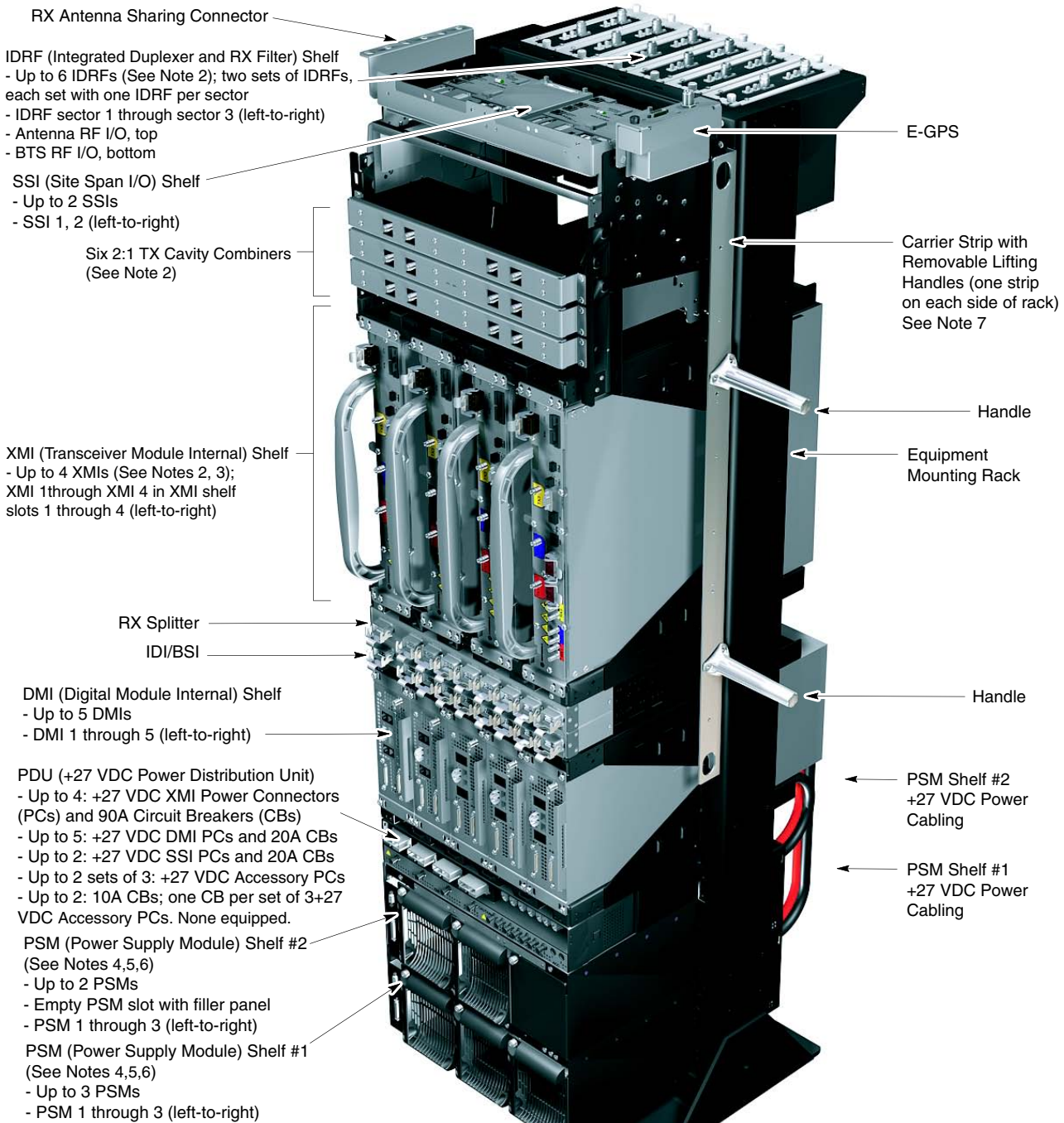

NOTES:

1. Interconnect cabling not shown for clarity.
2. 1.9 GHz equipment shown.
3. 1.9 GHz XMI is 106.3 mm wide.
4. PSM shelves are optional and used instead of +27 VDC power Input.
5. Both PSM shelves are either -48 VDC or AC.
6. Only -48 VDC PSMs can be used in -48 VDC PSM shelf. Only AC PSMs can be used in AC PSM shelf.
7. Carrier strips are removable

ti-cdma-05997.eps

Items to be installed

Figure 1-6 shows the items to be installed.

Figure 1-6 Items to install

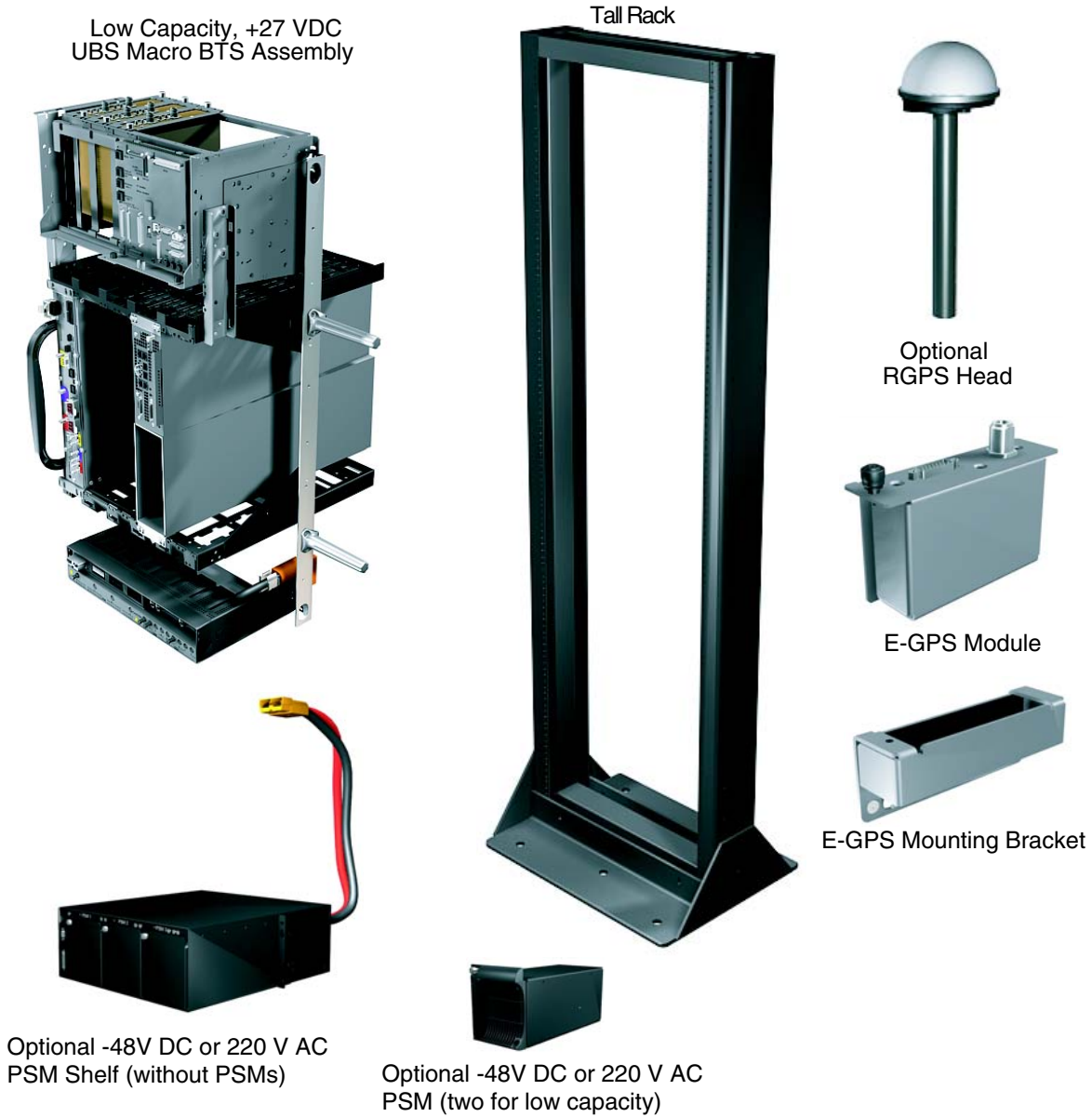

Tools and materials

Required tools and materials

The following tools and materials are required to perform the installation:

- Battery driver, capable of 3.95 N-m to 5.09 N-m (35-45 in-lb) torque
- T20 and T25 TORX bits with 12 inch extension
- Torque drivers; 1 N-m, 2.3 N-m, 4.8 N-m +/- 10%
- 8 mm SMA connector torque wrench; 1.02 N-m (9 in-lb) +/- 10%
- 19 mm N-type connector torque wrench; 4.3 N-m (38 in-lb) +/- 10%
- Phillips screwdriver
- Flat screwdriver
- 3/8-inch ratchet -5.6 N-m (50 in-lb)
- 8-mm socket
- 19-mm socket
- 10-mm deep set socket
- 9/16-inch socket
- 3/16-inch socket
- Side cutters
- Dust mask
- Safety glasses
- Ear plugs
- Marker for marking outline on floor
- Tape measure with millimeter scale, capable measuring up to 1200 mm or with inch scale, capable measuring up to 48 inches
- Shop vacuum
- Cable tie-wraps
- Scissors or knife
- 0.25 W SMA-type terminators for any unused directional port connectors on an IDRF - customer supplied

- 50 W N-type terminators for any unused TX/RX connectors on an IDRFB - customer supplied
- Digital Multi-Meter (DMM) Fluke Model 8062A with Y8134 test lead kit or equivalent; used for precision DC and AC measurements, requiring 4-1/2 digits.
- One DC connector housing per DC power feed (see [Table 2-8](#) for quantity of power feeds)
 - Orange DC connector housing used for +27 V DC application (see [Table 2-14](#) for part information).
 - Blue DC connector housing used for -48 V DC application (see [Table 2-15](#) for part information).
- DC connector cable clamps for power cable (see [Table 2-14](#) or [Table 2-15](#) for part information).
- DC connector housing contacts/lugs for power cable (see [Table 2-14](#) or [Table 2-15](#) for part information).
- Crimper tool - Anderson Power Products part number 1368 - Hydraulic hand tool, maximum cable size of 300 MCM.

Other tools are required to install the rack to the floor. The method of installing the rack to the floor, as specified by a Structural Engineer, determines what additional tools are required.

Recommended tools

The following tools are not required, but they may make the installation easier:

- Long screwdriver extension
- Long socket wrench extension
- Mechanical hoist capable of lifting 100 kg, 2 m high
- Banding cutter

Unpacking Instructions

Unpacking the carrier strip assembly

The UBS Macro BTS carrier strip assembly includes the low-capacity frame equipment pre-mounted and cabled. This assembly consists of the following equipment:

- One set of IDRFs, up to three IDRFs.
- One SSI
- One XMI
- One DMI
- PDU with one +27 V DC input power feed and circuit breaker/output power connector assemblies as follows: XMI 1, DMI 1, DMI 2 and SSI 1.



NOTE

The STGN4034 Installation Kit is also packaged with the UBS Macro carrier strip assembly. The installation kit contains all of the M5 x 12 mm screws needed to rack mount the equipment.

The UBS Macro BTS carrier strip assembly is shipped in a large carton that is banded to a pallet. Follow the steps in [Procedure 1-1](#) to unpack the carrier strip assembly.

Procedure 1-1 Unpacking the carrier strip assembly

1	Cut the bands that hold the carton to the pallet.
2	Lift the carton up and off of the pallet. Remove the cut bands
3	Remove the inner carton support (see Figure 1-7).
	 <h3 style="background-color: #00b050; color: white; padding: 2px 5px;">NOTE</h3> <p>The carrier strip assembly is sitting on a wooden support (see Figure 1-8).</p>
4	Locate the STGN4034 Installation Kit that is packaged with the UBS Macro carrier strip assembly.
5	Inspect the carrier strip assembly for damage.

Figure 1-7 Carrier strip assembly with inner carton support



ti-cdma-06026.eps

Figure 1-8 Carrier strip assembly with inner carton support removed

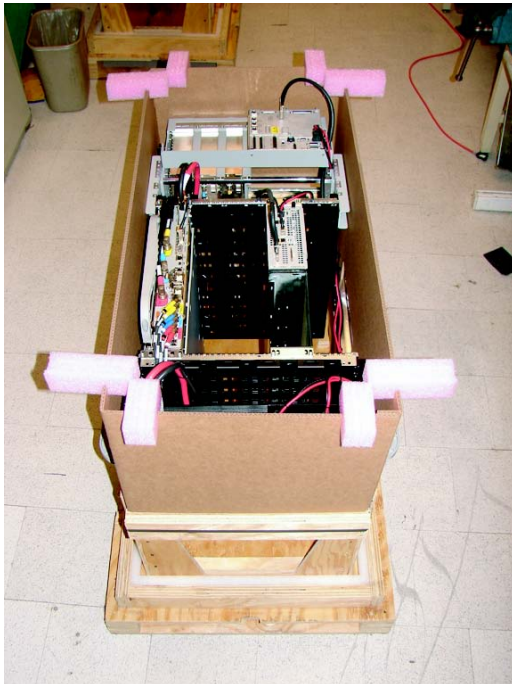
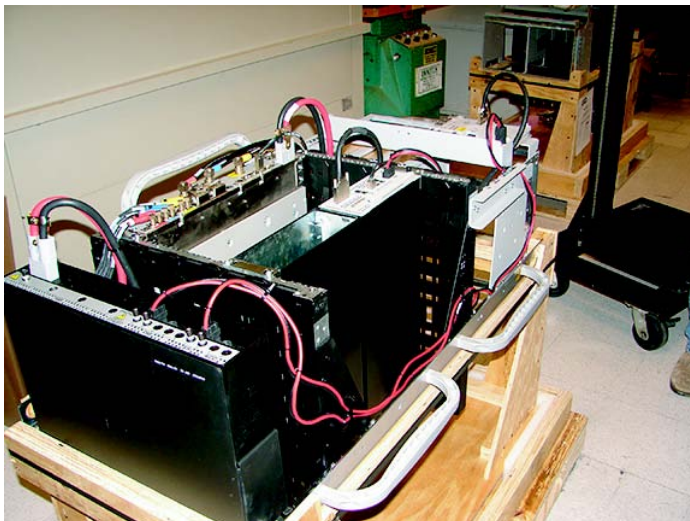

ti-cdma-06027.eps

Unpacking accessory equipment

UBS Macro BTS accessory equipment is shipped in smaller cartons. The quantity of cartons is dependent on the BTS site configuration and options. Follow the steps in [Procedure 1-2](#) to unpack the accessory equipment.

Procedure 1-2 Unpacking accessory equipment

1	Open an accessory equipment carton.
2	Inspect the contents of the carton for damage.
3	Verify that the carton contains all of the equipment stated on the packing list.
4	Repeat this procedure for each carton in the shipment.

UBS Macro BTS Installation Procedure

Overview

Introduction

This chapter provides the information and procedures to install the items and cabling for the UBS Macro BTS. Both pictorial and textual information is presented.

The installation is broken into a set of tasks. Each set of tasks is broken down into a set of steps.

Individual tasks or steps are based on the overall installation sequence and must not be performed randomly.

Structural engineer

A Structural Engineer has to determine the method and equipment needed to mount the rack to the floor.

Required items

For each set of tasks, a list of tools and items is given that covers those specific tasks.

A full list of tools is given in [Tools and materials on page 1-16](#).

Cabling and configuration options

All of the configurations require unique cables and/or items. Installation of all cables and all items is covered. When applicable, the cabling and configuration options are called out. Not all cables or items covered in this manual should be installed. Consult the site plan to determine exactly what items to install.

Color coding

Many of the connectors and cables are color coded. As the cables are installed, the cable color code should match the color code of the connector. Not all cables and connectors are color coded.

Some, but not all, of the color coding is called out in the installation procedures. The scheme of the color codes is shown in [Table 2-1](#) and [Table 2-2](#).

Table 2-1 Color code – DC power connectors/cables

Color	Represents
ORANGE	+27 V DC Power
BLUE	-48 V DC Power

Table 2-2 Color code - RF Equipment and Connectors/Cables

Color	Represents
ORANGE	800 MHz RF equipment
BLUE	1.9 GHz RF equipment
GREEN	2.1 GHz RF equipment
RED	Sector 1
BLUE	Sector 2
YELLOW	Sector 3
GREY	RFL (reflected) Main
BROWN	RFL DIV (reflected diversity)
WHITE	For RF use, it can mean: <ul style="list-style-type: none"> • Main • FWD (forward main)
BLACK	For RF use, it can mean: <ul style="list-style-type: none"> • Diversity • FWD DIV (forward diversity)

Cable list, diagrams and connectors

Overview

This section gives a UBS Macro BTS external input/output (I/O) cable run list – a list of cables and the end connection points. This can be used as a check-off sheet during installation. For any item that cables connect to, that item and the associated connectors are shown.

UBS Macro BTS external I/O cable run list

Table 2-3 gives the UBS Macro BTS external input/output cable run list. Not all cables are needed for all configurations.



NOTE

Each row in Table 2-3 is a separate unique cable run even if the reference designator and the part number are duplicated.

Table 2-3 UBS Macro BTS external I/O cable run list

Reference (used in manual)	Part number	From		To		Notes
		Item	Connector	Item	Connector	
DD	Customer	Rack	Double-studs	Site Master Ground Bar (MGB)	Customer	Earth Ground Cable/Wire (4 AWG or larger diameter)
NN	One of: 3086039H10 through H14 (Note 1)	RGPS Head	12-pin Circular (Deutsch)	RGPS Lightning Arrester	RGPS Lightning Arrester	RGPS Head Cable, shielded twisted pair
AA	3086433H14	SSI	RGPS (15-pin D)	RGPS Lightning Arrester	RGPS Lightning Arrester	RGPS Head Cable, shielded twisted pair
W	CGDS19797321	SSI	SPANS (37-pin D)	Customer	Equipment	T1/E1 Bal., shielded twisted pair cable (Note 2)

Continued

Table 2-3 UBS Macro BTS external I/O cable run list (Continued)

Reference (used in manual)	Part number	From		To		Notes
		Item	Connector	Item	Connector	
None	Customer	SSI (E1 Daughter Card)	SPAN RX/TX # (BNCs)	Customer	Equipment	E1 Unbal. 75-Ohm Coax Up to 8 cables (Note 2)
X	CGDS19797321	SSI	CUSTOMER IP 1-12 OP 1-4 (37-pin D)	Customer	Equipment	Customer Input/Output (IP/OP)
X	CGDS19797321	SSI	CUSTOMER IP 13-24 OP 5-8 (37-pin D)	Customer	Equipment	Customer Input/Output (IP/OP)
DC	Customer	PDU +27 V DC Power Input Cable	Orange (2-contact, Anderson SB-350)	DC Power Wires; Red & Black	Orange (2-contact, Anderson SB-350)	+27 V DC Power From Customer Source
CC	Customer	-48 V DC PSM Shelf Power Input Cable	Blue (2-contact, Anderson SB-350)	DC Power Wires; Blue & Black	Blue (2-contact, Anderson SB-350)	-48 V DC Power From Customer Source
AC	Customer	AC PSM Shelf	AC Input Terminal Block	Customer	Equipment	AC Power From Customer Source
None	Customer	Sector 1 IDRF	TX/RX MAIN (N-type, coaxial)	Sector 1 TX/RX Main Ant. Cable	N-type, coaxial	RF Ant., 50-Ohm Coaxial (Note 3)
None	Customer	Sector 2 IDRF	TX/RX MAIN (N-type, coaxial)	Sector 2 TX/RX Main Ant. Cable	N-type, coaxial	RF Ant., 50-Ohm Coaxial (Note 3)
None	Customer	Sector 3 IDRF	TX/RX MAIN (N-type, coaxial)	Sector 3 TX/RX Main Ant. Cable	N-type, coaxial	RF Ant., 50-Ohm Coaxial (Note 2)
None	Customer	Sector 1 IDRF	RX DIV (N-type, coaxial)	Sector 1 RX Div. Ant. Cable	N-type, coaxial	RF Ant., 50-Ohm Coaxial (Note 2)

Continued

Table 2-3 UBS Macro BTS external I/O cable run list (Continued)

Reference (used in manual)	Part number	From		To		Notes
		Item	Connector	Item	Connector	
None	Customer	Sector 2 IDRF	RX DIV (N-type, coaxial)	Sector 2 RX Div. Ant. Cable	N-type, coaxial	RF Ant., 50-Ohm Coaxial (Note 2)
None	Customer	Sector 3 IDRF	RX DIV (N-type, coaxial)	Sector 3 RX Div. Ant. Cable	N-type, coaxial	RF Ant., 50-Ohm Coaxial (Note 2)



NOTE

1. Cables 3086039H10 through H14 are various lengths; where the part number suffix indicates the following cable lengths: H10 = 15 m (50 ft), H11 = 38 m (125 ft), H12 = 76 m (250 ft), H13 = 152 m (500 ft) and H14 = 304 m (1000 ft). Cables H10 and H11 are included in Motorola option T472AG and T472AH, respectively. Cables H12, H13 and H14 are included in Motorola option T472AJ, T472AK and T472AL respectively.
2. Cable may be connected to a lightning arrester.

Connector locations

Figure 2-1 through Figure 2-4 show the items that external cables connect to. For each connector, the name is stated and where the associated cable goes.

IDRF I/O details

Figure 2-1 shows connector locations and usage for the 800 MHz IDRF.

Figure 2-2 shows connector locations and usage for the 1.9 GHz IDRF.

Figure 2-1 800 MHz IDRf I/O connectors

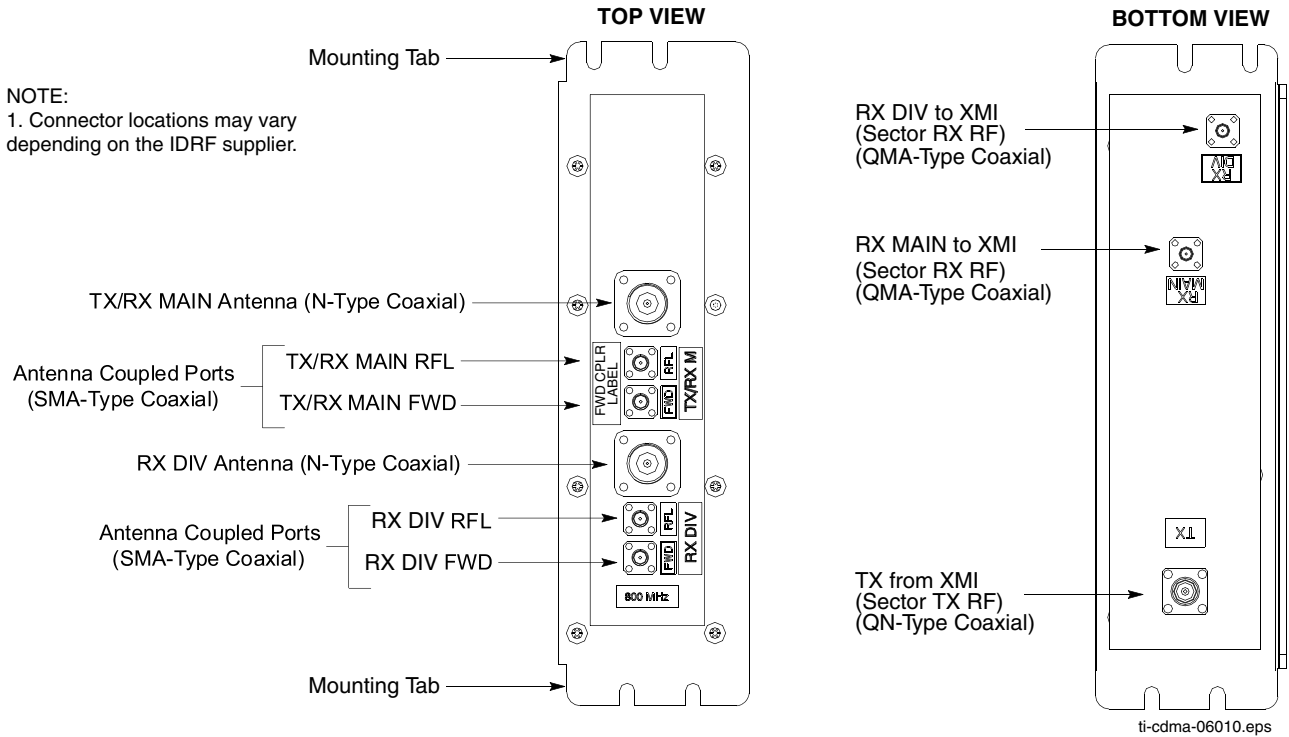
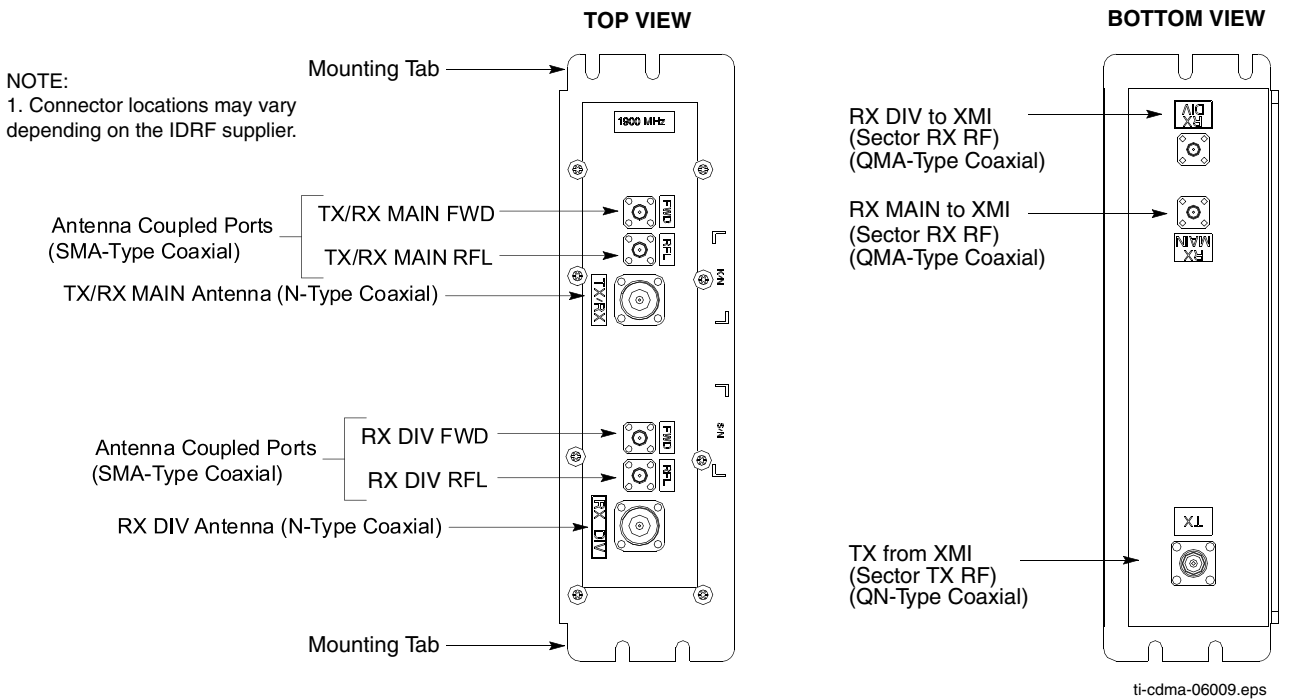

Figure 2-2 1.9 GHz IDRf I/O connectors



SSI I/O details

[Figure 2-3](#) shows connector locations and usage for the SSI and the optional E1 unbalanced daughter card.

Figure 2-3 SSI front panel connectors

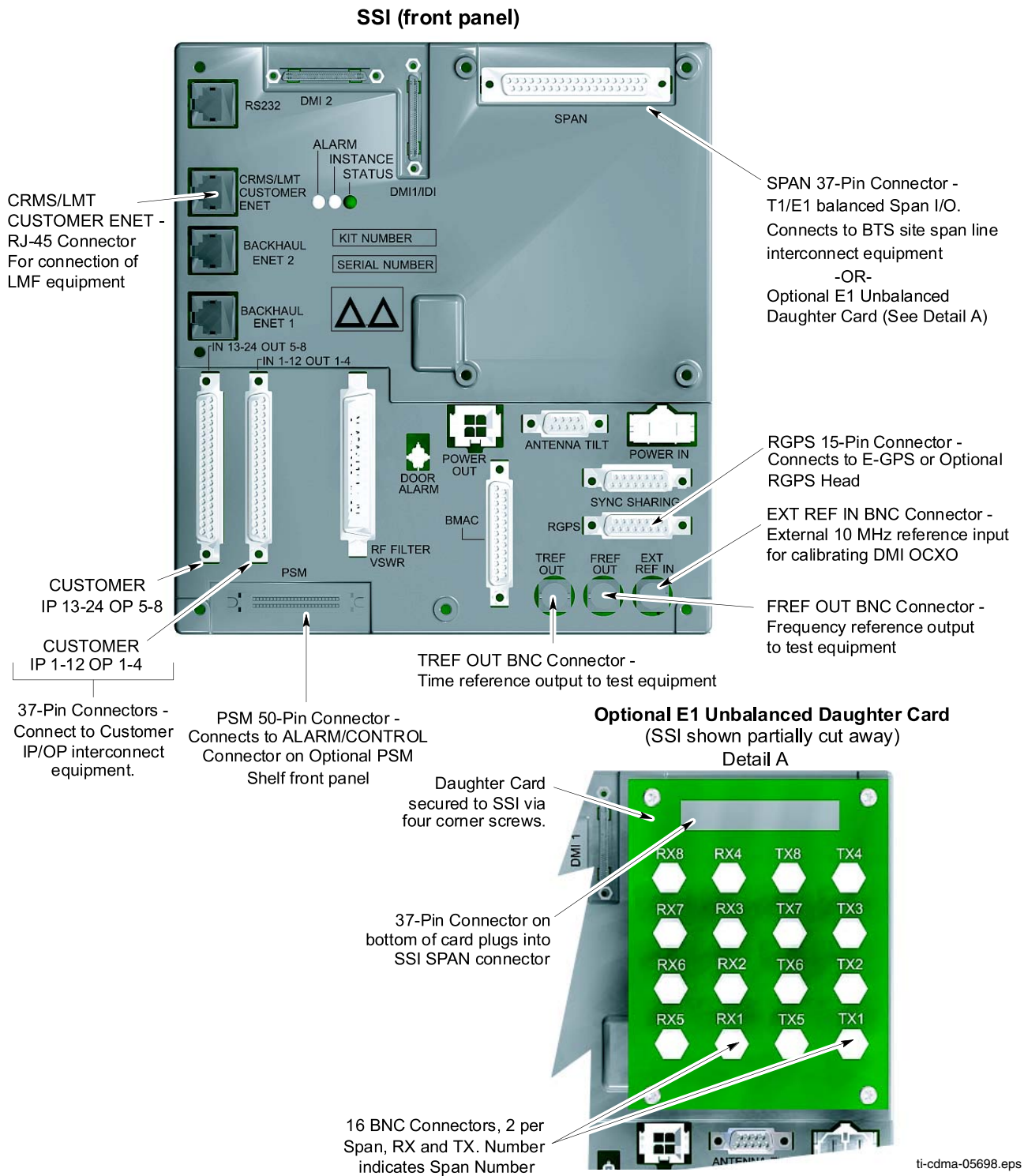

ti-cdma-05698.eps

PSM shelf front panel I/O details

Figure 2-4 shows the front panel connector locations and usage for the optional PSM shelf.

Figure 2-4 PSM shelf front panel connectors

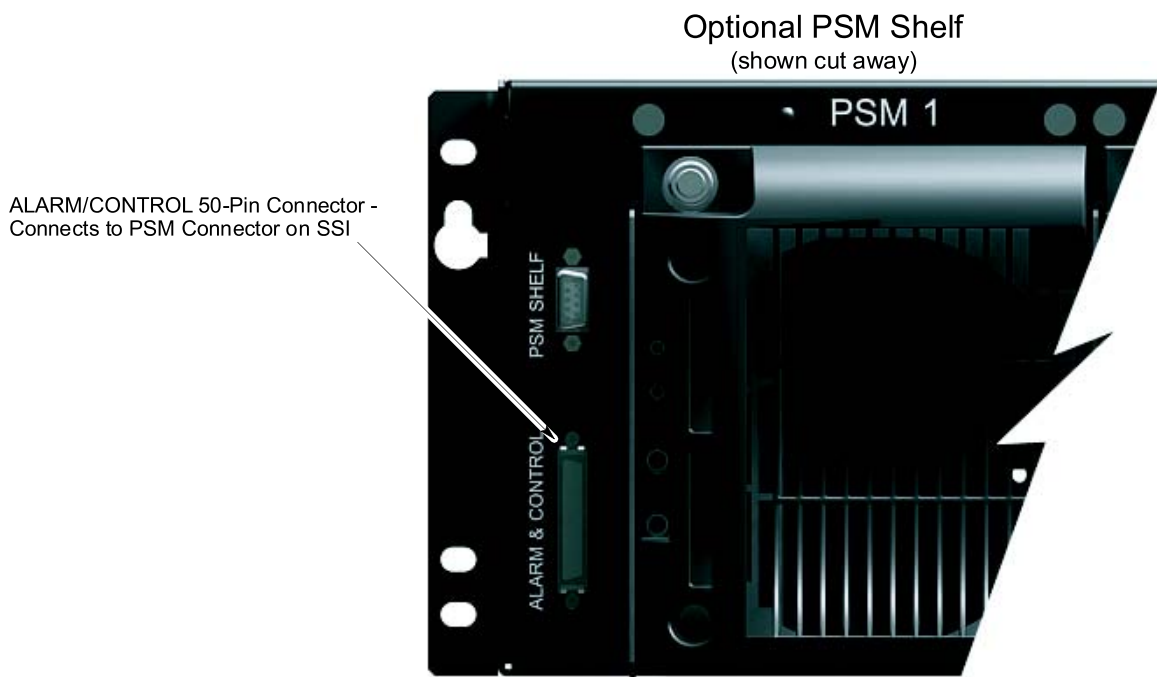

ti-cdma-05699.eps

Full installation sequence

Overview

The installation of the UBS Macro BTS is composed of two parts to be performed in this order:

1. Verifying site and equipment
2. Physical installation

Once the site is verified, the BTS can be physically installed.

Details to perform each part are given here along with any prerequisites.

Prerequisites

This document is not a planning guide and is not meant to provide planning information. All site planning, including power requirements and installation of site power, must be completed before performing the installation. The site verification will help verify this prerequisite has been met.

A Structural Engineer has been consulted and has determined the method to mount the rack to the floor.

Verifying site and equipment

This can be performed at any time prior to the physical installation. Verifying site and equipment is composed of two portions to be performed in this order:

1. Site verifications - Refer to [Site verification on page 2-15](#) to verify the site.
2. Unpack and identify the equipment - Refer to [Unpacking Instructions on page 1-18](#) and unpack the various cartons. Refer to [Figure 1-6](#) and verify the correct equipment is present. The exact number and type of equipment is site dependent.

Physical installation

Recommendations

Motorola recommends performing the physical installation all at once and not in multiple stages.

Motorola recommends installing cable ties to eliminate confusion and clutter.

Color code

Follow the color codes for the cables and connectors when applicable. Refer to [Overview on page 2-2](#) of this chapter for a detailed description of the color codes.

Default values

Unless otherwise specified, use these default values during the installation.

- All screws are M5 x 12 mm and require a T25 TORX bit. These screws are included in the STGN4034 Installation Kit that is packaged with the UBS Macro carrier strip assembly.
- Torque values are to be within +/-10% of value shown.
- Tighten screws and bolts to 4.77 N-m (42 in-lb).
- Maximum torque for the IDRf screws is 2.37 N-m (21 in-lb).
- Tighten SMA connectors to 1.02 N-m (9 in-lb).
- Tighten N-connectors on cables to 4.3 N-m (38 in-lb).

Preview of installation tasks

This section provides a preview of all of the tasks to be performed to install the UBS Macro BTS as well the sequence of those tasks. Each specific task is detailed in its own section later in this manual.



NOTE

Each item number below corresponds to a specific task number. The task number is used to identify the task and its occurrence within the overall installation sequence.

** indicates an optional task. The system configuration determines if the optional task is to be performed or if it can be skipped.

Perform the following tasks in the order shown when installing the UBS Macro BTS.

1. ** Install the optional RGPS head and route cable (NN) to the BTS site. Skip this task if the optional RGPS head is not required.
2. Mount rack to floor using the hardware, tools, and procedures defined by your Structural Engineer. Motorola recommends using 6 carbon steel grade 8.8 M12 bolts.
3. Install earth ground wire/cable (DD) between the site Master Ground Bar (MGB) and equipment rack. Attach ground wire to the top of equipment rack using 2 studs/nuts and a 10 mm socket and ratchet. Tighten to 5.65 N-m (50 in-lb).
4. ** Perform this task for -48 V DC or 220 V AC UBS only. Install the PSM shelf to the bottom of the rack using 6 screws; three screws on each left and right side. Install the appropriate, -48 V DC or 220 V AC, PSMs into PSM shelf slots 1 and 2.

- 5.** Mount the UBS Macro BTS carrier strip assembly to the rack at the predetermined height. First, measure and install 2 hanger screws in the rack rails; one screw on each left and right side at the proper height. Second, four people lift the UBS Macro BTS carrier strip assembly via the carrier strip handles and hang the assembly on the 2 hanger screws in the rack rails. Install 2 screws in the keyholes at the bottom of each carrier strip. Third, completely fasten the UBS assembly/carrier strips using 22 more screws; 11 screws on each left and right side. Completely tighten these 22 screws. Then completely tighten the 4 screws in the keyholes.
- 6.** ** Install the additional equipment required to expand the UBS Macro BTS low-capacity starter/expansion frame to the mid-capacity frame configuration. If the initial UBS Macro BTS installation is for a low-capacity frame configuration, skip this task and go to Task 7. Perform this task only if the initial UBS Macro BTS installation is for a mid-capacity frame configuration.
- 7.** ** For -48 V DC or 220 V AC UBS only, connect the +27 V DC power output cable from the rear of the PSM shelf to the +27 V DC power input cable on the rear of the PDU. Connect the 50-conductor cable (supplied with PSM shelf) between the PSM shelf front panel ALARM/CONTROL connector and SSI PSM connector.
- 8.** Route the customer supplied TX/RX main and RX diversity antenna cables to the front of the Integrated Duplexer RX Filters (IDRFs) at the top of the frame. Connect each antenna cable to the corresponding IDRF connector.
- 9.** Connect customer supplied 0.25 W, 50-Ohm, SMA-type terminators to unused directional coupler port connectors on the front of the IDRFs.
- 10.** ** Install optional RGPS cable (AA). Connect the 15-pin D-connector to the RGPS connector on the front of the SSI. Route the loose end of the cable to the RGPS lightning arrester and connect the wires there. Skip this task if the optional RGPS head is not required.
- 11.** ** Install T1/E1 balanced span I/O cable (W). Connect the 37-pin D-connector to the SPAN connector on the front of the SSI. Route the loose end of the cable to the site span line interconnect equipment and connect the wires.
- 12.** ** Install E1 unbalanced span I/O coaxial cables (customer supplied). Route 75-Ohm coaxial cables, with BNC connectors, from the site span line interconnect equipment to the SSI. Connect each cable to the corresponding BNC connector on the SSI E1 daughter card.
- 13.** ** Install Customer Alarm Input/Output (IP/OP) cables (X). Connect the 37-pin D-connector to the corresponding CUSTOMER IP 1-12 OP 1-4 connector and CUSTOMER IP 13-24 OP 5-8 connector on the front of the SSI. Route the loose end of the cables to the customer IP/OP interconnect equipment and connect the wires.
- 14.** ** Ensure that all circuit breakers are open on the PDU. For +27 V DC UBS only: attach an Orange 2-contact DC connector to Red and Black wires. Connect this Orange connector to the +27 V DC input power cable on the rear of the PDU. Route the loose ends of the wires to the site +27 V DC source and connect the wires.
- 15.** ** Ensure that all circuit breakers are open on the PDU. For -48 V DC UBS only: attach a Blue 2-contact DC connector to Blue and Black wires. Connect this Blue connector to the Blue DC INPUT connector on the rear of the -48 V DC PSM shelf. Route the loose ends of the wires to the site -48 V DC source and connect the wires.
- 16.** ** Ensure that all circuit breakers are open on the PDU. For 220 V AC UBS only: attach customer supplied wiring and conduit for 220 V AC lines. Connect wires and required insertion bridges to the AC INPUT terminal block on the rear of the AC PSM shelf. Route the loose ends of the wires to the site 220 V AC source and connect the wires.

After performing all of the necessary tasks, complete the installation by performing the following:

- Clean up the site.
- Fill out installation check off sheet.

Site verification

Site installation checks

Verify that the site is ready for BTS installation before performing the physical installation.

A detailed layout of the site is provided with the site-specific documentation. Before installing the hardware, compare the information presented here to the site-specific documentation layout and verify with the Site Manager for the following:

- All cable trays are installed.
- All external signal cables are connected.
- Site is clean.
- Site specific documentation covering all site dependent installation information is available.
- The installation area has restricted access. Equipment is meant to be installed and operated in a restricted access location. In order to maintain UL listing, equipment must be installed in a restricted access area.
- The site can maintain the required temperature range.
- The layout meets the minimum clearance requirements for the equipment as listed in [Table 2-5](#), [Table 2-6](#) and [Table 2-7](#).
- All building DC power cables are connected.
- The building meets the voltage and power requirements shown in *Site description (as built)* documents.
- Power cables are present that meet the requirements shown in [Table 2-8](#).
- The procedure, tools, and equipment required to mount the rack to the floor are specified by a Structural Engineer.
- The site can meet the footprint dimensions (as shown in [Figure 2-5](#)) and not violate any of the required clearances.
- Site grounding is according to Grounding Guidelines for Cellular Radio Installations (Motorola part number 68P81150E62).
- The screen (outer shield) of the RF antenna coaxial cable must be connected to earth (grounded) at the entrance to the building. This should be done in accordance with applicable national electrical installation codes (Section 820.93 of the National Electrical Code, ANSI/NFPA 70).
- Verify that the Master Ground Bar is connected to a solid earth ground. This is required to ensure protection from hazardous voltages by providing a high integrity protective earthing circuit when the frame is later grounded to the Master Ground Bar.

- The frames can be mounted as specified in the site-specific documentation.
- Each frame has its own main power cut off.



NOTE

Motorola recommends a separate main power cut off for each frame of the system.

Temperature range

The site building must be able to maintain a temperature between 0° C and 50° C. The life span of electronic equipment is shortened by environmental variations, even though it is designed to operate at extreme temperatures.

Frame physical dimensions

The following table gives the frame dimensions.

Table 2-4 Frame dimensions

Height	Width	Depth	Maximum Weight
1800 mm (70.86 inches)	575 mm (22.63 inches)	700 mm (27.55 inches)	312 kg (688 lbs)

Frame clearances

The following tables give the frame clearances for various configurations.

Table 2-5 Minimum frame clearances for airflow

Front	Rear	Top	Left side	Right side	Bottom
150 mm (5.9 inches)	150 mm (5.9 inches)	300 mm (11.8 inches)	0 mm (0 inches)	0 mm (0 inches)	0 mm (0 inches)

Table 2-6 Minimum frame clearances for maintenance - front access only

Front	Rear	Top	Left side	Right side	Bottom
700 mm (27.55 inches)	150 mm (5.9 inches)	300 mm (11.8 inches)	75 mm (2.95 inches)	75 mm (2.95 inches)	0 mm (0 inches)

Table 2-7 Minimum frame clearances for maintenance - front and rear access

Front	Rear	Top	Left side	Right side	Bottom
700 mm (27.55 inches)	150 mm (5.9 inches)	300 mm (11.8 inches)	0 mm (0 inches)	0 mm (0 inches)	0 mm (0 inches)

Frame DC input power and power cabling information

Table 2-8 gives DC input power cabling and circuit breaker information.



NOTE

For frame maximum and typical power consumption, refer to the *UBS (800 MHz) BTS Specification (B1)* document or *UBS (1.9 GHz) BTS Specification (B1)* document whichever is applicable.

Table 2-8 +27 V DC and -48 V DC Frame Power Cabling and Power Supply Breaker Information

Qty of XMIs	Maximum cable length	Cable size (AWG)	Cable insulation temperature rating (° C)	Qty of power feeds (+ and - pairs)	Breaker size per feed (Amps DC)
1	661.11 cm (21.69 ft)	2/0	200	1	250
1	833.63 cm (27.35 ft)	3/0	150	1	250
1	1051.25 cm (34.499 ft)	4/0	150	1	250
2	661.11 cm (21.69 ft)	2/0	200	1	250
2	833.63 cm (27.35 ft)	3/0	150	1	250
2	1051.25 cm (34.499 ft)	4/0	150	1	250
3	661.11 cm (21.69 ft)	2/0	200	2	250
3	833.63 cm (27.35 ft)	3/0	150	2	250
3	1051.25 cm (34.499 ft)	4/0	150	2	250

Continued

Table 2-8 +27 V DC and -48 V DC Frame Power Cabling and Power Supply Breaker Information (Continued)

Qty of XMIs	Maximum cable length	Cable size (AWG)	Cable insulation temperature rating (° C)	Qty of power feeds (+ and - pairs)	Breaker size per feed (Amps DC)
4	661.11 cm (21.69 ft)	2/0	200	2	250
4	833.63 cm (27.35 ft)	3/0	150	2	250
4	1051.25 cm (34.499 ft)	4/0	150	2	250

Frame positioning

Typically, equipment frames are positioned side-by-side, with the frame fronts facing the same direction.

Rack base description and dimensions

The base of the rack consists of the following:

- Isolation pads attached to the base to isolate the rack from the floor. The isolation pads are positioned between the floor and the base.
- Six 22 mm (0.87 inches) M12 mounting holes.
- Plastic shoulder washer in each hole to isolate the frame from the floor. [Figure 2-5](#) shows the footprint of the rack.

Figure 2-5 Rack footprint

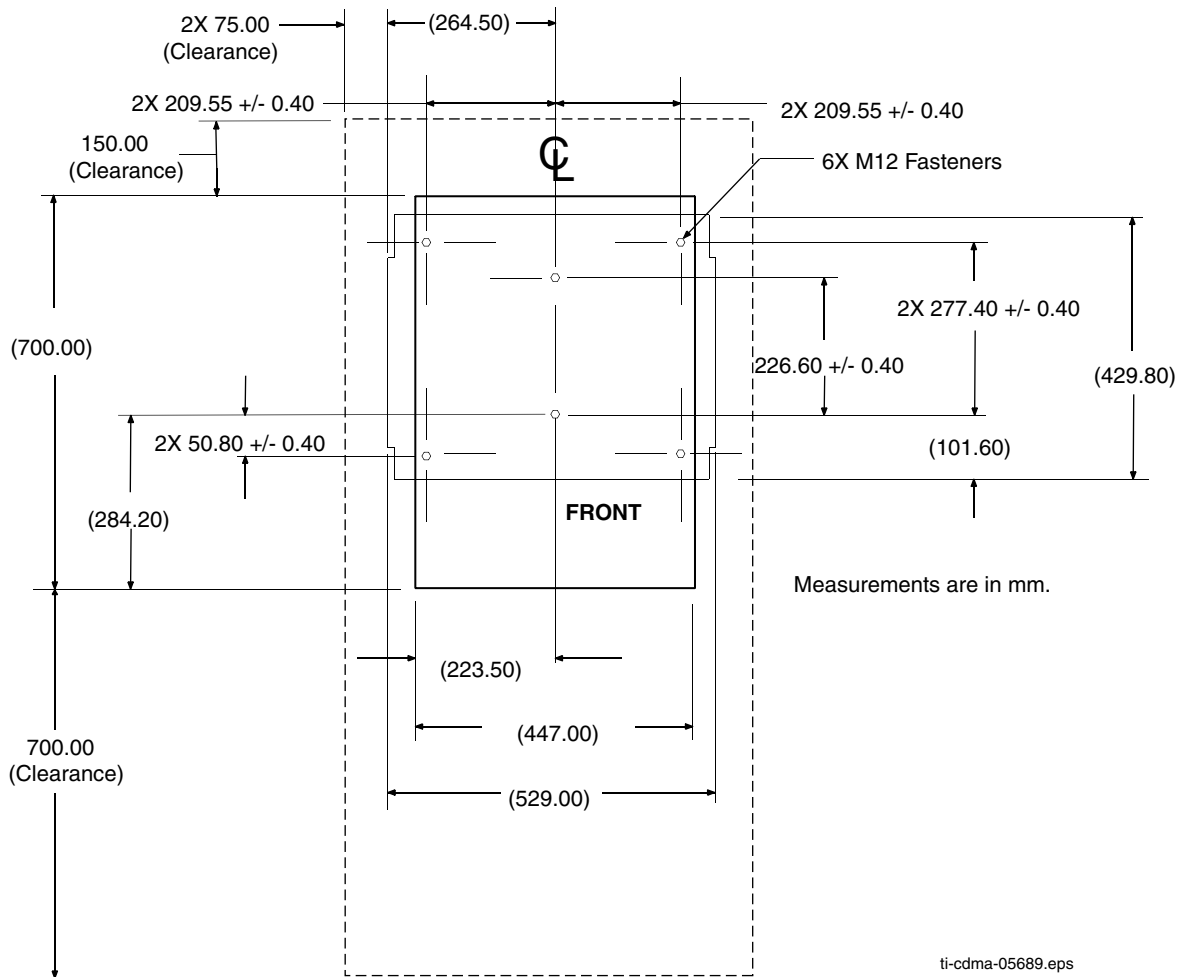

Task 1: Installing RGPS Head

Objective

The objective of this procedure is to install the optional Remote GPS (RGPS) head and cables (NN and AA). The site configuration/characteristics determines whether an RGPS head and cables are to be installed.

Any of the following RGPS heads may be used:

- STLN6594 (Motorola part number)
- 0186012H04 (Motorola part number)



NOTE

Cable NN works with any of the above listed RGPS heads.

RGPS head installation

Required items

The following tools are required:

- Adjustable torque ratchet with metric socket set
- Flat head screwdriver
- Lightning Arrestor (Motorola part number CGDSO971017AA1 or equivalent)

Table 2-9 gives a list of the cables for connecting the RGPS head.

Table 2-9 List of required cables for RGPS head installation

Cable	Quantity	Part Number	Description
AA	One	SGKN4430	15 pin D-connector on one end and loose wires (3086433H14) on the other end.
NN	Only one of the following:	3086039H10	RGPS cable, 15 m (50 ft); part of Option T472AG
		3086039H11	RGPS cable, 38 m (125 ft); part of Option T472AH
		3086039H12	RGPS cable, 76 m (250 ft); part of Option T472AJ
		3086039H13	RGPS cable, 152 m (500 ft); part of Option T472AK
		3086039H14	RGPS cable, 304 m (1000 ft); part of Option T472AL

Cabling diagrams

The following figures show the cabling for an RGPS head.

Figure 2-6 RGPS cabling diagram

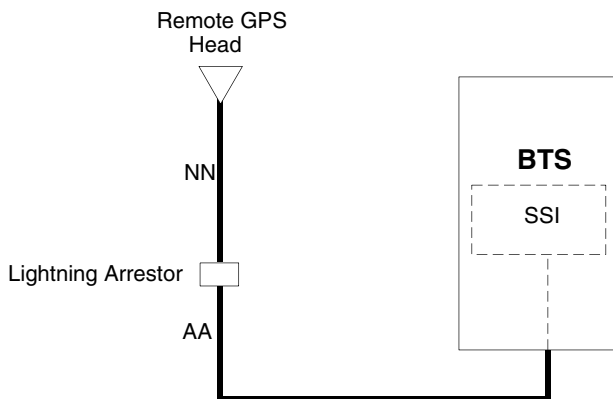

ti-cdma-05700.eps



CAUTION

When wiring the Motorola P/N STLN6594 RGPS Head at a new BTS site, the Yellow and Yellow/Black wires on both sides of the lightning arrestor must be disconnected (see [Figure 2-7](#) and [Figure 2-8](#)). Otherwise, the STLN6594 RGPS Head will be permanently damaged.



CAUTION

If a Motorola P/N 0186012H04 or 0186012H03 RGPS Head at an existing BTS site is being replaced with the Motorola P/N STLN6594 RGPS Head, the Yellow and Yellow/Black wires on both sides of the lightning arrestor must be disconnected (see [Figure 2-7](#) and [Figure 2-8](#)). Otherwise, the STLN6594 RGPS Head will be permanently damaged.



NOTE

The Motorola P/N 0186012H04 RGPS Head will work with the Yellow and Yellow/black wires disconnected or connected on both sides of the lightning arrestor.

Figure 2-7 RGPS wiring

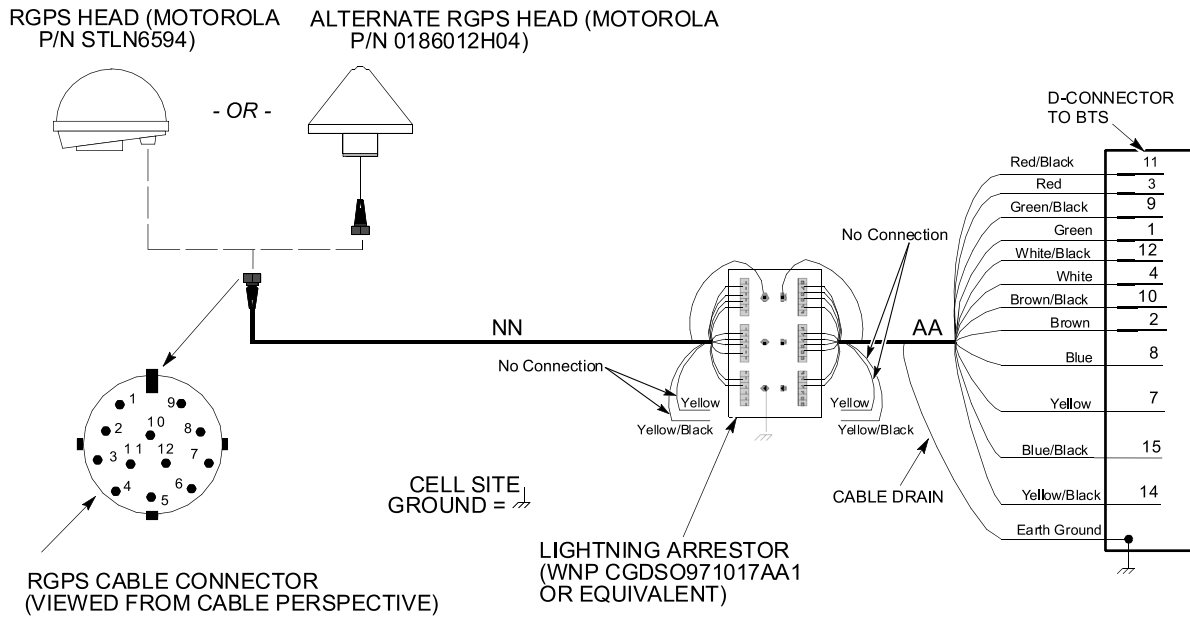

ti-cdma-05701.eps

Figure 2-8 RGPS lightning arrester wiring

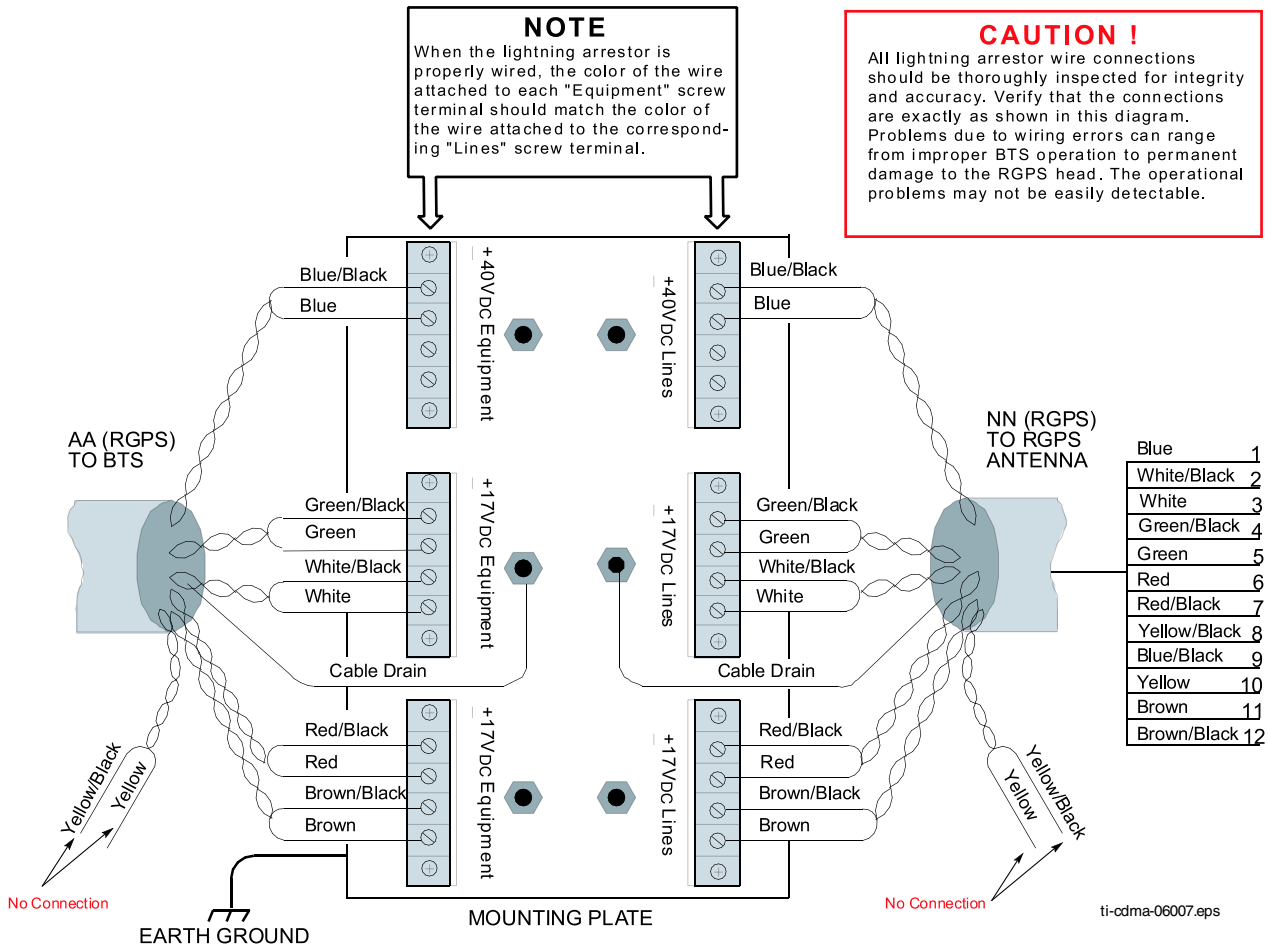

Mounting diagrams

Figure 2-9 and Figure 2-10 show the mounting details for the RGPS heads.

Figure 2-9 RGPS heads

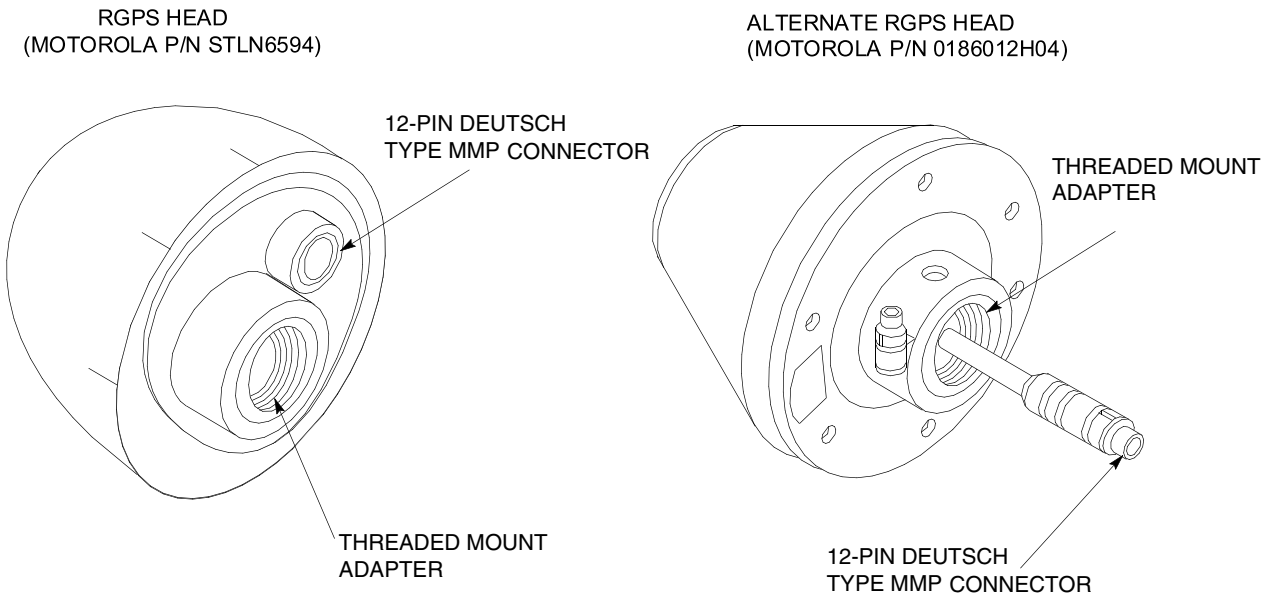

ti-cdma-05702.eps

Figure 2-10 Installing the RGPS head

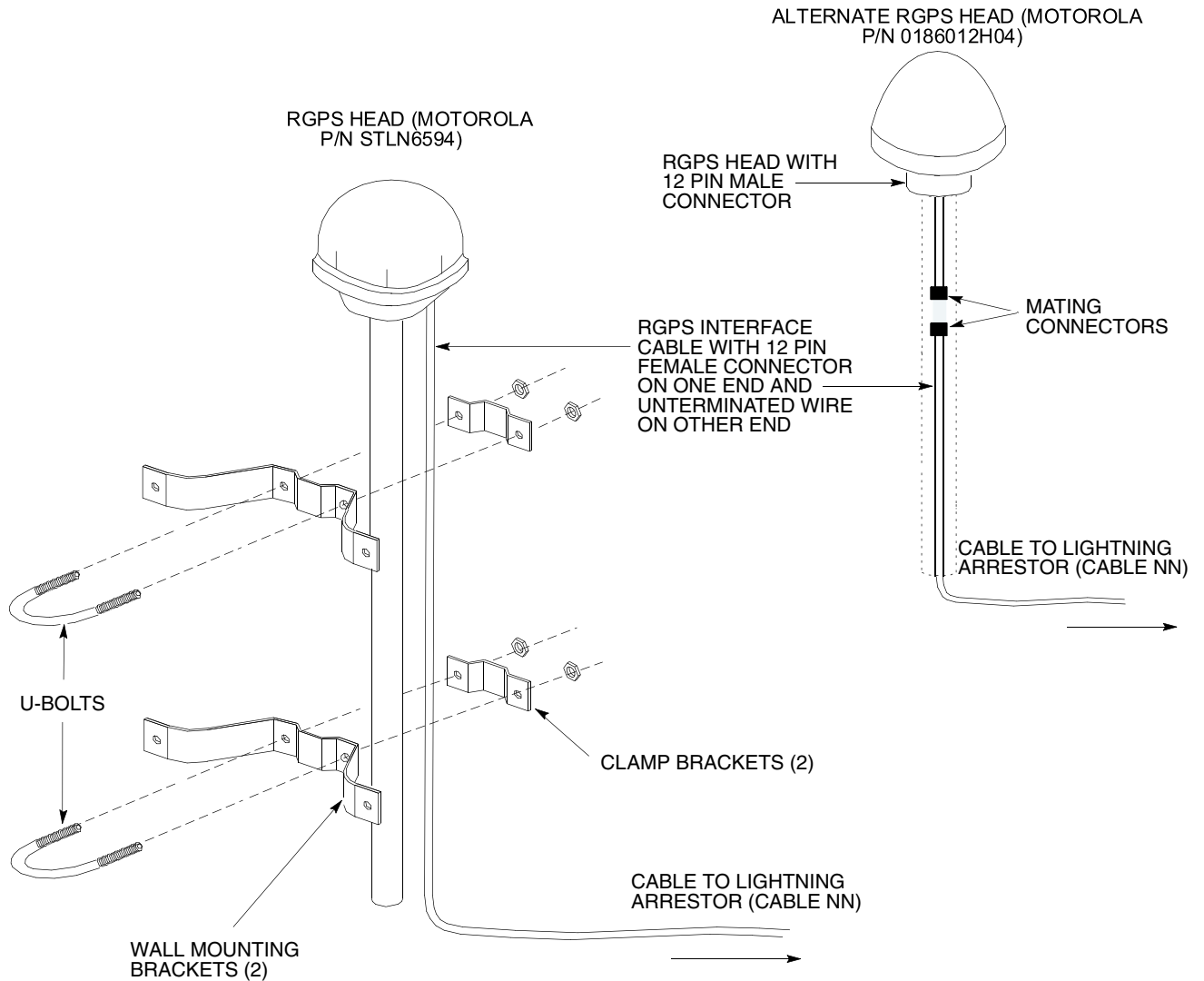

ti-cdma-05740.eps

Cable pinout

Figure 2-11 shows the connector pins on cables AA and NN. Table 2-10 gives the pinout for cable AA and NN and signal names.

Figure 2-11 Connector pin numbering for cables NN and AA

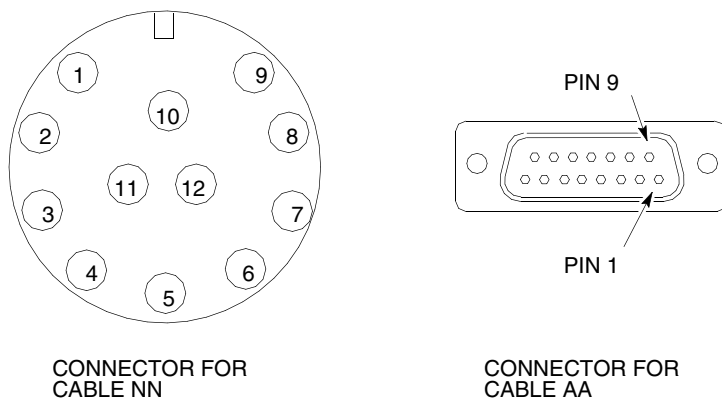

ti-cdma-00047.eps

Table 2-10 Pinout for cables NN and AA



Cable NN (12-cond)			Cable AA (12-cond)	
Pin (12-pins)	Signal	Wire Color	Pin (15-pins)	Signal
9	DC Ground 1	Blue-Black	15	RGPS Return
1	Power 1	Blue	8	RGPS +27 V Supply
8	Not Used	Yellow-Black	14	Not Used
10	Not Used	Yellow	7	Not Used
4	Transmit Port (-)	Green-Black	9	DATA (-) From Head
5	Transmit Port (+)	Green	1	DATA (+) From Head
2	Receive Port (-)	White-Black	12	DATA (-) To Head
3	Receive Port (+)	White	4	DATA (+) To Head
7	Not Connected	Red-Black	11	TDR Ground
6	Not Connected	Red	3	TDR (+)
12	PPS Timing (-)	Brown-Black	10	SYNC (-) From Head
11	PPS Timing (+)	Brown	2	SYNC (+) From Head
		Cable Drain (Shield)	13	Ground
			5, 6	Not Connected

Wire colors are the same for both cables.

Procedure

The procedure to install the RGPS antenna is as follows:

Procedure 2-1 Procedure to install an RGPS head

1	<p>Determine the mounting location for the RGPS head.</p> <div style="display: flex; align-items: center; gap: 10px;">  <div style="border: 1px solid black; padding: 2px 5px; background-color: #f4a460; font-weight: bold;">WARNING</div> </div> <p>The structure of the wall should be verified by a qualified structural engineer. Mounting the RGPS head and hardware to an inadequate wall structure and/or using inadequate installation methods can result in serious personal injury.</p>
2	<p>Use the appropriate mounting bolts for the mounting surface and install the two wall mounting brackets. Refer to Figure 2-10.</p>
3	<p>Route the 12-pin Deutsch (that is, circular) connector end of the RGPS cable (cable NN) to the RGPS head.</p>
4	<p>Connect the RGPS cable (cable NN) connector to the RGPS head 12-pin circular connector as shown in Figure 2-7 and Figure 2-10. Tighten the spinning flange on the connector a quarter turn, to secure the connection.</p>
5	<p>Insert the RGPS mounting pipe into the threaded mount of the RGPS head and carefully tighten it manually.</p>
6	<p>Install the RGPS mounting pipe into the mounting brackets as shown in Figure 2-10. Tighten the U-bolt clamps to secure the assembly. For the STLN6594 RGPS Head, tape or tie-wrap the cable to the mounting pipe.</p>
7	<p>Route the free end of the BTS RGPS cable (cable NN) to the RGPS cable lightning arrester. Remove any excess cable length and strip off approximately 15 cm of the cable outer insulation.</p>
8	<p>Connect the twelve (12) wires and cable drain of the cable end to the lightning arrester as shown in Figure 2-8. Double check the lightning arrester connections for compliance as displayed in Figure 2-8.</p> <div style="display: flex; align-items: center; gap: 10px;">  <div style="background-color: #00e0e0; padding: 2px 5px; font-weight: bold;">NOTE</div> </div> <p>RGPS cable AA gets connected to the UBS Macro BTS and then routed to the RGPS cable lightning arrester during Task 8.</p>

Tasks 2-3: Installing Rack & Ground Cable

Objectives

The objectives of this procedure are as follows:

- Mount the rack to the floor.
- Install the ground cable (DD).

Rack requirements

The UBS Macro BTS equipment is designed to be mounted in an open standard 19-inch rack.

To ensure proper equipment support, grounding, and easy installation, Motorola recommends that the UBS Macro BTS equipment be mounted in one of the following applicable Motorola racks:

- STHN4120 19-inch (1800 mm)
- STHN4121 19-inch (1400 mm)
- STHN4122 19-inch (1000 mm)

Structural engineer prerequisite

Ensure that the procedure, tools, and equipment required to mount the rack to the floor are specified by a Structural Engineer.

Required items

The following items are required:

- Rack
- 10 mm socket
- Torque driver
- Flat blade screwdriver
- 6 carbon steel grade 8.8 bolts M12 - customer supplied
- Other items, specified by the Structural Engineer, that are required to install the rack
- Cable DD - customer supplied ground cable, 4 AWG or larger diameter
- Two-hole ground lug and mounting nuts - part of rack hardware kit (CGDSTB54205)

Location of rack earth ground terminals

Figure 2-12 shows the location of the ground terminals on the rack.

Figure 2-12 Location of ground terminals on a Motorola rack

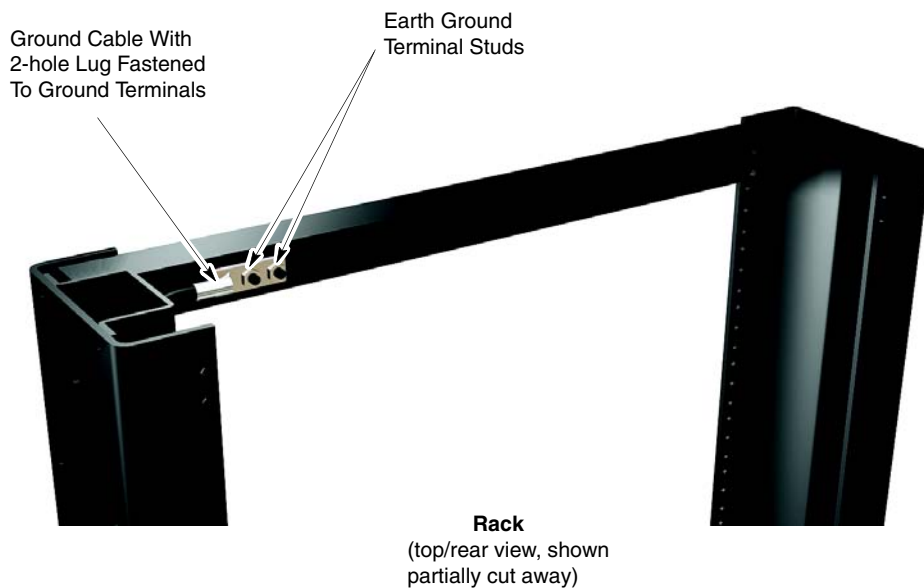

ti-cdma-05691.eps

Procedure

Procedure 2-2 gives the procedure for performing Tasks 2-3.

Procedure 2-2 Performing Tasks 2-3

1	<p>Mount the rack to the floor using the hardware, tools and procedures defined by the Structural Engineer.</p> <p> NOTE</p> <p>Motorola recommends using carbon steel grade 8.8 M12 bolts.</p>
---	---

Continued

Procedure 2-2 Performing Tasks 2-3 (Continued)

2	<p>Route the ground cable (cable DD) between the Master Ground Bar (MGB) and the rack.</p> <p> NOTE</p> <p>Ground cables must not have sharp bends.</p>
3	Strip insulation from the frame end of cable DD.
4	Attach the 2-hole lug to the rack-end of the cable DD.
5	Attach the end of cable DD with the 2-hole lug to the 2 terminal studs at the top of the rack. Using 2 nuts, 10 mm socket and ratchet, tighten the nuts to 5.65 N-m (50 inch-lb). Refer to Figure 2-12 for location of ground terminal studs on the rack.
6	Cut cable DD to length and connect it to the Master Ground Bar.
7	Verify that the Master Ground Bar is connected to a solid earth ground.