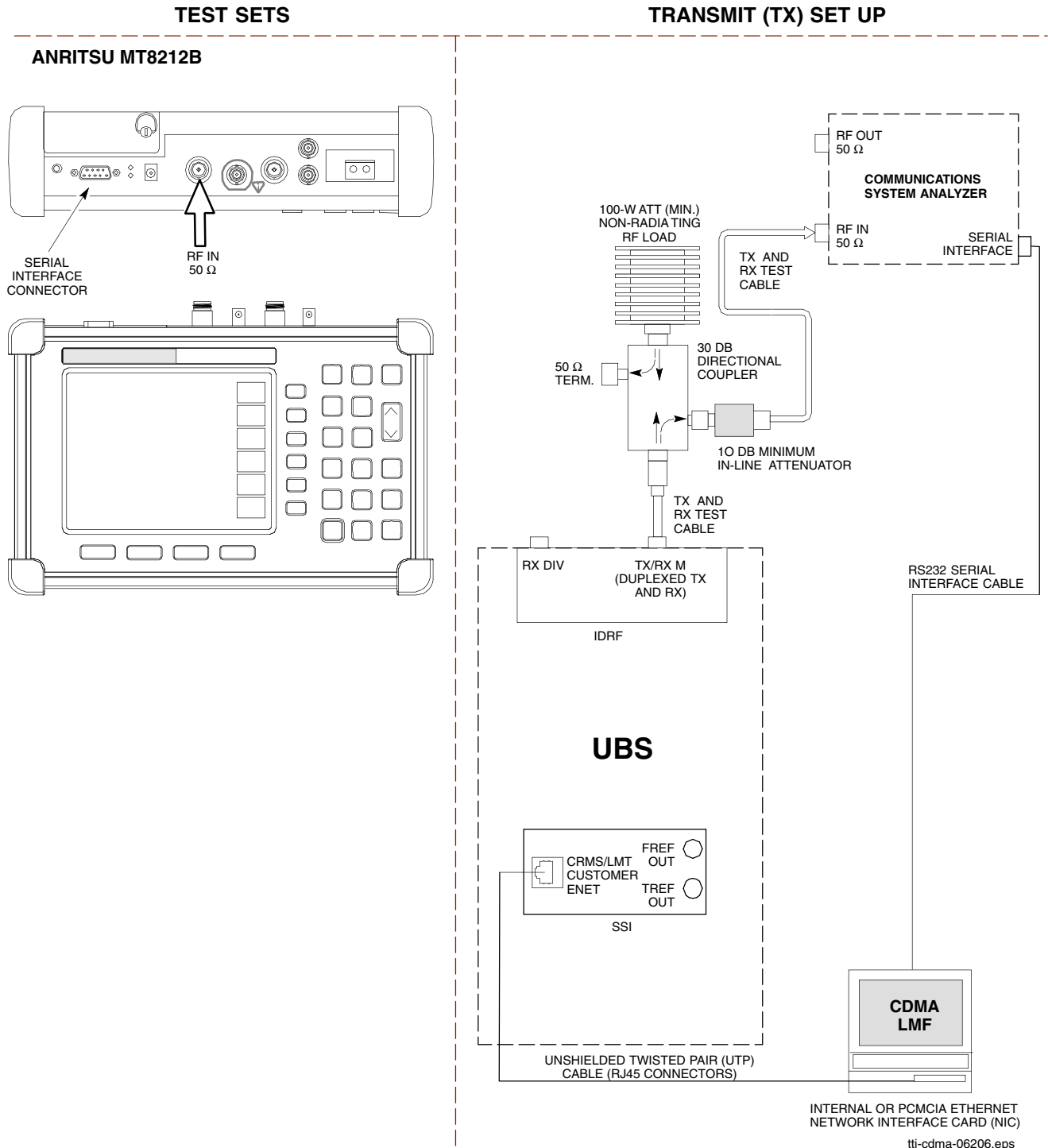

Figure 3-26 TX Calibration Test Setup – Anritsu MT8212B



Setup for ATP

[Figure 3-27](#), [Figure 3-28](#), [Figure 3-29](#), and [Figure 3-30](#) show test set connections for ATP tests.

Figure 3-27 ATP Test Setup – Agilent E4432B/8935 and Agilent E4432B/E4406A

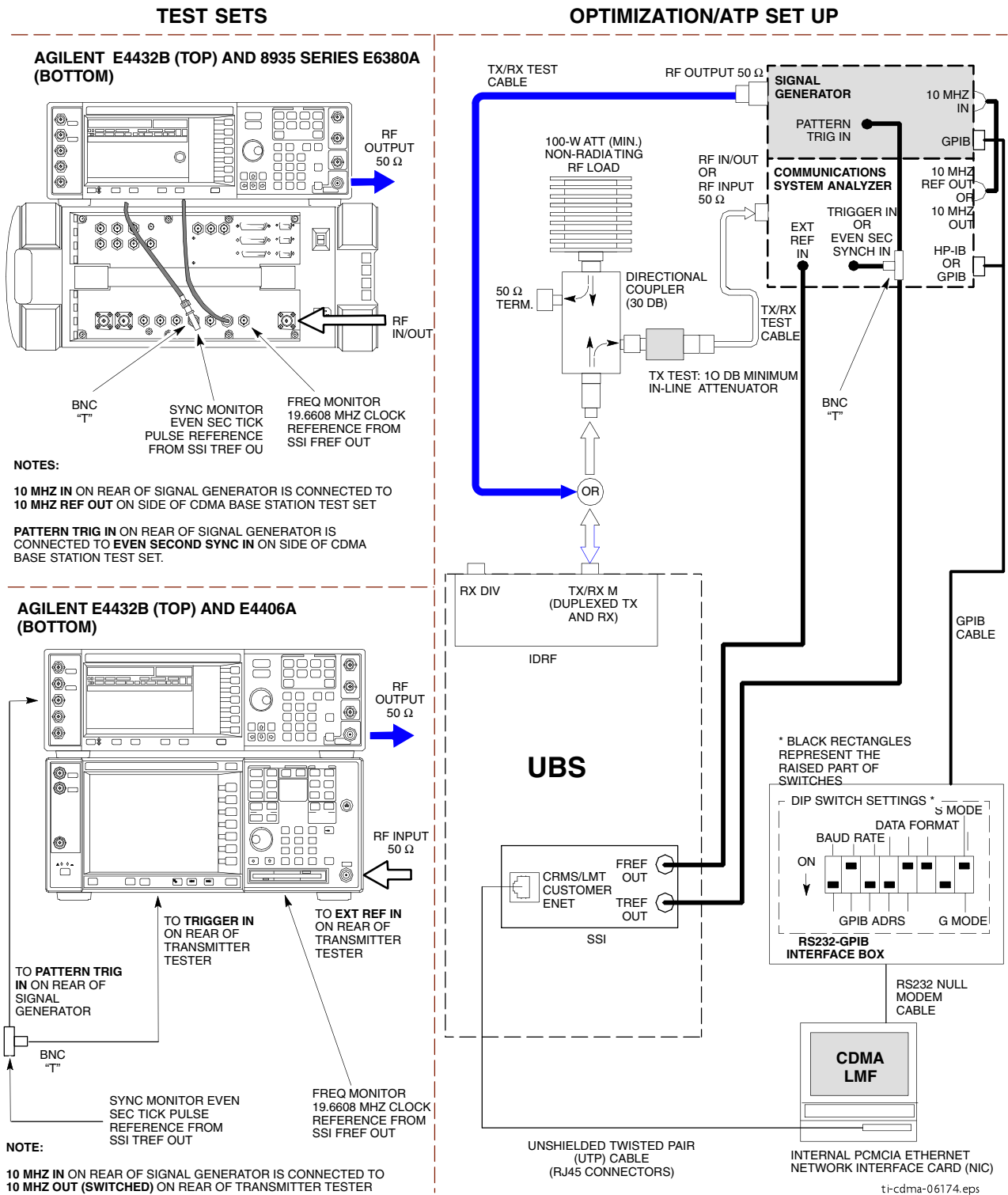
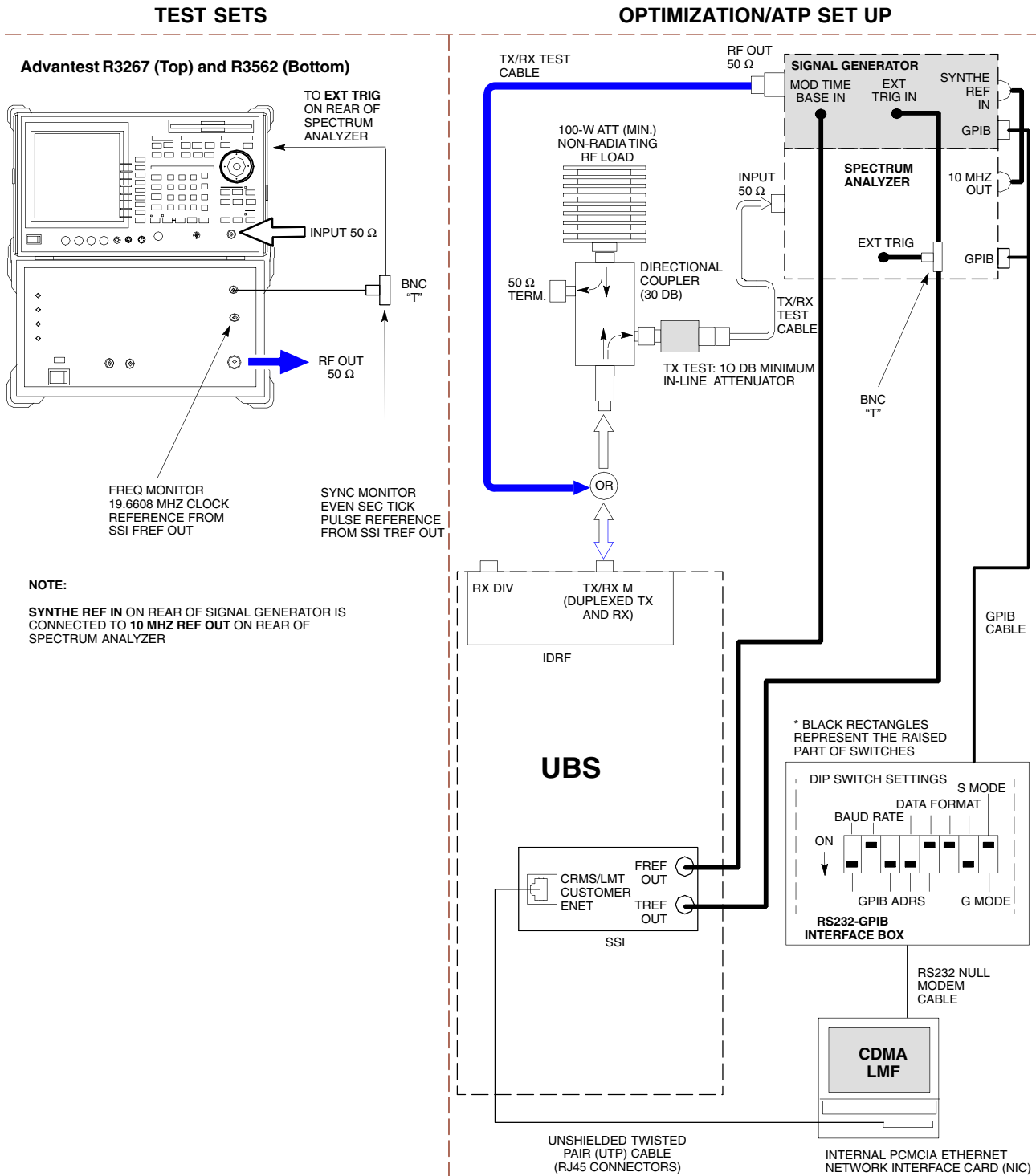

Figure 3-28 ATP Test Setup – Advantest R3267/3562



ti-cdma-06173.eps

Figure 3-29 ATP Test Setup – Agilent E7495A or E7495B

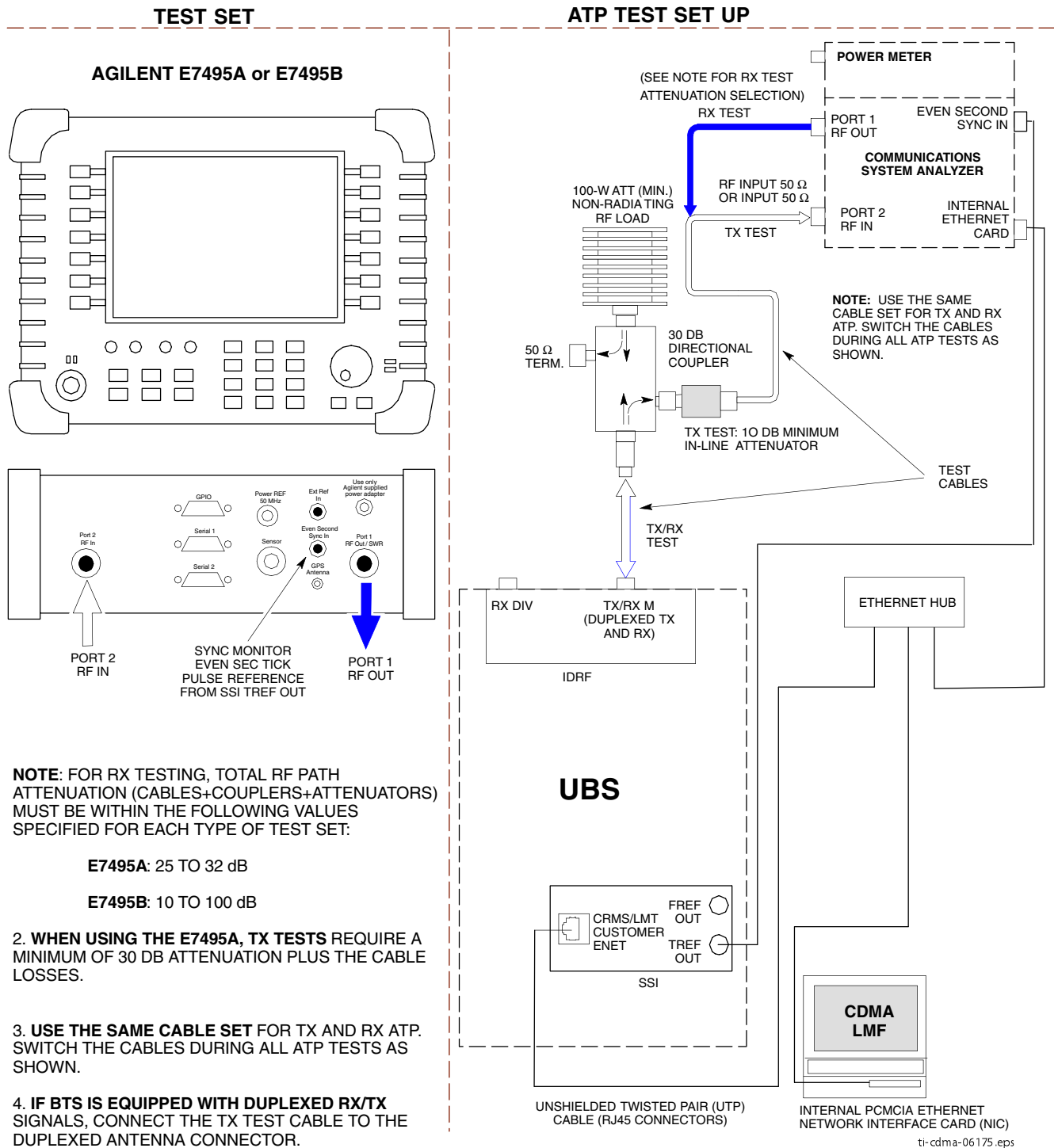
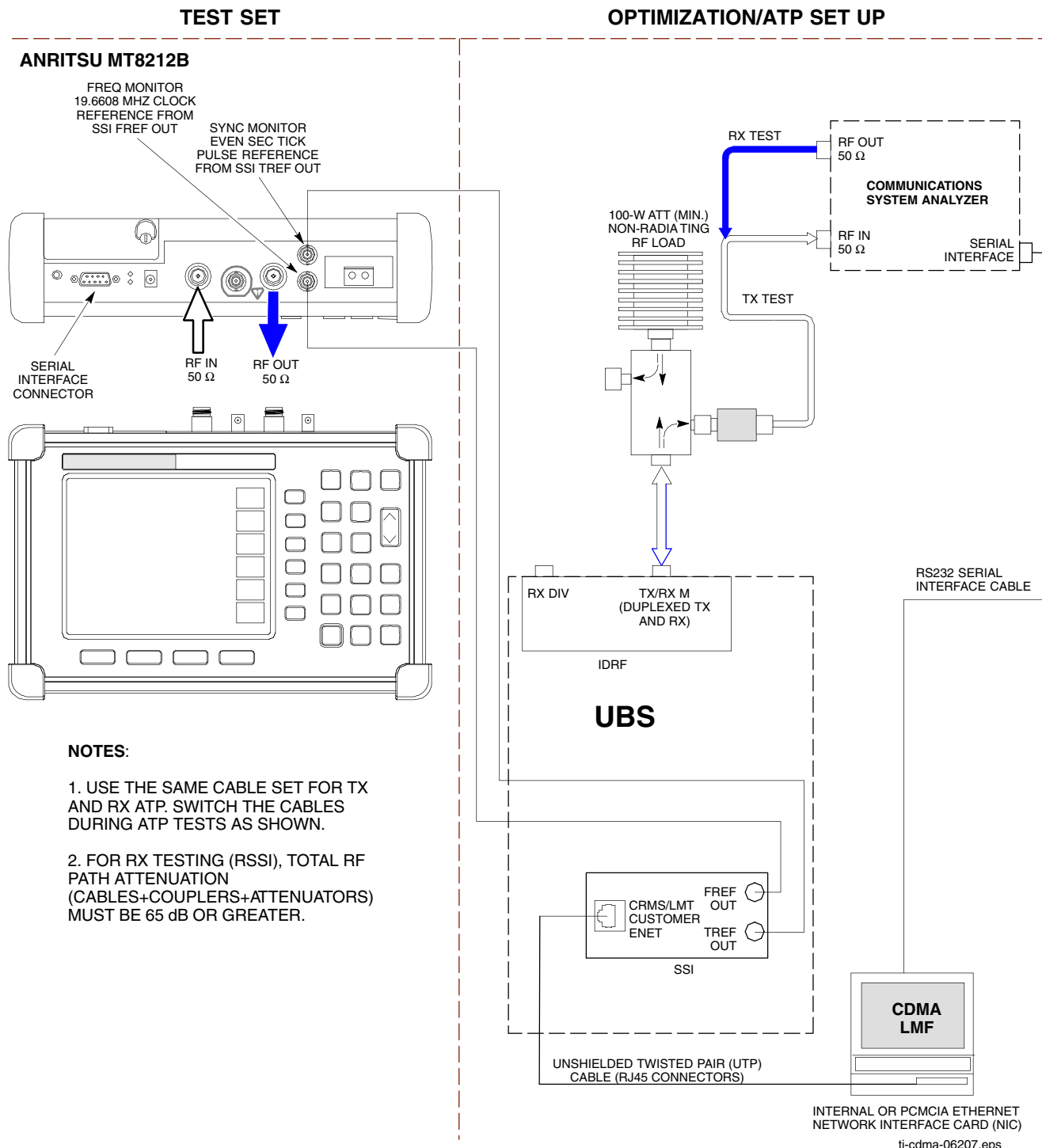

Figure 3-30 ATP Test Setup – Anritsu MT8212B



Test Equipment Connection to the LMF

Test Equipment Connection

The LMF computer platform provides two types of hardware interfaces which support three different test equipment communication methods.

- The COM hardware interface (RS-232) supports connection with both of the following communication methods:
 - o General Purpose Interface Bus (GPIB)
 - o Direct serial connection
- The Ethernet interface supports the network test equipment communication method.

Additional information on each interface type is provided in the following subsections.

COM Port Interface

The LMF computer RS-232 serial bus interfaces are designated as COM connections or ports in software. These interfaces support communication with test equipment connected to the LMF computer either directly with a serial cable or through a GPIB interface device (GPIB box). The LMF normally uses COM1 for the interface. COM2 is not used unless the LMF computer has two RS-232 connectors. The COM port selected in the LMF can not be used for any other purpose when the LMF is using it.

Selecting the COM port - Perform the following to select a COM port for use with test equipment needing either a GPIB or a direct serial connection:

Procedure 3-6 Selecting a COM Port for GPIB or Serial Test Equipment Connection

1	From the LMF window menu bar select Tools > Options . Result: The LMF Options window opens.
2	If the Test Equipment tab is not in the forefront, click the tab to bring it forward.
3	Click in the COM radio button in the GPIB/COM settings area. Result: A black dot appears in the circle.
4	Select the COM port to use (normally COM1) from the dropdown in the Port: box of the GPIB/COM settings area.
5	Click the Save button to save the selection configuration for future LMF sessions.
6	Click the Close button to close the LMF Options window.

Disconnecting and Reconnecting the LMF and the COM port - The LMF can be disconnected from the active COM port by using the **Disconnect Port** button in the **GPIB/COM settings** area of the **Test Equipment** tab. Disconnecting the LMF may be needed, for example, to use a HyperTerminal connection for a hardware Man Machine Interface (MMI) communication session. Perform the following to disconnect or reconnect the LMF and the selected COM port.

Procedure 3-7 Disconnect and Reconnect the LMF and the Active COM Port

1	From the LMF window menu bar select Tools > Options . Result: The LMF Options window opens.
2	If the Test Equipment tab is not in the forefront, click the tab to bring it forward.
3	<i>Disconnect</i> the LMF from the active COM port: click the Disconnect Port button in the GPIB/COM settings area.
4	<i>Reconnect</i> the LMF to the active COM port: click the Detect button in the GPIB Test equipment or Serial Test Equipment area.
5	If no other operations are required in the LMF Options window click Close to close the window.

Ethernet Interface

The LMF computer Ethernet interface supports communication with test equipment which uses the network connection method. This interface uses Internet Protocol (IP) addressing to differentiate each node on the network. Motorola recommends that the Ethernet connection be done through an Ethernet hub. The hub connects to the LMF computer, the test equipment, and the base station Local Area Network (LAN). Connection details are as follows:

Test equipment to hub - This is an Unshielded Twisted Pair (UTP) Ethernet cable with two 10/100Base-TX 8-contact modular connectors.

LMF to hub - Use one of the following cable types to connect the LMF to the Hub:

- Ethernet cable. Be sure the computer Network Interface Card (NIC) is set for either AUTO or to use the 8-contact modular connector only.
- Coaxial cable between NIC and Hub. For a computer NIC equipped with a 10Base-2 (BNC) connector, use a BNC tee connector on the hub. If the hub does not have BNC connectors, use a BNC-to-UTP adapter with the tee connector. Connect a coaxial cable between the NIC and one end of the BNC tee crossbar.

Hub to base station- Use one of the following, depending on the type of base station to be calibrated or tested:

- For UBS with 10/100Base-T LAN: Connect an Ethernet cable between the hub and the SSI CRMS/LMT CUSTOMER ENET connector.

Addressing Methods

Different addressing methods are used for test equipment depending on the type of interface connection it has. The different addressing methods are described in the following subsections.

GPIB Addresses

GPIB addresses can range from 1 through 30. The LMF will accept any address in that range, but the numbers entered in the LMF Options window GPIB address box must match the addresses set in the test equipment. Motorola recommends using **1** for a CDMA signal generator, **13** for a power meter, and **18** for a communications system analyzer. To verify and, if necessary, change the GPIB addresses of the test equipment, refer to the *Setting GPIB Addresses* sections of [Appendix D Test Equipment Preparation](#).

Serial Connection

This connection type uses a direct serial connection between the test equipment and the LMF computer platform. The *Anritsu* MT8212B communications test set is an example of test equipment using this type of connection. There are no specific addressing requirements for this type of interface.

IP Addresses

Test equipment using the Network connection type use IP addresses to identify them on the Ethernet LAN. The E7495A and E7495B communications test sets are examples of Network connection test equipment. Setting the IP address in the test equipment is covered in the specific test equipment (for example, Agilent E7495) set-up section of [Appendix D Test Equipment Preparation](#).

Test Equipment Selection

Test Equipment Selection

Test equipment selection is performed in the **LMF Options** window, accessed through **Tools > Options** in the LMF window menu bar. The window has four tabs covering different categories of options. Test equipment operations, including selection, are performed on the **Test Equipment** tab. For software release 2.20.0.x (R20), the test equipment list displayed on this tab is context sensitive based on the **Connection type** selected.

- When **GPIB** is selected, only test equipment with a GPIB interface is displayed.
- When **Serial** is selected, only test equipment needing a direct serial connection is displayed.
- When **Network** is selected, only test equipment needing an Ethernet connection is displayed.

Manual and Autodetect Selection

Test equipment can be manually specified before or after the test equipment is connected. The LMF does not try to determine if the test equipment is actually connected for manual selection. The LMF can be commanded to automatically detect test equipment connected to it. This autodetection feature is operated by a **Detect** button located in the test equipment list area for each connection type (GPIB, Serial, or Network).

Selecting Test Equipment

There is a different set of test equipment selection procedures for each test equipment connection type. These are:

- GPIB connection
- Serial connection
- Network (Ethernet) connection

Selection Procedures

Test equipment selection procedures are contained in the following subsections. Each subsection is for a different connection type. Each subsection includes a procedure for manually specifying test equipment items and a procedure to have the LMF automatically detect the connected test equipment.

GPIB Interface Test Equipment Manual Selection and Autodetection

Prerequisites - The following must be done before performing these procedures:

- LMF computer and test equipment are both correctly connected to the GPIB box
- Test equipment is turned on
- GPIB addresses set in the test equipment have been verified as correct using the applicable procedures in [Appendix D Test Equipment Preparation](#).

Manual selection – Test equipment may be selected manually even if it is not connected to the LMF.

Procedure 3-8 Manually Selecting Test Equipment - GPIB Interface

1	In the LMF menu bar, select Tools > Options . Result: The LMF Options window appears.
2	Click on the Test Equipment tab (if not in the forefront).
3	Click the GPIB radio button in the Connection Type area. Result: A black dot appears in the circle.
4	Click the COM radio button in the GPIB/COM settings area. Result: A black dot appears in the circle.
5	Select the correct LMF computer serial port from the Port: pick list (normally COM1) (Refer to the Test Equipment Connection to the LMF on page 3-45 section of this chapter).
6	In the GPIB Test equipment area click the checkbox(es) of the test equipment being used. Result: Checkmarks appear in the boxes clicked on.
7	If one is not already displayed, type the GPIB address for each checked piece of test equipment in the corresponding box labeled GPIB . Recommended Addresses 1 = CDMA Signal generator 13 = Power Meter 18 = CDMA Analyzer
<div style="display: flex; align-items: center;">  <div style="background-color: #00ffff; padding: 5px; border: 1px solid black; font-weight: bold; font-size: 1.2em;">NOTE</div> </div> <p style="margin-top: 10px;">When the test equipment items are manually selected, the CDMA analyzer is used only if a power meter is not selected.</p>	

Continued

Procedure 3-8 Manually Selecting Test Equipment - GPIB Interface (Continued)

8	Click the Apply button. The button will darken until the selection is committed.
9	Click the Detect on startup checkbox in the Autodetection settings area to allow the LMF to detect the test equipment automatically on application startup. A checkmark appears in the box.
10	Click the Save button to save the selection configuration for future LMF sessions.
11	Click the Close button to close the LMF Options window.



NOTE

When two devices of the same type have been selected, a window will appear warning that more than one signal generator/power meter/ analyzer has been chosen. Click the **Continue** button to close this window. The checkbox can be clicked to prevent the window from being displayed again, if desired.



Automatically Selecting Test Equipment (Autodetection) – When using the autodetection feature to select test equipment, the LMF determines which test equipment items are actually communicating with the LMF.

Procedure 3-9 Autodetecting Test Equipment - GPIB Interface

1	In the LMF menu bar, select Tools > Options . Result: The LMF Options window appears.
2	Click on the Test Equipment tab (if not in the forefront).
3	Click the GPIB radio button in the Connection Type area. Result: A black dot appears in the circle.
4	Click the COM radio button in the GPIB/COM settings area. Result: A black dot appears in the circle.
5	Select the correct LMF computer serial port from the Port: pick list (normally COM1) (Refer to the Test Equipment Connection to the LMF on page 3-45 section of this chapter).

Continued

Procedure 3-9 Autodetecting Test Equipment - GPIB Interface (Continued)

6	<p>If they are not already displayed, enter the GPIB address for each piece of required test equipment, separated by commas, in the GPIB Addresses: box in the GPIB Test equipment area.</p> <p>Recommended Addresses 1 = CDMA Signal generator 13 = Power Meter 18 = CDMA Analyzer</p> <div style="display: flex; align-items: center; margin-top: 10px;">  <div style="background-color: #00b0f0; color: white; padding: 5px 10px; font-weight: bold; text-align: center;">NOTE</div> </div> <p style="margin-top: 10px;">In autodetection when both a power meter and a CDMA analyzer are selected, the LMF uses the first item that is capable of performing RF power measurement listed in the GPIB Addresses: box. The address for a CDMA signal generator is normally 1, the address for a power meter is normally 13, and the address for a CDMA analyzer is normally 18. If 1,13,18 is listed in the GPIB Addresses: box, the power meter (13) is used for RF power measurements. When the test equipment items are manually selected, the CDMA analyzer is used only if a power meter is not selected.</p>
7	<p>Click the Detect button. The button will darken until the selection is committed.</p> <p>Result: For each detected equipment item, a check will appear in its checkbox and its GPIB address will appear in its GPIB box.</p>
8	<p>Click the Detect on startup checkbox in the Autodetection settings area to allow the LMF to detect the test equipment automatically on application startup.</p> <p>Result: A checkmark appears in the box.</p>
9	<p>Click the Save button to save the selection configuration for future LMF sessions.</p>
10	<p>Click the Close button to close the LMF Options window.</p> <div style="display: flex; align-items: center; margin-top: 10px;">  <div style="background-color: #00b0f0; color: white; padding: 5px 10px; font-weight: bold; text-align: center;">NOTE</div> </div> <p style="margin-top: 10px;">When two devices of the same type have been selected, a window will appear warning that more than one signal generator/power meter/ analyzer has been chosen. Click the Continue button to close this window. The checkbox can be clicked to prevent the window from being displayed again, if desired.</p>

Serial Interface Test Equipment Manual Selection and Autodetection

Prerequisites – The following must be done before performing these procedures:

- Test equipment is correctly connected to the LMF computer RS-232 connector with a serial cable
- Test equipment is turned on

Manual selection – Test equipment may be selected manually even if it is not connected to the LMF.

Procedure 3-10 Manually Selecting Test Equipment - Serial Interface

1	In the LMF menu bar, select Tools > Options . Result: The LMF Options window appears.
2	Click on the Test Equipment tab (if not in the forefront).
3	Click the Serial radio button in the Connection Type area. Result: A black dot appears in the circle.
4	Click the COM radio button in the GPB/COM settings area. Result: A black dot appears in the circle.
5	Select the correct LMF computer serial port from the Port: pick list (normally COM1) (Refer to the Test Equipment Connection to the LMF on page 3-45 section of this chapter).
6	In the Serial Test equipment , area click the checkbox(es) of the test equipment being used. Result: Checkmarks appear in the box(es) clicked on.
7	Click the Apply button. The button will darken until the selection is committed.
8	Click the Detect on startup checkbox in the Autodetection settings area to allow the LMF to detect the test equipment automatically on application startup. Result: A checkmark appears in the box.
9	Click the Save button to save the selection configuration for future LMF sessions.
10	Click the Close button to close the LMF Options window.

Automatically Selecting Test Equipment (Autodetection) – When using the autodetection feature to select test equipment, the LMF determines which test equipment items are actually communicating with the LMF.

Procedure 3-11 Autodetecting Test Equipment - Serial Interface

1	In the LMF menu bar, select Tools > Options . Result: The LMF Options window appears.
2	Click on the Test Equipment tab (if not in the forefront).
3	Click the Serial radio button in the Connection Type area. Result: A black dot appears in the circle.

Continued

Procedure 3-11 Autodetecting Test Equipment - Serial Interface (Continued)

4	Click the COM radio button in the GPIB/COM settings area. Result: A black dot appears in the circle.
5	Select the correct LMF computer serial port from the Port: pick list (normally COM1) (Refer to the Test Equipment Connection to the LMF on page 3-45 section of this chapter).
6	Choose the test equipment on the Serial Test Equipment list by clicking the corresponding checkbox. Result: A checkmark appears in the box.
7	Click the Detect button. The button will darken until the selection is committed. Result: For each detected equipment item, a check will appear in its checkbox.
8	Click the Detect on startup checkbox in the Autodetection settings area to allow the LMF to detect the test equipment automatically on application startup. Result: A checkmark appears in the box.
9	Click the Save button to save the selection configuration for future LMF sessions.
10	Click the Close button to close the LMF Options window.

Network Interface Test Equipment Manual Selection and Autodetection

Prerequisites- The following must be done before performing these procedures:

- Be sure that no other equipment is connected to the LMF.
- Test equipment is correctly connected to the LMF computer through the Ethernet LAN
- The IP address is set in the test equipment as specified in the test equipment model (for example, Agilent E7495) set-up section of [Appendix D Test Equipment Preparation](#).
- Test equipment is turned on

Manual selection – Test equipment may be selected manually even if it is not connected to the LMF.

Procedure 3-12 Manually Selecting Test Equipment - Network Interface

1	In the LMF menu bar, select Tools > Options . Result: The LMF Options window appears.
2	Click on the Test Equipment tab (if not in the forefront).
3	Click the Network radio button in the Connection Type area. Result: A black dot appears in the circle.

Continued

Procedure 3-12 Manually Selecting Test Equipment - Network Interface (Continued)

4	In the Ethernet Test equipment area click the checkbox(es) of the test equipment being used. Result: Checkmarks appear in the box(es) clicked on.
5	If it is not already displayed, enter the IP address for the required piece test equipment in the IP box in the Ethernet Test equipment area.
6	Click the Apply button. The button will darken until the selection is committed.
7	Click the Detect on startup checkbox in the Autodetection settings area to allow the LMF to detect the test equipment automatically on application startup. Result: A checkmark appears in the box.
8	Click the Save button to save the selection configuration for future LMF sessions.
9	Click the Close button to close the LMF Options window.

Automatically Selecting Test Equipment (Autodetection) – When using the autodetection feature to select test equipment, the LMF determines which test equipment items are actually communicating with the LMF.

Procedure 3-13 Autodetecting Test Equipment - Network Interface

1	In the LMF menu bar, select Tools > Options . Result: The LMF Options window appears.
2	Click on the Test Equipment tab (if not in the forefront).
3	Click the Network radio button in the Connection Type area. Result: A black dot appears in the circle.
4	If it is not already displayed, enter the IP address for the required piece test equipment in the IP box in the Ethernet Test equipment area.
5	Click the Detect button. The button will darken until the selection is committed. Result: For each detected equipment item, a check will appear in its checkbox.
6	Click the Detect on startup checkbox in the Autodetection settings area to allow the LMF to detect the test equipment automatically on application startup. Result: A checkmark appears in the box.
7	Click the Save button to save the selection configuration for future LMF sessions.
8	Click the Close button to close the LMF Options window.

Test Set Calibration

Test Set Calibration Background

Proper test equipment calibration ensures that the test equipment and associated test cables do not introduce measurement errors, and that measurements are correct.



NOTE

If the test equipment set being used to interface with the base station has been calibrated and maintained as a set, this procedure does not need to be performed. (Test equipment set includes LMF computer, communications test set, additional test equipment, associated test cables, and adapters.)

This procedure must be performed *before* beginning the optimization. Verify all test equipment (including all associated test cables and adapters actually used to interface all test equipment and the base station) has been calibrated and maintained as a set.



CAUTION

If any piece of test equipment, test cable, or RF adapter, that makes up the calibrated test equipment set, has been replaced, re-calibration must be performed. Failure to do so can introduce measurement errors, resulting in incorrect measurements and degradation to system performance.



NOTE

Calibration of the communications test set (or equivalent test equipment) must be performed at the site before calibrating the overall test set. Calibrate the test equipment *after* it has been allowed to warm-up and stabilize for a *minimum of 60 minutes*.

Calibration Procedures Included

Automatic

Procedures included in this section use the LMF automated calibration routines to determine path losses of the supported communications analyzer, power meter, associated test cables, adapters, and (if used) antenna switch that make up the overall calibrated *test equipment set*. After calibration, the gain/loss offset values are stored in a test measurement offset file on the LMF computer.

Manual

Agilent E4406A Transmitter Tester - The E4406A does not support the power level zeroing calibration performed by the LMF. If this instrument is to be used for Bay Level Offset calibration and calibration is attempted with the LMF Calibrate Test Equipment function, the LMF will return a status window failure message stating that zeroing power is not supported by the E4406A. Refer to [Appendix D Test Equipment Preparation](#) for instructions on using the instrument's self-alignment (calibration) function prior to performing Bay Level Offset calibration.

Power Meters - Manual power meter calibration procedures to be performed prior to automated calibration are included in [Appendix D Test Equipment Preparation](#).

Cable Calibration - Manual cable calibration procedures using the Advantest R3465 communications system analyzer are provided in [Appendix D Test Equipment Preparation](#), if needed.

Prerequisites

Ensure the following prerequisites have been met before proceeding:

- Test equipment is correctly connected and turned on.
- Test equipment addressing is set as required for the connection type being used (GPIB, Serial, Network)

Calibrate Test Equipment Function (Except Agilent E4406A and Anritsu MT8212B)

The **Calibrate Test Equipment** function zeros the power measurement level of the test equipment item to be used for TX calibration and audit. If both a power meter and an analyzer are connected, only the power meter is zeroed.



NOTE

1. The Agilent E4406A transmitter tester does not support power measurement level zeroing. Refer to the Test Equipment Calibration section of Appendix F for E4406A calibration.
2. Power measurement zeroing and other required calibration procedures for the *Anritsu* MT8212B are included in the [Calibrating the *Anritsu* MT8212B on page 3-57](#) subsection below.

Prerequisites

- Test equipment to be zeroed has been connected correctly for tests to be run.
- Test equipment has been selected in the LMF ([Test Equipment Selection on page 3-48](#)) and detected.

Procedure

Perform the following to calibrate the test equipment.

Procedure 3-14 Calibrate Test Equipment - Power Measurement Zeroing

1	From the Util menu, select Calibrate Test Equipment from the pull-down menu. A Directions window is displayed.
2	Follow the directions provided.
3	Click on Continue to close the Directions window and start the calibration process. A status report window is displayed.
4	Click on OK to close the status report window.

Calibrating the *Anritsu* MT8212B

Three types of calibration are required for the MT812B. These are:

- Zero out power meter
- Calibrate TX Analyzer
- Calibrate CW Generator

Procedures for each type of calibration is covered in the following subsections.

Zero Out Power Meter

Before using the MT8212B test set to perform RF power measurement, the test set internal power meter function must be zeroed.

Prerequisites – The following must be done before the zeroing out the power meter:

- The test set is connected to the LMF computer serial port with the *Anritsu* 800-441 RS-232 serial interface cable
- Test equipment is turned on and has warmed up for at least 60 minutes.
- Test equipment has been selected/detected in the LMF ([Test Equipment Selection on page 3-48](#))

Zero out power meter – Perform the following to zero out the power meter function before performing RF power measurements.

Procedure 3-15 *Anritsu* MT8212B Multi-function Test Set Zero Out Power Meter

1	In the LMF menu bar select Util > Calibrate Test Equipment . Result: A Calibrate <i>Anritsu</i> MT8212B window appears.
2	Click in the Option for zero out power meter on <i>Anritsu</i> MT8212B radio button in the Zero Out Power Meter area. Result: A black dot appears in the circle.
3	Click on OK . Result: A Directions window is displayed.
4	Follow the directions provided. Result: A status report window will open.
5	Click on OK to close the status report window.

Calibrate TX Analyzer

TX Analyzer calibration should be accomplished before performing any ATP operations with the MT8212B.

Prerequisites – The following must be done before the CW generator calibration:

- The test set is connected to the LMF computer serial port with the *Anritsu* 800-441 RS-232 serial interface cable
- Test equipment has been selected/detected in the LMF ([Test Equipment Selection on page 3-48](#))
- Additional items must be available for the TX Analyzer calibration method chosen as indicated in the following:

- Standard Open-Short-Load Components calibration:
 - *Anritsu* 22N50 Open/Short, DC to 18 GHz, N(m) connector, 50 ohm
 - *Anritsu* SM/PL precision load, DC-to-4 GHz, 42 dB, N(m) connector, 50 ohm
- Standard InstaCal™ calibration:
 - *Anritsu* ICN50 *InstaCal* calibration module, 2 MHz to 4 GHz, N(m) connector, 50 ohm

TX analyzer calibration – Perform the following to calibrate the MT8212B TX analyzer function..

Procedure 3-16 *Anritsu* MT8212B Multi-function Test Set TX Analyzer Calibration

1	In the LMF menu bar select Util > Calibrate Test Equipment.Calibrate <i>Anritsu</i> MT8212B window appears
2	Click in the radio button in the Calibrate TX Analyzer area. Result: A black dot appears in the circle.
3	Select the required frequency band from the dropdown list in the Frequency Band: box. <div style="display: flex; align-items: center;">  <div style="background-color: #00b050; color: white; padding: 5px 10px; font-weight: bold; text-align: center;">NOTE</div> </div> <p style="margin-left: 40px;">The dropdown list in the Frequency Band: box is automatically populated with selections for the base station the LMF is logged into.</p>
4	Enter the channel number to be calibrated in the Channel box.
5	Select the desired calibration method from the dropdown list in the Calibration Method box.
6	Click OK . Result: A Directions window is displayed.
7	Follow the directions provided.
8	When actions required by directions have been completed, click on Continue to close the Directions window and start the generator calibration process. Result: A status report window is displayed.
9	Click on OK to close the status report window.

Calibrate CW Generator

Before using the MT8212B test set to perform base station RSSI testing, the test set internal Continuous Wave (CW) generator must be calibrated.

Prerequisites - The following must be done before the CW generator calibration:

- The test set is connected to the LMF computer serial port with the *Anritsu* 800-441 RS-232 serial interface cable
- Test equipment is turned on and has warmed up for *at least 60 minutes*.
- Test equipment has been selected/detected in the LMF ([Test Equipment Selection on page 3-48](#))
- RX cable(s) used in the calibration process must be calibrated for the channel for which the CW generator is to be calibrated (refer to [Figure 3-34](#) and [Calibrating cables on page 3-65](#))

CW generator calibration - Perform the following to calibrate the MT8212B internal CW generator before performing RSSI testing with this test set.

Procedure 3-17 *Anritsu* MT8212B Multi-function Test Set CW Generator Calibration

1	In the LMF menu bar select Util > Calibrate Test Equipment . Result: Calibrate Anritsu MT8212B window appears
2	Click in the radio button in the Calibrate CW Generator area. Result: A black dot appears in the circle.
3	Select the required frequency band from the dropdown list in the Frequency Band: box. <div style="display: flex; align-items: center;"> <div style="background-color: #00b050; color: white; padding: 5px 10px; border-radius: 5px;">NOTE</div> </div> <p>The dropdown list in the Frequency Band: box is automatically populated with selections for the base station the LMF is logged into.</p>
4	Enter the channel or channels to be calibrated in the Channel(s) box (separate multiple channels with a comma and no space). <div style="display: flex; align-items: center;"> <div style="background-color: #00b050; color: white; padding: 5px 10px; border-radius: 5px;">NOTE</div> </div> <p>When two or more channels numbers are entered, the generator will be calibrated for each channel. Interpolation will be accomplished for other channels as required for TX calibration. Channels must be within the range of the selected frequency band.</p>
5	Click OK . Result: A Directions window is displayed.
6	Follow the directions provided.
7	When actions required by directions have been completed, click on Continue to close the Directions window and start the generator calibration process. Result: A status report window is displayed.

Procedure 3-17 *Anritsu* MT8212B Multi-function Test Set CW Generator Calibration
(Continued)

8	Click on OK to close the status report window.
----------	---

Setting and Editing Generator Calibration Data

Generator Calibration Data

Generator calibration data is automatically stored in a generator calibration data file by the LMF when the generator function of a test equipment item is calibrated using the LMF **Util > Calibrate Test Equipment** functions. Stored data values can be edited with this procedure, or new data can be entered manually for a test equipment item generator function which was calibrated without using the LMF.



CAUTION

This procedure *MUST* be used to enter calibration data values for any MT8212B which was *calibrated without using the LMF*. Failure to do this will generate incorrect results for any RSSI testing performed.

Prerequisites

The LMF is logged into a BTS.

Set or Edit Generator Calibration Data

Perform the following to enter new calibration data or edit existing data.

Procedure 3-18 Set or Edit Generator Calibration Data

1	In the LMF menu bar select Util > Edit > Generator Calibration Data . Result: Generator Calibration Data window appears with tabs for each type of generator test equipment calibrated using the LMF (for example, the <i>Anritsu</i> MT8212B).
2	Click on the tab for the generator with data to be edited or entered. Result: The tab moves to the forefront.
3	To edit existing values, click in the data field to be edited and make required changes.
4	To add a new channel and its data: <ol style="list-style-type: none"> 1. Click the Add Row button. 2. Click in the field where data is to be entered; for example, Frequency Band, Channel #, or Power (dB). 3. Enter the desired value.

Continued

Procedure 3-18 Set or Edit Generator Calibration Data (Continued)**NOTE**

For **Frequency Band** fields, select the required frequency band from the dropdown provided. Selections are made available for the BTS which the LMF is logged into.

5 To delete a row, click in the row, and then click the **Delete Row** button.

6 For each tab with changes, click the **Save** button to save the displayed values.

**NOTE**

- Values entered after the **Save** button was used will not be saved.
- If generator calibration values exist for two different channels assigned to one frequency band, the LMF will interpolate for all other channels on this frequency band.
- Entered values will be used by the LMF as soon as they are saved. It is not necessary to log out and log back into the LMF for changes to take effect.

Cable Calibration

Calibrating Cables Overview

The cable calibration function measures the loss (in dB) for the TX and RX cables that are to be used for testing. A CDMA analyzer is used to measure the loss of each cable configuration (TX cable configuration and RX cable configuration). The cable calibration consists of the following:

- **Measuring the loss of a short cable** – This is required to compensate for any measurement error of the analyzer. The short cable (used only for the calibration process) is used in series with both the TX and RX cable configuration when measuring. The measured loss of the short cable is deducted from the measured loss of the TX and RX cable configuration to determine the actual loss of the TX and RX cable configurations. The result is then adjusted out of both the TX and RX measurements to compensate for the measured loss.
- **Measuring the short cable plus the RX cable configuration loss** – The RX cable configuration normally consists only of a coax cable with type-N connectors that is long enough to reach from the BTS RX port of the test equipment. Refer to [Figure 3-31](#), [Figure 3-32](#), [Figure 3-33](#), or [Figure 3-34](#) for specific cable and connection requirements for each type of communications system analyzer.
- **Measuring the short cable plus the TX cable configuration loss** – The TX cable configuration normally consists of two coax cables with type N connectors and a directional coupler, a load, and an additional attenuator (if required by the specified BTS). The total loss of the path loss of the TX cable configuration must be as required for the BTS (normally 30 or 50 dB). Refer to [Figure 3-31](#), [Figure 3-32](#), [Figure 3-33](#), or [Figure 3-34](#) for specific cable and connection requirements for each type of communications system analyzer.

Cable Calibration Set-up Diagrams

[Figure 3-31](#) and [Figure 3-32](#) show the cable calibration set-up for various supported test sets. The left side of the diagram depicts the location of the input and output connectors of each test equipment item, and the right side details the set up for each test.

Calibrate Test Cabling using Communications System Analyzer

Cable Calibration is used to calibrate both TX and RX test cables.

Prerequisites

Ensure the following prerequisites have been met before proceeding:

- One of the following:
 - LMF computer serial port and test equipment are connected to the GPIB box
 - For MT8212B, the test equipment is connected to the LMF computer serial port
 - For E7495A/B, the LMF computer NIC and the E7495 are connected to the Ethernet hub (*Test Equipment Connection* section)
- Test equipment is turned on and has warmed up for at least 60 minutes.
- Test equipment has been selected/detected in the LMF (Refer to the *Selection Procedures* subsection of the *Test Equipment Selection* section)

Calibrating cables

Refer to [Figure 3-31](#), [Figure 3-32](#), [Figure 3-33](#), or [Figure 3-34](#) and perform the following to calibrate the test cable configurations.

Procedure 3-19 Automatic Cable Calibration

1	<p>From the Util menu, select Cable Calibration.</p> <p>Result: A Cable Calibration window is displayed.</p>
2	<p>Enter the channel number(s) in the Channels box.</p> <div style="margin-top: 10px;">  <div style="background-color: #00b050; color: white; padding: 5px; display: inline-block; margin-left: 10px;">NOTE</div> </div> <p>Multiple channel numbers must be separated with a comma and no space (for example; 200,800). When two or more channel numbers are entered, the cables are calibrated for each channel. Interpolation is accomplished for other channels as required for TX calibration.</p>
3	<p>In the Cable Calibration pick list select one of the following:</p> <ul style="list-style-type: none"> ● TX and RX Cable Cal ● TX Cable Cal ● RX Cable Cal
4	<p>Click OK and follow the direction displayed for each step. A status report window displays the results of the cable calibration.</p>

Figure 3-31 Cable Calibration Test Setup – Agilent 8935

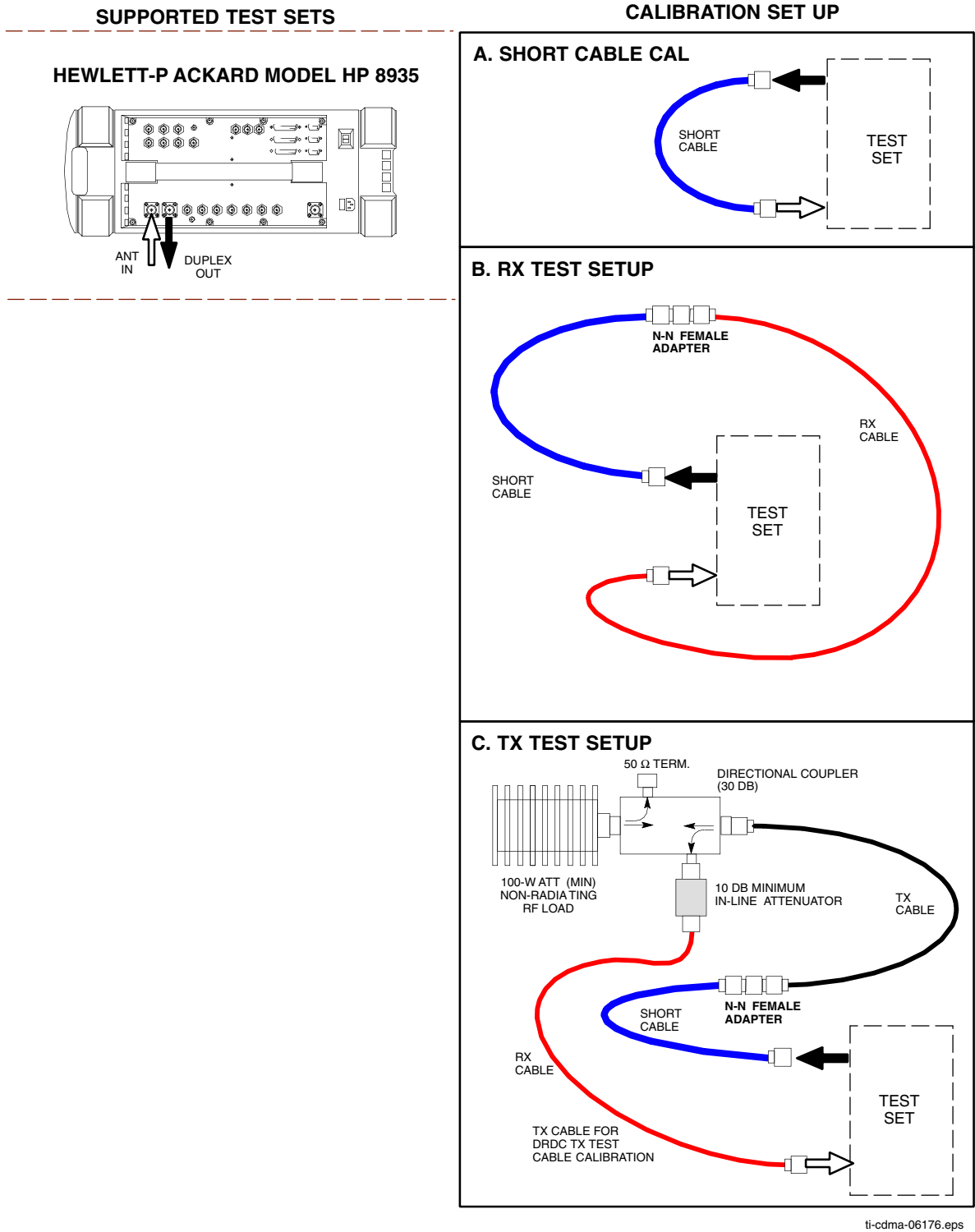
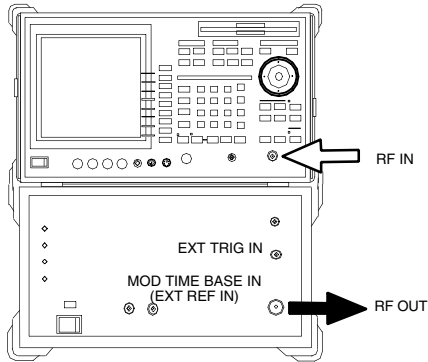

Figure 3-32 Cable Calibration Test Setup – Advantest R3267/R3562,E4406A/E4432B, and Agilent E4432/8935 Series E6380A

SUPPORTED TEST SETS

ADVANTEST R3267 (TOP) AND R3562 (BOTTOM)



NOTE:
SYNTH REF IN on rear signal generator is connected to **10 MHZ OUT** on rear of spectrum analyzer

AGILENT E4432B (TOP) AND E4406A (BOTTOM)

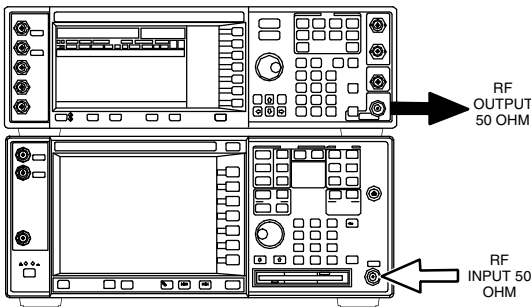

AGILENT E4432B (TOP) AND 8935 SERIES E6380A (BOTTOM)

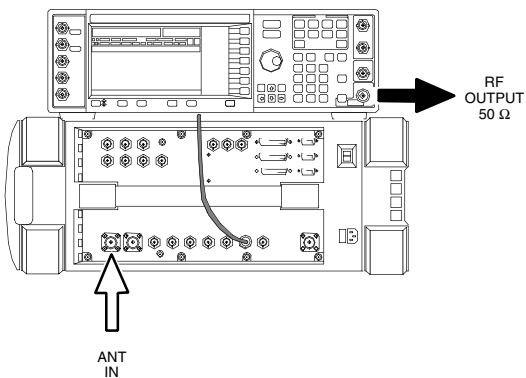

NOTE:
10 MHZ IN on rear of signal generator is connected to **10 MHZ REF OUT** on side of CDMA Base Station Test Set

CALIBRATION SET UP

A. SHORT CABLE CAL

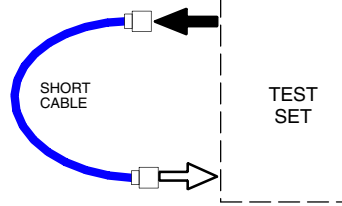

B. RX TEST SETUP

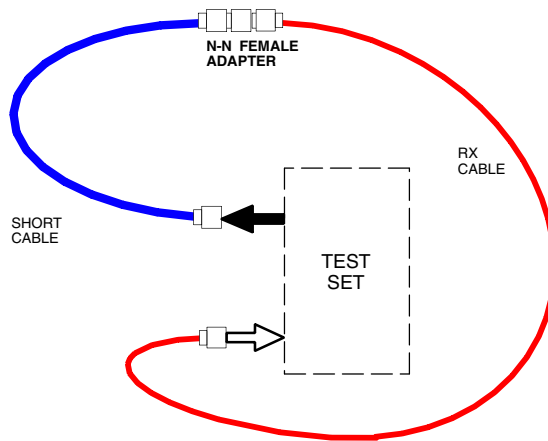

C. TX TEST SETUP

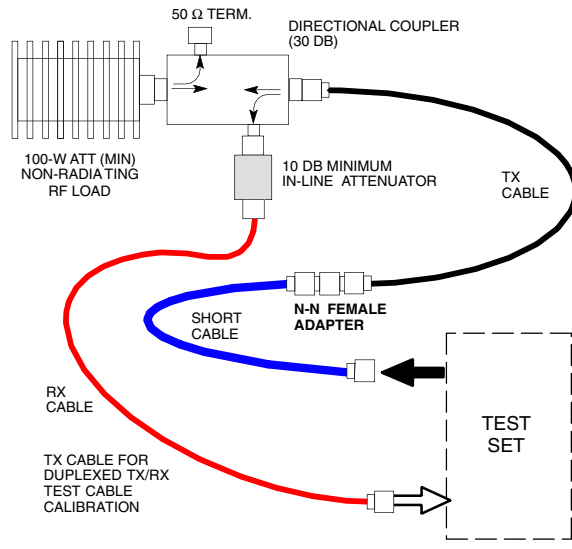

ti-cdma-06177.eps

Figure 3-33 Cable Calibration Test Setup – Agilent E7495A and E7495B

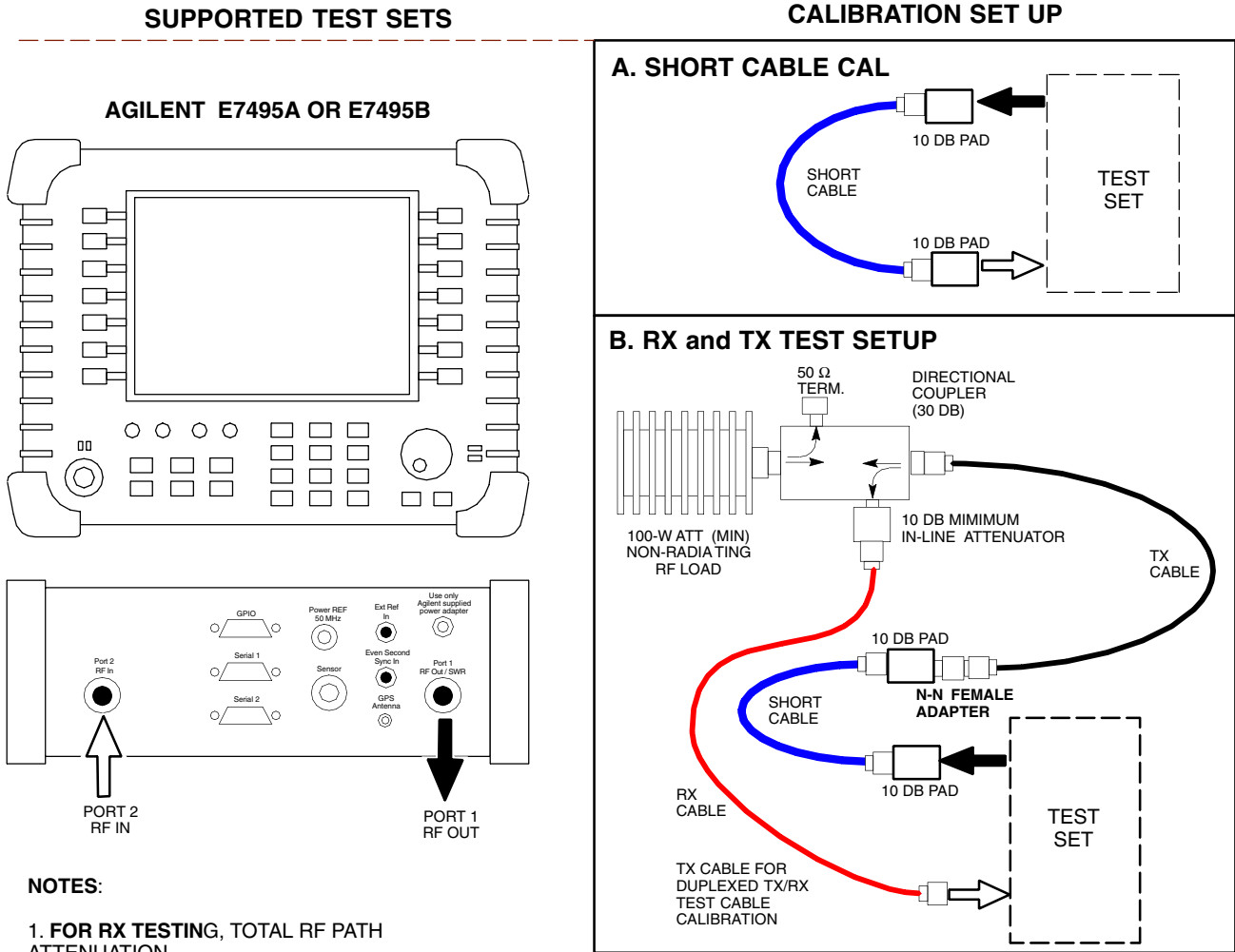

NOTES:

1. **FOR RX TESTING**, TOTAL RF PATH ATTENUATION (CABLES+COUPLERS+ATTENUATORS) MUST BE WITHIN THE VALUES SPECIFIED BELOW FOR EACH TYPE OF TEST SET:

E7495A: 25 TO 32 dB

E7495B: 10 TO 100 dB

2. **WHEN USING THE E7495A, TX TESTS** REQUIRE A MINIMUM OF 30 DB ATTENUATION PLUS THE CABLE LOSSES.

ti-cdma-06178.eps

Figure 3-34 Cable Calibration Test Setup – Anritsu MT8212B

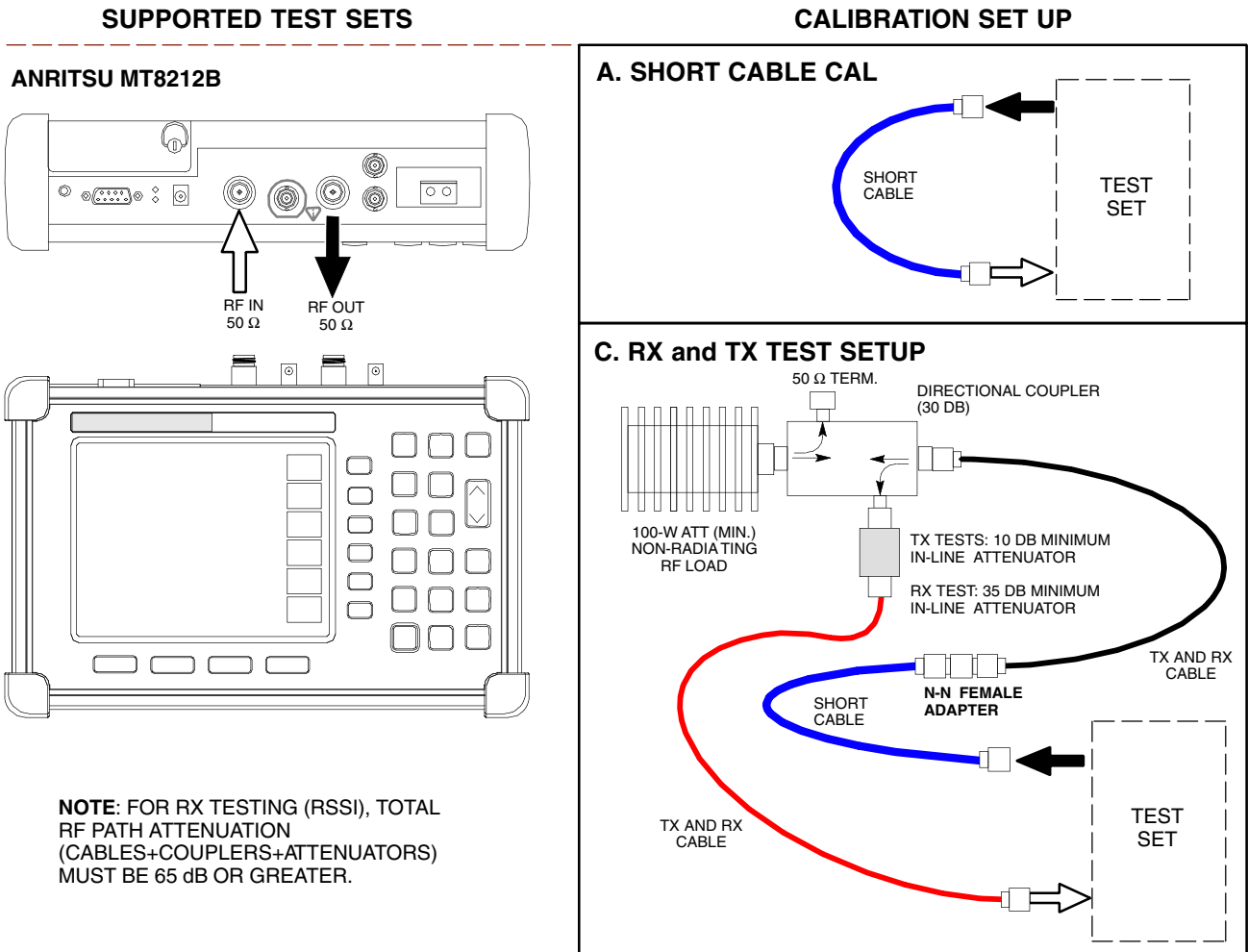

ti-cdma-06208.eps

Calibrate Test Cabling Using Signal Generator & Spectrum Analyzer

Manual cable calibration can be performed by following [Procedure 3-20](#) to calibrate the TX/*duplexed* RX cables using a signal generator and spectrum analyzer. Refer to [Figure 3-35](#), if required. Follow [Procedure 3-21](#) to calibrate the *non*-duplexed RX cables using the signal generator and spectrum analyzer. Refer to [Figure 3-36](#), if required.

TX and Duplexed RX Cable Calibration

Procedure 3-20 Calibrating TX and Duplexed RX Cables Using Signal Generator and Spectrum Analyzer

1	Connect a short test cable between the spectrum analyzer and the signal generator.
2	Set signal generator to 0 dBm at the customer frequency.
3	Use a spectrum analyzer to measure signal generator output (see Figure 3-35 A) and record the value.
4	Connect the spectrum analyzer's short cable to Figure 3-35 point B , (as shown in the lower right portion of the diagram) to measure cable output at customer frequency. Record the value at point B,
5	Calibration factor = A - B. Example: Cal = -1 dBm - (-53.5 dBm) = 52.5 dB



NOTE

The short cable is used for calibration only. It is part of the final test setup. After calibration is completed, rearrange any cables. Use the equipment setup, as is, to ensure test procedures use the correct calibration factor.

Figure 3-35 TX and Duplexed RX Cable Calibration

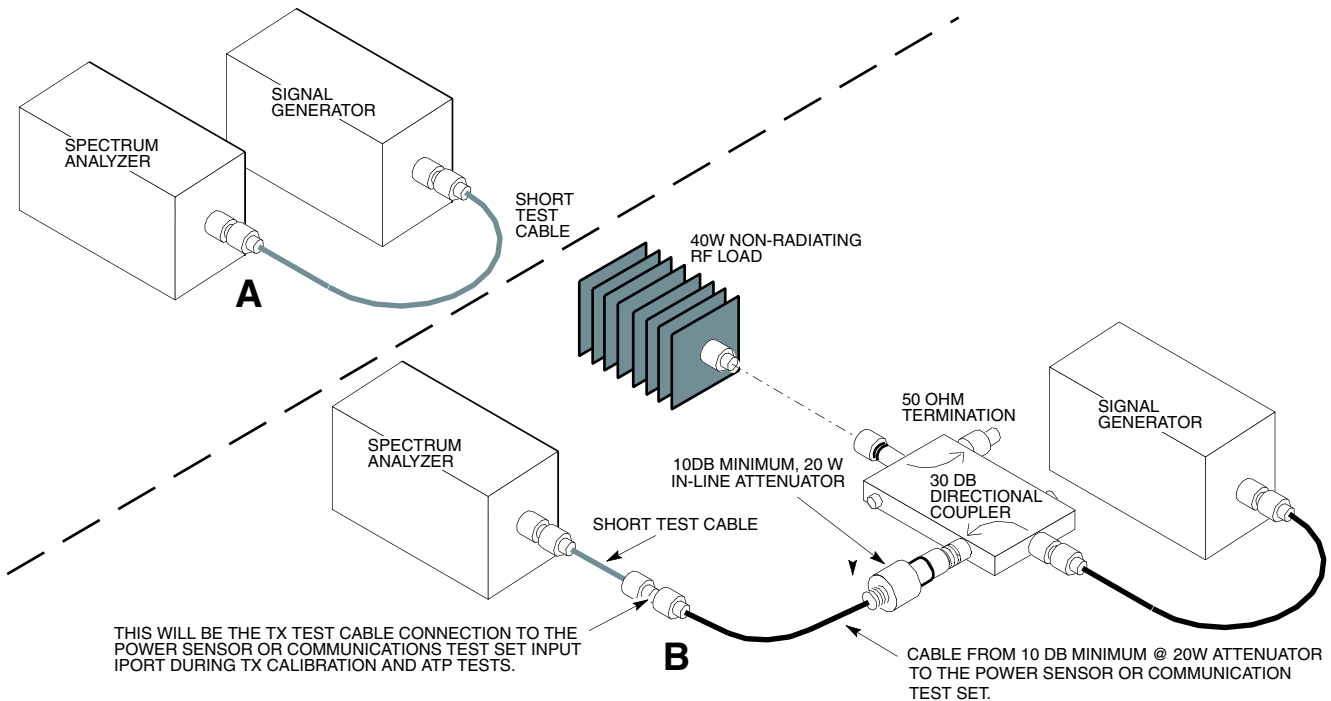

ti-cdma-00145.eps

Non-duplexed RX Cable Calibration

Procedure 3-21 Calibrating RX Cables Using a Signal Generator and Spectrum Analyzer

1	Connect a short test cable to the spectrum analyzer and connect the other end to the Signal Generator.
2	Set signal generator to -10 dBm at the customer's RX frequency.
3	Use spectrum analyzer to measure signal generator output (see Figure 3-36, A) and record the value for A.
4	Connect the test setup, as shown in the lower portion of the diagram to measure the output at the customer's RX frequency. Record the value at Figure 3-36, point B .
5	Calibration factor = A - B. <i>Example:</i> Cal = -12 dBm - (-14 dBm) = 2 dBm
6	<div style="display: flex; align-items: center;">  <div style="background-color: #00b050; color: white; padding: 5px 15px; font-weight: bold; font-size: 1.2em;">NOTE</div> </div> <p>The short cable is used for <i>calibration only</i>. It is <i>not</i> part of the final test setup. After calibration is completed, <i>do not</i> rearrange any cables. Use the equipment setup as is to ensure test procedures use the correct calibration factor.</p>

Figure 3-36 Non-Duplex RX Cable Calibration



Setting Cable Loss Values

Cable loss values for the TX and RX test cable configurations are normally set by accomplishing cable calibration using the applicable test equipment. The resulting values are stored in the cable loss files. The cable loss values can also be set/changed manually.

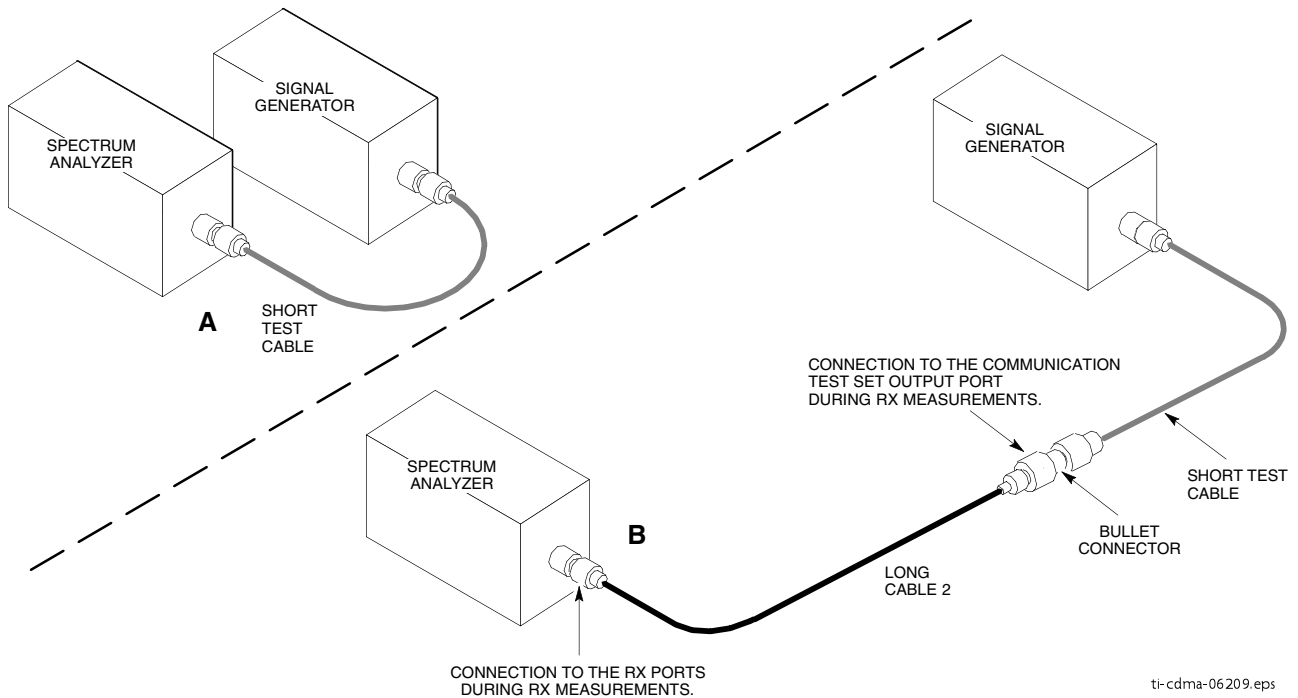

CAUTION

If cable calibration was performed without using the LMF, cable loss values *must* be manually entered in the LMF database. Failure to do this will result in inaccurate UBS calibration and reduced site performance.

Prerequisites

LMF is logged into the UBS

Procedure

Perform the following to set cable loss values.

Procedure 3-22 Setting Cable Loss Values

1	In the LMF menu bar, click on Util > Edit > Cable Loss
2	In the data entry pop-up window, select <i>one</i> of the following: <ul style="list-style-type: none"> • TX Cable Loss • RX Cable Loss
3	To add a new channel number, click on Add Row , and click in Channel# and Loss (dBm) columns and enter the desired values.
4	To edit existing values, click in the data box to be changed and change the value.
5	To delete a row, click on the row and then click on the Delete Row button.
6	To save displayed values, click on the Save button.
7	To exit the window, click on the Dismiss button.
	Values entered/changed after the Save button was used are not saved.
	<div style="display: flex; align-items: center;">  <div style="background-color: #00FFFF; padding: 5px; border: 1px solid black; font-weight: bold; font-size: 1.2em;">NOTE</div> </div> <ul style="list-style-type: none"> • If cable loss values exist for two different channels, the LMF will interpolate for all other channels. • Entered values are used by the LMF as soon as they are saved. Logging out and logging in again is not necessary.

Acceptance Test Procedures

Introduction to ATP

Introduction

General

The Acceptance Test Procedures (ATP) allow Cellular Field Engineers (CFEs) to run automated acceptance tests on all UBS subsystem devices equipped in the NEC using the LMF and the test equipment it supports.

LMF User Interface

This chapter provides procedures for performing acceptance testing from the LMF Graphical User Interface (GUI) environment, the recommended method. The GUI provides the advantages of simplifying the LMF user interface, reducing the potential for mis-keying commands and associated parameters, and speeding up the execution of complex operations involving multiple command strings. If it is believed the LMF command line interface (CLI) will provide additional insight into ATP operation or unexpected test results, refer to LMF CLI Reference.

Test Reports

The CFE can choose to save the results of ATP tests to a report file from which ATP reports are generated for later printing. See the Generating an ATP Report section in this chapter.

Test Equipment Selection

Because test equipment functions during acceptance testing are controlled by the LMF directly, only the test equipment models supported by the LMF can be used.



CAUTION

1. Before using the LMF, read the Developer Release Notes for WinLMF section in the LMF Help function on-line documentation for any applicable information. Pay particular attention to the Caveats/Known Issues part of this appendix.
2. The ATP test is to be performed on out-of-service sectors only.
3. DO NOT substitute test equipment with other models not supported by the LMF.

Test Equipment Set Calibration

Refer to [Test Set Calibration on page 3-55](#), [Cable Calibration on page 3-64](#), and [Appendix D Test Equipment Preparation](#) for detailed interconnection information needed for calibrating equipment, cables, and other test equipment set components.



NOTE

Equipment has been factory-tested for FCC compliance. If license-governing bodies require documentation supporting UBS site compliance with regulations, a full ATP may be necessary. Perform the Reduced ATP only if reports for the specific UBS site are NOT required.

After verifying that the proper operational software was code synced to the UBS, the CFE must perform these procedures (minimal recommendation):

1. Verify the TX/RX paths by performing TX Audit and Receive Signal Strength Indicator (RSSI) tests.
2. Be sure calibration data for all equipped sector-carriers is obtained and loaded on the OMC-R for normal site operation.

Should failures occur while performing the specified tests, refer to the Basic Troubleshooting section of this manual for help in determining the failure point. Once the point of failure has been identified and corrected, refer to the FRU Optimization and ATP Test Matrix in [Appendix B FRU Optimization/ATP Matrix](#) to determine the applicable test that must be performed.

In the unlikely event that the UBS passes these tests but has a forward link problem during normal operation, the CFE should then perform the additional TX tests for troubleshooting: TX spectral mask, TX rho, and TX code domain.

1x EV-DO ATP

Should the UBS Macro be equipped with EV-DO cards/modules, refer to *1x EV-DO System ATP — 68P09283A59* for testing procedures.

Acceptance Test Procedures - TX & RX

Reduced and Full ATP

The full ATP (all the ATP tests) is optional. It is recommended that the reduced ATP be used. The reduced ATP consists of TX Audit and Receive Signal Strength Indicator (RSSI).

TX Audit and RSSI Tests

TX Audit The Audit is a power out test that will pass within +/-2 dB of the expected power. The standard pattern per S-C is 43dBm and the Audit test will pass if the output power is within the limits listed above.

TX Audit Test Procedure Perform the procedure in [Procedure 4-1](#) for TX Audit.

Procedure 4-1 Procedure for TX Audit

1	Set up test equipment for TX acceptance tests per Figure 3-23 through Figure 3-26
2	If it has not already been done, configure the test equipment for TX path audit as in Figure 3-23
3	Click on the devices to be tested.
4	Click Tests > TX > TX Audit
5	Select the appropriate carrier in the Channels/Carrier pick list. Enter the channel number in the Carrier # Channels box.
	<div style="display: flex; align-items: center;">  <div style="background-color: #00b050; color: white; padding: 5px 10px; font-weight: bold; text-align: center;">NOTE</div> </div> <p>To select multiple items, hold down the Shift or CTRL key while making the selections.</p>
6	Click OK . The status report window is displayed and then a Directions pop-up is displayed.
7	Follow the cable connection directions as they are displayed. Test results are displayed in the status report window.

Continued

Procedure 4-1 Procedure for TX Audit (Continued)

8	Click Save Results or Dismiss button.
	<div style="background-color: #00e68c; color: white; padding: 5px; display: inline-block;">NOTE</div>
	If Dismiss is selected, the test results will not be saved.

Figure 4-1 TX Audit Signal



ti-cdma-TX_Audit.eps

Receive Signal Strength Indication Acceptance Test

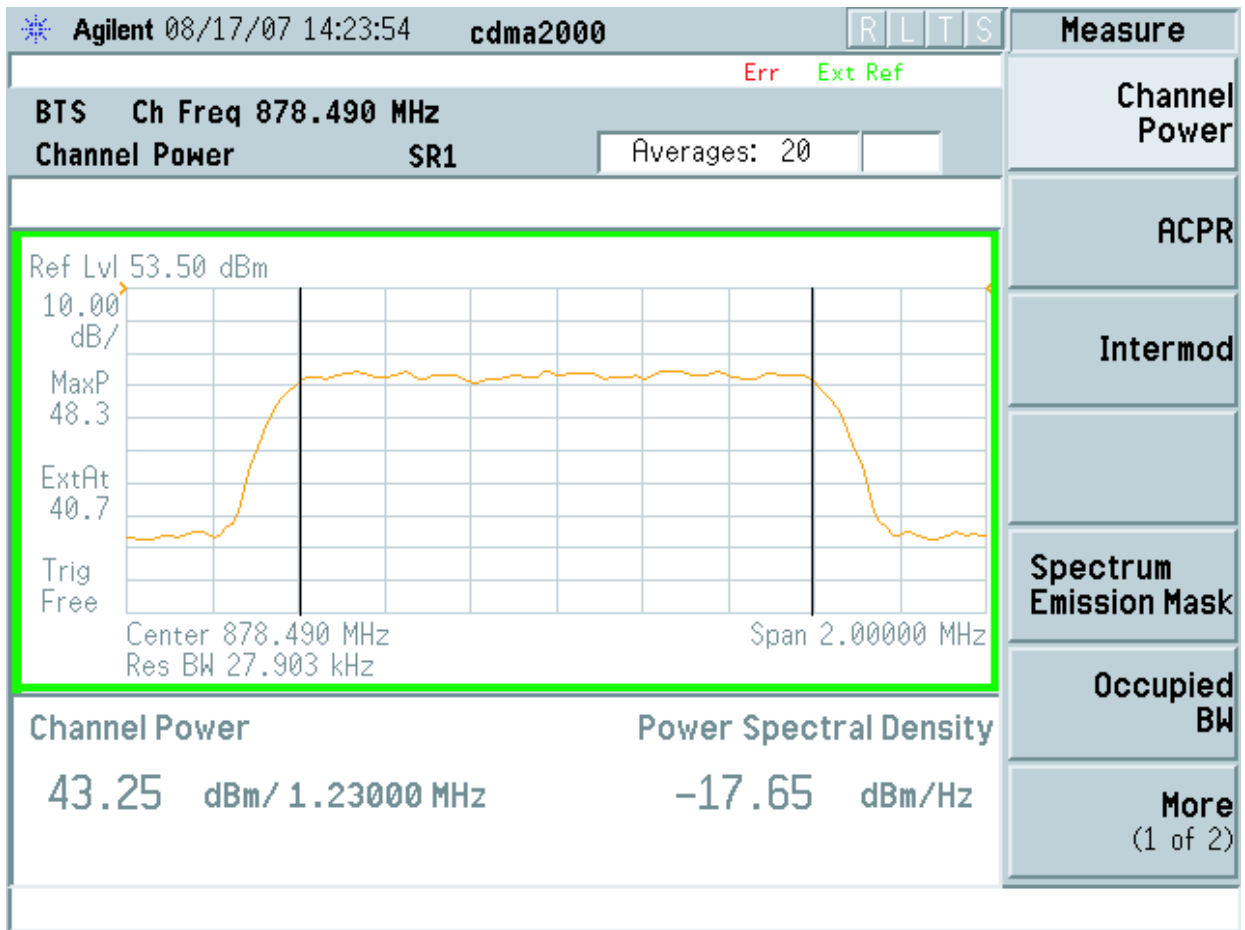
Overview This test verifies Receive Signal Strength Indication (RSSI) for the selected sectors to ensure integrity of the reverse (RX) path, that path losses are within tolerances required for correct receiver operation, and correct installation of the RX path. Testing is performed using the calibrated external test equipment as the signal source. The test equipment is controlled by the LMF during the test. The receive signal generated by the test equipment is injected into the sector RX path to be tested at the applicable UBS main and / or diversity receive ports.

Equipment Operation During Testing The LMF sets the pilot channel power level of the sector for the selected sector to +XX dBm (measured at the TX port of the frame) and enables the sector-carrier on pilot channel only to enable the RX circuitry. The LMF then commands the test equipment to generate the receive signal on the selected carrier at -80 dBm as measured at the UBS RX port

Test Measurements The power level of the received signal is measured by the RFX. The LMF corrects the measured power of the signal using the RX BLO and determines if the corrected signal gain is equal to or greater than the following specified criteria for the band in which the UBS operates:

- 1900 MHz: -80 dBm (-86 dBm or greater)
- 800 MHz: -80 dBm (-86 dBm or greater)



NOTE

The LMF provides -80 dBm signal (default) input to the UBS. The RSSI must be +/-6 dB.

Receive Signal Strength Indicator ATP

Perform the following procedure for RSSI acceptance testing.

Procedure 4-2 Procedure for RSSI Acceptance Testing

1	Set up the test equipment for RX acceptance tests. Reference Figure 3-23 through Figure 3-26 .
2	Select the carrier to be tested.
3	In the LMF window menu bar, click on Tests > RX > RSSI
4	Select the carrier to be tested in the Channels/Carriers pick list which is displayed.

Continued

Procedure 4-2 Procedure for RSSI Acceptance Testing (Continued)

5	Select the RX Branch to be tested from the choices in the drop down list provided (Both, Main, Diversity)
6	Enter the appropriate power level into the Generator amplitude box (default: -80 dBm)
7	Click OK . A status bar will be displayed followed by a Directions pop up window.
8	Follow cable connection directions as they are displayed, and click the Continue button to begin testing. Progress will be indicated in the status bar.
9	When the test is completed, click Save Results or Dismiss button, as required, in the Status Report window.



NOTE

If **Dismiss** is selected, then the test results will not be saved.

Automated ATP

This section covers the general requirements and procedures for conducting both automated ATP testing and performing individual ATP tests.

Automated ATP Test Options

Acceptance tests can be run individually or as one of the following automated groups:

- All TX: TX tests verify the performance of the UBS transmit line up.
- All RX: RX tests verify the performance of the UBS receiver line up.
- All TX/RX: Executes all the TX and RX tests.
- Full Optimization: Executes the TX calibration, downloads the BLO, and executes the TX audit before running all of the TX and RX tests.



NOTE

The Full Optimization test can be run if TX path calibration is needed before the TX and RX acceptance tests are run.

The **STOP** button can be used to stop the testing process.

The LMF is optimized to perform the tests as quickly as possible when selecting the "perform all" menu options. It is recommended that the user select this option on a per sector/carrier option where possible to save time.

Required Test Equipment

The following test equipment is required:

- LMF
- Power Meter
- Communications System Analyzer



WARNING

- *Before connecting any test equipment directly to any UBS TX OUT connector, verify that there are no CDMA channels keyed.*
- *At active sites, have the OMC-R operator place the carrier assigned to the UBS under test OOS. Failure to do so can result in serious personal injury and/or equipment damage.*



NOTE

Test equipment must be calibrated and the cables re-calibrated before using them to perform acceptance tests.

ATP Test Prerequisites

Before attempting to run any ATP tests, ensure the following have been completed:

- LMF is logged into the UBS.
- All FRUs on the LMF screen are INS (Green)
- Test cables are calibrated
- Test equipment is connected for ATP tests (refer to ATP Test Setup illustrations in the Test Equipment Set Up section of [Appendix E Optimization and Calibration Procedures](#))
- Test equipment has been selected in the LMF, warmed up 60 minutes and calibrated
- All required Ethernet test equipment connections are made
- UBS transmit connectors are terminated with either non-radiating loads or connected to the test equipment as specified in [Figure 3-27](#) through [Figure 3-30](#).



WARNING

Before a FER test is run, be sure that the following is done:

All transmitter connectors are properly terminated. Terminations should be 50-Ohms, 200 W. Failure to observe these warnings may result in bodily injury or equipment damage.

Procedure 4-3 Setup Test Equipment — TX Output Verify/Control Tests

1	If it has not already been done, interface the LMF computer to the UBS.
2	If it has not already been done, refer to Procedure 3-3 to start a GUI LMF session and log into the UBS.
3	If it has not already been done, refer to Figure 3-23 , Figure 3-24 , Figure 3-25 , or Figure 3-26 as applicable, for the test equipment and antennas being used, to connect test equipment for acceptance testing.



NOTE

LMF-based measurements factor in TX cable loss between the UBS and the test equipment.

Antenna Connectors

All acceptance testing requires test equipment connections to the UBS antenna TX or RX connectors. Refer to the ATP Test Setup illustrations in the Test Equipment Set Up section of [Appendix E Optimization and Calibration Procedures](#) for specific connection requirements

Recommended Tests



The recommended tests are TX Audit and Receive Signal Strength Indicator (RSSI) to confirm the physical assembly of the frame and that all the cables TX, RX, Digital etc are correctly connected. The rest of the tests are supported, optional, or for troubleshooting purposes.

TX/RX ATP Test Procedure

Follow the procedure in [Procedure 4-4](#) to perform the All TX/RX ATP test.

Procedure 4-4 All TX/RX ATP Test Procedure

Continued

1	Set up the test equipment for abbreviated tests per Procedure 4-3
2	<p>Select the device(s) to be tested.</p> <div style="display: flex; align-items: center;">  <div style="background-color: #00FFFF; padding: 5px; font-weight: bold; margin-right: 10px;">NOTE</div> </div> <p>To select multiple items, hold down the Shift or Ctrl key while making the selections.</p> <p>For all TX tests except Code domain, a SectorCarrier must be selected. For code domain select the modem and carrier. For RX test — FER select the modem and SectorCarrier. For RX test — RSSI select SectorCarrier only.</p>
3	Click on Tests in the UBS Menu bar, and select All TX/RX ATP.. from pull-down menu.
4	<p>Select the appropriate SectorCarrier (carrier-bts#-sector#-carrier#) displayed in the Channels/Carrier pick list.</p> <div style="display: flex; align-items: center;">  <div style="background-color: #00FFFF; padding: 5px; font-weight: bold; margin-right: 10px;">NOTE</div> </div> <p>Since the UBS supports OMNI configurations only, sector# will always be 1.</p>
5	<p>Verify that the correct channel number for the selected SectorCarrier is shown in the Carrier # Channels box. If not obtain the latest bts-#.necf files.</p> <div style="display: flex; align-items: center;">  <div style="background-color: #00FFFF; padding: 5px; font-weight: bold; margin-right: 10px;">NOTE</div> </div> <p>If necessary, the correct number may be manually entered into the Carrier # Channels box.</p>
6	<p>Select the appropriate RX Branch (Both, Main, or Diversity) from the drop-down menu.</p> <p>In the Rate Set box, select the appropriate data rate (1=9600, 2= 14400, 3 = 9600 1X) from the drop-down list.</p>
7	In the Test Pattern box, select the Standard test pattern from the drop down list in the Bay Level Offset Calibration section.
8	Click on the OK button. The status report window and a Directions pop-up are displayed.
9	Follow the cable connection directions as they are displayed. The test results are displayed in the status report window.

Continued

Procedure 4-4 All TX/RX ATP Test Procedure (Continued)

10 Click on **Save Results** or **Dismiss**.



NOTE

If **Dismiss** is used, the test results **will not** be saved in the test report file.

Figure 4-2 TX Test Options Screen

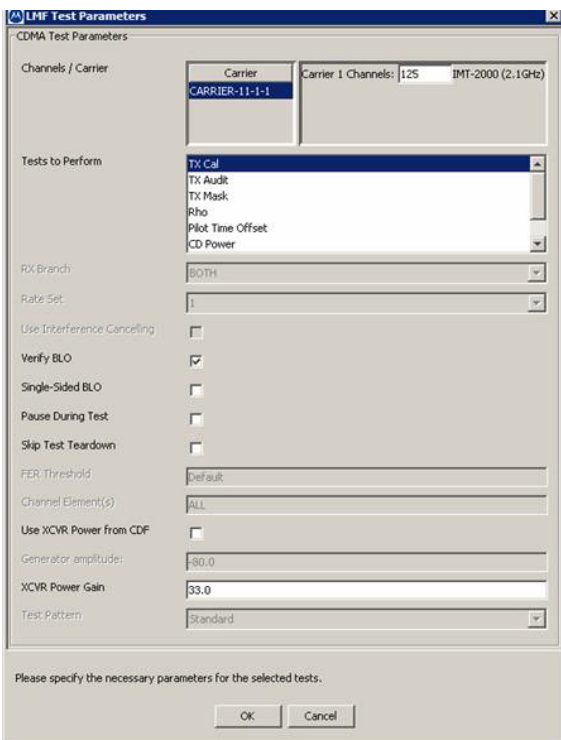

enter_filename_here_and_move_per_step_8



Perform the procedure in [Procedure 4-5](#) for all-inclusive transmit test.

Procedure 4-5 All TX ATP Test

1 Set up the test equipment for TX acceptance tests per [Procedure 4-3](#)

Continued

Procedure 4-5 All TX ATP Test (Continued)

2	<p>On LMF, select devices to be tested.</p> <div style="display: flex; align-items: center;">  <div style="background-color: #00FFFF; padding: 5px; border: 1px solid black; font-weight: bold; font-size: 1.2em;">NOTE</div> </div> <p>To select multiple items, hold down the Shift or Ctrl key while making the selections.</p>
3	<p>Click on Tests in the BTS Menu bar, and select All TX ATP... from pull-down menu.</p>
4	<p>Select the appropriate carrier (HDModem) from those displayed in the Channels/Carrier pick list.</p>
5	<p>Verify that the correct channel number for the selected carrier is shown in the Carrier # Channels box. If not obtain the latest bts-#.necf files.</p> <div style="display: flex; align-items: center;">  <div style="background-color: #00FFFF; padding: 5px; border: 1px solid black; font-weight: bold; font-size: 1.2em;">NOTE</div> </div> <p>If necessary, the correct number may be manually entered into the Carrier # Channels box.</p>
6	<p>In the Test Pattern box, select the Standard test pattern from the drop down list in the Bay Level Offset Calibration section. Other selections are available for TX Mask only.</p>
7	<p>Click OK to display a status bar followed by a Directions pop-up window.</p>
8	<p>Follow the cable connection directions as they are displayed, and click the Continue button to begin testing. As the ATP process is completed, results will be displayed in a status report window.</p>
9	<p>Click the Save Results or Dismiss button.</p> <div style="display: flex; align-items: center;">  <div style="background-color: #00FFFF; padding: 5px; border: 1px solid black; font-weight: bold; font-size: 1.2em;">NOTE</div> </div> <p>If Dismiss is used, the test results will not be saved in the test report file.</p>