

1X SC™ 4812ET Lite BTS Optimization/ATP

Software Release 2.16.0.x and CDMA LMF Build 2.16.x.x

800 MHz and 1.9 GHz

CDMA

Notice

While reasonable efforts have been made to assure the accuracy of this document, Motorola, Inc. assumes no liability resulting from any inaccuracies or omissions in this document, or from use of the information obtained herein. The information in this document has been carefully checked and is believed to be entirely reliable. However, no responsibility is assumed for inaccuracies or omissions. Motorola, Inc. reserves the right to make changes to any products described herein and reserves the right to revise this document and to make changes from time to time in content hereof with no obligation to notify any person of revisions or changes. Motorola, Inc. does not assume any liability arising out of the application or use of any product, software, or circuit described herein; neither does it convey license under its patent rights or the rights of others.

It is possible that this publication may contain references to, or information about Motorola products (machines and programs), programming, or services that are not announced in your country. Such references or information must not be construed to mean that Motorola intends to announce such Motorola products, programming, or services in your country.

Copyrights

This instruction manual, and the Motorola products described in this instruction manual may be, include or describe copyrighted Motorola material, such as computer programs stored in semiconductor memories or other media. Laws in the United States and other countries preserve for Motorola certain exclusive rights for copyrighted material, including the exclusive right to copy, reproduce in any form, distribute and make derivative works of the copyrighted material. Accordingly, any copyrighted Motorola material contained herein or in the Motorola products described in this instruction manual may not be copied, reproduced, distributed, merged or modified in any manner without the express written permission of Motorola. Furthermore, the purchase of Motorola products shall not be deemed to grant either directly or by implication, estoppel, or otherwise, any license under the copyrights, patents or patent applications of Motorola, as arises by operation of law in the sale of a product.

Usage and Disclosure Restrictions

License Agreement

The software described in this document is the property of Motorola, Inc. It is furnished by express license agreement only and may be used only in accordance with the terms of such an agreement.

Copyrighted Materials

Software and documentation are copyrighted materials. Making unauthorized copies is prohibited by law. No part of the software or documentation may be reproduced, transmitted, transcribed, stored in a retrieval system, or translated into any language or computer language, in any form or by any means, without prior written permission of Motorola, Inc.

High Risk Activities

Components, units, or third-party products used in the product described herein are NOT fault-tolerant and are NOT designed, manufactured, or intended for use as on-line control equipment in the following hazardous environments requiring fail-safe controls: the operation of Nuclear Facilities, Aircraft Navigation or Aircraft Communication Systems, Air Traffic Control, Life Support, or Weapons Systems ("High Risk Activities"). Motorola and its supplier(s) specifically disclaim any expressed or implied warranty of fitness for such High Risk Activities.

Trademarks



and Motorola are registered trademarks of Motorola, Inc.

Product and service names profiled herein are trademarks of Motorola, Inc. Other manufacturers' products or services profiled herein may be referred to by trademarks of their respective companies.

Copyright

© Copyright 2001 Motorola, Inc.
All Rights Reserved



Printed on
Recyclable Paper

REV012501

SPECIFICATIONS SUBJECT TO CHANGE WITHOUT NOTICE

FOA



Table of Contents

1X SC™ 4812ET Lite BTS Optimization/ATP

Software Release 2.16.0.x and CDMA LMF Build 2.16.x.x

List of Figures	iv
List of Tables	vii
Foreword	xii
FCC Requirements	xv
General Safety	xviii
Revision History	xx
Patent Notification	xxi

Chapter 1: Introduction

Optimization Manual Scope and Layout	1-1
Purpose of the Optimization	1-3
When to Optimize	1-4
Required Test Equipment and Software	1-5
Required Documents and Related Publications	1-12
Terms and Abbreviations	1-13
BTS Equipment Identification	1-15
Cabinet Identification	1-17
Internal Assembly Location and Identification	1-18
BTS Sector Configurations	1-26

Chapter 2: Preliminary Operations

Preliminary Operations: Overview	2-1
Ethernet LAN	2-3
Initial Power Up	2-4

Chapter 3: Optimization/Calibration

Optimization/Calibration – Introduction	3-1
Preparing the LMF	3-4
Span Lines – Interface and Isolation	3-14
LMF to BTS Connection	3-20
Using CDMA LMF	3-21

Table of Contents – continued

Pinging the Processors	3-28
Download the BTS	3-31
CSM System Time – GPS & LFR/HSO Verification	3-37
Test Equipment Setup	3-47
Test Set Calibration	3-55
Bay Level Offset Calibration	3-64
RFDS Setup and Calibration	3-76
Alarms Testing	3-85

Chapter 4: Automated Acceptance Test Procedure (ATP)

Automated Acceptance Test Procedure – Introduction	4-1
Acceptance Tests – Test Set Up	4-3
Abbreviated (All-inclusive) Acceptance Tests	4-4
Individual Acceptance Tests–Introduction	4-7
TX Spectral Purity Transmit Mask Acceptance Test	4-9
TX Waveform Quality (Rho) Acceptance Test	4-12
TX Pilot Time Offset Acceptance Test	4-13
TX Code Domain Power/Noise Floor Acceptance Test	4-15
RX FER Acceptance Test	4-18
Generating an ATP Report	4-20

Chapter 5: Leaving the Site

Updating Calibration Data Files	5-1
Prepare to Leave the Site	5-3

Chapter 6: Basic Troubleshooting

Basic Troubleshooting Overview	6-1
Troubleshooting: Installation	6-2
Troubleshooting: Download	6-7
Troubleshooting: Calibration	6-10
Basic Troubleshooting – RF Path Fault Isolation	6-12
Troubleshooting: Transmit ATP	6-15
Troubleshooting: Receive ATP	6-17
Troubleshooting: CSM Checklist	6-18
SCCP Backplane Troubleshooting	6-20
RFDS – Fault Isolation	6-26
Module Front Panel LED Indicators and Connectors	6-28
Basic Troubleshooting – Span Control Link	6-35

Table of Contents – continued

Appendix A: Data Sheets

Optimization (Pre–ATP) Data Sheets	A-1
Site Serial Number Check List	A-13

Appendix B: FRU Optimization/ATP Test Matrix

FRU Optimization/ATP Test Matrix	B-1
--	-----

Appendix C: BBX Gain Set Point vs. BTS Output Considerations

BBX2 Gain Set Point vs. BTS Output Considerations	C-1
---	-----

Appendix D: CDMA Operating Frequency Information

CDMA Operating Frequency Programming Information – North American PCS Bands . D-1	
--	--

Appendix E: PN Offset/I & Q Offset Register Programming Information

PN Offset Programming Information	E-1
---	-----

Appendix F: Test Equipment Preparation

Test Equipment Preparation	F-1
Manual Cable Calibration	F-14

Appendix G: Download ROM Code

Downloading ROM Code with the LMF	G-1
---	-----

Appendix H: In–Service Calibration

Introduction	H-1
Power Delta Calibration	H-3
In–Service Calibration	H-18

Index



List of Figures

1X SC™ 4812ET Lite BTS Optimization/ATP

Software Release 2.16.0.x and CDMA LMF Build 2.16.x.x

Figure 1-1: SC4812ET Lite Logical BTS Span Cabling	1-16
Figure 1-2: SC4812ET Lite BTS Frame	1-17
Figure 1-3: Internal Assemblies and FRUs (Cabinet doors not shown for clarity)	1-18
Figure 1-4: 50–Pair Punchblock	1-20
Figure 1-5: SCCP Shelf, IS–95A/B and 1X Devices	1-22
Figure 1-6: RF Interface Panel, DRDCs Installed	1-23
Figure 1-7: RF Interface Panel, TRDCs Installed	1-24
Figure 1-8: RFDS, DRDC, and TRDC Details	1-25
Figure 1-9: SC4812ET Lite LPA Configuration with Bandpass Filters (Starter Frame Mapping Only)	1-27
Figure 2-1: Backplane DIP Switch Settings	2-2
Figure 2-2: External Ethernet LAN Connectors	2-3
Figure 2-3: Frame Power Subassemblies, North American and International Cabinets	2-5
Figure 2-4: ACLC Circuit Breaker Panel – North American	2-6
Figure 2-5: ACLC Circuit Breaker Panel – International	2-6
Figure 2-6: DC PDA	2-7
Figure 2-7: ACLC Voltage Measurement Probe Points – North American	2-11
Figure 2-8: ACLC Voltage Measurement Probe Points – International	2-12
Figure 2-9: Meter Alarm Panel (MAP)	2-13
Figure 2-10: Heat Exchanger Blower Assembly and Circuit Breakers	2-18
Figure 3-1: CDMA LMF Folder Structure	3-9
Figure 3-2: BTS Folder Name Syntax Example	3-10
Figure 3-3: CAL File Name Syntax Example	3-10
Figure 3-4: CDF Name Syntax Example	3-10
Figure 3-5: Code Load File Name Syntax Example	3-12
Figure 3-6: DDS File Name Syntax Example	3-13
Figure 3-7: Disconnecting Span Lines	3-14
Figure 3-8: Rear and Front View of CSU Shelf	3-16

List of Figures – continued

Figure 3-9: 50–Pair Punchblock	3-17
Figure 3-10: LMF Connection Detail	3-20
Figure 3-11: CDMA LMF Computer Common MMI Connections	3-27
Figure 3-12: BTS Ethernet LAN Interconnect Diagram	3-28
Figure 3-13: CSM MMI Terminal Connection	3-40
Figure 3-14: Cable Calibration Test Setup	3-50
Figure 3-15: TX Calibration Test Setup (CyberTest and HP 8935)	3-51
Figure 3-16: TX Calibration Test Setup HP 8921A and Advantest	3-52
Figure 3-17: Optimization/ATP Test Setup Calibration (CyberTest, HP 8935 and Advantest)	3-53
Figure 3-18: Optimization/ATP Test Setup HP 8921A	3-54
Figure 3-19: Calibrating Test Equipment Setup for TX Cable Calibration (Using Signal Generator and Spectrum Analyzer)	3-60
Figure 3-20: Calibrating Test Equipment Setup for RX ATP Test (Using Signal Generator and Spectrum Analyzer)	3-61
Figure 3-21: Battery Over–Temperature Sensor	3-92
Figure 3-22: MAP Connector J8 (Rear of MAP)	3-93
Figure 4-1: TX Mask Verification Spectrum Analyzer Display	4-11
Figure 4-2: Code Domain Analyzer CD Power/Noise Floor Display Examples	4-17
Figure 6-1: TX Output Fault Isolation Flowchart	6-14
Figure 6-2: CSM Front Panel Indicators & Monitor Ports	6-29
Figure 6-3: GLI2 Front Panel Operating Indicators	6-32
Figure 6-4: MCC24 Front Panel LEDs and LED Indicators	6-34
Figure 6-5: MGLI/GLI Board MMI Connection Detail	6-36
Figure D-1: North America PCS Frequency Spectrum (CDMA Allocation) . . .	D-1
Figure D-2: North American Cellular Telephone System Frequency Spectrum (CDMA Allocation).	D-4
Figure F-1: HP8921A/600 Cables Connection for 10 MHz Signal and GPIB without Rubidium Reference	F-2
Figure F-2: HP8921A Cables Connection for 10 MHz Signal and GPIB with Rubidium Reference	F-4
Figure F-3: Cable Connections for Test Set without 10 MHz Rubidium Reference	F-7
Figure F-4: Cable Connections for Test Set with 10 MHz Rubidium Reference	F-8
Figure F-5: Power Meter Detail	F-10
Figure F-6: Gigatronics 8542C Power Meter Detail	F-13
Figure F-7: Cable Calibration Using HP8921 with PCS Interface	F-17
Figure F-8: Cable Calibration Using Advantest R3465	F-20
Figure H-1: Delta Calibration Setup – Agilent E4432B to HP437	H-5

List of Figures – continued

Figure H-2: Delta Calibration Setup – Agilent E4432B to Agilent E4406A . . .	H-5
Figure H-3: Delta Calibration Setup – Advantest R3562 to HP437	H-8
Figure H-4: Delta Calibration Setup – Advantest R3562 to R3267	H-8
Figure H-5: Delta Calibration Setup – E6380A to HP437	H-10
Figure H-6: Delta Calibration Setup – E6380A to E6380A	H-11
Figure H-7: Delta Calibration Setup – HP8921A to HP437	H-13
Figure H-8: Delta Calibration Setup – HP8921A to HP8921A	H-14
Figure H-9: Delta Calibration Setup – R3561L to HP437	H-17
Figure H-10: Delta Calibration Setup – R3561L to R3465	H-17
Figure H-11: Optimization/ATP Test Setup Using Directional Coupler – Agilent Test Equipment	H-20
Figure H-12: Optimization/ATP Test Setup Using Directional Coupler – Advantest R3267/R3562 Test Equipment	H-21
Figure H-13: Optimization/ATP Test Setup Using RFDS – Agilent Test Equipment	H-22
Figure H-14: Optimization/ATP Test Setup Using RFDS – Advantest R3267/R3562 Test Equipment	H-23



List of Tables

1X SC™ 4812ET Lite BTS Optimization/ATP

Software Release 2.16.0.x and CDMA LMF Build 2.16.x.x

Table 1-1: Non-Standard Terms and Abbreviations	1-13
Table 1-2: SCCP Cage Module Device ID Numbers (Top Shelf)	1-16
Table 1-3: SCCP Cage Module Device ID Numbers (Bottom Shelf)	1-16
Table 1-4: BTS Sector Configuration	1-26
Table 1-5: Sector Configurations	1-27
Table 2-1: Initial Installation of Boards/Modules	2-1
Table 2-2: Initial Inspection and Setup	2-4
Table 2-3: DC Power System Pre-Power Application Test	2-7
Table 2-4: AC Voltage Measurements	2-9
Table 2-5: Applying Internal AC Power	2-12
Table 2-6: DC Power Application and Tests	2-14
Table 2-7: Battery Charge Test (Connected Batteries)	2-15
Table 2-8: Battery Discharge Test	2-16
Table 2-9: Power Removal	2-17
Table 3-1: CD ROM Installation	3-4
Table 3-2: Copying CBSC CDF Files to the LMF Computer	3-5
Table 3-3: Create HyperTerminal Connection	3-7
Table 3-4: T1/E1 Span Isolation	3-15
Table 3-5: Punchdown Location for 50-Pair Punch Block	3-18
Table 3-6: Connect the LMF to the BTS	3-20
Table 3-7: BTS GUI Login Procedure	3-23
Table 3-8: BTS CLI Login Procedure	3-24
Table 3-9: BTS GUI Logout Procedure	3-25
Table 3-10: BTS CLI Logout Procedure	3-26
Table 3-11: Establishing MMI Communication	3-26
Table 3-12: Pinging the Processors	3-29
Table 3-13: Verify GLI ROM Code Loads	3-32
Table 3-14: Download and Enable MGLI and GLI Devices	3-33
Table 3-15: Download RAM Code and Data to Non-GLI Devices	3-34

List of Tables – continued

Table 3-16: Select CSM Clock Source	3-34
Table 3-17: Enable CSMs	3-35
Table 3-18: Enable MCCs	3-36
Table 3-19: Test Equipment Setup (GPS & LFR/HSO Verification)	3-39
Table 3-20: GPS Initialization/Verification	3-41
Table 3-21: LORAN–C Initialization/Verification	3-45
Table 3-22: Test Equipment Setup	3-48
Table 3-23: Selecting Test Equipment Manually in a Serial Connection Tab ..	3-56
Table 3-24: Selecting Test Equipment Using Auto-Detect	3-57
Table 3-25: Test Equipment Calibration	3-58
Table 3-26: Cable Calibration	3-59
Table 3-27: Calibrating TX Cables Using Signal Generator and Spectrum Analyzer	3-60
Table 3-28: Calibrating RX Cables Using a Signal Generator and Spectrum Analyzer	3-61
Table 3-29: Setting Cable Loss Values	3-62
Table 3-30: Setting TX Coupler Loss Values	3-63
Table 3-31: BLO BTS.cal file Array Branch Assignments	3-66
Table 3-32: SC4812ET Lite BTS.cal File Array (Per Sector)	3-67
Table 3-33: Set Up Test Equipment (RF Path Calibration)	3-68
Table 3-34: All Cal/Audit Path Calibration	3-71
Table 3-35: TX Calibration Test	3-71
Table 3-36: Download BLO	3-73
Table 3-37: TX Path Audit	3-74
Table 3-38: Create CAL File	3-75
Table 3-39: RFDS Parameter Settings	3-77
Table 3-40: Definition of Parameters	3-78
Table 3-41: Valid NAM Field Ranges	3-79
Table 3-42: Set Antenna Map Data	3-80
Table 3-43: Set RFDS Configuration Data	3-81
Table 3-44: RFDS TSIC Calibration Channel Frequencies	3-82
Table 3-45: RFDS Calibration	3-83
Table 3-46: Program NAM Procedure	3-84
Table 3-47: Alarm Testing Preparation	3-86
Table 3-48: Heat Exchanger Alarm	3-86
Table 3-49: ACLC and Power Entry Door Alarm	3-86
Table 3-50: AC Fail Alarm	3-87

List of Tables – continued

Table 3-51: Minor Alarm	3-87
Table 3-52: Single Rectifier Fail or Minor Alarm, Single–Carrier System	3-88
Table 3-53: Multiple Rectifier Failure or Major Alarm, Single–Carrier System	3-88
Table 3-54: Single Rectifier Fail or Minor Alarm, Two–Carrier System	3-89
Table 3-55: Multiple Rectifier Failure or Major Alarm, Two–Carrier System	3-90
Table 3-56: Battery Over–Temperature Alarm	3-90
Table 3-57: Rectifier Over–Temperature Alarm	3-93
Table 4-1: Set Up Test Equipment – TX Output Verify/Control Tests	4-3
Table 4-2: All TX/RX ATP Test Procedure	4-5
Table 4-3: All TX ATP Test Procedure	4-5
Table 4-4: All RX ATP Test Procedure	4-6
Table 4-5: Test Spectral Purity Transmit Mask	4-10
Table 4-6: Test Waveform Quality (Rho)	4-12
Table 4-7: Test Pilot Time Offset	4-13
Table 4-8: Test Code Domain Power/Noise Floor	4-16
Table 4-9: Test FER	4-19
Table 4-10: Generating an ATP Report	4-20
Table 5-1: Copying CAL Files to a Diskette	5-1
Table 5-2: Copying CAL Files from Diskette to the CBSC	5-1
Table 5-3: Remove External Test Equipment	5-3
Table 5-4: Reset BTS Devices and Remote Site Initialization	5-3
Table 5-5: Bring Modules into Service	5-4
Table 5-6: Remove LMF	5-4
Table 5-7: Connect T1 or E1 Spans	5-5
Table 5-8: Check Before Leaving the Site	5-5
Table 6-1: Login Failure Troubleshooting Procedures	6-2
Table 6-2: Force Ethernet LAN A to Active State as Primary LAN	6-2
Table 6-3: GLI IP Address Setting	6-4
Table 6-4: Troubleshooting a Power Meter Communication Failure	6-5
Table 6-5: Troubleshooting a Communications Analyzer Communication Failure	6-6
Table 6-6: Troubleshooting Code Download Failure	6-7
Table 6-7: Troubleshooting Data Download Failure	6-7
Table 6-8: Troubleshooting Device Enable (INS) Failure	6-8
Table 6-9: LPA Errors	6-9
Table 6-10: Troubleshooting BLO Calibration Failure	6-10
Table 6-11: Troubleshooting Calibration Audit Failure	6-11

List of Tables – continued

Table 6-12: Troubleshooting TX Mask Measurement Failure	6-15
Table 6-13: Troubleshooting Rho and Pilot Time Offset Measurement Failure	6-15
Table 6-14: Troubleshooting Code Domain Power and Noise Floor Measurement Failure	6-16
Table 6-15: Troubleshooting Carrier Measurement Failure	6-16
Table 6-16: Troubleshooting Multi-FER Failure	6-17
Table 6-17: No GLI2 Control via LMF (all GLI2s)	6-21
Table 6-18: No GLI2 Control through Span Line Connection (Both GLI2s) ..	6-22
Table 6-19: MGLI2 Control Good – No Control over Co-located GLI2	6-22
Table 6-20: MGLI2 Control Good – No Control over AMR	6-22
Table 6-21: MGLI2 Control Good – No Control over Co-located BBX2s	6-23
Table 6-22: BBX2 Control Good – No (or Missing) Span Line Traffic	6-23
Table 6-23: No MCC24/MCC8E Channel Elements	6-23
Table 6-24: No DC Input Voltage to Power Supply Module	6-24
Table 6-25: No DC Input Voltage to any SCCP Shelf Module	6-25
Table 6-26: TX and RX Signal Routing Problems	6-25
Table 6-27: RFDS Fault Isolation – All tests fail	6-26
Table 6-28: RFDS Fault Isolation – All tests fail on single antenna path	6-26
Table 6-29: Troubleshoot Control Link Failure	6-35
Table 6-30: Set BTS Span Parameter Configuration	6-37
Table A-1: Verification of Test Equipment Used	A-1
Table A-2: Site Checklist	A-2
Table A-3: Preliminary Operations	A-2
Table A-4: GPS Receiver Operation	A-5
Table A-5: LFR Receiver Operation	A-6
Table A-6: LPA IM Reduction	A-7
Table A-7: TX BLO Calibration (3-Sector: 1-Carrier and 2-Carrier Non-adjacent Channels)	A-8
Table A-8: TX Bay Level Offset Calibration (3-Sector: 2-Carrier Adjacent Channels)	A-9
Table A-9: TX Antenna VSWR	A-10
Table A-10: RX Antenna VSWR	A-11
Table A-11: CDI Alarm Input Verification	A-11
Table B-1: When RF Optimization Is required on the BTS	B-1
Table B-2: When to Optimize Inter-frame Cabling	B-1
Table B-3: SC 4812ET Lite BTS Optimization and ATP Test Matrix	B-3
Table C-1: BBX2 Gain Set Point vs. Actual BTS Output (in dBm)	C-1
Table D-1: 1900 MHz TX and RX Frequency vs. Channel	D-2

List of Tables – continued

Table D-2: 800 MHz TX and RX Frequency vs. Channel	D-4
Table E-1: PnMaskI and PnMaskQ Values for PilotPn	E-3
Table F-1: HP8921A/600 Communications Test Set Rear Panel Connections Without Rubidium Reference	F-1
Table F-2: HP8921A/600 Communications Test Set Rear Panel Connections With Rubidium Reference	F-3
Table F-3: System Connectivity	F-5
Table F-4: Setting HP8921A GPIB Address	F-6
Table F-5: Pretest Setup for HP8921A	F-6
Table F-6: Pretest Setup for HP8935	F-6
Table F-7: Advantest R3465 GPIB Address and Clock Setup	F-9
Table F-8: Pretest Setup for Advantest R346	F-9
Table F-9: Power Meter Calibration Procedure	F-10
Table F-10: Calibrate Gigatronics 8542 Power Meter	F-12
Table F-11: Calibrating Test Cable Setup (using the HP PCS Interface)	F-14
Table F-12: Procedure for Calibrating Test Cable Setup Using Advantest R3465	F-18
Table G-1: Download ROM and RAM Code to Devices	G-2
Table H-1: Agilent E4406A Power Delta Calibration Procedure	H-3
Table H-2: Advantest R3267 Power Delta Calibration Procedure	H-6
Table H-3: Agilent E6380A Power Delta Calibration Procedure	H-9
Table H-4: HP8921A Power Delta Calibration Procedure	H-12
Table H-5: Advantest Power Delta Calibration Procedure	H-15
Table H-6: In-Service Calibration	H-24

Foreword

Scope of manual

This manual is intended for use by cellular telephone system craftspersons in the day-to-day operation of Motorola cellular system equipment and ancillary devices. It is assumed that the user of this information has a general understanding of telephony, as used in the operation of the Public Switched Telephone Network (PSTN), and is familiar with these concepts as they are applied in the cellular mobile/portable radiotelephone environment. The user, however, is not expected to have any detailed technical knowledge of the internal operation of the equipment.

This document covers only the steps required to verify the functionality of the RF Base Transceiver Subsystem (BTS) equipment prior to system level testing, and is intended to supplement site specific application instructions. It also should be used in conjunction with existing product manuals. Additional steps may be required.

This manual is not intended to replace the system and equipment training offered by Motorola, although it can be used to supplement or enhance the knowledge gained through such training.

Text conventions

The following special paragraphs are used in this manual to point out information that must be read. This information may be set-off from the surrounding text, but is always preceded by a bold title in capital letters. The four categories of these special paragraphs are:

NOTE

Presents additional, helpful, non-critical information that you can use.



IMPORTANT

Presents information to help you avoid an undesirable situation or provides additional information to help you understand a topic or concept.



CAUTION

Presents information to identify a situation in which equipment damage could occur, thus avoiding damage to equipment.



WARNING

Presents information to warn you of a potentially hazardous situation in which there is a possibility of personal injury.

The following special paragraphs are used in tables in the manual to point out information that must be read.

NOTE Presents additional, helpful non-critical information that you can use.
* IMPORTANT Presents information to help you avoid an undesirable situation or provide additional information to help you understand a topic or concept.
! CAUTION Presents information to identify a situation where equipment damage could occur and help you avoid damaging your equipment.
△ WARNING Presents information to warn you of a potentially hazardous situation where there is a possibility of personal injury (serious or otherwise).

Changes to manual

Changes that occur after the printing date are incorporated into your manual by Cellular Manual Revisions (CMRs). The information in this manual is updated, as required, by a CMR when new options and procedures become available for general use or when engineering changes occur. The cover sheet(s) that accompany each CMR should be retained for future reference. Refer to the Revision History page for a list of all applicable CMRs contained in this manual.

Receiving updates

Technical Education & Documentation (TED) maintains a customer database that reflects the type and number of manuals ordered or shipped since the original delivery of your *Motorola* equipment. Also identified in this database is a “key” individual (such as Documentation Coordinator or Facility Librarian) designated to receive manual updates from TED as they are released.

To ensure that your facility receives updates to your manuals, it is important that the information in our database is correct and up-to-date. Therefore, if you have corrections or wish to make changes to the information in our database (i.e., to assign a new “key” individual), please contact Technical Education & Documentation at:

MOTOROLA, INC.
Technical Education & Documentation
1 Nelson C. White Parkway
Mundelein, Illinois 60060
U.S.A.

Phone:
Within U.S.A. and Canada 800-872-8225
Outside of U.S.A. and Canada . . . +1-847-435-5700
FAX: +1-847-435-5541

Reporting manual errors

In the event that you locate an error or identify a deficiency in your manual, please take time to write to us at the address above. Be sure to include your name and address, the complete manual title and part number (located on the manual spine, cover, or title page), the page number (found at the bottom of each page) where the error is located, and any comments you may have regarding what you have found. We appreciate any comments from the users of our manuals.

FCC Requirements

Content

This section presents Federal Communications Commission (FCC) Rules Parts 15 and 68 requirements and compliance information for the SC™ 4812T/ET/ET Lite series RF Base Transceiver Stations (BTS).

FCC Part 15 Requirements

Part 15.19a(3) – INFORMATION TO USER

NOTE

This device complies with Part 15 of the FCC Rules. Operation is subject to the following two conditions:
(1) this device may not cause harmful interference, and
(2) this device must accept any interference received, including interference that may cause undesired operation.

Part 15.21 – INFORMATION TO USER



CAUTION

Changes or modifications not expressly approved by Motorola could void your authority to operate the equipment.

15.105(b) – INFORMATION TO USER

NOTE

This equipment has been tested and found to comply with the limits for a Class B digital device, pursuant to Part 15 of the FCC Rules. These limits are designed to provide reasonable protection against harmful interference in a residential installation. This equipment generates, uses and can radiate radio frequency energy and, if not installed and used in accordance with the instructions, may cause harmful interference to radio communications. However, there is no guarantee that interference will not occur in a particular installation. If this equipment does cause harmful interference to radio or television reception, which can be determined by turning the equipment OFF and ON, the user is encouraged to try to correct the interference by one or more of the following measures:

- Reorient or relocate the receiving antenna.
- Increase the separation between the equipment and receiver.
- Connect the equipment into an outlet on a circuit different from that to which the receiver is connected.
- Consult the dealer or an experienced radio/TV technician for help.

FCC Part 68 Requirements

This equipment complies with Part 68 of the Federal Communications Commission (FCC) Rules. A label inside the cabinet frame easily visible with the door open in the upper portion of the cabinet contains, among other information, the FCC Registration Number and Ringer Equivalence Number (REN) for this equipment. If requested, this information must be provided to the telephone company.

The REN is useful to determine the quantity of the devices which may connect to the telephone line. Excessive RENs on the telephone line may result in the devices not ringing in response to incoming calls. In most, but not all areas, the sum of the RENs should not exceed five (5.0). To be certain of the number of devices that may be connected to the line as determined by the total RENs, contact the telephone company to determine the maximum REN for the calling area.

If the dial-in site access modem causes harm to the telephone network, the telephone company will notify you in advance that temporary discontinuance of service may be required. If advance notice is not practical, the telephone company will notify you of the discontinuance as soon as possible. Also, you will be advised of your right to file a complaint with the FCC if you believe it is necessary.

The telephone company may make changes in its facilities, equipment, operations, or procedures that could affect the operation of your dial-in

site access modem. If this happens, the telephone company will provide advance notice so that you can modify your equipment as required to maintain uninterrupted service.

If you experience trouble with the dial-in site access modem, please contact:

Global Customer Network Resolution Center (CNRC)
1501 W. Shure Drive, 3436N
Arlington Heights, Illinois 60004
Phone Number: (847) 632-5390

for repair and/or warranty information. If the trouble is causing harm to the telephone network, the telephone company may request you to disconnect the equipment from the network until the problem is solved. You should not attempt to repair this equipment yourself. This equipment contains no customer or user-serviceable parts.

Changes or modifications not expressly approved by Motorola could void your authority to operate this equipment.

General Safety

Remember! . . . Safety depends on you!!

The following general safety precautions must be observed during all phases of operation, service, and repair of the equipment described in this manual. Failure to comply with these precautions or with specific warnings elsewhere in this manual violates safety standards of design, manufacture, and intended use of the equipment. Motorola, Inc. assumes no liability for the customer's failure to comply with these requirements. The safety precautions listed below represent warnings of certain dangers of which we are aware. You, as the user of this product, should follow these warnings and all other safety precautions necessary for the safe operation of the equipment in your operating environment.

Ground the instrument

To minimize shock hazard, the equipment chassis and enclosure must be connected to an electrical ground. If the equipment is supplied with a three-conductor ac power cable, the power cable must be either plugged into an approved three-contact electrical outlet or used with a three-contact to two-contact adapter. The three-contact to two-contact adapter must have the grounding wire (green) firmly connected to an electrical ground (safety ground) at the power outlet. The power jack and mating plug of the power cable must meet International Electrotechnical Commission (IEC) safety standards.

Do not operate in an explosive atmosphere

Do not operate the equipment in the presence of flammable gases or fumes. Operation of any electrical equipment in such an environment constitutes a definite safety hazard.

Keep away from live circuits

Operating personnel must:

- not remove equipment covers. Only Factory Authorized Service Personnel or other qualified maintenance personnel may remove equipment covers for internal subassembly, or component replacement, or any internal adjustment.
- not replace components with power cable connected. Under certain conditions, dangerous voltages may exist even with the power cable removed.
- always disconnect power and discharge circuits before touching them.

Do not service or adjust alone

Do not attempt internal service or adjustment, unless another person, capable of rendering first aid and resuscitation, is present.

General Safety – continued

Use caution when exposing or handling the CRT

Breakage of the Cathode-Ray Tube (CRT) causes a high-velocity scattering of glass fragments (implosion). To prevent CRT implosion, avoid rough handling or jarring of the equipment. The CRT should be handled only by qualified maintenance personnel, using approved safety mask and gloves.

Do not substitute parts or modify equipment

Because of the danger of introducing additional hazards, do not install substitute parts or perform any unauthorized modification of equipment. Contact Motorola Warranty and Repair for service and repair to ensure that safety features are maintained.

Dangerous procedure warnings

Warnings, such as the example below, precede potentially dangerous procedures throughout this manual. Instructions contained in the warnings must be followed. You should also employ all other safety precautions that you deem necessary for the operation of the equipment in your operating environment.



WARNING

Dangerous voltages, capable of causing death, are present in this equipment. Use extreme caution when handling, testing, and adjusting.

Revision History

Manual Number

68P09253A60

Manual Title

1X SC™ 4812ET Lite BTS Optimization/ATP
Software Release 2.16.0.x and CDMA LMF Build 2.16.x.x

Version Information

The following table lists the manual version, date of version, and remarks on the version.

Version Level	Date of Issue	Remarks
1	08/2/2001	Preliminary version of manual for R2.16.0 1X BTS

Patent Notification

Patent numbers

This product is manufactured and/or operated under one or more of the following patents and other patents pending:

4128740	4661790	4860281	5036515	5119508	5204876	5247544	5301353
4193036	4667172	4866710	5036531	5121414	5204977	5251233	5301365
4237534	4672657	4870686	5038399	5123014	5207491	5255292	5303240
4268722	4694484	4872204	5040127	5127040	5210771	5257398	5303289
4282493	4696027	4873683	5041699	5127100	5212815	5259021	5303407
4301531	4704734	4876740	5047762	5128959	5212826	5261119	5305468
4302845	4709344	4881082	5048116	5130663	5214675	5263047	5307022
4312074	4710724	4885553	5055800	5133010	5214774	5263052	5307512
4350958	4726050	4887050	5055802	5140286	5216692	5263055	5309443
4354248	4729531	4887265	5058136	5142551	5218630	5265122	5309503
4367443	4737978	4893327	5060227	5142696	5220936	5268933	5311143
4369516	4742514	4896361	5060265	5144644	5222078	5271042	5311176
4369520	4751725	4910470	5065408	5146609	5222123	5274844	5311571
4369522	4754450	4914696	5067139	5146610	5222141	5274845	5313489
4375622	4764737	4918732	5068625	5152007	5222251	5276685	5319712
4485486	4764849	4941203	5070310	5155448	5224121	5276707	5321705
4491972	4775998	4945570	5073909	5157693	5224122	5276906	5321737
4517561	4775999	4956854	5073971	5159283	5226058	5276907	5323391
4519096	4797947	4970475	5075651	5159593	5228029	5276911	5325394
4549311	4799253	4972355	5077532	5159608	5230007	5276913	5327575
4550426	4802236	4972432	5077741	5170392	5233633	5276915	5329547
4564821	4803726	4979207	5077757	5170485	5235612	5278871	5329635
4573017	4811377	4984219	5081641	5170492	5235614	5280630	5339337
4581602	4811380	4984290	5083304	5182749	5239294	5285447	D337328
4590473	4811404	4992753	5090051	5184349	5239675	5287544	D342249
4591851	4817157	4998289	5093632	5185739	5241545	5287556	D342250
4616314	4827507	5020076	5095500	5187809	5241548	5289505	D347004
4636791	4829543	5021801	5105435	5187811	5241650	5291475	D349689
4644351	4833701	5022054	5111454	5193102	5241688	5295136	RE31814
4646038	4837800	5023900	5111478	5195108	5243653	5297161	
4649543	4843633	5028885	5113400	5200655	5245611	5299228	
4654655	4847869	5030793	5117441	5203010	5245629	5301056	
4654867	4852090	5031193	5119040	5204874	5245634	5301188	

Chapter 1: Introduction

Table of Contents

Optimization Manual Scope and Layout	1-1
Manual Scope and Layout	1-1
Assumptions and Prerequisites	1-1
Document Composition	1-2
Purpose of the Optimization	1-3
Why Optimize?	1-3
What Is Optimization?	1-3
What Happens During Optimization	1-3
When to Optimize	1-4
New Installations	1-4
Site Expansion	1-4
Periodic Optimization	1-4
Repaired Sites	1-4
Required Test Equipment and Software	1-5
Policy	1-5
Test Equipment Calibration	1-5
Test Cable Calibration	1-5
Equipment Warm-up	1-5
Required Test Equipment and Software	1-6
Optional Equipment	1-10
Required Documents and Related Publications	1-12
Required Documents	1-12
Related Publications	1-12
Terms and Abbreviations	1-13
Standard and Non-standard Terms and Abbreviations	1-13
BTS Equipment Identification	1-15
Equipment Overview	1-15
Logical BTS Numbering	1-15
Cabinet Identification	1-17
Major Components	1-17
Internal Assembly Location and Identification	1-18
Internal Assemblies and FRUs	1-18
SCCP Cage Configuration and the 1X Devices	1-26
BTS Sector Configurations	1-27
Sector Configuration	1-27

Manual Scope and Layout

This document provides information pertaining to the optimization and audit tests of the Motorola SC4812ET Lite RF Base Transceiver Station (BTS) equipment frame and its associated internal and external interfaces. The following subjects are addressed: preliminary background information; optimization, and alarm/redundancy tests; Acceptance Test Procedures (ATP) to verify site operation and regulation compliance; site turnover; troubleshooting.

Most applications use the same test procedure for all equipment variations. However, decision break points are provided throughout the procedure when equipment-specific tests are required. For example, when tests using external test equipment are performed instead of those using the RFDS, additional test procedures and illustrations are provided to cover both applications.

This optimization procedure consists of a group of task-oriented tests. Each major test category (Audit, Initial power-up, Calibration tests, etc.) is described in chapters which are broken down into multi-page “maps.”

Each “map” typically consists of pages containing all the information necessary to perform the test (including all required input levels, output levels, CDMA Local Maintenance Facility (CDMA LMF) commands, and test points required). Also described are some of the main concepts you must understand in the test process. Whenever possible, graphics, flowcharts, or other examples complement the information/steps.

Assumptions and Prerequisites

This document assumes that the BTS frames and cabling have been installed per the *Frame Mounting Guide Analog/CDMA/TDMA; 68P09226A18*, which covers the physical “bolt down” of all SC series equipment frames, and the *SC4812ET Lite Installation; 68P09253A36*, which covers BTS-specific cabling configurations.

Document Composition

This document covers the following major areas:

- Introduction, consisting of preliminary background information (such as component and subassembly locations and frame layouts) to be considered by the Cellular Field Engineer (CFE) before performing optimization or tests.
- Preliminary Operations, consisting of jumper configuration of BTS sub-assemblies, pre-power-up tests, initial application of power to the BTS equipment frames, and initial power-up tests.
- Optimization/Calibration, consisting of procedures for downloading all BTS processor boards, test equipment set-up, RF path verification, BLO calibration and calibration audit, and Radio Frequency Diagnostic System (RFDS) calibration.
- Acceptance Test Procedures (ATP), consisting of automated ATP tests, executed by the CDMA LMF, and used to verify all major TX and RX performance characteristics on all BTS equipment. This chapter also covers generating an ATP report.
- Prepare to Leave the Site, discussing site turnover after ATP is completed.
- Basic Troubleshooting, consisting of procedures to perform when an ATP fails, as well as when incorrect results are obtained during logon, test equipment operation, calibration, and GPS operation.
- Appendices that contain pertinent PN offset, frequency programming, and output power data tables, along with additional data sheets that are filled out manually by the CFE at the site.

Why Optimize?

Proper optimization and calibration ensures that:

- Accurate downlink RF power levels are transmitted from the site.
- Accurate uplink signal strength determinations are made by the site.

What Is Optimization?

Optimization compensates for the site-specific cabling and normal equipment variations. Site optimization guarantees that the combined losses of the new cables and the gain/loss characteristics and built-in tolerances of each BTS frame do not accumulate and cause improper site operation.

What Happens During Optimization

Optimization identifies the accumulated loss (or gain) for each receive and transmit path at the BTS site, and stores these values in a database.

- A receive path (RX) starts at the Duplexer Directional Coupler (DRDC) or Transmit & Receive Dual Directional Coupler (TRDC) antenna feedline port and travels through the DRDC/TRDC, the Multi-coupler Preselector Card (MPC) and additional splitter circuitry, ending at a Broad Band Transceiver (BBX) backplane slot in the Small CDMA Channel Processor (SCCP) shelf.
- A transmit path (TX) starts at the SCCP shelf BBX backplane slot, is routed to the Linear Power Amplifier (LPA) Trunking Module, through the LPAs, back through the LPA Trunking Module, through the bandpass filter or 2-cavity combiner, and ends at the DRDC/TRDC antenna feedline port.

Six of the seven BBX2 boards in each SCCP shelf are optimized to specific RX and TX antenna ports. The seventh BBX2 board acts in a redundant capacity for BBX2 boards 1 through 6, and is optimized to all antenna ports. A single value is generated for each complete path, thereby eliminating the accumulation of error that would occur from individually measuring and summing the gain and loss of each element in the path.

BTS equipment factors in these values internally, leaving only site-specific antenna feed line loss and antenna gain characteristics to be factored in by the CFE when determining site Effective Radiated Power (ERP) output power requirements.

When to Optimize

New Installations

After the initial site installation, the BTS must be prepared for operation. This preparation includes verifying hardware installation, initial power-up, downloading of operating code, verifying GPS operation and verifying transmit and receive paths.

Next, the optimization is performed. Optimization includes performance verification and calibration of all transmit and receive RF paths, and download of accumulated calibration data.

A calibration audit of all RF transmit paths may be performed any time after optimization to verify BTS calibration.

After optimization, a series of manual pre-Acceptance Test Procedure (ATP) verification tests are performed to verify alarm/redundancy performance.

After manual pre-ATP verification tests, a series of ATPs are performed to verify BTS performance. An ATP is also required before the site can be placed in service.

Site Expansion

Optimization is also required after expansion of a site with additional, interconnected BTS frames.

Periodic Optimization

Periodic optimization of a site may also be required, depending on the requirements of the overall system.

Repaired Sites



IMPORTANT

Refer to Appendix B for a detailed FRU Optimization/ATP Test Matrix outlining the minimum tests that must be performed *any time* a BTS subassembly or RF cable associated with it is replaced.

Policy

To ensure consistent, reliable, and repeatable optimization test results, test equipment and software meeting the following technical criteria should be used to optimize the BTS equipment. Test equipment can, of course, be substituted with other test equipment models *if the equipment meets the same technical specifications*.

It is the responsibility of the customer to account for any measurement variances and/or additional losses/inaccuracies that can be introduced as a result of these substitutions. Before beginning optimization or troubleshooting, make sure that the test equipment needed is on hand and operating properly.

Test Equipment Calibration

Optimum system performance and capacity depend on regular equipment service, calibration, and characterization prior to BTS optimization. Follow the original equipment manufacture (OEM) recommended maintenance and calibration schedules closely.

Test Cable Calibration

Equipment test cables are very important in optimization. It is recommended that the cable calibration be run at every BTS with the test cables attached. This method compensates for test cable insertion loss within the test equipment itself. No other allowance for test cable insertion loss needs to be made during the performance of tests.

Another method is to account for the loss by entering it into the CDMA LMF during the optimization procedure. This method requires accurate test cable characterization in a shop. The cable should be tagged with the characterization information prior to field optimization.

Equipment Warm-up

After arriving at a site, the test equipment should be plugged in and turned on to allow warm up and stabilization to occur for as long as possible. The following pieces of test equipment must be warmed up for *a minimum of 60 minutes* prior to using for BTS optimization or RFDS calibration procedures:

- Communications test set.
- Rubidium time base.
- Power meter.

Required Test Equipment and Software – continued

Required Test Equipment and Software

The following test equipment and software is required for the optimization procedure. Common assorted tools such as screwdrivers and frame keys are also needed. Read the owner's manual for all of the test equipment to understand its individual operation before using the tool in the optimization.

NOTE

Always refer to specific OEM test equipment documentation for detailed operating instructions.

CDMA LMF Hardware Requirements

A CDMA LMF computer platform that meets the following requirements (or better) is recommended:

- Notebook computer
- 266 MHz (32 bit CPU) Pentium processor
- 4 Gbyte internal hard disk drive
- SVGA 12.1–inch active matrix color display with 1024 x 768 (recommended) or 800 x 600 pixel resolution and capability to display more than 265 colors
- 64 MB RAM minimum (128 MB recommended)
- 20X CD–ROM drive
- 3 1/2 inch floppy drive
- 56kbps V.90 modem
- Serial port (COM 1)
- Parallel port (LPT 1)
- PCMCIA Ethernet interface card (for example, 3COM Etherlink III) with a 10BaseT–to–coax adapter
- MS® Windows 98® Second Edition (SE) operating system

NOTE

If 800 x 600 pixel resolution is used, the CDMA LMF window must be maximized after it is displayed.

CDMA LMF Software

The CDMA LMF is a graphical user interface (GUI) based Local Maintenance Facility (LMF). This software product is specifically designed to provide cellular communications field personnel with the capability to support the following CDMA Base Transceiver Stations (BTS) operations:

- Installation
- Maintenance
- Calibration
- Optimization

Ethernet LAN Transceiver (part of CGDSL MFCOMPAQNOV96)

- PCMCIA Ethernet Adapter + Ethernet UTP Adapter
3COM Model – Etherlink III 3C589B

used with

- Transition Engineering Model E-CX-TBT-03 10BaseT/10Base2 Converter (or equivalent)

NOTE

Xircom Model PE3-10B2 or its equivalent can also be used to interface the CDMA LMF Ethernet connection to the RFM frame.

Ethernet LAN External In/Out Port Adapter

Trompeter Electronics, Inc., AD-BJ20-E1-PL75 or equivalent BNC (F) to TRB (M) adapter is required if it is necessary to connect the CDMA LMF computer to the LAN external interface triaxial connectors located in the power entry compartment.

RS-232 to GPIB interface

- National Instruments GPIB-232-CT with Motorola CGDSEDN04X RS232 serial cable or equivalent; used to interface the CDMA LMF to the test equipment.
- *A standard RS-232 cable can be used with the following modifications:*

-Pin 8 (CTS) does not have to be jumpered/shorted to the others as it is a driver output. The DTR is already a driver output signal. The other pins are to receivers. Short pins 7, 1, 4, 6 on each cable end:

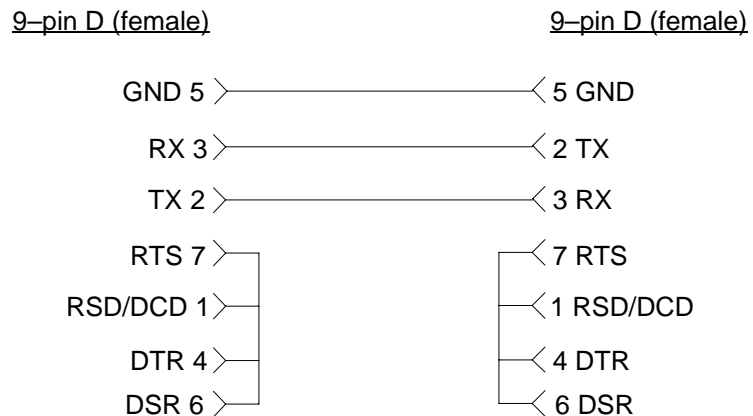

Model SLN2006A MMI interface kit

- Motorola Model TRN9666A null modem board. Connectors on opposite sides of the board must be used as this performs a null modem transformation between cables. This board can be used for 25-pin to 8-pin, 25-pin to 25-pin, and 10-pin to 10-pin conversions.
- Motorola 30-09786R01 MMI cable or equivalent; used to interface the CDMA LMF serial port connection to the GLI, CSM, ETIB board, and module debug serial ports.

Communications system analyzer CDMA/analog

The following communications system analyzers are supported by the LMF:

- Motorola CyberTest
- Advantest R3465 Analyzer with R3561L Signal Generator
- Hewlett Packard Model HP 8921A/600 Analyzer including 83203B CDMA Interface, manual control system card, and 83236A/B PCS Interface for 1900 MHz BTSs.
- Hewlett Packard Model HP 8935 Analyzer

or a combination of test equipment supported by the CDMA LMF and used during optimization and testing of the RF communications portion of BTS equipment.

The analyzer provides the following functions:

- Frequency counter.
- Deviation meter.
- RF power meter (average and code domain).
- RF signal generator (capable of DSAT/CDMA modulation).
- Audio signal generator.
- AC voltmeter (with 600-ohm balanced audio input and high impedance input mode).
- Noise measurement meter.
- C-Message filter.
- Spectrum analyzer.
- CDMA code domain analyzer.

GPIB cables

Hewlett Packard 10833A or equivalent; one or two meters long, used to interconnect test equipment and CDMA LMF terminal.

Power meter

- Hewlett Packard Model HP437B with HP8481A power sensor capable of measuring from -30 dBm to 20 dBm,

or

- Gigatronics 8542B power meter.

Timing reference cables

- *Two* Huber & Suhner 16MCX/11BNC/K02252D or equivalent; right angle MCX–male to standard BNC–male RG316 cables; 10 ft. long are required to interconnect the communications system analyzer to SGLN4132A and SGLN1145A CSM board timing references,

or

- *Two* BNC–male to BNC–male RG316 cables; 3 meters (10 feet) long, used to interconnect the communications system analyzer to SGLN4132B and SGLN1145B (and later) CSM front panel timing references in the RF Modem Frame.

Digital multimeter

Fluke Model 8062A with Y8134 test lead kit or equivalent; used for precision DC and AC measurements to four decimal places.

Directional coupler

Narda Model 3020A 20 dB coupler terminated with two Narda Model 375BN–M loads, or equivalent.

RF attenuators

- 20 dB Fixed attenuator, 20 Watt (Narda 768–20), used in conjunction with calibration of test cables or during general troubleshooting procedures.
- 10 dB Fixed attenuator, 20 Watt (Narda 768–10), for cable calibration with a Cybertest CDMA analyzer.

Clamp–on DC current probe

Amprobe CT600, or equivalent, 600 amp capability with jaw size which accommodates 2/0 cable. Used with the DMM for back–up battery charging testing.

Miscellaneous RF adapters, loads, etc.

As required to interface test cables and BTS equipment and for various test setups. Should include at least (2) 50 Ohm loads (type N) for calibration and (1) RF short.

RF load

100W non–radiating RF load used (as required) to provide dummy RF loading during BTS transmit tests.

High–impedance conductive wrist strap

Motorola Model 42–80385A59; used to prevent damage from ESD when handling or working with modules.

Driver bit for tamper-resistant fasteners

Torx tamper-resistant insert bit set, Grainger 5F530 or equivalent, to remove tamper-resistant fasteners securing the frame rear access cover.

Optional Equipment

This section provides a list of additional equipment that might be required during maintenance and troubleshooting operations.

NOTE

Not all optional equipment specified in this section will be supported by the CDMA LMF in automated tests.

Duplexer

Filtrionics Low IM Duplexer (Cm035-f2) or equivalent; used during Spectral Purity Receive band noise tests.

Frequency counter

Stanford Research Systems SR620 or equivalent; used if direct measurement of the 3 MHz or 19.6608 MHz references is required.

Spectrum analyzer

Spectrum Analyzer (HP8594E with CDMA personality card) or equivalent; required for *manual* tests other than standard Receive band spectral purity and TX LPA IM reduction verification tests performed by the CDMA LMF.

LAN tester

Model NETcat 800 LAN troubleshooter (or equivalent); used to supplement LAN tests using the ohm meter.

Span line (T1/E1) verification equipment

As required for the local application.

RF test cable (if not provided with test equipment)

Motorola Model TKN8231A; used to connect test equipment to the BTS transmitter output during optimization or during general troubleshooting procedures.

Oscilloscope

Tektronics Model 2445 or equivalent; used for waveform viewing, timing, and measurements, or during general troubleshooting procedures.

2-way splitter

Mini-Circuits Model ZFSC-2-2500 or equivalent; used to provide the diversity receive input to the BTS.

CDMA subscriber mobile or portable radiotelephone

Safco Model 2136–150 with power supply and antenna; used to provide test transmission and reception during BTS maintenance and troubleshooting. *Do not substitute other models that do not feature special test modes.* Two radios will be required for system and drive-around testing *after* optimization and BTS ATP are completed.

RF circulator

Circulator (FERROCOM 5809866C01) or equivalent; can substitute for a duplexer during Receive sensitivity FER testing in conjunction with Safco CDMA mobile.

High stability 10 MHz rubidium standard

Stanford Research Systems SR625 or equivalent. Required for CSM and LFR/HSO frequency verification.

Required Documents and Related Publications

Required Documents

The following documents are required to perform optimization of the cell site equipment:

- Site Document (generated by Motorola Systems Engineering), which includes:
 - General site information
 - Floor plan
 - RF power levels
 - Frequency plan (includes Site PN and operating frequencies)
 - Channel allocation (paging, traffic, etc.)
 - Board placement
 - Site wiring list
 - *Site-specific CDF file*
- Demarcation Document (Scope of Work Agreement)
- Equipment manuals for non-Motorola test equipment

Related Publications

Additional, detailed information about the installation, operation, and maintenance of the SC4812ET Lite BTS and its components is included in the following publications:

- *CDMA RFDS User's Guide; 68P64114A51*
- *LMF Help function*
- *LMF CLI Reference; 68P09253A56*
- *CDMA RFDS Hardware Installation; 68P64113A93*
- *SC4812ET Lite Installation; 68P09253A36*
- *SC4812ET Lite Field Replaceable Units; 68P09253A49*
- *SC4812T/ET/ET Lite Troubleshooting; 68P09252A93*
- *Frame Mounting Guide Analog/CDMA/TDMA; 68P09226A18*
- *Cellular Glossary of Terms and Acronyms; 68P09213A95*
- M-PATH™ T1 Channel Service Unit User's Guide, ADC Kentrox® part number 65-77538101
- M-PATH™ E1 Channel Service Unit Installation Guide, ADC Kentrox® part number 1174662
- 2-Slot Universal Shelf Installation Guide, *ADC Kentrox* part number 65-78070001

Standard and Non-standard Terms and Abbreviations

Standard terms and abbreviations used in this manual are defined in *Cellular Glossary of Terms and Acronyms; 68P09213A95*. Any non-standard terms or abbreviations included in this manual are listed in Table 1-1.

Table 1-1: Non-Standard Terms and Abbreviations

Term or Abbreviation	Definition
ACLC	AC Load Center. An SC4812ET Lite RF Base Transceiver Station (BTS) subassembly which provides the frame interface for external AC power connection and internal AC circuit control and protection.
CCD	Clock Combining and Distribution. SC4812-series BTS CDMA Channel Processor (CCP) shelf module which accepts timing signals from the active source and distributes them to other CCP shelf modules.
CIO	Combiner Input/Output.
DMAC	Digital Metering, Alarm, Control. Part of the Meter Alarm Panel (MAP) which provides control of and status information for the AC power rectifiers as well as back-up battery monitoring and test capability. Term is used interchangeably with MAP (see below).
DRDC	Duplexer, Receive Filter, Dual Directional Coupler. Provides duplexing of BTS transmit and receive signals to a single antenna and antenna signal sampling in either the forward (transmit) or reflected (receive) direction for use by an RF Diagnostic Subsystem (RFDS).
EMPC	Expansion Multi-coupler Preselector Card. BTS expansion frame MPC module which is used to receive, amplify, and distribute RX signals from the starter frame MPC.
ETIB	External Trunked Interface Board. Module providing status indicators and MMI interface connections for LPAs in SC4812ET and SC4812ET Lite BTS frames.
HSO	High Stability Oscillator. Module providing backup timing source for a BTS when the timing signal from the GPS or RGPS module is unavailable.
HSOX	HSO Expansion. Module used in a BTS expansion frame to interface with the starter frame HSO or LFR and distribute the timing signals to the expansion frame CSM modules.
LPAC	Linear Power Amplifier Controller
MAP	Meter Alarm Panel. SC4812ET Lite Field Replaceable Unit (FRU) which contains the functions of both the Temperature Compensation Panel (TCP) and the DMAC. Term is used interchangeably with DMAC.
MPC	Multi-coupler Preselector Card. BTS CCP shelf module used to amplify and distribute RX signals to BBX modules.
PDA	Power Distribution Assembly. Assembly in an SC4812ET Lite BTS providing internal DC power distribution and circuit protection.

. . . continued on next page

Terms and Abbreviations – continued

Table 1-1: Non-Standard Terms and Abbreviations

Term or Abbreviation	Definition
RGD	Remote Global Positioning System (GPS) Distribution
SCCP	Small CDMA Channel Processor. The type of CCP shelf used in the SC4812ET Lite BTS.
test equipment set	The CDMA LMF computer, communications test set, directional couplers, attenuators, termination loads, associated test cables, and adapters needed for the complete calibration and acceptance testing of a BTS. The <i>test equipment set</i> is calibrated and maintained as a unit. When one component of a set is replaced, the complete set must be recalibrated to ensure measurement errors are not introduced during BTS optimization and ATP.
TCP	Temperature Compensation Panel. A function of the SC4812ET Lite MAP which provides the capability to adjust DC voltage output of the rectifiers to compensate for variations resulting from temperature changes.
TRDC	Transmit & Receive Dual Directional Coupler (Non-duplexed, Receive Filter). TRDCs contains separate transmit and receive paths and bandpass filters which are not connected electrically. Transmit and receive antenna signals are not duplexed and must be handled by separate antennas. Each RF path contains a dual directional coupler on the antenna port which allows sampling of antenna signals in the forward (transmit) and reflected (receive) directions for use by an RFDS.

Equipment Overview

The SC4812ET Lite BTS frame consists of a single, outdoor, weatherized cabinet containing RF and power components. The BTS is functionally similar to the two-cabinet SC4812ET, but provides more flexibility in site selection because of its smaller footprint and lighter weight. The BTS is powered by 240 Vac, rectified internally to +27 Vdc, and can support up to two carriers in a 3-sector configuration. An SC4812ET Lite starter frame with the maximum of one SC4812ET Lite expansion frame can support a maximum of four carriers in a 3-sector configuration. Six-sector operation is not supported with any SC4812ET Lite configuration.

The BTS frame houses the fan modules, RF compartment heat exchanger, Small CDMA Channel Processor shelf (SCCP), RF Linear Power Amplifier (LPA) modules, LPA trunking modules, bandpass filters or 2:1 combiners, and Duplexer Directional Couplers (DRDC) or Triplexer Directional Couplers (TRDC). Power components include an AC Load Center (ACLC), rectifiers, a +27 Vdc Power Distribution Assembly (PDA), backup batteries, battery heaters, and one duplex GFCI 115 Vac utility outlet.

Logical BTS Numbering

An SC4812ET Lite logical BTS can consist of up to two SC4812ET Lite frames. In a logical BTS, all frames located at a site are identified as parts of a single, numbered BTS (for example, **BTS-812**). Each frame is assigned a unique frame number. The first, or starter, frame of a logical BTS has a **-1** suffix (for example, **BTS-812-1**) and the second, or expansion, frame of the logical BTS is numbered with the suffix, **-101** (e. g. **BTS-812-101**).

Figure 1-1 shows the frame configuration for a logical BTS consisting of two SC4812ET Lite frames. The figure also shows the BTS-to-CBSC Transcoder and inter-frame span configurations which can be employed with an SC4812ET Lite logical BTS.

BTS Equipment Identification – continued

Figure 1-1: SC4812ET Lite Logical BTS Span Cabling

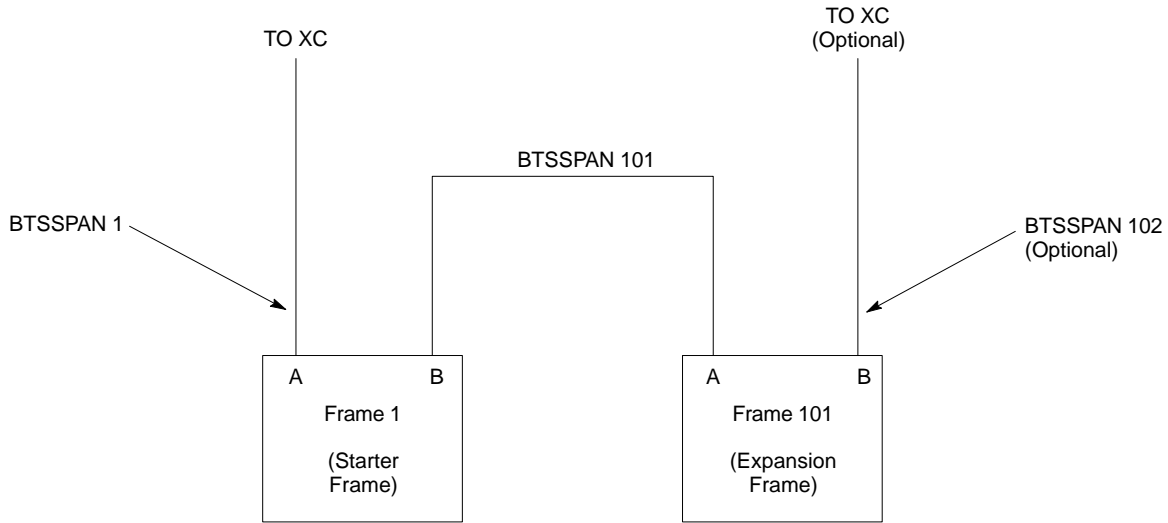

SCCP Shelf Card/Module Device ID Numbers

All Ethernet LAN-addressable modules in the logical BTS frames at a single site are also identified with unique Device ID numbers dependent upon the Frame ID number in which they are located. Refer to Table 1-2, Table 1-3, and Figure 1-5 for specific SCCP Shelf Device ID numbers.

Table 1-2: SCCP Cage Module Device ID Numbers (Top Shelf)

Frame #	Module ID Number (Left to Right)										
	Power (PS-1)	Power (PS-2)	AMR -1	GLI2 -1	MCC2		BBX2			BBX2-R	MPC/EMPC -1
1	-	-	1	1	1	2	1	2	3	R1	-
101	-	-	101	101	101	102	101	102	103	R101	-

Table 1-3: SCCP Cage Module Device ID Numbers (Bottom Shelf)

Frame #	Module ID Number (Left to Right)														
	HSO/LFR	CSM -1	CSM -2	CCD A	CCD B		AMR -2	GLI2-2	MCC2		BBX2			SW	MPC/EMPC -2
1	-	1	2	-	-	-	2	2	3	4	4	5	6	-	-
101	-	101	102	-	-	-	102	102	103	104	104	105	106	-	-

Major Components

Figure 1-2 illustrates the features of the BTS frame, the single major component of the Motorola SC4812ET Lite.

Figure 1-2: SC4812ET Lite BTS Frame

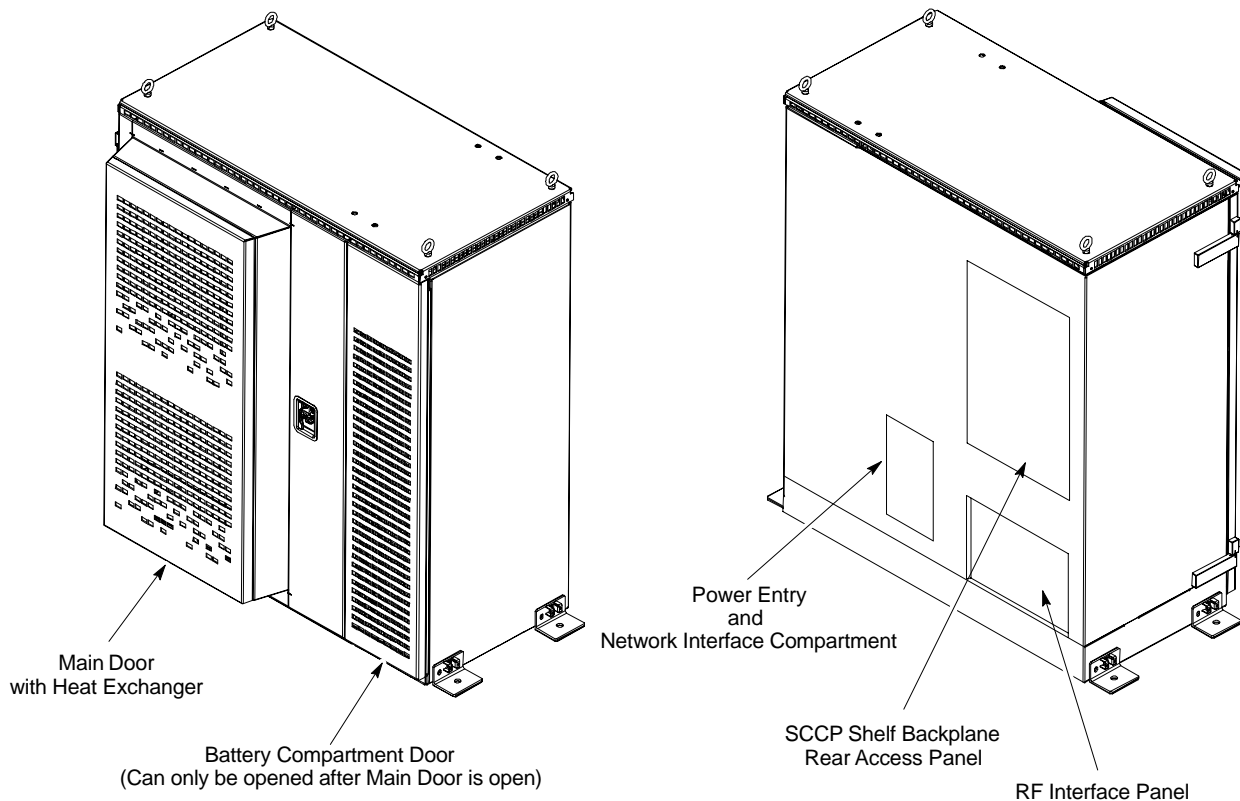

SC4812ETL0001-1

Internal Assembly Location and Identification

Internal Assemblies and FRUs

Figure 1-3 shows the location of the internal assemblies and Field Replaceable Units (FRU). A brief description of each item is found in the following paragraphs.

Figure 1-3: Internal Assemblies and FRUs
(Cabinet doors not shown for clarity)

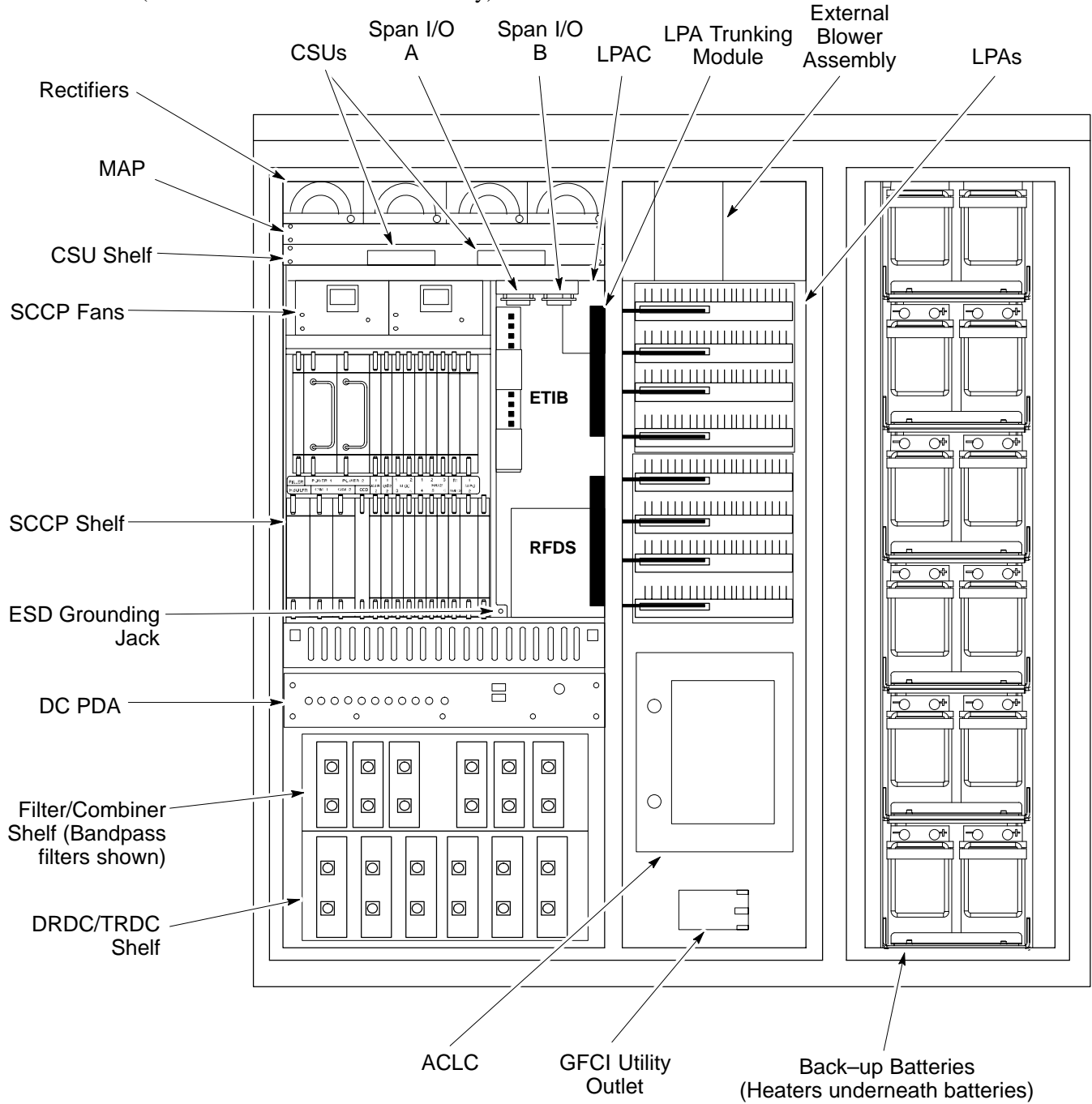

SC4812ETL0002-4

AC Load Center (ACLC)

The ACLC is the frame entry point for AC power. It incorporates AC power control, distribution, and surge protection (Figure 1-3).

Back-up Batteries

The batteries (Figure 1-3) provide +24 Vdc back-up for the frame should AC power be interrupted. The frame can accommodate a total of 12 12V batteries grouped in six strings. Each string consists of two batteries connected in series for 24 Vdc output. The six strings are connected in parallel to meet the current-draw requirements of the frame. The maximum time duration of the back-up capability depends on system configuration.

Battery Heaters

The battery heater pads warm the batteries to provide improved cold-weather performance. A separate heater pad is required for each battery string and is located between each battery string and its respective support shelf.

Channel Service Units (CSU) (Optional)

The SC4812ET Lite can be equipped with up to two *M-PATH 537* CSU or two *M-PATH 437* CSU modules which install in the CSU shelf (Figure 1-3). These modules allow monitoring of span performance and provide capability for remote network management.

CSU Shelf

The CSU shelf is an *ADC Kentrox 2-slot* Universal Shelf which can accommodate two *M-PATH 537* or two *M-PATH 437* CSU modules. When the optional CSU modules are not installed, cover plates are installed over the CSU card slots (Figure 1-3).

DC Power Distribution Assembly (PDA)

Both rectifier output voltage and back-up battery voltage are routed to the PDA (Figure 1-3) where they are combined into system DC bus voltage. The PDA provides distribution of DC power and system DC bus protection from the loads with MAIN BREAKER and the smaller post-distribution circuit breakers. MAIN BREAKER permits removal of *all* frame loading from the bus. The 13 post-distribution circuit breakers permit removal of individual loads.

Duplexer, Receive filter, Dual Directional Coupler (DRDC)

DRDCs permit duplexing of sector transmit and receive signals on a single antenna. The DRDCs also incorporate a receive bandpass filter and dual directional couplers which permit signal monitoring by the RF Diagnostic Subsystem.

ET Interface Board (ETIB) and LPA Control (LPAC) Board

The ETIB is an interconnect module with status LEDs, MMI receptacles, and secondary surge protection for the LPA modules. The LPAC board provides the interface for the LPA connections (Figure 1-3).

Filter/Combiner Shelf (Bandpass Filters or 2:1 Combiners)

The filter/combiner shelf (Figure 1-3) holds the transmit bandpass filters or 2:1 combiners, depending on system configuration.

Heat Exchanger

The heat exchanger provides cooling to the frame RF compartment. The fan speed of the heat exchanger adjusts automatically with temperature. The heat exchanger is located in the frame main door (Figure 1-2).

Punchblock

The punchblock (Figure 1-4) is the interface between the frame and the T1/E1 span lines. It is located on the right-hand side of the power entry compartment at the rear of the frame. The punchblock provides the initial interconnection between the spans and the Customer-defined I/O, alarms, multi-frame timing source (RGPS and RHSO), and pilot beacon control (optional).

Figure 1-4: 50-Pair Punchblock

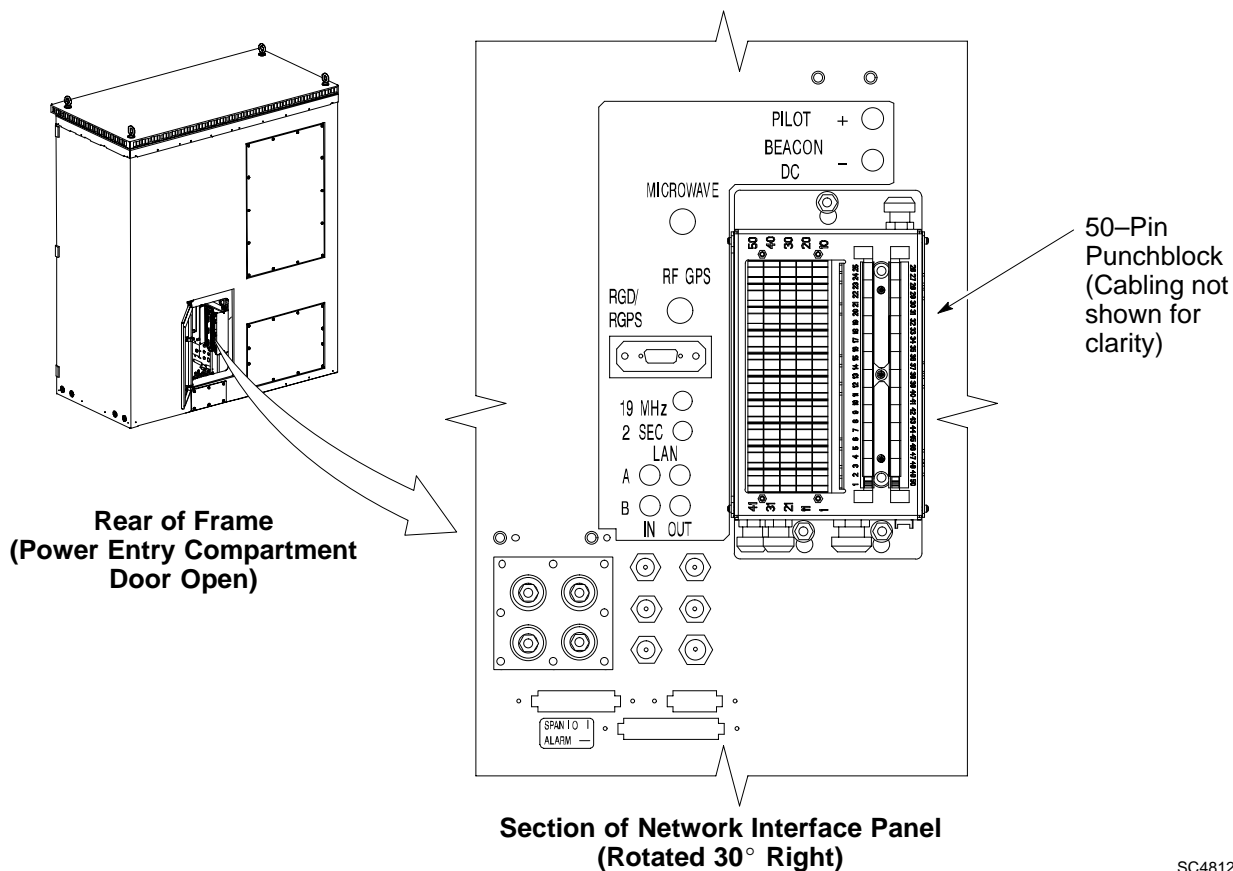

SC4812ETL0024-1

Rectifiers

The rectifiers (Figure 1-3) convert AC power supplied to the frame to +27.4 Vdc which powers the frame and maintains the charge of the back-up batteries. Rectifier positions are numbered 1 through 4 from left to right when facing the frame. Single-carrier frames are equipped with three rectifiers installed in positions 1, 2, and 3. Two-carrier frames are equipped with four rectifiers. The number of rectifiers supplied with each configuration provides N+1 redundancy.

RF Diagnostic Subsystem (RFDS)

The RFDS (Figure 1-5) provides the capability for remotely monitoring the status of the SC4812ET Lite transmit and receive paths. For IS-95A/B operation, the RFDS is a COBRA model. To support 1X operation, the RFDS must be the 1X-capable COBRA-II.

Small CDMA Channel Processor (SCCP) Shelf

The SCCP shelf has provisions for the following types and quantities of modules (Figure 1-3 and Figure 1-5):

- Alarm Monitoring and Reporting (AMR) cards (2)
- Broadband Transceiver (BBX2 or BBX-1X) cards, primary (6)
- BBX2 or BBX-1X card, redundant (1)
- CDMA Clock Distribution (CCD) cards (2)
- Clock Synchronization Manager (CSM) on two cards (one with GPS receiver, if ordered)
- Combiner Input/Output (CIO) card (1)
- Fan modules (2)
- Filler panel (as required)
- Group Line Interface (GLI2) cards (2)
- High Stability Oscillator (HSO)/Low Frequency Receiver (LFR) card (Optional) (1)
- Multi-coupler Preselector Cards (MPC3) (2)
- Multi-Channel CDMA (MCC8E, MCC24, or MCC-1X) cards (4)
- Power supply cards (2)
- Switch card (1)

Internal Assembly Location and Identification – continued

Figure 1-5: SCCP Shelf, IS-95A/B and 1X Devices

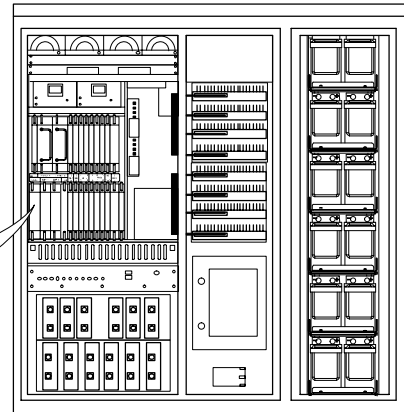
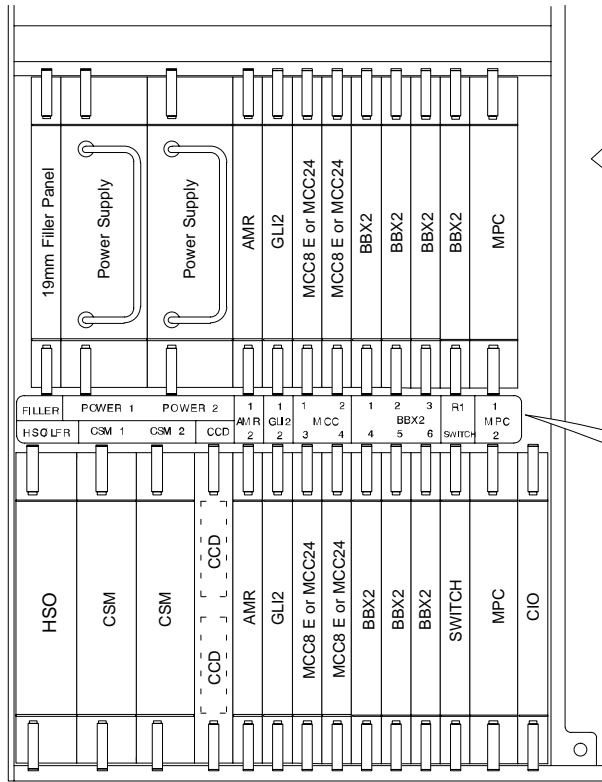

NOTES:

- 1. MCCs may be MCC8Es, MCC24s, or MCC-1Xx
- 2. BBXx may be BBX2s or BBX-1Xs

FILLER	POWER 1	POWER 2	1	1	1	2	1	2	3	R1	1
HSO/LFR	CSM 1	CSM 2	CCD	AMR	GLI2	MCC	BBX2	BBX2	BBX2	SWITCH	MPC
				2	2	3	4	4	5	6	2

FRAME 1

FILLER	POWER 1	POWER 2	101	101	101	102	101	102	103	R101	1
HSO/LFR	CSM 101	CSM 102	CCD	AMR	GLI2	MCC	BBX2	BBX2	BBX2	SWITCH	MPC
				102	102	103	104	104	105	106	2

**FRAME 101
(Expansion Frame)**

SC4812ETL0003-4

Span I/O Boards

The two span I/O boards, Span I/O A and Span I/O B (Figure 1-3), provide the span line interface from the punchblock or the CSU modules, if equipped, to the SCCP backplane.

Transmit & receive, non-duplexed, Receive filter, Dual Directional Coupler (TRDC)

TRDCs provide separate, bandpass-filtered sector transmit and receive paths. When TRDCs are used separate transmit and receive antennas are required for each sector. As with DRDCs, TRDCs dual directional couplers for each antenna path which permit signal monitoring by the RFDS.

Figure 1-6: RF Interface Panel, DRDCs Installed

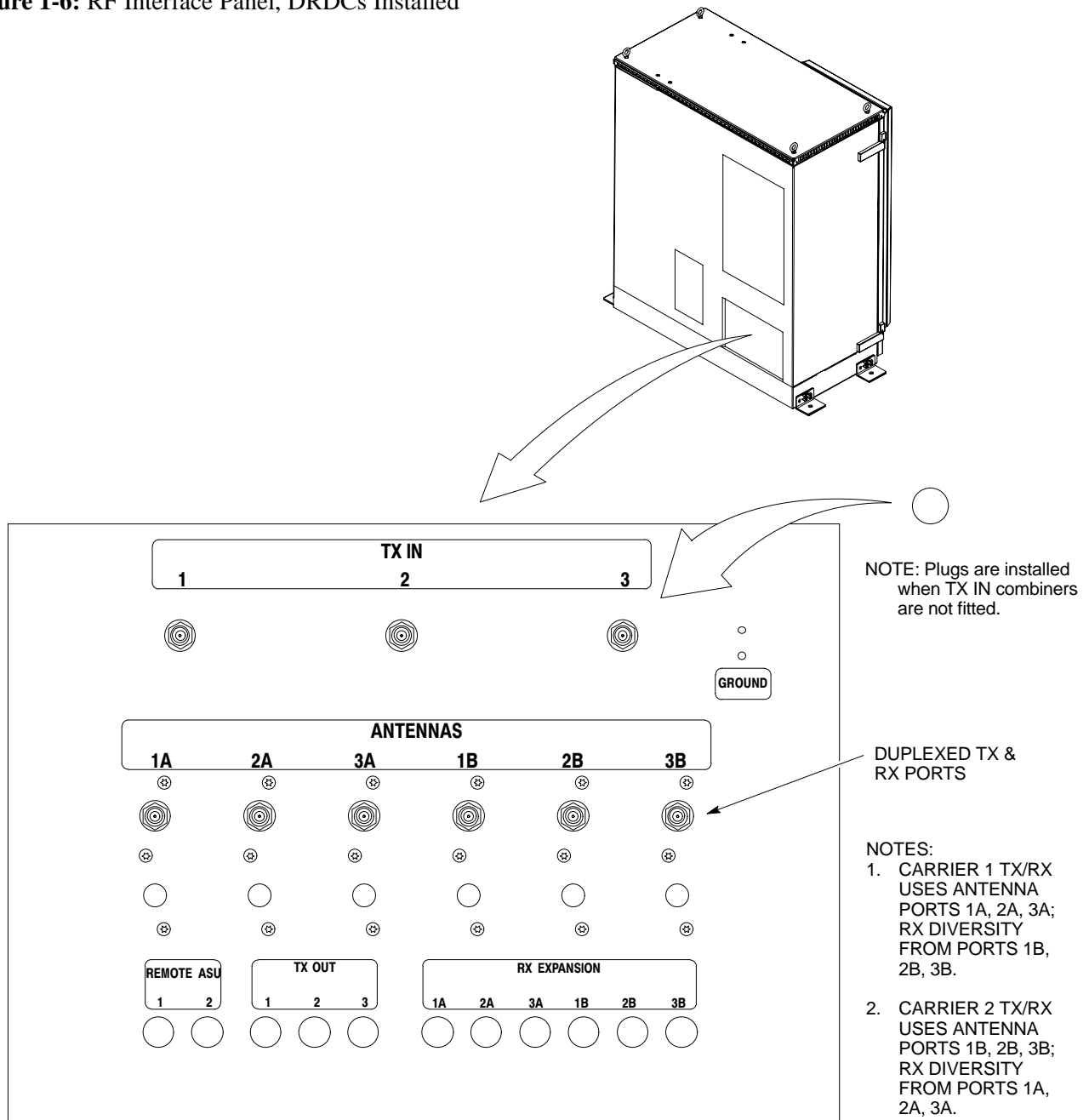

SC4812ETL0018-2

Internal Assembly Location and Identification – continued

Figure 1-7: RF Interface Panel, TRDCs Installed

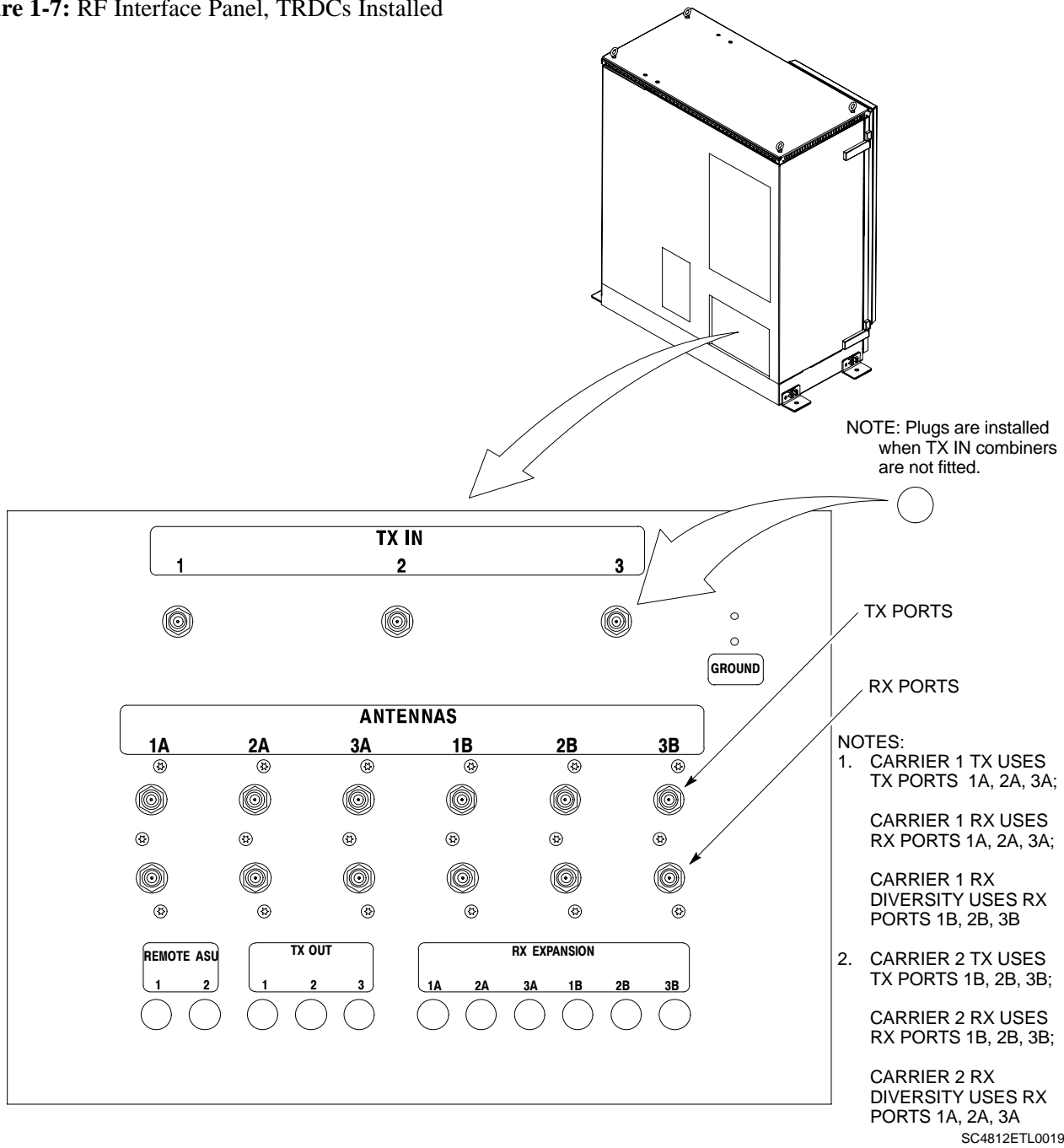
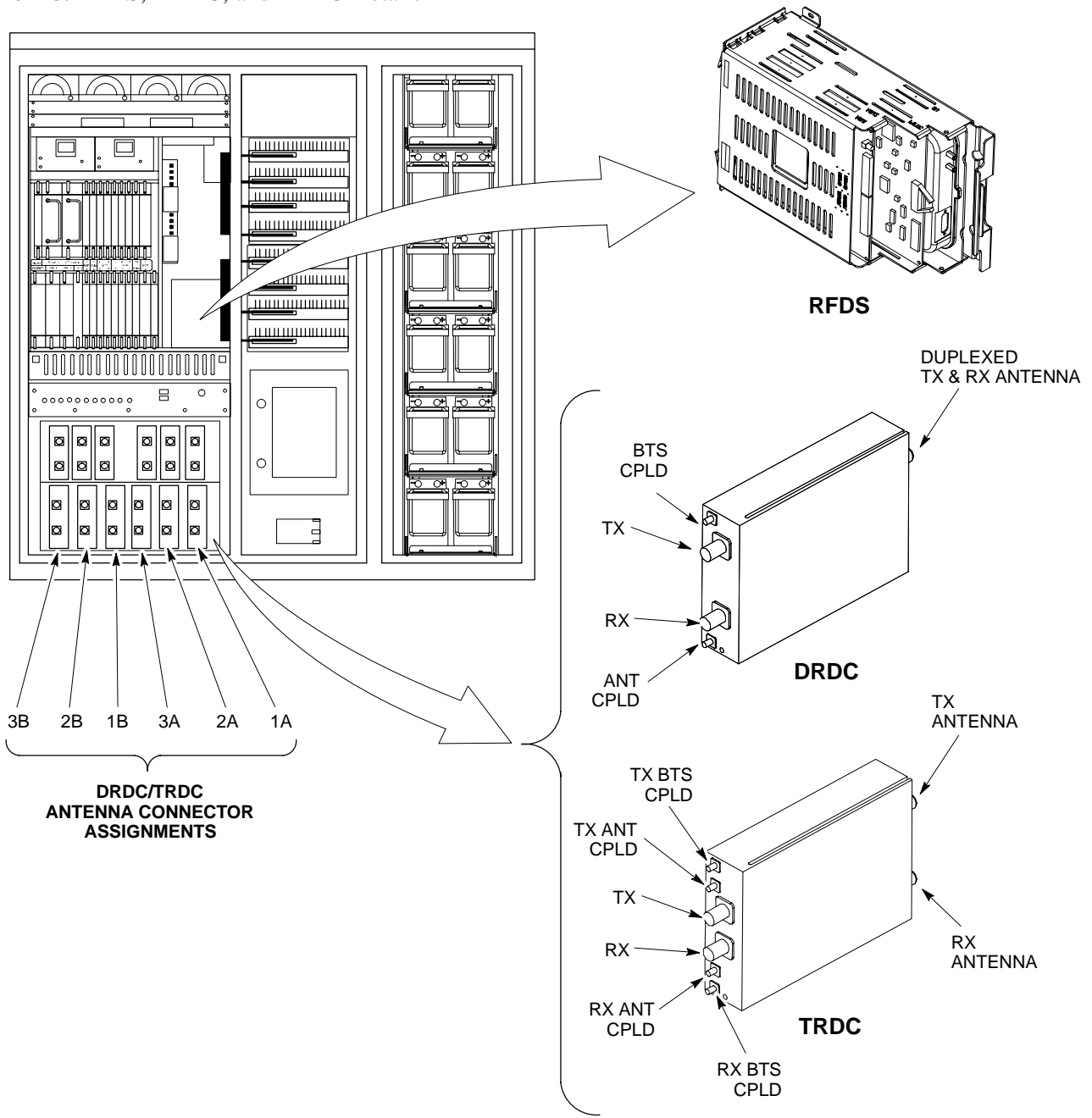

Figure 1-8: RFDS, DRDC, and TRDC Details



SC4812ETL0005-3

SCCP Cage Configuration and the 1X Devices

SC4812ET Lite frames have one SCCP cage which will support up to 4 MCC cards and 6 BBX cards.

MCC Cards

A BTS may be configured with a mix of MCC-8E, MCC-24, and MCC-1X cards. Any MCC card slot will support any of the three MCC types. For 1X capability under R16.0, at least one MCC card must be an MCC-1X which can be installed in any MCC card slot.

BBX Cards

Up to 6 BBX cards of mixed BBX2s and BBX-1Xs can also be supported. BBX card slots 1 through 6 are carrier- and sector-dependent. As a result, the BBX slots dedicated to the sectors for one carrier should be populated with the same type of cards. Refer to Table 1-5 for BBX card slot carrier and sector correlations.

The BBX-R1 card slot is dedicated to the *redundant* BBX. This slot will support either a BBX2 or a BBX-1X. If a cage has BBX-1X carriers, the redundant BBX (BBXR) *must* be a BBX-1X card to provide 1X redundancy support.

Sector Configuration

There are a number of ways to configure the BTS frame. Table 1-4 outlines the basic requirements. For more detailed information also see Table 1-5 and Figure 1-9. Bandpass filters are used for single-carrier configurations and two-carrier systems when carriers are either *adjacent* or *not adjacent*

Table 1-4: BTS Sector Configuration			
Number of Carriers	Number of Sectors	Channel Spacing	Filter/Combiner Requirements
1	3	N/A	Bandpass Filter
2	3	Adjacent or Non-adjacent	Bandpass Filter

The matrix in Table 1-5 shows the correlation between the various sector configurations and BBX cards.

BTS Sector Configurations – continued

Table 1-5: Sector Configurations							
Configuration	Description						
1	3-Sector / 1 Carrier						
	The configuration below maps RX and TX with bandpass filters for a 3-sector/1-carrier frame.						
	ANT 1A	ANT 2A	ANT 3A	ANT 1B	ANT 2B	ANT 3B	
	TX1 / RX1A	TX2 / RX2A	TX3 / RX3A	RX1B	RX2B	RX3B	Carrier #
BBX2-1	BBX2-2	BBX2-3	BBX2-1 (diversity RX)	BBX2-2 (diversity RX)	BBX2-3 (diversity RX)	1	
2	3-Sector / 2-ADJACENT or 2-NON-ADJACENT Carriers						
	The configuration below maps RX and TX with bandpass filters for 3-sectors/2-carriers for both <i>adjacent</i> and <i>non-adjacent</i> channels.						
	ANT 1A	ANT 2A	ANT 3A	ANT 1B	ANT 2B	ANT 3B	
	TX1 / RX1A	TX2 / RX2A	TX3 / RX3A	TX4 / RX1B	TX5 / RX2B	TX6 / RX3B	Carrier #
	BBX2-1	BBX2-2	BBX2-3	BBX2-1 (diversity RX)	BBX2-2 (diversity RX)	BBX2-3 (diversity RX)	1
BBX2-4 (RX)	BBX2-5 (RX)	BBX2-6 (RX)	BBX2-4 (TX & diversity RX)	BBX2-5 (TX & diversity RX)	BBX2-6 (TX & diversity RX)	2	

Figure 1-9: SC4812ET Lite LPA Configuration with Bandpass Filters (Starter Frame Mapping Only)

**Table 1-5
Configuration Numbers 1 and 2
Bandpass Filters
3-Sector**

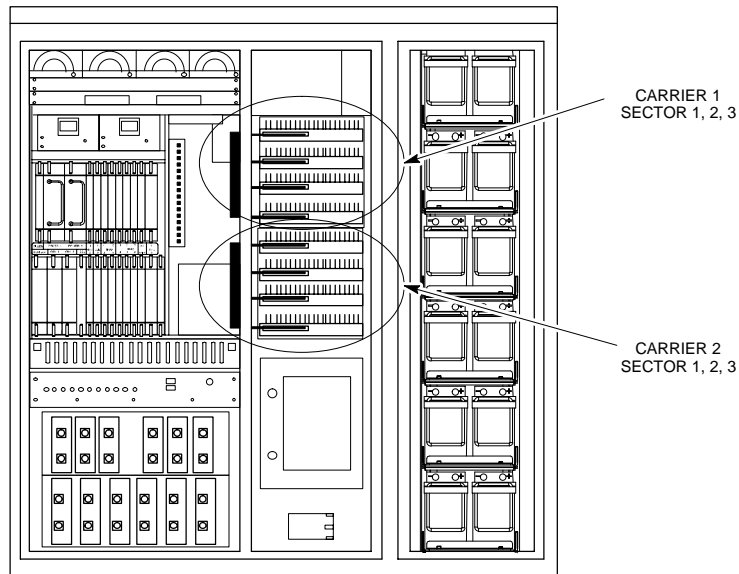

SC4812ETL0011-3

Chapter 2: Preliminary Operations

Table of Contents

Preliminary Operations: Overview	2-1
Introduction	2-1
Cellsite Types	2-1
CDF	2-1
Site Equipage Verification	2-1
Initial Installation of Boards/Modules	2-1
Setting Frame SCCP Configuration Switch	2-2
Ethernet LAN	2-3
Ethernet LAN Termination	2-3
Initial Power Up	2-4
Introduction	2-4
Required Tools	2-4
Cabling Inspection	2-4
Initial Inspection and Setup	2-4
DC Power System Pre-Power Application Test	2-7
External AC Power Connection Verification	2-9
Applying AC Power	2-12
DC Power Application and Testing	2-14
Battery Charge Test (Connected Batteries)	2-15
Battery Discharge Test	2-16
Power Removal Procedure	2-17

Preliminary Operations: Overview

Introduction

This section first verifies proper frame equipage. This includes verifying module placement, jumper, and dual in-line package (DIP) switch settings against the site-specific documentation supplied for each BTS application. Next, pre-power up and initial power-up procedures are presented.

Cellsite Types

Sites are configured as 3-sector with one or two carriers. Each type has unique characteristics and must be optimized accordingly.

CDF

The Cell-site Data File (CDF) contains site type and equipage data information and passes it directly to the CDMA Local Maintenance Facility (LMF) during optimization. The number of BTS frames, BBX2 and MCC24 boards, and linear power amplifier assignments are some of the equipage data included in the CDF.

Site Equipage Verification

Review the site documentation. Match the site engineering equipage data to the actual boards and modules shipped to the site. Physically inspect and verify the equipment provided for the frame.



CAUTION

Always wear a conductive, high impedance wrist strap while handling any circuit card/module to prevent damage by ESD. After removal, the card/module should be placed on a conductive surface or back into the anti-static bag it was shipped in.

Initial Installation of Boards/Modules

Table 2-1: Initial Installation of Boards/Modules

Step	Action
1	Refer to the site documentation and, if it was not previously done, slide all boards and modules into the appropriate shelves as required. DO NOT SEAT the boards and modules at this time.
2	As the actual site hardware is installed, record the serial number of each module on a “Serial Number Checklist” in the site logbook.

Setting Frame SCCP Configuration Switch

2

The backplane configuration switch is located behind the frame rear access panel. It must be set for the frame type as shown in Figure 2-1.

The switch setting must be verified and set before power is applied to the BTS equipment.

Figure 2-1: Backplane DIP Switch Settings

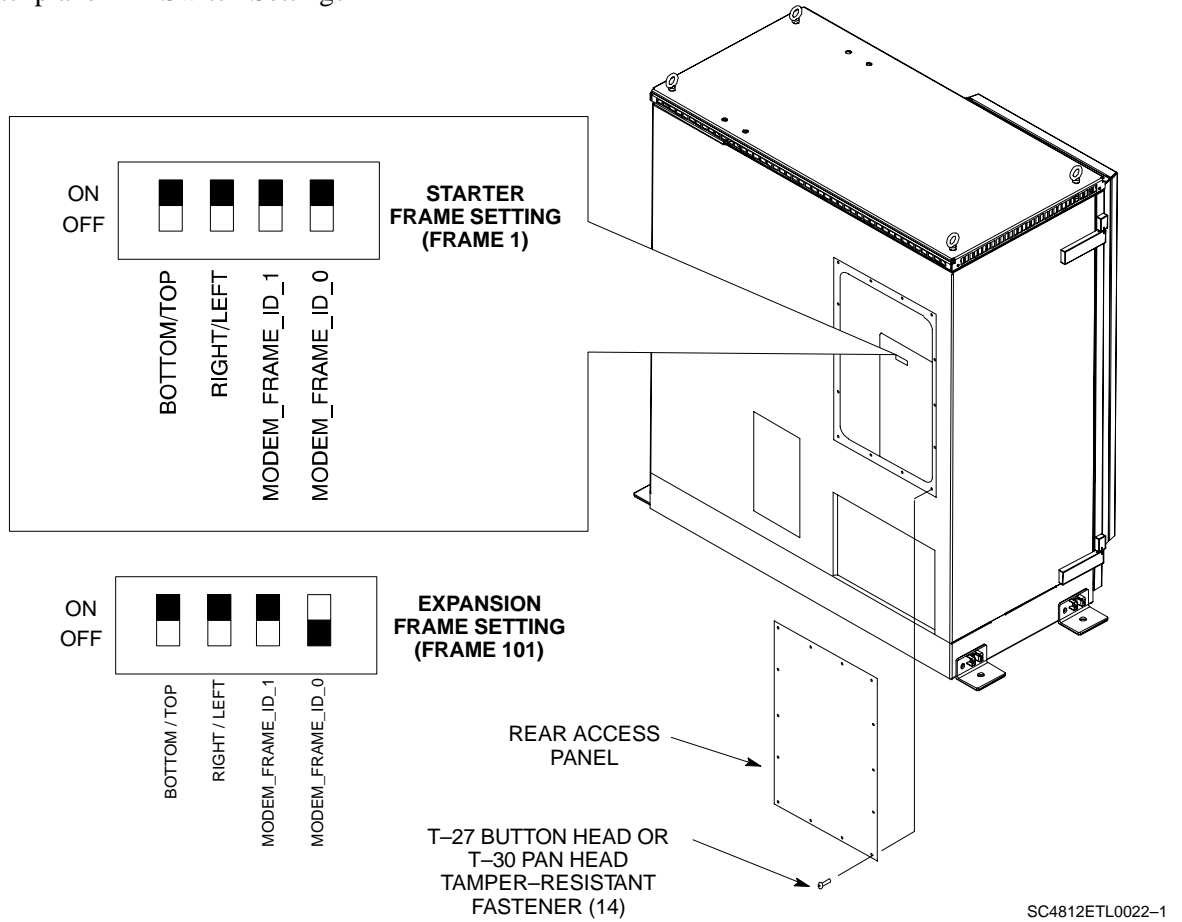

Ethernet LAN

Ethernet LAN Termination

For proper operation, each end of the primary and redundant BTS Ethernet Local Area Networks (LAN) must be terminated with a 50-ohm load. For a BTS consisting of a single frame, this is done by placing 50-ohm triaxial terminations on the LAN A and B external IN and OUT connectors located in the power entry compartment (Figure 2-2). When the LAN links multiple frames in a logical BTS, the 50-ohm triaxial terminations must be installed on *all uncabled* LAN A and B external connectors *on each frame*.

Check the LAN A and B external IN and OUT connectors in the power entry compartment of each frame, and be sure terminations are installed on all the uncabled external LAN connectors.

Figure 2-2: External Ethernet LAN Connectors

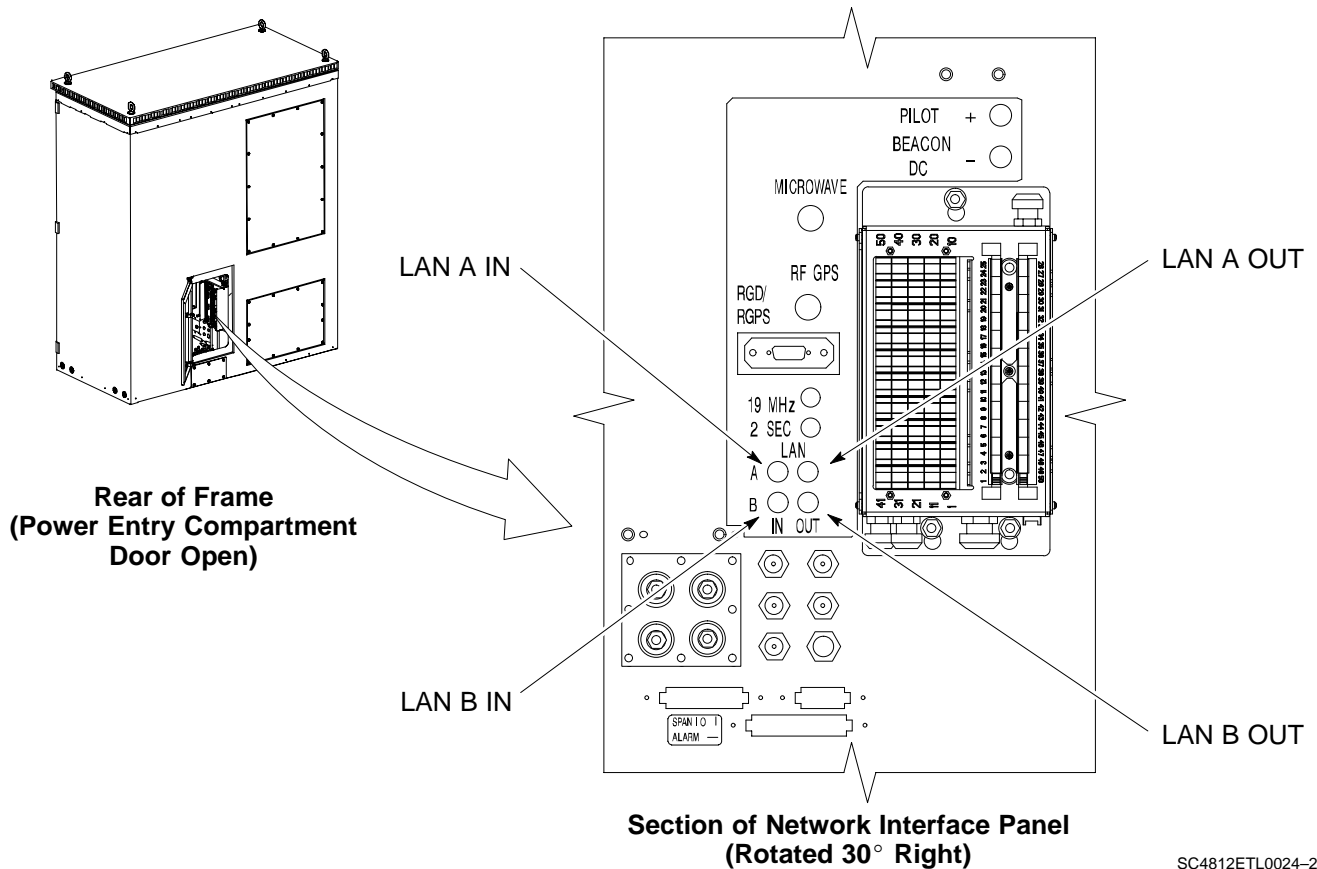

SC4812ETL0024-2

Initial Power Up

Introduction

The following information is used to check for any electrical short circuits and to verify the operation and tolerances of the cell site and BTS power supply units before applying power for the first time. It contains instructional information on the proper initial power up procedures for the SC4812ET Lite for both the North American version and the International version. If directions are different for either version, they are called out within the procedure. Please pay attention to all cautions and warning statements in order to prevent accidental injury to personnel.

Required Tools

The following tools are used in the procedures.

- Clamp-on DC current probe (600 amp capability with jaw size to accommodate 2/0 cable).
- Digital Multimeter (DMM) with standard 2mm (.080”) tip probes
- Hot Air Gun – (optional for part of the Alarm Verification)

Cabling Inspection

Using the site-specific documentation generated by Motorola Systems Engineering, verify that the following cable systems are properly connected:

- Receive RF cabling – up to six RX cables
- Transmit RF cabling – up to six TX cables



IMPORTANT

For DC power applications (+27 V):

- The positive power cable is red.
- The negative power cable is black. (The black power cable is at ground potential.)

Initial Inspection and Setup



CAUTION

Ensure all battery shelf circuit breakers (Figure 2-3) for unused battery positions are off (pulled out) before and during the entire power up process. Leave these breakers in the off position when leaving the site.

Table 2-2: Initial Inspection and Setup

Step	Action
1	Be sure that the facility circuit breaker controlling external AC power supplied to the frame is set to OFF .
2	Be sure that <i>all</i> AC Load Center (ACLC), <i>all</i> DC Power Distribution Assembly (PDA), and <i>all</i> battery shelf circuit breakers are turned OFF .

. . . continued on next page

Initial Power Up – continued

Table 2-2: Initial Inspection and Setup	
Step	Action
3	Confirm that the Meter Alarm Panel (MAP) POWER switch and all LEDs (Figure 2-9) are OFF . If any LEDs are lighted, re-check and turn OFF all battery shelf circuit breakers.
4	If a heat source was placed in the RF compartment to prevent condensation prior to BTS power-up, turn off the heat source and remove it and any associated cabling from the BTS before proceeding.
5	Confirm that the external 220 Vac supply is correctly connected to the ACLC input by performing the procedure in Table 2-4.

Figure 2-3: Frame Power Subassemblies, North American and International Cabinets

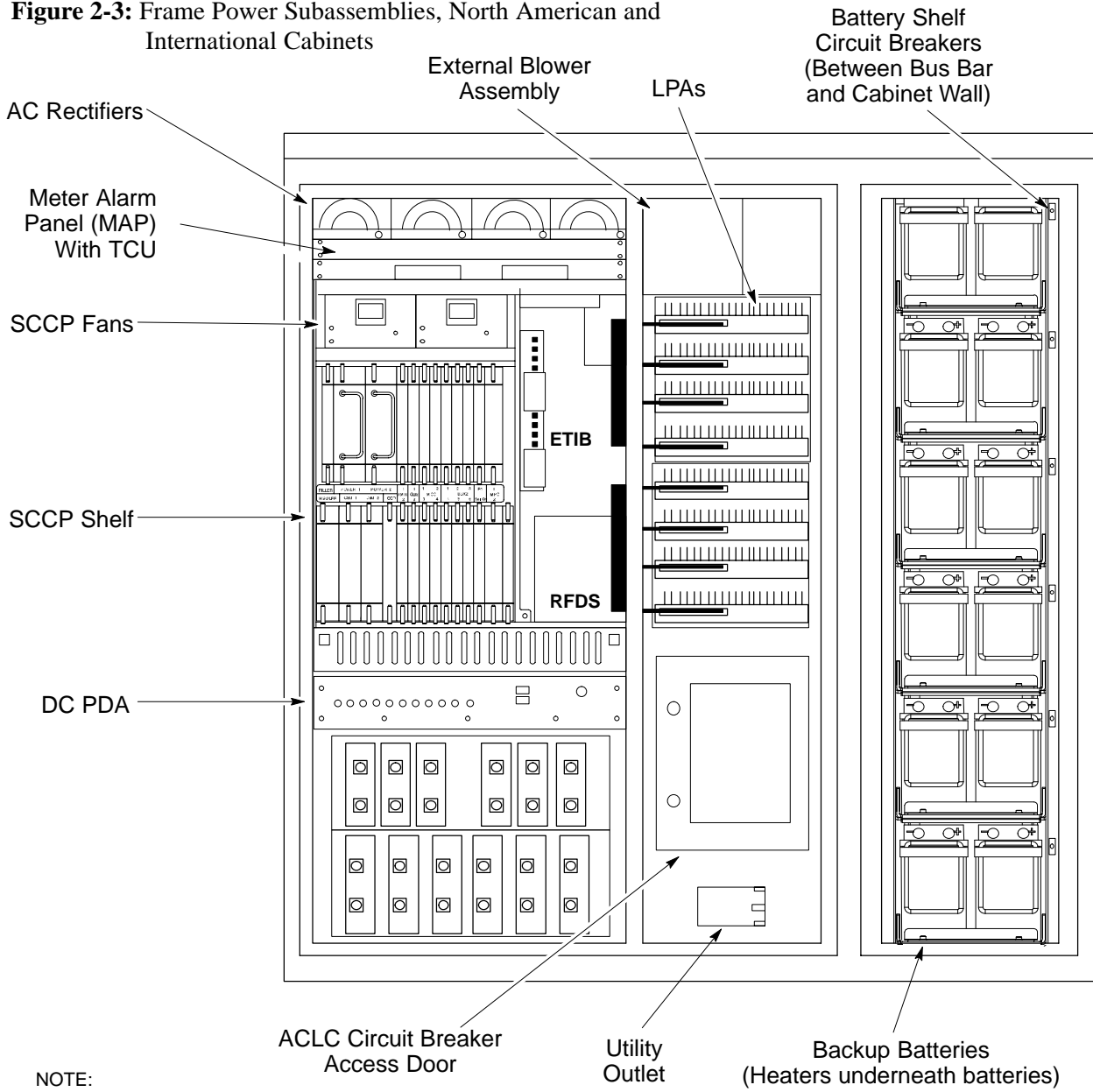

NOTE:
 GFCI capability is built into the Utility Outlet of the North American Cabinet.
 GFCI capability is built into the circuit breakers of the International Cabinet

SC4812ETL0002-3

2

Figure 2-4: ACLC Circuit Breaker Panel – North American

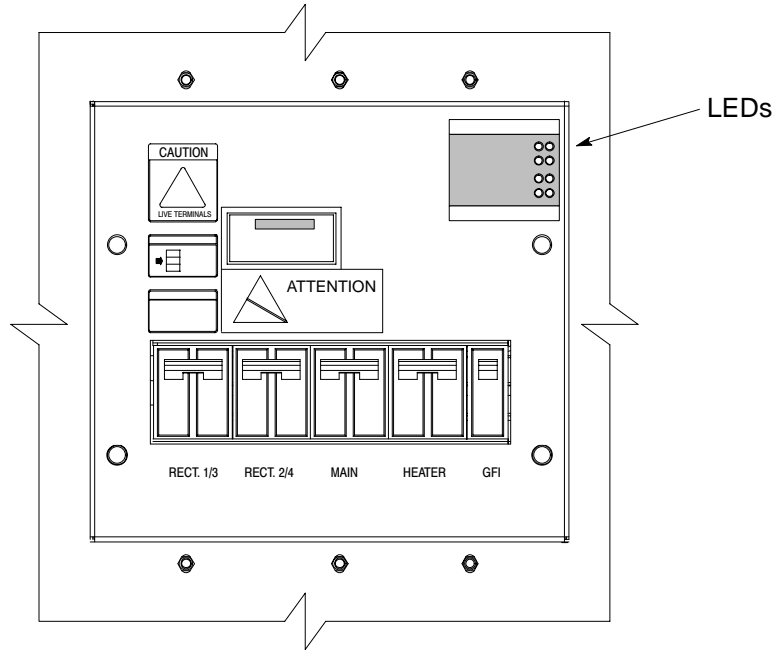

SC4812ETL0008-1

Figure 2-5: ACLC Circuit Breaker Panel – International

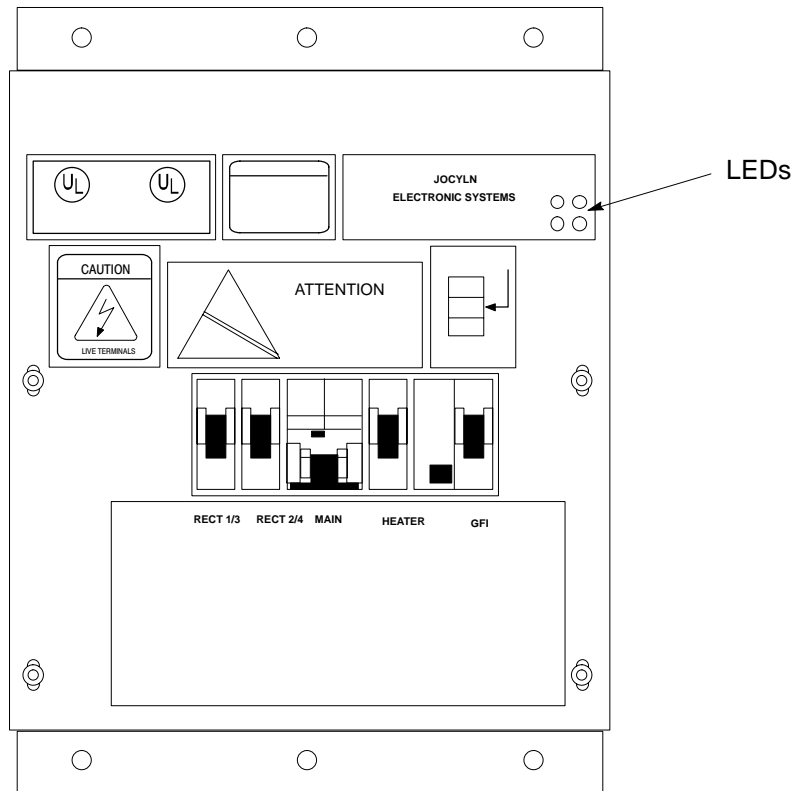

Initial Power Up – continued

Figure 2-6: DC PDA

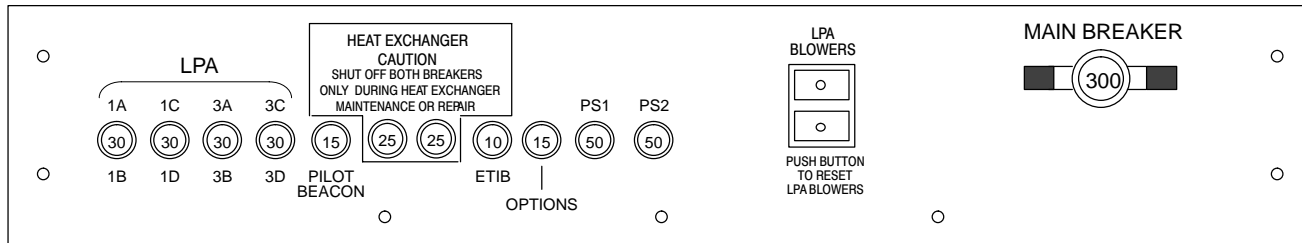

SC4812ETL0009-3

DC Power System Pre-Power Application Test

Before applying any power to the BTS frame, follow the procedure in Table 2-3 to verify there are no shorts in the DC power distribution system.

NOTE

The procedure in Table 2-3 is required only on initial BTS power-up or following maintenance when any major power components (e.g., ACLC, DC PDA, Meter Alarm Panel) were replaced or internal DC power cables were disconnected.

Table 2-3: DC Power System Pre-Power Application Test

Step	Action
1	Physically verify all ACLC front-panel circuit breakers (Figure 2-4) are OFF (down), all DC PDA circuit breakers (Figure 2-6) are set to OFF (pulled out), and all battery shelf circuit breakers (Figure 2-3) are OFF (pulled out).
2	Visually ensure that all AC rectifier modules (Figure 2-3) are <i>not</i> powered (DC, PWR, and bar graph LEDs are <i>not</i> lighted), that the MAP power switch (Figure 2-9) is OFF , and that no LEDs on the MAP are lighted.
3	Inside the battery compartment, measure the <i>voltage</i> between the + (red) and – (black) battery bus bars. There should be no 27 Vdc present.

... continued on next page

2

Table 2-3: DC Power System Pre-Power Application Test

Step	Action
4	<p>* IMPORTANT</p> <p>Do not unseat the AC rectifier modules in the following step.</p> <p>Perform the following:</p> <ul style="list-style-type: none"> • <i>In the frame RF compartment</i>, unseat all circuit boards/ modules (except CCD and CIO cards) in the SCCP shelf, but leave them in their respective slots. • <i>In the frame LPA compartment</i>, disconnect the Linear Power Amplifier (LPA) cables from the compartment bulkhead feed through connector.
5	<p>Set the DMM to measure resistance, and inside the battery compartment, measure the resistance between the + (red) and – (black) battery bus bars. The resistance should measure $\geq 1\text{ M}\Omega$.</p>
6	<p>Leave the DMM set to measure resistance, and insert the probes into the MAP VOLT and AMP TEST POINTS (Figure 2-9). Place the (+) DMM probe into the (–) AMP TEST POINT. Place the (–) DMM probe into the (–) VOLT TEST POINT. Resistance should measure greater than 750 Ω.</p>
7	<p>On the DC PDA, set the MAIN BREAKER to the ON position by pushing it in. Resistance between the MAP (–) VOLT TEST POINT and the (–) AMP TEST POINT should measure between 300 Ω minimum 900 Ω maximum.</p>
8	<p>Before proceeding, be sure the SCCP shelf power/converter modules PS1 and PS2 are correct by verifying that the locking/retracting tabs appear as follows:</p> <p>–  (in +27 volt systems)</p> <p>! CAUTION</p> <p>Using the incorrect type of power/converter modules will damage the module, the SCCP shelf, and other modules installed in the SCCP shelf.</p>
9	<p>* IMPORTANT</p> <p>In the following steps, if the DMM reads between 300 Ω minimum and 900 Ω maximum after inserting any board/module, a low impedance problem probably exists in that board/module. Replace the suspect board/module and repeat the test. If test still fails, isolate the problem before proceeding.</p> <p>Insert and lock the PS1 DC–DC converter module into its slot, and and turn ON the PS1 DC circuit breaker on the DC PDA.</p>
10	<p>Resistance between the MAP (–) VOLT TEST POINT and the (–) AMP TEST POINT should typically increase as capacitors charge, finally measuring between 300 Ω minimum and 900 Ω maximum.</p>
11	<p>Repeat steps 9 and 10 for the PS2 converter module/circuit breaker and all other remaining modules in the SCCP shelf.</p>
12	<p>On the DC PDA, set the LPA 1A–1B circuit breaker to the ON position <i>by pushing it in</i>, and repeat step 10.</p>
13	<p>Repeat step 12 for each of the three remaining LPA circuit breakers.</p>

... continued on next page

Table 2-3: DC Power System Pre-Power Application Test

Step	Action
14	<p><i>Carefully</i> reconnect each LPA cable <i>one at a time</i>. Repeat step 10 after reconnecting each cable.</p> <ul style="list-style-type: none"> A typical response is that the ohmmeter will steadily climb in resistance as module input capacitors charge, finally indicating between 300 Ω minimum and 900 Ω maximum.
15	Set the Pilot Beacon, <i>both</i> Heat Exchanger, ETIB, and Options circuit breakers to ON <i>one at a time</i> . Repeat step 10 after pushing in each circuit breaker.
16	Set all DC PDA circuit breakers to OFF (pulled out).



CAUTION

Failure to properly connect the external AC power cable will damage the surge protection module inside the ACLC.

External AC Power Connection Verification

Following verification of frame DC power system integrity, external AC power connections must be verified. To accomplish this, the series of AC voltage measurements specified in Table 2-4 is required.

Table 2-4: AC Voltage Measurements

Step	Action
1	<p>NOTE This procedure is required only after external AC power wiring has been initially connected or removed and reconnected to the frame.</p> <p>Δ WARNING Ensure the frame is <i>unpowered</i> by setting the facility circuit breaker controlling external AC power supplied to the frame to OFF.</p> <p><i>Physically verify all</i> DC PDA circuit breakers are set to OFF (pulled out), and <i>all</i> battery shelf circuit breakers are OFF (pulled out).</p>
2	Open the ACLC circuit breaker access door, and set all ACLC circuit breakers to OFF (down).
3	Remove the four screws securing the ACLC front panel assembly, and remove the ACLC front panel assembly to gain access to the AC circuit breaker input terminals (Figure 2-8).
4	Apply external AC power to the frame by setting the facility circuit breaker to ON .

... continued on next page

Table 2-4: AC Voltage Measurements

Step	Action
5	<p>! CAUTION North AMERICAN Cabinet only: If the AC voltages measured in the following steps exceed 120 V when measuring from terminals L1 or L2 to neutral or ground, STOP and DO NOT proceed until the cause of the higher voltages are determined. The frame will be damaged if the Main breaker is turned on with excessive voltage on the inputs.</p> <p>Measure the AC voltage from terminal L1 to neutral. North American Cabinet:</p> <ul style="list-style-type: none"> • Voltage should be in the nominal range of 115 to 120 Vac. <p>International Cabinet:</p> <ul style="list-style-type: none"> • Voltage should be in the nominal range of 210 to 240 Vac.
6	<p>Measure the AC voltage from terminal L1 to ground. North American Cabinet:</p> <ul style="list-style-type: none"> • Voltage should be in the nominal range of 115 to 120 Vac. <p>International Cabinet:</p> <ul style="list-style-type: none"> • Voltage should be in the nominal range of 210 to 240 Vac.
7	<p>Steps 7a through 7c apply to the North American cabinet only. If working on a International cabinet continue to step 8.</p>
7a	<p>Measure the AC voltage from terminal L2 to neutral on the North American cabinet.</p> <ul style="list-style-type: none"> • Voltage should be in the nominal range of 115 to 120 Vac.
7b	<p>Measure the AC voltage from terminal L2 to ground on the North American cabinet.</p> <ul style="list-style-type: none"> • Voltage should be in the nominal range of 115 to 120 Vac.
7c	<p>! CAUTION If the AC voltages measured (on the North American cabinet) in the following step exceeds 240 V when measuring between terminals L1 and L2, STOP and DO NOT proceed until the cause of the higher voltages are determined. The frame will be damaged if the Main breaker is turned on with excessive voltage on the inputs.</p> <p>Measure from terminal L1 to terminal L2.</p> <ul style="list-style-type: none"> • Voltage should be in the nominal range from 208 to 240 Vac.
8	<p>Remove external AC power from the frame by setting the facility circuit breaker to OFF.</p>
9	<p>Install the ACLC front panel assembly and secure with the four screws removed in step 1.</p>
10	<p>Apply external AC power to the frame by setting the facility circuit breaker to ON.</p>

Initial Power Up – continued

Figure 2-7: ACLC Voltage Measurement Probe Points – North American

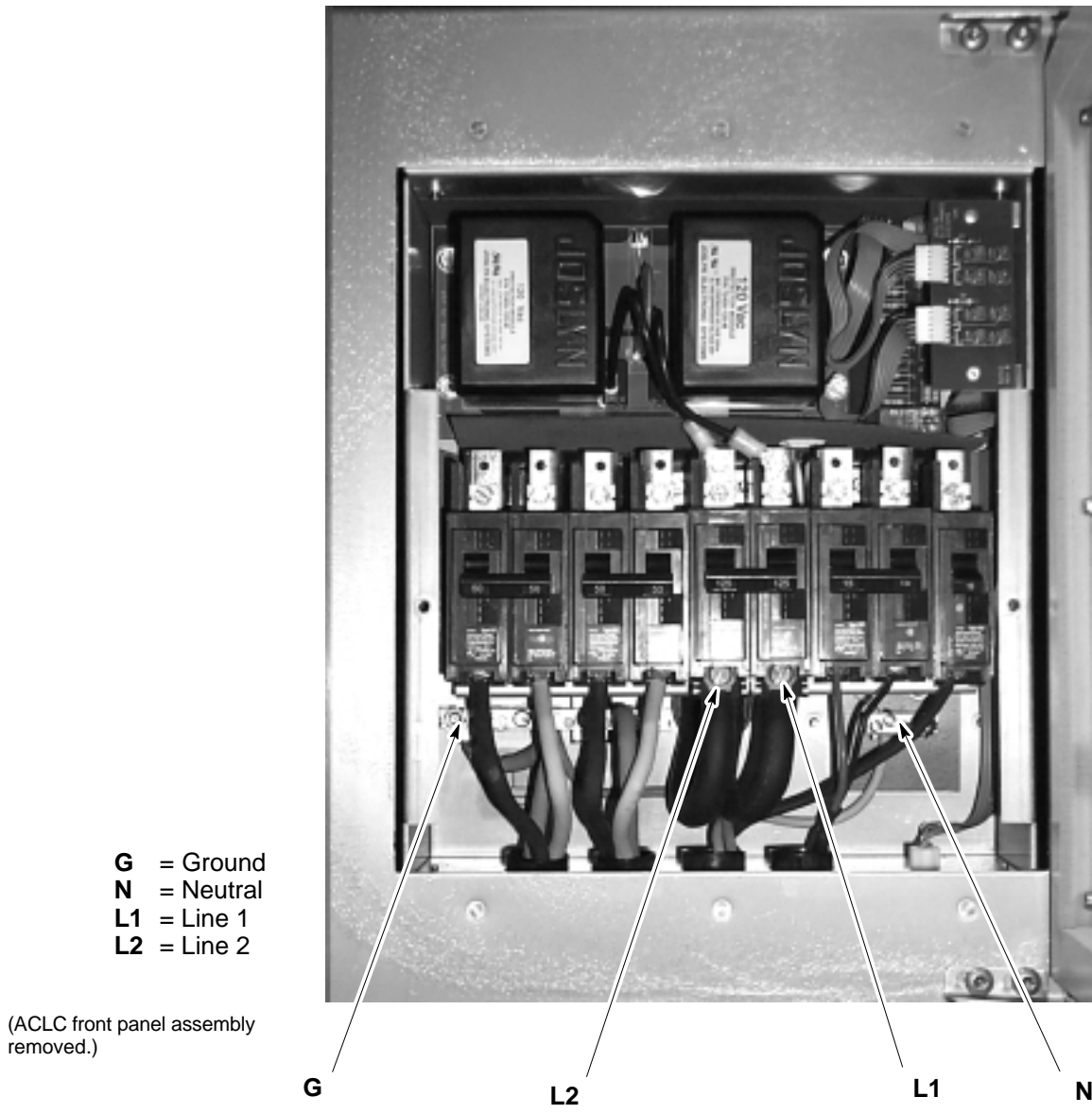
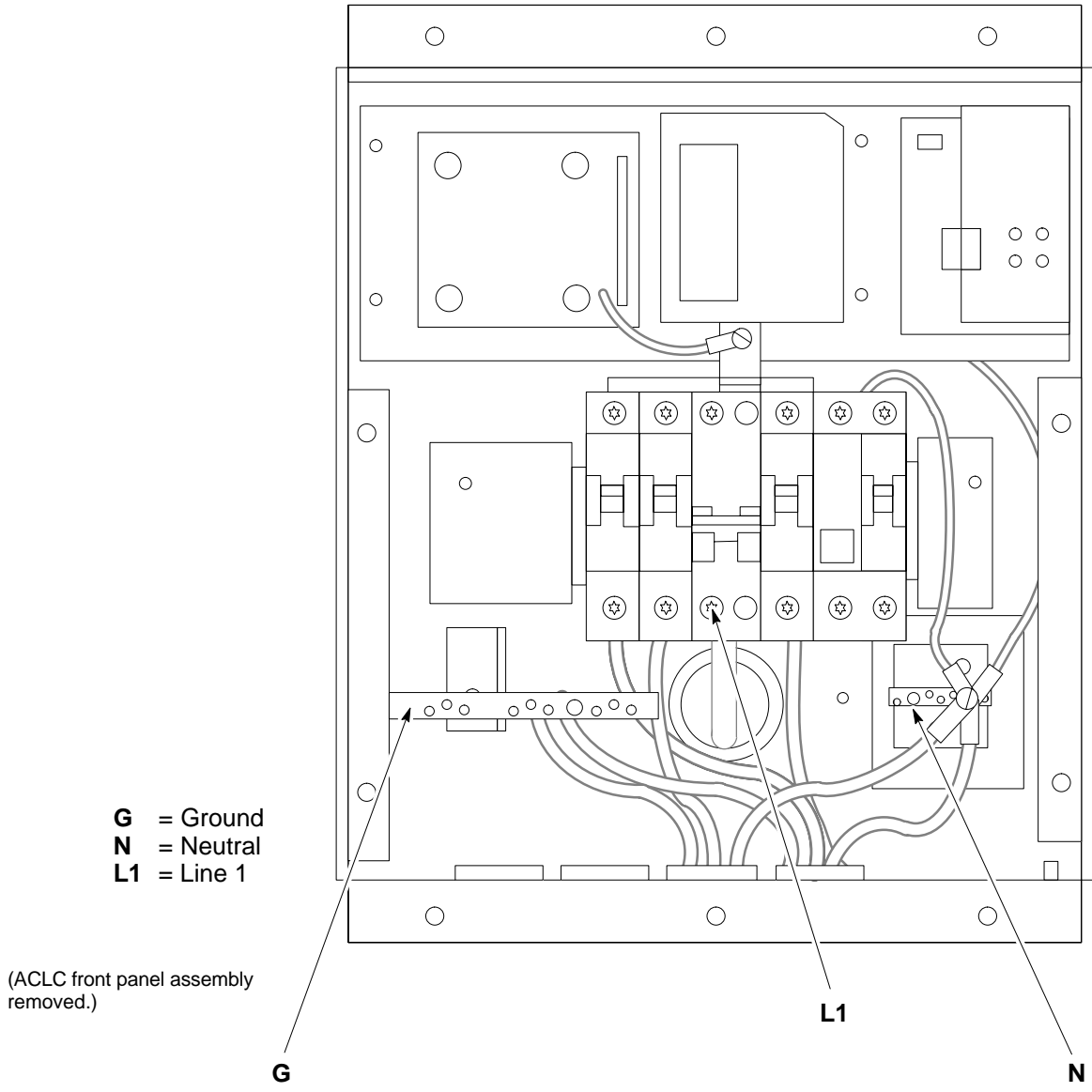

Figure 2-8: ACLC Voltage Measurement Probe Points – International



Applying AC Power

Once the external AC power connections are verified, AC power may be applied internally to the frame. Table 2-5 provides the procedure for applying internal AC power.

Step	Action
1	Be sure the requirements of Table 2-4 for AC input power connection verification have been met.
2	Be sure <i>all</i> DC PDA circuit breakers are set to OFF (pulled out), <i>all</i> ACLC front-panel circuit breakers are OFF (down), and <i>all</i> battery shelf circuit breakers are OFF (pulled out).

... continued on next page

Initial Power Up – continued

Table 2-5: Applying Internal AC Power

Step	Action
3	Be sure the MAP power switch, TCP switch, and BATT TEST switch are all set to OFF .
4	<i>If it has not already been done</i> , set the facility circuit breaker supplying AC power to the frame to ON .
5	Set the ACLC MAIN circuit breaker ON . <ul style="list-style-type: none"> For the North American cabinet: Observe that all eight (8) green LEDs on the front of the ACLC are illuminated (Figure 2-4). For the International cabinet: Observe that all four (4) green LEDs on the front of the ACLC are illuminated (Figure 2-4).
6	On the ACLC, set RECT. 1/3 and RECT. 2/4 branch circuit breakers ON . All the installed rectifier modules (Figure 2-3) will start up, and the green DC and PWR LEDs should light on each.
7	Set the MAP power switch to ON . The MAP VOLT display should read 27.4 ± 0.2 VDC with the TCP switch OFF . ! CAUTION Once power is applied to the MAP, be careful not to short either of the VOLT TEST POINTS to ground. Failure to comply will result in severe damage to the MAP.
8	On the MAP, set the TCP switch (Figure 2-9) to ON . Verify no alarm LEDs are lighted on the MAP. NOTE Depending on battery compartment temperature, the rectifier voltage displayed on the MAP VOLT indicator may change by as much as ± 1.5 V when the TCP is set to on.
9	Check the rectifier current bar graph displays (green LED display on the rectifier module). None should be lighted at this time.
10	If batteries are fitted, set the ACLC HEATER circuit breaker to ON . NOTE The GFCI AC circuit breaker should remain OFF unless the GFCI outlet is in use.

Figure 2-9: Meter Alarm Panel (MAP)

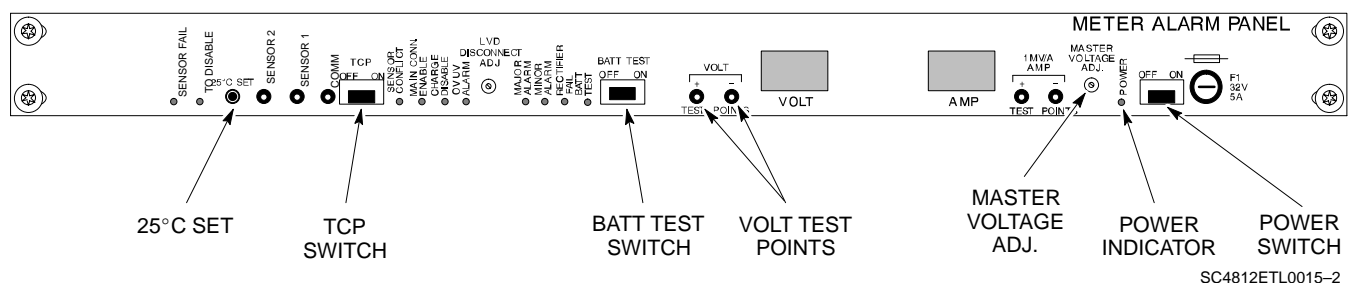

DC Power Application and Testing

Table 2-6 lists the step-by-step instructions for applying DC power and ensuring the DC power system components are correctly functioning.

Table 2-6: DC Power Application and Tests	
Step	Action
1	Be sure <i>all</i> DC PDA and battery shelf circuit breakers are OFF (pulled out).
2	Be sure the procedures in Table 2-3 (if applicable) and Table 2-5 have been performed.
3	<p>! CAUTION</p> <p>When measuring voltage at the VOLT TEST POINTS, be careful not to short either of the test points to ground. Failure to comply will result in severe damage to the MAP.</p> <p>Measure voltage at the MAP VOLT TEST POINTS while pressing the 25° C SET button (Figure 2-9). The voltage should read 27.4 ± 0.2 Vdc. Adjust with the MASTER VOLTAGE ADJ. on the MAP, if necessary, to obtain an indicated 27.4 ± 0.2 Vdc. Release the 25° C SET button.</p>
4	Depending on the ambient temperature, the voltage reading may now change by up to ± 1.5 V compared to the reading just measured. If it is cooler than 25°C, the voltage will be higher, and if it is warmer than 25°C, the voltage will be lower.
5	Inside the battery compartment, measure the voltage between the cable connection point at the bottom of the + (red) battery bus bar and chassis ground, observing that the polarity is correct. The voltage should be the same as the measurement in step 4.
6	Measure the voltage between the + (red) and – (black) battery bus bars in the battery compartment. Place the probe at the bottom of the bus bars where the cables are connected. The DC voltage should measure the same as in step 4.
7	Close (push in) DC PDA MAIN BREAKER.
8	<p><i>On the DC PDA (Figure 2-6)</i>, set the PS1 and PS2 circuit breakers to the ON position by pushing them in one at a time while observing the rectifier output current indicated on the MAP AMP display.</p> <p>– The display should indicate between 20 and 60 amps.</p>
9	<p><i>On the DC PDA</i>), set the <i>remaining</i> circuit breakers to the ON position by pushing them in one at a time <i>in the following sequence</i>:</p> <ul style="list-style-type: none"> • LPA circuit breakers (four breakers, labeled 1A–1B through 3C–3D). • HEAT EXCHANGER circuit breakers (two breakers) • ETIB circuit breaker • PILOT BEACON circuit breaker • OPTION circuit breaker

... continued on next page

Table 2-6: DC Power Application and Tests

Step	Action
10	<p>Confirm that the MAP AMP display continues to indicate between 20 and 60 amps during the initial power application.</p> <p>NOTE No battery charging or heavy RF loading is present at this point.</p>
11	<p><i>If the frame is not equipped with the pilot beacon option</i>, set the PILOT BEACON circuit breaker to OFF.</p>

**Battery Charge Test
(Connected Batteries)**

Table 2-7 lists the step-by-step instructions for testing the battery charging performance.

Table 2-7: Battery Charge Test (Connected Batteries)

Step	Action
1	<p>Close the battery shelf circuit breakers (Figure 2-3) for connected batteries <i>only</i>. This process should be completed quickly to avoid individual battery strings drawing excess charge current</p> <p>NOTE If the batteries are sufficiently discharged, the battery circuit breakers may not engage individually due to the surge current. If this condition occurs, disconnect the batteries from the 27Vdc bus by setting the MAP power switch to OFF, and then engage all the connected battery circuit breakers. The MAP power switch should then be turned ON.</p>
2	<p>Using the clamp-on DC current probe and DMM, measure the current in each of the battery string connections to the battery bus bars. The charge current may initially be high but should quickly reduce in a few minutes if the batteries have a typical new-battery charge level.</p> <p>NOTE The MAP AMP display will indicate the total current output of the rectifiers during this procedure. As an alternative, the bar graph meters on the AC rectifier modules can be used as a rough estimate of the total battery charge current. Each rectifier module bar graph has eight (8) LED elements to represent the output current. Each illuminated LED element indicates that approximately 12.5% (1/8 or 8.75 Amps) of an individual rectifier’s maximum current output (70 Amps) is flowing.</p> <p>RECTIFIER BAR GRAPH EXAMPLE: Question: A system fitted with three (3) rectifier modules each have three bar graph LED elements illuminated. What is the total output current into the batteries? Answer: Each bar graph is indicating approximately 12.5% of 70 amps, therefore, 3 x 8.75 equals 26.25 amps per rectifier. As there are three rectifiers, the total charge current is equal to (3 x 26.25 A) 78.75 amps.</p> <p>This charge current calculation is only valid when the RF and LPA compartment electronics are not powered on, and the RF compartment heat exchanger is turned off. This can only be accomplished if the DC PDA MAIN BREAKER is set to OFF.</p>

. . . continued on next page

Table 2-7: Battery Charge Test (Connected Batteries)

Step	Action
3	The current in each string should be approximately equal (within ± 5 amps).
4	Allow a few minutes to ensure that the battery charge current stabilizes before taking any further action. Recheck the battery current in each string. If the batteries had a reasonable charge, the current in each string should reduce to less than 5 amps.
5	Recheck the DC output voltage. It should remain the same as measured in step 4 of the frame DC Power Application and Test (Table 2-6). NOTE If discharged batteries are installed, the MAP AMP display may indicate approximately 288 amps for a two-carrier frame (four rectifiers) or 216 amps for a single-carrier frame (three rectifiers). Alternately, all bar graph elements may be lighted on the rectifiers during the charge test. Either indication shows that the rectifiers are at full capacity and are rapidly charging the batteries. It is recommended in this case that the batteries are allowed to charge and stabilize as in the above step before commissioning the site. This could take several hours.

Battery Discharge Test

Perform the test procedure in Table 2-8 only when the battery current is less than 5 Amps per string. Refer to Table 2-7 on the procedures for checking current levels.

Table 2-8: Battery Discharge Test

Step	Action
1	Turn the BATT TEST switch on the MAP ON (Figure 2-9). The rectifier output voltage and current should decrease by approximately 10% as the batteries assume the load. Alarms for the MAP may occur.
2	Measure the individual battery string current using the clamp-on DC current probe and DMM. The battery discharge current in each string should be approximately the same (within ± 5 amps).
3	Turn BATT TEST switch OFF .



CAUTION

Failure to *turn off* the MAP BATT TEST switch before leaving the site will result in low battery capacity and reduce battery life.

Power Removal Procedure

If it becomes necessary to remove power from the frame, follow the procedure in Table 2-9.

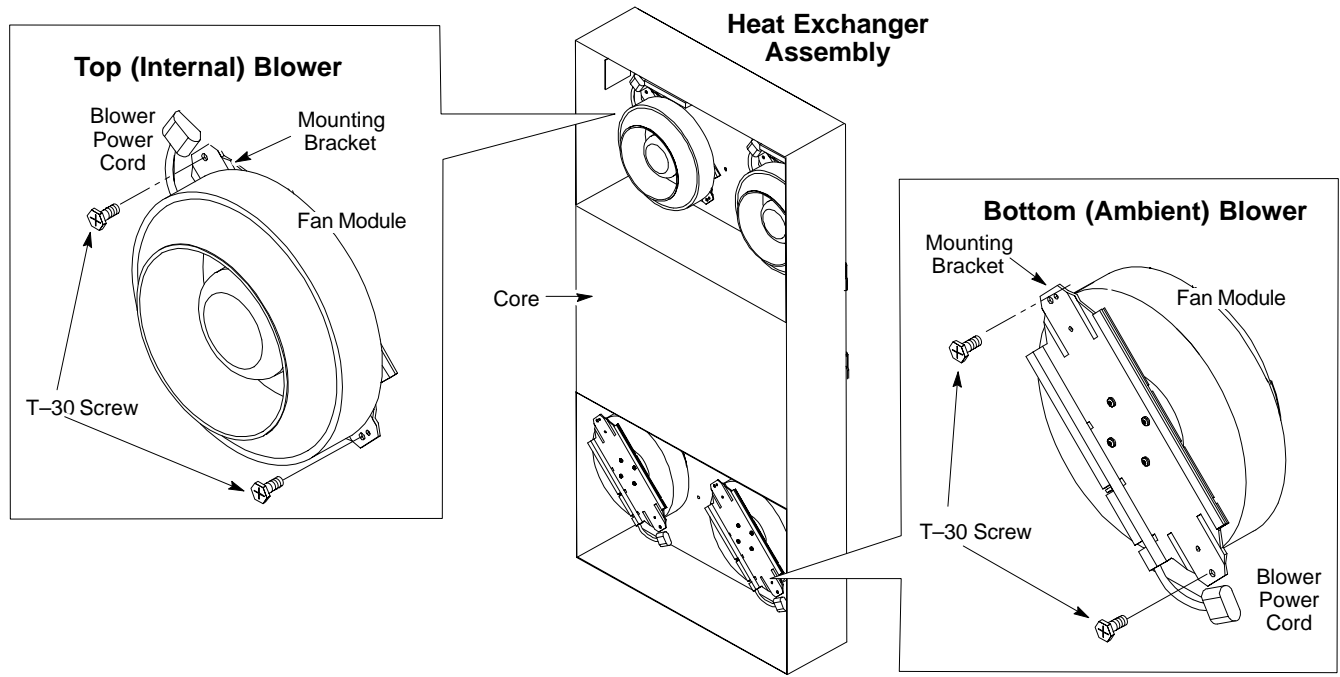

Table 2-9: Power Removal

Step	Action
1	Set all DC PDA circuit breakers to OFF (pulled out) in the following sequence: <ul style="list-style-type: none"> – LPAs – Pilot beacon – Heat exchanger – ETIB – Options – PS1 and PS2 – MAIN BREAKER #1 (Internal)
2	<p>Δ WARNING</p> <p>The surge capacitors in the DC PDA will store a large electrical charge for long periods of time. Failure to discharge these capacitors as specified in this step could result in serious personal injury or damage to equipment.</p> <p>On the DC PDA, set the PS1 and PS2 circuit breakers to ON (pushed in), and <i>wait at least 30 seconds</i>.</p>
3	Set the DC PDA PS1 and PS2 circuit breakers to OFF .
4	Set the MAP power switch to OFF .
5	Set all ACLC circuit breakers to OFF (down) in the following sequence: <ul style="list-style-type: none"> – GFI – HEATER – RECT. 1/3 – RECT. 2/4 – MAIN
6	Set the facility circuit breaker controlling external power to the frame to OFF .

2

Figure 2-10: Heat Exchanger Blower Assembly and Circuit Breakers



DC PDA

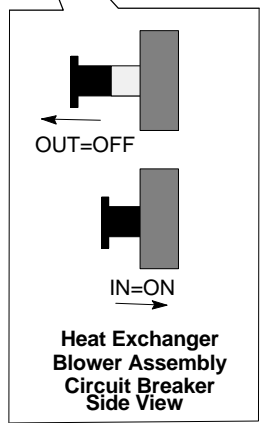
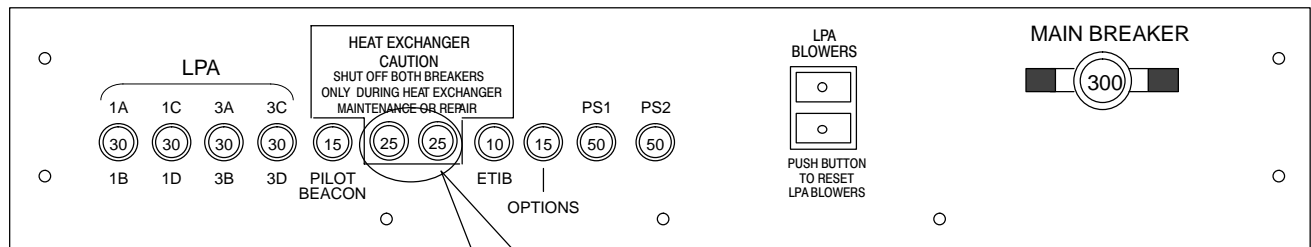

SC4812ETL0016-3

Chapter 3: Optimization/Calibration

Table of Contents

Optimization/Calibration – Introduction	3-1
Introduction	3-1
Optimization Process Overview	3-1
Cell Site Types	3-2
Cell Site Data File (CDF)	3-2
CDF Site Equipage Verification	3-3
BTS System Release Software Download	3-3
Preparing the LMF	3-4
Overview	3-4
LMF Installation and Update Procedures	3-4
Copy CBSC CDF Files to the LMF Computer	3-5
Creating a Named HyperTerminal Connection for MMI Communication	3-7
Folder Structure Overview	3-9
wlmf Folder	3-9
cdma Folder	3-9
bts–nnn Folders	3-9
bts–nnn.cal File	3-10
bts–nnn.cdf File	3-10
cbsc File	3-11
loads Folder	3-11
version Folder	3-11
code Folder	3-11
data Folder	3-12
Span Lines – Interface and Isolation	3-14
T1/E1 Span Interface	3-14
Isolate BTS from T1/E1 Spans	3-14
T1/E1 Span Isolation	3-15
Configure Optional Channel Service Units	3-15
Alarm and Span Line Cable Pin/Signal Information	3-17
LMF to BTS Connection	3-20
LMF to BTS Connection	3-20
Using CDMA LMF	3-21
Basic CDMA LMF Operation	3-21
CDMA LMF and Logical BTS	3-21
Logging Into a BTS	3-22

Logging Out	3-24
Establishing an MMI Communication Session	3-26
Online Help	3-27
Pinging the Processors	3-28
Pinging the BTS	3-28
Download the BTS	3-31
Overview	3-31
Verify GLI ROM Code Loads	3-32
Download RAM Code and Data to MGLI and GLI	3-33
Download RAM Code and Data to Non-GLI Devices	3-33
Select CSM Clock Source	3-34
Enable CSMs	3-35
Enable MCCs	3-36
CSM System Time – GPS & LFR/HSO Verification	3-37
Clock Synchronization Manager (CSM) System Time	3-37
Low Frequency Receiver/ High Stability Oscillator	3-37
CSM Frequency Verification	3-39
Test Equipment Setup (GPS & LFR/HSO Verification)	3-39
GPS Initialization/Verification	3-40
LORAN-C Initialization/Verification	3-45
Test Equipment Setup	3-47
Connecting Test Equipment to the BTS	3-47
Equipment Warm-up	3-49
Test Set Calibration	3-55
Background	3-55
Purpose	3-55
Selecting Test Equipment	3-56
Manually Selecting Test Equipment in a Serial Connection Tab	3-56
Automatically Selecting Test Equipment in a Serial Connection Tab ..	3-57
Calibrating Test Equipment	3-58
Calibrating Cables – Overview	3-58
Calibrating Cables with a CDMA Analyzer	3-59
Calibrating TX Cables Using a Signal Generator and Spectrum Analyzer	3-60
Calibrating RX Cables Using a Signal Generator and Spectrum Analyzer	3-61
Setting Cable Loss Values	3-62
Setting TX Coupler Loss Value	3-63
Bay Level Offset Calibration	3-64
Introduction	3-64
RF Path Bay Level Offset Calibration	3-64
When to Calibrate BLOs	3-64
TX Path Calibration	3-65
RX Path Calibration	3-65

Table of Contents – continued

BLO Calibration Data File	3-66
Test Equipment Setup: RF Path Calibration	3-68
Transmit (TX) Path Calibration	3-69
TX Calibration Test	3-71
Download BLO Procedure	3-72
Calibration Audit Introduction	3-73
Transmit (TX) Path Audit	3-73
TX Audit Test	3-74
Create CAL File	3-75
RFDS Setup and Calibration	3-76
RFDS Description	3-76
RFDS Parameter Settings	3-76
RFDS TSU NAM Programming	3-78
Explanation of Parameters used when Programming the TSU NAM ..	3-78
Valid NAM Ranges	3-79
Set Antenna Map Data	3-80
Set RFDS Configuration Data	3-81
RFDS Calibration	3-82
Program TSU NAM	3-84
Alarms Testing	3-85
Alarm Verification	3-85
Alarm Reporting Display	3-85
Alarm Testing Set-up	3-86
Heat Exchanger Alarm Test	3-86
Door Alarm	3-86
AC Fail Alarm	3-87
Minor Alarm	3-87
Rectifier Alarms	3-87
Single Rectifier Failure (Three Rectifier System)	3-87
Multiple Rectifier Failure (Three Rectifier System)	3-88
Single Rectifier Failure (Four Rectifier System)	3-89
Multiple Rectifier Failure (Four Rectifier System)	3-90
Battery Over Temperature Alarm (Optional)	3-90
Rectifier Over Temperature Alarm	3-93
Before Leaving the site	3-93

Introduction

This chapter provides procedures for downloading system operating software, set up of the supported test equipment, CSM reference verification/optimization, and transmit/receive path verification.



IMPORTANT

Before using the LMF, use an editor to view the "CAVEATS" section in the "readme.txt" file in the c:\wlmf folder for any applicable information.

Optimization Process Overview

After a BTS is physically installed and the preliminary operations, such as power up, have been completed, the CDMA LMF is used to calibrate and optimize the BTS. The basic optimization process consists of the following:

- Download MGLI2 (GLI2-<bt#>-1) with application code and data and then enable MGLI2.
- Use the CDMA LMF status function and verify that all of the installed devices of the following types respond with status information: CSM2, BBX2, GLI2, and MCC (and TSU if RFDS is installed). If a device is installed and powered up but is not responding and is colored gray in the BTS display, the device is not listed in the CDF file. The CDF file will have to be corrected before the device can be accessed by CDMA LMF.
- Download device application code and data to all devices of the following types:
 - CSM2
 - BBX2
 - Remaining GLI2 (GLI2-<bt#>-2)
 - MCC
- Download the RFDS TSIC (if installed).
- Verify the operation of the GPS and HSO signals.
- Enable the following devices (in the order listed):
 - Secondary CSM (slot 2)
 - Primary CSM (slot 1)
 - All MCCs
- Using the CDMA LMF test equipment selection function, select the test equipment to be used for the calibration.
- Calibrate the TX and RX test cables if they have not previously been calibrated using the CDMA LMF that is going to be used for the optimization/calibration. Cable calibration values can be entered manually, if required.
- Connect the required test equipment for a full optimization.

- Select all of the BBXs and all of the MCCs and use the full optimization function. The full optimization function performs TX calibration, BLO download, TX audit, all TX tests, and all RX tests for all selected devices.
- If the TX calibration fails, repeat the full optimization for any failed paths.
- If the TX calibration fails again, correct the problem that caused the failure and repeat the full optimization for the failed path.
- If the TX calibration and audit portion of the full optimization passes for a path but some of the TX or RX tests fail, correct the problem that caused the failure and run the individual tests as required until all TX and RX tests have passed for all paths.

Cell Site Types

Sites are configured as Omni/Omni or Sector/Sector (TX/RX). Each type has unique characteristics and must be optimized accordingly.

Cell Site Data File (CDF)



IMPORTANT

Before using the CDMA LMF for optimization/ATP, the correct **bts-#.cdf** and **cbsc-#.cdf** files for the BTS must be obtained from the CBSC and put in a **bts-#** folder in the LMF. Failure to use the correct CDF files can cause unreliable or improper site operation. **Failure to use the correct CDF files to log into a live (traffic carrying) site can shut down the site.**

The CDF includes the following information:

- Download instructions and protocol
- Site specific equipage information
- SCCP shelf allocation plan
 - BBX2 equipage (based on cell-site type) including redundancy
 - CSM equipage including redundancy
 - Multi Channel Card 24 or 8E (MCC24 or MCC8E) channel element allocation plan. This plan indicates how the SCCP shelf is configured, and how the paging, synchronization, traffic, and access channel elements (and associated gain values) are assigned among the (up to 4) MCC24s or MCC8Es in the shelf.
- CSM equipage including redundancy
- Effective Rated Power (ERP) table for all TX channels to antennas respectively. Motorola System Engineering specifies the ERP of a transmit antenna based on site geography, antenna placement, and government regulations. Working from this ERP requirement, the antenna gain, (dependent on the units of measurement specified) and

antenna feed line loss can be combined to determine the required power at the frame antenna connections. The corresponding BBX2 output level required to achieve that power level on any channel/sector can then be determined based on Bay Level Offset (BLO) data determined during the optimization process.

NOTE

Refer to the Figure 3-1 and the *LMF Help function* for additional information on the layout of the LMF directory structure (including CDF file locations and formats).

The CDF is normally obtained from the CBSC on a DOS formatted diskette, or through a file transfer protocol (ftp), if the LMF computer has ftp capability. Refer to the *LMF Help function*, and the LMF Help function, for more information.

CDF Site Equipage Verification

If it has not already been done, review and verify the site equipage data in the CDF with the actual site hardware and the site engineering documentation. Use a text editor to view the CDF contents.



CAUTION

Use extreme care not to make any changes to the CDF content while viewing the file. Changes to the CDF can cause the site to operate unreliably or render it incapable of operation.



CAUTION

Always wear a conductive, high impedance wrist strap while handling any circuit card/module to prevent damage by ESD. Extreme care should be taken during the removal and installation of any card/module. After removal, the card/module should be placed on a conductive surface or back into the anti-static bag in which it was shipped.

BTS System Release Software Download

The System Release software (for example R2.15.x.x) being used by the Base Station System (BSS) must be successfully downloaded to the BTS processor boards before optimization can be performed. Device initialization code is normally downloaded to the processor boards from the CBSC. Device application code and data is loaded from the CDMA LMF computer terminal.

Preparing the LMF

Overview

Before optimization can be performed, the CDMA LMF must be installed and configured on a computer platform meeting Motorola–specified requirements (see Recommended Test Equipment and Software in Chapter 1).



IMPORTANT

For the CDMA LMF graphics to display properly, the computer platform must be configured to display *more than 256 colors*. See the operating system software instructions for verifying and configuring the display settings.

Software and files for installing and updating the CDMA LMF are provided on CD ROM disks. The following items must be available:

- CDMA LMF Program on CD ROM
- CDMA LMF Binaries on CD ROM
- Configuration Data File (CDF) for each supported BTS (on floppy disk)
- CBSC File for each supported BTS (on floppy disk)

The following section provides information and instructions for installing and updating CDMA LMF software and files.

LMF Installation and Update Procedures

NOTE

First Time Installation Sequence:

1. Install Java Runtime Environment (JRE)
2. Install U/WIN K–shell emulator
3. Install LMF software
4. Install BTS Binaries
5. Install/create BTS folders

Follow the procedure in Table 3-1 to:

1. Install the CDMA LMF program using the CDMA LMF CD ROM
2. Install binary files using the CDMA LMF CD ROM

Table 3-1: CD ROM Installation

Step	Action
1	Insert the CDMA LMF CD ROM disk into your disk drive. <ul style="list-style-type: none">• If the Setup screen appears, follow the instructions displayed on the screen.• If the Setup screen is not displayed, proceed to Step 2.
2	Click on the Start button

Table 3-1: CD ROM Installation

Step	Action
3	Select Run .
4	Enter d:\autorun in the Open box and click OK . NOTE <i>(If applicable, replace the letter d with the correct CD ROM drive letter.)</i>
5	Follow the directions displayed in the Setup screen.

Copy CBSC CDF Files to the LMF Computer

Before logging on to a BTS with the CDMA LMF computer to execute optimization/ATP procedures, the correct **bts-#.cdf** and **cbsc-#.cdf** files must be obtained from the CBSC and put in a **bts-#** folder in the CDMA LMF computer. This requires creating versions of the CBSC CDF files on a DOS-formatted floppy diskette and using the diskette to install the CDF files on the CDMA LMF computer.



IMPORTANT

When copying CDF files, comply with the following to prevent BTS login problems with the Windows LMF:

- The numbers used in the **bts-#.cdf** and **cbsc-#.cdf** filenames must correspond to the locally-assigned numbers for each BTS and its controlling CBSC.
- The generic **cbsc-1.cdf** file supplied with the Windows LMF will work with locally numbered BTS CDF files. Using this file *will not provide a valid optimization* unless the generic file is edited to replace default parameters (e.g., channel numbers) with the operational parameters used locally.

The procedure in Table 3-2 lists the steps required to transfer the CDF files from the CBSC to the CDMA LMF computer. For any further information, refer to the *CDMA LMF Operator's Guide* (Motorola part no. 68P64114A21) or the CDMA LMF Help screen.

Table 3-2: Copying CBSC CDF Files to the LMF Computer

Step	Action
1	Login to the CBSC workstation.
2	Insert a DOS-formatted floppy diskette in the workstation drive.
3	Type eject -q and press the Enter key.

... continued on next page

Table 3-2: Copying CBSC CDF Files to the LMF Computer

Step	Action
4	Type mount and press the Enter key. NOTE <ul style="list-style-type: none"> • Look for the “<i>floppy/no_name</i>” message on the last line displayed. • If the eject command was previously entered, <i>floppy/no_name</i> will be appended with a number. Use the explicit <i>floppy/no_name</i> reference displayed when performing step 7.
5	Change to the directory, where the files to be copied reside, by typing cd <directoryname> (e.g., cd bts-248) and pressing the Enter key.
6	Type ls and press the Enter key to display the list of files in the directory.
7	With <i>Solaris versions of Unix</i> , create <i>DOS-formatted versions</i> of the <i>bts-#.cdf</i> and <i>cbsc-#.cdf</i> files on the diskette by entering the following command: unix2dos <source filename> /floppy/no_name/<target filename> (e.g., unix2dos bts-248.cdf /floppy/no_name/bts-248.cdf). NOTE <ul style="list-style-type: none"> • Other versions of Unix do not support the unix2dos and dos2unix commands. In these cases, use the Unix cp (copy) command. The <i>copied</i> files will be difficult to read with a DOS or Windows text editor because Unix files do not contain line feed characters. Editing <i>copied</i> CDF files on the CDMA LMF computer is, therefore, not recommended. • Using cp, multiple files can be <i>copied</i> in one operation by separating each filename to be copied with a space and ensuring the destination directory (<i>floppy/no_name</i>) is listed at the end of the command string following a space (e.g., cp bts-248.cdf cbsc-6.cdf /floppy/no_name).
8	Repeat steps 5 through 7 for each <i>bts-#</i> which must be supported by the CDMA LMF computer.
9	When all required files have been copied to the diskette type eject and press the Enter key.
10	Remove the diskette from the CBSC drive.
11	If it is not running, start the Windows operating system on the CDMA LMF computer.
12	Insert the diskette containing the <i>bts-#.cdf</i> and <i>cbsc-#.cdf</i> files into the CDMA LMF computer.
13	Using MS Windows Explorer, create a corresponding <i>bts-#</i> folder in the <i>wlmf\cdma</i> directory for each <i>bts-#.cdf/cbsc-#.cdf</i> file pair copied from the CBSC.
14	Use MS Windows Explorer to transfer the cbsc-#.cdf and bts-#.cdf files from the diskette to the corresponding wlmf\cdma\bts-# folders created in step 13.

3

Creating a Named HyperTerminal Connection for MMI Communication

Confirming or changing the configuration data of certain BTS Field Replaceable Units (FRU) requires establishing an MMI communication session between the CDMA LMF computer and the FRU. Using features of the Windows operating system, the connection properties for an MMI session can be saved on the CDMA LMF computer as a named Windows HyperTerminal connection. This eliminates the need for setting up connection parameters each time an MMI session is required to support optimization.

Once the named connection is saved, a shortcut for it can be created on the Windows desktop. Double-clicking the shortcut icon will start the connection without the need to negotiate multiple menu levels.

Follow the procedures in Table 3-3 to establish a named HyperTerminal connection and create a Windows desktop shortcut for it.



Table 3-3: Create HyperTerminal Connection

Step	Action
1	From the Windows Start menu, select: Programs > Accessories
2	Select Communications , double click the Hyperterminal folder, and then double click on the Hypertrm.exe icon in the window which opens. NOTE <ul style="list-style-type: none"> • If a Location Information Window appears, enter the required information, then click on the Close button. (This is required the first time, even if a modem is not to be used.) • If a You need to install a modem..... message appears, click on NO.
3	When the Connection Description box opens: <ul style="list-style-type: none"> – Type a name for the connection being defined (e.g., MMI Session) in the Name: window, – Highlight any icon preferred for the named connection in the Icon: chooser window, and – Click OK.
4	NOTE For CDMA LMF computer configurations where COM1 is used by another interface such as test equipment and a physical port is available for COM2, select COM2 in the following step to prevent conflicts. From the Connect using: pick list in the Connect To box displayed, select Direct to Com 1 or Direct to Com 2 for the RS–232 connection port, and click OK .

. . . continued on next page

Table 3-3: Create HyperTerminal Connection

Step	Action
5	In the Port Settings tab of the COM# Properties window displayed, configure the RS-232 port settings as follows: <ul style="list-style-type: none"> • Bits per second: 9600 • Data bits: 8 • Parity: None • Stop bits: 1 • Flow control: None
6	Click OK .
7	Save the defined connection by selecting: File > Save
8	Close the HyperTerminal window by selecting: File > Exit
9	Click the Yes button to disconnect when prompted.
10	If the Hyperterminal folder window is still open, proceed to step 12.
11	Select Communications and double click the Hyperterminal folder.
12	Highlight the newly-created connection icon by clicking on it.
13	<i>Right click and drag</i> the highlighted connection icon to the Windows desktop and release the right mouse button.
14	From the popup menu which appears, select Create Shortcut(s) Here .
15	If desired, reposition the shortcut icon for the new connection by dragging it to another location on the Windows desktop.
16	Close the Hyperterminal folder window by selecting: File > Close

Folder Structure Overview

The CDMA LMF uses a *wlmf* folder that contains all of the essential data for installing and maintaining the BTS. The following list outlines the folder structure for CDMA LMF. Except for the *bts-*nnn** folders, these folders are created as part of the CDMA LMF installation.

Figure 3-1: CDMA LMF Folder Structure

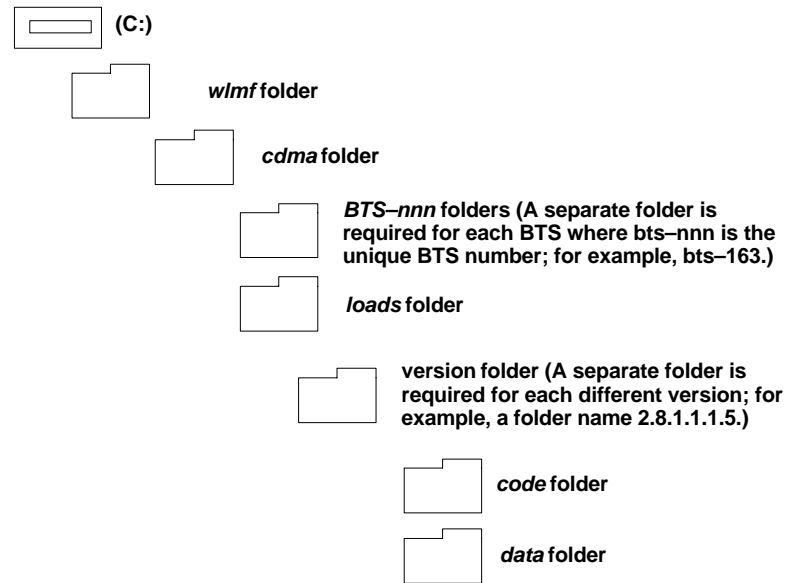

wlmf Folder

The *wlmf* folder contains the CDMA LMF program files.

cdma Folder

The *cdma* folder contains the *bts-*nnn** folders and the *loads* folder. It also contains a default *cbsc-1.cdf* file that can be copied to a *bts-*nnn** folder for use, if one cannot be obtained from the CBSC (Centralized Base Station Controller) when needed.

*bts-*nnn** Folders

Each *bts-*nnn** folder contains a CAL file, a CDF file and a *cbsc* file for the BTS. Other files required by CDMA LMF may also be located in the *bts-*nnn** folder. A *bts-*nnn** folder must be created for each BTS that is to be logged in to. The *bts-*nnn** folder must be correctly named (for example: *bts-273*) and must be placed in the *cdma* folder. Figure 3-2 shows an example of the file naming syntax for a BTS folder.

Figure 3-2: BTS Folder Name Syntax Example

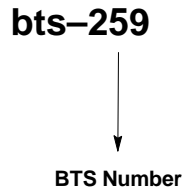

bts-*nnn*.cal File

The CAL (Calibration) file contains the bay level offset data (BLO) that is used for BLO downloads to the BBX devices. The CAL file is automatically created and updated by the CDMA LMF when TX calibration is performed. Figure 3-3 details the file name syntax for the CAL file.

Figure 3-3: CAL File Name Syntax Example

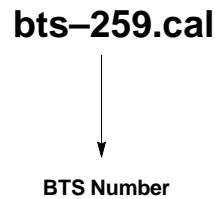

bts-*nnn*.cdf File

The CDF file contains data that defines the BTS and data that is used to download data to the devices. A CDF file must be placed in the applicable BTS folder before the CDMA LMF can be used to log into that BTS. CDF files are normally obtained from the CBSC using a floppy disk. A file transfer protocol (ftp) method can be used if the CDMA LMF computer has that capability. Figure 3-4 details the file name syntax for the CDF file.

Figure 3-4: CDF Name Syntax Example

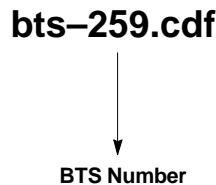

***cbsc* File**

The *cbsc-#.cdf* (Centralized Base Station Controller) file contains data for the BTS. If one is not obtained from the CBSC, a copy of the default *cbsc-1.cdf* file located in the *cdma* folder can be used.



IMPORTANT

Using the *generic cbsc-1.cdf* file will not provide a valid optimization unless the generic file is edited to replace default parameters with local operational parameters (e.g., CDMA channel numbers must be changed from the default “384” to those used locally by the BTS).

***loads* Folder**

The *loads* folder contains the version folder(s). It does not contain any files.

***version* Folder**

The *version* folder(s) contains the *code* and *data* folders. It does not contain any files. The name of version folders is the software version number of the code files that are included in its code folder. Version folders are created as part of the CDMA LMF installation and CDMA LMF updates. Each time the CDMA LMF is updated, another version folder will be created with the number of the software version for the code files being installed.

***code* Folder**

The code folder contains the binary files used to load code into the devices. A unique binary code file is required for each device type in the BTS to be supported with the CDMA LMF. Current version code files for each supported device created in this folder from the CDMA LMF CD ROM as part of the CDMA LMF installation/update process. Figure 3-5 shows an example of the file naming syntax for a code load file.

Figure 3-5: Code Load File Name Syntax Example

bbx_ram.bin.0600

Device Type

Hardware bin number

If this number matches the bin number of the device, the code file will automatically be used for the download*

* The device bin number can be determined by using the Status function after logging into a BTS. If the device does not have a bin number, one of the following default numbers must be used.

GLI=0100
LCI=0300
MCC=0C00
BBX=0600
BDC=0700
CSM=0800
TSU=0900
LPAC=0B00
MAWI=0D00

If a code file with the correct version and bin numbers is not found, a file selection window will appear.

data Folder

The data folder contains a DDS (Device Definition Structure) data file for each supported device type. The DDS files are used to specify the CDF file data that is used to download data to a device. Current version DDS files for each supported device type are created in this folder from the CDMA LMF CD ROM as part of the CDMA LMF installation or update process. Figure 3-6 shows an example of the file naming syntax for a code load file.

Figure 3-6: DDS File Name Syntax Example

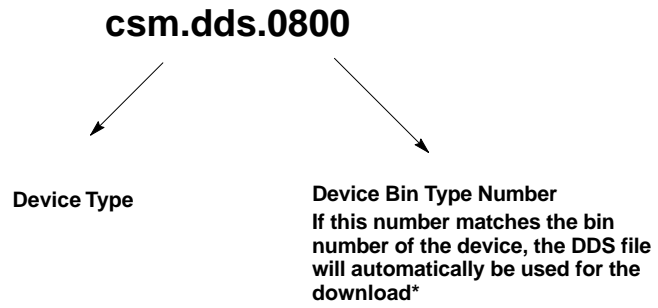

* The device bin number can be determined by using the Status function after logging into a BTS. If the device does not have a bin number, one of the following default numbers must be used.

- GLI=0100
- LCI=0300
- MCC=0C00
- BBX=0600
- BDC=0700
- CSM=0800
- TSU=0900
- LPAC=0B00

Span Lines – Interface and Isolation

T1/E1 Span Interface



IMPORTANT

At active sites, the OMC-R/CBSC must disable the BTS and place it out of service (OOS). **DO NOT** remove the span line cable connectors until the OMC-R/CBSC has disabled the BTS.

Each frame is equipped with one 50-pair punchblock for spans, customer alarms, remote GPS, and BTS frame alarms. See Figure 3-9 and refer to Table 3-5 for the physical location and punchdown location information.

Before connecting the LMF computer to the frame LAN, the OMC-R/CBSC must disable the BTS and place it OOS to allow the LMF to control the BTS. This prevents the CBSC from inadvertently sending control information to the BTS during LMF-based tests.

Isolate BTS from T1/E1 Spans

Once the OMC-R/CBSC has disabled the BTS, the spans must be disabled to ensure the LMF will maintain control of the BTS. To disable the spans, disconnect the cable connector for the BTS-to-CBSC Transcoder span at the Span I/O card (Figure 3-7).



IMPORTANT

If the BTS is a multi-frame logical BTS, *do not* disconnect the inter-frame span.

Figure 3-7: Disconnecting Span Lines

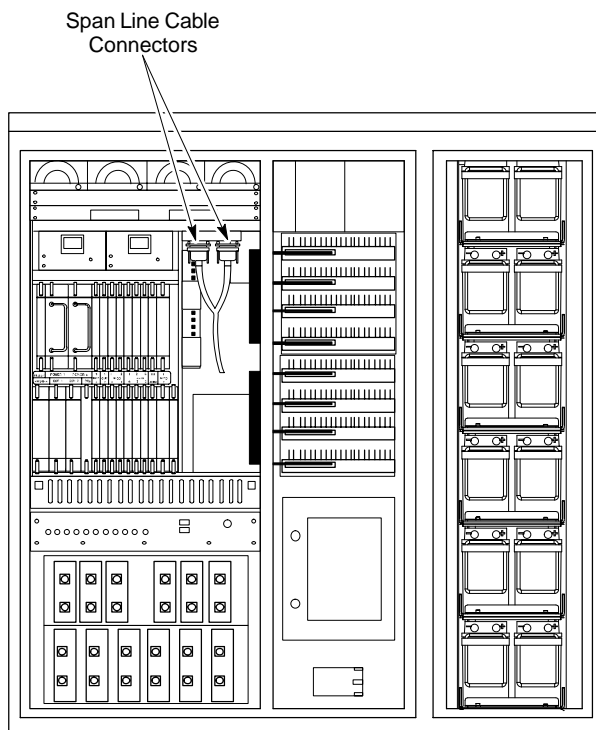

4812ETL0020-1

T1/E1 Span Isolation

Table 3-4 describes the action required for span isolation.

Table 3-4: T1/E1 Span Isolation	
Step	Action
1	Have the OMCR/CBSC place the BTS OOS.
2	To disable the span lines, locate the connector for the span or spans which must be disabled and remove the respective connector from the applicable SCCP cage Span I/O board (Figure 3-7).

Configure Optional Channel Service Units

The *M-PATH 537* Channel Service Unit (CSU) module provides in-band SNMP-managed digital service access to T1 and fractional T1 lines. The *M-PATH 437* Channel Service Unit (CSU) module provides in-band SNMP-managed digital service access to E1 and fractional E1 lines. CSU modules units plug into the CSU shelf (see Figure 3-8).

The CSU shelf can support two *M-PATH 537* or two *M-PATH 437* CSU modules. The 537 CSU module supports a single T1 span connection. The 437 CSU module supports a single E1 span connection.

Remote *M-PATH* management is available via SNMP over an in-band data link on the span line (using a facility data link or 8–64 Kbps of a DS0 channel). The unit at the near end of the management path can be an SNMP manager or another *M-PATH* CSU.

Programming of the *M-PATH* is accomplished through the DCE 9-pin connector on the front panel of the CSU shelf. Manuals and a Microsoft Windows programming disk are supplied with each unit.

For more information refer to *M-PATH T1 Channel Service Unit User’s Guide*, *ADC Kentrox* part number 65–77538101 or the *M-PATH E1 Channel Service Unit User’s Guide*, *ADC Kentrox* part number TBD.

Setting the Control Port

Whichever control port is chosen, it must first be configured so the control port switch settings match the communication parameters being used by the control device. If using the rear-panel DTE control port, set the SHELF ADDRESS switch SA5 to “up.” If using the rear-panel DCE control port, position the SHELF ADDRESS switch down.

For more information, refer to the 2-Slot Universal Shelf Installation Guide, *ADC Kentrox* part number 65–78070001.

Plug one of the cables listed below into the Control Port connectors:

<i>Part Number</i>	<i>Description of Cable</i>
01–95006–022 (six feet)	DB–9S to DB–9P
01–95010–022 (ten feet)	

The control port cables can be used to connect the shelf to:



Span Lines – Interface and Isolation – continued

- A PC using the AT 9-pin interface
- A modem using the 9-pin connector
- Other shelves in a daisy chain

Figure 3-8: Rear and Front View of CSU Shelf

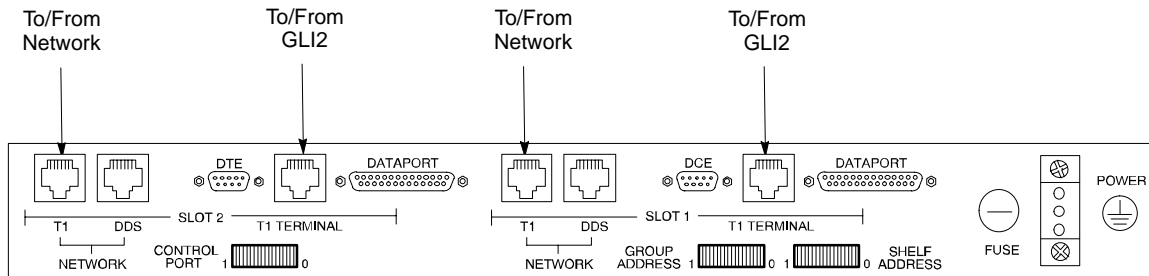

Rear View

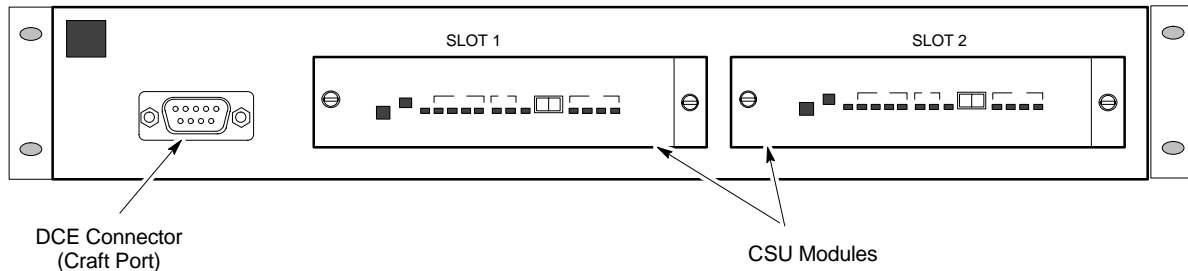

Front View

REF. FW00212

3

Alarm and Span Line Cable
Pin/Signal Information

See Figure 3-9 and refer to Table 3-5 for the physical location and punchdown location information for the 50-pair punchblock.

Figure 3-9: 50-Pair Punchblock

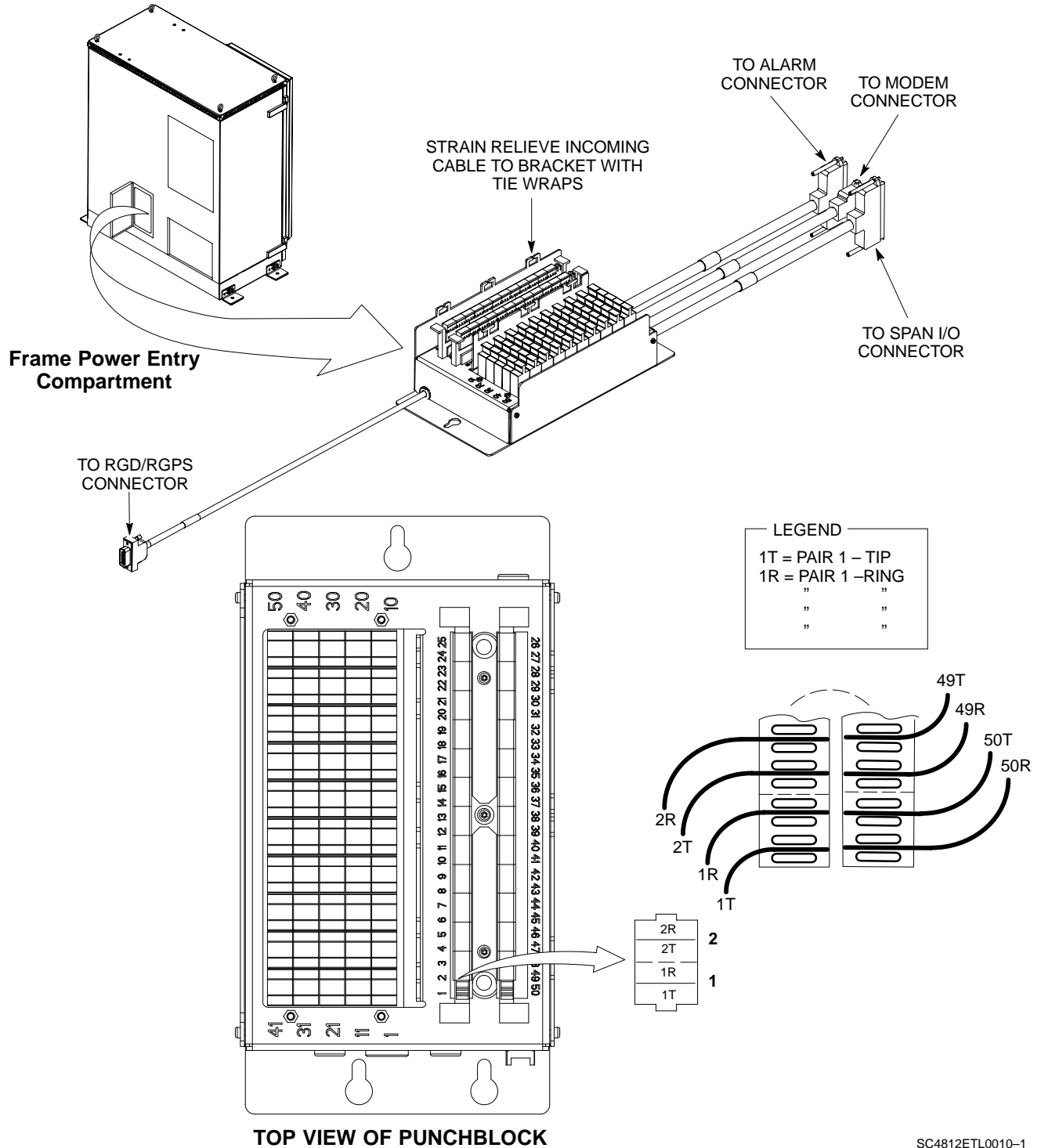

SC4812ETL0010-1

Span Lines – Interface and Isolation – continued

3

Table 3-5: Punchdown Location for 50-Pair Punch Block

<i>Site Component</i>	<i>Signal Name</i>	<i>Punchdown</i>	<i>Color</i>
NOT USED		1T	
		1R	
		2T	
		2R	
		3T	
		3R	
		4T	
		4R	
		5T	
		5R	
	6T		
	6R		
	7T		
LFR/HSO	LFR_HSO_GND	7R	Orange
	EXT_IPPS_POS	8T	Red
	EXT_IPPS_NEG	8R	White
	CAL_+	9T	Red
	CAL_-	9R	Green
	LORAN_+	10T	Red
	LORAN_-	10R	Blue
PILOT BEACON	Pilot Beacon Alarm – Minor	11T	
	Pilot Beacon Alarm – Rtn	11R	
	Pilot Beacon Alarm – Major	12T	
	Pilot Beacon Control – NO	12R	
	Pilot Beacon Control – COM	13T	
	Pilot Beacon Control – NC	13R	
CUSTOMER OUTPUTS / INPUTS	Customer Outputs 1 – NO	14T	
	Customer Outputs 1 – COM	14R	
	Customer Outputs 1 – NC	15T	
	Customer Outputs 2 – NO	15R	
	Customer Outputs 2 – COM	16T	
	Customer Outputs 2 – NC	16R	
	Customer Outputs 3 – NO	17T	
	Customer Outputs 3 – COM	17R	
	Customer Outputs 3 – NC	18T	
	Customer Outputs 4 – NO	18R	
	Customer Outputs 4 – COM	19T	
	Customer Outputs 4 – NC	19R	
	Customer Inputs 1	20T	
	Cust_Rtn_A_1	20R	
	Customer Inputs 2	21T	
	Cust_Rtn_A_2	21R	
	Customer Inputs 3	22T	
	Cust_Rtn_A_3	22R	
	Customer Inputs 4	23T	
	Cust_Rtn_A_4	23R	
	Customer Inputs 5	24T	
	Cust_Rtn_A_5	24R	
	Customer Inputs 6	25T	
	Cust_Rtn_A_6	25R	
	Customer Inputs 7	26T	
	Cust_Rtn_A_7	26R	
	Customer Inputs 8	27T	

... continued on next page

Span Lines – Interface and Isolation – continued

Table 3-5: Punchdown Location for 50-Pair Punch Block

<i>Site Component</i>	<i>Signal Name</i>	<i>Punchdown</i>	<i>Color</i>
CUSTOMER OUTPUTS / INPUTS	Cust_Rtn_A_8	27R	
	Customer Inputs 9	28T	
	Cust_Rtn_A_9	28R	
	Customer Inputs 10	29T	
	Cust_Rtn_A_10	29R	
SPAN	RVC_TIP_A	30T	Red/Bk
	RVC_RING_A	30R	Red
	XMIT_TIP_A	31T	White/Bk
	XMIT_RING_A	31R	White
	RVC_TIP_B	32T	Green/Bk
	RVC_RING_B	32R	Green
	XMIT_TIP_B	33T	Blue/Bk
	XMIT_RING_B	33R	Blue
	RVC_TIP_C	34T	Yellow/Bk
	RVC_RING_C	34R	Yellow
	XMIT_TIP_C	35T	Brown/Bk
	XMIT_RING_C	35R	Brown
	RVC_TIP_D	36T	Orange/Bk
	RVC_RING_D	36R	Orange
	XMIT_TIP_D	37T	Violet/Bk
	XMIT_RING_D	37R	Violet
	RVC_TIP_E	38T	Gray/Bk
	RVC_RING_E	38R	Gray
	XMIT_TIP_E	39T	Pink/Bk
	XMIT_RING_E	39R	Pink
RVC_TIP_F	40T	Tan/Bk	
RVC_RING_F	40R	Tan	
XMIT_TIP_F	41T	Bk/White	
XMIT_RING_F	41R	Bk	
RGPS	GPS_POWER_A+	42T	Blue
	GPS_POWER_A-	42R	Blue/Bk
	GPS_POWER_B+	43T	Yellow
	GPS_POWER_B-	43R	Yellow/Bk
	GPS_RX+	44T	White
	GPS_RX-	44R	White/Bk
	GPS_TX+	45T	Green
	GPS_TX-	45R	Green/Bk
	Signal Ground	46T	Red
	Master Frame	46R	Red/Bk
Phone Line	GPS_lpps+	47T	Brown
	GPS_lpps-	47R	Brown/Bk
Phone Line	Telco_Modem_T	48T	
	Telco_Modem_R	48R	
Miscellaneous	Chasis Ground	49T	Cable Drain
	Reserved	49R	
	Reserved	50T	
	Reserved	50R	

LMF to BTS Connection

LMF to BTS Connection

The CDMA LMF computer may be connected to the LAN A or B connector located behind the frame lower air intake grill. Figure 3-10 below shows the general location of these connectors. LAN A is considered the primary LAN.

Table 3-6: Connect the LMF to the BTS

Step	Action
1	To gain access to the LAN connectors, open the LAN cable and utility shelf access panel, then <i>pull apart the hook-and-loop fabric covering the BNC "T" connector</i> (see Figure 3-10). If desired, slide out the utility shelf for the LMF computer.
2	Connect the CDMA LMF computer to the LAN A (left-hand) BNC connector via PCMCIA Ethernet Adapter.

NOTE
Xircom Model PE3-10B2 or equivalent can also be used to interface the CDMA LMF Ethernet connection to the BTS frame connected to the PC parallel port, powered by an external AC/DC transformer. In this case, *the BNC cable must not exceed three feet in length.*

*** IMPORTANT**
The LAN shield is isolated from chassis ground. The LAN shield (exposed portion of BNC connector) **must not touch the chassis** during optimization.

Figure 3-10: LMF Connection Detail

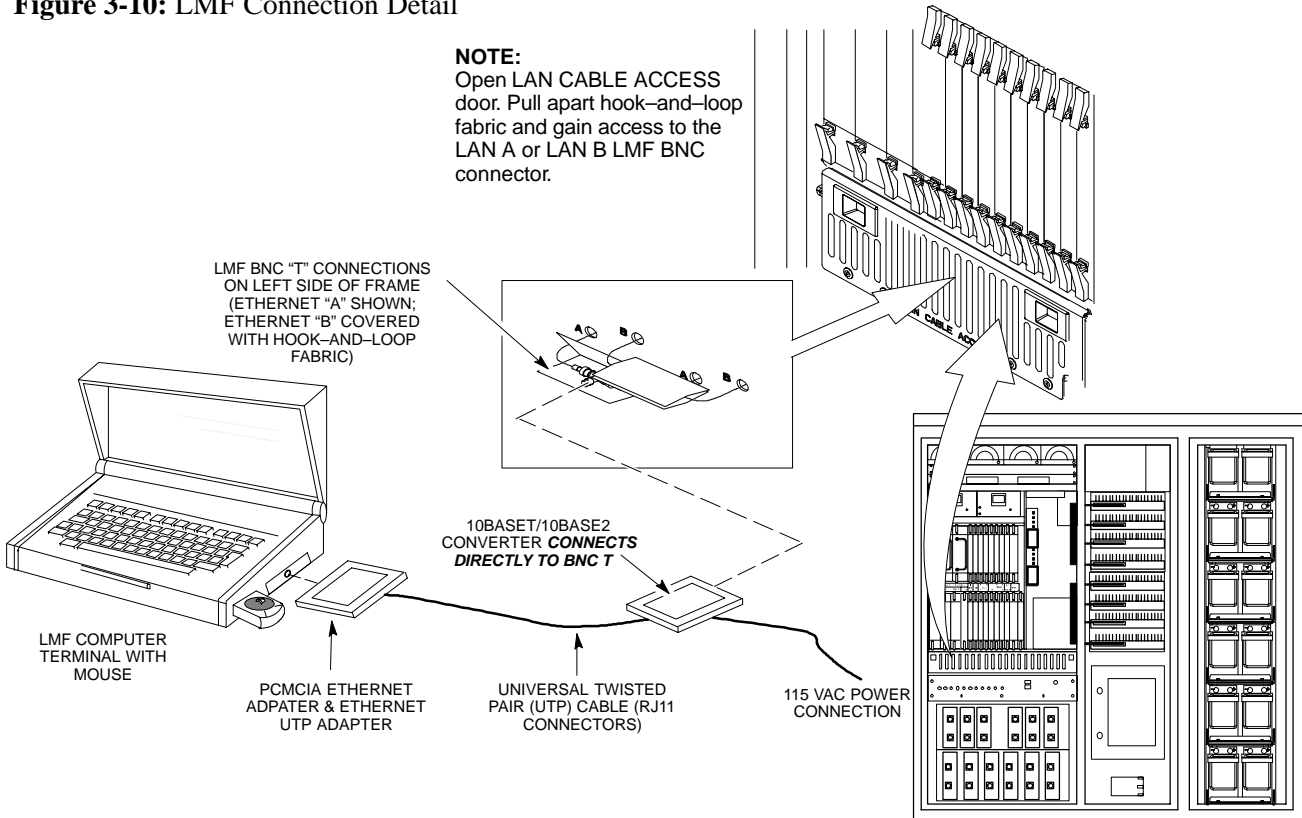

SC4812ETL0012-2

Using CDMA LMF

Basic CDMA LMF Operation

The CDMA LMF allows the user to work in the two following operating environments which are accessed using the specified desktop icons:

- Graphical User Interface (GUI) using the WinLMF icon
- Command Line Interface (CLI) using the WinLMF CLI icon

The GUI is the *primary* optimization and acceptance testing operating environment. The CLI environment provides additional capability to the user to perform manually controlled acceptance tests and audit the results of optimization and calibration actions.

Basic operation of the CDMA LMF in either environment includes performing the following:

- Selecting and Deselecting BTS devices
- Enabling devices
- Disabling devices
- Resetting devices
- Obtaining device status

The following additional basic operation can be performed in a GUI environment:

- Sorting a status report window

For detailed information on performing these and other CDMA LMF operations, refer to the *LMF Help function* and the *LMF CLI Reference; 68P09253A56*.



IMPORTANT

Unless otherwise noted, LMF procedures in this manual are performed using the GUI environment.

CDMA LMF and Logical BTS

An SC4812ET Lite logical BTS can consist of up to two SC4812ET Lite frames. When the CDMA LMF is connected to a frame 1 Ethernet port of a logical BTS, access is available to all devices in all of the frames that make up the logical BTS. A logical BTS CDF file that includes equipment information for all of the logical BTS frames and their devices is required for proper LMF interface. A CBSC CDF file that includes channel data for all of the logical BTS frames is also required.

The first frame of a logical BTS has a **-1** suffix (for example, **BTS-812-1**) and the second frame of the logical BTS is numbered with the suffix, **-101** (e. g. **BTS-812-101**). When the CDMA LMF is logged into a BTS, a FRAME tab is displayed for each frame. If there is only one frame for the BTS, there will only be one tab (e.g., **FRAME-282-1** for **BTS-282**). If a logical BTS has more than one frame, there will be a

separate **FRAME** tab for each frame (for example, **FRAME-438-1**, and **FRAME-438-101** for **BTS-438** that has both frames). If an RFDS is included in the CDF file, an **RFDS** tab (e.g., **RFDS-438-1**) will be displayed.

Actions, such as ATP tests, can be initiated for selected devices in one or more frames of a logical BTS. Refer to the CDMA LMF Select devices help screen for information on how to select devices.

3

Logging Into a BTS



CAUTION

Be sure that the correct **bts-#.cdf** and **cbsc-#.cdf** file is used for the BTS. These should be the CDF files that are provided for the BTS by the CBSC. Failure to use the correct CDF files can result in invalid optimization.

Failure to use the correct CDF files to log into a live (traffic-carrying) site can shut down the site.

Logging into a BTS establishes a communications link between the BTS and the CDMA LMF. You may be logged into one or more BTSs at a time, but only one CDMA LMF may be logged into each BTS.

Before attempting to start the CDMA LMF computer and the CDMA LMF software, confirm the CDMA LMF computer is properly connected to the BTS (see Table 3-6). Follow the procedures in Table 3-7 to log into a BTS.

Prerequisites

Before attempting to log into a BTS, ensure the following have been completed:

- The CDMA LMF is correctly installed and prepared.
- A **bts-*nnn*** folder with the correct CDF and CBSC files exists.
- The CDMA LMF computer was connected to the BTS before starting the Windows operating system and the CDMA LMF software. If necessary, restart the computer after connecting it to the BTS in accordance with Table 3-6 and Figure 3-10.