



---

# **1X SC<sup>™</sup> 4812T BTS Optimization/ATP**

**Table of Contents**

## Contents

FCC Requirements .....	xviii
Content .....	xviii
FCC Part 15 Requirements .....	xviii
FCC Part 68 Requirements .....	xix
Foreword .....	xx
General Safety .....	xxii
Revision History .....	xxiv
<b>Chapter 1 Introduction .....</b>	<b>1-1</b>
Optimization Manual: Scope and Layout .....	1-2
Manual Scope and Layout .....	1-2
Assumptions and Prerequisites .....	1-2
Document Composition .....	1-3
Purpose of the Optimization .....	1-4
Why Optimize? .....	1-4
What Is Optimization? .....	1-4
What Happens During Optimization? .....	1-4
When to Optimize .....	1-5
New Installations .....	1-5
Site Expansion .....	1-5
Periodic Optimization .....	1-5
Repaired Sites .....	1-5
Required Test Equipment and Software .....	1-6
Overview .....	1-6
Policy .....	1-6
Test Equipment Calibration .....	1-6
Test Cable Calibration .....	1-6
Equipment Warm-up .....	1-7
LMF computer and software .....	1-7
Communications system analyzer CDMA/analog .....	1-9
Optional Equipment .....	1-11
Required Documentation .....	1-12
Required Documents .....	1-12
Related Publications .....	1-12
Terms and Abbreviations .....	1-13
Standard and Non-standard Terms and Abbreviations .....	1-13
BTS Equipment Identification .....	1-15
Equipment Overview .....	1-15
Ancillary Equipment Frame Identification .....	1-15
Logical BTS .....	1-15
BTS Frame Description .....	1-21
I/O Interconnect Plates .....	1-23
Combined CDMA Channel Processor Shelf .....	1-27
BBX-1X and BBX2 Interchangeability .....	1-27
Linear Power Amplifier Shelf .....	1-28
BTS Sector Configuration .....	1-30
<b>Chapter 2 Preliminary Operations .....</b>	<b>2-1</b>
Preliminary Operations: Overview .....	2-2

Introduction .....	2-2
Cell Site Types .....	2-2
CDF/NECF .....	2-2
Site Equipage Verification .....	2-2
Initial Installation of Boards/Modules .....	2-3
Setting Frame C–CCP Shelf Configuration Switch .....	2-4
<b>Pre–Power–up Tests .....</b>	<b>2-5</b>
Objective .....	2-5
Test Equipment .....	2-5
Cabling Inspection .....	2-5
DC Power Pre-test (BTS Frame) .....	2-6
DC Power Pre-test (RFDS) .....	2-12
<b>Initial Power–up Tests and Procedures .....</b>	<b>2-13</b>
Power-up Procedures .....	2-13
Common Power Supply Verification .....	2-14
Initial Power-up (RFDS) .....	2-15
Initial Power-up (BTS) .....	2-15
<b>Chapter 3 Optimization/Calibration .....</b>	<b>3-1</b>
Introduction to Optimization and Calibration .....	3-2
Overview .....	3-2
Optimization Process Summary .....	3-2
Cell-site Types .....	3-3
CDF/NECF .....	3-3
BTS System Software Download .....	3-4
Site Equipage Verification .....	3-4
<b>Preparing the LMF .....</b>	<b>3-5</b>
Overview of Packet BTS files .....	3-5
LMF Features and Installation Requirements .....	3-6
LMF File Structure Overview .....	3-7
LMF Home Directory .....	3-8
NECF Filename Conventions and Directory Location .....	3-9
LMF Operating System Installation .....	3-10
Copy BTS and CBSC CDF (or NECF) Files to the LMF Computer .....	3-11
Creating a Named HyperTerminal Connection for MMI Connection .....	3-13
<b>Span Lines – Interface and Isolation .....</b>	<b>3-15</b>
T1/E1 Span Interface .....	3-15
Isolate BTS from T1/E1 Spans .....	3-15
T1/E1 Span Isolation .....	3-16
<b>LMF to BTS Connection .....</b>	<b>3-17</b>
Connect the LMF to the BTS .....	3-17
<b>Using the LMF .....</b>	<b>3-18</b>
Basic LMF Operation .....	3-18
The LMF Display and the BTS .....	3-19
Graphical User Interface Overview .....	3-19
Understanding GUI Operation .....	3-20
Command Line Interface Overview .....	3-25
Logging into a BTS .....	3-26
Logging Out .....	3-29
Establishing an MMI Communication Session .....	3-31
Online Help .....	3-32
<b>Pinging the Processors .....</b>	<b>3-33</b>

Pinging the BTS .....	3-33
Download the BTS .....	3-35
Overview .....	3-35
ROM Code .....	3-35
RAM Code .....	3-35
Verify GLI ROM Code Loads .....	3-37
Download RAM Code and Data to MGLI and GLI .....	3-38
Download Code and Data to Non–GLI Devices .....	3-39
Select CSM Clock Source .....	3-40
Enable MCCs .....	3-42
Enable Redundant GLIs .....	3-42
CSM System Time – GPS & LFR/HSO Verification .....	3-43
CSM & LFR Background .....	3-43
Front Panel LEDs .....	3-43
Low Frequency Receiver/High Stability Oscillator (LFR/HSO) .....	3-44
CSM Frequency Verification .....	3-45
Null Modem Cable .....	3-45
Test Equipment Setup: GPS & LFR/HSO Verification .....	3-46
GPS Initialization/Verification .....	3-48
LFR Initialization/Verification .....	3-52
HSO Initialization/Verification .....	3-54
Test Equipment Set-up .....	3-56
Connecting Test Equipment to the BTS .....	3-56
Test Equipment GPIB Address Settings .....	3-56
Supported Test Equipment .....	3-57
Test Equipment Connection Charts .....	3-58
Equipment Warm-up .....	3-60
Automatic Cable Calibration Set–up .....	3-60
Manual Cable Calibration .....	3-60
Set-up for TX Calibration .....	3-65
Setup for Optimization/ATP .....	3-68
ATP Setup with Directional Couplers .....	3-72
Test Set Calibration .....	3-74
Background .....	3-74
Calibration Procedures Included .....	3-74
GPIB Addresses .....	3-75
IP Addresses .....	3-75
Selecting Test Equipment .....	3-75
Manually Selecting Test Equipment in a Serial Connection Tab .....	3-76
Automatically Selecting Test Equipment in Serial Connection Tab .....	3-77
Detecting Test Equipment when using Agilent E7495A .....	3-77
Calibrating Test Equipment .....	3-78
Calibrating Cables Overview .....	3-79
Calibrate Test Cabling using Communications System Analyzer .....	3-80
Calibrate Test Cabling Using Signal Generator & Spectrum Analyzer .....	3-81
Setting Cable Loss Values .....	3-83
Setting TX Coupler Loss Values .....	3-84
Bay Level Offset Calibration .....	3-85
Introduction .....	3-85
RF Path Bay Level Offset Calibration .....	3-85
When to Calibrate BLOs .....	3-85
TX Path Calibration .....	3-86

BLO Calibration Data File .....	3-86
Test Equipment Set-up for RF Path Calibration .....	3-89
Transmit (TX) Path Calibration Description .....	3-89
TX Calibration and the LMF .....	3-90
Set-up for TX Calibration .....	3-91
TX Calibration .....	3-92
All Cal/Audit and TX Calibration Procedure .....	3-92
Download BLO Procedure .....	3-94
Calibration Audit Introduction .....	3-94
TX Path Audit .....	3-95
TX Audit Test .....	3-95
All Cal/Audit Test .....	3-97
Create CAL File .....	3-98
<b>RFDS Set-up and Calibration .....</b>	<b>3-99</b>
RFDS Description .....	3-99
RFDS Parameter Settings .....	3-99
Checking and Setting RFDS Parameters .....	3-100
RFDS TSU NAM Programming .....	3-102
Explanation of Parameters used when Programming the TSU NAM .....	3-102
Valid NAM Ranges .....	3-103
Set Antenna Map Data .....	3-104
Set RFDS Configuration Data .....	3-105
RFDS Calibration .....	3-106
Program TSU NAM .....	3-108
<b>BTS Redundancy/Alarm Testing .....</b>	<b>3-109</b>
Objective .....	3-109
Test Equipment .....	3-109
Redundancy/Alarm Test .....	3-109
Test Equipment Setup .....	3-110
Power Supply Redundancy .....	3-111
Miscellaneous Alarm/Redundancy Tests .....	3-113
BBX Redundancy .....	3-114
CSM, GPS, & LFR/HSO Redundancy/Alarm Tests .....	3-116
Power Amplifier (PA) Redundancy Test .....	3-118
MGLI/GLI Redundancy Test .....	3-119
<b>Alarms Testing .....</b>	<b>3-120</b>
Alarm Verification .....	3-120
Alarm Reporting Display .....	3-120
Purpose .....	3-121
Test Equipment .....	3-121
CDI Alarm Input Verification with Alarms Test Box .....	3-122
CDI Alarm Input Verification without Alarms Test Box .....	3-124
Pin and Signal Information for Alarm Connectors .....	3-126
<b>Chapter 4 Automated Acceptance Test Procedure .....</b>	<b>4-1</b>
<b>Automated Acceptance Test Procedures .....</b>	<b>4-2</b>
Introduction .....	4-2
Reduced ATP .....	4-3
ATP Test Options .....	4-4
ATP Test Prerequisites .....	4-5
TX OUT Connection .....	4-5
Required Test Equipment .....	4-6
Individual Acceptance Tests .....	4-7

Individual Tests .....	4-7
ATP Test Procedure .....	4-9
Individual ATP Test Background Information .....	4-11
TX Spectral Purity Transmit Mask Acceptance Test (Tx Mask) .....	4-11
TX Waveform Quality (rho) Acceptance Test .....	4-12
TX Pilot Time Offset Acceptance Test .....	4-13
TX Code Domain Power/Noise Floor Acceptance Test .....	4-13
RX Frame Error Rate (FER) Acceptance Test .....	4-14
Generating an ATP Report .....	4-16
Background .....	4-16
ATP Report .....	4-16
<b>Chapter 5 Prepare to Leave the Site .....</b>	<b>5-1</b>
Updating Calibration Data Files .....	5-2
Software Release caveats .....	5-2
Copy and Load Cal File to to CBSC .....	5-2
Prepare to Leave the Site .....	5-4
External Test Equipment Removal .....	5-4
BTS Site Span Configuration Verification .....	5-5
Set BTS Site Span Configuration .....	5-6
LMF Removal .....	5-8
Re-connect BTS T1/E1 Spans and Integrated Frame Modem .....	5-9
Reset All Devices and Initialize Site Remotely .....	5-10
<b>Chapter 6 Basic Troubleshooting .....</b>	<b>6-1</b>
Basic Troubleshooting Overview .....	6-2
Overview .....	6-2
Troubleshooting: Installation .....	6-3
Cannot Log into Cell-Site .....	6-3
Cannot Communicate to Power Meter .....	6-3
Cannot Communicate to Communications Analyzer .....	6-4
Troubleshooting: Download .....	6-5
Cannot Download CODE to Any Device (card) .....	6-5
Cannot Download DATA to Any Device (Card) .....	6-5
Cannot ENABLE Device .....	6-6
Miscellaneous Errors .....	6-6
Troubleshooting: Calibration .....	6-7
Bay Level Offset Calibration Failure .....	6-7
Cannot Load BLO .....	6-8
Calibration Audit Failure .....	6-8
Troubleshooting: Transmit ATP .....	6-9
BTS passed Reduced ATP tests but has forward link problem during normal operation .....	6-9
Cannot Perform TX Mask Measurement .....	6-9
Cannot Perform Rho or Pilot Time Offset Measurement .....	6-9
Cannot Perform Code Domain Power and Noise Floor Measurement .....	6-10
Troubleshooting: Receive ATP .....	6-11
Multi-FER Test Failure .....	6-11
Troubleshooting: CSM Check-list .....	6-12
Problem Description .....	6-12
Intermittent 19.6608 MHz Reference Clock/GPS Receiver Operation .....	6-12

No GPS Reference Source .....	6-12
Checksum Failure .....	6-12
GPS Bad RX Message Type .....	6-12
CSM Reference Source Configuration Error .....	6-12
Takes Too Long for CSM to Come INS .....	6-13
<b>C–CCP Backplane Troubleshooting .....</b>	<b>6-14</b>
Introduction .....	6-14
Connector Functionality .....	6-14
C–CCP Backplane Troubleshooting Procedure .....	6-15
Digital Control Problems .....	6-16
DC Power Problems .....	6-19
TX and RX Signal Routing Problems .....	6-20
<b>Module Front Panel LED Indicators and Connectors .....</b>	<b>6-21</b>
Module Status Indicators .....	6-21
LED Status Combinations for All Modules (except GLI, CSM, BBX, MCC) .....	6-21
DC/DC Converter LED Status Combinations .....	6-21
CSM LED Status Combinations .....	6-22
GLI2 LED Status Combinations .....	6-23
GLI2 Pushbuttons and Connectors .....	6-24
GLI3 Front Panel .....	6-26
BBX LED Status Combinations .....	6-27
MCC LED Status Combinations .....	6-27
LPA Shelf LED Status Combinations .....	6-28
<b>Basic Troubleshooting – Span Control Link .....</b>	<b>6-29</b>
Span Problems (No Control Link) .....	6-29
Set BTS Site Span Configuration .....	6-32
<b>Appendix A Data Sheets .....</b>	<b>A-1</b>
<b>Optimization (Pre–ATP) Data Sheets .....</b>	<b>A-2</b>
Verification of Test Equipment Used .....	A-2
Site Checklist .....	A-3
Preliminary Operations .....	A-3
Pre–Power and Initial Power Tests .....	A-4
General Optimization Checklist .....	A-5
GPS Receiver Operation .....	A-6
LFR Receiver Operation .....	A-7
LPA IM Reduction .....	A-8
LPA Convergence .....	A-9
TX BLO/Power Output Verification for 3–Sector Configurations .....	A-10
TX BLO/Power Output Verification for 6–Sector Configurations .....	A-15
BTS Redundancy/Alarm Tests .....	A-17
TX Antenna VSWR .....	A-17
RX Antenna VSWR .....	A-18
AMR Verification .....	A-18
<b>Site Serial Number Check List .....</b>	<b>A-19</b>
C–CCP Shelf .....	A-19
LPAs .....	A-20
Power Conversion Shelf (–48 V BTS Only) .....	A-20
<b>Appendix B PN Offset/I &amp; Q Offset Register Programming Information .....</b>	<b>B-1</b>
<b>PN Offset Programming Information .....</b>	<b>B-2</b>
PN Offset Background .....	B-2

PN Offset Usage .....	B-2
<b>Appendix C FRU Optimization/ATP Test Matrix .....</b>	<b>C-1</b>
FRU Optimization/ATP Test Matrix .....	C-2
Usage & Background .....	C-2
Detailed Optimization/ATP Test Matrix .....	C-3
<b>Appendix D BBX Gain Set Point vs. BTS Output .....</b>	<b>D-1</b>
BBX Gain Set Point vs. BTS Output Considerations .....	D-2
Usage & Background .....	D-2
<b>Appendix E CDMA Operating Frequency .....</b>	<b>E-1</b>
Operating Frequency – North American PCS Bands .....	E-2
Introduction .....	E-2
1900 MHz PCS Channels .....	E-2
Calculating 1900 MHz Center Frequencies .....	E-3
800 MHz CDMA Channels .....	E-5
Calculating 800 MHz Center Frequencies .....	E-5
Operating Frequency – Korean Bands .....	E-7
1700 MHz PCS Channels .....	E-7
Calculating 1700 MHz Center Frequencies .....	E-8
<b>Appendix F Test Equipment Preparation .....</b>	<b>F-1</b>
Test Equipment Preparation .....	F-2
Purpose .....	F-2
Agilent R7495A Test Equipment Setup .....	F-3
Verifying and Setting GPIB Addresses .....	F-6
Agilent E4406A Transmitter Tester GPIB Address .....	F-6
Agilent E4432B Signal Generator GPIB Address .....	F-7
Advantest R3267 Spectrum Analyzer GPIB Address .....	F-8
Advantest R3562 Signal Generator GPIB Address .....	F-9
Agilent 8935 Series E6380 (formerly HP 8935) Test Set GPIB Address .....	F-10
Hewlett Packard HP8921A and HP83236A/B GPIB Address .....	F-11
Advantest R3465 Communications Test Set GPIB Address .....	F-12
Motorola CyberTest GPIB Address .....	F-13
HP 437 Power Meter GPIB Address .....	F-14
Gigatronics 8541C Power Meter GPIB Address .....	F-15
RS232 GPIB Interface Adapter .....	F-16
Test Equipment Set-up .....	F-17
Purpose .....	F-17
Equipment Warm up .....	F-17
Prerequisites .....	F-17
HP8921A System Connectivity Test .....	F-18
Manual Cable Calibration using HP8921 with HP PCS Interface (HP83236) .....	F-19
HP PCS Interface Test Equipment Setup for Manual Testing .....	F-23
Calibrating Test Cable Setup using Advantest R3465 .....	F-24
Agilent E4406A Transmitter Tester Self-alignment (Calibration) .....	F-27
<b>Appendix G Download ROM Code .....</b>	<b>G-1</b>
Download ROM Code .....	G-2
Download ROM Code .....	G-2



<b>Appendix H In–Service Calibration</b> .....	<b>H-1</b>
Introduction .....	H-2
Purpose .....	H-2
Equipment Warm up .....	H-2
Power Delta Calibration .....	H-3
Power Delta Calibration Introduction .....	H-3
HP8921A Power Delta Calibration .....	H-3
Advantest R3465 Power Delta Calibration .....	H-5
HP8935 Power Delta Calibration .....	H-8
Agilent E4406A Power Delta Calibration .....	H-10
In–Service Calibration .....	H-13
<b>Appendix I VSWR</b> .....	<b>I-1</b>
Transmit & Receive Antenna VSWR .....	I-2
Purpose .....	I-2
Test equipment .....	I-2
Equipment Setup – HP Test Set .....	I-3
Equipment Setup – Advantest Test Set .....	I-5
<b>Appendix J Packet Backhaul Configuration</b> .....	<b>J-1</b>
BTS Router Initial Configuration .....	J-2
Overview .....	J-2
Terminal Setup .....	J-3
General .....	J-3
BTS Router Serial Communication .....	J-5
Downloading Minimum Canned BTS Router Configuration Files .....	J-8
Downloading Overview .....	J-8
Prerequisites .....	J-8
FTP File Transfer from the OMC–R .....	J-8
Verifying IOS Canned Version of the CF Memory Card .....	J-13
Overview .....	J-13
IOS Version Verification and File Sequence Position .....	J-13
Canned Configuration File Installation .....	J-13
Method 1: Using a TFTP Server to Load to CF Memory Card .....	J-15
Method 2: Using a CF Memory Card Reader to Load CF Memory Card .....	J-29
Replacing Installed BTS Router CF Memory Card IOS Version .....	J-36
Background .....	J-36
Equipment and Software Required for Verification Methods .....	J-36
Required Publications .....	J-36
Method 1: Replacement of Installed Router CF Card IOS Data .....	J-37
Method 2: Using a CF Memory Card Reader for Replacement of Installed IOS Version and Changing File Sequence Position .....	J-44
Change CF Memory Card File Sequence to Place IOS File First on the Card .....	J-48
Verify and Upgrade rommon Version .....	J-56
Introduction .....	J-56
Equipment and Software Required for Verification .....	J-56
Required Publications .....	J-56
Method 1: In–Router Verification and Replacement of Installed rommon Version .....	J-57
Method 2: Verification and Replacement of Installed rommon Version Using a CF Memory Card Reader ..	J-63
Recovery From BTS Router Boot to rommon .....	J-67

---

Introduction .....	J-67
Simple Recovery from Boot to rommon .....	J-67
Extended Recovery from Boot to rommon .....	J-71
Entering or Changing Router FE Interface IP Address .....	J-75
Prerequisites .....	J-75
Entering or Changing FE Interface IP Addresses .....	J-75
BTS Router Canned Configuration File .....	J-79
Obtaining the Latest Configuration File Content .....	J-79
Configuration File Examples .....	J-79
“Blue” BTS Router Canned Configuration .....	J-80
“Red” BTS Router Canned Configuration .....	J-82
Preparation for Site Turn–over .....	J-84
Returning the Site to OMC–R Control .....	J-84
What to Do Next .....	J-84
<b>Index .....</b>	<b>Index-1</b>

## List of Figures

Figure 1-1: Null Modem Cable Detail .....	1-8
Figure 1-2: +27 V SC 4812T BTS Starter Frame .....	1-17
Figure 1-3: –48 V SC 4812T BTS Starter Frame (2100 mm) .....	1-18
Figure 1-4: +27 V SC 4812T BTS Expansion Frame .....	1-19
Figure 1-5: –48 V SC 4812T BTS Expansion Frame (2100 mm) .....	1-20
Figure 1-6: +27 V SC 4812T Starter Frame I/O Interconnect Plate .....	1-23
Figure 1-7: –48 V SC 4812T Starter Frame I/O Interconnect Plate .....	1-24
Figure 1-8: +27 V SC 4812T Expansion Frame I/O Interconnect Plate .....	1-25
Figure 1-9: –48 V SC 4812T Expansion Frame I/O Interconnect Plate .....	1-26
Figure 1-10: SC 4812T Combined CDMA Channel Processor (C–CCP) Shelf .....	1-27
Figure 1-11: +27 V SC 4812T PA Configuration – 4 Carrier with 2:1 Combiners .....	1-28
Figure 1-12: –48 V SC 4812T PA Configuration – 4 Carrier, 3–Sector with 2:1 Combiners .....	1-29
Figure 1-13: +27 V SC4812T PA Configuration with Combiners/Filters .....	1-32
Figure 1-14: –48 V SC4812T PA Configuration with Combiners/Filters .....	1-33
Figure 1-15: –48 V BTS Power Conversion Shelf .....	1-34
Figure 1-16: CDMA (COBRA) RFDS Layout .....	1-35
Figure 2-1: 800 MHz Configuration Switch Card .....	2-3
Figure 2-2: Backplane DIP Switch Settings – SC 4812T .....	2-4
Figure 2-3: +27 V BTS DC Distribution Pre-test .....	2-8
Figure 2-4: +27 V SC 4812T BTS Starter Frame .....	2-9
Figure 2-5: –48 V BTS DC Distribution Pre-test .....	2-10
Figure 2-6: –48 V SC 4812T BTS Starter Frame .....	2-11
Figure 2-7: DC Distribution Pre-test (COBRA RFDS Detail) .....	2-12
Figure 3-1: LMF Folder Structure .....	3-7
Figure 3-2: Span I/O Board T1 Span Isolation .....	3-15
Figure 3-3: LMF Connection Detail .....	3-17
Figure 3-4: BTS Login screen – identifying circuit and packet BTS files .....	3-21
Figure 3-5: Self–Managed Network Elements (NEs) state of a packet mode SC4812T .....	3-22
Figure 3-6: Available packet mode commands .....	3-23
Figure 3-7: Packet mode site with MCC–1 and BBX–1 under LMF control .....	3-24
Figure 3-8: CDMA LMF Computer Common MMI Connections .....	3-32
Figure 3-9: BTS Ethernet LAN Interconnect Diagram .....	3-33
Figure 3-10: Null Modem Cable Detail .....	3-45
Figure 3-11: CSM MMI terminal connection .....	3-47
Figure 3-12: IS–95A/B Cable Calibration Test Setup – CyberTest, Agilent 8935, Advantest R3465, and HP 8921A .....	3-61
Figure 3-13: IS–95A/B and CDMA 2000 1X Cable Calibration Test Setup – Agilent E4406A/E4432B and Advantest R3267/R3562 .....	3-62
Figure 3-14: CDMA2000 1X Cable Calibration Test Setup – Agilent 8935/E4432B .....	3-63
Figure 3-15: CDMA2000 1X Cable Calibration Test Setup – Agilent E7495A .....	3-64

Figure 3-16: TX Calibration Test Setup – CyberTest (IS–95A/B) and Agilent 8935 (IS–95A/B and CDMA2000 1X), and Advantest R3465 .....	3-65
Figure 3-17: TX Calibration Test Setup – Agilent E4406A and Advantest R3567 (IS–95A/B and CDMA2000 1X) .....	3-66
Figure 3-18: TX Calibration Test Setup – Agilent E7495A (IS–95A/B and CDMA2000 1X) .....	3-67
Figure 3-19: Optimization/ATP Test Setup Calibration – Agilent 8935 .....	3-68
Figure 3-20: Optimization/ATP Test Setup – HP 8921 .....	3-69
Figure 3-21: IS–95A/B and CDMA2000 1X Optimization/ATP Test Setup – Advantest R3267/3562, Agilent E4432B/E4406A .....	3-70
Figure 3-22: IS–95A/B and CDMA2000 1X Optimization/ATP Test Setup – Agilent E7495A .....	3-71
Figure 3-23: Typical TX ATP Setup with Directional Coupler .....	3-72
Figure 3-24: Typical RX ATP Setup with Directional Coupler .....	3-73
Figure 3-25: Cal Setup for TX/Duplexed RX Test Cabling Using Signal Generator & Spectrum Analyzer .....	3-81
Figure 3-26: Cal Setup for Non–Duplexed RX Test Cabling Using Signal Generator & Spectrum Analyzer .....	3-82
Figure 3-27: SC 4812T C–CCP Shelf .....	3-112
Figure 3-28: –48 V BTS Power Conversion Shelf .....	3-112
Figure 3-29: +27 V BTS C-CCP Fan Modules .....	3-114
Figure 3-30: –48 V BTS C-CCP and Power Conversion Shelf Fan Modules .....	3-114
Figure 3-31: Alarm Connector Location and Connector Pin Numbering .....	3-121
Figure 3-32: AMR Connector Pin Numbering .....	3-122
Figure 4-1: TX Mask Verification Spectrum Analyzer Display .....	4-12
Figure 4-2: Code Domain Power and Noise Floor Levels .....	4-14
Figure 5-1: MGLI2/GLI2 MMI Port Connection .....	5-6
Figure 5-2: Site and Span I/O Boards T1 Span Connections .....	5-9
Figure 6-1: CSM Front Panel Indicators & Monitor Ports .....	6-22
Figure 6-2: GLI2 Front Panel .....	6-25
Figure 6-3: GLI3 Front Panel .....	6-26
Figure 6-4: MCC Front Panel .....	6-28
Figure 6-5: MGLI/GLI Board MMI Connection Detail .....	6-30
Figure 6-6: GLI3 Board MMI Connection Detail .....	6-31
Figure E-1: North American PCS 1900 MHz Frequency Spectrum .....	E-2
Figure E-2: North American Cellular Telephone System Frequency Spectrum .....	E-5
Figure E-3: 1700 MHz PCS Frequency Spectrum .....	E-7
Figure F-1: Agilent E7495A Pre–Power Sensor Calibration connection .....	F-5
Figure F-2: Agilent E7495A Power Sensor Calibration connection .....	F-5
Figure F-3: Setting Agilent E4406A GPIB Address .....	F-6
Figure F-4: Setting Agilent E4432B GPIB Address .....	F-7
Figure F-5: Setting Advantest R3267 GPIB Address .....	F-8
Figure F-6: Advantest R3562 GPIB Address Switch Setting .....	F-9
Figure F-7: Agilent 8935 Test Set .....	F-10

Figure F-8: HP 8921A and HP 83236A/B .....	F-11
Figure F-9: R3465 Communications Test Set .....	F-12
Figure F-10: HP 437 Power Meter .....	F-14
Figure F-11: Gigatronics 8541C Power Meter Detail .....	F-15
Figure F-12: RS232 GPIB Interface Adapter .....	F-16
Figure F-13: Calibrating Test Setup Components .....	F-22
Figure F-14: Cable Calibration using Advantest R3465 .....	F-26
Figure F-15: Agilent E4406A Self–alignment .....	F-27
Figure H-1: Delta Calibration Setup – HP8921A to HP437B .....	H-4
Figure H-2: Delta Calibration Setup – HP8921A to HP8921A .....	H-5
Figure H-3: Delta Calibration Setup – R3561L to HP437B .....	H-7
Figure H-4: Delta Calibration Setup – R3561L to R3465 .....	H-7
Figure H-5: Delta Calibration Setup – HP8935 to HP437B .....	H-9
Figure H-6: Delta Calibration Setup – HP8935 to HP8935 .....	H-9
Figure H-7: Delta Calibration Setup – Agilent E4432B to HP437 .....	H-12
Figure H-8: Delta Calibration Setup – Agilent E4432B to Agilent E4406A .....	H-12
Figure H-9: Optimization/ATP Test Setup Using RFDS .....	H-14
Figure H-10: IS–95 A/B/C Optimization/ATP Test Setup Using RFDS .....	H-15
Figure I-1: Manual VSWR Test Setup Using HP8921 Test Set (1700/1900 MHz) .....	I-4
Figure I-2: Manual VSWR Test Setup Using HP8921 Test Set (800 MHz) .....	I-5
Figure I-3: Manual VSWR Test Setup Using Advantest R3465 .....	I-7
Figure J-1: Wiring Diagram, BTS Router Communication Rollover Cable .....	J-5
Figure J-2: Wiring Diagram, DB–9 Plug–to–8–contact Modular Plug Adapter .....	J-6
Figure J-3: LMF Computer Connections to BTS Router .....	J-7
Figure J-4: LMF Computer TFTP Connections to BTS Router .....	J-19

## List of Tables

FCC Part 68 Registered Devices .....	xviii
Table 1-1: CDMA LMF Test Equipment Support Table .....	1-9
Table 1-2: Abbreviations and Acronyms .....	1-13
Table 1-3: C–CCP Shelf/Cage Card/Module Device ID Numbers (Top Shelf) .....	1-16
Table 1-4: C–CCP Shelf/Cage Card/Module Device ID Numbers (Bottom Shelf) .....	1-16
Table 1-5: BTS Sector Configuration .....	1-30
Table 1-6: Sector Configurations .....	1-31
Table 2-1: Initial Installation of Boards/Modules .....	2-3
Table 2-2: DC Power Pre–test (BTS Frame) .....	2-6
Table 2-3: DC Power Pre–test (RFDS) .....	2-12
Table 2-4: DC Input Power Cable Guidelines .....	2-13
Table 2-5: Common Power Supply Verification .....	2-14
Table 2-6: Initial Power-up (RFDS) .....	2-15
Table 2-7: Initial Power–up (BTS) .....	2-15
Table 3-1: Install LMF using CD ROM .....	3-10
Table 3-2: Copying CDF or NECF Files to the LMF Computer .....	3-11
Table 3-3: Creating a Named Hyperlink Connection for MMI Connection .....	3-13
Table 3-4: T1/E1 Span Isolation .....	3-16
Table 3-5: LMF to BTS Connection .....	3-17
Table 3-6: BTS GUI Login Procedure .....	3-26
Table 3-7: BTS CLI Login Procedure .....	3-28
Table 3-8: BTS GUI Logout Procedure .....	3-29
Table 3-9: BTS CLI Logout Procedure .....	3-30
Table 3-10: Establishing MMI Communications .....	3-31
Table 3-11: Pinging the Processors .....	3-34
Table 3-12: Verify GLI ROM Code Loads .....	3-37
Table 3-13: Download and Enable MGLI .....	3-38
Table 3-14: Download RAM Code and Data to Non–GLI Devices .....	3-39
Table 3-15: Select CSM Clock Source .....	3-40
Table 3-16: Enable CSMs .....	3-41
Table 3-17: Enable MCCs .....	3-42
Table 3-18: Enable Redundant GLIs .....	3-42
Table 3-19: Test Equipment Setup (GPS & LFR/HSO Verification) .....	3-46
Table 3-20: GPS Initialization/Verification .....	3-49
Table 3-21: LFR Initialization/Verification .....	3-53
Table 3-22: HSO Initialization/Verification .....	3-55
Table 3-23: IS–95 A/B Test Equipment Setup .....	3-58
Table 3-24: CDMA2000 1X/IS–95A/B Test Equipment Interconnection .....	3-59
Table 3-25: Selecting Test Equipment Manually in a Serial Connection Tab .....	3-76

Table 3-26: Selecting Test Equipment Using Auto-Detect .....	3-77
Table 3-27: Test Equipment Calibration .....	3-78
Table 3-28: Test Cabling Calibration using Comm. System Analyzer .....	3-80
Table 3-29: Calibrating TX/Duplexed RX Cables Using Signal Generator & Spectrum Analyzer ..	3-81
Table 3-30: Calibrating Non–Duplexed RX Cables Using a Signal Generator & Spectrum Analyzer	3-82
Table 3-31: Setting Cable Loss Values .....	3-83
Table 3-32: Setting TX Coupler Loss Value .....	3-84
Table 3-33: BLO BTS.cal File Array Assignments .....	3-87
Table 3-34: BTS.cal File Array (Per Sector) .....	3-87
Table 3-35: Set Up Test Equipment for RF Path Calibration .....	3-89
Table 3-37: All Cal/Audit and TX Calibration Procedure .....	3-92
Table 3-38: Download BLO .....	3-94
Table 3-39: BTS TX Path Audit .....	3-96
Table 3-40: All Cal/Audit Test .....	3-97
Table 3-41: Create CAL File .....	3-98
Table 3-42: RFDS Parameter Settings .....	3-100
Table 3-43: Definition of Parameters .....	3-102
Table 3-44: Valid NAM Field Ranges .....	3-103
Table 3-45: Set Antenna Map Data .....	3-104
Table 3-46: Set RFDS Configuration Data .....	3-105
Table 3-47: RFDS TSIC Calibration Channel Frequencies .....	3-106
Table 3-48: RFDS Calibration Procedure .....	3-107
Table 3-49: Program the TSU NAM .....	3-108
Table 3-50: Test Equipment Setup for Redundancy/Alarm Tests .....	3-110
Table 3-51: Power Supply/Converter Redundancy (BTS Frame) .....	3-111
Table 3-52: Miscellaneous Alarm Tests .....	3-113
Table 3-53: BBX Redundancy Alarms .....	3-115
Table 3-54: CSM, GPS, & LFR/HSO, Redundancy/Alarm Tests .....	3-116
Table 3-55: Power Amplifier Redundancy Test .....	3-118
Table 3-56: MGLI/GLI Redundancy Test (with MM Connection Established) .....	3-119
Table 3-57: CDI Alarm Input Verification Using the Alarms Test Box .....	3-122
Table 3-58: CDI Alarm Input Verification Without the Alarms Test Box .....	3-124
Table 3-59: Pin and Signal Information for Alarm Connectors .....	3-126
Table 4-1: ATP Test Procedure .....	4-9
Table 4-2: Generating an ATP Report .....	4-16
Table 5-1: Copying CAL Files to a Diskette .....	5-2
Table 5-2: Procedures to Copy CAL Files from Diskette to the CBSC .....	5-3
Table 5-3: External Test Equipment Removal .....	5-4
Table 5-4: BTS Span Parameter Configuration .....	5-5
Table 5-5: Set BTS Span Parameter Configuration .....	5-6
Table 5-6: Terminate the LMF Session and Remove the LMF .....	5-8

Table 5-7: T1/E1 Span/IFM Connections .....	5-9
Table 5-8: Reset BTS Devices and Remote Site Initialization .....	5-10
Table 6-1: Login Failure Troubleshooting Procedures .....	6-3
Table 6-2: Troubleshooting a Power Meter Communication Failure .....	6-3
Table 6-3: Troubleshooting a Communications Analyzer Communication Failure .....	6-4
Table 6-4: Troubleshooting Code Download Failure .....	6-5
Table 6-5: Troubleshooting Data Download Failure .....	6-5
Table 6-6: Troubleshooting Device Enable (INS) Failure .....	6-6
Table 6-7: Miscellaneous Failures .....	6-6
Table 6-8: Troubleshooting BLO Calibration Failure .....	6-7
Table 6-9: Troubleshooting Calibration Audit Failure .....	6-8
Table 6-10: Troubleshooting Forward Link Failure (BTS Passed Reduced ATP) .....	6-9
Table 6-11: Troubleshooting TX Mask Measurement Failure .....	6-9
Table 6-12: Troubleshooting Rho and Pilot Time Offset Measurement Failure .....	6-9
Table 6-13: Troubleshooting Code Domain Power and Noise Floor Measurement Failure .....	6-10
Table 6-14: Troubleshooting Multi-FER Failure .....	6-11
Table 6-15: No GLI Control via LMF (all GLIs) .....	6-16
Table 6-16: No GLI Control through Span Line Connection (Both GLIs) .....	6-16
Table 6-17: MGLI Control Good – No Control over Co-located GLI .....	6-16
Table 6-18: MGLI Control Good – No Control over AMR .....	6-17
Table 6-19: No BBX Control in the Shelf – No Control over Co-located GLIs .....	6-17
Table 6-20: MGLI Control Good – No (or Missing) Span Line Traffic .....	6-17
Table 6-21: No MCC Channel Elements .....	6-18
Table 6-22: No DC Input Voltage to Power Supply Module .....	6-19
Table 6-23: No DC Input Voltage to any C-CCP Shelf Module .....	6-20
Table 6-24: TX and RX Signal Routing Problems .....	6-20
Table 6-25: Troubleshoot Control Link Failure .....	6-29
Table 6-26: Set BTS Span Parameter Configuration .....	6-32
Table A-1: Verification of Test Equipment Used .....	A-2
Table A-2: Site Checklist .....	A-3
Table A-3: Preliminary Operations .....	A-3
Table A-4: Pre-power Checklist .....	A-4
Table A-5: Pre-power Checklist .....	A-5
Table A-6: GPS Receiver Operation .....	A-6
Table A-7: LFR Receiver Operation .....	A-7
Table A-8: LPA IM Reduction .....	A-8
Table A-9: LPA Convergence .....	A-9
Table A-10: TX BLO Calibration (3-S: 1-C, and 2- and 4-C Non-adjacent Channels) .....	A-10
Table A-11: TX BLO Calibration (3-S: 2-C Adjacent Channels) .....	A-11
Table A-12: TX BLO Calibration (3-S: 3- or 4-C Adjacent Channels) .....	A-12
Table A-13: TX BLO Calibration (6-S: 1-C, 2-C Non-adjacent Channels) .....	A-15



Table A-14: BTS Redundancy/Alarm Tests .....	A-17
Table A-15: TX Antenna VSWR .....	A-17
Table A-16: RX Antenna VSWR .....	A-18
Table A-17: AMR CDI Alarm Input Verification .....	A-18
Table B-1: PnMask I and PnMask Q Values for PilotPn .....	B-3
Table C-1: When RF Optimization is required on the BTS .....	C-2
Table C-2: When to Optimize Inter-frame Cabling .....	C-3
Table C-3: SC 4812T BTS Optimization and ATP Test Matrix .....	C-4
Table D-1: BBX Gain Set Point vs. Actual BTS Output (in dBm) .....	D-2
Table E-1: 1900 MHz TX and RX Frequency vs. Channel .....	E-3
Table E-2: 800 MHz TX and RX Frequency vs. Channel .....	E-5
Table E-3: 1700 MHz TX and RX Frequency vs. Channel (Korean Bands) .....	E-8
Table F-1: Set IP Address on Agilent E7495A test set .....	F-3
Table F-2: Detecting Agilent E7495A Test Equipment .....	F-4
Table F-3: E7495A Power Sensor Calibration .....	F-4
Table F-4: Verify and Change Agilent E4406A GPIB Address .....	F-6
Table F-5: Verify and Change Agilent E4432B GPIB Address .....	F-7
Table F-6: Verify and Change Advantest R3267 GPIB Address .....	F-8
Table F-7: Verify and/or Change Agilent 8935 (formerly HP 8935) GPIB Address .....	F-10
Table F-8: Verify and/or Change HP 8921A and HP 83236A GPIB Addresses .....	F-11
Table F-9: Verify and/or Change Advantest R3465 GPIB Address .....	F-12
Table F-10: Verify and/or Change Motorola CyberTest GPIB Address .....	F-13
Table F-11: Verify and/or Change HP 437 Power Meter GPIB Address .....	F-14
Table F-12: Verify and/or Change Gigatronix 8541C Power Meter GPIB Address .....	F-15
Table F-13: System Connectivity .....	F-18
Table F-14: Manual Cable Calibration Test Equipment Setup (using the HP PCS Interface) .....	F-19
Table F-15: HP PCS Interface Test Equipment Setup for Manual Testing .....	F-23
Table F-16: Procedure for Calibrating Test Cable Setup Using Advantest R3465 .....	F-24
Table F-17: Agilent E4406A Self-alignment (Calibration) .....	F-27
Table G-1: Download ROM Code .....	G-2
Table H-1: HP8921A Power Delta Calibration Procedure .....	H-3
Table H-2: Advantest Power Delta Calibration Procedure .....	H-5
Table H-3: HP8935 Power Delta Calibration Procedure .....	H-8
Table H-4: Agilent E4406A Power Delta Calibration Procedure .....	H-10
Table H-5: In-Service Calibration .....	H-16
Table I-1: VSWR Measurement Procedure – HP Test Set .....	I-3
Table I-2: VSWR Measurement Procedure – Advantest Test Set .....	I-5
Table J-1: Establish HyperTerminal Connection .....	J-3
Table J-2: Establishing BTS Router Serial Communication .....	J-6
Table J-3: BTS Router Canned Configuration File FTP Transfer from the OMC–R .....	J-8
Table J-4: Set LMF Computer NIC IP Address and Create a Default TFTP Directory .....	J-17

---

Table J-5: Connecting the LMF Computer to the BTS Router for TFTP File Transfer . . . . .	J-20
Table J-6: BTS Router Power–up and Initial Ethernet Configuration . . . . .	J-20
Table J-7: Transfer Canned Configuration Files to the BTS Router Using a TFTP Server . . . . .	J-23
Table J-8: Transfer Canned Configuration File to CF Memory Card with CF Memory Card Reader . . . . .	J-30
Table J-9: Copy Canned Configuration File to BTS Router Startup Configuration and Verify IOS File Position . . . . .	J-33
Table J-10: Using a TFTP Server Application for Replacing Loaded IOS Version and Verifying File Sequence Position . . . . .	J-38
Table J-11: Using a CF Memory Card Reader for Replacing Loaded IOS Version and Verifying File Sequence Position . . . . .	J-45
Table J-12: Use CF Memory Card Reader to Place IOS File First in CF Memory Card File Sequence . . . . .	J-49
Table J-13: Verify and Replace Installed rommon Version Using a tftp Server . . . . .	J-58
Table J-14: Verify and Replace Installed rommon Version Using a CF Memory Card Reader . . . . .	J-64
Table J-15: Simple Recovery from BTS Router rommon Boot . . . . .	J-68
Table J-16: Extended Recovery from BTS Router rommon Boot . . . . .	J-72
Table J-17: Enter/Change BTS Router FE Interface IP Addresses & Operating Parameters . . . . .	J-75
Table J-18: Prepare for Site Turn–over . . . . .	J-84
Table J-19: Returning the Site to Operational Control . . . . .	J-84

## FCC Requirements

### Content

This section presents Federal Communications Commission (FCC) Rules Parts 15 and 68 requirements and compliance information for the SC™ 4812T/ET/ET Lite series Radio Frequency Base Transceiver Stations.

### FCC Part 15 Requirements

#### Part 15.19a(3) – INFORMATION TO USER

<b>NOTE</b>	This device complies with Part 15 of the FCC Rules. Operation is subject to the following two conditions: <ol style="list-style-type: none"><li>1. This device may not cause harmful interference, and</li><li>2. This device must accept any interference received, including interference that may cause undesired operation.</li></ol>
-------------	---

#### Part 15.21 – INFORMATION TO USER

<b>CAUTION</b>	Changes or modifications not expressly approved by Motorola could void your authority to operate the equipment.
----------------	---

#### 15.105(b) – INFORMATION TO USER

<b>NOTE</b>	<p>This equipment has been tested and found to comply with the limits for a Class B digital device, pursuant to Part 15 of the FCC Rules. These limits are designed to provide reasonable protection against harmful interference in a residential installation. This equipment generates, uses and can radiate radio frequency energy and, if not installed and used in accordance with the instructions, may cause harmful interference to radio communications. However, there is no guarantee that interference will not occur in a particular installation. If this equipment does cause harmful interference to radio or television reception, which can be determined by turning the equipment OFF and ON, the user is encouraged to try to correct the interference by one or more of the following measures:</p> <ul style="list-style-type: none"><li>• Reorient or relocate the receiving antenna.</li><li>• Increase the separation between the equipment and receiver.</li><li>• Connect the equipment into an outlet on a circuit different from that to which the receiver is connected.</li><li>• Consult the dealer or an experienced radio/TV technician for help.</li></ul>
-------------	--

## FCC Part 68 Requirements

This equipment complies with Part 68 of the Federal Communications Commission (FCC) Rules. A label on the GLI3 board, This equipment complies with Part 68 of the FCC rules and the requirements adopted by the ACTA. On the GLI3 board, easily visible with the board removed, is a label that contains, among other information, a product identifier in the format US: AAAAEQ##TXXXX. If requested, this number must be provided to the telephone company.

FCC Part 68 Registered Devices	
Device	Part 68 ID
Group Line Interface (GLI2) *See Note	US: IHEUSA-32769-XD-E
Group Line Interface (GLI3) *See Note	US: IHEXDNANGLI3-1X
Cisco Model 1900-27 Router	US: 5B1DDNDN0006
ADC KENTROX Model 537	US: F81USA-31217-DE-N
Hitachi MCC-DO	US: 83YXDNANMCCDO
<b>*NOTE:</b> The BTS equipment may be equipped with either the GLI2, <US: IHEUSA-32769-XD-E>, or the GLI3, < US: IHEXDNANGLI3-1X>, and the Hitachi MCC-DO, <US: 83YXDNANMCCDO>, and may be used in conjunction with one or both of the listed registered CSU devices, or another registered CSU device not listed above.	

A plug and jack used to connect this equipment to the premises wiring and telephone network must comply with the applicable FCC Part 68 rules and requirements adopted by the ACTA. A compliant telephone cord and modular plug is provided with this product. It is designed to be connected to a compatible modular jack that is also compliant. See installation instructions for details.

The REN is used to determine the number of devices that may be connected to a telephone line. Excessive RENs on a telephone line may result in the devices not ringing in response to an incoming call. In most but not all areas, the sum of RENs should not exceed five (5.0). To be certain of the number of devices that may be connected to a line, as determined by the total RENs, contact the local telephone company. For products approved after July 23, 2001, the REN for this product is part of the product identifier that has the format US:AAAEQ##TXXXX. The digits represented by ## are the REN without a decimal point (e.g., 03 is a REN of 0.3). For earlier products, the REN is separately shown on the label.

The telephone company may make changes in its facilities, equipment, operations, or procedures that could affect the operation of your T1. If this happens, the telephone company will provide advance notice so that you can modify your equipment as required to maintain uninterrupted service.

If this equipment causes harm to the telephone network, the telephone company will notify you in advance that temporary discontinuance of service may be required. If advance notice is not practical, the telephone company will notify you as soon as possible. Also, you will be advised of your right to file a complaint with the FCC if you believe it is necessary.

If you experience trouble operating this equipment with the T1, please contact:

Global Customer Network Resolution Center (CNRC)  
 1501 W. Shure Drive, 3436N  
 Arlington Heights, Illinois 60004  
 Phone Number: (847) 632-5390

for repair and/or warranty information. You should not attempt to repair this equipment yourself. This equipment contains no customer or user-serviceable parts.

Changes or modifications not expressly approved by Motorola could void your authority to operate this equipment.

## Foreword

### Scope of manual

This manual is intended for use by cellular telephone system craftspersons in the day-to-day operation of Motorola cellular system equipment and ancillary devices.

This manual is not intended to replace the system and equipment training offered by Motorola, although it can be used to supplement or enhance the knowledge gained through such training.

### Obtaining Manuals

To view, download, order manuals (original or revised), visit the Motorola Lifecycles Customer web page at <http://services.motorola.com>, or contact your Motorola account representative.

If Motorola changes the content of a manual after the original printing date, Motorola publishes a new version with the same part number but a different revision character.

### Text conventions

The following special paragraphs are used in this manual to point out information that must be read. This information may be set-off from the surrounding text, but is always preceded by a bold title in capital letters. The three categories of these special paragraphs are:

<b>NOTE</b>	Presents additional, helpful, non-critical information that you can use. <b>Bold-text notes indicate information to help you avoid an undesirable situation or provides additional information to help you understand a topic or concept.</b>
-------------	---

<b>CAUTION</b>	Presents information to identify a situation in which equipment damage could occur, thus avoiding damage to equipment.
----------------	--

<b>WARNING</b>	Presents information to warn you of a potentially hazardous situation in which there is a possibility of personal injury.
----------------	---

The following typographical conventions are used for the presentation of software information:

- In text, sans serif **BOLDFACE CAPITAL** characters (a type style without angular strokes: i.e., SERIF versus SANS SERIF) are used to name a command.
- In text, *typewriter* style characters represent prompts and the system output as displayed on an operator terminal or printer.
- In command definitions, sans serif **boldface** characters represent those parts of the command string that must be entered exactly as shown and *typewriter* style characters represent command output responses as displayed on an operator terminal or printer.
- In the command format of the command definition, *typewriter* style characters represent the command parameters.

## Reporting manual errors

To report a documentation error, call the CNRC (Customer Network Resolution Center) and provide the following information to enable CNRC to open an MR (Modification Request):

- the document type
  - the manual title, part number, and revision character
  - the page number(s) with the error
  - a detailed description of the error and if possible the proposed solution
- Motorola appreciates feedback from the users of our manuals.

## Contact us

Send questions and comments regarding user documentation to the email address below:

[cdma.documentation@motorola.com](mailto:cdma.documentation@motorola.com)

Motorola appreciates feedback from the users of our information.

## Manual banner definitions

A banner (oversized text on the bottom of the page, for example, **PRELIMINARY**) indicates that some information contained in the manual is not yet approved for general customer use.

## 24-hour support service

If you have problems regarding the operation of your equipment, please contact the Customer Network Resolution Center for immediate assistance. The 24 hour telephone numbers are:

NA CNRC	+1–800–433–5202
EMEA CNRC	+44– (0) 1793–565444
ASPAC CNRC	+86–10–88417733
Japan & Korea CNRC	+81–3–5463–3550
LAC CNRC	+51–1–212–4020

For further CNRC contact information, contact your Motorola account representative.

## General Safety

**Remember! . . . Safety depends on you!!**

The following general safety precautions must be observed during all phases of operation, service, and repair of the equipment described in this manual. Failure to comply with these precautions or with specific warnings elsewhere in this manual violates safety standards of design, manufacture, and intended use of the equipment. Motorola, Inc. assumes no liability for the customer's failure to comply with these requirements. The safety precautions listed below represent warnings of certain dangers of which we are aware. You, as the user of this product, should follow these warnings and all other safety precautions necessary for the safe operation of the equipment in your operating environment.

### Ground the instrument

To minimize shock hazard, the equipment chassis and enclosure must be connected to an electrical ground. If the equipment is supplied with a three-conductor ac power cable, the power cable must be either plugged into an approved three-contact electrical outlet or used with a three-contact to two-contact adapter. The three-contact to two-contact adapter must have the grounding wire (green) firmly connected to an electrical ground (safety ground) at the power outlet. The power jack and mating plug of the power cable must meet International Electrotechnical Commission (IEC) safety standards.

<b>NOTE</b>	Refer to <i>Grounding Guideline for Cellular Radio Installations – 68P81150E62</i> .
-------------	--

### Do not operate in an explosive atmosphere

Do not operate the equipment in the presence of flammable gases or fumes. Operation of any electrical equipment in such an environment constitutes a definite safety hazard.

### Keep away from live circuits

Operating personnel must:

- not remove equipment covers. Only Factory Authorized Service Personnel or other qualified maintenance personnel may remove equipment covers for internal subassembly, or component replacement, or any internal adjustment.
- not replace components with power cable connected. Under certain conditions, dangerous voltages may exist even with the power cable removed.
- always disconnect power and discharge circuits before touching them.

### Do not service or adjust alone

Do not attempt internal service or adjustment, unless another person, capable of rendering first aid and resuscitation, is present.

**Use caution when exposing or handling the CRT**

Breakage of the Cathode-Ray Tube (CRT) causes a high-velocity scattering of glass fragments (implosion). To prevent CRT implosion, avoid rough handling or jarring of the equipment. The CRT should be handled only by qualified maintenance personnel, using approved safety mask and gloves.

**Do not substitute parts or modify equipment**

Because of the danger of introducing additional hazards, do not install substitute parts or perform any unauthorized modification of equipment. Contact Motorola Warranty and Repair for service and repair to ensure that safety features are maintained.

**Dangerous procedure warnings**

Warnings, such as the example below, precede potentially dangerous procedures throughout this manual. Instructions contained in the warnings must be followed. You should also employ all other safety precautions that you deem necessary for the operation of the equipment in your operating environment.

<b>WARNING</b>	Dangerous voltages, capable of causing death, are present in this equipment. Use extreme caution when handling, testing, and adjusting.
----------------	---



## Revision History

### Manual Number

68P09258A31–A

### Manual Title

1X SC™ 4812T BTS Optimization/ATP

### Version Information

The following table lists the manual version, date of version, and remarks on the version. Revision bars printed in page margins (as shown to the side) identify material which has changed from the previous release of this publication.

Version Level	Date of Issue	Remarks
1	Aug 2003	FOA
A	Oct 2003	General Availability



---

*Chapter 1*

# **Introduction**

# Optimization Manual: Scope and Layout

## Manual Scope and Layout

This document provides information pertaining to the optimization and audit tests of Motorola SC 4812T Base Transceiver Subsystem (BTS) equipment frames equipped with trunked high-power Power Amplifiers (PAs) and their associated internal and external interfaces.

Also covered is Software Release R2.16.3.x which supports the following versions of SC 4812T BTS sites:

- 1X Circuit BTS
- 1X Packet backhaul BTS

The 1X packet BTS has a packet backhaul network interface which is provided via a pair of routers together with a GLI upgrade (GLI3) that can handle voice (IS-95A/B, 1X) and data (IS-95B, 1X).

This BTS equipment is configured with all 1X cards (BBX-1X and MCC1X) or a mix of 1X cards and non-1X cards (BBX2 and MCC8E/24E). This configuration is compliant with all applicable cdma2000 1X specifications. It provides the forward link and reverse link RF functions to support 2G features and 3G-1X features (i.e., high capacity voice and high bit rate data).

The 1X circuit BTS has a split backhaul (circuit/packet pipe) network interface that can handle circuit based voice (IS-95A/B, 1X) and data (IS-95B) as well as packet based data (1X).

## Assumptions and Prerequisites

This document assumes the following prerequisites: The BTS frames and cabling have been installed per the *SC Product Family Frame Mounting Guide* manual, which covers the physical “bolt down” of all SC series equipment frames, and the *1X SC 4812T BTS Hardware Installation* manual, which covers BTS specific cabling configurations.

In most applications the same test procedure is used for all equipment variations. However, decision break points are provided throughout the procedure when equipment specific tests are required.

**NOTE**

As the Code Division Multiple Access (CDMA) Local Maintenance Facility (LMF) capability comes on-line, applicable LMF based procedures will be incorporated. Eventually, only the CDMA LMF platform will be supported as the recommended customer method of interfacing with and servicing the SC series BTS equipment.

We at Motorola Technical Information Products and Services have strived to incorporate into this document the many suggestions and inputs received from you, the customer, since the inception of the SC product line. At the same time, we have tried to insure that **the scope of the document targets both the novice and expert site technician and engineer with the information required to successfully perform the task at hand.**

## Document Composition

This document covers the following major areas.

- Introduction, consisting of preliminary background information (such as component and subassembly locations and frame layouts) to be considered by the Cellular Field Engineer (CFE) before optimization or tests are performed.
- Preliminary Operations, consisting of pre–power up tests, jumper configuration of BTS sub–assemblies, and initial application of power to the BTS equipment frames. Download of all BTS processor boards, and PAs.
- Optimization/Calibration, consisting of downloading all BTS processor boards, PA verification, radio frequency (RF) path verification, Bay Level Offset (BLO) calibration, and Radio Frequency Diagnostic System (RFDS) functions and calibration
- Acceptance Test Procedures (ATP), consisting of automated ATP scripts executed by the LMF and used to verify all major transmit (TX) and receive (RX) performance characteristics on all BTS equipment. Also generates an ATP report.
- Optional manual performance tests used to verify specific areas of site operation or to verify regulation compliance. These tests are typically used to isolate faults down to the module level and information necessary to better understand equipment operation.
- Site turnover after ATP is completed.
- Appendices include:
  - Data sheets for CFE’s recording at the site
  - Pseudorandom Noise (PN) Offset information
  - Optimization/ATP matrix
  - BBX Gain set point vs BTS output
  - CDMA operating frequency programming information
  - Manual test setup information
  - Downloading ROM and RAM code
  - In–service calibration procedures
  - GPIB addresses
  - Procedures for verifying that the Voltage Standing Wave Ratio (VSWR) of all antennas and associated feed lines fall within acceptable limits

# Purpose of the Optimization

## Why Optimize?

Proper optimization and calibration assures:

- Accurate downlink RF power levels are transmitted from the site.
- Accurate uplink signal strength determinations are made by the site.

## What Is Optimization?

Optimization compensates for the site-specific cabling and normal equipment variations. Cables that interconnect the BTS and Duplexer assemblies (if used), for example, are cut and installed at the time of the BTS frame installation at the site. Site optimization guarantees that the combined losses of the new cables and the gain/loss characteristics and built-in tolerances of each BTS frame do not accumulate, causing improper site operation.

## What Happens During Optimization?

**Overview** – During optimization, the accumulated path loss or gain is first determined for each RF transmit path in the BTS. These transmit path loss or gain values are then stored in a database along with RF receive path default values.

**RF path definitions** – For definitions of the BTS transmit (TX) and receive (RX) paths, see “Bay Level Offset Calibration” in Chapter 3.

**RF paths and transceiver optimization** – Six of the seven Broad Band Transceiver (BBX) boards in each CCP shelf are optimized to specific RX and TX antenna connectors. The seventh BBX board acts in a redundant capacity for BBX boards 1 through 6, and is optimized to *all* antenna connectors. A single optimization value is generated for each complete path. This eliminates the accumulation of error that would occur from individually measuring and summing the gain and loss of each element in the path.

**Using RF path gain/loss values** – BTS equipment factors in the derived optimization values internally to adjust transceiver power levels, leaving only site-specific antenna feedline loss and antenna gain characteristics to be factored in by the CFE when determining required site Effective Radiated Power (ERP) output power levels.

# When to Optimize

## New Installations

The following operations and optimization/test actions should be accomplished for a new BTS or frame installation:

1. After the initial site installation, it must be prepared for operation. This preparation includes verifying hardware installation, initial power-up, download of operating code, and Clock Synchronization Module (CSM) verification.
2. Next, the optimization is performed. Optimization includes performance verification and calibration of all transmit and receive RF paths, and download of accumulated calibration data.
3. A calibration audit of all RF transmit paths may be performed any time after optimization to verify BTS calibration.
4. After optimization, a series of manual pre-Acceptance Test Procedure (ATP) verification tests are performed to verify alarm/redundancy performance.
5. After manual pre-ATP verification tests, an ATP is performed to verify BTS performance. An ATP is also required to demonstrate regulation compliance before the site can be placed in service.

## Site Expansion

Optimization is required after expansion of a site with additional BTS frames.

## Periodic Optimization

Periodic optimization of a site may also be required, depending on the requirements of the overall system.

## Repaired Sites

Refer to Appendix C for a detailed FRU Optimization/ATP Test Matrix outlining the minimum tests that must be performed *any time* a BTS RF subassembly or cable associated with an RF path is replaced.

# Required Test Equipment and Software

## Overview

Test equipment and software described in this section is required for the optimization procedure. Common assorted tools such as screwdrivers and frame keys are also needed. Read the owner's manual for all of the test equipment to understand its individual operation before using the tool in the optimization.

## Policy

To ensure consistent, reliable, and repeatable optimization test results, test equipment and software meeting the following technical criteria should be used to optimize the BTS equipment. Test equipment can, of course, be substituted with other test equipment models *if the equipment meets the same technical specifications*.

<b>NOTE</b>	During manual testing, you can, of course, substitute test equipment with other test equipment models not supported by the LMF, <i>but those models must meet the same technical specifications</i> .
-------------	---

*It is the responsibility of the customer to account for any measurement variances and/or additional losses/inaccuracies that can be introduced as a result of these substitutions.* Before beginning optimization or troubleshooting, make sure that the test equipment needed is on-hand and operating properly.

## Test Equipment Calibration

Optimum system performance and capacity depend on regular equipment service, calibration prior to BTS optimization. Follow the original equipment manufacturer (OEM) recommended maintenance and calibration schedules closely.

## Test Cable Calibration

Test cables can make critical differences in optimization accuracy. It is recommended that cable calibration be run at every BTS with the complete *test equipment set*. This method compensates for test cable insertion loss within the test equipment itself. No other allowance for test cable insertion loss needs to be made during the performance of tests.

Another method to account for cable loss is by entering it into the LMF during the optimization procedure. This method requires accurate test cable characterization using shop test equipment. Characterized cables should be tagged with the characterization information, and the measured losses entered into the LMF before field optimization.



## Equipment Warm-up

After arriving at a site, test equipment should be plugged in and turned on immediately to provide the longest possible time for warm up and stabilization. The following pieces of test equipment must be warmed-up for *a minimum of 60 minutes* prior to using for BTS optimization or RFDS calibration procedures.

- Communications Test Set (Agilent E7495A requires only 30 minutes).
- Rubidium Time Base.
- Power Meter.

## LMF computer and software

### LMF Hardware Requirements

An LMF computer platform that meets the following requirements (or better) is recommended:

- Notebook computer
- 266 MHz (32-bit CPU) Pentium processor
- MS® Windows 98® Second Edition (SE) or *Windows 2000* operating system
- 4 GB internal hard disk drive
- SVGA 12.1-inch active matrix color display with 1024 x 768 (recommended) or 800 x 600 pixel resolution and capability to display more than 265 colors

<b>NOTE</b>	If 800 x 600 pixel resolution is used, the LMF window must be maximized after it is displayed.
-------------	--

- Memory requirements:
  - Minimum required RAM: 96 MB
  - Recommended RAM:
    - 128 MB for Windows 98 SE
    - 256 MB for Windows 2000
- 20X CD ROM drive
- 3 1/2 inch floppy drive
- 56kbps V.90 modem
- Serial port (COM 1)
- Parallel port (LPT 1)
- PCMCIA Ethernet interface card (for example, 3COM Etherlink III) with a 10Base-T-to-coax adapter

### LMF Software

The Local Maintenance Facility (LMF) application program is a graphical user interface (GUI)-based software tool. This product is specifically designed to provide cellular communications field personnel with the capability to support the following CDMA Base Transceiver Station (BTS) operations:

- Installation
- Maintenance
- Calibration
- Optimization

### Ethernet LAN Transceiver

- PCMCIA Ethernet Adapter + Ethernet UTP Adapter  
3COM Model – Etherlink III 3C589B

### 10BaseT/10Base2 Converter

- Transition Engineering Model E-CX-TBT-03 10BaseT/10Base2 Converter

**NOTE** Xircom Model PE3-10B2 or equivalent can also be used to interface the LMF Ethernet connection to the frame.

### 3C-PC-COMBO CBL

- Connects to the 3COM PCMCIA card and eliminates the need for a 10BaseT/10base2 Converter.

### RS-232 to GPIB Interface

- National Instruments GPIB-232-CT with Motorola CGDSEDN04X RS232 serial null modem cable or equivalent; used to interface the LMF to the test equipment.
- Standard RS-232 cable can be used with the following modifications (see Figure 1-1):
  - This solution passes only the 3 minimum electrical connections between the LMF and the General Purpose Information Bus (GPIB) interface. The control signals are jumpered as enabled on both ends of the RS-232 cable (9-pin D). TX and RX signals are crossed as Null Modem effect. Pin 5 is the ground reference.
  - Short pins 7 and 8 together, and short pins 1, 4, and 6 together on each connector.

**Figure 1-1:** Null Modem Cable Detail

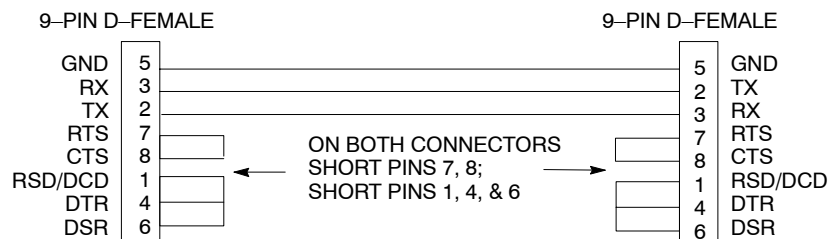

FW00362

**MMI Interface Kit**

Motorola cable part number CGDSMMICABLE219112 is used to connect the LMF to the BTS.

**Communications system analyzer CDMA/analog****Table 1-1: CDMA LMF Test Equipment Support Table**

Item	Description	Test Capability
<b>Test Sets</b>		
Hewlett Packard, model HP 8921A (with 83203B)	Communications analyzer (includes 83203B CDMA interface option)	IS–95A/B only
Hewlett Packard, model HP 83236A	PCS interface for PCS band	IS–95A/B only
Motorola CyberTest	Communications analyzer	IS–95A/B only
Advantest R3465 (with 3561L)	Communications analyzer (with 3561 CDMA option)	IS–95A/B only
Agilent E4406A (with E4432B)	Communications analyzer (with Generator)	IS–95A/B and CDMA 2000 testing
Advantest R3267 Analyzer (with R3562)	Communications Analyzer with Advantest R3562 Generator	IS–95A/B and CDMA 2000 testing
Agilent 8935 series E6380A (formerly HP 8935) with option 200 or R2K	Communications test set	IS–95A/B and CDMA 2000 testing
Agilent E7495A	Communications test set	IS–95A/B and CDMA 2000 testing
<b>Power Meters</b>		
Gigatronix 8541C	Power meter	
HP437B (with HP8481A sensor)	Power meter with sensor – capable of measuring –30 dBm to 20 dBm	

A combination of test equipment supported by the LMF may also be used during optimization and testing of the RF communications portion of BTS equipment when the communications system analyzer does not perform all of the following functions:

- Frequency counter
- Deviation meter
- RF power meter (average and code domain)
- RF signal generator (capable of DSAT/CDMA modulation)
- Audio signal generator
- AC voltmeter (with 600–ohm balanced audio input and high impedance input mode)
- Noise measurement meter
- C–Message filter
- Spectrum analyzer
- CDMA code domain analyzer

### **GPIB Cables**

- Hewlett Packard 10833A or equivalent; 1 to 2 meters (3 to 6 feet) long used to interconnect test equipment and LMF terminal.

### **Timing Reference Cables**

- *Two* BNC-male to BNC-male RG316 cables; 3.05 m (10 ft.) long. Used to connect the communications analyzer to the front timing reference of the CSM cards in the BTS frame.

### **Digital Multimeter**

- Fluke Model 8062A with Y8134 test lead kit or equivalent; used for precision dc and ac measurements, requiring 4-1/2 digits.

### **Directional Coupler**

- Narda Model 30661 30 dB (Motorola part no. 58D09732W01) 1900 MHz coupler terminated with two Narda Model 375BN-M loads, or equivalent.
- Narda Model 30445 30 dB (Motorola Part No. 58D09643T01 ) 800 MHz coupler terminated with two Narda Model 375BN-M loads, or equivalent.

### **RF Attenuator**

- 20 dB fixed attenuator, 20 W (Narda 768-20); used with 1.7/1.9 GHz test cable calibrations or during general troubleshooting procedures.

### **RF Terminations/Loads**

- At least three 100-Watt (or larger) non-radiating RF terminations/loads.

### **Miscellaneous RF Adapters, Loads, etc**

- As required to interface test cables and BTS equipment and for various test set ups. Should include at least two 50 Ohm loads (type N) for calibration and one RF short, two N-Type Female-to-Female Adapters.

### **LAN Cable**

- BNC-to BNC 50 ohm coaxial cable [.91 m (3 ft) maximum] with an F-to-F adapter, used to connect the 10BaseT-to-coaxial adapter to the BTS LAN connector.

### **High-impedance Conductive Wrist Strap**

- Motorola Model 42-80385A59; used to prevent damage from Electrostatic Discharge (ESD) when handling or working with modules.

## Optional Equipment

**NOTE**

Not all optional equipment specified here will be supported by the LMF in automated tests or when executing various measure type command line interface (CLI) commands. It is meant to serve as a list of additional equipment that might be required during maintenance and troubleshooting operations.

### Frequency Counter

- Stanford Research Systems SR620 or equivalent. If direct measurement of the 3 MHz or 19.6608 MHz references is required.

### Spectrum Analyzer

- Spectrum Analyzer (HP8594E with CDMA personality card) or equivalent; required for *manual* tests.

### Local Area Network (LAN) Tester

- Model NETcat 800 LAN troubleshooter (or equivalent); used to supplement LAN tests using the ohmmeter.

### Span Line (T1/E1) Verification Equipment

- As required for local application

### Oscilloscope

- Tektronics Model 2445 or equivalent; for waveform viewing, timing, and measurements or during general troubleshooting procedure.

### 2–way Splitter

- Mini–Circuits Model ZFSC–2–2500 or equivalent; provides the diversity receive input to the BTS

### High Stability 10 MHz Rubidium Standard

- Stanford Research Systems SR625 or equivalent – required for CSM and Low Frequency Receiver/High Stability Oscillator (LFR/HSO) frequency verification.

### Itasca Alarms Test Box

- Itasca CGDSCMIS00014 – This test box may be used as a tool to assist in the testing of customer alarms.

# Required Documentation

## Required Documents

The following documents are required to perform optimization of the cell site equipment:

- Site Document (generated by Motorola Systems Engineering), which includes:
  - General Site Information
  - Floor Plan
  - RF Power Levels
  - Frequency Plan (includes Site PN and Operating Frequencies)
  - Channel Allocation (Paging, Traffic, etc.)
  - Board Placement
  - Site Wiring List
  - CDF or NECF files (bts-#.cdf or bts-#.necf and cbsc-#.cdf)
- Demarcation Document (Scope of Work Agreement)
- Equipment manuals for non-Motorola test equipment

## Related Publications

Additional, detailed information about the installation, operation, and maintenance of the SC4812T BTS and its components is included in the following publications:

- *BTS Frame Installation Manual*; 68P09226A18
- *1X SC 4812T BTS Hardware Installation* ; 68P09258A55
- *1X SC 4812T BTS FRU Guide* ; 68P09258A64
- *CDMA LMF Operator's Guide*; 68P64114A78
- *CDMA RFDS Hardware Installation manual*; 68P64113A93
- *CDMA RFDS User's Guide*, 68P64113A37
- *LMF CLI Commands, R16*, 68P09253A56

## Terms and Abbreviations

### Standard and Non-standard Terms and Abbreviations

Standard terms and abbreviations used in this manual are defined in *Cellular Glossary of Terms and Acronyms; 68P09213A95*. Any non-standard terms or abbreviations included in this manual are listed in Table 1-2.

Acronym	Definition
1X	One of two bandwidths currently defined in the IS-2000 CDMA specification, which extends the capability of the IS-95A and B specifications. 1X bandwidth provides wireless packet voice and data transmission capability at up to 144 Mbps.
BBX-1X	Broadband Transceiver, 3rd Generation supports IS-95A/B and cdma2000 1X
BBX2	Broadband Transceiver, 2nd Generation supports IS-95A/B
BBXR	Redundant BBX for a CCP shelf or cage.
C-CCP	Combined CDMA Channel Processor
CCD	Clock Combining and Distribution. CCP shelf module which accepts timing signals from the active source and distributes them to other CCP shelf modules.
CIO	Combiner Input/Output
DRDC	Duplexer/RX Filter/Directional Coupler
EMPC	Expansion Multicoupler Preselector Card
FWTIC	Fixed Wireless Terminal Interface Card
GLI2	Group Line Interface, 2nd Generation card hardware version
GLI3	Group Line Interface, 3rd Generation card hardware version for packet backhaul
HSO	High Stability Oscillator
HSOX	High Stability Oscillator Expansion
LIF	Load Information File
LORAN	LONG RANGE Navigational
MCC8E	Multichannel CDMA Card supporting 8 IS-95A/B channels.
MCC24E	Multichannel CDMA Card supporting 24 IS-95A/B channels.
MCC-1X	Multichannel CDMA Card supporting 16 or 48 CDMA2000 1X or (with Software Release 2.16.0.84.3 and higher) IS-95A/B channels.
MPC	Multicoupler Preselector Card
NECB	Network Element Configuration Baseline
NECF	Network Element Configuration File
NECJ	Network Element Configuration Journal
OLF	Object List File. File containing a list of the ROM and RAM code versions which should be operating on every device installed in a BTS. The file is resident on the Central Base Station Controller (CBSC) Mobility Manager (MM) and is passed to the GLI after a DLM job is invoked. The GLI uses the OLF to determine which devices require code download to meet the OLF-specified version.
PDA	Power Distribution Assembly

. . . continued on next page

**Table 1-2: Abbreviations and Acronyms**

Acronym	Definition
RGD	Remote Global Positioning System (GPS) Distribution. Module which provides distribution of digital timing information to up to four BTS RF modem frames (RFMFs) from a single Remote GPS receiver.
RGPS	Remote Global Positioning System. GPS receiver and signal distribution subsystem which provides digital timing information for up to four BTS RFMFs at a cell site.
RHSO	Remote High-Stability Oscillator. Subsystem which generates and distributes synchronization signals from a single HSO to up to four RF modem frames.
SBPF	Single Bandpass Filter
SNMP	Simple Network Management Protocol
SUA	Subscriber Unit Assembly
TRDC	Transmit Receive filter/Directional Coupler
UTC	Universal Time Coordinates



# BTS Equipment Identification

## Equipment Overview

The Motorola SC 4812T BTS can consist of the following equipment frames:

- At least one BTS starter frame
  - +27 V BTS (see Figure 1-2)
  - –48 V BTS (see Figure 1-3)
- Ancillary equipment frame (or wall mounted equipment)
- Expansion frames
  - +27 V BTS (see Figure 1-4)
  - –48 V BTS (see Figure 1-5)

## Ancillary Equipment Frame Identification

<b>NOTE</b>	Equipment listed below can be wall mounted or mounted in a standard 19 inch frame. The description assumes that all equipment is mounted in a frame for clarity.
-------------	--

If equipped with the RFDS option, the RFDS and directional couplers are the interface between the site antennas and the BTS or Modem frame. The RFDS equipment includes:

- Directional couplers
- Site receive bandpass/bandreject filters
- RFDS

## Logical BTS

The BTS software implements the logical BTS capability. Previously, all BTS frames co-located at a single site had to be identified in the network with separate and distinct BTS ID numbers. In the Logical BTS feature, all frames located at a single BTS site are identified with unique Frame ID numbers (Frame ID Numbers 1, 101, 201, 301) under a single (site) BTS ID number. A logical BTS can consist of up to four SC 4812T frames. When the LMF is connected to frame 1 of a logical BTS, you can access all devices in all of the frames that make up the logical BTS. A logical BTS requires a CDF/NECF file that includes equipage information for all of the logical BTS frames and their devices and a CBSC file that includes channel data for all of the logical BTS frames.

### Logical BTS Numbering

The first frame of a logical BTS has a **-1** suffix (e.g., **BTS-812-1**). Other frames of the logical BTS are numbered with suffixes, **-101**, **-201**, and **-301** (e. g. **BTS-812-201**). When you log into a BTS, a **FRAME** tab is displayed for each frame. If there is only one frame for the BTS, there is only one tab (e.g., **FRAME-282-1**) for BTS-282. If a logical BTS has more than one frame, there is a separate **FRAME** tab for each frame (e.g. **FRAME-438-1**, **FRAME-438-101**, and **FRAME-438-201** for a **BTS-438** that has three frames). If an RFDS is included in the CDF/NECF file, an **RFDS** tab (e.g., **RFDS-438-1**) is displayed.

Actions (e.g., ATP tests) can be initiated for selected devices in one or more frames of a logical BTS. Refer to the Select devices help screen for information on how to select devices.

### C-CCP Shelf Card/Module Device ID Numbers

All cards/modules/boards in the frames at a single site, assigned to a single BTS number, are also identified with unique Device ID numbers dependent upon the Frame ID number in which they are located. Refer to Table 1-3 and Table 1-4 for specific C-CCP Shelf Device ID numbers.

**Table 1-3: C-CCP Shelf/Cage Card/Module Device ID Numbers (Top Shelf)**

Frame #	Card/Module ID Number (Left to Right)																		
	Power (PS-1)	Power (PS-2)	Power (PS-3)	AMR -1	GLI2 -1	MCC						BBX						BBX-R	MPC/EMPC -1
1	-	-	-	1	1	1	2	3	4	5	6	1	2	3	4	5	6	R1	-
101	-	-	-	101	101	101	102	103	104	105	106	101	102	103	104	105	106	R101	-
201	-	-	-	201	201	201	202	203	204	205	206	201	202	203	204	205	206	R201	-
301	-	-	-	301	301	301	302	303	304	305	306	301	302	303	304	305	306	R301	-

**Table 1-4: C-CCP Shelf/Cage Card/Module Device ID Numbers (Bottom Shelf)**

Frame #	Card/Module ID Number (Left to Right)																					
	HSO/LFR	CSM -1	CSM -2	CCD A	CCD B		AMR -2	GLI2-2	MCC						BBX						SW	MPC/EMPC -2
1	-	1	2	-	-	-	2	2	7	8	9	10	11	12	7	8	9	10	11	12	-	-
101	-	101	102	-	-	-	102	102	107	108	109	110	111	112	107	108	109	110	111	112	-	-
201	-	201	202	-	-	-	202	202	207	208	209	210	211	212	207	208	209	210	211	212	-	-
301	-	301	302	-	-	-	302	302	307	308	309	310	311	312	307	308	309	310	311	312	-	-

Figure 1-2: +27 V SC 4812T BTS Starter Frame

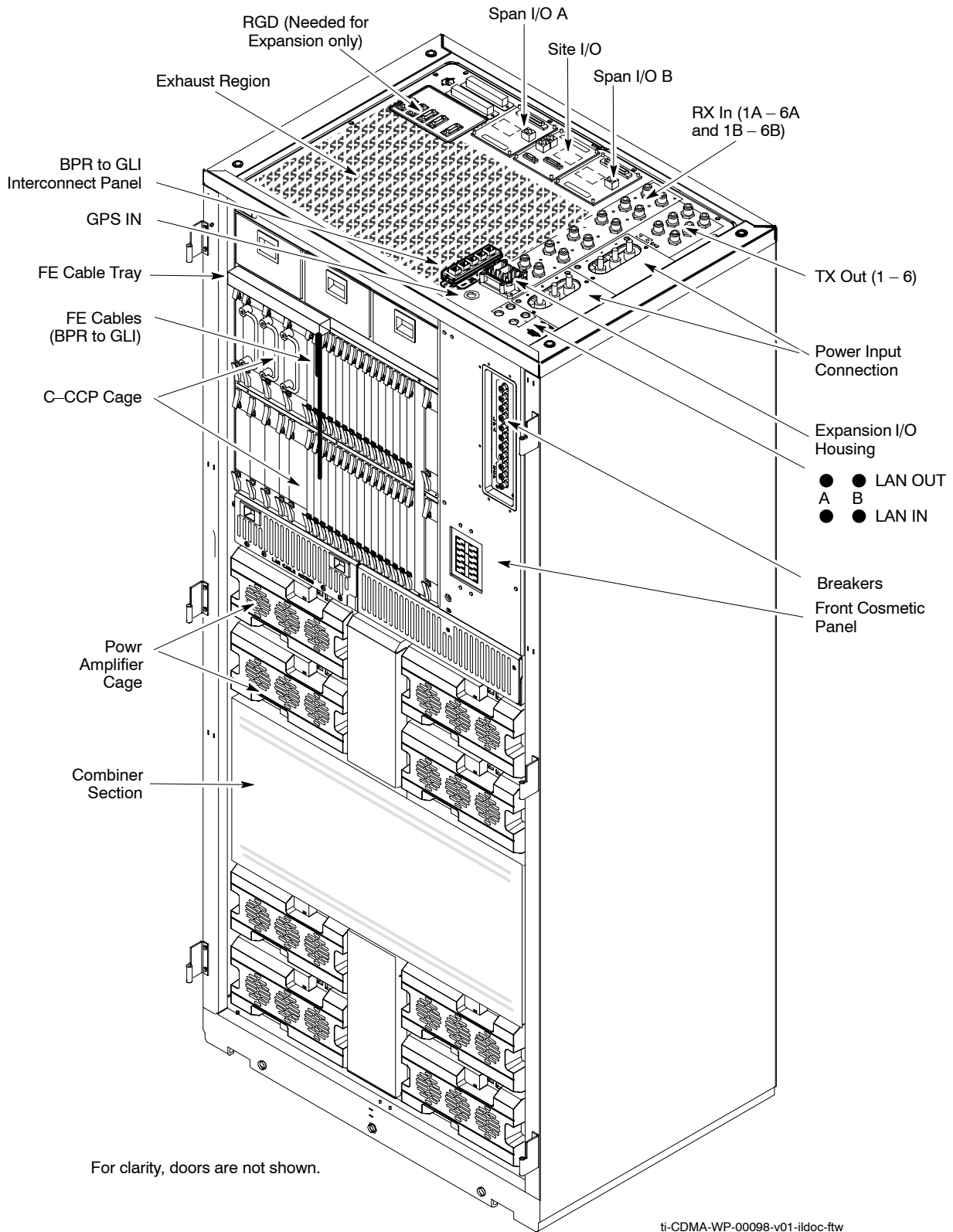

Figure 1-3: -48 V SC 4812T BTS Starter Frame (2100 mm)

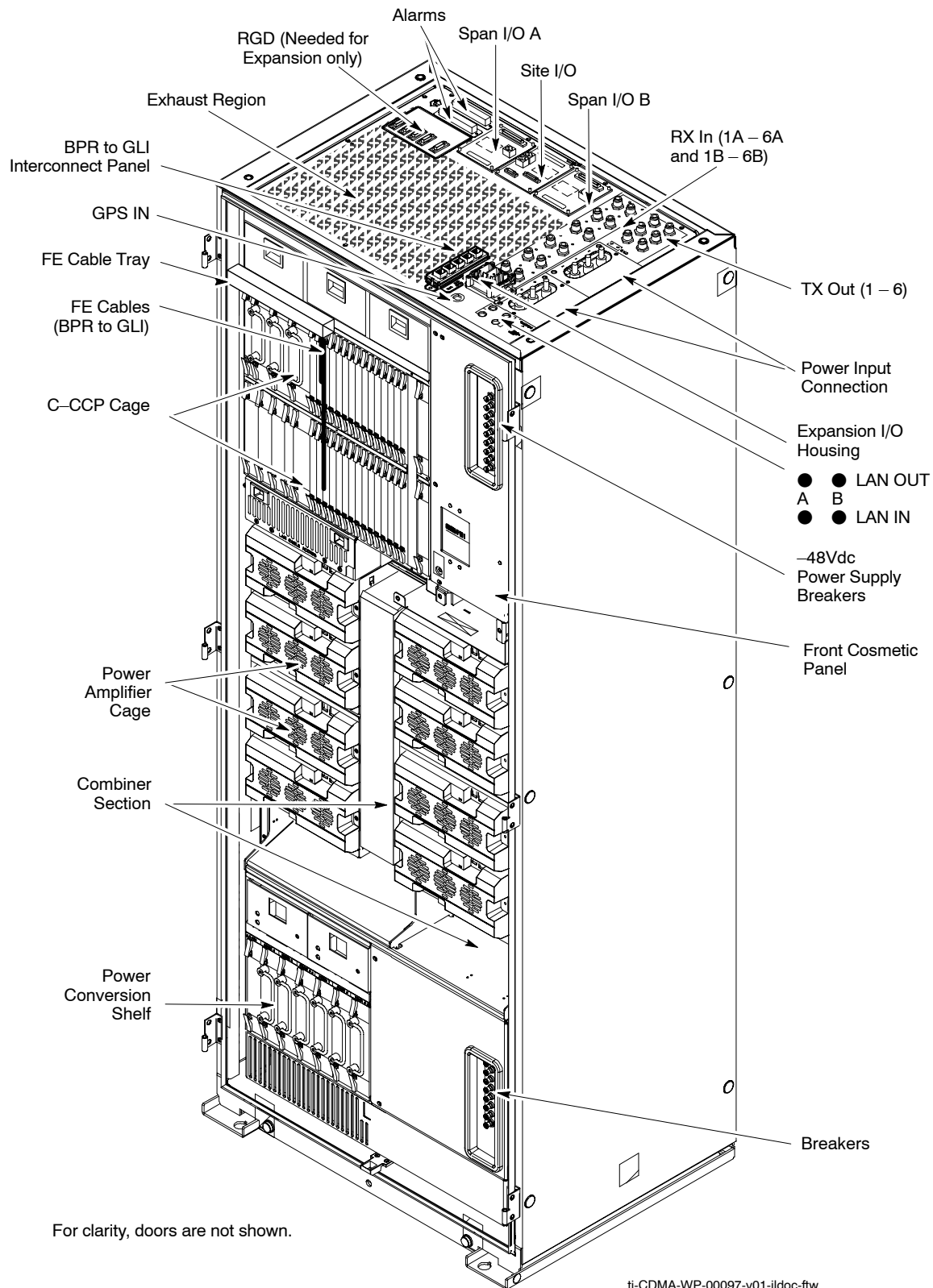
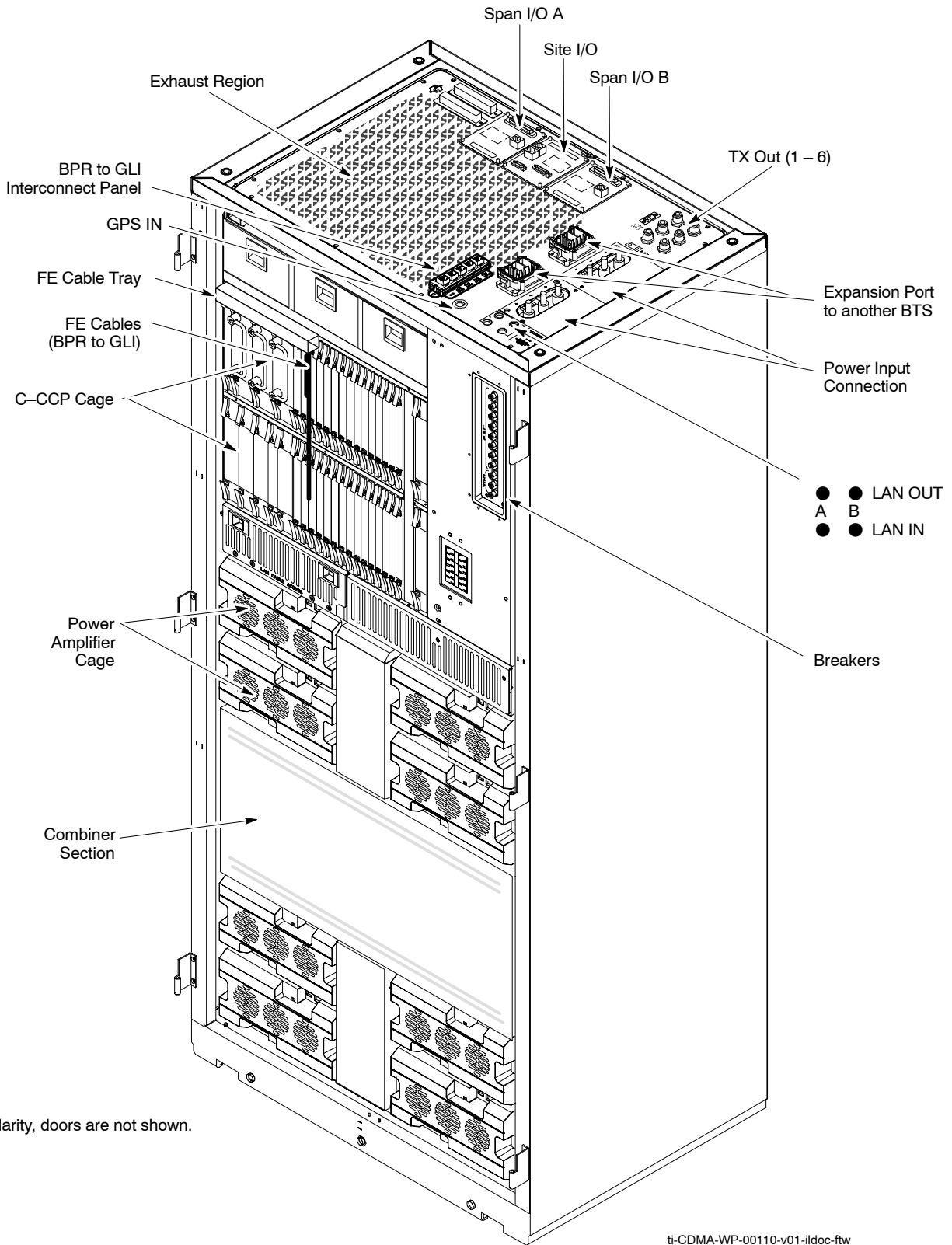

Figure 1-4: +27 V SC 4812T BTS Expansion Frame



For clarity, doors are not shown.

ti-CDMA-WP-00110-v01-ildoc-ftw

Figure 1-5: -48 V SC 4812T BTS Expansion Frame (2100 mm)

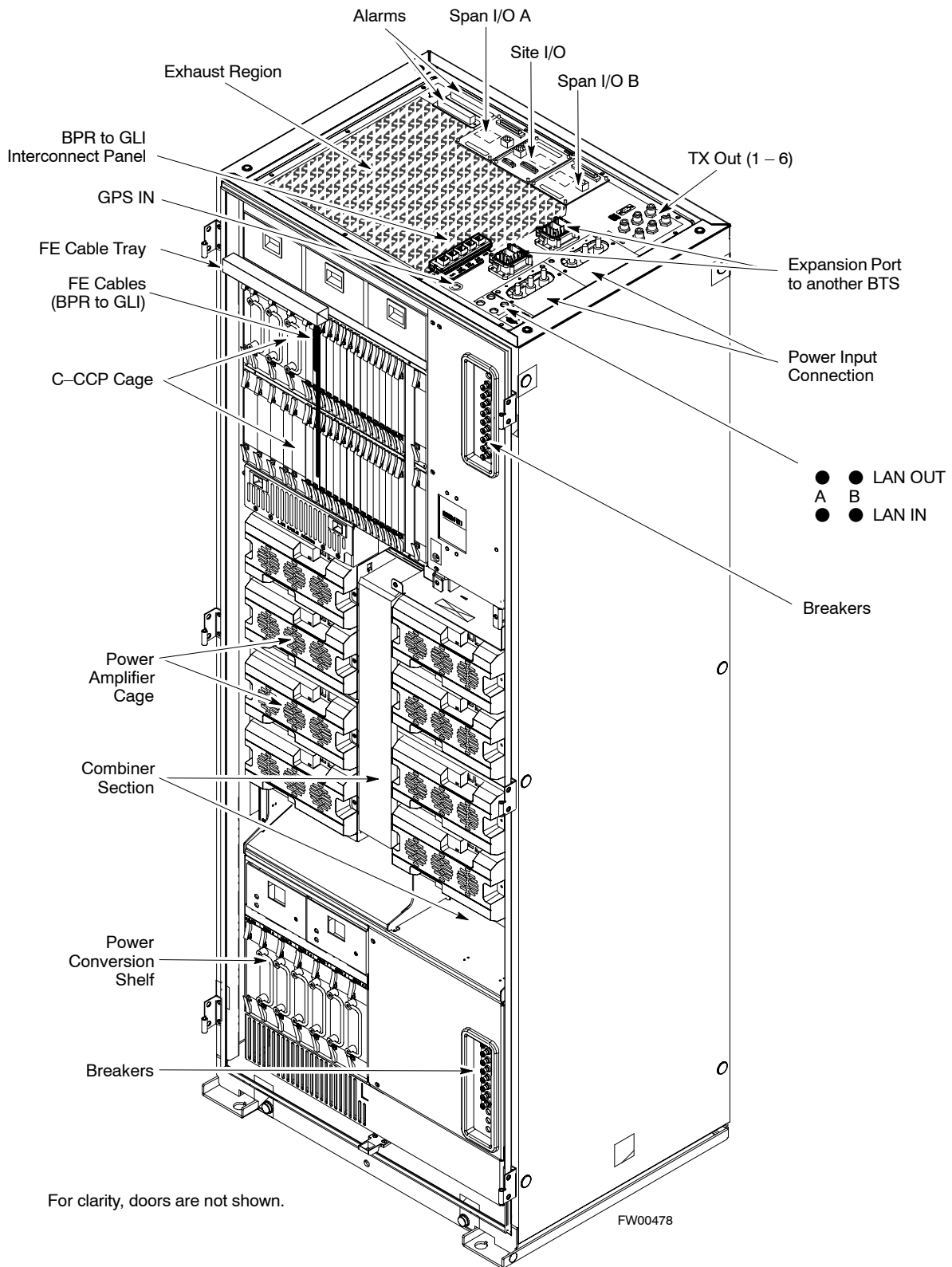

## BTS Frame Description

The BTS is the interface between the span lines to/from the Cellsite Base Station Controller (CBSC) and the site antennas. This frame is described in three sections:

- The top interconnect plate where all connections are made.
- The upper portion of the frame which houses circuit breakers, cooling fans, and the C-CCP shelf.
- The lower portion of the frame which houses the PA fans, PAs, and TX filter/combiners.
- The -48 V version of the BTS also has a section below the PAs containing a power conversion shelf that supplies power to the PAs.

Use the illustrations that follow to visually identify the major components, that make up the Motorola SC 4812T BTS frame.

### Top Interconnect Plate (see Figure 1-6 or Figure 1-7)

All cabling to and from the BTS equipment frames is via the interconnect panel on the top of each frame. Connections made here include:

- Span lines
- RX antennas
- TX antenna
- Alarm connections
- Power input
- LAN connections
- GPS input or Remote Global Positioning System (RGPS) on the Site I/O Board
- Remote Global Positioning System Distribution (RGD)
- LORAN-C Low Frequency Receiver (LFR) input
- Expansion frame connection
- Ground connections
- RJ-45 Pass-through Connectors

### C-CCP Shelf (see Figure 1-10)

- C-CCP backplane and cage
- Power supply modules
- CDMA clock distribution (CCD) boards
- CSM and HSO/LFR boards
- Alarm Monitoring and Reporting (AMR) boards
- GLI cards (may be GLI2 or GLI3)
- MPC/EMPC boards
  - MPC – starter frame only
  - EMPC – expansion frames
- Switch card
- MCC boards (may be MCC8E, MCC24, or MCC-1X)
- BBX boards (may be BBX2 or BBX-1X)
- CIO boards

**PA Shelves (see Figure 1-11 or Figure 1-12)**

- PA cages
- PA trunking backplanes
- Single Tone Linear Power Amplifier (STLPA, or more commonly referred to as “PA”) modules
- PA fan modules
- PA Combiner Cage (+27 V BTS)
- TX filter combiners or bandpass filters

**–48 V Power Conversion Shelf (see Figure 1-15)**

- Power conversion backplane and shelf
- Power conversion boards
- Power conversion alarm card
- Fan modules
- Power distribution assembly
- Air plenum



# I/O Interconnect Plates

Figure 1-6: +27 V SC 4812T Starter Frame I/O Interconnect Plate

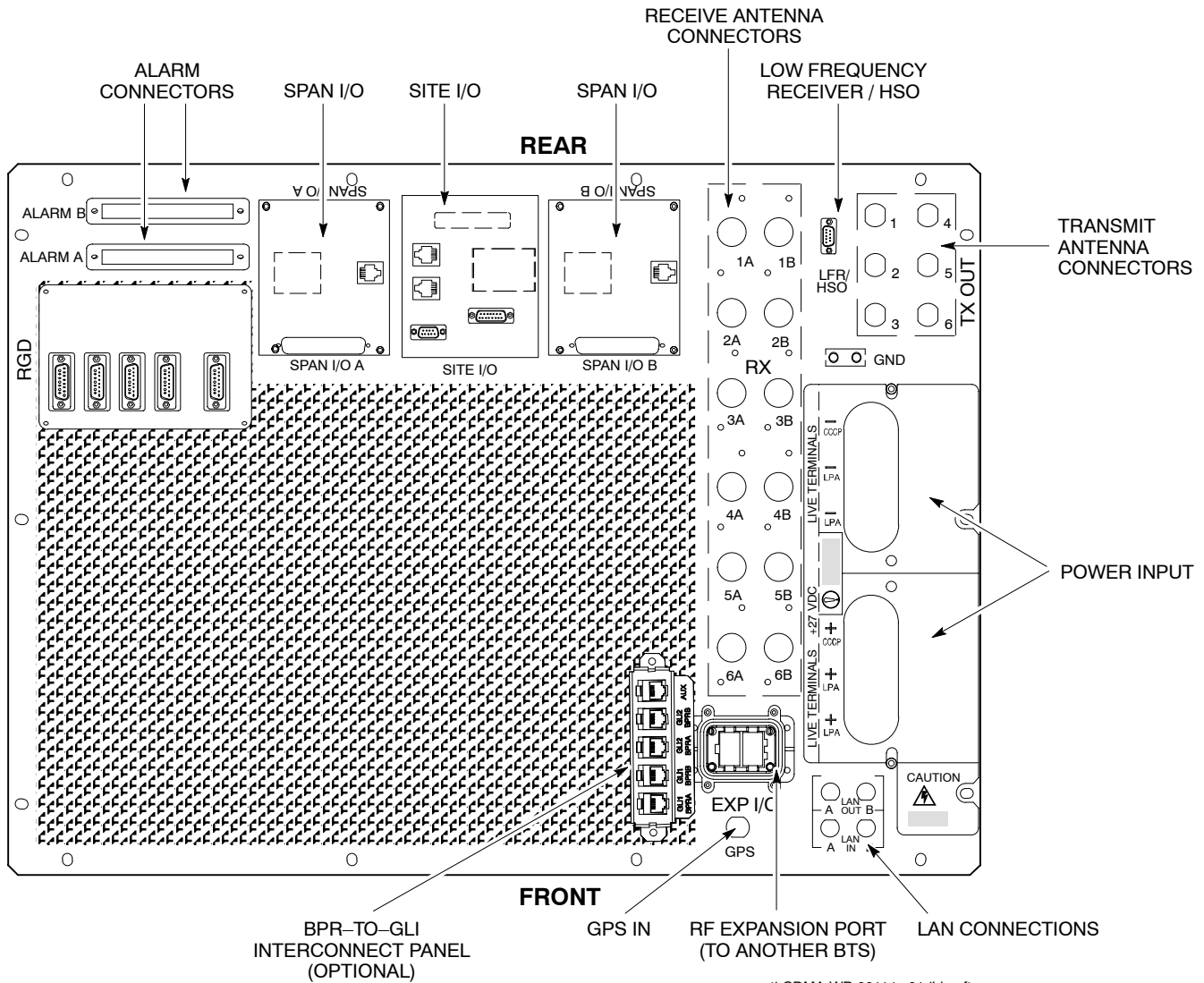

ti-CDMA-WP-00114-v01-ildoc-ftw

Figure 1-7: -48 V SC 4812T Starter Frame I/O Interconnect Plate

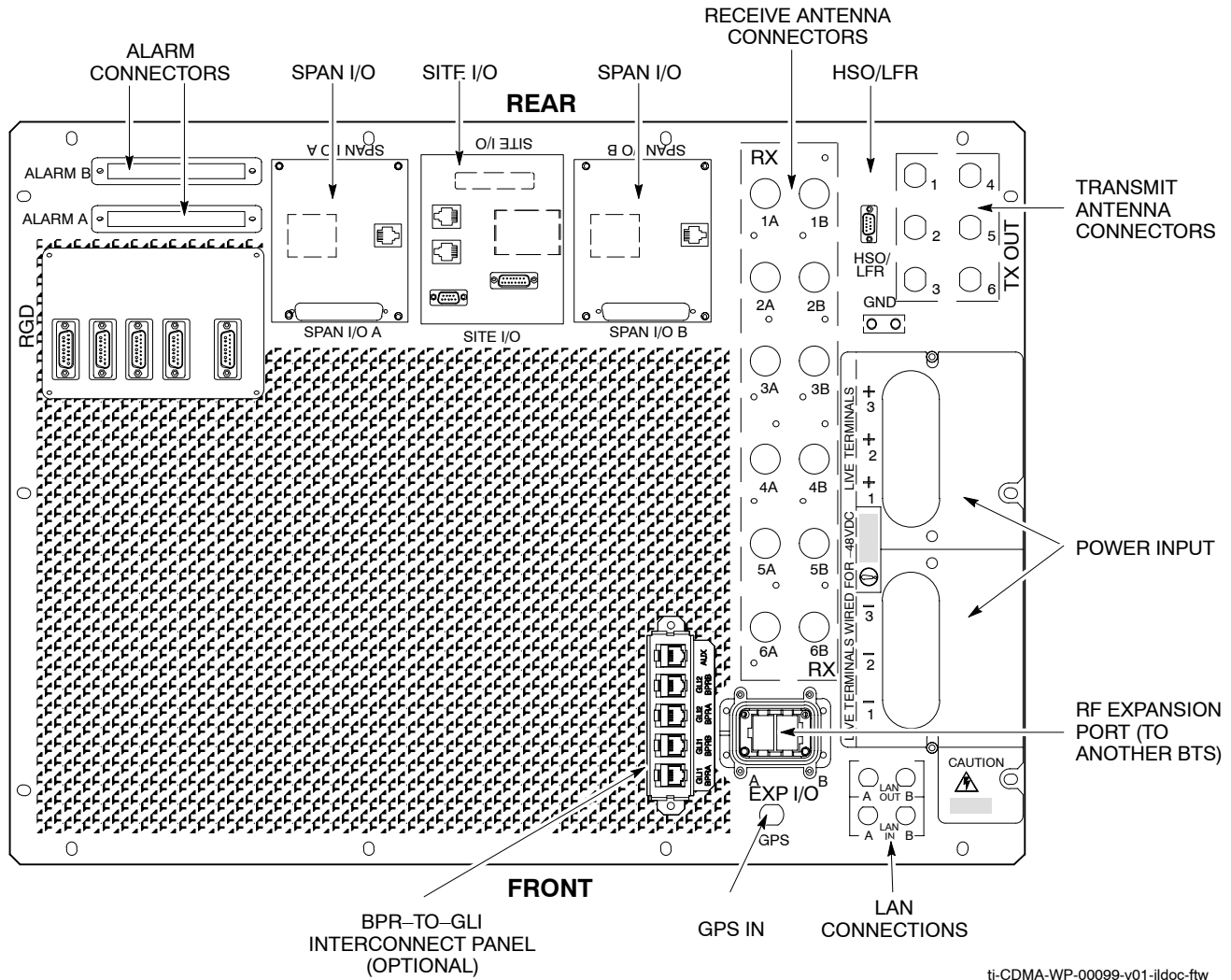

ti-CDMA-WP-00099-v01-ildoc-ftw

Figure 1-8: +27 V SC 4812T Expansion Frame I/O Interconnect Plate

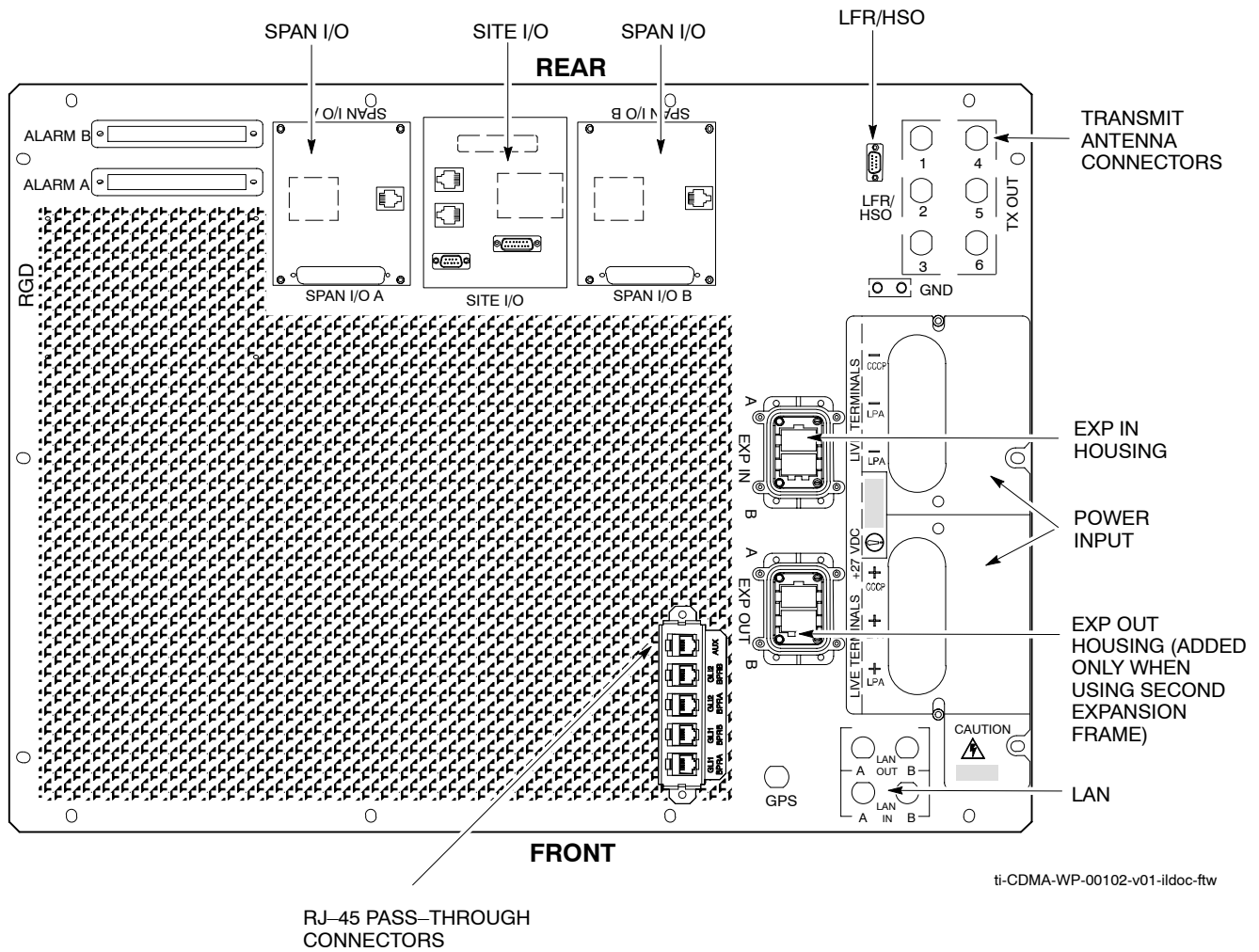
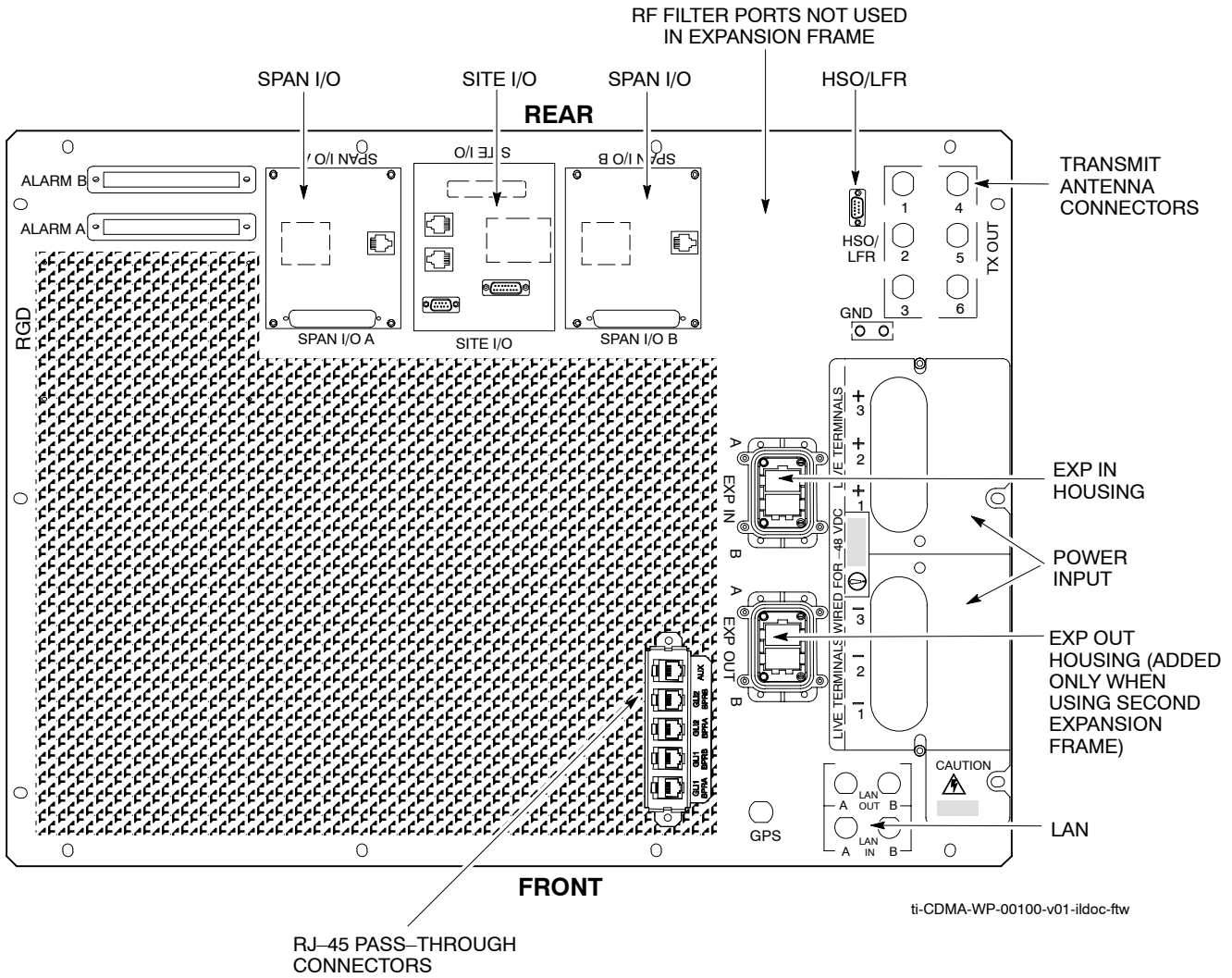
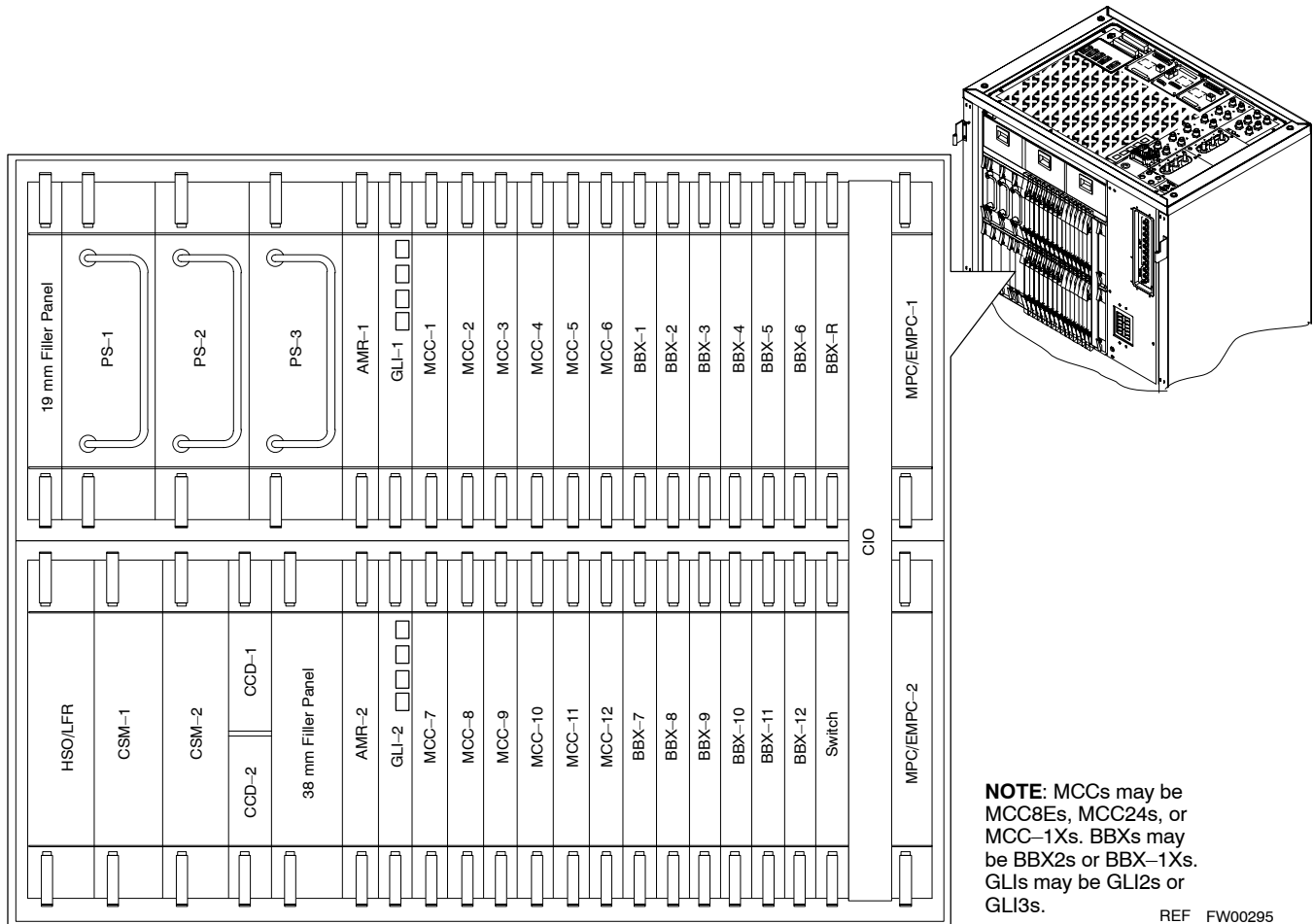

Figure 1-9: -48 V SC 4812T Expansion Frame I/O Interconnect Plate



## Combined CDMA Channel Processor Shelf

**Figure 1-10:** SC 4812T Combined CDMA Channel Processor (C-CCP) Shelf



### BBX-1X and BBX2 Interchangeability

In a BSS operating with R16.0 software, BBX-1X cards can be used as direct replacements for BBX2 cards; however, *different types of BBXs should not be mixed on the same carrier*. Therefore, if a BBX2 card is replaced with a BBX-1X, all remaining BBX2 cards for the carrier supported by the replaced card must also be replaced with BBX-1X cards.

# Linear Power Amplifier Shelf

Figure 1-11: +27 V SC 4812T PA Configuration – 4 Carrier with 2:1 Combiners

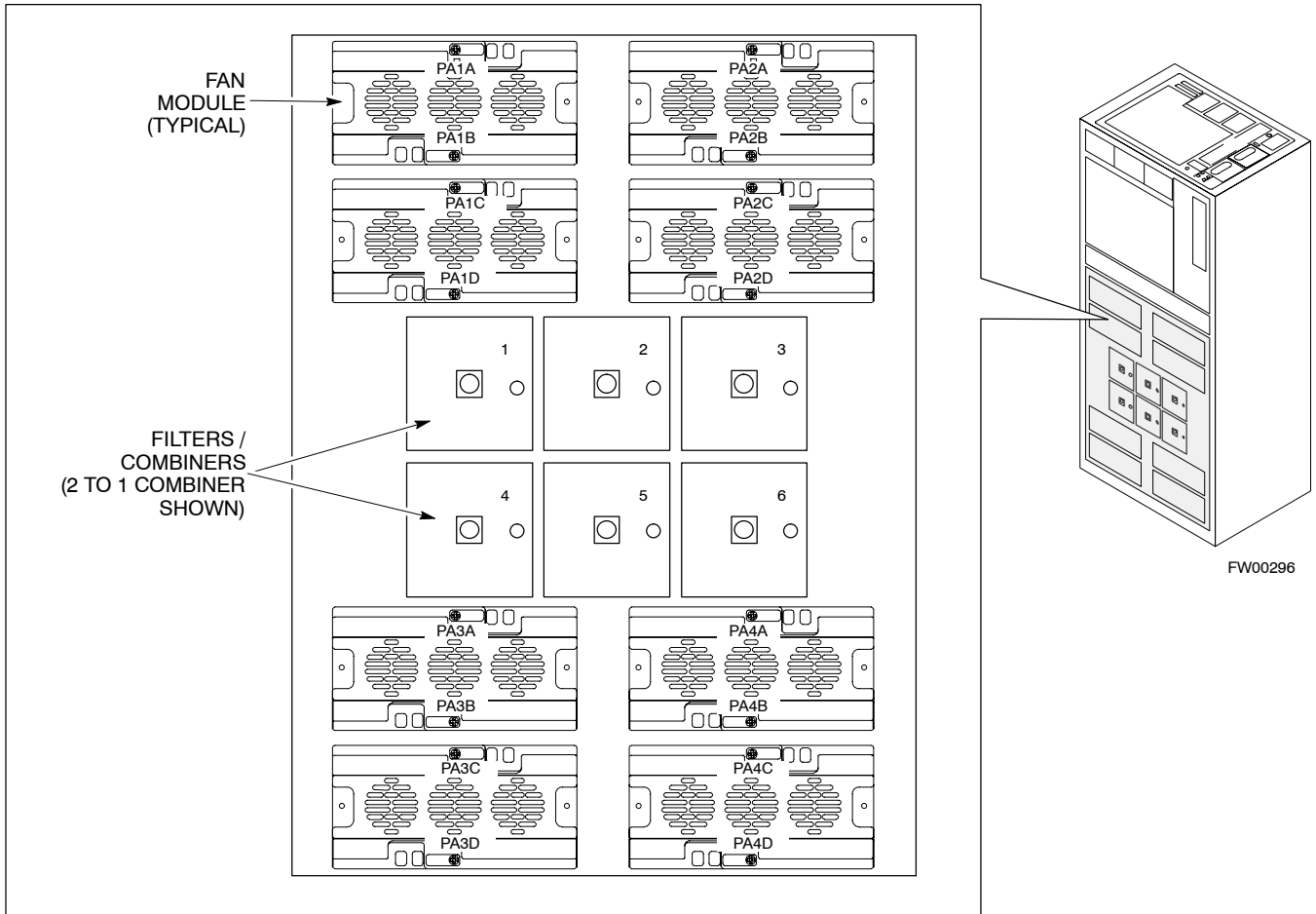

**4-CARRIER CONFIGURATION**

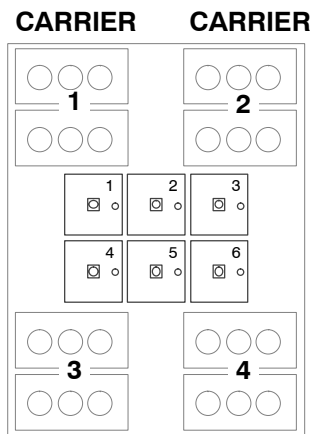

**Note**  
 No adjacent carriers may exist within the same TX filter combiner. "Adjacent" is defined as  $f_{c1}$  and  $f_{c2}$  being 1.25 MHz apart (center-to-center). "Non-adjacent" is defined as  $f_{c1}$  and  $f_{c2}$  being  $\geq 2.50$  MHz apart (center-to-center).



**Figure 1-12:** -48 V SC 4812T PA Configuration – 4 Carrier, 3-Sector with 2:1 Combiners

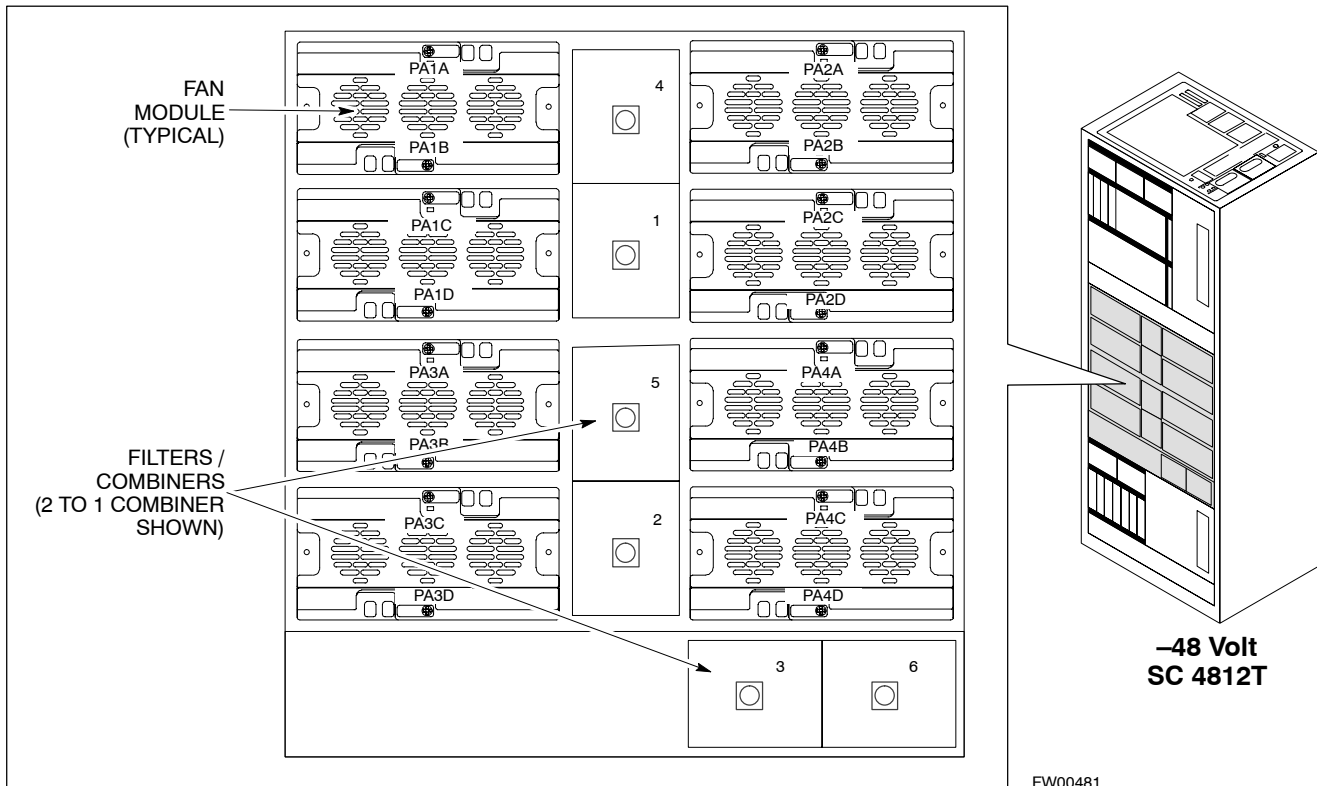

**4-CARRIER CONFIGURATION**

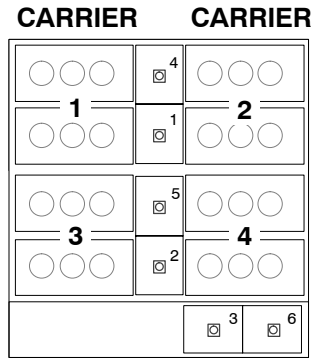

**Note**  
 No adjacent carriers may exist within the same TX filter combiner. "Adjacent" is defined as  $f_{c1}$  and  $f_{c2}$  being 1.25 MHz apart (center-to-center). "Non-adjacent" is defined as  $f_{c1}$  and  $f_{c2}$  being  $\geq 2.50$  MHz apart (center-to-center).

## BTS Sector Configuration

There are a number of ways to configure the BTS frame. Table 1-5 outlines the basic requirements. When carrier capacity is greater than two, a 2:1 or 4:1 cavity combiner must be used. For one or two carriers, bandpass filters or cavity combiners may be used, depending on sectorization and channel sequencing.

<b>Number of carriers</b>	<b>Number of sectors</b>	<b>Channel spacing</b>	<b>Filter requirements</b>
1	3 or 6	N/A	Bandpass Filter, Cavity Combiner (2:1 or 4:1)
2	6	Non-adjacent	Cavity Combiner (2:1 Only)
2	6	Adjacent	<b>Not supported</b> in single frame
2	3	Non-adjacent	Cavity Combiner (2:1 or 4:1)
2	3	Adjacent	Bandpass Filter
3,4	3	Non-adjacent	Cavity Combiner (2:1 or 4:1)
3,4	3	Adjacent	Cavity Combiner (2:1 Only)



**NOTE** In Table 1-6, BBXs may be BBX2s or BBX-1Xs.

Table 1-6: Sector Configurations							
Config Ref. No.	Description						
1	<b>3-Sector/2-ADJACENT Carriers</b> – The configuration below maps TX with optional 2:1 cavity combiners for 3 sectors/2 carriers for <i>adjacent</i> channels. Note that 2:1 cavity combiners are used (6 total).						
	<b>TX1</b>	<b>TX2</b>	<b>TX3</b>	<b>TX4</b>	<b>TX5</b>	<b>TX6</b>	<b>Carrier#</b>
	BBX-1 N/A	BBX-2 N/A	BBX-3 N/A	N/A BBX-7	N/A BBX-8	N/A BBX-9	1 2
2	<b>6-Sector/2-NON-ADJACENT Carriers</b> – The configuration below maps TX with 2:1 cavity combiners for 6 sectors/2 carriers for <i>non-adjacent</i> channels.						
	<b>TX1</b>	<b>TX2</b>	<b>TX3</b>	<b>TX4</b>	<b>TX5</b>	<b>TX6</b>	<b>Carrier#</b>
	BBX-1 BBX-7	BBX-2 BBX-8	BBX-3 BBX-9	BBX-4 BBX-10	BBX-5 BBX-11	BBX-6 BBX-12	1 2
3	<b>3-Sector/2-NON-ADJACENT Carriers</b> – The configuration below maps TX with 2:1 cavity combiners for 3 sectors/2 carriers for <i>non-adjacent</i> channels.						
	<b>TX1</b>	<b>TX2</b>	<b>TX3</b>	<b>TX4</b>	<b>TX5</b>	<b>TX6</b>	<b>Carrier#</b>
	BBX-1 BBX-7	BBX-2 BBX-8	BBX-3 BBX-9	N/A N/A	N/A N/A	N/A N/A	1 2
4	<b>3-Sector/4-ADJACENT Carriers</b> – The configuration below maps TX with 2:1 cavity combiners for 3 sector/4 carriers for <i>adjacent</i> channels.						
	<b>TX1</b>	<b>TX2</b>	<b>TX3</b>	<b>TX4</b>	<b>TX5</b>	<b>TX6</b>	<b>Carrier#</b>
	BBX-1 N/A	BBX-2 N/A	BBX-3 N/A	N/A BBX-7	N/A BBX-8	N/A BBX-9	1 2
	BBX-4 N/A	BBX-5 N/A	BBX-6 N/A	N/A BBX-10	N/A BBX-11	N/A BBX-12	3 4
	<b>3-Sector / 2-ADJACENT Carriers</b> – The configuration below maps TX with bandpass filters for 3 sectors/2 carriers for <i>adjacent</i> channels.						
5	<b>TX1</b>	<b>TX2</b>	<b>TX3</b>	<b>TX4</b>	<b>TX5</b>	<b>TX6</b>	<b>Carrier#</b>
	BBX-1 N/A	BBX-2 N/A	BBX-3 N/A	N/A BBX-7	N/A BBX-8	N/A BBX-9	1 2
	<b>3-Sector/3 or 4-NON-ADJACENT Carriers</b> – The configuration below maps TX with 4:1 cavity combiners for 3 sectors/3 or 4 carriers for <i>non-adjacent</i> channels.						
6	<b>TX1</b>	<b>TX2</b>	<b>TX3</b>	<b>TX4</b>	<b>TX5</b>	<b>TX6</b>	<b>Carrier#</b>
	BBX-1 BBX-7	BBX-2 BBX-8	BBX-3 BBX-9	N/A N/A	N/A N/A	N/A N/A	1 2
	BBX-4 BBX-10	BBX-5 BBX-11	BBX-6 BBX-12	N/A N/A	N/A N/A	N/A N/A	3 4
	<b>6-Sector/1-Carrier</b> – The configuration below maps TX with either bandpass filters or 2:1 cavity combiners for 6 sector/1 carrier.						
	7	<b>TX1</b>	<b>TX2</b>	<b>TX3</b>	<b>TX4</b>	<b>TX5</b>	<b>TX6</b>
BBX-1		BBX-2	BBX-3	BBX-4	BBX-5	BBX-6	1

Figure 1-13: +27 V SC4812T PA Configuration with Combiners/Filters

**Note: See Table 1-6 Configuration Reference Numbers 1, 2, 3, 4.**

**Note: See Table 1-6 Configuration Reference Number 6.**

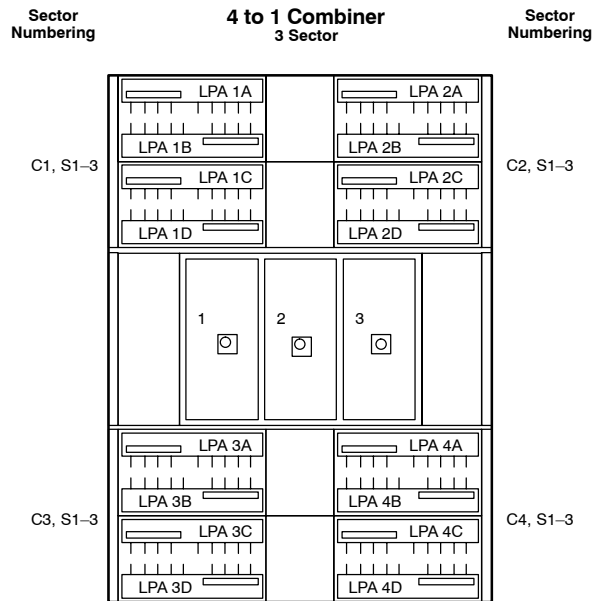
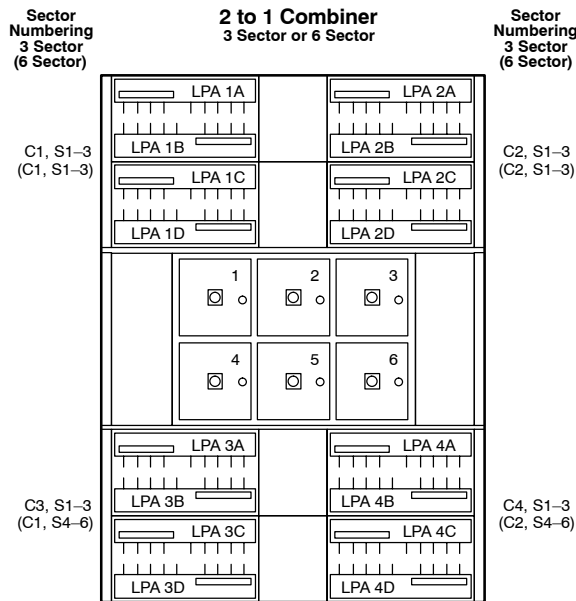

**Note: See Table 1-6 Configuration Reference Number 5.**

**Note: See Table 1-6 Configuration Reference Number 7.**

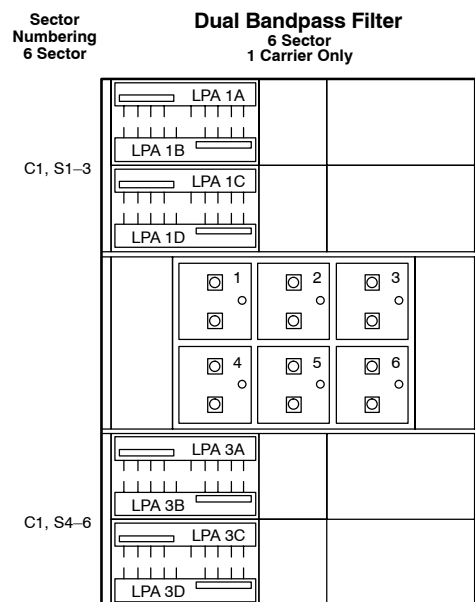
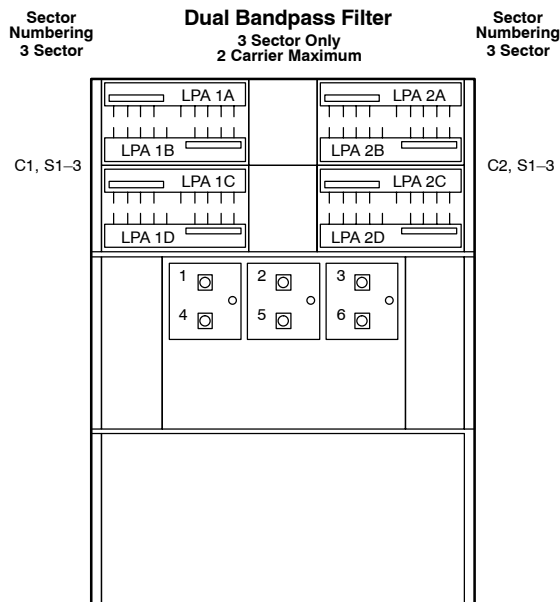

FW00297

Figure 1-14: -48 V SC4812T PA Configuration with Combiners/Filters

Note: See Table 1-6 Configuration Reference Numbers 1, 2, 3, 4.

Note: See Table 1-6 Configuration Reference Number 6.

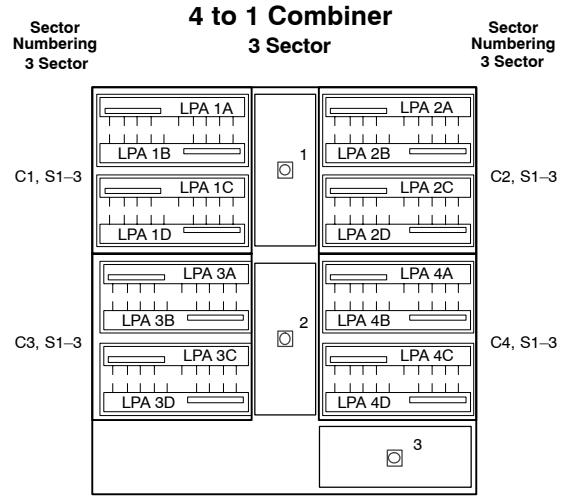
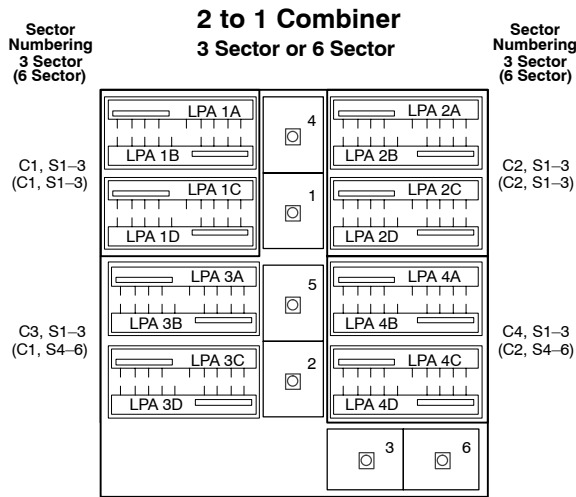

Note: See Table 1-6 Configuration Reference Number 5.

Note: See Table 1-6 Configuration Reference Number 7.

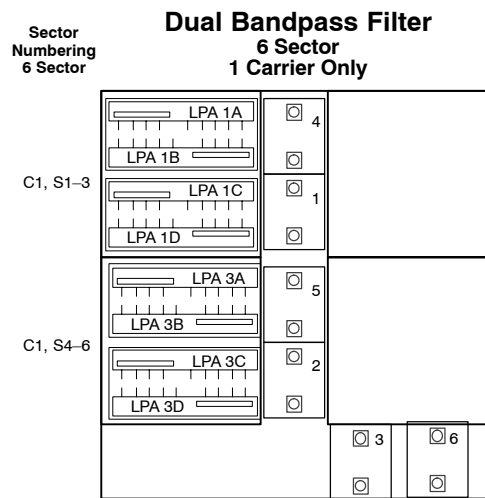
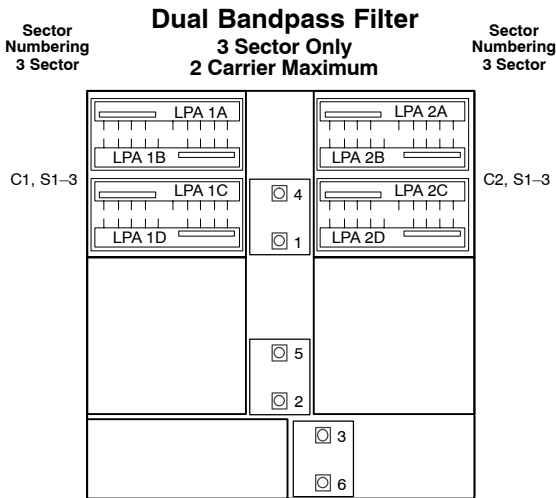

REF FW00482

Figure 1-15: -48 V BTS Power Conversion Shelf

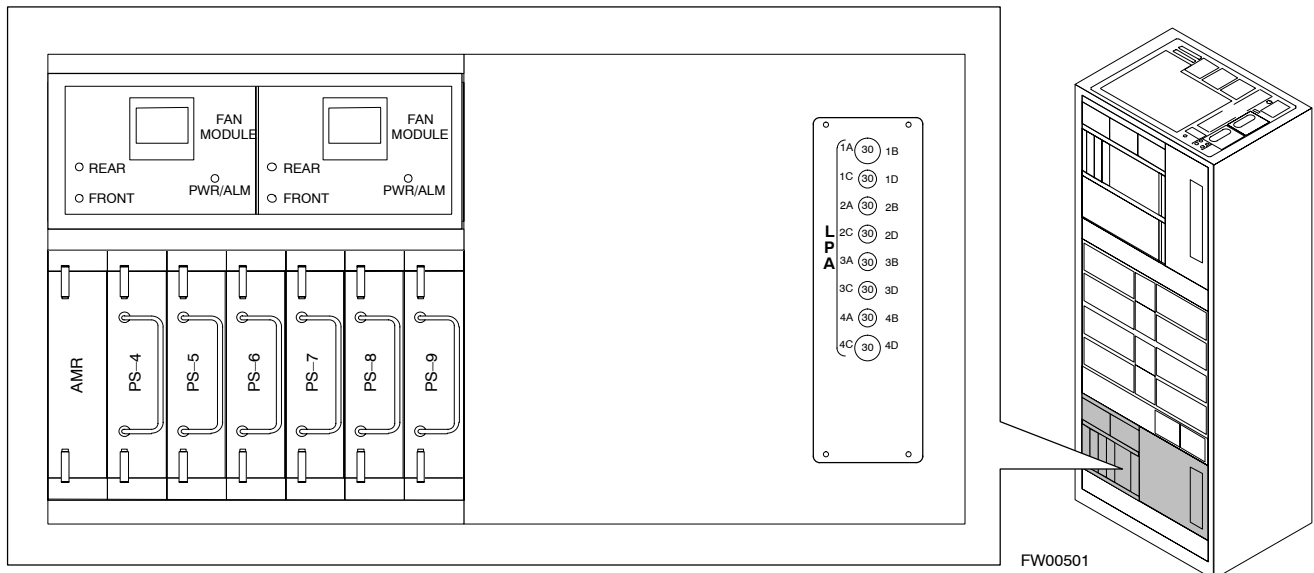
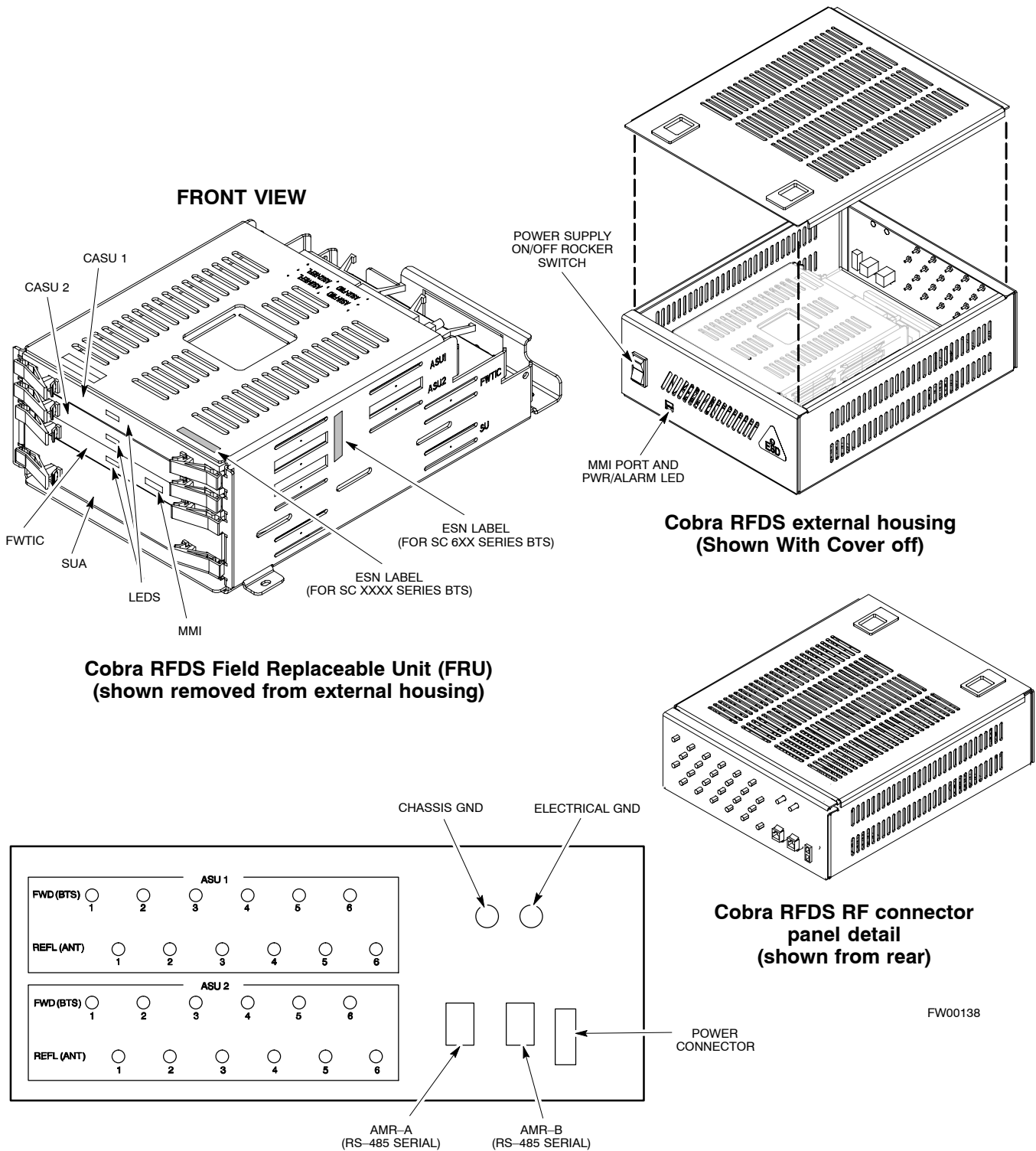

Figure 1-16: CDMA (COBRA) RFDS Layout





## *Chapter 2*

# **Preliminary Operations**

# Preliminary Operations: Overview

## Introduction

This section first verifies proper frame equipage. This includes verifying module placement, jumper, and dual in-line package (DIP) switch settings against the site-specific documentation supplied for each BTS application. Next, pre-power up and initial power-up procedures are presented.

## Cell Site Types

Sites are configured as Omni, 3-sectored with a maximum of 4 carriers, and 6-sectored with a maximum of 2 carriers. Each type has unique characteristics and must be optimized accordingly. For more information on the differences in site types, please refer to the *BTS/Modem Frame Hardware Installation* manual.

## CDF/NECF

The Configuration Data File (CDF) or Network Element Configuration File (NECF) contains site type and equipage data information and passes it directly to the LMF during optimization. The number of modem frames, C-CCP shelves, BBX boards, MCC boards (per cage), and linear power amplifier assignments are some of the equipage data included in the CDF/NECF.

<b>NOTE</b>	Be sure that the correct <b>bts-#.cdf</b> (or <b>bts-#.necf</b> ) and <b>cbsc-#.cdf</b> files are used for the BTS. These should be the CDF/NECF files that are provided for the BTS by the CBSC. Failure to use the correct CDF/NECF files can cause system errors. <b><u>Failure to use the correct CDF/NECF files to log into a live (traffic carrying) site can shut down the site.</u></b>
-------------	---

## Site Equipage Verification

Review the site documentation. Match the site engineering equipage data to the actual boards and modules shipped to the site. Physically inspect and verify the equipment provided for the BTS or Modem frame and ancillary equipment frame.

<b>CAUTION</b>	Always wear a conductive, high impedance wrist strap while handling any circuit card/module to prevent damage by ESD. After removal, the card/module should be placed on a conductive surface or back into the anti-static shipping bag.
----------------	--



## Initial Installation of Boards/Modules

Follow the procedure in Table 2-1 to verify the initial installation of boards/modules.

Table 2-1: Initial Installation of Boards/Modules	
Step	Action
1	Refer to the site documentation and install all boards and modules into the appropriate shelves as required. <b>Verify they are NOT SEATED at this time.</b>  <b>NOTE</b> On 800 MHz systems, the Switch Card has a configuration switch that must match the site configuration (see Figure 2-1).
2	As the actual site hardware is installed, record the serial number of each module on a "Serial Number Checklist" in the site logbook.

Figure 2-1: 800 MHz Configuration Switch Card

**NOTE** Configuration Switch (shown in Figure 2-1) is a feature on the newer versions of the 800 Mhz switch card (some earlier cards do not have the switch). Configuration shown is for 3 Sector BTS. Switch 1 chooses BTS or MF. Switch 4 chooses 3-sector or 6 sector. Switches 2 & 3 are not used.

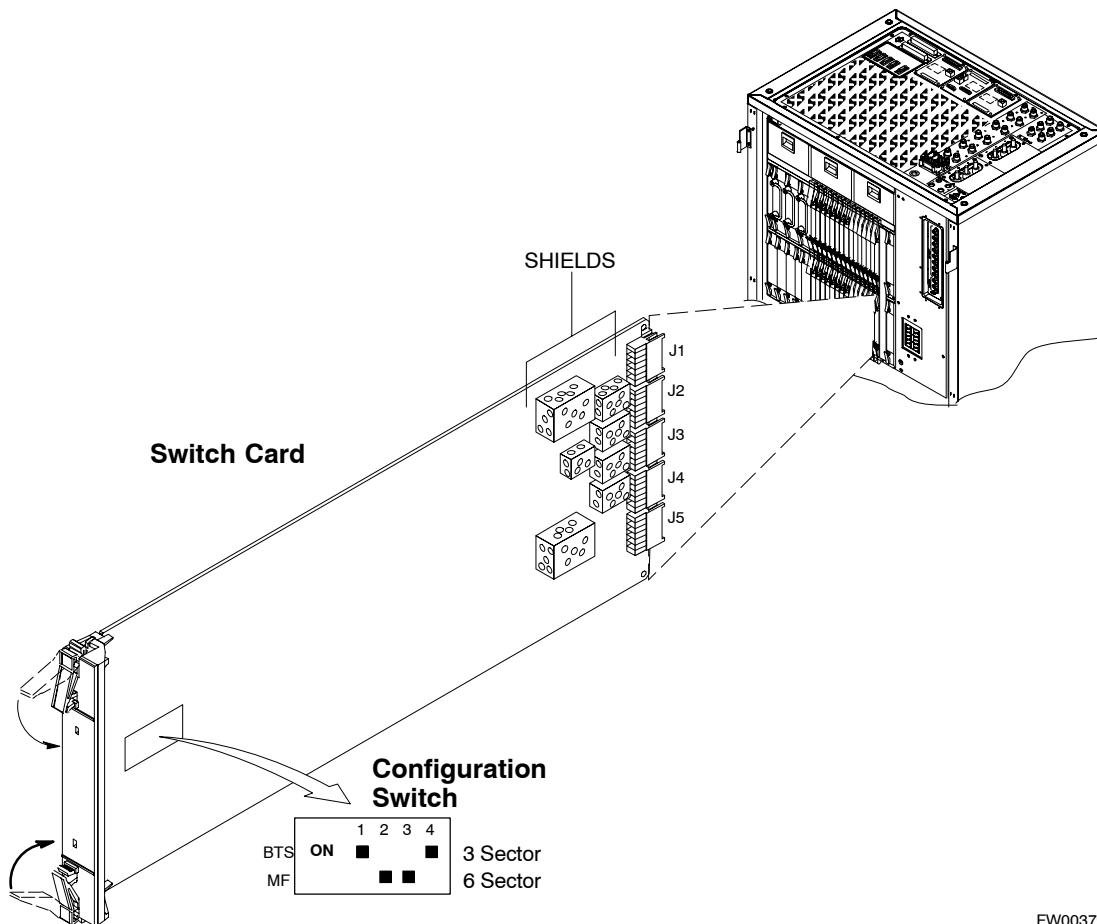

FW00379

## Setting Frame C–CCP Shelf Configuration Switch

The backplane switch settings behind the fan module nearest the breaker panel should be set as shown in Figure 2-2.

The switch setting must be verified and set before power is applied to the BTS equipment.

**Figure 2-2:** Backplane DIP Switch Settings – SC 4812T

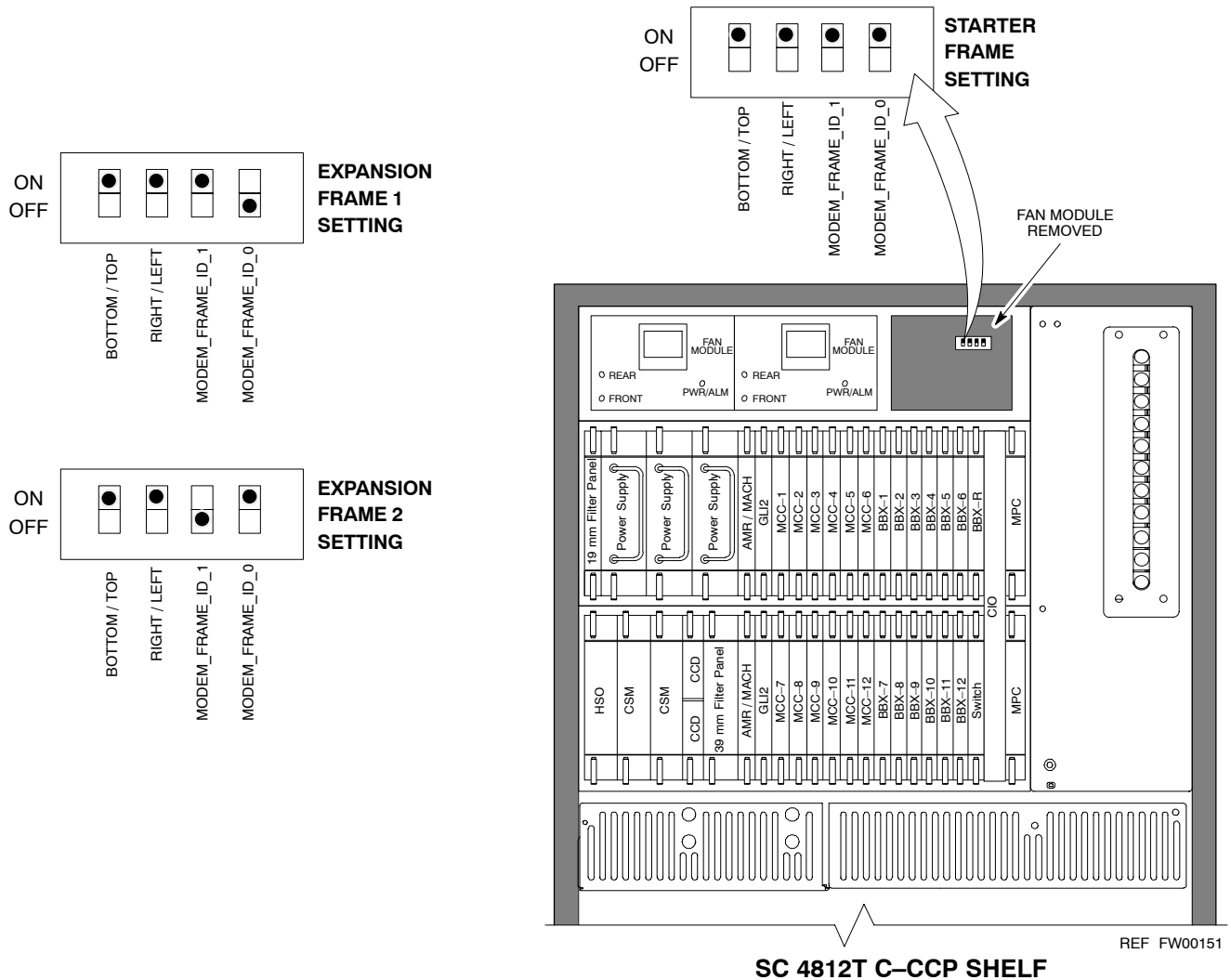

## Pre-Power-up Tests

### Objective

This procedure checks for any electrical short circuits and verifies the operation and tolerances of the cellsite and BTS power supply units prior to applying power for the first time.

2

### Test Equipment

The following test equipment is required to complete the pre-power-up tests:

- Digital Multimeter (DMM)

<b>CAUTION</b>	Always wear a conductive, high impedance wrist strap while handling the any circuit card/module to prevent damage by ESD.
----------------	---

### Cabling Inspection

Using the site-specific documentation generated by Motorola Systems Engineering, verify that the following cable systems are properly connected:

- Receive RF cabling – up to 12 RX cables
- Transmit RF cabling – up to six TX cables
- GPS
- LFR

<b>NOTE</b>	<p>For positive power applications (+27 V):</p> <ul style="list-style-type: none"><li>• The positive power cable is red.</li><li>• The negative power cable (ground) is black.</li></ul> <p>For negative power applications (–48 V):</p> <ul style="list-style-type: none"><li>• The negative power cable is red or blue.</li><li>• The positive power cable (ground) is black.</li></ul> <p>In all cases, the black power cable is at ground potential.</p>
-------------	--

## DC Power Pre-test (BTS Frame)

Before applying any power to the BTS frame, follow the procedure in Table 2-2 while referring to Figure 2-3 and Figure 2-4 for +27 V systems or to Figure 2-5 and Figure 2-6 for –48 V systems to verify there are no shorts in the BTS frame DC distribution system.

**Table 2-2: DC Power Pre–test (BTS Frame)**

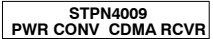
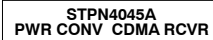
Step	Action
1	<i>Physically verify</i> that all DC power sources supplying power to the frame are <b>OFF</b> or disabled.
2	<p><i>On each frame:</i></p> <ul style="list-style-type: none"> <li>• <i>Unseat</i> all circuit boards (except CCD and CIO cards) in the C–CCP shelf and LPA shelves, but leave them in their associated slots.</li> <li>• Set C–CCP shelf breakers to the <b>OFF</b> position by <i>pulling out</i> power distribution breakers (labeled <b>C–CCP 1, 2, 3</b> on the +27 V BTS C–CCP power distribution panel and labeled <b>POWER 1,4,5,2,6,7,3,8,9</b> on the –48 V C–CCP power distribution panel).</li> <li>• Set LPA breakers to the <b>OFF</b> position by <i>pulling out</i> the LPA breakers (8 breakers, labeled <b>1A–1B</b> through <b>4C–4D</b> – located on the C–CCP power distribution panel in the +27 V BTS or on the power conversion shelf power distribution panel in the –48 V BTS).</li> </ul>
3	<p>Verify that the resistance from the power (+ or –) feed terminals with respect to the ground terminal on the top of the frame measures <math>\geq 500 \Omega</math> (see Figure 2-3).</p> <ul style="list-style-type: none"> <li>• If reading is <math>&lt; 500 \Omega</math>, a short may exist somewhere in the DC distribution path supplied by the breaker. Isolate the problem before proceeding. A reading <math>&gt; 3 \text{ M}\Omega</math> could indicate an open (or missing) bleeder resistor (installed across the filter capacitors behind the breaker panel).</li> </ul>
4	<p>Set the C–CCP (POWER) breakers to the <b>ON</b> position by pushing them <b>IN</b> <i>one at a time</i>. Repeat Step 3 after turning on each breaker.</p> <p><b>NOTE</b></p> <p>If the ohmmeter stays at <math>0 \Omega</math> after inserting any board/module, a short probably exists in that board/module. Replace the suspect board/module and repeat the test. If test still fails, isolate the problem before proceeding.</p>
5	<p>Insert and lock the DC/DC converter modules for the C–CCP shelf and into their associated slots <i>one at a time</i>. Repeat Step 3 after inserting each module.</p> <ul style="list-style-type: none"> <li>• A typical response is that the ohmmeter steadily climbs in resistance as capacitors charge, finally indicating approximately <math>500 \Omega</math>.</li> </ul> <p><b>! CAUTION</b></p> <p>Verify the correct power/converter modules by observing the locking/retracting tabs appear as follows:</p> <ul style="list-style-type: none"> <li>–  (in +27 V BTS C–CCP shelf)</li> <li>–  (in –48 V BTS C–CCP shelf)</li> </ul>
6	<p>Insert and lock all remaining circuit boards and modules into their associated slots in the C–CCP shelf. Repeat Step 3 after inserting and locking each board or module.</p> <ul style="list-style-type: none"> <li>• A typical response is that the ohmmeter steadily climbs in resistance as capacitors charge, stopping at approximately <math>500 \Omega</math>.</li> </ul>
7	<p>Set the LPA breakers <b>ON</b> by pushing them <b>IN</b> <i>one at a time</i>. Repeat Step 3 after turning on each breaker.</p> <ul style="list-style-type: none"> <li>• A typical response is that the ohmmeter will steadily climb in resistance as capacitors charge, stopping at approximately <math>500 \Omega</math>.</li> </ul>

. . . continued on next page

**Table 2-2: DC Power Pre-test (BTS Frame)**

Step	Action
8	<p>In the -48 V BTS, insert and lock the DC/DC LPA converter modules into their associated slots <i>one at a time</i>. Repeat Step 3 after inserting each module.</p> <ul style="list-style-type: none"> <li>A typical response is that the ohmmeter steadily climbs in resistance as capacitors charge, finally indicating approximately <b>500 Ω</b></li> </ul> <p><b>! CAUTION</b> Verify the correct power/converter modules by observing the locking/retracting tabs appear as follows:</p> <ul style="list-style-type: none"> <li>-  (in -48 V BTS power conversion shelf)</li> </ul>
9	<p>Seat all LPA and associated LPA fan modules into their associated slots in the shelves <i>one at a time</i>. Repeat Step 3 after seating each LPA and associated LPA fan module.</p> <ul style="list-style-type: none"> <li>A typical response is that the ohmmeter will steadily climb in resistance as capacitors charge, stopping at approximately <b>500 Ω</b>.</li> </ul>

Figure 2-3: +27 V BTS DC Distribution Pre-test



**Breakering:**

- Two LPAs on each trunking backplane breakered together
- Designed for peak LPA current of 15 amps (30 amp breakers)
- Unused TX paths do not need to be terminated
- Single feed for C-CCP
- Dual feed for LPA

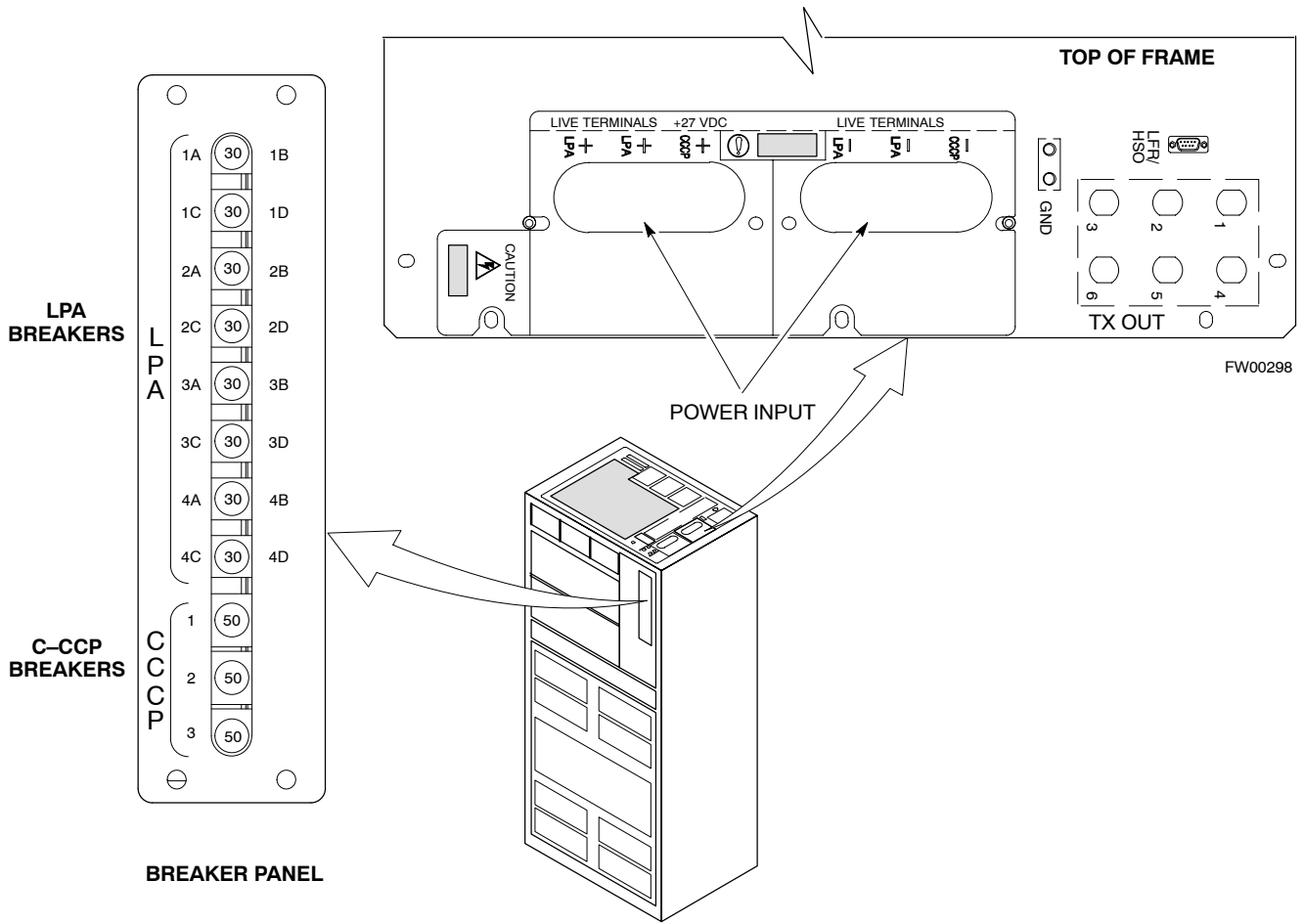
Figure 2-4: +27 V SC 4812T BTS Starter Frame

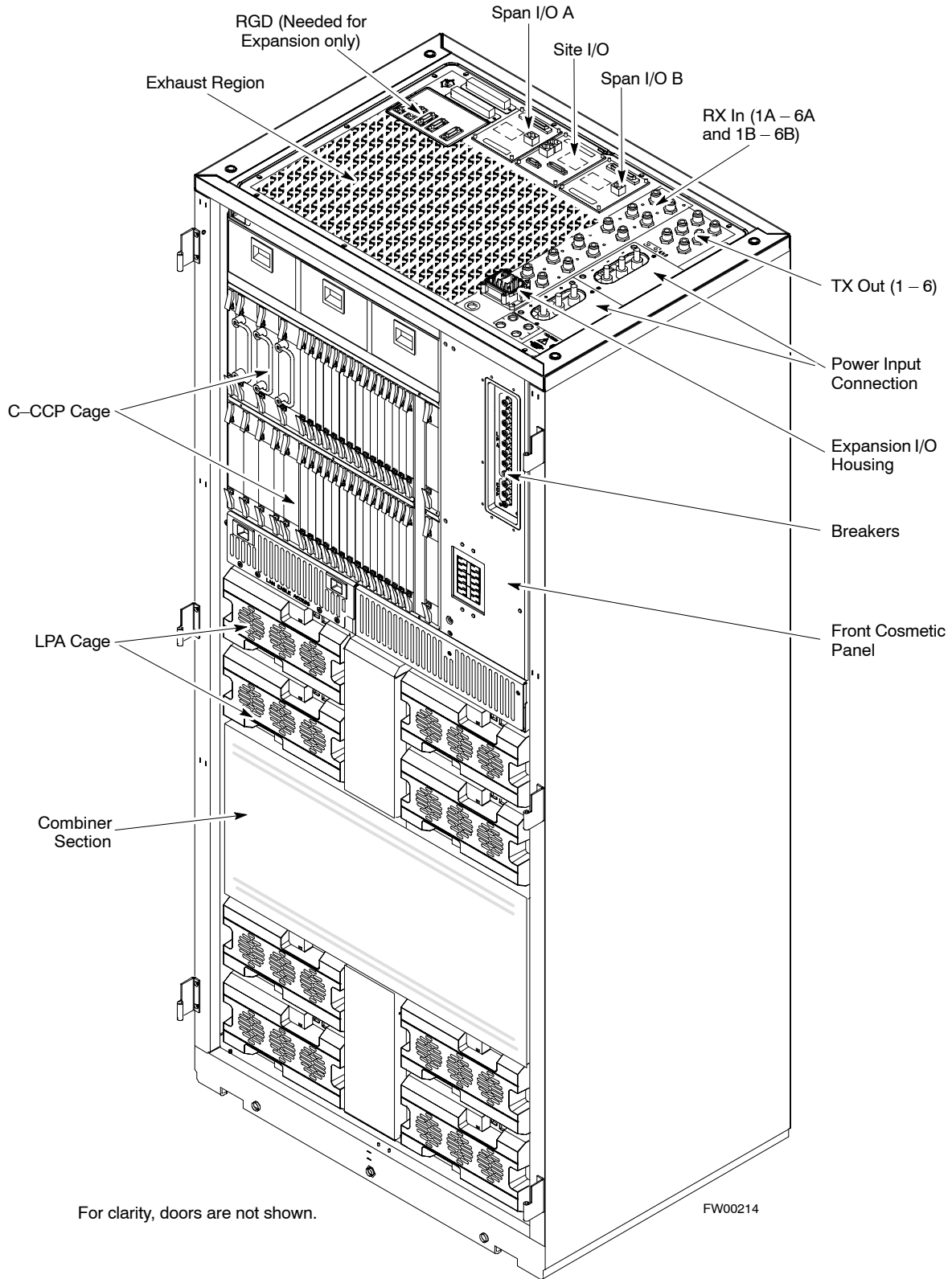
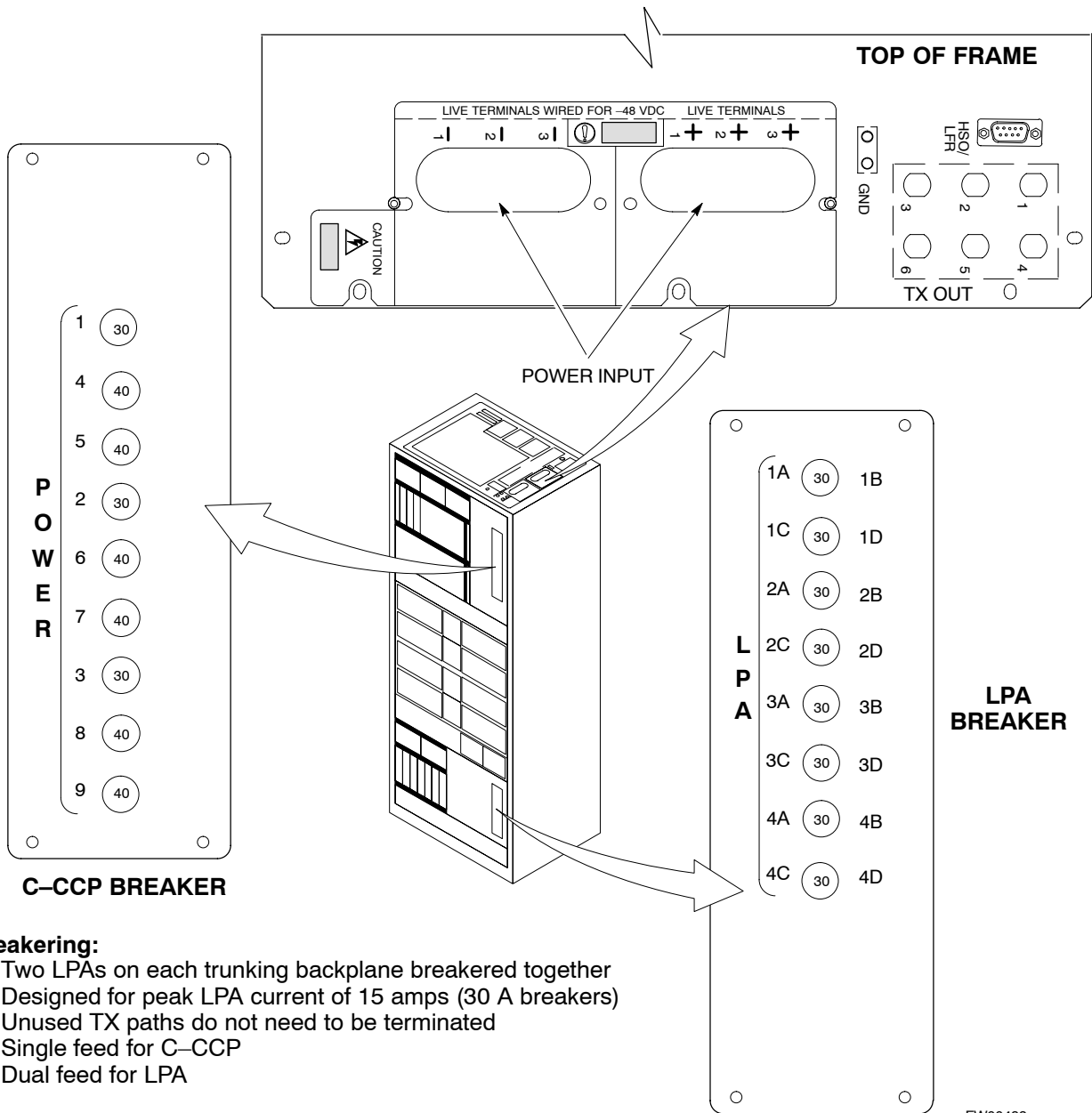

Figure 2-5: -48 V BTS DC Distribution Pre-test



**Breakering:**

- Two LPAs on each trunking backplane breakered together
- Designed for peak LPA current of 15 amps (30 A breakers)
- Unused TX paths do not need to be terminated
- Single feed for C-CCP
- Dual feed for LPA

FW00483

2



Figure 2-6: -48 V SC 4812T BTS Starter Frame

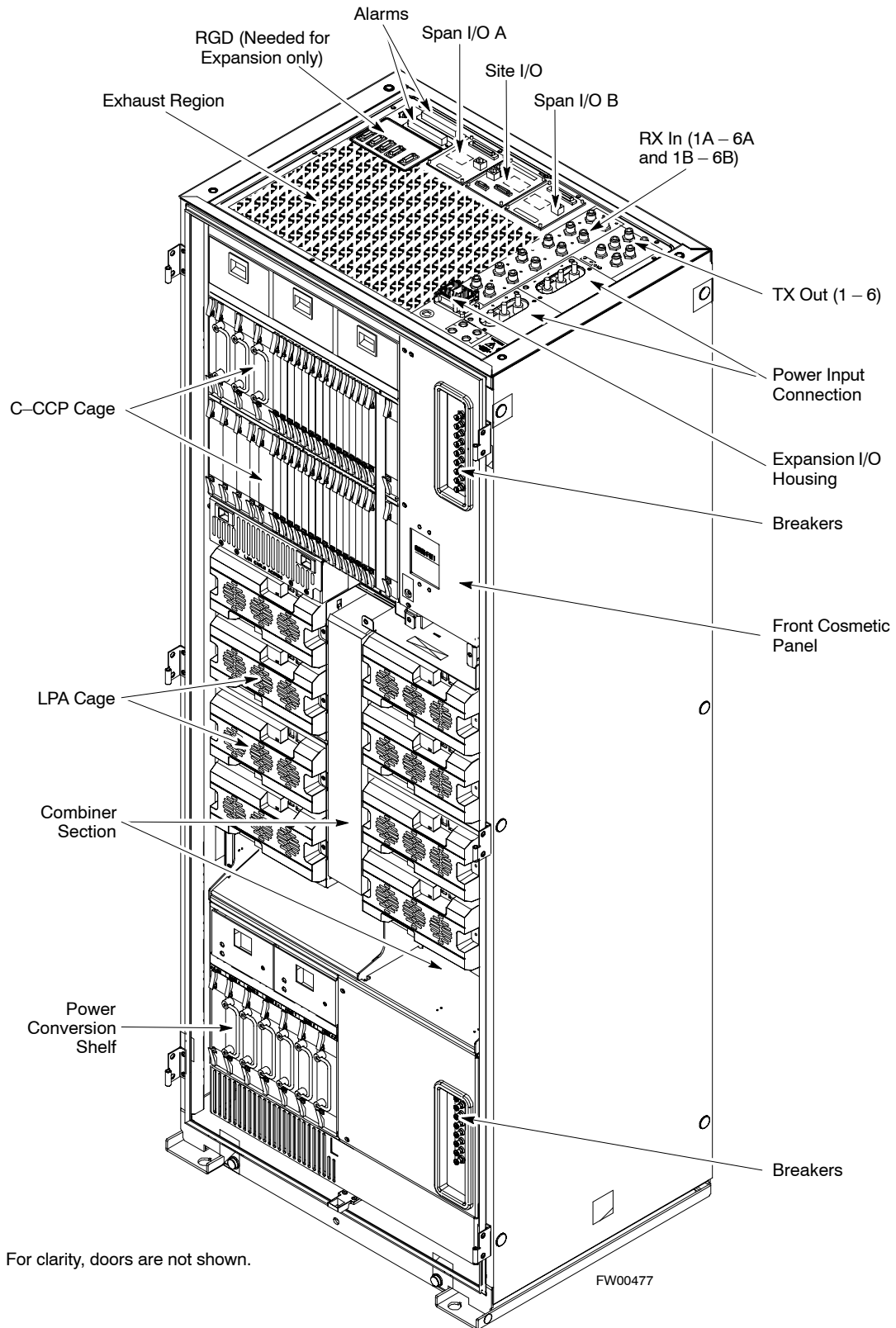

## DC Power Pre-test (RFDS)

Before applying power to the RFDS, follow the steps in Table 2-3, while referring to Figure 2-7, to verify there are no shorts in the RFDS DC distribution system, backplanes, or modules/boards. As of the date of this publication, the RFDS is not used with the -48 V BTS.

**NOTE** Visual inspection of card placement and equipage for each frame vs. site documentation must be completed, as covered in Table 2-1 on page 2-3, before proceeding with this test.

Step	Action
1	<i>Physically verify</i> that all DC/DC converters supplying the RFDS are <b>OFF</b> or disabled.
2	Set the input power rocker switch <b>P1</b> to the <b>OFF</b> position (see Figure 2-7).
3	Verify the initial resistance from the power (+ or -) feed terminal with respect to ground terminal measures $\geq 5 \text{ k}\Omega$ , then slowly begins to increase. <ul style="list-style-type: none"> <li>• If the initial reading is <math>\leq 5 \text{ k}\Omega</math> and remains constant, a short exists somewhere in the DC distribution path supplied by the breaker. Isolate the problem before proceeding.</li> </ul>
4	Set the input power rocker switch <b>P1</b> to the <b>ON</b> position. Repeat Step 3.

**Figure 2-7: DC Distribution Pre-test (COBRA RFDS Detail)**

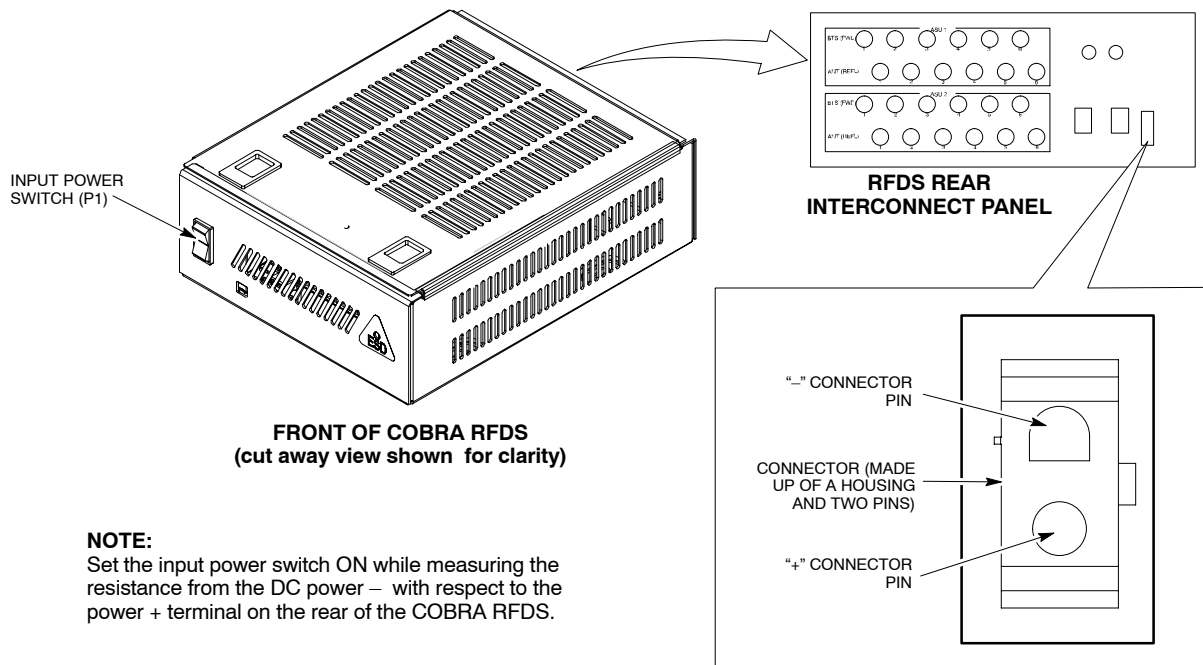

**NOTE:**  
Set the input power switch ON while measuring the resistance from the DC power - with respect to the power + terminal on the rear of the COBRA RFDS.

FW00139

# Initial Power–up Tests and Procedures

## Power-up Procedures

**WARNING** Potentially lethal voltage and current levels are routed to the BTS equipment. This test must be performed with a second person present, acting in a safety role. Remove all rings, jewelry, and wrist watches prior to beginning this test.

### DC Input Power

In the tests to follow, power will first be verified at the input to each BTS frame. After power is verified, cards and modules within the frame itself will be powered up and verified one at a time.

Before applying any power, verify the correct power feed and return cables are connected between the power supply breakers and the power connectors at the top of each BTS frame. Verify correct cable position referring to Figure 2-3 on page 2-8 for +27 V systems and Figure 2-5 on page 2-10 for –48 V systems.

**CAUTION** Always wear a conductive, high impedance wrist strap while handling any circuit card/module to prevent damage by ESD. Extreme care should be taken during the removal and installation of any card/module. After removal, the card/module should be placed on a conductive surface or back into the anti–static bag in which it was shipped.

**NOTE** For positive power applications (+27 V):

- The positive power cable is red.
- The negative power cable (ground) is black.

For negative power applications (–48 V):

- The negative power cable is red or blue.
- The positive power cable (ground) is black.

In all cases, the black power cable is at ground potential.

Motorola recommends that the DC input power cable used to connect the frame to the main DC power source conforms to the guidelines outlined in Table 2-4.

<b>Table 2-4: DC Input Power Cable Guidelines</b>	
<b>Maximum Cable Length</b>	<b>Wire Size</b>
30.38 m (100 ft)	107 mm <sup>2</sup> (AWG #4/0)
54.864 m (180 ft)	185 mm <sup>2</sup> (350 kcmil)
Greater than 54.864 m (180 ft)	Not recommended

**NOTE** If Anderson SB350 style power connectors are used, make sure the connector adapters are securely attached to each of the BTS power feeds and returns. Also, make sure the cables have been properly installed into each connector.

## Common Power Supply Verification

The procedure in Table 2-5 must be performed on any BTS frame connected to a common power supply at the site *after the common power supply has been installed and verified per the power supply OEM suggested procedures.*

Perform the following steps to verify the power input is within specification *before* powering up the individual cards/modules with the frames themselves.

**Table 2-5: Common Power Supply Verification**

Step	Action
1	Physically verify that all DC power sources supplying the frame are <b>OFF</b> or disabled.
2	On the RFDS (for +27 V systems only), set the input power switch <b>P1</b> to the <b>OFF</b> position (see Figure 2-7).
3	<p><i>On each frame:</i></p> <ul style="list-style-type: none"> <li>• <i>Unseat</i> all circuit boards (except CCD and CIO cards) in the C-CCP shelf and LPA shelves, but leave them in their associated slots.</li> <li>• Set breakers to the <b>OFF</b> position by <i>pulling out</i> C-CCP and LPA breakers (see Figure 2-3 on page 2-8 or Figure 2-5 on page 2-10 for breaker panel layout if required). <ul style="list-style-type: none"> <li>– C-CCP shelf breakers are labeled <b>CCCP-1, 2, 3</b> in the +27 V BTS and labeled <b>POWER 1,4,5,2,6,7,3,8,9</b> in the -48 V BTS.</li> <li>– LPA breakers are labeled <b>1A-1B</b> through <b>4C-4D</b>.</li> </ul> </li> </ul>
4	Inspect input cables, verify correct input power polarity via decal on top of frame ( <b>+27 Vdc</b> or <b>-48 Vdc</b> ).
5	Apply power to BTS frames, <i>one at a time</i> , by setting the appropriate breaker in the power supply that supplies the frame to the <b>ON</b> position.
6	After power is applied to each frame, use a digital voltmeter to verify power supply output voltages at the top of each BTS frame are within specifications: <b>+27.0 Vdc</b> or <b>-48 Vdc</b> nominal.

## Initial Power-up (RFDS)

The procedure in Table 2-6 must be performed on the RFDS after input power from the common power supply has been verified. Perform the following steps to apply initial power to the cards/modules within the frame itself, verifying that each is operating within specification.

<b>NOTE</b>	Visual inspection of card placement and equipage for each frame vs. site documentation <b>must be completed</b> , as covered in Table 2-1, on page 2-3, before proceeding with this test.
-------------	---

**Table 2-6: Initial Power-up (RFDS)**

Step	Action
1	On the RFDS, set the input power rocker switch ( <b>P1</b> ) to the <b>ON</b> position (see Figure 2-7).
2	Verify power supply output voltages (at the top of BTS frame), using a digital voltmeter, are within specifications: <b>+27.0 V</b> nominal.

## Initial Power-up (BTS)

The procedure must be performed on each frame after input power from the common power supply has been verified. Follow the steps in Table 2-7 to apply initial power to the cards/modules within the frame itself, verifying that each is operating within specification.

**Table 2-7: Initial Power–up (BTS)**

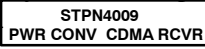
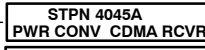
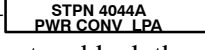
Step	Action
1	At the BTS, set the C–CCP (POWER) power distribution breakers (see Figure 2-3 on page 2-8 or Figure 2-5 on page 2-10) to the <b>ON</b> position by <i>pushing in</i> the breakers.
2	Insert the C–CCP fan modules. Observe that the fan modules come on line.
3	<p><b>! CAUTION</b></p> <p>Verify the correct power/converter modules by observing the locking/retracting tabs appear as follows:</p> <ul style="list-style-type: none"> <li>–  (in +27 V BTS C–CCP shelf)</li> <li>–  (in –48 V BTS C–CCP shelf)</li> <li>–  (in –48 V BTS power conversion shelf)</li> </ul> <p>Insert and lock the converter/power supplies into their associated slots <i>one at a time</i>.</p> <ul style="list-style-type: none"> <li>• If no boards have been inserted, all three <b>PWR/ALM</b> LEDs would indicate RED to notify the user that there is no load on the power supplies. <ul style="list-style-type: none"> <li>– If the LED is RED, do not be alarmed. After Step 4 is performed, the LEDs should turn GREEN; if not, then a faulty converter/power supply module is indicated and should be replaced <i>before proceeding</i>.</li> </ul> </li> </ul>
4	Seat and lock all remaining circuit cards and modules in the C–CCP shelf into their associated slots.
5	Seat the first equipped LPA module pair into the assigned slot in the upper LPA shelf including LPA fan. <ul style="list-style-type: none"> <li>• In +27 V systems, observe that the LPA internal fan comes on line.</li> </ul>
6	Repeat step 5 for all remaining LPAs.

. . . continued on next page

Table 2-7: Initial Power-up (BTS)

Step	Action
7	<p>Set the LPA breakers to the ON position (<i>per configuration</i>) by pushing them IN <i>one at a time</i>. See Figure 1-13 on page 1-32 or Figure 1-14 on page 1-33 for configurations and Figure 2-3 on page 2-8 or Figure 2-5 on page 2-10 for LPA breaker panel layout.</p> <p>On +27 V frames, engage (push) LPA circuit breakers.</p> <ul style="list-style-type: none"> <li>• Confirm LEDs on LPAs light.</li> </ul> <p>On -48 V frames, engage (push) LPA PS circuit breakers.</p> <ul style="list-style-type: none"> <li>• Confirm LPA PS fans start.</li> <li>• Confirm LEDs on -48 V power converter boards light.</li> <li>• Confirm LPA fans start.</li> <li>• Confirm LEDs on LPAs light.</li> </ul>
8	<p>After all cards/modules have been seated and verified, use a digital voltmeter to verify power supply output voltages at the top of the frame remain within specifications: <b>+27.0 Vdc</b> or <b>-48 Vdc</b> nominal.</p>
9	<p>Repeat Steps 1 through 8 for additional co-located frames (if equipped).</p>

2

*Chapter 3*

# Optimization/Calibration

# Introduction to Optimization and Calibration

## Overview

This section describes procedures for isolating the BTS from the span lines, preparing and using the LMF, downloading system operating software, CSM reference verification/optimization, set up and calibration of the supported test equipment, transmit/receive path verification, using the RFDS, and verifying the customer defined alarms and relay contacts are functioning properly.

<b>NOTE</b>	Before using the LMF, use an editor to view the “CAVEATS” section in the “readme.txt” file in the c:\wlmf folder for any applicable information.
-------------	--

## Optimization Process Summary

After a BTS is physically installed and the preliminary operations, such as power up, have been completed, the LMF is used to optimize the BTS. The basic optimization process consists of the following:

1. Download MGLI-1 with code and data and then enable MGLI-1.

<b>NOTE</b>	GLIs may be GLI2s or GLI3s.
-------------	-----------------------------

2. Use the status function and verify that all of the installed devices of the following types respond with status information: CSM, BBX, GLI, MCC, and TSU (if RFDS is installed). If a device is installed and powered up but is not responding and is colored gray in the BTS display, the device is not listed in the CDF/NECF file. The CDF/NECF file must be corrected before the device can be accessed by the LMF.
3. Download code and data to all devices of the following types:
  - CSM
  - BBX (may be BBX2 or BBX-1X)
  - GLI (other than MGLI-1)
  - MCC (may be MCC-8E, MCC24, or MCC-1X)
4. Download the RFDS TSIC (if installed).
5. Verify the operation of the GPS and HSO or LFR signals.
6. Enable the following devices (in the order listed):
  - Secondary CSM
  - Primary CSM
  - All MCCs
7. Using the LMF test equipment selection function, select the test equipment to be used for the calibration.
8. Calibrate the TX and RX test cables if they have not previously been calibrated using the CDMA LMF that will be used for the optimization/calibration. The cable calibration values can also be entered manually.
9. Connect the required test equipment for a full optimization.
10. Select all of the BBXs and all of the MCCs, and use the full optimization function. The full optimization function performs TX calibration, BLO download, TX audit, all TX tests, and all RX tests for all selected devices.



11. If the TX calibration fails, repeat the full optimization for any failed paths.
12. If the TX calibration fails again, troubleshoot and correct the problem that caused the failure and repeat the full optimization for the failed path.
13. If the TX calibration and audit portion of the full optimization passes for a path but some of the TX or RX tests fail, correct the problem that caused the failure and run the individual tests as required until all TX and RX tests have passed for all paths.

## Cell-site Types

Sites are configured as Omni/Omni or Sector/Sector (TX/RX). Each type has unique characteristics and must be optimized accordingly.

**NOTE** For more information on the different in site types, please refer to the applicable *Hardware Installation* manual.

## CDF/NECF

The CDF/NECF (Configuration Data File/Network Element Configuration File) contains information that defines the BTS and data used to download files to the devices. A CDF/NECF file must be placed in the applicable BTS folder before the LMF can be used to log into that BTS. CDF/NECF files are normally obtained from the CBSC using a floppy disk. A file transfer protocol (ftp) method can be used if the LMF computer has that capability. Refer to the *LMF Help function on-line documentation* for more information.

The CDF/NECF includes the following information:

- Download instructions and protocol
- Site specific equipage information
- C-CCP shelf allocation plan
  - BBX equipage (based on cell-site type) including redundancy
  - CSM equipage including redundancy
  - MCC (MCC24E, MCC8E, or MCC-1X) channel element allocation plan. This plan indicates how the C-CCP shelf is configured, and how the paging, synchronization, traffic, and access channel elements (and associated gain values) are assigned among the (up to 12) MCCs in the shelf.
- CSM equipage including redundancy
- Effective Rated Power (ERP) table for all TX channels to antennas respectively. Motorola System Engineering specifies the ERP of a transmit antenna based on site geography, antenna placement, and government regulations. Working from this ERP requirement, the antenna gain, (dependent on the units of measurement specified) and antenna feed line loss can be combined to determine the required power at the top of the BTS frame. The corresponding BBX output level required to achieve that power level on any channel/sector can also be determined.

**NOTE**

Refer to Figure 3-1 and the *LMF Help function on-line documentation* for additional information on the layout of the LMF directory structure (including CDF/NECF file locations and formats).

## BTS System Software Download

BTS system software must be successfully downloaded to the BTS processor boards before optimization can be performed. BTS operating code is loaded from the LMF computer terminal.

BTSs configured for Circuit Backhaul use `bts.cdf` files. BTSs configured for Packet Backhaul use `bts.necf` files (`bts-xxx.xml`) located on the OMC/R.

**NOTE**

Before using the LMF for optimization/ATP, the correct **`bts-#.cdf`** (or **`bts-#.necf`**) and **`cbsc-#.cdf`** files for the BTS must be obtained from the CBSC and put in a **`bts-#`** folder in the LMF. Failure to use the correct CDF/NECF files can cause wrong results. **Failure to use the correct CDF/NECF files to log into a live (traffic carrying) site can shut down the site.**

The CDF/NECF is normally obtained from the CBSC on a DOS formatted diskette, or through a file transfer protocol (ftp) if the LMF computer has ftp capability. Refer to the *LMF Help function on-line documentation* for the procedure.

## Site Equipage Verification

If you have not already done so, use an editor to view the CDF/NECF, and review the site documentation. Verify the site engineering equipage data in the CDF/NECF matches the actual site hardware using a CDF/NECF conversion table.

**CAUTION**

- Use extreme care not to make any changes to the CDF/NECF content while viewing the file. Changes to the CDF/NECF can cause the site to operate unreliably or render it incapable of operation.
- Always wear a conductive, high impedance wrist strap while handling any circuit card/module to prevent damage by ESD. Extreme care should be taken during the removal and installation of any card/module. After removal, the card/module should be placed on a conductive surface or back into the anti-static bag in which it was shipped.

# Preparing the LMF

## Overview of Packet BTS files

R16.0 and earlier releases had the configuration file called CDF for each BTS and CBSC used by LMF. In 16.1 Packet BTS, BTS with GLI3 booting in packet binary, the CDF is replaced by two new configuration files called Network Element Configuration Base (NECB) and Network Element Change Journal (NECJ). The NECB contains the baseline configuration and is analogous to the CDF, while the NECJ contains all the changes made to the configuration since the last time the NECB was re-generated. Once the NECJ gets to 80% of its maximum size, the NECB is re-generated and all the updates are rolled into it.

These files play much broader and vital role than previous CDF files. GLI3 booting in circuit binaries works similar to R16.0.

A few LMF related important facts about these files are listed below.

- Both files (NECB and NECJ) are in XML format.
- NECB contains all the up-to-date static configuration information and NECJ contains all the recent changes (including operations) which are not updated in the NECB.
- Both files can be viewed in any XML viewer (most easily available is Internet Explorer V5.0 and higher). They can be also viewed by any other word processor, but the XML tags will also be seen with them.
- These files will be created by OMC-R from MIB as per the BTS provisioning.
- These files will be regenerated for each software release upgrade on the system for each BTS.
- These files will reside on both OMC-R and Packet-GLI3 (unlike CDF) and will be synchronized periodically between them.
- Both NECB and NECJ file contain a “SoftwareVersion” field in their header section indicating the system release version of these files.
- Instead of the `bts#.cdf` file, the packet LMF uses a `bts#.XML` file, which is a copy of the `NECB.XML` file.
- Packet-GLI3 will need these files for site initialization.
- The scope of NECB has grown much broader than CDF and has much more BTS centric information. The use of generic version of these files should be strictly avoided for the correct site initialization.

## LMF Features and Installation Requirements

Before optimization can be performed, the LMF application software must be installed and configured on a computer platform meeting Motorola–specified requirements (see Recommended Test Equipment and Software in Chapter 1).

<b>NOTE</b>	For the CDMA LMF graphics to display properly, the computer platform must be configured to display more than 256 colors. See the operating system software instructions for verifying and configuring the display settings.
-------------	---

Software and files for installation and updating of the LMF are provided on CD ROM disks. The following installation items must be available:

- LMF Program on CD ROM
- CDF/NECF for each supported BTS (on diskette or available from the CBSC)
- CBSC File for each supported BTS (on diskette or available from the CBSC)

### FTP Server

To be able to download files to the GLI3, the LMF now runs FTP server on the LMF laptop. The LMF FTP server runs from the LMFs home directory. All the files necessary to run the LMF FTP server are installed from the LMF CD. The FTP server is automatically started by the LMF upon successful Login to a Packet BTS.

In addition, the LMF provides a new option in the Tools menu called FTP Server. The option starts the LMFs FTP server if **Start** is selected, and stops the server if **Stop** is selected. The LMFs FTP server runs on port 21. If any other process is using that port, the error message is displayed to the user stating that the port is occupied. There is another option under FTP Server menu called FTP Monitor, which allows the user to watch FTP activity b/w the LMF and GLI.

### Firewalls

Firewalls will block the FTP requests from the Packet GLI to the LMF laptop. You must disable your firewall before attempting the BTS Synch command. Some common firewall programs to look for include Network ICE, BlackICE, Norton’s Desktop Firewall, Enterprise Firewall, and Personal Firewall.

### FTP Server Port in use

On some Windows 2000 installations, a process called “inetd.exe” makes the FTP server port 21 unusable by the LMF. If the LMF reports that the FTP server could not start because the port is in use, make sure the inetd.exe is not running by using the Task Manager’s process list. If inetd.exe is running, end the process by selecting it and clicking the “End Process” button. Inetd32.exe is NOT the same and ending it will not resolve this problem.

## LMF File Structure Overview

The LMF uses a  $\langle x \rangle \setminus \langle \text{lmf home directory} \rangle$  folder that contains all of the essential data for installing and maintaining the BTS. The following list outlines the folder structure for LMF. Except for the *bts- $nnn$*  folders, these folders are created as part of the LMF installation. Refer to the *CDMA LMF Operator's Guide* for a complete description of the folder structure.

**Figure 3-1:** LMF Folder Structure

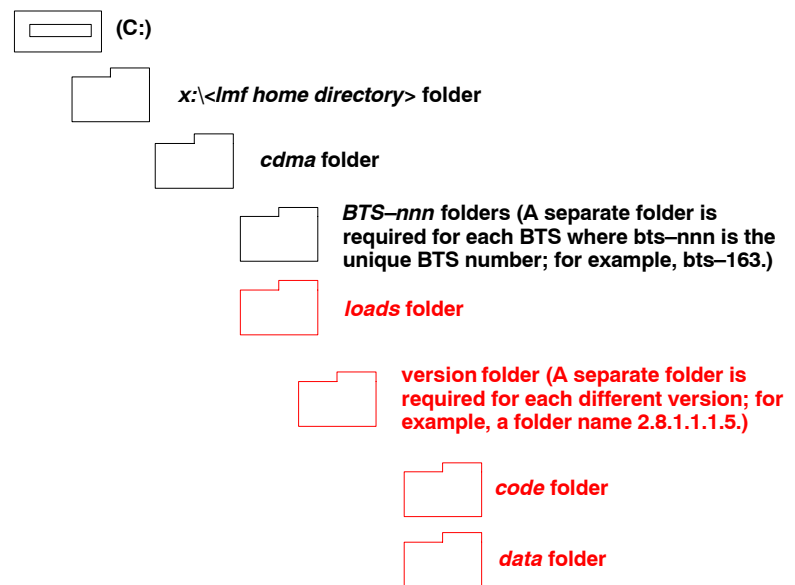

**NOTE**

The “loads” folder and all the folders below it are not available from the LMF for Software Release 2.16.1.x. These folders may be present as a legacy from previous software versions or downloaded from the CBSC/OMC-R.

## LMF Home Directory

The LMF installation program creates the default home directory, **c:\wlmf**, and installs the application files and subdirectories (folders) in it. Because this can be changed at installation, the CDMA LMF home directory will be referred to with the generic convention of:

**<x>:\<lmf home directory>**

Where:

<x> = the LMF computer drive letter where the CDMA LMF home directory is located.

<lmf home directory> = the directory path or name where the CDMA LMF is installed.

## NECF Filename Conventions and Directory Location

### NECF

The NECF actually consists of two files: the NECB and NECJ. The naming convention for the NECB and NECJ is:

**NECB\*bts#.xml**

**NECJ\*bts#.xml**

Where:

\* = any characters can be substituted there

# = the actual integer BTS number

The NECB and its corresponding NECJ must have the exact same name, except for the “B” and “J” difference after the initial NEC characters.

The NECB and the NECJ must reside in the <LMF\_HOME>\cdma\bts-# directory corresponding to the BTS frame they are for.

### Load Information File (LIF)

The LIF contains all the devices binaries available for the specified System Software Release. It is the functional equivalent of the OLF file that was used pre-Packet.

The naming convention for the LIF is:

**NE\_LIF.xml**

The LIF must reside in the <LMF\_HOME>\cdma\loads\<Software Release Number> directory, where <LMF\_HOME> = the home directory in which the LMF is installed, usually C:\wlmf <Software Release Number> = the System Software Release Number (e.g. 2.16.1.0.10).

### Cal File

The Cal File still resides in the <LMF\_HOME>\cdma\bts-# directory and is named bts-#.cal, where # is the actual integer number of the BTS.