

Site verification

Site installation checks

Verify that the site is ready for BTS installation before performing the physical installation.

A detailed layout of the site is provided with the site-specific documentation. Before installing the hardware, compare the information presented here to the site-specific documentation layout and verify with the Site Manager for the following:

- All cable trays are installed.
- All external signal cables are connected.
- Site is clean.
- Site specific documentation covering all site dependent installation information is available.
- The installation area has restricted access. Equipment is meant to be installed and operated in a restricted access location. In order to maintain UL listing, equipment must be installed in a restricted access area.
- The site can maintain the required temperature range.
- The layout meets the minimum clearance requirements for the equipment as listed in [Table 2-5](#), [Table 2-6](#) and [Table 2-7](#).
- All building DC power cables are connected.
- The building meets the voltage and power requirements shown in *Site description (as built)* documents.
- Power cables are present that meet the requirements shown in [Table 2-8](#).
- The procedure, tools, and equipment required to mount the rack to the floor are specified by a Structural Engineer.
- The site can meet the footprint dimensions (as shown in [Figure 2-5](#)) and not violate any of the required clearances.
- Site grounding is according to Grounding Guidelines for Cellular Radio Installations (Motorola part number 68P81150E62).
- The screen (outer shield) of the RF antenna coaxial cable must be connected to earth (grounded) at the entrance to the building. This should be done in accordance with applicable national electrical installation codes (Section 820.93 of the National Electrical Code, ANSI/NFPA 70).
- Verify that the Master Ground Bar is connected to a solid earth ground. This is required to ensure protection from hazardous voltages by providing a high integrity protective earthing circuit when the frame is later grounded to the Master Ground Bar.

- The frames can be mounted as specified in the site-specific documentation.
- Each frame has its own main power cut off.



NOTE

Motorola recommends a separate main power cut off for each frame of the system.

Temperature range

The site building must be able to maintain a temperature between 0° C and 50° C. The life span of electronic equipment is shortened by environmental variations, even though it is designed to operate at extreme temperatures.

Frame physical dimensions

The following table gives the frame dimensions.

Table 2-4 Frame dimensions

Height	Width	Depth	Maximum Weight
1800 mm (70.86 inches)	575 mm (22.63 inches)	700 mm (27.55 inches)	312 kg (688 lbs)

Frame clearances

The following tables give the frame clearances for various configurations.

Table 2-5 Minimum frame clearances for airflow

Front	Rear	Top	Left side	Right side	Bottom
150 mm (5.9 inches)	150 mm (5.9 inches)	300 mm (11.8 inches)	0 mm (0 inches)	0 mm (0 inches)	0 mm (0 inches)

Table 2-6 Minimum frame clearances for maintenance - front access only

Front	Rear	Top	Left side	Right side	Bottom
700 mm (27.55 inches)	150 mm (5.9 inches)	300 mm (11.8 inches)	75 mm (2.95 inches)	75 mm (2.95 inches)	0 mm (0 inches)

Table 2-7 Minimum frame clearances for maintenance - front and rear access

Front	Rear	Top	Left side	Right side	Bottom
700 mm (27.55 inches)	150 mm (5.9 inches)	300 mm (11.8 inches)	0 mm (0 inches)	0 mm (0 inches)	0 mm (0 inches)

Frame DC input power and power cabling information

Table 2-8 gives DC input power cabling and circuit breaker information.



NOTE

For frame maximum and typical power consumption, refer to the *UBS (800 MHz) BTS Specification (B1)* document or *UBS (1.9 GHz) BTS Specification (B1)* document whichever is applicable.

Table 2-8 +27 V DC and -48 V DC Frame Power Cabling and Power Supply Breaker Information

Qty of XMIs	Maximum cable length	Cable size (AWG)	Cable insulation temperature rating (° C)	Qty of power feeds (+ and - pairs)	Breaker size per feed (Amps DC)
1	661.11 cm (21.69 ft)	2/0	200	1	250
1	833.63 cm (27.35 ft)	3/0	150	1	250
1	1051.25 cm (34.499 ft)	4/0	150	1	250
2	661.11 cm (21.69 ft)	2/0	200	1	250
2	833.63 cm (27.35 ft)	3/0	150	1	250
2	1051.25 cm (34.499 ft)	4/0	150	1	250
3	661.11 cm (21.69 ft)	2/0	200	2	250
3	833.63 cm (27.35 ft)	3/0	150	2	250
3	1051.25 cm (34.499 ft)	4/0	150	2	250

Continued

Table 2-8 +27 V DC and -48 V DC Frame Power Cabling and Power Supply Breaker Information (Continued)

Qty of XMIs	Maximum cable length	Cable size (AWG)	Cable insulation temperature rating (° C)	Qty of power feeds (+ and - pairs)	Breaker size per feed (Amps DC)
4	661.11 cm (21.69 ft)	2/0	200	2	250
4	833.63 cm (27.35 ft)	3/0	150	2	250
4	1051.25 cm (34.499 ft)	4/0	150	2	250

Frame positioning

Typically, equipment frames are positioned side-by-side, with the frame fronts facing the same direction.

Rack base description and dimensions

The base of the rack consists of the following:

- Isolation pads attached to the base to isolate the rack from the floor. The isolation pads are positioned between the floor and the base.
- Six 22 mm (0.87 inches) M12 mounting holes.
- Plastic shoulder washer in each hole to isolate the frame from the floor. [Figure 2-5](#) shows the footprint of the rack.

Figure 2-5 Rack footprint

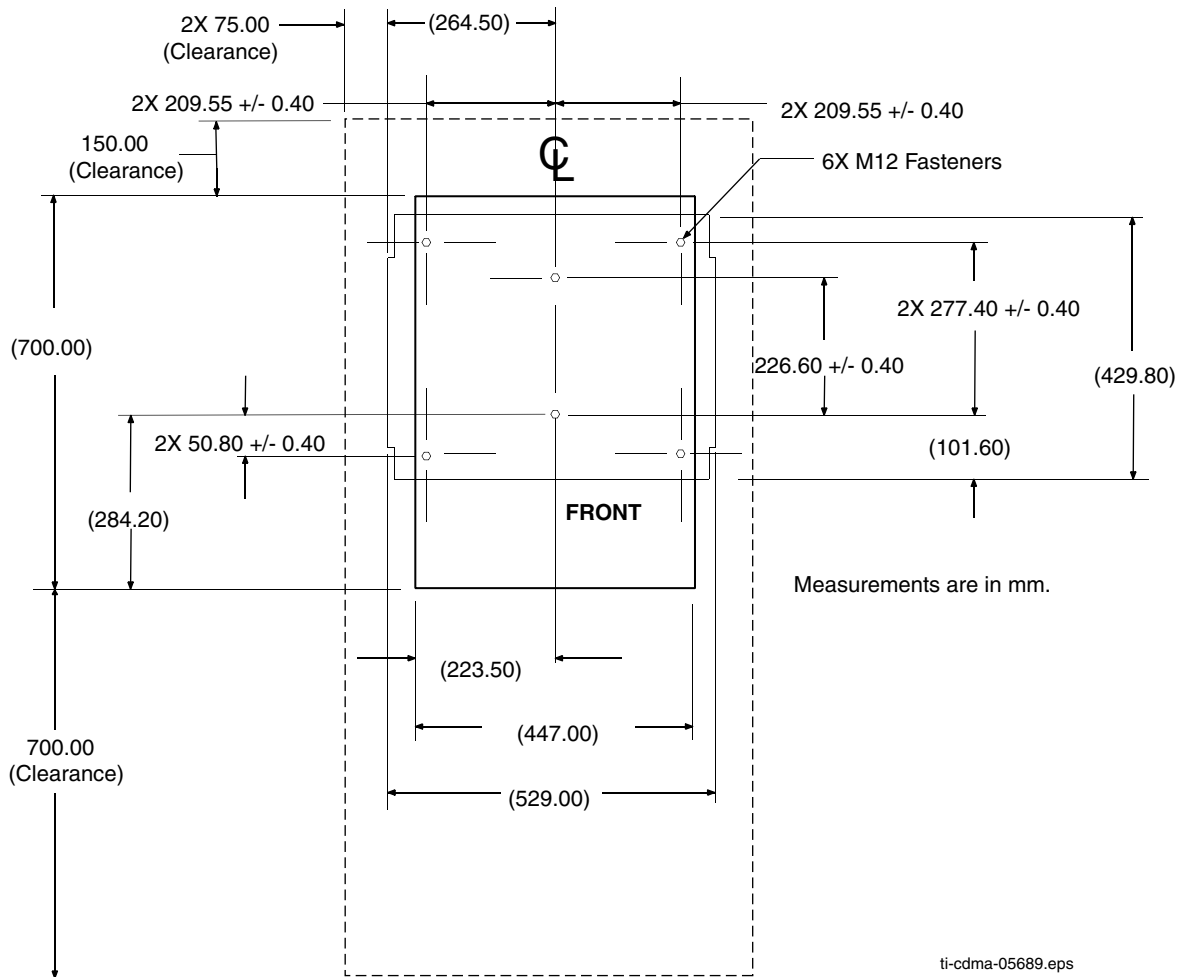

Task 1: Installing RGPS Head

Objective

The objective of this procedure is to install the optional Remote GPS (RGPS) head and cables (NN and AA). The site configuration/characteristics determines whether an RGPS head and cables are to be installed.

Any of the following RGPS heads may be used:

- STLN6594 (Motorola part number)
- 0186012H04 (Motorola part number)



NOTE

Cable NN works with any of the above listed RGPS heads.

RGPS head installation

Required items

The following tools are required:

- Adjustable torque ratchet with metric socket set
- Flat head screwdriver
- Lightning Arrestor (Motorola part number CGDSO971017AA1 or equivalent)

[Table 2-9](#) gives a list of the cables.

Table 2-9 List of required cables for RGPS head installation

Cable	Quantity	Part Number	Description
AA	1	SGKN4430 (3086433H14)	15 pin D-connector on one end and loose wires on the other end. Cable is Motorola P/N 3086433H12.
NN		3086039H10	RGPS cable, 15 m (50 ft); part of Option T472AG
		3086039H11	RGPS cable, 38 m (125 ft); part of Option T472AH
		3086039H12	RGPS cable, 76 m (250 ft); part of Option T472AJ

Table 2-9 List of required cables for RGPS head installation (Continued)

Cable	Quantity	Part Number	Description
		3086039H13	RGPS cable, 152 m (500 ft); part of Option T472AK

Cabling diagrams

The following figures show the cabling for an RGPS head.

Figure 2-6 RGPS cabling diagram ^{3086039H14} RGPS cable, 304 m (1000 ft); part of Option _{1472AL}

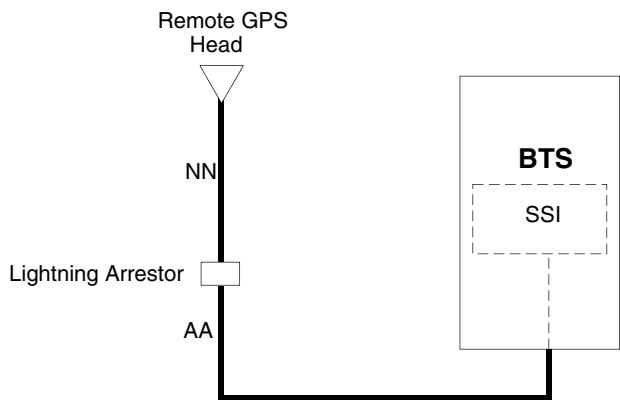

ti-cdma-05700.eps



CAUTION

When wiring the Motorola P/N STLN6594 RGPS Head at a new BTS site, the Yellow and Yellow/Black wires on both sides of the lightning arrester must be disconnected (see [Figure 2-7](#) and [Figure 2-8](#)). Otherwise, the STLN6594 RGPS Head will be permanently damaged.



CAUTION

If a Motorola P/N 0186012H04 or 0186012H03 RGPS Head at an existing BTS site is being replaced with the Motorola P/N STLN6594 RGPS Head, the Yellow and Yellow/Black wires on both sides of the lightning arrester must be disconnected (see [Figure 2-7](#) and [Figure 2-8](#)). Otherwise, the STLN6594 RGPS Head will be permanently damaged.



NOTE

The Motorola P/N 0186012H04 RGPS Head will work with the Yellow and Yellow/black wires disconnected or connected on both sides of the lightning arrestor.

Figure 2-7 RGPS wiring

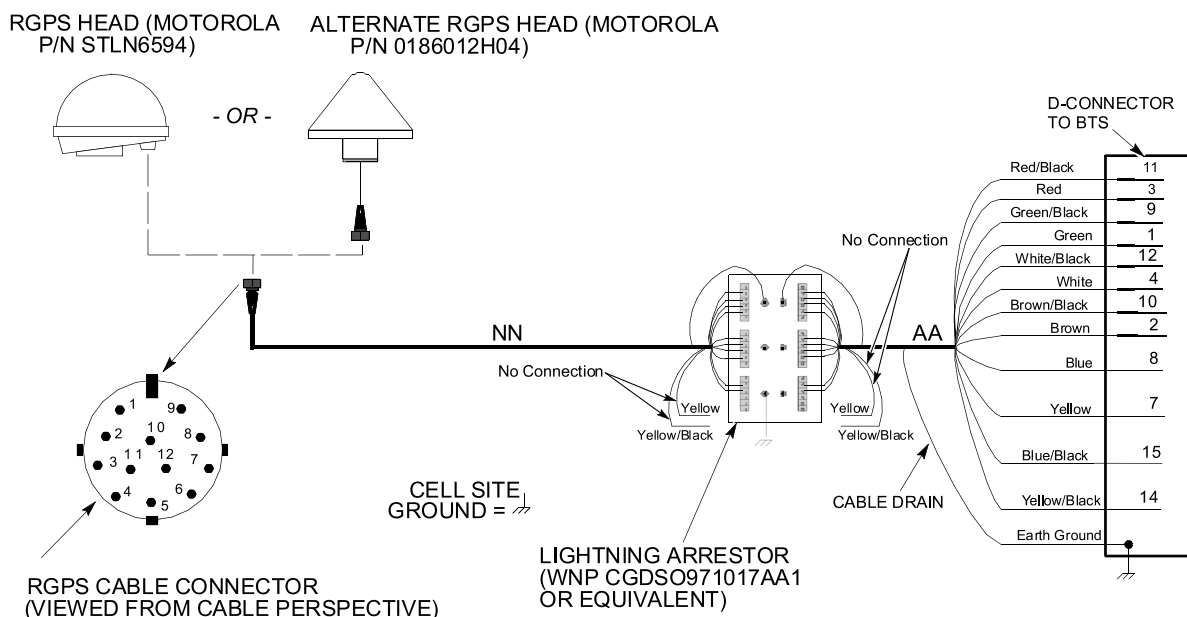

ti-cdma-05701.eps

Figure 2-8 RGPS lightning arrester wiring

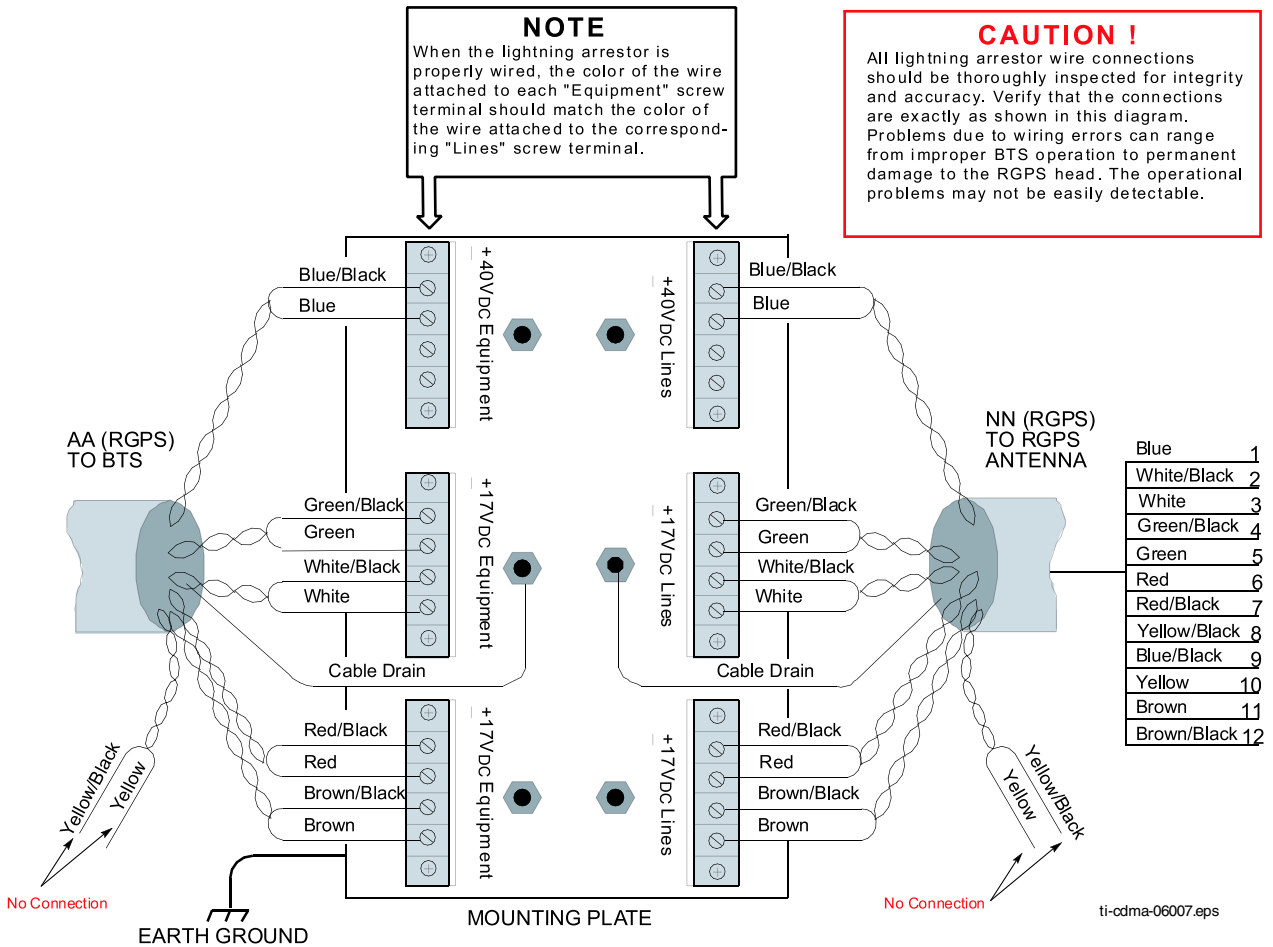

Mounting diagrams

Figure 2-9 and Figure 2-10 show the mounting details for the RGPS heads.

Figure 2-9 RGPS heads

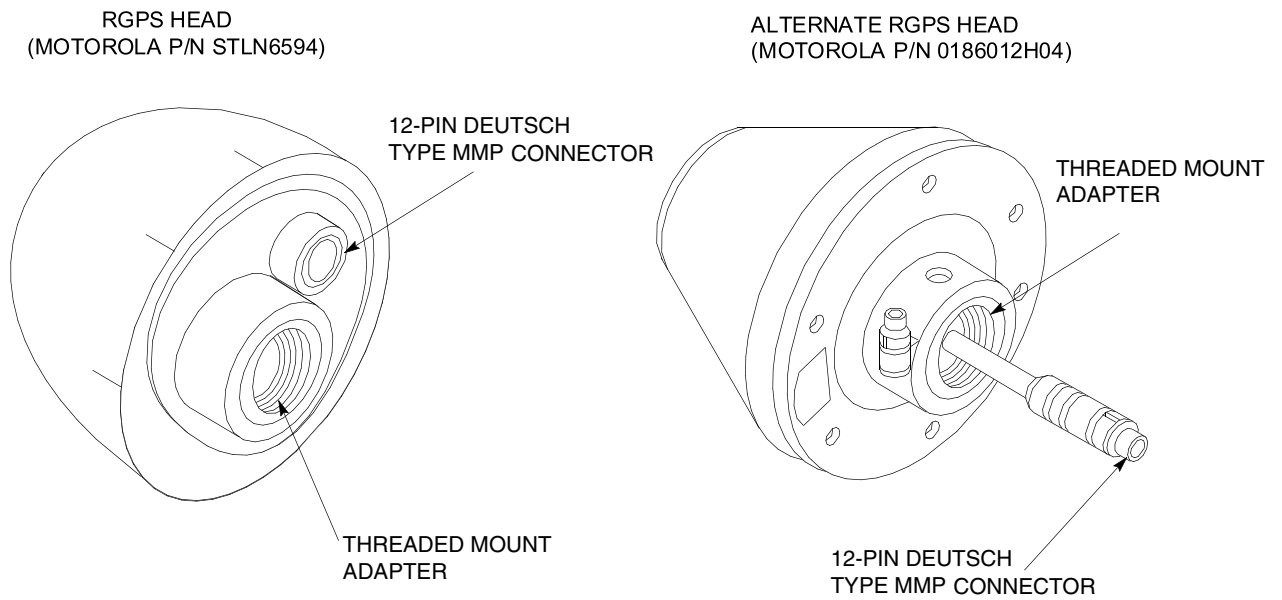

ti-cdma-05702.eps

Figure 2-10 Installing the RGPS head

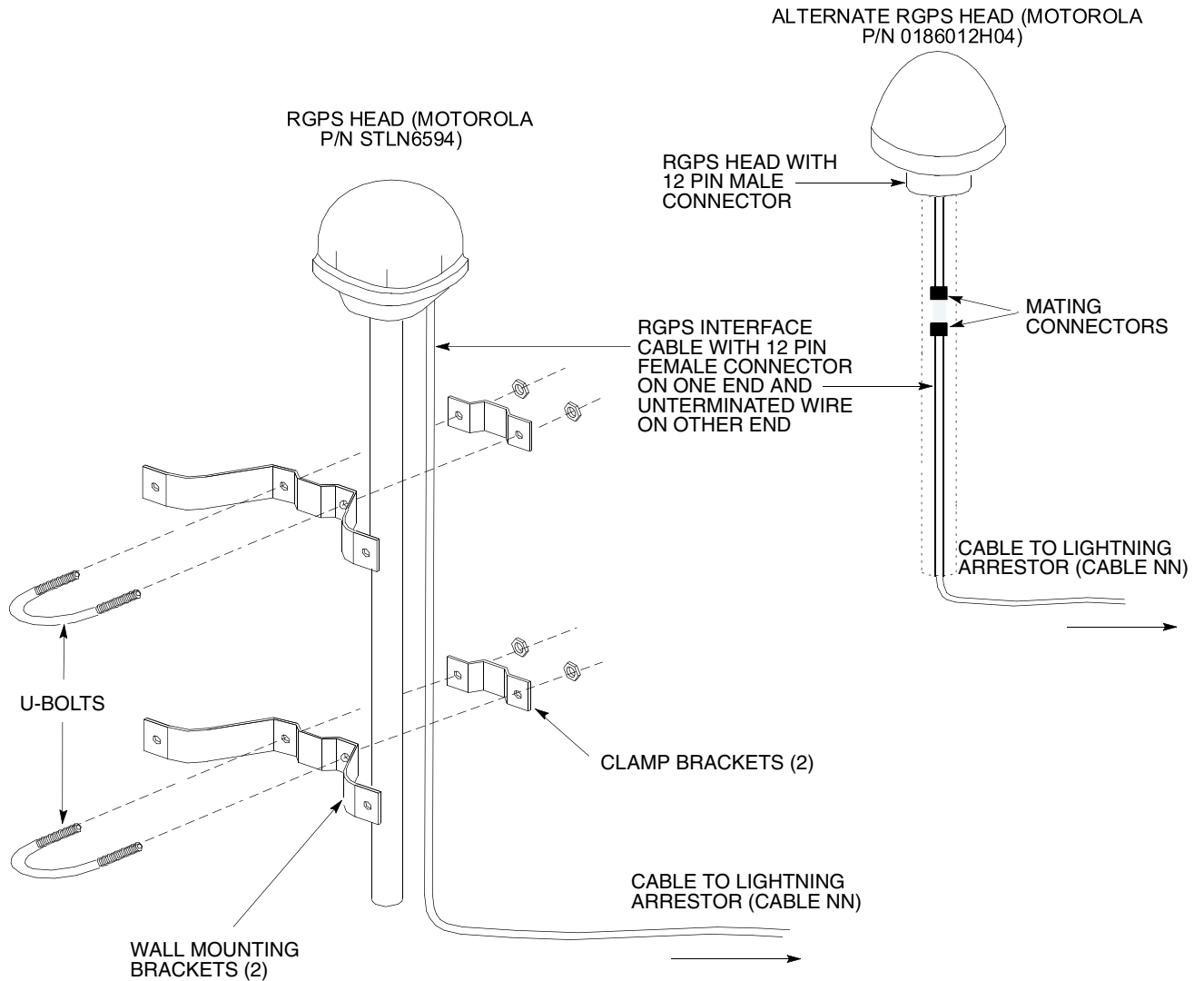

ti-cdma-05740.eps

Cable pinout

Figure 2-11 shows the connector pins on cables AA and NN. Table 2-10 gives the pinout for cable AA and NN and signal names.

Figure 2-11 Connector pin numbering for cables NN and AA

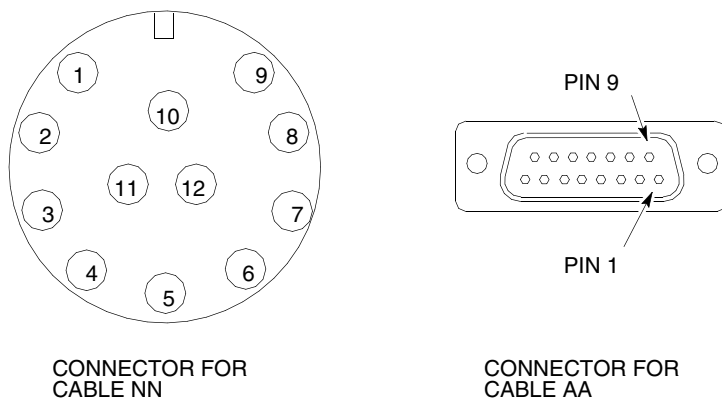

ti-cdma-00047.eps

Table 2-10 Pinout for cables NN and AA



Cable NN (12-cond)			Cable AA (12-cond)	
Pin (12-pins)	Signal	Wire Color	Pin (15-pins)	Signal
9	DC Ground 1	Blue-Black	15	RGPS Return
1	Power 1	Blue	8	RGPS +27 V Supply
8	Not Used	Yellow-Black	14	Not Used
10	Not Used	Yellow	7	Not Used
4	Transmit Port (-)	Green-Black	9	DATA (-) From Head
5	Transmit Port (+)	Green	1	DATA (+) From Head
2	Receive Port (-)	White-Black	12	DATA (-) To Head
3	Receive Port (+)	White	4	DATA (+) To Head
7	Not Connected	Red-Black	11	TDR Ground
6	Not Connected	Red	3	TDR (+)
12	PPS Timing (-)	Brown-Black	10	SYNC (-) From Head
11	PPS Timing (+)	Brown	2	SYNC (+) From Head
		Cable Drain (Shield)	13	Ground
			5, 6	Not Connected

Wire colors are the same for both cables.

Procedure

The procedure to install the RGPS antenna is as follows:

Procedure 2-1 Procedure to install an RGPS head

1	<p>Determine the mounting location for the RGPS head.</p> <div style="display: flex; align-items: center; margin-top: 10px;">  <div style="border: 1px solid black; background-color: #f4a460; padding: 2px 5px; font-weight: bold; color: white;">WARNING</div> </div> <p>The structure of the wall should be verified by a qualified structural engineer. Mounting the RGPS head and hardware to an inadequate wall structure and/or using inadequate installation methods can result in serious personal injury.</p>
2	Use the appropriate mounting bolts for the mounting surface and install the two wall mounting brackets. Refer to Figure 2-10 .
3	Route the 12-pin Deutsch (that is, circular) connector end of the RGPS cable (cable NN) to the RGPS head.
4	Connect the RGPS cable (cable NN) connector to the RGPS head 12-pin circular connector as shown in Figure 2-7 and Figure 2-10 . Tighten the spinning flange on the connector a quarter turn, to secure the connection.
5	Insert the RGPS mounting pipe into the threaded mount of the RGPS head and carefully tighten it manually.
6	Install the RGPS mounting pipe into the mounting brackets as shown in Figure 2-10 . Tighten the U-bolt clamps to secure the assembly. For the STLN6594 RGPS Head, tape or tie-wrap the cable to the mounting pipe.
7	Route the free end of the BTS RGPS cable (cable NN) to the RGPS cable lightning arrester. Remove any excess cable length and strip off approximately 15 cm of the cable outer insulation.
8	<p>Connect the twelve (12) wires and cable drain of the cable end to the lightning arrester as shown in Figure 2-8. Double check the lightning arrester connections for compliance as displayed in Figure 2-8.</p> <div style="display: flex; align-items: center; margin-top: 10px;">  <div style="background-color: #00cccc; padding: 2px 5px; font-weight: bold; color: white;">NOTE</div> </div> <p>RGPS cable AA gets connected to the UBS Macro BTS and then routed to the RGPS cable lightning arrester during Task 8.</p>

Tasks 2-3: Installing Rack & Ground Cable

Objective

The objectives of this procedure are as follows:

- Mount the rack to the floor.
- Install the ground cable (DD).

Rack requirements

The UBS Macro BTS equipment is designed to be mounted in an open standard 19-inch rack.

To ensure proper equipment support, grounding, and easy installation, Motorola recommends that the UBS Macro BTS equipment be mounted in one of the following applicable Motorola racks:

- STHN4120 19-inch (1800 mm)
- STHN4121 19-inch (1400 mm)
- STHN4122 19-inch (1000 mm)

Structural engineer prerequisite

Ensure that the procedure, tools, and equipment required to mount the rack to the floor are specified by a Structural Engineer.

Required items

The following items are required:

- Rack
- 10 mm socket
- Torque driver
- Flat blade screwdriver
- 6 carbon steel grade 8.8 bolts M12 - customer supplied
- Other items, specified by the Structural Engineer, that are required to install the rack
- Cable DD - customer supplied ground cable, 4 AWG or larger diameter
- Two-hole ground lug and mounting nuts - part of rack hardware kit (CGDSTB54205)

Location of rack earth ground terminals

Figure 2-12 shows the location of the ground terminals on the rack.

Figure 2-12 Location of ground terminals on a Motorola rack

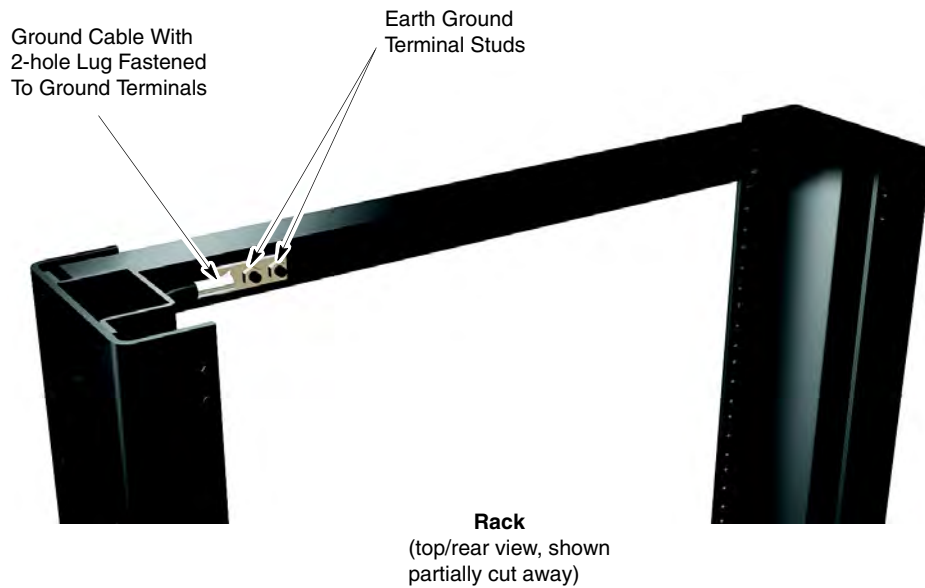

ti-cdma-05691.eps

Procedure

Procedure 2-2 gives the procedure for performing Tasks 2-3.

Procedure 2-2 Performing Tasks 2-3

1	<p>Mount the rack to the floor using the hardware, tools and procedures defined by the Structural Engineer.</p> <div style="display: flex; align-items: center; margin-top: 10px;"> <div style="background-color: #00b050; color: white; padding: 5px 10px; font-weight: bold; text-align: center;">NOTE</div> </div> <p style="margin-top: 10px;">Motorola recommends using carbon steel grade 8.8 M12 bolts.</p>
----------	--

Continued

Procedure 2-2 Performing Tasks 2-3 (Continued)

2	<p>Route the ground cable (cable DD) between the Master Ground Bar (MGB) and the rack.</p> <div data-bbox="483 372 582 478"></div> <div data-bbox="608 395 842 446">NOTE</div> <p data-bbox="608 495 1137 527">Ground cables must not have sharp bends.</p>
3	Strip insulation from the frame end of cable DD.
4	Attach the 2-hole lug to the rack-end of the cable DD.
5	Attach the end of cable DD with the 2-hole lug to the 2 terminal studs at the top of the rack. Using 2 nuts, 10 mm socket and ratchet, tighten the nuts to 5.65 N-m (50 inch-lb). Refer to Figure 2-12 for location of ground terminal studs on the rack.
6	Cut cable DD to length and connect it to the Master Ground Bar.
7	Verify that the Master Ground Bar is connected to a solid earth ground.

Task 4: Rack Mounting the Optional PSM Shelf

Objective

The objective of this procedure is to perform task 4:

- For -48 V DC or 220 V AC UBS only.
Install the PSM shelf to the bottom of the rack. The site configuration/characteristics will determine if a PSM shelf is to be installed.
- Install the appropriate, -48 V DC or 220 V AC, PSMs into PSM shelf slots 1 and 2. Either up to two -48 V DC or up to two 220 V AC PSMs can be installed in the shelf. One PSM is required for the low capacity configuration and the second PSM is for redundancy.

Required items

The following items are required:

- Either a -48 V DC or 220 V AC PSM shelf (whichever is applicable)
- Either up two -48 V DC or 220 V AC PSMs (whichever is applicable)
- Eight (8) M5 x 12 mm screws for mounting the PSM shelf - these screws are included in the STGN4034 Installation Kit that is packaged with the UBS Macro carrier strip assembly
- Tape measure with millimeter scale, capable measuring up to 1200 mm or with inch scale, capable measuring up to 48 inches; for measuring screw location heights on rack
- TORX T25 bit and driver
- Torque driver

Procedure

[Procedure 2-3](#) gives the procedure for performing Task 4.

Procedure 2-3 Procedure for Task 4

1	Locate the bottom RU that is to be used for the installation of the PSM shelf.
2	Using a tape measure, measure mounting screw location heights on each side of the rack. Measure from the bottom of the RU determined in step 1 (Refer to Figure 2-13). Mark the following screw locations:

Continued

Procedure 2-3 Procedure for Task 4 (Continued)

	<ul style="list-style-type: none"> • 136 mm (5.35 inches) for PSM shelf
3	Partially insert an M5 x 12 mm screw into each location marked on the rack. Leave the screw heads extending 7 mm out from the rack surface.
4	Remove the PSM shelf from its packaging.
5	Align the keyhole slots in the PSM shelf with the bottom screws, installed in step 3 above (Refer to Figure 2-14).
6	Insert screws in the 6 open slots of the PSM shelf and tighten all 8 PSM shelf screws to 4.77 N-m (42 in-lb).
7	<div style="text-align: center;">  <div style="border: 1px solid black; padding: 2px; display: inline-block; background-color: #f4a460;">WARNING</div> </div> <p>PSM weighs approximately 5 kg. Be careful when handling the PSM to prevent damage to the equipment and personal injury.</p> <p>Install the appropriate PSMs into PSM shelf slots 1 and 2 as follows:</p> <ol style="list-style-type: none"> 1. Grasp the handle on the front panel of the PSM with one hand while carefully supporting the bottom of the module with the other hand. 2. Properly orient the PSM and insert it into the slot. 3. Slowly slide the module into the shelf until the rear connectors are fully seated. Make sure that the PSM is fully engaged with the shelf backplane slot connectors.
8	Using a T25 TORX bit and torque driver, tighten the PSM captive retaining thumbscrew to 2.37 N-m (21 in-lb).

Procedural reference diagrams

The following diagrams help clarify certain steps in [Procedure 2-3](#).

Figure 2-13 Hanger screw layout for the optional PSM shelf



NOTE

1. All dimensions are in millimeters
2. 1800 mm high rack shown. Dimension and hanger screw locations are also applicable for the 1400 mm rack.

ti-cdma-06011.eps

Figure 2-14 Hanging the PSM shelf

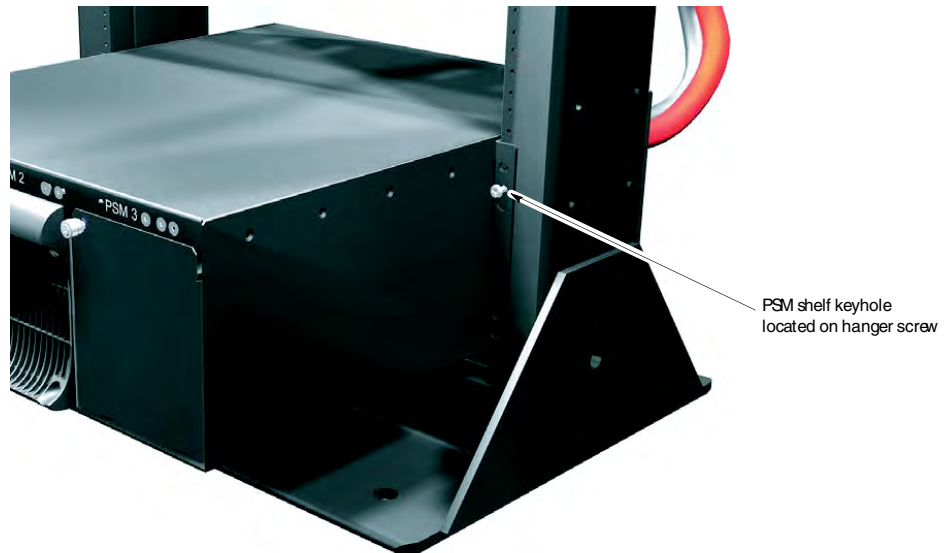

NOTE
1. A keyhole/hanger screws located on both the right and left sides.
Both keyholes/hanger screws should be engaged at the same time.

ti-cdma-05869.eps

Task 5: Rack Mounting for Low-Capacity Frame

Objective

The objective of Task 5 is to install the UBS Macro carrier strip assembly into an EIA 19-inch rack.

The UBS Macro carrier strip assembly contains all of the equipment required for configuring a low-capacity, +27 V DC starter frame. The layout of the equipment on the carrier strips allows capacity expansion of the frame.

The most common and preferred method is to install the UBS Macro carrier strip assembly into an 1800 mm or 1400 mm high rack. This method requires that there be 600 mm of clearance on the left and right sides of the rack.



NOTE

The UBS Macro carrier strip assembly requires a minimum of 27 Rack Units (RUs) of continuous space.

Required items



The following items are required:

- UBS Macro carrier strip assembly
- Tape measure with millimeter scale, capable measuring up to 1200 mm or with inch scale, capable measuring up to 48 inches; for measuring screw location heights on rack
- Twenty-six (26) M5 x 12 mm screws for mounting the UBS carrier strip assembly - these screws are included in the STGN4034 Installation Kit that is packaged with the UBS Macro carrier strip assembly
- TORX T25 bit and driver
- Torque driver
- 10 mm socket and ratchet

Procedure



Procedure 2-4 gives the procedure for performing Task 5.

Procedure 2-4 Rack Mounting the Low-Capacity, +27 V DC UBS Macro BTS Assembly

1	<p>Using a tape measure, measure mounting hanger screw location heights on each side of the rack (see Figure 2-15 Hanger screw layout for UBS Macro carrier strip assembly on page 2-40). Measure down from the very top of the rack. Mark the following screw locations:</p> <ul style="list-style-type: none"> 95.25 mm (3.75 inches) for the top of the UBS Macro carrier strip assembly
2	Partially insert an M5 x 12 mm screw into each location marked on the rack. Leave the screw heads extending 7 mm out from the rack surface.
3	Move the pallet with the unpacked UBS Macro carrier strip assembly and support near the rack so as to allow movement on both sides of the support and in front of the rack. Leave the carrier strip assembly on the support.
4	<p>step 5 through step 7 are for the optional removal of the XMI from the UBS Macro carrier strip assembly. XMI removal should only be performed if the UBS Macro carrier strip assembly is too heavy for two people to lift.</p> <div style="margin-top: 10px;">  <div style="display: inline-block; background-color: #00FFFF; padding: 5px; margin-left: 10px;">NOTE</div> <p>The preferred method is to skip the XMI removal steps and use a suitable device or 4 people to lift the assembly/carrier strips.</p> </div> <div style="margin-top: 10px;">  <div style="display: inline-block; background-color: #00FFFF; padding: 5px; margin-left: 10px;">NOTE</div> <p>The UBS Macro carrier strip assembly with the XMI installed weighs approximately 60 kg (132.3 lb) and the XMI weighs 23-28 kg (50.7-61.7 lb) depending on the RF band.</p> <p>If you are skipping the XMI removal steps, go to step 8. Otherwise, go to step 5.</p> </div>
5	Remove the XMI from the UBS Macro carrier strip assembly. Refer to the photographs in Figure 2-16 Removing the XMI from the carrier strip assembly on page 2-41 . Disconnect all cables from the front of the XMI (see photographs A and B). Dress these disconnected cables away from the front of the XMI.
6	Using a T25 TORX driver, remove the four XMI mounting screws; two screws at each of the top and bottom mounting tabs on the front of the module.

Continued

Procedure 2-4 Rack Mounting the Low-Capacity, +27 V DC UBS Macro BTS Assembly (Continued)

7	<p>Using two hands, grasp the XMI by its handle and lift it straight up and out of the UBS Macro carrier strip assembly (see photographs C and D). Set the XMI aside for later reinstallation.</p> <div style="display: flex; align-items: center; margin-top: 10px;">  <div style="border: 1px solid black; background-color: yellow; padding: 2px 10px; font-weight: bold;">CAUTION</div> </div> <p>An XMI module that is not in a shelf should always be set on its side and never on its edge. This will prevent the XMI module from tipping over and causing damage or injury.</p>
8	<div style="display: flex; align-items: center; margin-bottom: 10px;">  <div style="background-color: cyan; padding: 2px 10px; font-weight: bold; color: white;">NOTE</div> </div> <p>The carrier strips allow up to four people to carefully lift the UBS Macro carrier strip assembly off the support and onto the rack. The assembly can also be lifted via some mechanical aid (hoist, etc.) attached to the lifting loops on the ends of the carrier strips.</p> <div style="display: flex; align-items: center; margin-bottom: 10px;">  <div style="background-color: cyan; padding: 2px 10px; font-weight: bold; color: white;">NOTE</div> </div> <p>Four people, two on each side, are needed to lift the carrier strip assembly with the XMI installed.</p> <p>Two people, one on each side, are needed to lift the carrier strip assembly without the XMI installed.</p> <p>Lift the UBS Macro carrier strip assembly up and off of the support and onto the rack (see Figure 2-17 Lifting and hanging the carrier strip assembly on the rack (XMI shown removed) on page 2-42).</p>
9	Using the carrier strip hanger screws previously installed in the rack, align the top carrier strip keyhole slots with the two hanger screws. Hang the carrier strip assembly on these two screws.
10	Insert a screw in the two bottom carrier strip keyhole slots (see Figure 2-18 Carrier strip assembly keyhole screw locations on page 2-43). Do not tighten the screws in carrier strip keyhole slots.
11	Insert screws in the 22 open slots of the various shelves of the carrier strip assembly. Using a T25 TORX driver, tighten these 24 screws to 4.77 N-m (42 in-lb).
12	Using a T25 TORX driver, tighten the four screws in carrier strip keyhole slots to 4.77 N-m (42 in-lb).
13	If the XMI was removed, go to step 14 .

Continued

Procedure 2-4 Rack Mounting the Low-Capacity, +27 V DC UBS Macro BTS Assembly (Continued)

14	Grasp the XMI by its handle with one hand and the XMI bottom edge with the other hand. Lift the XMI and fully insert it into slot 1 (left most slot) of the XMI shelf. See photograph A of Figure 2-19 Reinstalling the XMI on page 2-44 .
15	Insert the four XMI mounting screws; two screws at each of the top and bottom mounting tabs on the front of the module. Using a T25 TORX driver, tighten the screws to 4.77 N-m (42 in-lb).
16	<p>Reconnect all cables to the XMI front panel.</p> <div style="text-align: center;">  <div style="border: 1px solid black; padding: 2px; display: inline-block; background-color: yellow;">CAUTION</div> </div> <p>To avoid blocking exhaust air from the XMI, be certain that the XMI power cable is routed to the outside of the XMI at the back of the rack.</p> <p>See photographs B through D of Figure 2-19 Reinstalling the XMI on page 2-44.</p>
17	<p>This step is optional and is only performed if there is a desire to remove the carrier strips from the frame. Remove the carrier strips from the frame as follows:</p> <ul style="list-style-type: none"> • Using a 10 mm socket and ratchet, loosen and remove the 8 nuts that secure each carrier strip to the frame. • Remove the carrier strip.

Procedural reference diagrams

The following diagrams help clarify certain steps in [Procedure 2-4](#).

- [Figure 2-15 Hanger screw layout for UBS Macro carrier strip assembly on page 2-40](#)
- [Figure 2-16 Removing the XMI from the carrier strip assembly on page 2-41](#)
- [Figure 2-17 Lifting and hanging the carrier strip assembly on the rack \(XMI shown removed\) on page 2-42](#)
- [Figure 2-18 Carrier strip assembly keyhole screw locations on page 2-43](#)
- [Figure 2-19 Reinstalling the XMI on page 2-44](#)

Figure 2-15 shows hanger screw layout used for mounting the UBS Macro carrier strip assembly onto a 1400 mm or 1800 mm high EIA 19-inch rack.

Figure 2-15 Hanger screw layout for UBS Macro carrier strip assembly



NOTE

- 1. All dimensions are in millimeters
- 2. 1800 mm high rack shown. Dimension and hanger screw locations are also applicable for the 1400 mm rack

ti-cdma-06012.eps

Figure 2-16 shows the optional removal of the XMI from the UBS Macro carrier strip assembly just prior to rack mounting the carrier strip assembly.

Figure 2-16 Removing the XMI from the carrier strip assembly



A

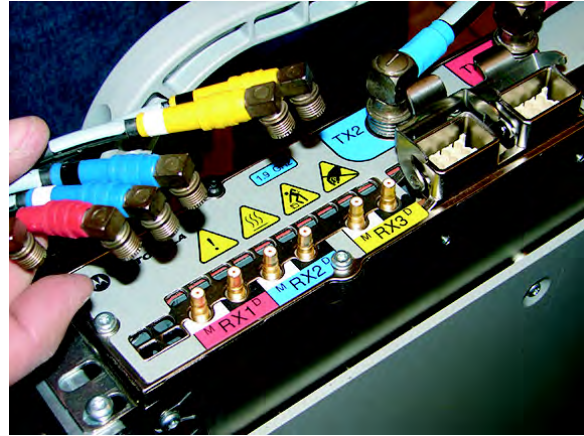

B

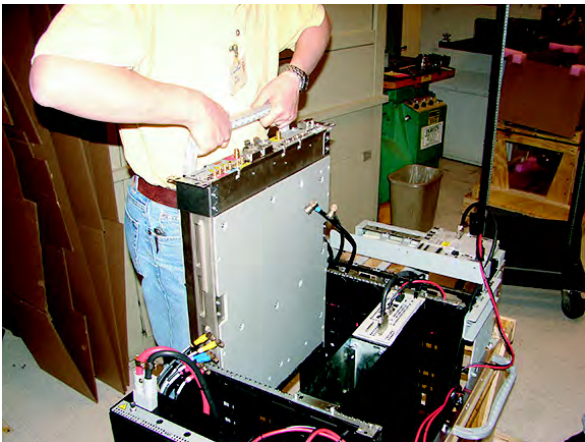

C

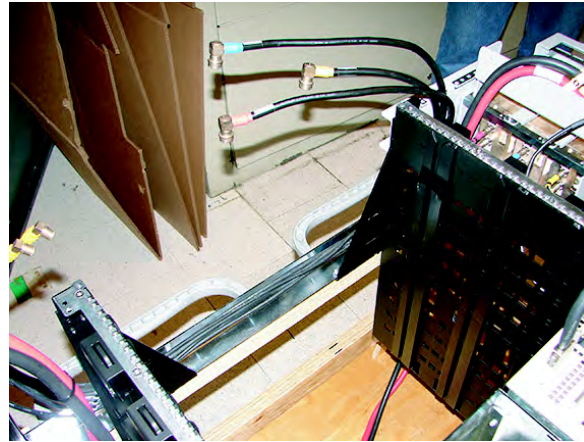

D

ti-cdma-06028.eps

Figure 2-17 shows two people lifting and hanging the UBS Macro carrier strip assembly on the rack.

Figure 2-17 Lifting and hanging the carrier strip assembly on the rack (XMI shown removed)

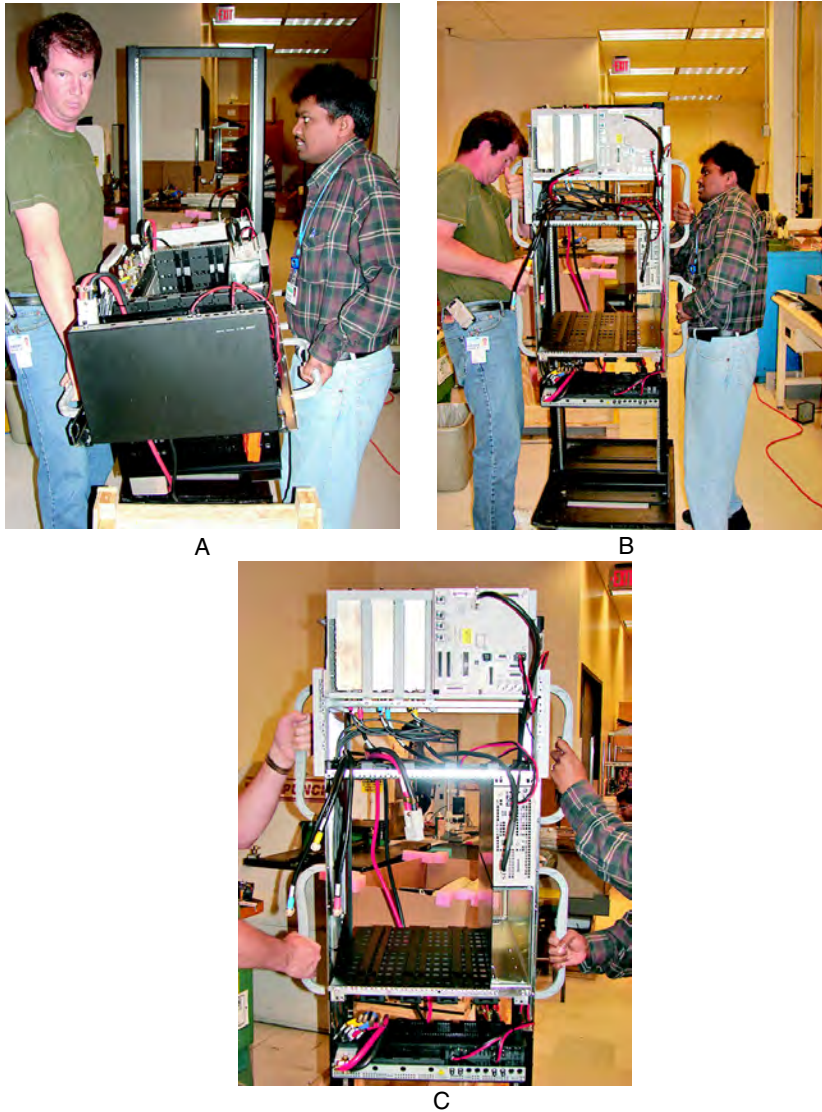

ti-cdma-06029.eps

Figure 2-18 shows the keyhole screw locations in a rack mounted UBS Macro carrier strip assembly.

Figure 2-18 Carrier strip assembly keyhole screw locations

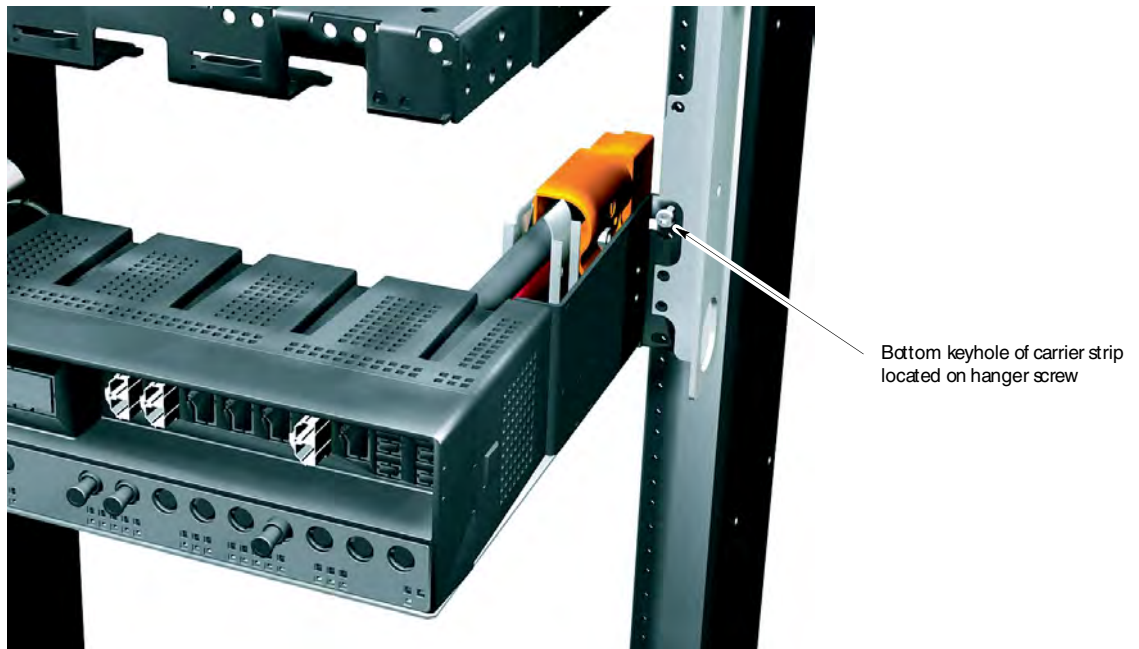

NOTE

1. Another carrier strip keyhole/hanger screw is located at the top of the right side carrier strip/rack rail. The left side carrier strip/rack rail has atop and bottom keyholes/hanger screws at the same heights as the right side. All four keyholes/hanger screws should be engaged at the same time.

ti-cdma-05870.eps

Figure 2-19 shows how to reinstall the XMI into the frame if the XMI was previously removed from the UBS Macro carrier strip assembly.

Figure 2-19 Reinstalling the XMI

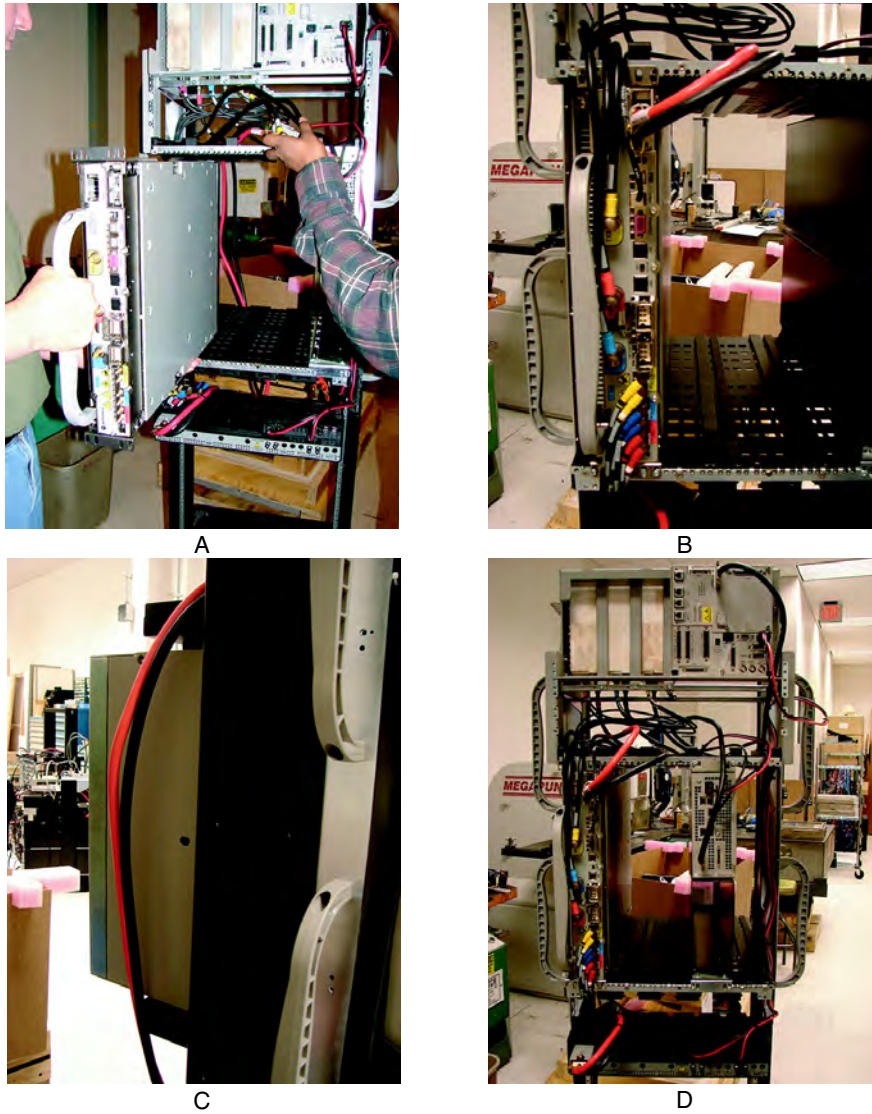

ti-cdma-06030.eps

Task 6: Expanding the Low-capacity Frame



NOTE

If the initial UBS Macro BTS installation is for a low-capacity frame configuration, skip this task and go to [Task 7: Cabling the Optional PSM Shelf on page 2-46](#).

Perform this task only if the initial UBS Macro BTS installation is for a mid-capacity frame configuration.

Objective

The objective of Task 6 is to install the additional equipment required to expand the UBS Macro BTS low-capacity starter/expansion frame to the mid-capacity frame configuration.



NOTE

Currently a UBS Macro BTS low-capacity starter/expansion frame can only be expanded to mid-capacity. In the future, the low-capacity starter/expansion frames and mid-capacity frames will be expandable to high-capacity.

Procedure

Go to [Chapter 3 Low-to-Mid Capacity Frame Expansion Procedures](#) and perform all of the applicable procedures for expanding the low-capacity UBS Macro BTS starter/expansion frame to the mid-capacity frame configuration.

After all of the additional expansion equipment is installed, go to [Task 7: Cabling the Optional PSM Shelf on page 2-46](#) and continue performing the remaining tasks in sequential order.

Task 7: Cabling the Optional PSM Shelf

Objective

The objectives of this procedure are to perform Tasks 7:

- For -48 V DC or 220 V AC UBS only.
Connect the +27 V DC power output cable from the rear of the PSM shelf to the +27 V DC power input cable on the rear of the PDU.
- For -48 V DC or 220 V AC UBS only
Connect the 50-conductor cable (supplied with PSM shelf) between the PSM shelf front panel ALARM/CONTROL connector and SSI front panel PSM connector.

Required items

The following items are required:

- 50-conductor cable (supplied with PSM shelf)
- Flat blade screw driver

Procedure

[Procedure 2-5](#) gives the procedure for performing Task 7.

Procedure 2-5 Procedure for Task 7

1	Connect the +27 V DC power output cable from the rear of the PSM shelf to the +27 V DC power input cable on the rear of the PDU. Mate Orange connectors together.
2	Connect the 50-conductor cable (supplied with PSM shelf) between the PSM shelf front panel ALARM/CONTROL connector and SSI front panel PSM connector. Refer to Figure 2-3 and Figure 2-4 for the connector locations on the PSM shelf front panel and on the SSI.

Tasks 8-9: Connecting TX/RX Antennas

Objective

The objectives of performing Tasks 8-9 are as follows:

- Install the external antenna cables to the Integrated Duplexer RX Filters (IDRFs).
- Install terminators on the IDRFs.

The site configuration/characteristics determines the IDRF usage.

Required items

The following items are required:

- External TX and RX 50 Ohm coaxial cables with type N connectors (customer supplied)
- 0.25 W, 50 Ohm, SMA-type male terminators (customer supplied) for unused directional coupler port connectors
- 50 W N-type male terminator (customer supplied) for unused TX/RX connectors
- SMA breakover wrench
- 19 mm open-end hex wrench (N-type connector)

Location of antenna connectors

The top view of [Figure 2-1](#) and [Figure 2-2](#) show the location of the UBS Macro BTS antenna connectors on the top of the IDRF.

Procedure

The procedure for performing the Tasks 8-9 is as follows.

Procedure 2-6 Procedure for Tasks 8-9

- | | |
|----------|---|
| 1 | Route the customer supplied TX/RX main and RX diversity antenna cables to the top of the Integrated Duplexer RX Filters (IDRFs), located at the top of the frame. |
|----------|---|

Continued

Procedure 2-6 Procedure for Tasks 8-9 (Continued)

2	<p>Connect each antenna cable to the corresponding IDRf type N connector. Refer to Figure 2-1 or Figure 2-2, whichever is applicable, for the location of the UBS Macro BTS antenna connectors on the top of the IDRf. Using a 19 mm open-end hex wrench, tighten the cable connectors to 4.3 N-m (38 in-lb).</p> <div data-bbox="443 434 544 540"> </div> <div data-bbox="571 459 804 506"> <p>NOTE</p> </div> <p>The IDRfs are not labeled for a sector. To determine the sector for each IDRf, look at the color code of the XMI TX and RX cables connected to the bottom of the IDRf. Refer to Table 2-2 for the mapping of the cable color to the sector (Red = sector 1, Blue = sector 2, Yellow = sector 3). The sectors can also be determined by tracing those XMI cables back to the XMI TX and RX ports, which are labeled as TX1 and RX1 for sector 1, TX2 and RX2 for sector 2, and TX3 and RX3 for sector 3.</p>
3	<p>Connect customer supplied 0.25 W, 50 Ohm, SMA-type terminators to any unused directional coupler port connectors on the top of the IDRfs.</p>
4	<p>For any unused TX/RX connector on an IDRf, install a 50 W N-type terminator (customer supplied).</p>

Tasks 10-13: Connecting RGPS, Spans, Customer Alarms

Objective



CAUTION

The SSI provides only secondary surge protection for the RGPS and T1/E1 span connections. The customer is responsible for providing primary surge protection.

The objectives of performing Tasks 10–13 are as follows:

- Install RGPS cable AA between the RGPS cable lightning arrester and UBS Macro BTS.
- Install T1/E1 balanced Span I/O cable (W) between the UBS Macro BTS the site span line interconnect equipment.
- Install E1 unbalanced Span I/O coaxial cables (customer supplied) between the UBS Macro BTS the site span line interconnect equipment.
- Install Customer Alarm Input/Output (IP/OP) cables (X) between the UBS Macro BTS the Customer IP/OP interconnect equipment.

The site configuration/characteristics determines whether the cables in Tasks 10-13 are to be installed.

Cabling options

The site characteristics determine the use of cables AA, W and X.

The RGPS cable (AA) is optional and used only when the optional RGPS head is used.

The T1/E1 balanced Span I/O cable (W) can carry up to 8 spans, but the UBS Macro BTS currently supports only up to 4 spans. This is also true for E1 unbalanced Span I/O coaxial cables (customer supplied).



NOTE

For Span I/O cable (W), the minimum size of span line wires is 26 AWG.

The usage and quantity of Customer Alarm Input/Output (IP/OP) cables (X) is determined by the customer.

Required items

The following items are required:

- Cable AA - Part number 3086433H12
- Cable W - Part number CGDS19797321
- Cable X - Part number CGDS19797321



NOTE

All SSI cable connectors with jack-screws require a flat-blade driver and should be tightened to 1.02 N-m (9 in-lb).

Location of cables AA, W and X

Figure 2-3 shows the connector locations on the front panel of the SSI for: RGPS cable (AA), T1/E1 balanced span line cable (W), E1 unbalanced span line coaxial cables, and customer alarm cable (X).

The optional RGPS cable (AA) has a 15-pin D-connector on one end that connects to the RGPS connector, located on the front of the SSI. The other cable end has loose wires. This end is routed to the RGPS lightning arrester, where the wires connect. Refer to Figure 2-6 through Figure 2-11, Table 2-9 and Table 2-10 for RGPS cable (AA) details.

Details for cables (W) and (X) are provided in this task section.

Balanced T1/E1 cable (W) details

Figure 2-20 and Table 2-11 show the pin and signal information for cable W.

Figure 2-20 T1/E1 balanced span line cable (W) pin numbering

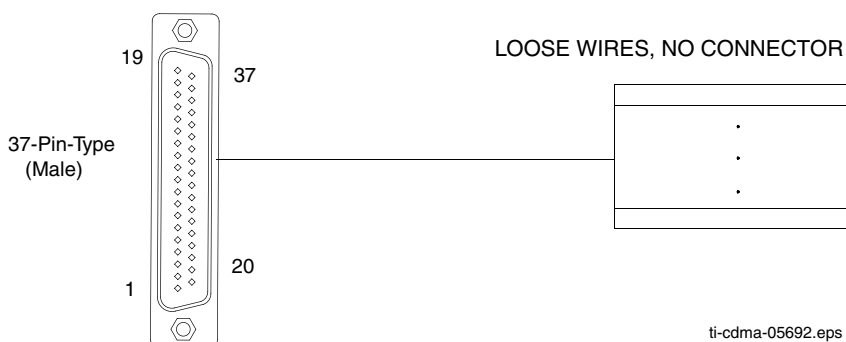

Figure 2-20 shows E1 unbalanced 75-Ohm BNC connectors and labeling on the daughter card.

Table 2-11 also shows the correlation between spans and the E1 unbalanced Span I/O coaxial BNC connectors.

Table 2-11 T1/E1 I/O cable W (span) signal and pin information

Span number	Signal name	T1/E1 Balanced Span 36-Cond Shielded Twisted Pair Cable (W) 37-Pin D-Sub Connector		E1 Unbalanced 75-Ohm Coaxial Cable BNC Connection (RING is GND/shield)
		Pin	Wire Color	
1	TX1_TIP	1	White/Blue	TX1
	TX1_RING	20	Blue/White	
	RX1_TIP	12	Black/Orange	RX1
	RX1_RING	30	Orange/Black	
2	TX2_TIP	2	White/Orange	TX2
	TX2_RING	21	Orange/White	
	RX2_TIP	13	Black/Green	RX2
	RX2_RING	31	Green/Black	
3	TX3_TIP	3	White/Green	TX3
	TX3_RING	22	Green/White	
	RX3_TIP	14	Black/Brown	RX3
	RX3_RING	32	Brown/Black	
4	TX4_TIP	4	White/Brown	TX4
	TX4_RING	23	Brown/White	
	RX4_TIP	15	Black/Gray	RX4
	RX4_RING	33	Gray/Black	
5	TX5_TIP	5	White/Gray	TX5
	TX5_RING	24	Gray/White	
	RX5_TIP	16	Yellow/Blue	RX5
	RX5_RING	34	Blue/Yellow	
6	TX6_TIP	6	Red/Blue	TX6
	TX6_RING	25	Blue/Red	
	RX6_TIP	17	Yellow/Orange	RX6
	RX6_RING	35	Orange/Yellow	
7	TX7_TIP	7	Red/Orange	TX7
	TX7_RING	26	Orange/Red	
	RX7_TIP	18	Yellow/Green	RX7
	RX7_RING	36	Green/Yellow	

Continued

Table 2-11 T1/E1 I/O cable W (span) signal and pin information (Continued)

Span number	Signal name	T1/E1 Balanced Span 36-Cond Shielded Twisted Pair Cable (W) 37-Pin D-Sub Connector		E1 Unbalanced 75-Ohm Coaxial Cable BNC Connection (RING is GND/shield)
		Pin	Wire Color	
8	TX8_TIP	8	Red/Green	TX8
	TX8_RING	27	Green/Red	
	RX8_TIP	19	Yellow/Brown	RX8
	RX8_RING	37	Brown/Yellow	
	Ground	9	Red/Brown	
	Ground	28	Brown/Red	
	Not Connected	10		
	Ground	11	Black/Blue	
Ground	29	Blue/Black		

Customer alarm input/output (IP/OP) cable (X) details

Alarm connectors

There are two ALARM connectors on the UBS Macro SSI:

- CUSTOMER IP 1-12 OP 1-4 connector
- CUSTOMER IP 13-24 OP 5-8 connector

Each ALARM connector provides 12 inputs and 4 outputs. A total of 24 inputs and 8 outputs are available.

Function

ALARM connectors provide for Customer Defined Alarm Inputs and Outputs. The customer can connect BTS site alarm input sensors and output devices to the UBS Macro BTS, thus providing alarm reporting of active sensors as well as controlling output devices.

The SSI detects signals from customer input sensors and reports the detected signals to the DMI controller, which in turn reports the detected alarm to the OMC-R, where it is displayed as defined by the customer.

The SSI also provides switched relay contacts to customer output devices. The SSI controls relay contacts according to output control signals from the DMI controller, in response to customer defined commands entered at the OMC-R.

Input connections

Each input consists of a wire/pin pair (that is, input/Gnd). To ensure proper operation, each pair to be used must be connected to an external sensor that provides a dry-contact closure. The customer sensor output connects between an optically isolated 5 V DC signal and an isolated return.

For an OPEN circuit (logic **0**) between pins:

- There is 10 K Ohms or greater across the input pair.
- The signal to ground voltage is +5 V DC.

For a CLOSED circuit (logic **1**) between pins:

- There is 1 K Ohms or less across the input pair.
- The signal to ground current is a maximum of 9 mA.

Either of the above states can be defined by the customer in system software as an alarm condition.

Output connections

Each output consists of 3-wires/pins:

- COM
- NC
- NO

The customer output device control inputs connect between the common (COM) and either the normally closed (NC) or normally open (NO) contacts of a relay. The NC and NO state for relay contacts occurs when the relay coil is not energized.

Relay contacts are load rated for a maximum of 1 A at 24 V DC and 0.5 A at 50 V DC.

The toggling of relay contacts to the opposite state is controlled by system software.

Pins and signals

[Figure 2-21](#), [Table 2-12](#) and [Table 2-13](#) show the pin and signal information for cable X.

Figure 2-21 Customer alarm cable (X) pin numbering

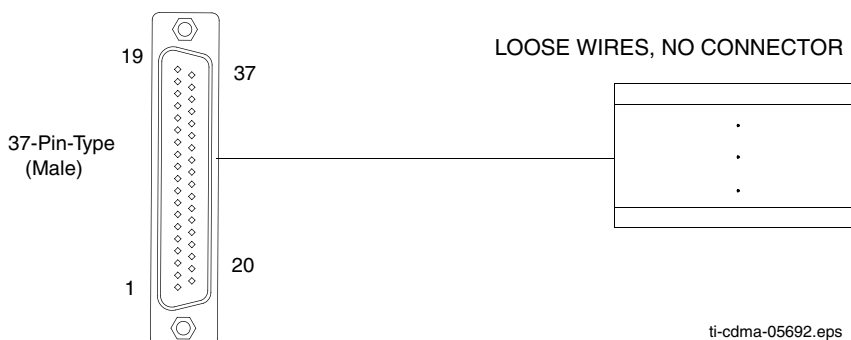

ti-cdma-05692.eps

Table 2-12 Customer alarm cable (X) pinout for customer IP 1-12 OP 1-4

37-Pin D-Sub Pin number	Signal Description	Wire Color	37Pin D-Sub Pin number	Signal Description	Wire Color
1	Customer Input 1	White/Blue	20	Input 1 Gnd	Blue/White
2	Customer Input 2	White/Orange	21	Input 2 Gnd	Orange/White
3	Customer Input 3	White/Green	22	Input 3 Gnd	Green/White
4	Customer Input 4	White/Brown	23	Input 4 Gnd	Brown/White
5	Customer Input 5	White/Gray	24	Input 5 Gnd	Gray/White
6	Customer Input 6	Red/Blue	25	Input 6 Gnd	Blue/Red
7	Customer Input 7	Red/Orange	26	Input 7 Gnd	Orange/Red
8	Customer Input 8	Red/Green	27	Input 8 Gnd	Green/Red
9	Customer Input 9	Red/Brown	28	Input 9 Gnd	Brown/Red
10	Not Connected		29	Customer Output NC 1	Blue/Black
11	Customer Output NO 1	Black/Blue	30	Customer Output Common 1	Orange/Black
12	Customer Output NO 2	Black/Orange	31	Customer Output Common 2	Green/Black

Continued

Table 2-12 Customer alarm cable (X) pinout for customer IP 1-12 OP 1-4 (Continued)

37-Pin D-Sub Pin number	Signal Description	Wire Color	37Pin D-Sub Pin number	Signal Description	Wire Color
13	Customer Output NC 2	Black/Green	32	Customer Output NC 3	Brown/Black
14	Customer Output NO 3	Black/Brown	33	Customer Output Common 3	Gray/Black
15	Customer Output NO 4	Black/Gray	34	Customer Output Common 4	Blue/Yellow
16	Customer Output NC 4	Yellow/Blue			
17	Customer Input 10	Yellow/Orange	35	Input 10 Gnd	Orange/Yellow
18	Customer Input 11	Yellow/Green	36	Input 11 Gnd	Green/Yellow
19	Customer Input 12	Yellow/Brown	37	Input 12 Gnd	Brown/Yellow

Table 2-13 Customer alarm cable (X) pinout for customer IP 13-24 OP 5-8

37-Pin D-Sub Pin number	Signal Description	Wire Color	37-Pin D-Sub Pin number	Signal Description	Wire Color
1	Customer Input 13	White/Blue	20	Input 13 Gnd	Blue/White
2	Customer Input 14	White/Orange	21	Input 14 Gnd	Orange/White
3	Customer Input 15	White/Green	22	Input 15 Gnd	Green/White
4	Customer Input 16	White/Brown	23	Input 16 Gnd	Brown/White
5	Customer Input 17	White/Gray	24	Input 17 Gnd	Gray/White
6	Customer Input 18	Red/Blue	25	Input 18 Gnd	Blue/Red
7	Customer Input 19	Red/Orange	26	Input 19 Gnd	Orange/Red
8	Customer Input 20	Red/Green	27	Input 20 Gnd	Green/Red
9	Customer Input 21	Red/Brown	28	Input 21 Gnd	Brown/Red

Continued

Table 2-13 Customer alarm cable (X) pinout for customer IP 13-24 OP 5-8 (Continued)

37-Pin D-Sub Pin number	Signal Description	Wire Color	37-Pin D-Sub Pin number	Signal Description	Wire Color
10	Not Connected		29	Customer Output NC 5	Blue/Black
11	Customer Output NO 5	Black/Blue	30	Customer Output Common 5	Orange/Black
12	Customer Output NO 6	Black/Orange	31	Customer Output Common 6	Green/Black
13	Customer Output NC 6	Black/Green	32	Customer Output NC 7	Brown/Black
14	Customer Output NO 7	Black/Brown	33	Customer Output Common 7	Gray/Black
15	Customer Output NO 8	Black/Gray	34	Customer Output Common 8	Blue/Yellow
16	Customer Output NC 8	Yellow/Blue			
17	Customer Input 22	Yellow/Orange	35	Input 22 Gnd	Orange/Yellow
18	Customer Input 23	Yellow/Green	36	Input 23 Gnd	Green/Yellow
19	Customer Input 24	Yellow/Brown	37	Input 24 Gnd	Brown/Yellow

Procedure



Perform Tasks 10-13 as given in [Procedure 2-7](#).

Procedure 2-7 Procedure for Tasks 10-13

1	Connect the 15-pin D-connector end of cable (AA) to the RGPS connector on the front of the SSI. Refer to Figure 2-3 for the connector location on the SSI.
2	Route the loose end of cable (AA) to the RGPS lightning arrester and connect the wires there. Refer to Figure 2-6 through Figure 2-11 , Table 2-9 and Table 2-10 .
3	For T1/E1 balanced span line connections, go to step 4 . For E1 unbalanced span line connections, go to step 7 .

Continued

Procedure 2-7 Procedure for Tasks 10-13 (Continued)

4	Connect the 37-pin D-connector end of cable (W) to the SPAN connector on the front of the SSI. Refer to Figure 2-3 for the connector location on the SSI.
5	<p>Route the loose end of cable (W) to the customer span line interconnect equipment and connect the wires. Refer to Table 2-11.</p> <div data-bbox="483 449 842 559">  <div data-bbox="608 476 842 523" style="background-color: #00FFFF; padding: 5px; display: inline-block;">NOTE</div> </div> <p>The UBS Macro BTS currently supports only up to 4 spans.</p>
6	Go to step 9 .
7	Connect E1 unbalanced Span I/O coaxial cables (customer supplied) to the corresponding BNC connector on the SSI E1 daughter card. Refer to Figure 2-3 for the BNC connector locations on the SSI. Also, refer to Table 2-11 for correlation between spans and the E1 unbalanced span I/O coaxial BNC connectors.
8	<p>Route the other ends of the span I/O coaxial cables to the customer span line interconnect equipment and connect the cables.</p> <div data-bbox="483 910 842 1021">  <div data-bbox="608 938 842 985" style="background-color: #00FFFF; padding: 5px; display: inline-block;">NOTE</div> </div> <p>The UBS Macro BTS currently only supports up to 4 spans.</p>
9	Connect the 37-pin D-connector of the Customer Alarm Input/Output (IP/OP) cables (X) to the corresponding CUSTOMER IP 1-12 OP 1-4 connector and CUSTOMER IP 13-24 OP 5-8 connector on the front of the SSI.
10	Route the loose end of cable (X) to the Customer IP/OP interconnect equipment and connect the wires. Refer to Figure 2-3 for the CUSTOMER IP/OP connector locations on the SSI. Also, refer to Table 2-12 and Table 2-13 .

Task 14: Connecting +27 V DC Power

Objective

Task 14 is performed for +27 V DC UBS Macro BTS only.

The objective of this procedure is to perform Task 14, which includes:

- Attaching the contact/lugs, connector and cable clamp on the +27 V DC power input cable wires.
- Connecting the +27 V DC input power cable to the rear of the PDU.
- Routing the loose ends of the wires to the site +27 V DC source for connection.

Frame power cables and connector information

The wire gauge (that is, diameter) depends on the required length of the DC power cable (DC). Refer to [Table 2-8](#) for the correct wire size.

The DC connector contact/lug size depends on the wire gauge used for the DC power cable (DC). Refer to [Table 2-14](#) for DC connector contact/lug part information.

In order to minimize current imbalance between the feed (+V) and return (-V) wires used in the cable:

- Ensure that the wire size, length and gage, of each wire used in the cable are the same.
- Ensure that contacts/lugs used in the connector are identical and match the gauge of the wire.



NOTE

Motorola recommends using 2/0 AWG cables for short cable runs; less than 661.11 cm (21.69 ft).

Table 2-14 +27 V DC connector (Orange) parts information

Item Description	Part Number	Qty
Orange DC connector housing	Anderson Power Products Mfr Part# 932, or Allied Electronics Stk# 803-0097	1 per +27 V DC power feed

Continued

Table 2-14 +27 V DC connector (Orange) parts information (Continued)

Item Description	Part Number	Qty
AWG 2/0 connector contact/lug	Anderson Power Products Mfr Part# 907, or Allied Electronics Stk# 803-0500	2 per DC connector housing
AWG 3/0 connector contact/lug	Anderson Power Products Mfr Part# 916, or Allied Electronics Stk# 803-0502	2 per DC connector housing
AWG 4/0 connector contact/lug	Anderson Power Products Mfr Part# 908, or Allied Electronics Stk# 803-0504	2 per DC connector housing
Cable clamp for two single conductors with hardware	Anderson Power Products Mfr Part# 996G1	1 per +27 V DC power feed

Required items

The following items are required:

- One +27 V DC Power Input Cable (DC) - customer supplied. The wire size, length and gauge, used for cable (DC) depends on site characteristics (see [Table 2-8](#)).



NOTE

Motorola recommends the use of Red wire for feed (+V) and Black wire for return (-V).

- Two contacts/lugs – customer supplied. Contact/lug fastens to wire end and is inserted into DC connector housing. For contact/lug part number (refer to [Table 2-14](#)). Contact/lug size must match the gauge of the wire being used.
- One DC connector housing – customer supplied. Use Anderson SB350 connector housing (Orange color) or equivalent.
- DC connector cable clamps for power cable (see [Table 2-14](#) or [Table 2-15](#) for part information).
- Crimper tool - Anderson Power Products part number 1368 - Hydraulic hand tool, maximum cable size of 300 MCM
- Wire stripper/cutters.
- Digital Multi-Meter (DMM) Fluke Model 8062A with Y8134 test lead kit or equivalent; used for precision DC and AC measurements, requiring 4-1/2 digits.

Power cabling and tie down requirements

To control the inductance at the BTS DC power input due to the spacing between wires used in the +27 V DC Power Input Cable (DC), the feed (+V) and return (-V) wires must be bound together at intervals of 1 meter or less. Refer to [Figure 2-22](#).

Figure 2-22 +27 V DC power input cable (DC) wire tie-wrap example

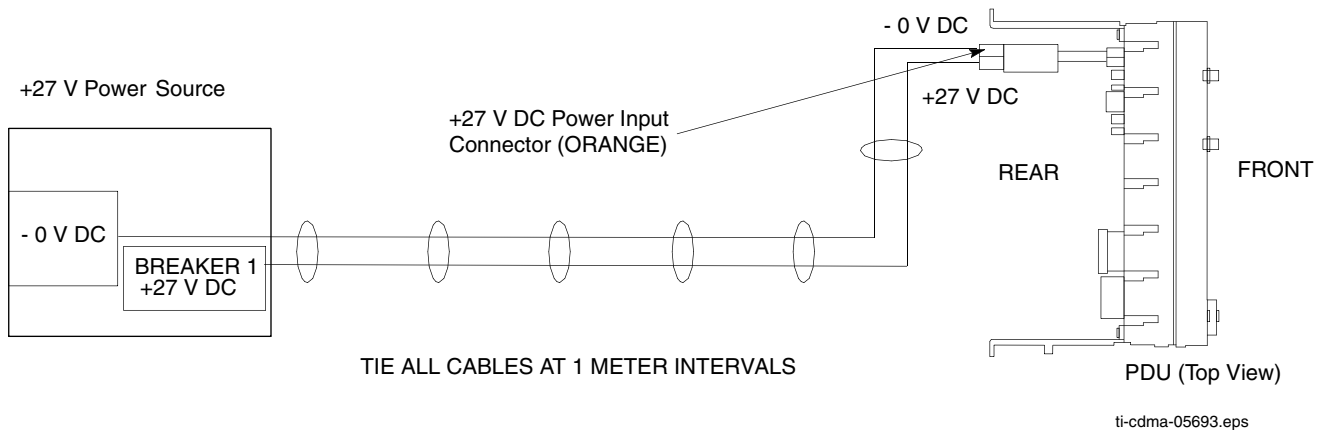

Contact/lug, DC connector housing and PDU input power

[Figure 2-23](#) shows the lugs and DC connector housing. This figure also shows the location at which the +27 V DC Input Power Cable (DC) connects to the rear of the PDU.

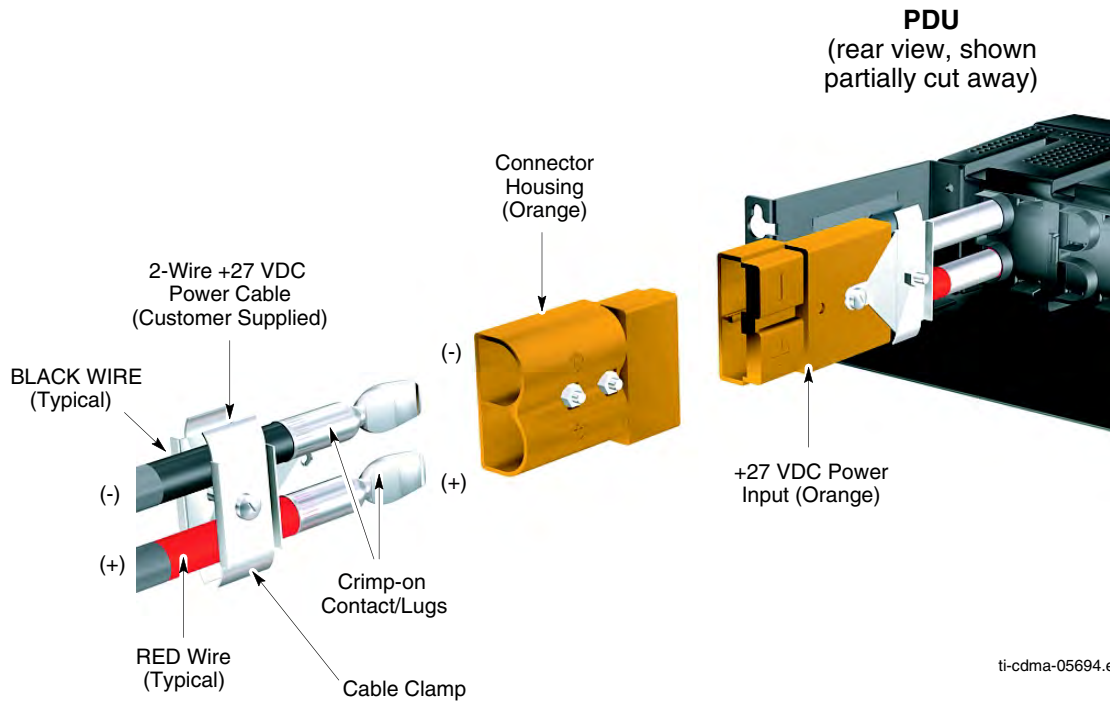
Figure 2-23 +27 V DC power input cable (DC) connector and connection to PDU

Procedure

Perform the Task 14 as given in [Procedure 2-8](#).



WARNING

- Do not wear a wrist strap when servicing the power supplies or power distribution cabling.
- Ensure that the source for the DC power is in the OFF position.
- Ensure that all of the PDU circuit breakers are OFF.

Procedure 2-8 Procedure for Task 14

- 1 Ensure that the BTS ground cable (DD) is connected between the rack and the Master Ground Bar (refer to Task 3).

Continued

Procedure 2-8 Procedure for Task 14 (Continued)

2	Ensure that the +27 V DC Power Input Cable (DC) is NOT connected to the main +27 V DC power source. Turn OFF the main +27 V DC power source.
3	Remove the components from the DC connector package.
4	Strip 35 mm of insulation from the negative (-V) and positive (+V) wires of the power cable.
5	Place a DC contact/lug on the negative (-V) and positive (+V) wires of the power cable. Refer to Figure 2-23 .
6	Using the appropriate crimping tool, crimp the DC contact/lug on to the wires.
7	Observe the negative (-V) and positive (+V) wire polarities and insert the DC contacts/lugs into the DC connector housing until an audible click is heard. Refer to Figure 2-23 .
8	Verify the positive (+V) wire is installed in the positive position and the negative (-V) wire is installed in the negative (-) position on the connector housing.
9	Ensure that the wires are firmly fastened to the DC connector housing.
10	Tie the positive (+V) and negative (-V) wires of the cable together as shown in Figure 2-22 .
11	Route the loose end of the +27 V DC Power Input Cable (DC) to the site +27 V DC source and connect the wires to the source.
12	Verify that proper polarity is maintained from the +27 V DC power source to the UBS Macro BTS.
13	Use a Digital Multi-Meter (DMM) to measure the voltage of the DC connector housing that was installed in step 7 . Perform the following: <ul style="list-style-type: none"> ● Set the DMM to measure 27 V DC. ● Connect the DMM negative (GND/common) lead to the (-) terminal of the cable connector. ● Connect the DMM positive lead to the (+) terminal of the cable connector.
14	Turn on the main +27 V DC power source.
15	Observe the DMM and verify that the voltage is nominally +27 V (range = +26 to +28 V).
16	Turn off the main +27 V DC power source.
17	Disconnect the DMM from the cable connector.
18	Connect +27 V DC Power Input Cable (DC) connector to the +27 V DC input power cable on the rear of the PDU; Orange connectors mate. Refer to Figure 2-23 .

Task 15: Connecting -48 V DC Power

Objective

Task 15 is performed for -48 V DC UBS Macro BTS only.

The objective of this procedure is to perform Task 15, which includes:

- Attaching the contact/lugs and connector on the -48 V DC power input cable wires.
- Connecting the -48 V DC input power cable to the rear of the -48 V DC PSM shelf.
- Routing the loose ends of the wires to the site -48 V DC source for connection to the source.



NOTE

Verify that the +27 V DC output power cable from the PSM shelf is already connected to the PDU +27 V DC input power cable. This was performed during Tasks 4-7.

Frame power cables and connector information

The wire gauge (that is, diameter) depends on the required length of the DC power cable (CC). Refer to [Table 2-8](#) for the correct wire size.

The DC connector contact/lug size depends on the wire gauge used for the DC power cable (CC). Refer to [Table 2-15](#) for DC connector contact/lug part information.

In order to minimize current imbalance between the feed (-V) and return (+V) wires used in the cable:

- Ensure that the wire size, length and gauge, of each wire used in the cable are the same.
- Ensure that contacts/lugs used in the connector are identical and match the gauge of the wire.



NOTE

Motorola recommends using 2/0 AWG cables for short cable runs; less than 661.11 cm (21.69 ft).

Table 2-15 -48 V DC connector (Blue) parts information

Item Description	Part Number	Qty
Blue DC connector housing	Anderson Power Products Mfr Part# 912, or Allied Electronics Stk# 803-0492	1 per -48 V DC power feed
AWG 2/0 connector contact/lug	Anderson Power Products Mfr Part# 907, or Allied Electronics Stk# 803-0500	2 per DC connector housing
AWG 3/0 connector contact/lug	Anderson Power Products Mfr Part# 916, or Allied Electronics Stk# 803-0502	2 per DC connector housing
AWG 4/0 connector contact/lug	Anderson Power Products Mfr Part# 908, or Allied Electronics Stk# 803-0504	2 per DC connector housing
Cable clamp for two single conductors with hardware	Anderson Power Products Mfr Part# 996G1	1 per -48 V DC power feed

Required items

The following items are required:

- One -48 V DC Power Input Cable (CC) - customer supplied. The wire size, length and gauge, used for cable (CC) depends on site characteristics (see [Table 2-8](#)).



NOTE

Motorola recommends the use of blue wire for feed (-V) and black wire for return (+V).

- Two Contacts/Lugs – customer supplied. Contact/lug fastens to wire end and is inserted into DC connector housing. For contact/lug part number (refer to [Table 2-15](#)). Contact/lug size must match the gauge of the wire being used.
- One DC Connector Housing – supplied with UBS BTS. Use Anderson SB350 connector housing (blue color) or equivalent.
- Crimper tool - Anderson Power Products part number 1368 - Hydraulic hand tool, maximum cable size of 300 MCM
- Wire stripper/cutters.
- Digital Multi-Meter (DMM) Fluke Model 8062A with Y8134 test lead kit or equivalent; used for precision DC and AC measurements, requiring 4-1/2 digits.

Power cabling and tie down requirements

To control the inductance at the BTS DC power input due to the spacing between wires used in the -48 V DC Power Input Cable (CC), the feed (-V) and return (+V) wires must be bound together at intervals of 1 meter or less. Refer to [Figure 2-24](#).

Figure 2-24 48 V DC power input cable (CC) wire tie-wrap example

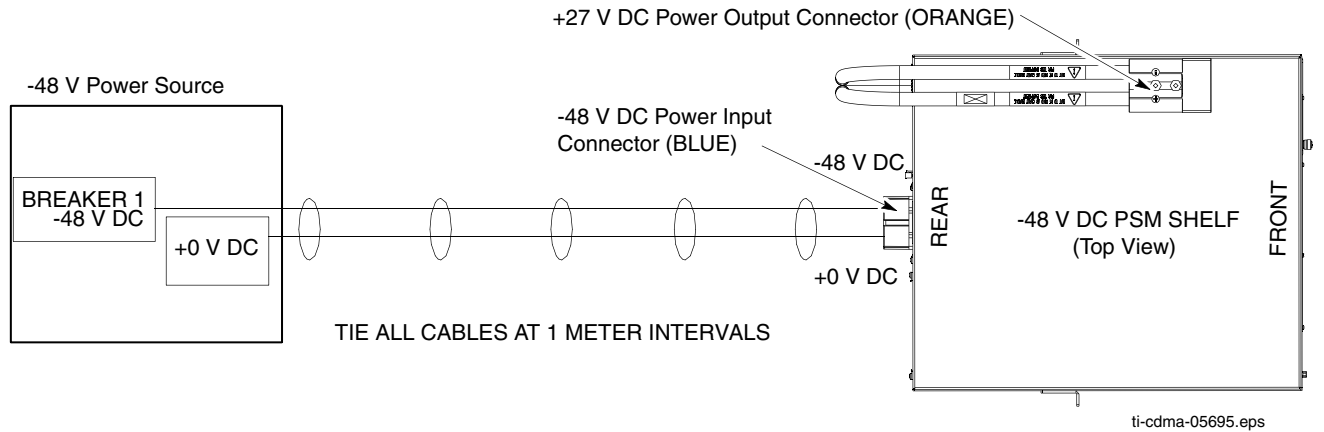

Contact/lug, DC connector housing and PDU input power

[Figure 2-25](#) shows the lugs and DC connector housing. This figure also shows the location at which the -48 V DC Input Power Cable (CC) connects to the rear of the PDU.

Figure 2-25 48 V DC power input cable (CC) connector and connection to PSM shelf

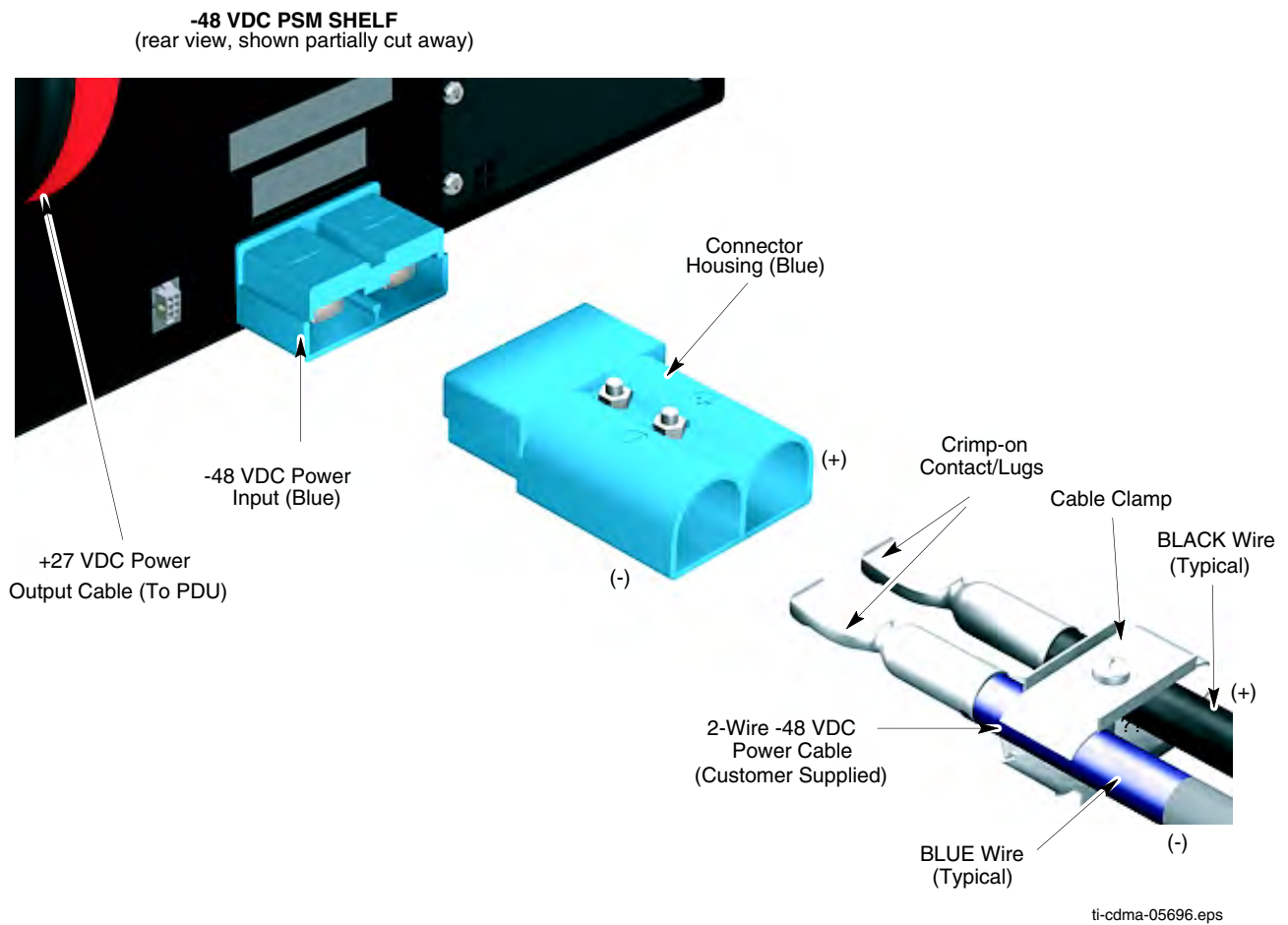

Procedure

Performing Task 15 as given in [Procedure 2-9](#).



WARNING

- Do not wear a wrist strap when servicing the power supplies or power distribution cabling.
- Ensure that the source for the DC power is in the OFF position.
- Ensure that all of the PDU circuit breakers are OFF.

Procedure 2-9 Procedure for Task 15

1	Ensure that the BTS ground cable (DD) is connected between the rack and the Master Ground Bar (refer to Task 3).
2	Ensure that the -48 V DC Power Input Cable (CC) is NOT connected to the main -48 V DC power source. Turn OFF the main -48 V DC power source.
3	Remove the components from the DC connector package.
4	Strip 35 mm of insulation from the negative (-V) and positive (+V) wires of the power cable.
5	Place a DC contact/lug on the negative (-V) and positive (+V) wires of the power cable. Refer to Figure 2-25 .
6	Using the appropriate crimping tool, crimp the DC contact/lug on to the wires.
7	Observe the negative (-V) and positive (+V) wire polarities and insert the DC contacts/lugs into the DC connector housing until a click sound is heard. Refer to Figure 2-25 .
8	Verify the positive (+V) wire is installed in the positive position and the negative (-V) wire is installed in the negative (-) position on the connector housing.
9	Ensure that the wires are firmly fastened to the DC connector housing.
10	Tie the positive (+V) and negative (-V) wires of the cable together as shown in Figure 2-24 .
11	Route the loose end of the -48 V DC Power Input Cable (CC) to the site -48 V DC source and connect the wires to the source.
12	Verify that proper polarity is maintained from the -48 V DC power source to the UBS Macro BTS.
13	Use a Digital Multi-Meter (DMM) to measure the voltage of the DC connector housing that was installed in step 7 . Perform the following: <ul style="list-style-type: none"> ● Set the DMM to measure 48 V DC. ● Connect the DMM negative (GND/common) lead to the (-) terminal of the cable connector. ● Connect the DMM positive lead to the (+) terminal of the cable connector.
14	Turn on the main -48 V DC power source.
15	Observe the DMM and verify that the voltage is nominally +48 V (range = +40 to +60 V).
16	Turn off the main -48 V DC power source.
17	Disconnect the DMM from the cable connector.
18	Connect -48 V DC Power Input Cable (CC) connector to the -48 V DC input power connector on the rear of the PSM shelf; blue connectors mate. Refer to Figure 2-25 .

Task 16: Connecting 220 V AC Power

Objective

Task 16 is performed for 220 V AC UBS Macro BTS only.

The objective of this procedure is to perform Task 16, which includes:

- Attaching customer supplied wiring and conduit for 220 V AC lines.
- Connecting wires and required insertion bridges to the AC INPUT terminal block on the rear of the AC PSM shelf.
- Routing the loose ends of the wires to the site 220 V AC source for connection to the source.



NOTE

Verify that the +27 V DC output power cable from the PSM shelf is already connected to the PDU +27 V DC input power cable. This was performed during Tasks 4-7.

Frame AC power cables and wiring information

The AC PSM shelf and AC PSMs can operate with the following AC power inputs:

- Input AC Voltage Range: 154 V AC to 300 V AC
- Single-Phase
- 3-Phase STAR
- 3-Phase DELTA

Consider the following AC power input circuit characteristics:

- The AC PSM shelf terminal block has seven terminals; one for Ground plus six for AC line wires and insertion bridges.
- The AC PSM shelf terminal block Ground terminal can accommodate a wire size range of 2 AWG to 10 AWG.
- The AC PSM shelf terminal block AC line terminals can accommodate a wire size range of 2 AWG to 10 AWG.

- Input AC cable sizing should be determined by Local Electrical Codes, using 90 C minimum rated conductors, and de-rating for 50 C operation.
- The customer must provide a disconnect device and an over current protection device for the AC circuit supplying the UBS Macro BTS. A circuit breaker size of 30 Amperes is recommended, or as appropriate set by Local Electrical Code.

Required items

The following items are required:

- Conduit - customer supplied
- Wire for Ground and AC lines - customer supplied
- Insertion bridges – supplied with AC PSM shelf; two 3-position bridges and three 2-position bridges
- T20 TORX bit with 12-inch extension
- Flat blade screwdriver
- Wire stripper/cutters

AC PSM shelf AC power input detail

Figure 2-26 shows the location of the AC PSM shelf AC power input terminals and wiring details for:

- Single-Phase
- 3-Phase STAR
- 3-Phase DELTA

Figure 2-26 AC PSM shelf AC power input terminal block and wiring details

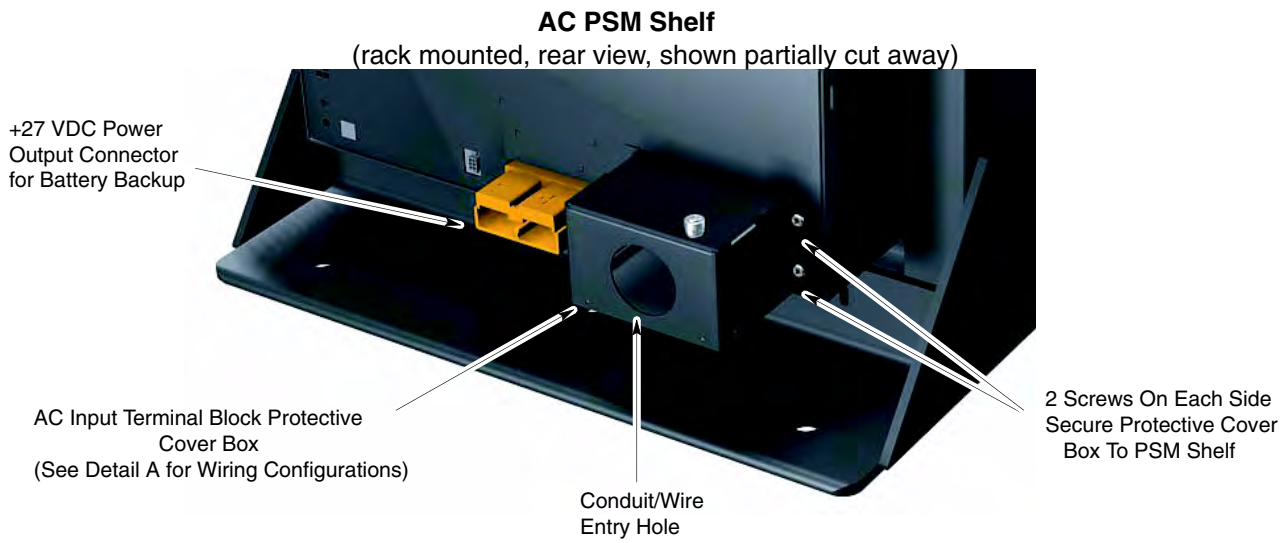

Detail A - AC Input Terminal Wiring Configurations (protective cover box removed)

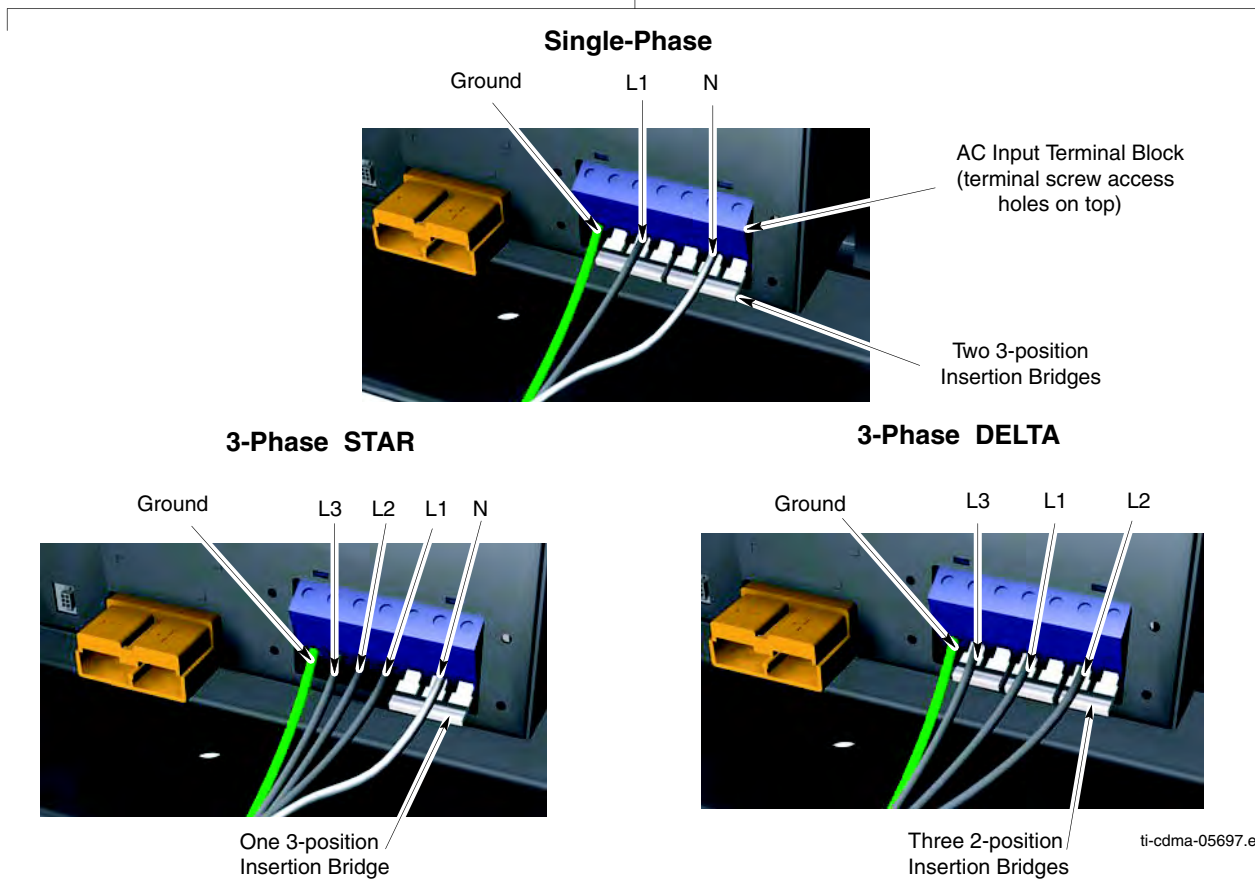

Procedure

Perform Task 16 as given in [Procedure 2-10](#).



WARNING

- Do not wear a wrist strap while servicing the power supplies or power distribution cabling.
- Ensure that the source for the AC power is in the OFF position.
- Ensure that all of the PDU circuit breakers are OFF.

Procedure 2-10 Procedure for Task 16

1	Set the source for the AC voltage to the OFF position.
2	Ensure that the BTS ground cable (DD) is connected between the rack and the Master Ground Bar (refer to Task 3).
3	On the rear of the PSM shelf, locate the AC input terminal block cover box. Using a TORX T20 bit and driver, remove the 4 screws securing the cover box to the PSM shelf (refer to Figure 2-26).
4	Remove the cover box from the PSM shelf to expose the AC input terminal block.
5	Attach conduit to the cover box.
6	Route the AC wires and the earth ground wire through the conduit and the cover box. Leave wires extending to reach the AC input terminal block.
7	Strip 25 mm of insulation from each of the AC supply line wires and the earth ground wire.
8	Locate the ground terminal on the AC input terminal block (refer to Figure 2-25).
9	Using a flat blade screwdriver, turn the ground terminal screw counter clockwise (CCW) until the terminal is fully open. Insert the earth ground wire into the ground terminal. Turn the ground terminal screw clockwise (CW) to close the terminal and secure the wire. Tighten the terminal screw to 4.0 - 4.5 N-m (35 - 40 in-lb).
10	Determine if the AC input terminal block already has insertion bridges properly installed for the desired AC supply configuration: <ul style="list-style-type: none"> • Single-Phase • 3-Phase STAR • 3-Phase DELTA Refer to Figure 2-26 as needed.

Continued

Procedure 2-10 Procedure for Task 16 (Continued)

11	<p>Open the six line terminals as follows:</p> <ul style="list-style-type: none"> • Insert a flat blade screwdriver into each screw hole on top of the terminal block. • Turn the terminal screw CCW until the terminal is fully open.. <div style="display: flex; align-items: center; margin-top: 10px;">  <div style="background-color: #00ffff; padding: 5px; text-align: center; font-weight: bold; color: white;">NOTE</div> </div> <p style="text-align: center; margin-top: 10px;">Failure to fully open the terminals can cause improper placement of the insertion bridges in later steps.</p>
12	Place an insertion bridge into the proper terminals. While holding the bridge with one hand, turn the corresponding terminal screws CW until the bridge is securely clamped.
13	Repeat step 12 for any remaining terminals requiring an insertion bridge.
14	<p>Connect the AC supply line wires to the proper terminals as follows:</p> <ul style="list-style-type: none"> • Insert a flat blade screwdriver into the appropriate screw hole on top of the terminal block. • Turn the terminal screw CCW until the terminal is fully open. • Insert the appropriate wire into the terminal. • While holding the wire with one hand, turn the corresponding terminal screw CW until the wire is securely clamped. Tighten the terminal screw to 4.0 - 4.5 N-m (35 - 40 in-lb). <p>Refer to Figure 2-26 as needed.</p>
15	Repeat step 14 for any unconnected AC supply line wires.
16	Visually inspect all insertion bridge(s) and wires for proper placement. All conductors must be inside the clamp of each terminal block.
17	Place the cover box, with conduit attached, in position over the AC input terminal block.
18	Insert the 4 screws to secure the cover box to the PSM shelf. Ensure that the wires are not pinched.
19	Using a TORX T20 bit and driver, tighten the 4 screws to 1.6 - 1.8 N-m (14 - 16 in-lb).
20	Complete the installation of the AC wiring at the AC Power source.

Low-to-Mid Capacity Frame Expansion Procedures



NOTE

The R20 UBS Macro BTS supports single band 800 MHz or 1.9 GHz RF band, up to two XMIs, up to two DMIs and one SSI. UBS Macro BTS frame configurations with up to four XMIs and up to five DMIs will be available in the future.

Low-to-Mid Capacity Frame Expansion Overview

This chapter provides information and procedures needed for expanding the low-capacity UBS Macro BTS starter/expansion frame to the mid-capacity frame configuration.

The mid-capacity frame consists of the low-capacity frame equipment plus the following additional expansion equipment:

- second XMI, required.
- second DMI, required.
- circuit breaker/output power connector assemblies; one required for each of the following: second XMI and second DMI.
- second set of IDRFs, required.
- optional RX splitter or RX share cable.
- second/third PSM, required for –48 V or 220 V AC only. Two PSMs are required for the mid capacity configuration and the third PSM is for redundancy.

Cabling of the RX splitter to the XMIs will be performed after all of the additional expansion equipment (i.e., XMI, DMI, SSI, circuit breaker/output power connector assemblies, etc.) is installed in the frame.

How to use this chapter

Typically the installer is directed to this chapter via [Task 6: Expanding the Low-capacity Frame on page 2-45 of Chapter 2 UBS Macro BTS Installation Procedure](#).

Perform all of the applicable procedures, in this chapter, for expanding the low-capacity UBS Macro BTS starter/expansion frame to the mid-capacity frame configuration.

After all of the additional expansion equipment is installed, go to [Task 7: Cabling the Optional PSM Shelf on page 2-46 of Chapter 2 UBS Macro BTS Installation Procedure](#), and continue performing the remaining tasks in sequential order.

Adding Circuit Breakers/Connectors to PDU

Objective

The objective of this section is to install additional circuit breaker/output power connector assemblies in the PDU. These additional circuit breaker/output power connector assemblies are required to allow the PDU to provide DC power to the expansion equipment being added to the UBS Macro BTS frame.

The circuit breaker/output power connector assemblies are located on the PDU front panel.

Each circuit breaker/output power connector assembly is arranged so that the circuit breaker is just below the corresponding DC output power connector.

The PDU can be equipped with the following circuit breaker/output power connector assemblies:

- up to four 90A for XMI 1 – XMI 4
- up to five 20A for DMI 1 – DMI 5
- up to two 20A for SSI 1 – SSI 2
- up to two 10A for accessory groups ACC 1 – ACC 2

The PDU in the UBS Macro BTS low-capacity starter/expansion frame is already equipped with the following circuit breaker/output power connector assemblies:

- one 90A for XMI 1
- two 20A for DMI 1 – DMI 2
- one 20A for SSI 1
- zero 10A for no accessories

The type and quantity of circuit breaker/output power connector assemblies required depends on which circuit breaker/output power connector assemblies are not already equipped in the PDU, but are needed to support the additional expansion equipment.

Required items

The following items are required:

- Appropriate type and quantity of circuit breaker/output power connector assemblies to be added for expansion purposes
 - c 90A circuit breaker/output power connector assembly (Motorola model STLN4093)
 - c 20A circuit breaker/output power connector assembly (Motorola model STLN6472)



NOTE

Mounting screws are provided with each circuit breaker/output power connector assembly; four screws with the 90A assembly and two screws with the 20A assembly.

- Side cutters; diagonal pliers or wire cutter
- Small knife
- TORX T25 bit and driver
- Torque driver

Procedure

[Procedure 3-1](#) contains the steps for adding a circuit breaker/output power connector assembly to the PDU.

Procedure 3-1 Adding a Circuit Breaker/Output Power Connector Assembly to the PDU





CAUTION

Make sure DC input power is not applied to the PDU before performing [Procedure 3-1](#).

1	Set all PDU front panel circuit breakers to the off (pulled out) position.
2	Disconnect all DC power cables from the PDU front panel. Dress these cables away from the PDU front panel.
3	Remove the PDU front panel as follows: <ul style="list-style-type: none"> • See Figure 3-1 Adding a Breaker Assembly Module to the PDU on page 3-6 photograph A. • While depressing the retaining tab on the left and right front ends of the PDU, slide the PDU front panel forward and off of the PDU.
4	Install the additional circuit breaker/output power connector assemblies in the required locations on the PDU front panel DC output power bus (see Figure 3-1 Adding a Breaker Assembly Module to the PDU on page 3-6 photograph B).

Continued

Procedure 3-1 Adding a Circuit Breaker/Output Power Connector Assembly to the PDU (Continued)

5	<p>Position the circuit breaker/output power connector assembly as follows:</p> <ul style="list-style-type: none"> • Circuit breaker actuator at the bottom and the DC output power connector at the top • Circuit breaker actuator facing toward the front of the frame • Align mounting screw holes of the circuit breaker/output power connector assembly with the corresponding screw holes on the PDU front panel DC output power bus.
6	<p>Insert the supplied mounting screws into the screw holes.</p> <div style="display: flex; align-items: center; margin-top: 10px;">  <div style="background-color: #00b050; color: white; padding: 5px 10px; font-weight: bold; text-align: center;">NOTE</div> </div> <p style="margin-top: 10px;">Two screws on top and bottom for the 90A assembly. One screw on top and bottom for the 20A assembly.</p> <p>Using a TORX T25 driver, tighten the mounting screws to 4.8 N-m (42.25 in-lb) $\pm 10\%$.</p>
7	<p>Using side cutters, cut out the applicable circuit breaker actuator and the corresponding connector covers on the PDU front panel (see Figure 3-1 Adding a Breaker Assembly Module to the PDU on page 3-6 photograph C).</p> <div style="display: flex; align-items: center; margin-top: 10px;">  <div style="background-color: #00b050; color: white; padding: 5px 10px; font-weight: bold; text-align: center;">NOTE</div> </div> <p style="margin-top: 10px;">It may be necessary to use a small knife to remove any of the tabs that do not cut cleanly.</p>
8	<p>Reattach the PDU front panel to the PDU as follows:</p> <ul style="list-style-type: none"> • See Figure 3-1 Adding a Breaker Assembly Module to the PDU on page 3-6 photograph D. • Align the PDU front panel with the PDU circuit breaker actuators and power connectors while inserting the PDU front panel retaining tabs into the retainer on the left and right front ends of the PDU. • Slide the PDU front panel onto the front of the PDU. • Firmly press on the ends of the PDU front panel until each end tab snaps into place.
9	<p>Set all PDU front panel circuit breakers to the off (pulled out) position.</p>
10	<p>Reconnect all DC power cables that were disconnected in step 2 of this procedure. Make sure that each cable is connected to the proper PDU front panel power connector.</p>

Procedural reference diagram

The following diagram helps clarify certain steps in [Procedure 3-1](#) .

Figure 3-1 Adding a Breaker Assembly Module to the PDU

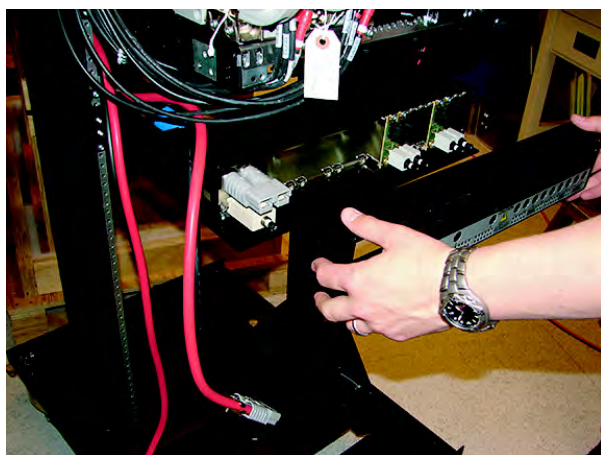

A

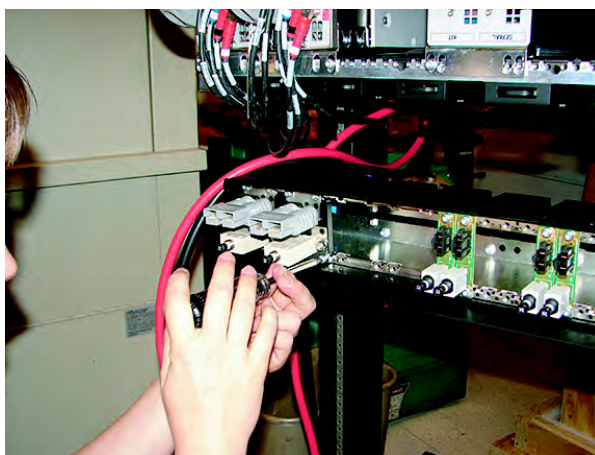

B

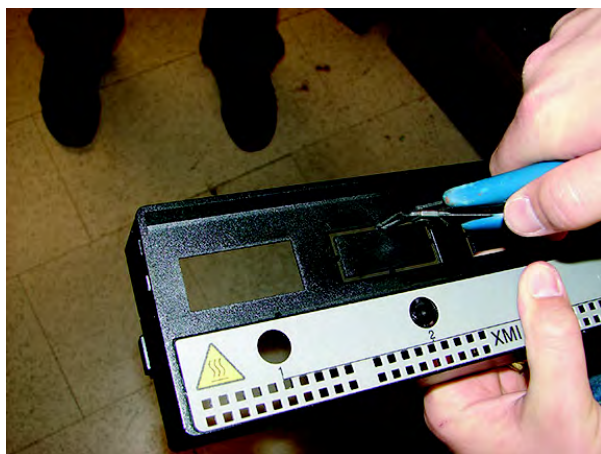

C

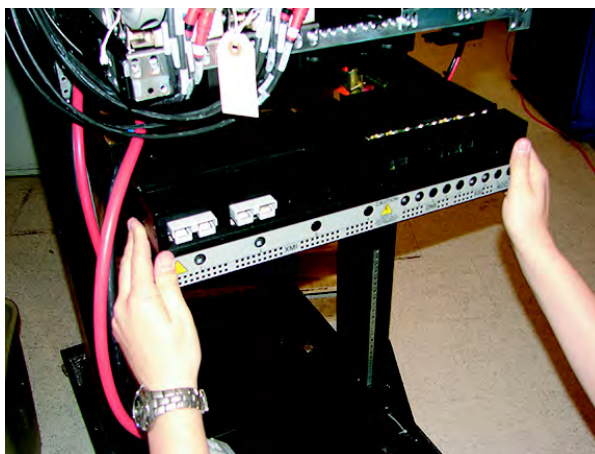

D

ti-cdma-06031.eps

Adding an XMI

Objective

The objective of this section is to mount an additional XMI into the XMI shelf.



NOTE

Cabling of the additional XMI will be performed after all of the additional expansion equipment (i.e., IDRFs, DMI, circuit breaker/output power connector assemblies, etc.) that connects to the additional XMI is installed in the frame.

Required items

Parts

The following applicable additional XMI is required:

- 800 MHz XMI assembly with removable XMI handle attached (Motorola model SGTf4194).
- 1.9 GHz XMI assembly with removable XMI handle attached (Motorola model STWG4000).

Manpower



CAUTION

The XMI module is heavy. Two people are required to lift, carry, or handle the XMI module.



NOTE

The XMI weighs 23-28 kg (50.7-61.7 lb) depending on the RF band.

Tools



The following tools are required:

- TORX T25 bit and driver
- Torque driver

Procedure

Procedure 3-2 contains the steps for adding a 2nd XMI to the XMI shelf.

Procedure 3-2 Adding a 2nd XMI to the XMI Shelf

	 <div data-bbox="571 815 807 863" style="background-color: yellow; border: 1px solid black; padding: 2px; display: inline-block;">CAUTION</div> <p>The XMI module is heavy. Two people are required to lift, carry, or handle the XMI module.</p> <ul style="list-style-type: none"> • Be sure the removable XMI handle is attached to the front of the XMI before physically handling the module. • Be sure two people use both hands and wear protective footwear when handling the XMI. • Be sure to use two people to support the module while sliding the module out of or into the shelf slot.  <div data-bbox="571 1257 807 1306" style="background-color: yellow; border: 1px solid black; padding: 2px; display: inline-block;">CAUTION</div> <p>An XMI module that is not in a shelf should always be set on its side and never on its edge. This will prevent the XMI module from tipping over and causing damage or injury.</p>
1	Remove the XMI from its packaging and inspect it for damage.
2	 <div data-bbox="571 1549 807 1598" style="background-color: cyan; border: 1px solid black; padding: 2px; display: inline-block;">NOTE</div> <p>XMI 2 mounts in the XMI shelf slot just to the right of XMI 1. XMI 3 mounts in the XMI shelf slot just to the right of XMI 2. XMI 4 mounts in the XMI shelf slot just to the right of XMI 3.</p> <p>This step requires two people. Perform the following:</p>

Continued

Procedure 3-2 Adding a 2nd XMI to the XMI Shelf (Continued)

	<ul style="list-style-type: none">• One person grasp the XMI by the handle with both hands. The second person grasp the XMI fan tray sides with both hands. Using safe lifting technique (i.e. lift with your legs not your back), pick up the XMI and carry it over to the front of the frame.• While one person holds the XMI by the handle with both hands, the second person supports the bottom of the module with one hand and the top of the module with the other hand. Lift the XMI into the appropriate XMI shelf slot rails and gently slide it all of the way into the shelf slot.
3	Insert the four XMI mounting screws; two screws at each of the top and bottom mounting tabs on the front of the module. Using a T25 TORX driver, tighten the screws to 4.8 N-m (42.25 in-lb) $\pm 10\%$.

Procedural reference diagram

The following diagram helps clarify certain steps in [Procedure 3-2](#).

Figure 3-2 Installing a 2nd XMI



ti-cdma-06032.eps

Adding a DMI

Objective

The objective of this section is to mount an additional DMI into the XMI shelf.



NOTE

Cabling of the additional DMI will be performed after all of the additional expansion equipment (i.e., XMI, circuit breaker/output power connector assemblies, etc.) that connects to the additional DMI is installed in the frame.

Required items

Parts

The additional DMI is application dependent. Use one of the following factory built DMI assemblies as applicable:



NOTE

All models of DMI assemblies include: DMI chassis with controller board, fans and front panel.

- DMI assembly with one 1X CDMA modem board (Motorola model STLN6681).
- DMI assembly with one EV-DO modem board (Motorola model STLN6682).
- DMI assembly with two 1X CDMA modem boards (Motorola model STLN6683).
- DMI assembly with one 1X CDMA modem board and one EV-DO modem board (Motorola model STLN6684).
- DMI assembly with two EV-DO modem boards (Motorola model STLN6679).

Tools

The following tools are required:

- TORX T25 bit and driver
- Torque driver
- ESD wrist strap

Prerequisite



CAUTION

ESD handling precautions **must be** adhered to when handling the DMI assembly. Wear a conductive, high impedance wrist strap during handling.

The procedures in this chapter requires working on or around circuitry that is extremely sensitive to ESD.

Procedure

[Procedure 3-3](#) contains the steps for adding a 2nd DMI to the XMI shelf.

Procedure 3-3 Adding a 2nd DMI to the XMI Shelf

1	Set the additional DMI assembly, in its packaging, near the UBS Macro BTS frame.
2	 <div style="border: 1px solid black; padding: 2px; display: inline-block; margin-left: 10px;">CAUTION</div> <p>ESD handling precautions must be adhered to during this procedure. Wear a conductive, high impedance wrist strap.</p> <p>Plug the end of the ESD wrist strap into the UBS Macro BTS frame ESD jack. This jack is located in the middle of the upper XMI shelf bracket. Attach the wrist strap to your wrist.</p>
3	Remove the additional DMI from its packaging and inspect it for damage.
4	<p>Install the DMI assembly into the appropriate empty DMI housing in the UBS Macro BTS frame by performing the following:</p> <ol style="list-style-type: none"> 1. Position the DMI assembly on its bottom edge so that the front panel handle is on the right and the retaining fastener is at the top.

Continued

Procedure 3-3 Adding a 2nd DMI to the XMI Shelf (Continued)

2. Pick up the DMI assembly with two hands.
 3. Insert the rear of the DMI assembly into the empty housing.
 4. Slide the DMI assembly completely into the housing (see [Figure 3-3 Installing a 2nd DMI on page 3-13](#)).
 5. Turn the retaining fastener CW (Clockwise) until finger tight to secure the DMI assembly in the housing.
-

Procedural reference diagram

The following diagram helps clarify certain steps in [Procedure 3-3](#).

Figure 3-3 Installing a 2nd DMI

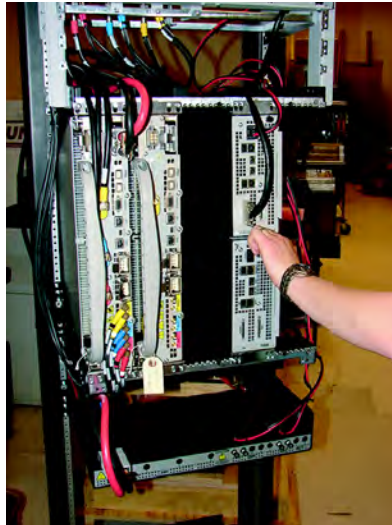

ti-cdma-06033.eps

Adding a Second Set of IDRFs

Objective

The objective of this section is to mount a second set of IDRFs into the IDRF shelf.



NOTE

Cabling of the second set of IDRFs to the second XMI will be performed after all of the additional expansion equipment (i.e., XMI, DMI, circuit breaker/output power connector assemblies, etc.) is installed in the frame.

The second set of IDRFs consists of:

- one IDRF for an omni antenna configuration.
- three IDRFs, one per sector, for a 3-sector antenna configuration.

The second set of IDRFs mounts in the right-half of the IDRF shelf. The second set of IDRFs are designated as sector 1, 2 and 3 from left to right.

Required items

Parts

The proper quantity, for omni or 3-sector antenna configuration, of the following applicable IDRF is required:

- China Full Band 800 MHz IDRF (Motorola model STF4009)
- India Full Band 800 MHz IDRF (Motorola model STF4010)
- US Full Band 800 MHz IDRF (Motorola model STF4015)
- US A-band 800 MHz IDRF (Motorola model STF4016)
- US B-band 800 MHz IDRF (Motorola model STF4017)
- 1.9 GHz IDRF (Motorola model STFG4055)

Tools

The following tools are required:

- TORX T25 bit and driver
- Torque driver

Procedure

[Procedure 3-4](#) contains the steps for adding a second set of IDRFs to the IDRF shelf.

Procedure 3-4 Adding a second set of IDRFs to the IDRF shelf

1	Remove the additional IDRFs from their packaging and inspect them for damage.
2	<p>While working at the front/top of the UBS Macro BTS frame, pick up an additional IDRF and mount it into the IDRF shelf as follows:</p> <ul style="list-style-type: none"> • Position the IDRF with the IDRF mounting plate on top/facing upward and the mounting plate flange is on the right side (see Figure 3-4 Installing the second set of IDRFs on page 3-16 photograph B). • Insert the first IDRF into the sector 1 position on the right half of the top of the IDRF shelf (see photograph A). • Slide the IDRF down into the IDRF shelf.
3	Repeat step 2 for the remaining IDRFs, but insert them in sector 2 and sector 3 positions.
4	Insert four mounting screws through each IDRF mounting plate and into the IDRF shelf. Using a T25 TORX driver, tighten the mounting screws for all of the additional IDRFs to 4.8 N-m (42.25 in-lb) $\pm 10\%$.

Procedural reference diagram

The following diagram helps clarify certain steps in [Procedure 3-4](#).

Figure 3-4 Installing the second set of IDRFs

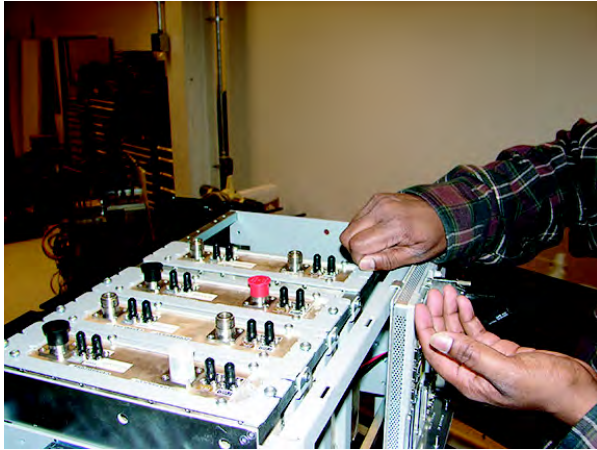

A

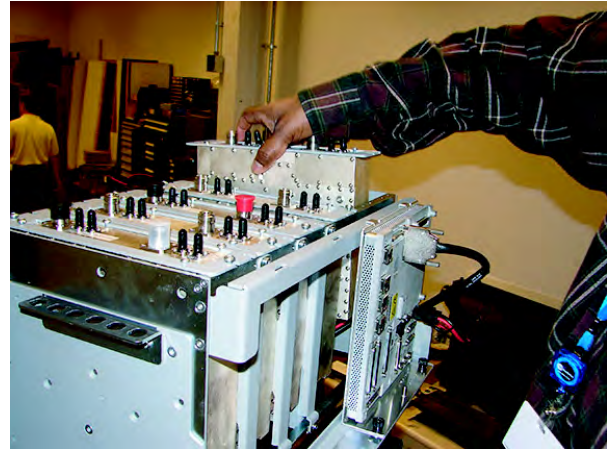

B

ti-odma-06035.eps

Adding an Optional RX Splitter

Objective

The objective of this section is to mount the optional RX splitter onto the bottom of the XMI shelf.



NOTE

Cabling of the RX splitter to the XMIs will be performed after all of the additional expansion equipment (i.e., XMI, DMI, circuit breaker/output power connector assemblies, etc.) is installed in the frame.

Required items

Parts

The following part is required:

- Wide band (800 MHz through 2.1 GHz RF bands) single band RX splitter (Motorola model STRG4029)

Tools

The following tools are required:

- TORX T25 bit and driver
- Torque driver

Procedure

[Procedure 3-5](#) contains the steps for adding the RX splitter to the bottom of the XMI shelf.

Procedure 3-5 Adding an RX splitter to the XMI shelf

-
- | | |
|---|--|
| 1 | Remove the RX splitter from its packaging and inspect it for damage. |
|---|--|
-

Continued

Procedure 3-5 Adding an RX splitter to the XMI shelf (Continued)

2	<p>While working at the front of the UBS Macro BTS frame, pick up the RX splitter and mount it onto the bottom of the XMI shelf as follows:</p> <ul style="list-style-type: none"> • See Figure 3-5 Mounting the RX splitter on page 3-18. • Position the RX splitter as follows: <ul style="list-style-type: none"> c RX splitter I/O connectors facing toward front of the frame. c RX splitter mounting tabs, one on each end of splitter, facing up. c In front of the XMI shelf bottom bracket. • Align the guide pins on each RX splitter mounting tab with the corresponding hole located on the XMI shelf bottom bracket (see photograph A). • Insert the guide pins into the holes and hold the RX splitter mounting tabs against the XMI shelf bottom bracket. • Insert a mounting screw through each RX splitter mounting tab and into the XMI shelf bottom bracket. (see photograph B).
3	<p>Using a T25 TORX driver, tighten the mounting screws to 4.8 N-m (42.25 in-lb) ±10%.</p>

Procedural reference diagram

The following diagram helps clarify certain steps in [Procedure 3-5](#).

Figure 3-5 Mounting the RX splitter

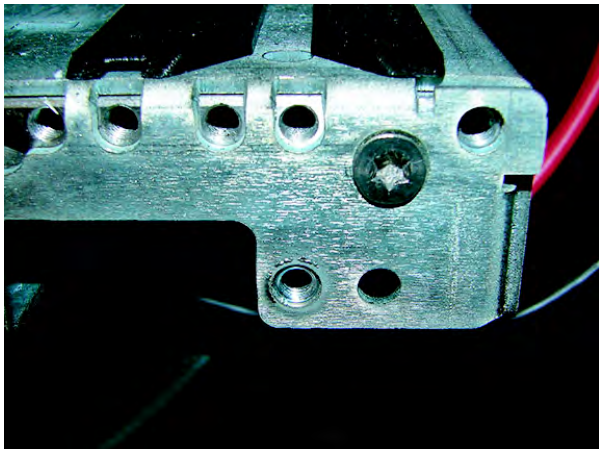

A

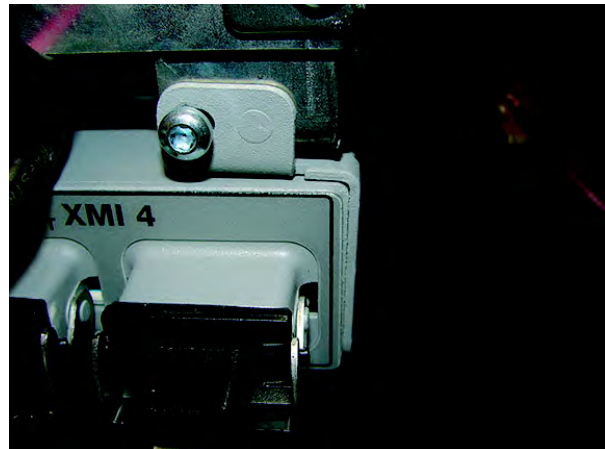

B

ti-odma-06036.eps

Adding a second/third PSM (-48 V or 220 V AC only)



NOTE

A second/third PSM is required when expanding a -48 V DC or 220 VAC UBS Macro BTS frame from low capacity to mid capacity. Two PSMs are required for the mid capacity configuration and the third PSM is for redundancy.

Objective

For -48 V or 220 V AC only, install the appropriate PSM into slot 2. If applicable, remove the filler plate that covers slot 3 of the PSM shelf and then install the appropriate PSM into slot 3.

Required items

Parts



CAUTION

Never plug a -48 V DC PSM into a 220 V AC PSM shelf.
Never plug a 220 V AC PSM into a -48 V DC PSM shelf.

Up to two of either the following parts are required:

- -48 V DC Power Supply Module (-48 V DC PSM) — Motorola model STPN4037
- 220 V AC Power Supply Module (220 V AC PSM) — Motorola model STPN4036

Tools

The following tools are required:

- TORX T25 bit and driver
- Torque driver

Procedure

Procedure 3-6 contains the steps for adding a second/third PSM to the PSM shelf.

Procedure 3-6 Adding a 2nd/3rd PSM to the PSM shelf

1	If a PSM is to be installed in PSM shelf slot 3, use a T25 TORX bit and driver to completely loosen the captive retaining thumbscrew on the filler plate that covers slot 3 of the PSM shelf. Remove the filler plate.
2	<div style="display: flex; align-items: center; gap: 10px;">  <div style="border: 1px solid black; padding: 2px 5px; font-weight: bold; background-color: #f4a460;">WARNING</div> </div> <p>PSM weighs approximately 5 kg. Be careful when handling the PSM to prevent damage to the equipment and personal injury.</p> <p>Install the appropriate PSM into PSM shelf slot 2 and 3 as follows:</p> <ol style="list-style-type: none"> 1. Grasp the handle on the front panel of the PSM with one hand while carefully supporting the bottom of the module with the other hand. 2. Properly orient the PSM and insert it into the slot. 3. Slowly slide the module into the shelf until the rear connectors are fully seated. Make sure that the PSM is fully engaged with the shelf backplane slot connectors.
3	Using a T25 TORX bit and torque driver, tighten the captive retaining thumbscrew to 2.37 N-m (21 in-lb).

Mid-capacity Expansion Interconnect Cabling

Objective

The objective of this section is to route and connect all required cabling between the additional mid-capacity expansion equipment (i.e., 2nd XMI, 2nd DMI, optional RX splitter, circuit breaker/output power connector assemblies) that is installed in the frame.



NOTE

The RX splitter is optional equipment for expansion to mid-capacity. An RX share cable can be used instead of the RX splitter for interconnecting RX RF signals between XMI 1 and XMI 2.

Installing DC power cables

Locate the required DC power cables and then perform [Procedure 3-7](#) through [Procedure 3-8](#) as needed.

Required DC power cables

- XMI DC power cable (Motorola part number 3088319T03)
- DMI DC power cable (Motorola part number 3088961T05)

DC power cabling procedures

Procedure 3-7 Installing the XMI 2 DC power cable

1	Locate the XMI DC power cable (Motorola part number 3088319T03).
2	Connect the appropriate end of the XMI DC power cable to the +27 V DC input power connector on the top of XMI 2 front panel.

Continued

Procedure 3-7 Installing the XMI 2 DC power cable (Continued)

3	Route the loose end of the XMI DC power cable as follows:
	<ol style="list-style-type: none">1. Through the opening above XMI 2 between the XMI shelf and the IDR shelf to the back of the XMI shelf.2. Down and around the left side of the rear of XMI 2.
	 NOTE To avoid blocking exhaust air from the XMI, the XMI DC power cable must not be routed directly behind the XMI.
3.	Down to the PDU and over the top of the PDU to the PDU front panel.
4	Connect the loose end of the XMI DC power cable to the XMI 2 DC output power connector on the PDU front panel.

Procedure 3-8 Installing the DMI 2 DC power cable

1	Locate the DMI DC power cable (Motorola part number 3088961T05).
2	Connect the appropriate end of the DMI DC power cable to the DMI 2 DC output power connector on the PDU front panel.

Continued

Procedure 3-8 Installing the DMI 2 DC power cable (Continued)

- 3** Route the loose end of the DMI DC power cable as follows:
- 1.** Up the right side of the frame/rack and around to the back of the frame.
 - 2.** Through the opening between the XMI shelf and the IDRf shelf and over the XMI shelf top bracket.
 - 3.** Down to the front panel of the appropriate DMI.

**NOTE**

Excess cable should be coiled up and placed on top of the XMI shelf top bracket.

- 4** Connect the loose end of the DMI DC power cable to the +27 V DC input power connector on the front panel of DMI 2.

Installing/Connecting RF cables (XMI to IDRf)

Locate the required RF cables and then perform [Procedure 3-9](#) and [Procedure 3-10](#) as needed.

Required RF cables

The required TX RF cables are as follows:

- TX sector-1 RF cable (Motorola part number 3088160T73)
- TX sector-2 RF cable (Motorola part number 3088160T74)
- TX sector-3 RF cable (Motorola part number 3088160T75)

RF cabling procedures

Perform [Procedure 3-9](#) to install the TX RF cables between XMI 2 and the second set of IDRFs.

Procedure 3-9 Installing TX RF cables

1	<p>Locate the following TX RF cables:</p> <ul style="list-style-type: none"> • TX sector-1 RF cable (Motorola part number 3088160T73) • TX sector-2 RF cable (Motorola part number 3088160T74) • TX sector-3 RF cable (Motorola part number 3088160T75)
2	<p>Install the TX sector-1 RF cable as follows:</p> <ol style="list-style-type: none"> 1. Connect one end of the cable to the TX1 connector on the XMI 2 front panel. 2. Route the loose end of the cable through the opening between the XMI shelf and the IDRF shelf. 3. Loop the cable around under the second set of IDRFs. 4. Connect the loose end of the TX sector-1 RF cable to the TX input connector on the bottom panel of the sector-1 IDRF of the second set of IDRFs.
3	<p>Install the TX sector-2 RF cable as follows:</p> <ol style="list-style-type: none"> 1. Connect one end of the cable to the TX2 connector on the XMI 2 front panel. 2. Route the loose end of the cable through the opening between the XMI shelf and the IDRF shelf. 3. Loop the cable around under the second set of IDRFs. 4. Connect the loose end of the TX sector-2 RF cable to the TX input connector on the bottom panel of the sector-2 IDRF of the second set of IDRFs.
4	<p>Install the TX sector-3 RF cable as follows:</p> <ol style="list-style-type: none"> 1. Connect one end of the cable to the TX3 connector on the XMI 2 front panel. 2. Route the loose end of the cable through the opening between the XMI shelf and the IDRF shelf. 3. Loop the cable around under the second set of IDRFs. 4. Connect the loose end of the TX sector-3 RF cable to the TX input connector on the bottom panel of the sector-3 IDRF of the second set of IDRFs.

Perform [Procedure 3-10](#) to connect the RX RF cables between XMI 2 and the second set of IDRFs.

Procedure 3-10 Connecting RX RF cables

1	<p>Disconnect the following RX RF cables from the front panel of XMI 1:</p> <ol style="list-style-type: none"> 1. Disconnect the end of the 3088160T79 cable from the RX1 D connector on the XMI 1 front panel. 2. Disconnect the end of the 3088160T80 cable from the RX2 D connector on the XMI 1 front panel. 3. Disconnect the end of the 3088160T81 cable from the RX3 D connector on the XMI 1 front panel.
2	<p>Connect the RX RF cables that were disconnected in step 1 to the front panel of XMI 2 as follows:</p> <ol style="list-style-type: none"> 1. Connect the loose end of the 3088160T79 cable to the RX1 D connector on the XMI 2 front panel. 2. Connect the loose end of the 3088160T80 cable to the RX2 D connector on the XMI 2 front panel. 3. Connect the loose end of the 3088160T81 cable to the RX3 D connector on the XMI 2 front panel.
3	<p>Disconnect the following RX RF cables from the bottom of the first (original) set of IDRFs as follows:</p> <ol style="list-style-type: none"> 1. Disconnect the end of the 3088160T79 cable from the RX DIV connector on the bottom panel of the sector-1 IDRF of the first set of IDRFs. 2. Disconnect the end of the 3088160T80 cable from the RX DIV connector on the bottom panel of the sector-2 IDRF of the first set of IDRFs. 3. Disconnect the end of the 3088160T81 cable from the RX DIV connector on the bottom panel of the sector-3 IDRF of the first set of IDRFs.
4	<p>Connect the RX RF cables that were disconnected in step 3 to the bottom panel of the second set of IDRFs as follows:</p> <ol style="list-style-type: none"> 1. Connect the loose end of the 3088160T79 cable to the RX MAIN connector on the bottom panel of the sector-1 IDRF of the second set of IDRFs. 2. Connect the loose end of the 3088160T80 cable to the RX MAIN connector on the bottom panel of the sector-2 IDRF of the second set of IDRFs. 3. Connect the loose end of the 3088160T81 cable to the RX MAIN connector on the bottom panel of the sector-3 IDRF of the second set of IDRFs.

Installing XMI to DMI cables

Locate the required XMI to DMI cables and then perform [Procedure 3-11](#).



NOTE

For the mid-capacity frame, there are four 3088791T02 cables used to interconnect XMIs to DMIs. One of these cables is already installed/connected in the low-capacity configuration.

Required XMI to DMI cables

The required XMI to DMI cables are as follows:

- Three XMI to DMI cables (Motorola part number 3088791T02)

XMI to DMI cabling procedure

Perform [Procedure 3-11](#) to install the XMI to DMI cables between two XMIs and two DMIs.

Procedure 3-11 Installing XMI to DMI cables

1	Verify that an XMI to DMI cable (Motorola part number 3088791T02) is already installed/connected between XMI 1 front panel connector HSL 1 and DMI 1 front panel connector XMI 1/BSI.
2	Locate the following cables: <ul style="list-style-type: none"> • Three XMI to DMI cables (Motorola part number 3088791T02)
3	Install an XMI to DMI cable between XMI 1 and DMI 2 as follows: <ol style="list-style-type: none"> 1. Connect the appropriate end of the 3088791T02 cable to the HSL 2 connector on the XMI 1 front panel. 2. Route the loose end of the cable up above XMI 1, through the opening between the XMI shelf and IDR shelf, and behind the hooks on the top XMI shelf bracket. Continue routing over to the XMI shelf DMI slot and then down to DMI 2. 3. Connect the loose end of the 3088791T02 cable to the XMI 1/BSI connector on the DMI 2 front panel.
4	Install an XMI to DMI cable between XMI 2 and DMI 1 as follows: <ol style="list-style-type: none"> 1. Connect the appropriate end of the 3088791T02 cable to the HSL 1 connector on the XMI 2 front panel.

Continued

Procedure 3-11 Installing XMI to DMI cables (Continued)

	<ol style="list-style-type: none"> 2. Route the loose end of the cable up above XMI 2 through the opening between the XMI shelf and IDRF shelf, and behind the hooks on the top XMI shelf bracket. Continue routing over to the XMI shelf DMI slot and then down to DMI 1. 3. Connect the loose end of the 3088791T02 cable to the XMI 2 connector on the DMI 1 front panel.
5	<p>Install an XMI to DMI cable between XMI 2 and DMI 2 as follows:</p> <ol style="list-style-type: none"> 1. Connect the appropriate end of the 3088791T02 cable to the HSL 2 connector on the XMI 2 front panel. 2. Route the loose end of the cable up above XMI 2 through the opening between the XMI shelf and IDRF shelf, and behind the hooks on the top XMI shelf bracket. Continue routing over to the XMI shelf DMI slot and then down to DMI 2. 3. Connect the loose end of the 3088791T02 cable to the XMI 2 connector on the DMI 2 front panel.

Installing DMI to SSI cables

Locate the required DMI to SSI cables and then perform [Procedure 3-12](#).

**NOTE**

For the mid-capacity frame, there are two 3088792T01 cables used to interconnect SSI 1 to DMI 1 and DMI 2. One of these cables is already installed/connected in the low-capacity configuration.

Required DMI to SSI cables

The required DMI to SSI cable is as follows:

- One DMI to SSI cable (Motorola part number 3088792T01)

DMI to SSI cabling procedure

Perform [Procedure 3-12](#) to install the DMI to SSI cable between SSI 1 and DMI 2.

Procedure 3-12 Installing DMI 2 to SSI 1 cable**Continued**

1	Verify that a DMI to SSI cable (Motorola part number 3088792T01) is already installed/connected between DMI 1 front panel connector IDI/SSI 1 and SSI 1 front panel connector DMI 1/IDI .
2	Locate the following cables: <ul style="list-style-type: none"> ● One DMI to SSI cable (Motorola part number 3088792T01)
3	Install the DMI to SSI cable between DMI 2 and SSI 1 as follows: <ol style="list-style-type: none"> 1. Connect the appropriate end of the 3088792T01 cable to the IDI/SSI 1 connector on the DMI 2 front panel. 2. Route the loose end of the cable up above the XMI shelf DMI slot, through the opening between the XMI shelf and the IDRF shelf, and out the right side of the opening. Continue routing upwards along the right rack rail and over in to SSI 1. <div style="margin-top: 10px;">  <div style="background-color: #00b050; color: white; padding: 5px; display: inline-block; font-weight: bold; margin-left: 10px;">NOTE</div> <p style="margin-left: 40px;">Excess cable should be coiled up and placed on top of the XMI shelf top bracket.</p> </div> <ol style="list-style-type: none"> 3. Connect the loose end of the 3088792T01 cable to the DMI 2 connector on the SSI 1 front panel.

Installing RX splitter to XMI RX RF cables or RX share cable

Expansion to mid-capacity requires interconnection of RX RF signals between XMI 1 and XMI 2. This can be accomplished by using an optional RX splitter or RX share cable.

If the optional RX splitter is used, locate the required RX splitter to XMI RX RF cables and then perform [Procedure 3-13](#).

If the optional RX splitter is not used, locate the required RX share cable and then perform [Procedure 3-14](#).

Required RX splitter to XMI RX RF cables

The required RX splitter to XMI RX RF cables are as follows:

- RX splitter to XMI 1 RX RF cable (Motorola part number 3088407T10)
- RX splitter to XMI 2 RX RF cable (Motorola part number 3088407T11)

Required RX share cable

The required RX share cable is as follows:

- RX share cable (Motorola part number SGLN6345)



NOTE

The RX share cable cross-connects XMI 1 **RX EXP OUT** to XMI 2 **RX EXP IN** and XMI 2 **RX EXP OUT** to XMI 1 **RX EXP IN**.

RX splitter to XMI cabling procedure

Perform [Procedure 3-13](#) to install the RX splitter to XMI RX RF cables between RX splitter and the two XMIs.

Procedure 3-13 Installing RX splitter to XMI RX RF cables

1	<p>Locate the following cables:</p> <ul style="list-style-type: none"> • RX splitter to XMI 1 RX RF cable (Motorola part number 3088407T10) • RX splitter to XMI 2 RX RF cable (Motorola part number 3088407T11)
2	<p>Install the RX splitter to XMI 1 RX RF cable (Motorola part number 3088407T10) as follows:</p> <div style="margin-top: 10px;">  <div style="background-color: #00e0e0; color: white; padding: 5px; display: inline-block; margin-left: 10px;">NOTE</div> </div> <p>The 3088407T10 cable contains two separate cables bundled together. The 3088407T10 cable has two connectors on each end of the bundle. The ends of each separate cable can be determined by observation.</p> <ol style="list-style-type: none"> 1. Position the 3088407T10 cable so that two connectors on one end of the bundle are in front of XMI 1 (i.e., XMI end) and the two connectors on the other end of the bundle are in front of the RX splitter. 2. Connect an XMI end connector to the RX EXP OUT connector on the XMI 1 front panel. 3. Connect the loose end of the same separate cable to the XMI 1 RX EXP IN connector on the RX splitter front panel. 4. Connect the remaining XMI end connector to the RX EXP IN connector on the XMI 1 front panel.

Continued

Procedure 3-13 Installing RX splitter to XMI RX RF cables (Continued)

5. Connect the loose end of the same separate cable to the **XMI 1 RX EXP OUT** connector on the RX splitter front panel.

- 3 Install the RX splitter to XMI 2 RX RF cable (Motorola part number 3088407T11) as follows:

**NOTE**

The 3088407T11 cable contains two separate cables bundled together. The 3088407T11 cable has two connectors on each end of the bundle. The ends of each separate cable can be determined by observation.

1. Position the 3088407T11 cable so that two connectors on one end of the bundle are in front of XMI 2 (i.e., XMI end) and the two connectors on the other end of the bundle are in front of the RX splitter.
2. Connect an XMI end connector to the **RX EXP OUT** connector on the XMI 2 front panel.
3. Connect the loose end of the same separate cable to the **XMI 2 RX EXP IN** connector on the RX splitter front panel.
4. Connect the remaining XMI end connector cable to the **RX EXP OUT** connector on the XMI 2 front panel.
5. Connect the loose end of the same separate cable to the **XMI 2 RX EXP IN** connector on the RX splitter front panel.

XMI 1 to XMI 2 RX cabling procedure

Perform [Procedure 3-14](#) to install the RX share cable to interconnect RX RF signals between XMI 1 and XMI 2.

Procedure 3-14 Installing RX share cable

- 1 Locate the following cable:
 - RX share cable (Motorola part number SGLN6345)

Continued

Procedure 3-14 Installing RX share cable (Continued)**NOTE**

The SGLN6345 cable contains two separate cables bundled together. The SGLN6345 cable has four ends with a connector on each end.

The ends of the RX share cable are labeled as follows:

- **XMI 1 RX EXP OUT**
- **XMI 1 RX EXP IN**
- **XMI 2 RX EXP OUT**
- **XMI 2 RX EXP IN**

2 Install the RX share cable as follows:

- 1.** Connect the **XMI 1 RX EXP OUT** cable connector to the **RX EXP OUT** connector on the XMI 1 front panel.
- 2.** Connect the **XMI 1 RX EXP IN** cable connector to the **RX EXP IN** connector on the XMI 1 front panel.
- 3.** Connect the **XMI 2 RX EXP OUT** cable connector to the **RX EXP OUT** connector on the XMI 2 front panel.
- 4.** Connect the remaining **XMI 2 RX EXP IN** cable connector to the **RX EXP IN** connector on the XMI 2 front panel.

What's Next

.....

Installation completion

At this point the hardware installation is complete. Perform the following tasks to complete the system installation.

- Clean up the site
- Fill out the installation completion checklist
- Record **As-Built** information
- Perform the ATPs
- Load the software

Perform the clean up of the site and fill out the checklist, first. Then perform the rest of the tasks or perform them later.

Clean up the site

Clean up the site by following the instructions given in [Procedure 4-1](#).

Procedure 4-1 Cleaning the site

1	Remove protective covering Remove any cardboard from the walls that was used to protect the walls. Remove any antistatic plastic or cloth sheet used to cover the equipment.
2	Lighting fixtures Remove any masking tape from the fluorescent light fixtures.
3	Tools Place all hand and power tools in the installation tool kit or other appropriate place. Check for any tools requiring replacement, cleaning, or adjustment.
4	Materials Place any leftover materials in a location specified by the site manager.
5	Remove debris To remove the debris, perform the following: <ul style="list-style-type: none"> ● Remove any packing material. ● Ensure that all scrap materials are removed from any tables or stands. ● Clean/sweep the floor. Ensure all chalk-line marks are removed.

Continued

Procedure 4-1 Cleaning the site (Continued)

6	<p>Environment Perform the following to check the environment:</p> <ul style="list-style-type: none"> • Check whether all covers, frame doors and fan housings are in place. • Confirm all power connections are tight. • Organize any items (such as manuals, materials, etc.) left on site and place them in a safe location specified by the site manager.
----------	---

Fill out the installation completion checklist

After the site is cleaned up, fill out the installation completion checklist and make any necessary copies. Copy this check sheet as required.

Installation completion checklist

Date Hardware Installation Completed: _____

Site: _____

BTS Frame Serial Number: _____

Checklist Completed By: _____

Checklist Reviewed By: _____

Table 4-1 Installation completion checklist

Status	No.	Item	Notes
	1	Frames are bolted down.	
	2	DC power cabling completed.	
	3	Each frame has its own earth ground.	
	4	RX RF cables installed.	
	5	TX RF cables installed.	
	6	Span line cables installed.	
	7	Alarm cables installed.	
	8	RGPS head installed (if required).	
	9	RGPS cabling installed (if required).	
	10	All connectors (power, signal, RF, internal and external) are tight.	
	11	All cables dressed and tied.	
	12	Installation and site specific manuals at site.	

Continued

Table 4-1 Installation completion checklist (Continued)

Status	No.	Item	Notes
	13	Cable racks properly grounded.	
	14	Static wrist straps are present.	
	15	Site cleaned, swept, and trash removed.	
	16	Any deficiencies reported to the appropriate people.	
	17	Correct polarity has been maintained from the DC power source to the frame.	
	18	Power has not been applied to any frame.	

Record "As-Built" information

Record the site specific information on how the unit was installed and cabled.

Performing the ATPs

This manual does not cover the procedure of performing the ATPs. For this procedure, refer to the *1X UBS Macro BTS Optimization/ATP* (68P09283A63) manual.

Loading the software

This manual does not cover the procedure for loading the software. Refer to the appropriate software release manual for procedure for loading the software.