

**NOKIA**

# **Nokia MetroSite Base Station Commissioning**

**Confidential**

The information in this document is subject to change without notice and describes only the product defined in the introduction of this documentation. This document is intended for the use of Nokia Telecommunications' customers only for the purposes of the agreement under which the document is submitted, and no part of it may be reproduced or transmitted in any form or means without the prior written permission of Nokia Telecommunications. The document has been prepared to be used by professional and properly trained personnel, and the customer assumes full responsibility when using it. Nokia Telecommunications welcomes customer comments as part of the process of continuous development and improvement of the documentation.

The information or statements given in this document concerning the suitability, capacity, or performance of the mentioned hardware or software products cannot be considered binding but shall be defined in the agreement made between Nokia Telecommunications and the customer. However, Nokia Telecommunications has made all reasonable efforts to ensure that the instructions contained in the document are adequate and free of material errors and omissions. Nokia Telecommunications will, if necessary, explain issues which may not be covered by the document.

Nokia Telecommunications' liability for any errors in the document is limited to the documentary correction of errors. Nokia Telecommunications WILL NOT BE RESPONSIBLE IN ANY EVENT FOR ERRORS IN THIS DOCUMENT OR FOR ANY DAMAGES, INCIDENTAL OR CONSEQUENTIAL (INCLUDING MONETARY LOSSES), that might arise from the use of this document or the information in it.

This document and the product it describes are considered protected by copyright according to the applicable laws.

NOKIA logo is a registered trademark of Nokia Corporation.

Other product names mentioned in this document may be trademarks of their respective companies, and they are mentioned for identification purposes only.

Copyright © Nokia Telecommunications Oy 1999. All rights reserved.

## Contents

	<b>Contents</b>	<b>3</b>
<b>1</b>	<b>About this document</b>	<b>7</b>
<b>2</b>	<b>Nokia BTS Manager</b>	<b>9</b>
2.1	Starting and exiting the BTS Manager	9
2.2	Using Help	10
<b>3</b>	<b>Commissioning</b>	<b>11</b>
3.1	Commissioning with Nokia BTS Manager's Wizard	11
3.2	Allocating transmission capacity with Traffic Manager	21
<b>4</b>	<b>Commissioning report</b>	<b>25</b>
4.1	Test results	25
<b>5</b>	<b>Troubleshooting and fault reporting</b>	<b>27</b>
<b>6</b>	<b>Routing transmission capacity</b>	<b>29</b>
6.1	Creating cross-connections manually	29
	<b>Appendix A. LMP connector description</b>	<b>33</b>



## Summary of changes

Updated September 99



# 1

## About this document

This document describes the commissioning of the Nokia MetroSite GSM 900, 1800 and 1900 Base Station (BTS). The document provides instructions on how to use the Nokia BTS Manager's commissioning Wizard. Read carefully *Nokia MetroSite BTS Warnings and Cautions* before starting the commissioning.

The document contains the following information:

- chapter 2: Nokia BTS Manager
- chapter 3: Commissioning
- chapter 4: Commissioning Report
- chapter 5: Troubleshooting and Fault Reporting
- chapter 6: Routing Transmission Capacity

---

### Caution

Commissioning measures concerning any Nokia Base Transceiver Station (BTS) may be performed only by properly trained and authorised personnel.

---





# 2

## Nokia BTS Manager

This chapter gives instructions on how to get started with Nokia BTS Manager. It is assumed here that the user knows how to use Windows 95 or NT4.0 software.

### 2.1 Starting and exiting the BTS Manager

The installation program of the manager SW creates a Nokia BTS Manager icon on the desktop and defines its parameters. For more information on the installation, refer to the Nokia BTS Manager online Help or the instructions on the Nokia BTS Manager CD-ROM case.



#### **Start the BTS Manager as follows:**

1. Double-click the BTS Manager icon on the desktop. The Nokia BTS Manager starts with the Supervise and Alarms windows opened. Also, the software checks the BTS configuration and displays it in the Supervision window.
2. Enter the MMI password if MMI password checking is on (this is the case when you work in Windows 95 environment).
3. Enter the BTS password if BTS password checking is on. The software continues execution only if the BTS accepts the entered password. You may enter an invalid password three times before the BTS Manager exits.

You can define different Manager options and communications parameters when starting to work with the BTS Manager.

---

#### **Note**

The BTS Manager PC must be connected to the BTS in order to make the BTS password checking possible. If no connection exists, password checking is not applicable.

---

To exit the BTS Manager, choose the Exit command on the File menu.

## 2.2 Using Help

The Nokia BTS Manager software has a convenient, context-sensitive online Help facility for getting information about a task you are going to perform, a feature you might want to know more about, or a command you may want to use.

To get Help

- press F1
- click the 'Help' button on the toolbar
- choose one of the Help menu commands or
- click the Help button in any dialog box.

In the Help Topics window you can see three tabbed pages: Contents, Index and Find.

### **Contents**

The Contents page displays a list of topics organized in books by category.

### **Index**

The Index page lists keywords in alphabetical order through which different topics can be reached.

### **Find**

The Find page provides a full-text search functionality that allows you to search for any word or phrase in the Help file.

To exit Help, press ESC or ALT+F4.

# 3 Commissioning

## 3.1 Commissioning with Nokia BTS Manager's Wizard

The commissioning is done with Nokia BTS Manager's Wizard.

It is assumed here that the LAPD links and the PCM port are activated at the BSC. The BCF is in the 'unlocked' state.



**Before beginning the commissioning do the following:**

1. Check that the Abis cables are connected.
2. Check that the Nokia MetroSite BTS is powered up.
3. Connect the Nokia BTS Manager PC to the BTS's LMP port. See Appendix A for a description of the LMP cable.

4. Check that you have the required Site IDs and transmission capacity tables, or that the correct Site Configuration File (SCF) exists on the PC hard disk.
- 

#### Note

The Site Configuration File is an unformatted ASCII file which contains site parameters for several sites under a BSC. The file is created from the NMS/2000 database and it can be retrieved to the Manager PC via a Web server interface to the NMS/2000 (refer to NMS/2000 documentation). During the commissioning procedure, the parameters for the selected site are automatically read from the file.

The file can be modified locally using the SCF Editor, which is delivered on the Nokia BTS Manager CD-ROM. For details on how to install the editor, refer to the instructions on the CD-ROM case. For information on how to use the editor, refer to the application's online Help.

---

#### Note

BTS SW is loaded to the BTS by the manufacturer. There is usually no need to locally load SW to the BTS during commissioning.

---



#### **Start the commissioning as follows:**

1. Start the Nokia BTS Manager by double-clicking the BTS Manager icon on the desktop.
  2. Enter the MMI and BTS passwords, if required.
  3. When the BTS Manager indicates that the BTS is in the 'BCF commissioning' state, choose the Wizard command on the Commissioning menu.
  4. Select the Manual Commissioning option and click Next.
- 

#### Note

Commissioning can be done only with a non-commissioned BTS. If the BTS is already commissioned, you need to run the Undo Commissioning procedure first.

---

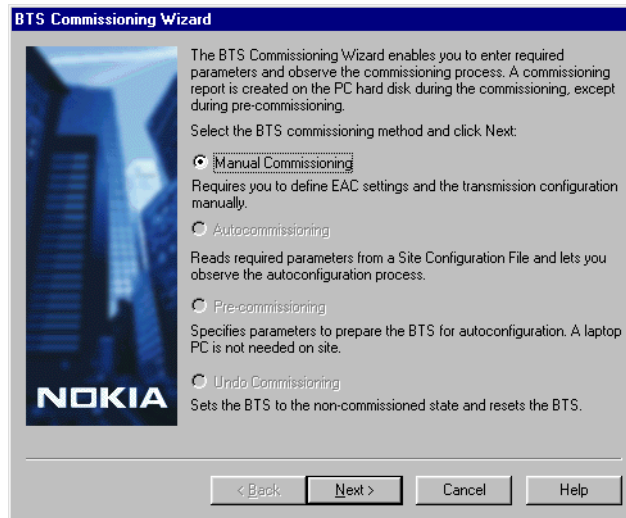

Figure 1. Manual Commissioning option

5. The configuration data for the site(s) is stored on your PC in a Site Configuration File (SCF) under a certain pre-defined name. Open the file, select the site to be commissioned and click Next.

The next time you launch the Commissioning Wizard, this page automatically displays the Site Configuration File you used in the previous session.

---

#### Note

If the correct site configuration data is not in the SCF or if the SCF file itself is not available, select the 'Undefined' site option and click Next to continue.

---

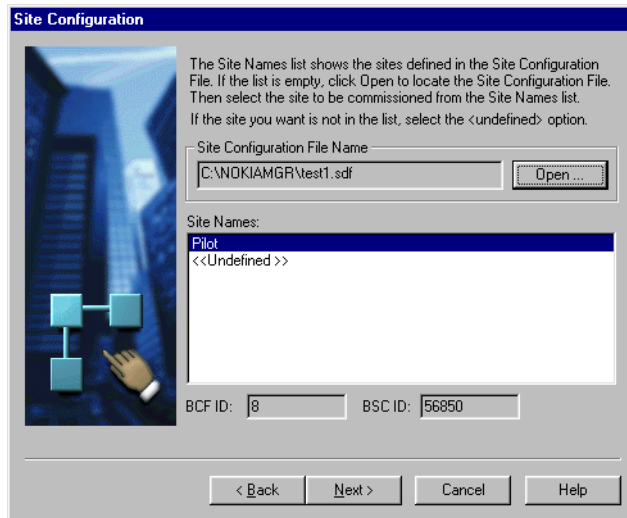

Figure 2. Site configuration file and site name list

---

**Note**

If the EAC inputs will not be used, just click Next.

---

6. Check the EAC inputs if they will be used. If the SCF is available and the EACs are defined in it, the 'In Use' information is read from the SCF; otherwise you have to mark the required EACs as 'In Use'.

The state of each EAC will change in real time as you test them, e.g. if you blow some smoke on the smoke detector. Then, the appropriate state changes from 'Open' to 'Closed', or vice versa.

After testing the EACs, mark them 'Checked'. When you have completed the testing (or checking), click Next.

---

**Note**

The Next button remains disabled until you click a check mark in the Checked box for all inputs that are 'In Use'.

---

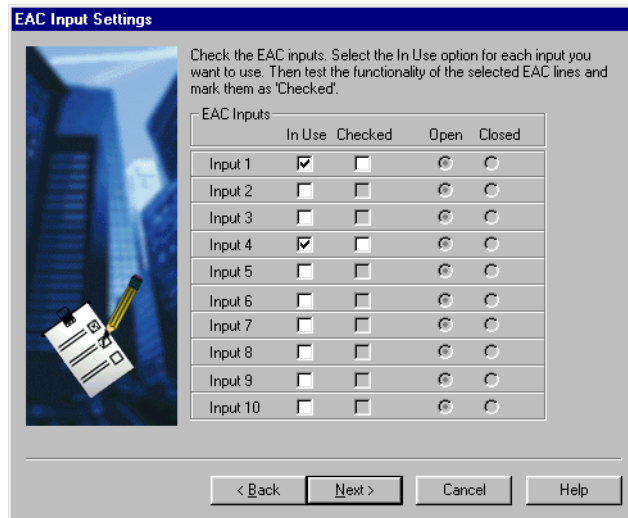

Figure 3. EAC inputs

---

**Note**

If the EAC outputs will not be used, click Next.

---

7. Check the EAC outputs (if they will be used) by changing the EAC states. If the SCF is available and the EACs are defined in it, the EAC output information is read from the SCF; otherwise you have to first mark the required EACs as 'In use'.

When you have finished the EAC output settings, click the Set Outputs button to send the information to ther BTS.

After you have completed checking, click Next.

---

**Note**

The Next button remains disabled until you click a check mark in the Checked box for all outputs that are 'In Use'.

---

**Note**

The EAC names and polarities are defined at the BSC.

---

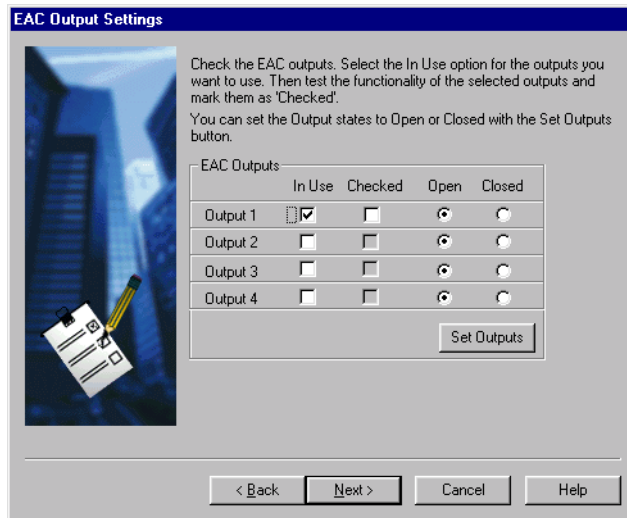

Figure 4. EAC outputs

8. Check that the transmission parameters are correct. If you selected the <undefined> option on the Site Configuration page, you need to enter the parameters here, because the information was not available in the Site Configuration File.

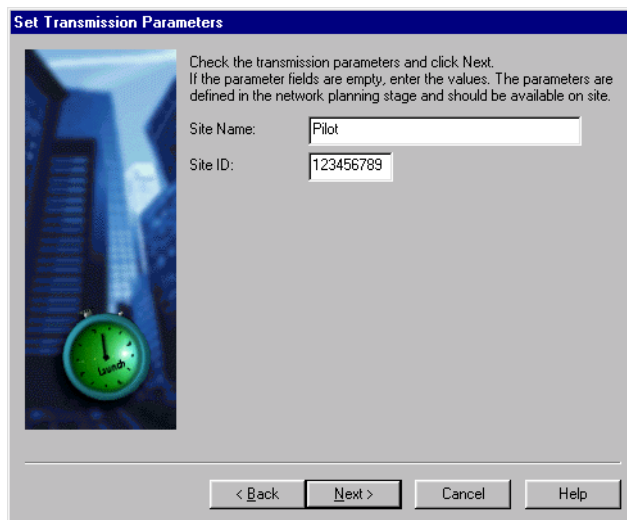

Figure 5. Transmission parameters



- Click the Traffic Manager button to open the Traffic Manager dialog box. The Next button is disabled until you return from the Traffic Manager.

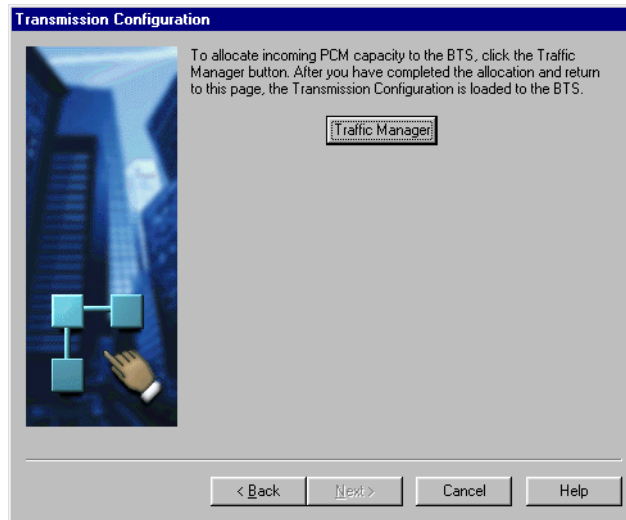

Figure 6. Traffic Manager button

- Allocate transmission capacity to the BTS with the Traffic Manager (refer to 3.2) and, when completed, click OK. This will establish a transmission connection between the BTS and the BSC. (In case the connection fails, refer to chapter 5, Troubleshooting and fault reporting.)

When you click OK in the Traffic Manager, the Transmission Configuration page reappears. The Back button is disabled, because the transmission parameters have already been sent to the BTS. If you need to change any parameters you have specified prior to this point, you have to run the Undo Commissioning procedure first and then re-commission the BTS.

When the Transmission Configuration page reappears, there is a short delay before the Wizard automatically proceeds to the next page. If the BTS Test Reporting page does not appear automatically, click Next to proceed.

---

### Note

When the BTS Test Reporting page appears, there is a slight delay before the automatic BSC-controlled tests start. If you click the Manual button to open the TRX Test dialog box and the BSC-controlled tests start, the dialog box closes automatically.

---

During the BTS/BSC start-up scenario the BSC checks the BTS SW and if it is not the correct one, the BSC loads SW to the BTS. This downloading will take from 5 to 20 minutes depending on the link speed. If no SW downloading takes place, the process will take about 10 seconds. After that the BSC sends the configuration data to the BTS.

11. When the BCF is in the 'Supervisory' state and the TRXs are ready for testing, the BTS tests are run under the BSC's control. The BSC runs automatic tests on the Abis link and on each TRX installed in the BTS.

The TRX test will take about 6 - 7 seconds for one TRX, 15 seconds for 4 TRXs (one radio time slot per each TRX is tested), while the Abis loop test will take about 1 minute 50 seconds (all channels of every TRX are tested).

---

### Note

If the establishment of the BTS/BSC connection does not succeed, the BTS remains in the 'Waiting for LAPD' state. Then you can click the Manual button to run local TRX tests. You can also run manual tests after the automatic BSC-controlled tests are over.

---



### Caution

In order not to interfere the operation of other sites, make sure that an RF attenuator is connected to every TRX in the BTS before you start local TRX tests.

---

The BTS starts operating normally after the tests have been performed, if the TRXs are unlocked at the BSC. The BCCH TRXs' LEDs are green and the TCH TRXs' LEDs are blinking green.

12. Check the test results on the BTS Test Reporting page and click Next.

---

### Note

The test results can be monitored at the BSC. It is also possible to request the latest test results remotely from the NMS/2000.

---

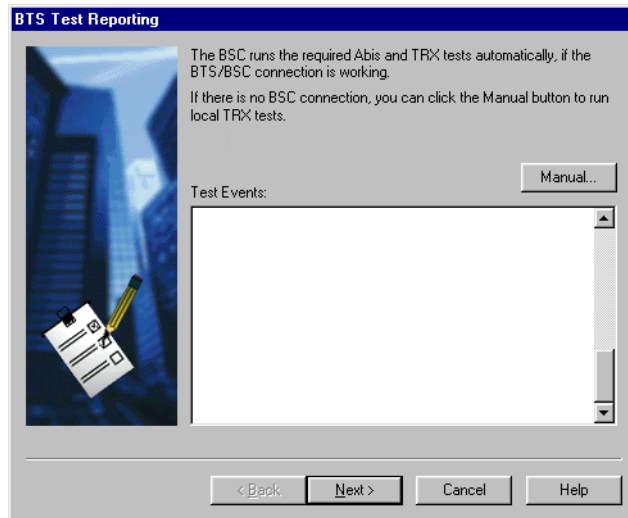

Figure 7. Test events

13. Check the BTS Commissioning Report.
14. Type a name for the BTS Commissioning Report in the Save As field.

By default, the Commissioning Report is saved to the \NOKIAMGR\REPORTS folder. To specify a different path for the report, click Browse and navigate to the folder you want.

15. Click Finish. The Commissioning Wizard closes.

---

### Note

If there is a need to route transmission capacity and no cross-connection file is available to automate the process, the cross-connections have to be created manually. See chapter 6 for instructions on how to create the cross-connections.

---

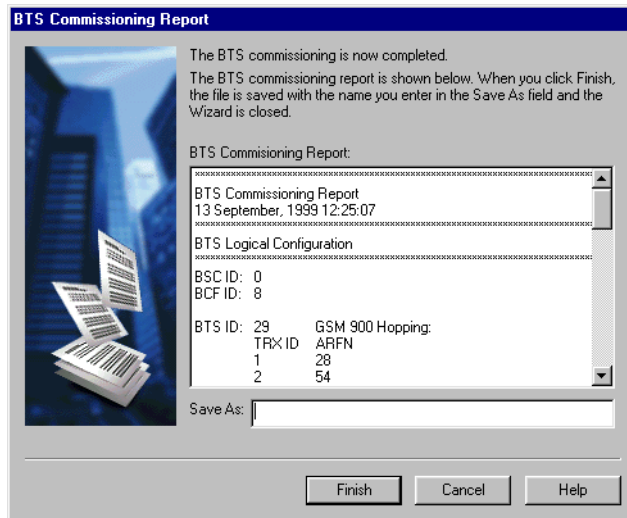

Figure 8. BTS Commissioning Report

16. Quit the BTS Manager.
17. Disconnect the BTS Manager PC from the Nokia MetroSite BTS's LMP port.

The commissioning parameters are stored in the flash memory of the Master TRX (i.e. TRX1). The Master TRX creates back-up copies of these parameters in the slave TRXs' flash memory.

**Note**

For maintenance purposes, in the case of 1\*TRX BTS, make a back-up copy of the timeslot allocation settings using the Traffic Manager's export function (refer to 3.2).

At this point you should check the Alarms window for possible alarms generated during the commissioning. For alarm descriptions, refer to *Nokia MetroSite BTS Alarm Descriptions*.

Complete the installation as instructed in *Nokia MetroSite Base Station Installation*.

### 3.2 Allocating transmission capacity with Traffic Manager

The Traffic Manager is a graphical tool that allows you to allocate BTS transmission capacity independent of which Nokia MetroSite transmission unit is used. You need only to define the line interface (e.g. Port 1) and the incoming timeslot allocation on the Abis according to the transmission plan.

With the FXC E1/T1 Symm transmission unit, the cross-connections are created automatically after the capacity has been set and approved.

If a Site Configuration File is used for transmission capacity allocation, the Abis TS Allocation table is filled automatically. You only need to check the correctness of the capacity allocation.

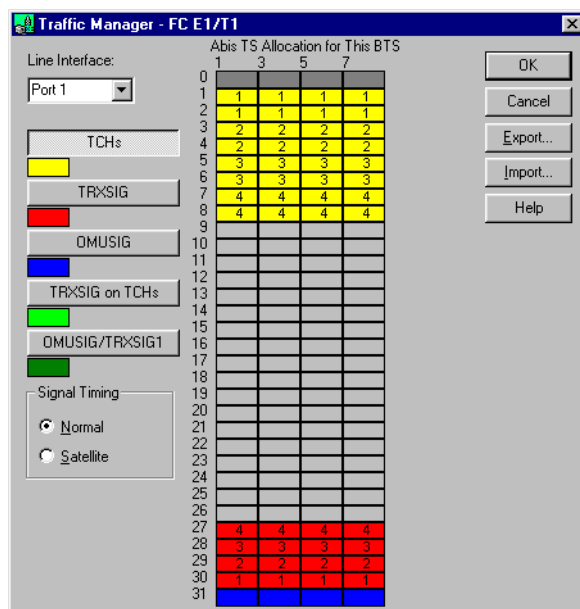

Figure 9. Traffic Manager for allocating BTS transmission capacity

#### Note

In the case of 1.5 MB links (T1), the Traffic Manager automatically reduces the number of timeslot rows in the table to 24.

The capacity to be used is defined by selecting its signal type (TCHs, TRXSIG, OMUSIG, TRXSIG on TCHs or OMUSIG/TRXSIG1) and by reserving required time slots and bits.

**Allocate transmission capacity as follows:**

1. Select the line interface used (Port 1 - Port 16, depending on the transmission unit).
2. Click the appropriate traffic or signal button.
3. Click in a cell in the Abis timeslot allocation table.
4. Select an option, e.g. link speed, as required by the SW. (The selections are different depending on the signal type.) The SW then automatically reserves the time slots and bits to be used for the selected function.
5. Repeat steps 2 - 4 until all types of necessary BTS signals are marked.

---

**Note**

If you want to modify the allocation table at this point, you have to first delete prior allocations. Click the right mouse button on the cells to be modified and delete either one signal allocation, all signal allocations of a particular type or delete all allocations for the selected port.

---

6. Check that the signal timing (either 'Normal' or 'Satellite') is correctly set.
7. Click the OK button to send the information to the BTS.

---

**Note**

If you want to modify the allocations after you click OK in the Traffic Manager, you have to first run Undo Commissioning and reset the BCF.

---

---

**Note**

When the link capacity restricts normal signal allocation, you can use the 'TRXSIG on TCHS' and combined 'OMUSIG/ TRXSIG1' signal types.

---

The signal types are discussed below in more detail:

**OMUSIG**

The BTS can have one OMUSIG which allocates 2, 4 or 8 bits in one time slot depending on the link speed used (16 - 64 kbit/s). If a combined OMU/TRXSIG1 is used, the allocation of the OMUSIG is disabled.

**OMUSIG/TRXSIG1**

The BTS can have one combined OMUSIG/TRXSIG1 which allocates 2, 4 or 8 bits in one timeslot depending on the link speed used (16 - 64 kbit/s). When a compressed Abis timeslot allocation is used, the OMUSIG/TRXSIG1 can be located in TCH/TS0 or TCH/TS0 - TS3 which means that it overlaps the TCHs which are reserved for a TRX (normally TRX1).

**TCHs**

The BTS must be allocated at least as many TCHs as there are TRXs installed in it (1 - 12). Each TCH allocates 2 contiguous time slots (16 bits) for a single TRX each of which is marked with the TRX number. The TCHs are numbered from 1 to 12 in order of which they are defined.

**TRXSIG**

The BTS must be allocated at least as many TRXSIGs as there are TRXs installed in it (1 - 12). Each TRXSIG can allocate 2, 4 or 8 bits in one time slot depending on the link speed used (16 - 64 kbit/s). The TRXSIGs are numbered from 1 to 12 in the order they are entered.

**TRXSIG on TCHs**

The TRXSIG can be reserved on a traffic channel but then up to 4 traffic channels are lost. The signal type must always start from the first bit of the channel.





# 4 Commissioning report

After the actual commissioning, the Commissioning Report is saved in a file on the PC hard disk (by default in the NOKIAMGR\BTSMAN\REPORTS folder).

The report is an ASCII text file that you can open and check with Notepad or any word processor.

The Commissioning Report can be sent to the NMS/2000 via the Web server. The report serves as the Site Acceptance document.

## 4.1 Test results

Each test gives one of the following test results: OK, Partially failed or Failed.

The BTS Commissioning report provides the following information:

- Report title
- Date and time
- BTS logical configuration
- BTS HW report
- BTS SW report
- EAC input test report
- EAC output test report
- TS allocation report
- TRX test report
- Abis test report
- BTS alarm test report
- External TREs
- Telecom status



# 5 Troubleshooting and fault reporting

In the case of a failure in the commissioning procedure, an alarm will appear in the alarm window (refer to the *BTS Alarm descriptions* document in the SW release binder). Also, you may check the cause of a failure from the commissioning report and the diagnostic report.

The commissioning procedure may fail, e.g. when:

- the Abis cables are not properly connected (then the transmission unit LED is not green)
- the pre-configuration failed at the BSC, e.g. the BCF and TRX objects were not created
- the oven oscillator has not yet warmed up (then the BCF remains in the 'Configuring' state)
- the TRXs are not unlocked at the BSC (then the TRXs do not enter the 'Supervisory' state)
- the PCM port is not activated at the BSC.

Before starting to re-commission the BTS, first run the Undo Commissioning procedure.

All damages, failures or faults must be reported to Nokia using the Failure Report Form provided by the Customer Services (CS).



# 6

## Routing transmission capacity

Routing of transmission capacity can be done in two ways, depending whether there is a cross-connection file available or not.

If the cross-connection file exists, routing of transmission capacity is automated, i.e. the Site Configuration File refers to the name of the file and the embedded node manager opens the file and sends the settings to the transmission unit without any indication to the user by the SW.

If the cross-connection file required is not available, you have to create the cross-connections manually using the Cross-connections tool (see the section below).

### 6.1 Creating cross-connections manually

Cross-connections are created with the Cross-connections tool in the transmission unit manager application.

Cross-connections define how signals are routed from a FXC transmission unit to another transmission unit. Cross-connections are created into banks which are either active or inactive. The cross-connections in the active banks are in use, whereas those in inactive banks can be used for creating or editing cross-connections. The procedure below describes how to create bi-directional cross-connections.



#### Create bi-directional cross-connections as follows:

1. Start the Cross-connections tool by choosing the Open command on the Transmission menu in the BTS Manager. The manager application for the transmission unit is launched and the BTS Manager session terminates.
2. Open the inactive bank page. (The number of the active bank is given above the cross-connections list view.)

3. Open the Add Cross-Connection dialog box by right-clicking the mouse and selecting the Add... command. (Another way to open the dialog box is to choose the Add command on the Cross-connections | Connections submenu.)
4. Define the following settings according to the cross-connection plan:
  - label, i.e. the name of the new cross-connection (max. 80 characters)
  - cross-connection type; in this case the type is 'bi-directional'
  - granularity (with nx64k set also its coefficient n)
  - cross-connection class
  - timeout.
5. Click the Tx1/Rx1 button to open the Termination Point view.
6. In the Interface tree view, select one of the FXC transmission card's interfaces, e.g. Interface 1.

---

#### Note

In the timeslot table, the earlier reserved timeslots and bits are indicated by grey, while the selected ones will become yellow.

---

7. Click a cell in the table to define the start bit of the frame.
8. Click OK. The dialog box is closed.
9. Click the Tx2/Rx2 button to open the Termination Point view.
10. In the Interface tree view, select an interface, e.g. Interface 2.
11. Click a cell in the table to define the start bit of the frame.
12. Click OK. The dialog box is closed.
13. Click Apply in the Add Cross-connection dialog box. All settings are loaded but the window remains open.
14. Repeat steps 1 - 13 for other types of cross-connections.
15. Activate the bank by selecting the Cross-connections | Banks | Activate command and click OK.
16. Close the views and the Cross-connection tool.

17. Quit the transmission unit manager. The Nokia BTS Manager starts automatically.

### **Editing a bank**

You can start editing already made settings in an inactive bank by double-clicking the particular connection in the cross-connection list view in the Cross-connection window or by selecting the connection and choosing the Edit command on the pop-up menu (which appears when you right-click the mouse).

If you have activated the bank, you need to copy the cross-connection information to the inactive bank for editing as active banks cannot be edited. The copy command also is available in the pop-up menu.





Appendix A. LMP connector description

Figure 10 below describes the connectors and pin order of the LMP cable which connects the BTS Manager PC to the BTS.

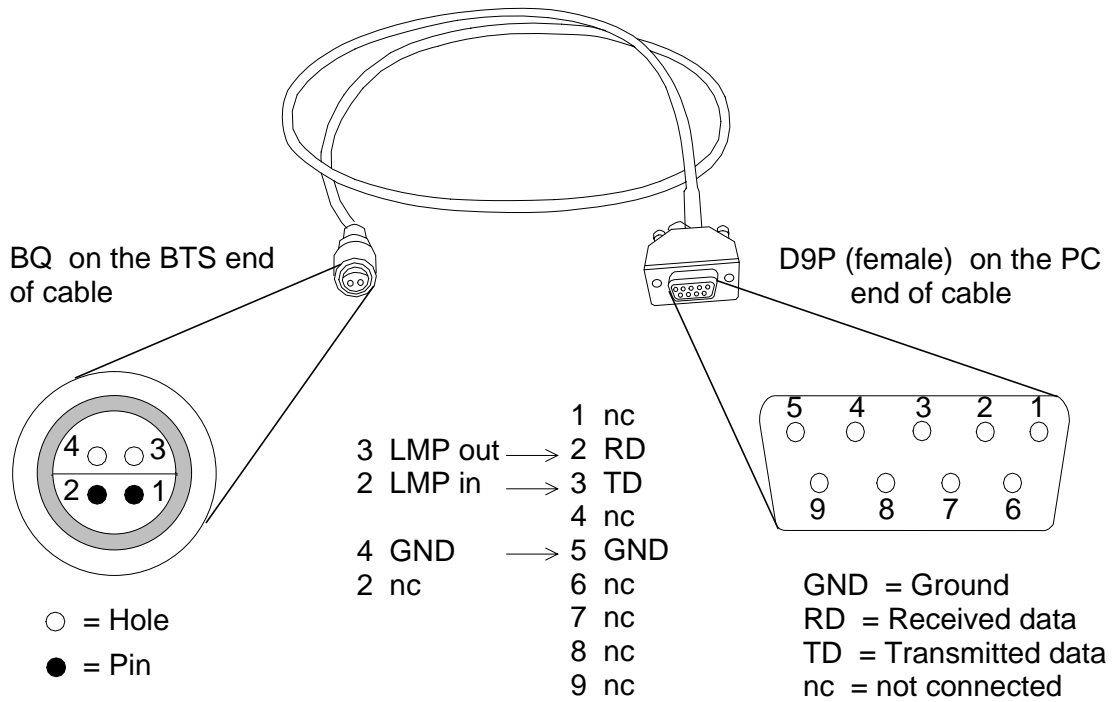

Figure 10. LMP cable connectors

