

## **EXHIBIT 3**

# **INSTALLATION and OPERATIONAL MANUAL**

**EXHIBIT 3**

**SECTION 2.1033(c) (3)**

A copy of the installation and operating instructions to be furnished the user. A draft copy of the instructions may be submitted if the actual document is not available. The actual document shall be furnished to FCC when it becomes available.

RESPONSE: There is not a specific instruction book for the ICLA.

A copy of Operation, Administration and Maintenance manual for the FLEXENT ® Land Station Cellular system using Code Division Multiple Access (CDMA) technology is included with this filing.



# **Flexent CDMA Microcell**

## **Operation, Administration, and Maintenance**

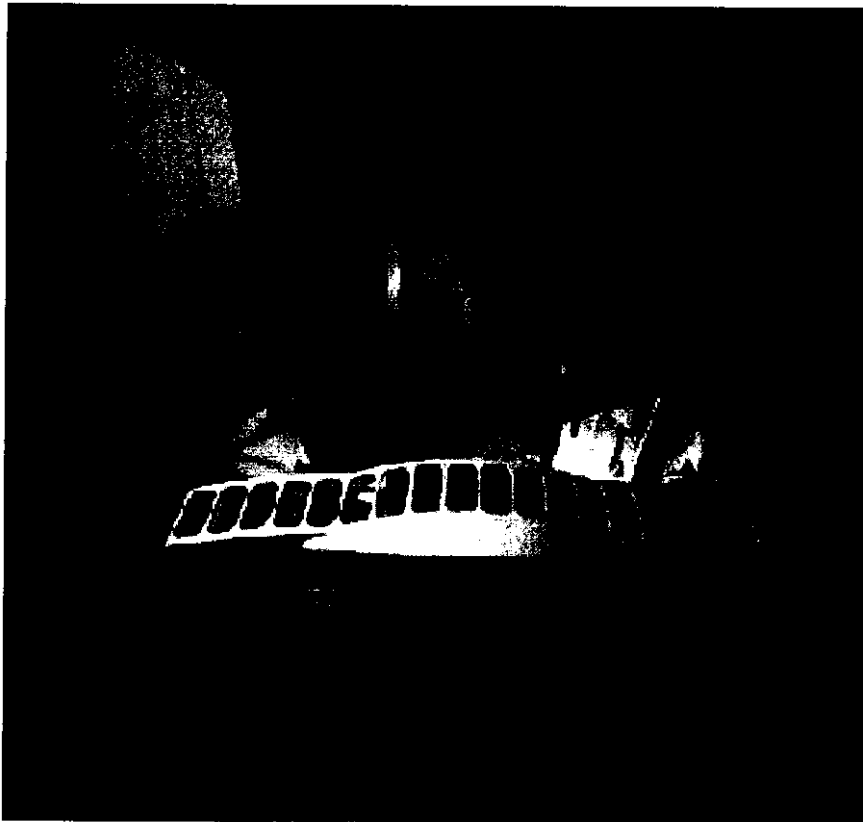

**Lucent Technologies — Proprietary**  
This document contains proprietary information of  
Lucent Technologies and is not to be disclosed or used  
except in accordance with applicable agreements

Copyright © 1998 Lucent Technologies  
Unpublished and Not for Publication  
All Rights Reserved

Issue 1.0 Draft  
November 1998  
**FOR INFORMATION  
ONLY**



This material is protected by the copyright and trade secret laws of the United States and other countries. It may not be reproduced, distributed or altered in any fashion by any entity (either internal or external to Lucent Technologies), except in accordance with applicable agreements, contracts or licensing, without the expressed written consent of the Customer Training and Information Products organization and the business management owner of the material.

For permission to reproduce or distribute please contact:

FLEXENT® Product Development Manager 1-800-334-0404

### **Notice**

Every effort was made to ensure that the information in this document was complete and accurate at the time of printing. However, that information is subject to change.

### **Trademarks**

FrameMaker is a registered trademark of Adobe Systems Inc.

UNIX is a registered trademark of Novell Inc.

FLEXENT and AUTOPLEX are registered trademarks of Lucent Technologies, Inc.

### **Support Telephone Number**

Lucent Technologies provides a telephone number for technical assistance support from the Wireless Technical Support Center (WTSC). The support number is:

1-800-225-4672

Developed by Lucent Technologies Customer Training and Information Products.

<b>1.</b>	<b>Introduction to <i>FLEXENT™</i> CDMA Microcell</b>	<b>1-1</b>
<b>2.</b>	<b>CDMA Microcell Hardware Description</b>	<b>2-1</b>
<b>3.</b>	<b>Microcell Interconnections</b>	<b>3-1</b>
	Microcell Functional View	3-2
	Microcell Physical Interconnections	3-9
<b>4.</b>	<b>Microcell User Interface</b>	<b>4-1</b>
	Microcell User Interfaces	4-4
	Primary Communication Method: The Remote Maintenance Terminal Interface	4-7
	Alternate Communication Method: Direct Access to the Switch through Status Display Pages Basics	4-10
	craft shellInterface and Read-Only Printer Basics	4-25
	RC/V Screens Basics	4-31
	Microcell Documentation	4-47
<b>5.</b>	<b>CDMA Microcell Maintenance</b>	<b>5-1</b>
	Operation and Maintenance Overview	5-4
	Routine (Preventive) Maintenance	5-9
	Corrective Maintenance	5-11
	Microcell Maintenance Principles	5-19
	Operation and Maintenance Task Hierarchy	5-32

---

<b>6. Diagnostics</b>	<b>6-1</b>
Fault Detection and Correction Mechanisms	6-3
Microcell Primary Mode for Diagnostics and Testing	6-9
Manual Routine Diagnostics -- Alternate Mode	6-15
Alarms	6-18
Cell Site Fault Detection and Recovery Tools	6-22

---

<b>7. Trouble Clearing</b>	<b>7-1</b>
Fault Isolation Strategy (For CTRM-equipped Microcells)	7-3
Performance Measurement Using the RMT	7-12
Performance Measurement Using the Alternate Method	7-13
Performance Measurements Using the Alternate Method	7-22

---

<b>Acronyms and Glossary</b>	<b>ACCRO-1</b>
------------------------------	----------------

# 1 Introduction to FLEXENT™ CDMA Microcell

## Introduction

**Objective of the Unit** The objective of this unit is to introduce the FLEXENT™ CDMA microcell. In particular, it is designed to enable the reader to:

- Learn about the different types of access schemes
- Learn about the relationship between microcell operating frequencies and transmission channels
- Introduce the microcell as the interface between the landline network and mobile terminals
- Describe the different microcell configurations

At the end of this unit, the reader should be able to:

- Find the frequency that corresponds to a specific CDMA transmission channel
- Identify the components of a Flexent CDMA microcell network
- Name the different Flexent CDMA microcell configurations

Details on microcell internal structure are provided in Unit 2. Details on the signal flow within a microcell are provided in Unit3.

<b>Content</b>	Introduction	1
	Introduction to CDMA	2
	CDMA Frequencies Assignments	4
	Detailed PCS Frequencies	8
	The CDMA microcell	10

# Introduction to CDMA

---

## Voice Traffic and Access Schemes

Access schemes are designed to increase voice traffic within an allocated frequency band.

### Code Division Multiple Access

Code Division Multiple Access (CDMA) is such an access scheme and is based on spread-spectrum technology. The current CDMA standard allows up to 61 simultaneous users in one 1.2288 MHz channel. Field conditions and performance requirements, such as the quality of the voice signal, contribute to keep the number of simultaneous users to below 40.

CDMA is implemented in two different frequency bands:

- PCS (Personal Communication Services), which corresponds to transmissions in the 1.8 GHz to 2.0 GHz band.
- Cellular, which corresponds to transmissions in the 850KHz band.

### Examples of other Access Schemes

Examples of other access schemes are as follows:

- Time Division Multiple Access (TDMA) divides a channel into six time slots. Present TDMA standard allocate two time slots per user, allowing three simultaneous users per 30 KHz channel.
- Frequency Division Multiple Access (FDMA) allows one user per 30 KHz channel.



**Graphic Representation  
of the Access Schemes**

When displayed on an appropriate monitor, the different access schemes are represented as shown in Figure 1-1. The waves in the CDMA diagram represent distinct communication channels.

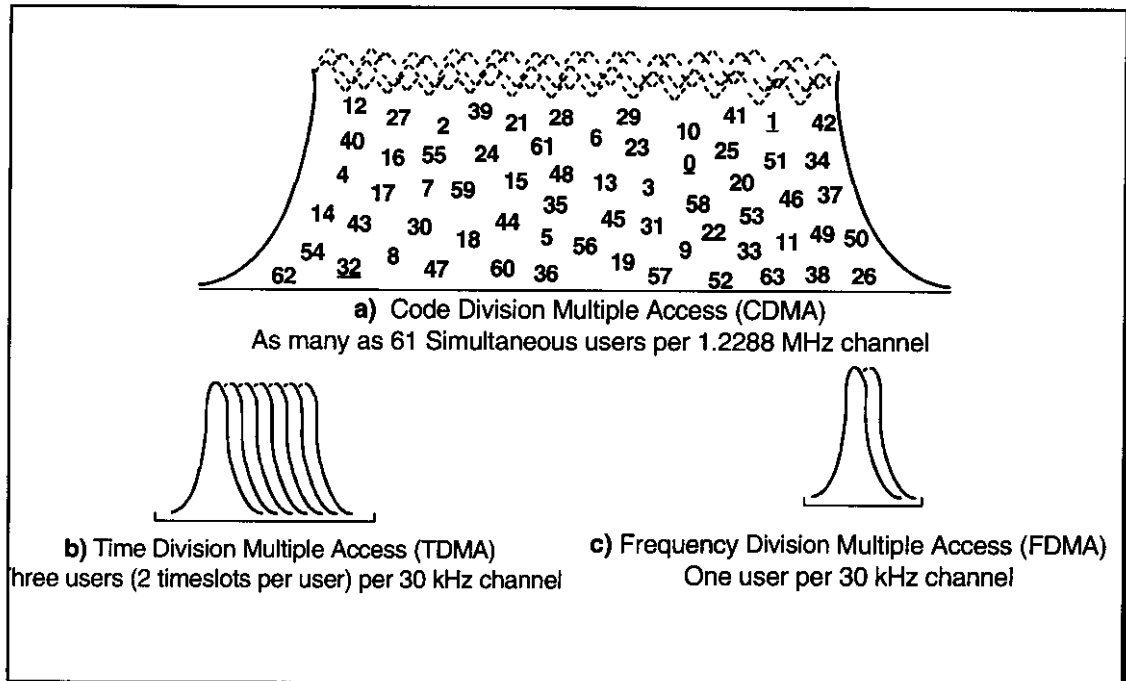

*Figure 1-1. Examples of Access Schemes*

# CDMA Frequencies Assignments

**Overview: CDMA Bands Spectrum**

The CDMA microcell is designed to operate in the PCS and Cellular frequency ranges.

**PCS Transmission**

The PCS part of the radio spectrum is divided into two groups, one for wireless signals transmitted by the microcell, the other for wireless signals received by the microcell. Each group contains six frequency blocks, labeled from A to F, as shown in Figure 1-2..

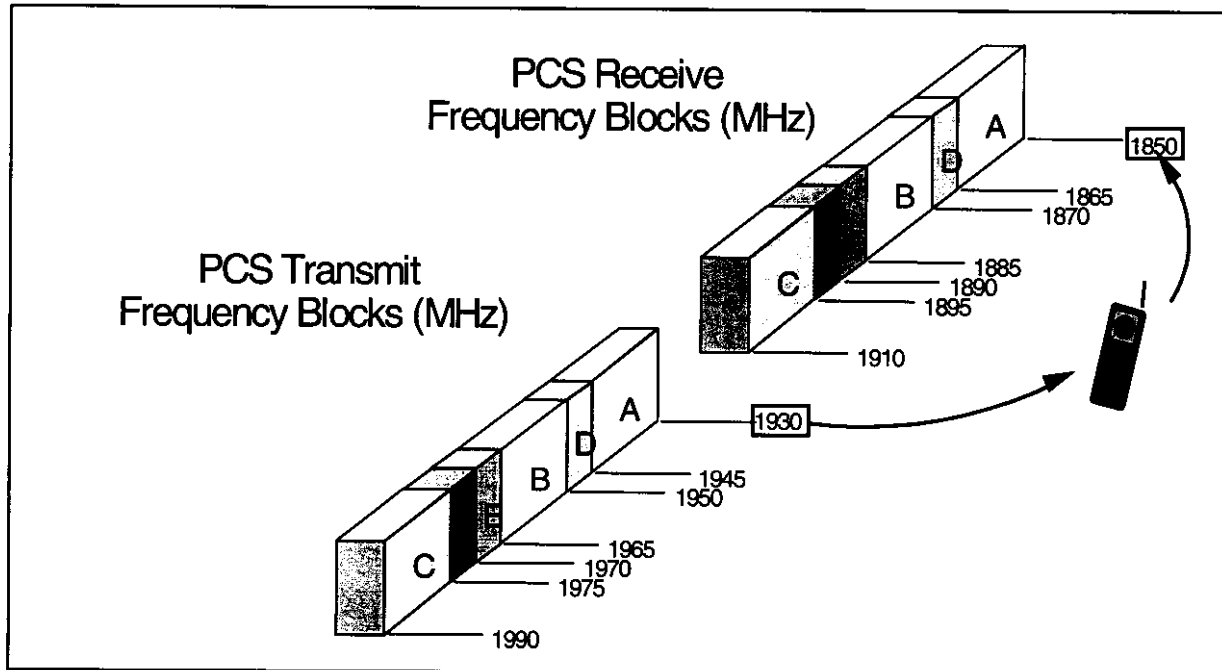

*Figure 1-2. Frequency Band Allocation*

**Transmission Channels**

Each group itself is divided into 1200, 50 KHz-wide channels, covering receive and transmit frequencies. These channels, allocated among the different blocks, are consecutively numbered within each group. For a given channel, the Receive Frequency is 80 MHz lower than the Transmit Frequency.

**PCS Channels Table**

The table shown in Figure 1-3. summarizes the range of channel numbers in the PCS bands. Not all channels are valid as per FCC

regulations. Lucent microcells are designed to operate on all valid channels.

PCS Channel Band	PCS CDMA Channel Numbers	Receive Frequency Range (MHz)	Transmit Frequency Range (MHz)
A	000-299	1850-1865	1930-1945
D	300-399	1865-1870	1945-1950
B	400-699	1870-1885	1950-1965
E	700-799	1885-1890	1965-1970
F	800-899	1890-1895	1970-1975
C	900-1199	1895-1910	1975-1990

**Figure 1-3. Receive/Transmit Band and Channel Assignment Table**

**Channel Assignment Formula**

Each channel is assigned a given frequency, according to the simple arithmetic formula given below.

$$\text{CCF} = \text{Channel Number} * 0.050\text{MHz} + \text{Lower Band Frequency}$$

\* stands for the multiplication sign

-- For a Transmit Channel, Lower Band Frequency is 1930 MHz

-- For a Receive Channel, Lower Band Frequency is 1850 MHz

**Channel Number vs. PCS Frequency Assignment Table**

Table shown in Figure 1-4. provides the range of channels and central frequencies corresponding to the channel assignment formula.

	Channel #	Center Frequency
	(N)	(MHz)
Microcell Receive	$1 \leq N \leq 1200$	$0.05N + 1850$
Microcell Transmit	$1 \leq N \leq 1200$	$0.05N + 1930$

*Figure 1-4. Range of Channel Numbers vs. Channel Frequencies*

**Computing Center Channel Frequency Examples**

The computation steps to find the frequencies of a handset that transmits and a microcell receives on Channel 335 are given in Table 1-1.

*Table 1-1. Example of Channel Assignment Computing*

Step	Operation	Example
1	Take channel number	335
2	Multiply by Constant	0.05 MHz
3	Equals	16.75 MHz
4	Add Lower value for Receive	1850.000 MHz
5	Add Lower value for Transmit	1866.750 MHz

**Valid Frequencies**

Not all frequencies are valid within the PCS spectrum. Available frequencies are shown in Table 1-2.

Table 1-2. Valid PCS Frequencies

Block Designator	Valid CDMA Frequency Assignment	CDMA Channel Number	Receive Frequencies (MHz)	Transmit Frequencies (MHz)
A	Valid	25-275	1851.250-1863.750	1931.250-1943.750
D	Valid	325-375	1866.250-1868.750	1946.250-1948.750
B	Valid	425-675	1871.250-1883.750	1951.250-1963.750
E	Valid	725-775	1886.250-1888.750	1966.250-1968.750
F	Valid	825-875	1891.250-1893.750	1971.250-1973.750
C	Valid	925-1175	1896.250-1808.750	1976.250-1988.750
A	Valid	25-275	1851.250-1863.750	1931.250-1943.750
D	Valid	325-375	1866.250-1868.750	1946.250-1948.750

**Cellular Transmission** The cellular band is divided into two groups of 25MHz each, corresponding to receive and transmit frequencies. A block of 20MHz is left between the two groups for other wireless services. The two groups are shown in Figure 1-5. Receive frequencies begin at 824 MHz, and Transmit frequencies at 869 MHz.

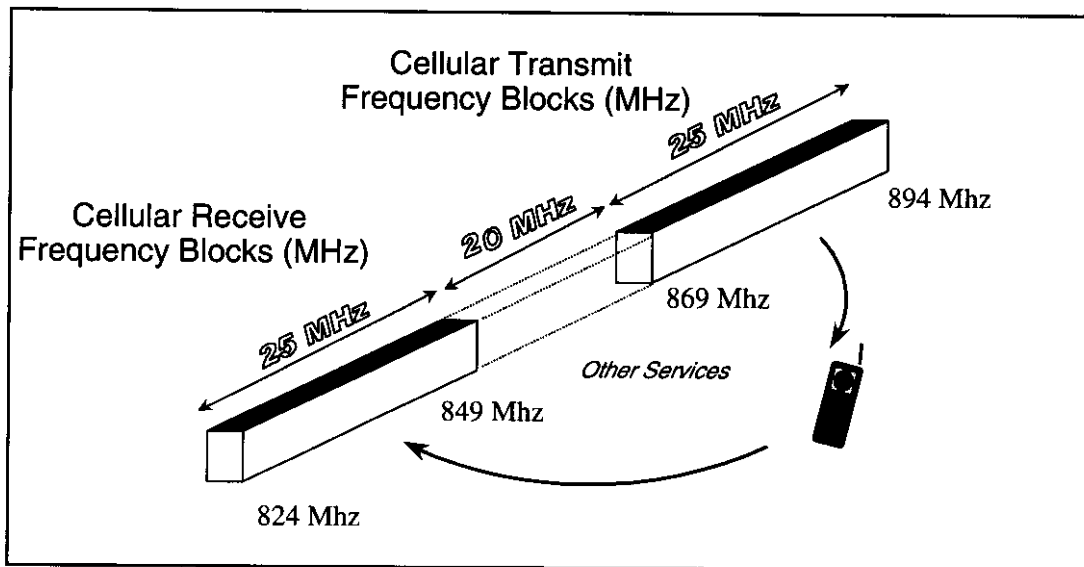

Figure 1-5. Cellular Spectrum

**Transmission Channels**

Each group of frequencies is subdivided into two blocks, A and B, each containing 416 channels. Each channel is 30 KHz-wide, with a 30 KHz gap between channels.

## The CDMA Microcell

---

- Overview** The microcell is the network element responsible for the operation of the air interface to a Mobile Terminal (MT). Its position in the network is shown in Figure 1-6..
- Transmit Power Option** Nominal transmit power is set at 8 Watt
- Cell Environment** Microcells are designed to operate without requiring cooling fans. Fans can be configured for cells running under extreme environmental conditions.
- Structure of the Microcell Network** The Mobile Switching Center contains a 5ESS Digital Cellular Switch (DCS), which provides interface with the land lines, and an Executive Cellular Processor (ECP), which controls the wireless network. In addition, a High Availability Operation Management Platform (HA-OMP) performs interface functions for the ECP. Microcells are connected via DS1 facilities to the DCS. Control information to the microcell come from a Radio Cluster Server (RCS) through signaling DS0 channels. These channels are groomed from the DS1 facilities and routed through the 5ESS Switch.

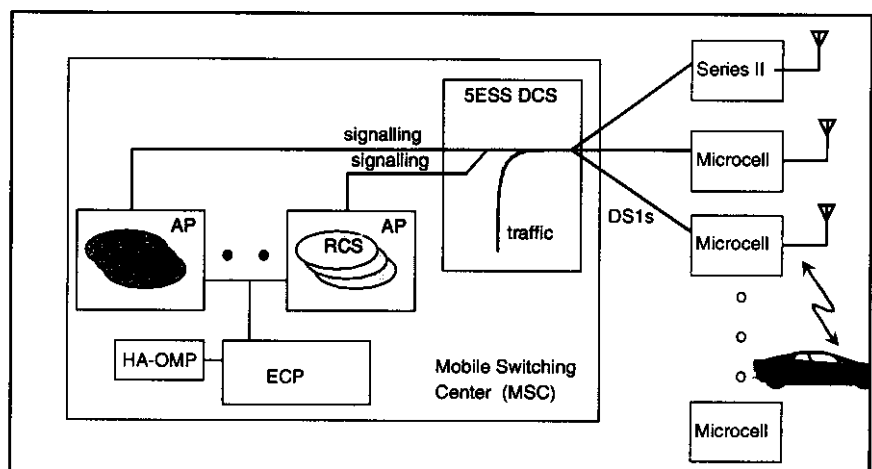

**Figure 1-6. Network View of the CDMA Microcell**

### Radio Cluster Servers, Application Processors, and Cell Sites

Two components are essential to the operation of a microcell:

- Radio Cluster Server (RCS) - located at the MSC
- Cell Site - the combination of a microcell and Antenna Subsystem.

RCSs are application instances that run on Application Processors (APs). APs are high performance general computer nodes located at the MSC that can simultaneously execute several RCS application instances.

#### **Optional BackUp RCS/AP**

A second RCS/AP may be used for backup to the first RCS/AP. If used, this backup will communicate via a second signaling DS0. An RCS may control up to six microcells.

**Functions** Each of the network elements (RCS and microcells) supports a specific function, which are outlined below:

#### **RCS**

The RCS provides coordination and control of the individual Cell Sites associated with it.

#### **CDMA Microcell**

The CDMA microcell provides radio functionality for a geographical area, which can be served by an omni-directional antenna system or a multi-sector antenna system. One microcell serves one sector or one OMNI antenna system.

- In the forward direction, the microcell performs the following in that order:
  1. channel coding
  2. modulation
  3. Radio Frequency (RF) upconversion
  4. RF amplification
  5. transmission of the traffic over-the-air to the Mobile Terminal (MT) according to the parameters sent down from the RCS
- In the reverse direction the microcell performs the following in that order:
  1. receives the traffic from the MT
  2. demodulates the traffic signal
  3. decodes the traffic signal
  4. sends the traffic signal to the DCS



**Microcell Configurations  
Options**

Microcells can be configured either as single-sector carrier microcells, or as several microcells connected in a daisy-chain configuration.

The microcell is designed to support different topologies, frequencies, power, antenna, and environment configurations.

**Topology**

Microcell topology is either stand-alone or daisy-chained.

- In a stand-alone topology, a DS1 line supplies signaling to a single microcell.
- In a daisy-chain topology, microcells use a single T1/E1 with a shared signaling channel. This allows for more efficient use of the transmission facilities. Up to three microcells may be served by the same T1/E1.

**Antenna Configurations**

The microcell is primarily intended for use with two CDMA antennas (one duplex Rx/Tx and one diversity Rx) and one GPS antenna, through simplex antennas configurations (one Tx and two Rx antennas) are also supported. .

These antennas may be mounted directly to the microcell, mounted remotely and cabled to the microcell, or the CDMA antennas may be integrated within the front panel of the microcell. Antenna geometry is chosen to avoid excessive coupling between the different antennas.

**Daisy-Chaining**

The microcells in a daisy-chain can either be individual OMNI cells, or several microcells, each providing a directional antenna system. In the latter case, a three-sector cell site can be constructed by connecting three microcells in a daisy-chain configuration, where each microcell supports a sector via a 120-degree antenna system.

Daisy-chaining might be used in installations where the microcells are closely located, such as a three-sector configuration of microcells, or where the microcells are used for in-building distribution where there would be several cell sites located within the same building.

Microcells operating in a daisy-chain can be classified into a number of configurations:

- Collocated, such as when the microcells are mounted on the same pole to provide three-sector coverage. Here the separation is on the order of 10 feet.

- Local, such as when the microcells are mounted on a rooftop, also providing three sector coverage. Here the separation is on the order of 100 feet.
- Remote, such as when the microcells are chained to multiple locations within a building. Here the separation may be on the order of 500-1000 feet.

A diagram of possible configurations is shown in Figure 1-7.

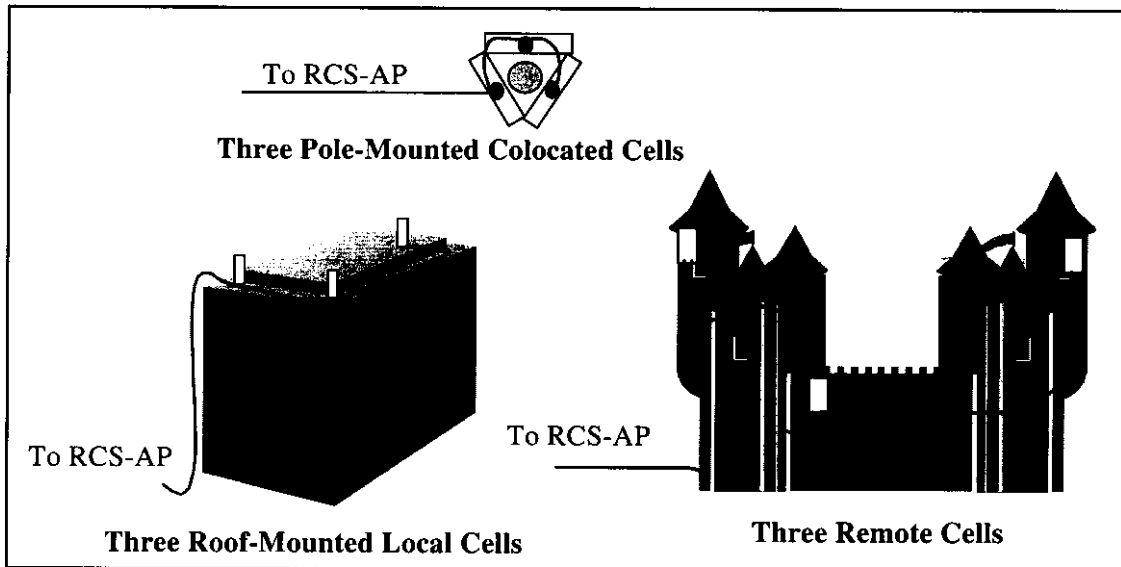

**Figure 1-7. Examples of Daisy-Chain Configurations**

**Daisy-Chain Capacity**

In a daisy-chain application, the signaling links for all microcells in the chain are carried on a single DS0.

In a T1 environment, a second DS0 is reserved as a signaling backup, which leaves 22 DS0s for supplying packet pipes to the microcells.

In an E1 environment, a second DS0 is reserved for signaling backup, and one is used for sync, leaving 29 DS0s for supplying packet pipes to the microcells.

**Packet Pipes and Microcells**

The DCS places the control messages onto one DS0 of the DS1 connected to the microcell; it routes coded speech traffic from a packet handler within the DCS onto the same DS1.

Each DS1 facility that connects to a cell site has sets of DS0 channels defined as packet pipes.

These packet pipes carry voice traffic to and from the air interfaces provided at the cell site.

**Channel Elements**

A CE contains the circuitry necessary to support a full duplex CDMA channel (i.e., to perform forward link and reverse link CDMA spread-spectrum processing). Each CE supports one CDMA channel. A CE is capable of performing the modulation/demodulation of a single CDMA channel or, in some cases, more than one channel.

Each CE can be assigned to perform one or more of the following functions:

- Pilot Channel functions, which enable the CDMA mobile to establish communication with the microcell.
- Sync Channel functions, which are used by the mobile to acquire initial time synchronization.
- Paging Channel functions, which are used by the microcell to transmit system overhead information and pages to the mobile.
- Access Channel functions, reverse of the Paging Channel, which are used to receive various types of messages from the mobile.
- Traffic (User) Channel functions, which carry voice communication.

The pilot, sync, and access functions can be combined with other functions into a single CE. This combination defines a CE "personality".





# 2 CDMA Microcell Hardware Description

## Introduction

**Objectives of this Unit** The objective of this unit is to describe the physical structure of a CDMA microcell. At the end of this unit, the reader should be able to do the following:

- List the components of a CDMA microcell
- Identify the functionality of these components

<b>Content</b>	• CDMA microcell Hardware Architecture Overview	2
	• Microcell Components	3
	• Microcell Hardware -- CRC	5
	• CSU	8
	• Microcell Components -- CCU-20	9
	• Microcell Components -- CBR	11
	• Microcell Components -- Transmit Amplifier	14
	• Microcell Components -- Bandpass Filter Assembly	15
	• Low Noise Amplifier Module	16
	• Oscillator Module	17
	• Input/Output Module	18
	• Microcell Component -- Antennas	19
	• Microcell Component -- CDMA Test Radio Module	20
	• Microcell Components -- Time Frequency Unit	21

- Microcell Component -- Power Converter Unit 23
- Ancillary Cell Site Components 24
- Remote Maintenance Terminal (RMT) 26

## CDMA Microcell Hardware Architecture Overview

---

### **Microcell Functionality**

The microcell performs the following functions:

- Interfaces to the RCS over a T1/E1 line
- Supports 20 or 40 CDMA channel elements (two are used for overhead channels and the remainder are used for traffic channels)
- Provides one sector of RF coverage

# Microcell Components

**Overview** The components of a CDMA microcell are depicted in Figure 2-1.

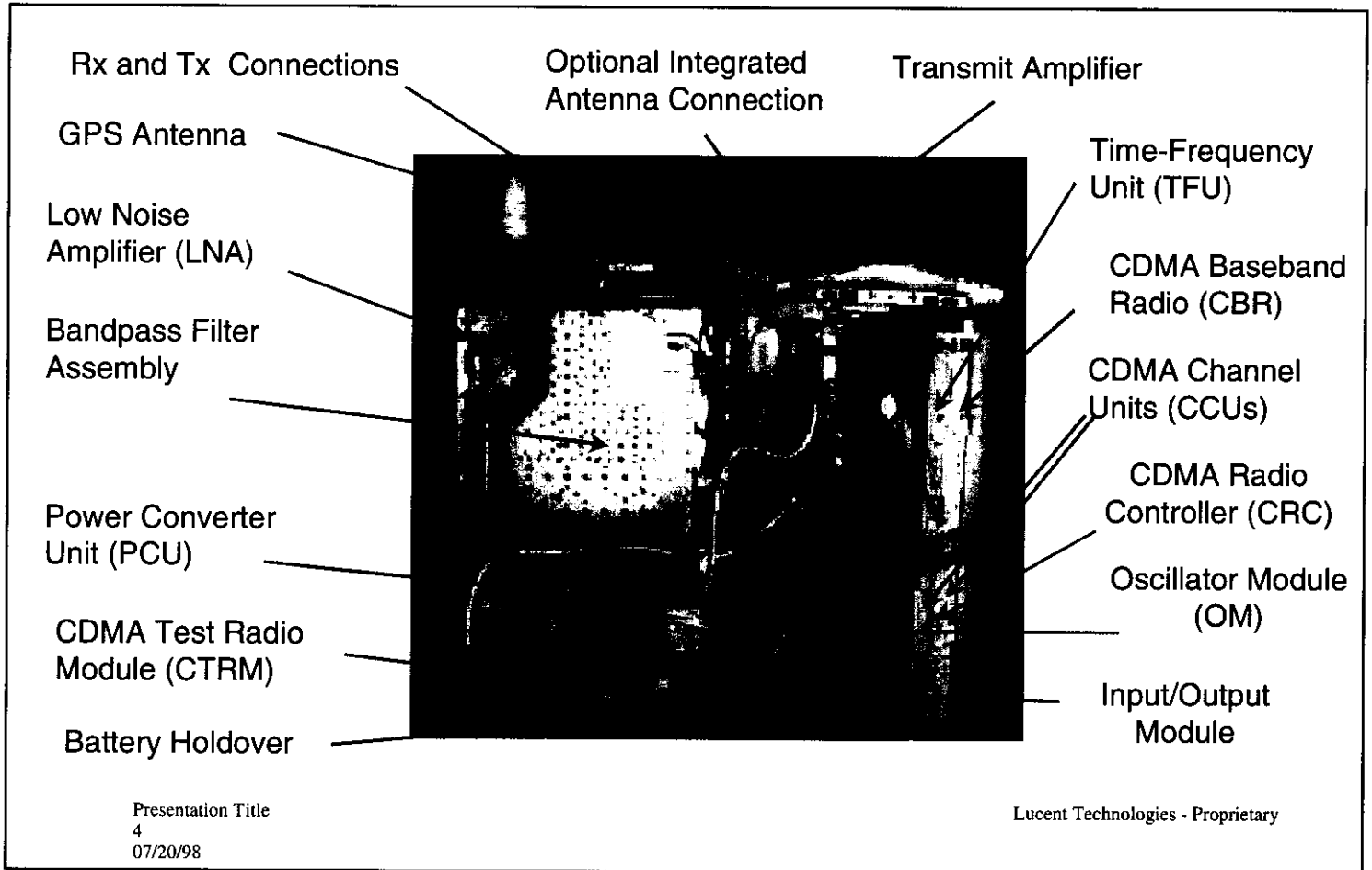

**Figure 2-1. CDMA Microcell Components**



**CDMA Microcell Details** A CDMA microcell includes the following components:

<b>Component</b>	<b>Function</b>
CDMA Radio Controller (CRC),	Responsible for controlling the microcell and interfacing the T1 or E1 facilities to the microcell.
20-Channel Elements CDMA Channel Units (CCU-20)	Perform all baseband signal processing necessary to originate the forward baseband signal and to terminate the reverse baseband signal. Up to 2 CCUs can be accommodated by a microcell
CDMA Baseband Radio (CBR)	Receives the digitally combined baseband forward signal from the CCU-20s and converts it to a low power level modulated RF signal.s:
CDMA Amplifiers	There microcell supports two amplifiers: <ul style="list-style-type: none"> <li>• Transmit RF amplifier that amplifies the RF signal from the CBR up to the required power level.</li> <li>• Low Noise Amplifier (LNA) in the receive path that amplifies the received RF signal from the Mobile Station (MS).</li> </ul>
Filters and test couplers	Ensure that the RF signal conforms to the spectral limits described in the appropriate standards, and allow the RF path to be tested.
Time/Frequency Unit (TFU)	Provides the reference frequency and CDMA clocks used by the CBRs and CCUs, and contains a GPS unit to provide CDMA network synchronization.
Oscillator Module (OM)	Provides an ovenized oscillator reference to the TFU.
CDMA Test Radio Module (CTRM)	Optional device that allows the customer to perform on-line testing of the functionality of the traffic and overhead channels.
Power supply	Converts AC power to the DC voltages needed by the cell equipment.

## Microcell Hardware -- CRC

---

**Overview** The CDMA Radio Complex (CRC) performs the following functions:

- Is the cell controller
- Provides termination to the T1/ E1 lines
- Maintains the cell file system.

**Structure of the CRC** The CRC is a circuit pack located inside the lower part of the microcell door, as shown in Figure 2-2.

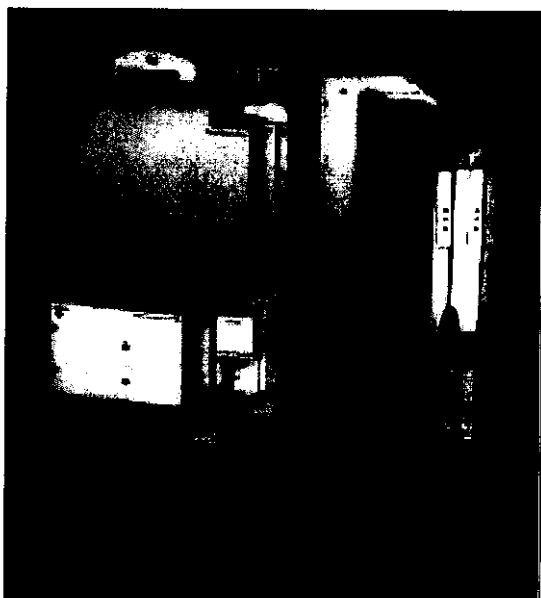

- **Functions**
  - Is the Cell Controller
  - Terminates T1/E1
  - Stores cell NVM files
  - Supports two Channel Service Units (CSU) chips
  - Supports the Ethernet Maintenance Port and Voice Interface Module
- **LED Indicators**

11 LEDs:

  - One set of three for board status
  - 2 sets of four (one set for each T1/E1 line) for cell status

*Figure 2-2. CDMA Radio Complex*

**Additional CRC Functions** The CRC also supports the following components and functions:

### Channel Service Unit (CSU)

The CRC supports up to two CSU chips that provide connectivity with the T1/E1 line(s) and enable loopback testing. Each CSU supports one T1/E1 line.

**Ethernet Maintenance Port**

The CRC drives an Ethernet port which serves as the cell maintenance port to be used by the technician when connecting to the cell for diagnostics. The connection is 10BaseT (10 Mbps, twisted pair) terminating in an RJ-45 jack.

**Voice Interface Support**

The CRC is responsible for detecting the off-hook/on-hook state of the cell voice interface (craft POTS line). Upon detecting this change of state, the CRC software will instruct the communications processor to patch the voice data onto the allocated T1/E1 DS0 for transmission to the MSC.

**Control of T1/E1 Bypass Relay**

The CRC controls the bypass relay used to allow a daisy-chained DS1 line to bypass an inoperable cell. When the cell initializes and the communications processor is ready to participate in the daisy-chain, the CRC sets a signal line which activates (opens) the bypass relay and splices the microcell into the daisy-chain. This relay closes under the following conditions:

- Microcell power fails or is otherwise off.
- CRC is pulled out of the microcell backplane.
- CRC detects a failure in the communications processor which is interrupting the data flow to other cells in the daisy chain (dependent on recovery software actions).
- CRC otherwise fails such that the board executes a hardware reset (the initial state of the bypass relay control line is deenergized; that is, the relay is closed).

The microcell does not support redundant T1/E1 facilities; this would require that the bypass relay be removed to prevent looping these two lines together.

**CDMA Clock Detection**

The CRC is responsible for monitoring the CDMA clocks generated by the TFU and for reporting an alarm to the RCS when a failure is detected. The two 19.6608-MHz and the EvenSecTic signals are monitored.

**LED Indicators**

The CRC incorporates eleven LEDs grouped into the following categories:

1. Three board status LEDs:
  - A red LED to indicate a failure
  - A yellow LED to indicate an NVM update in progress
  - A green LED to indicate that the CRC is operational
2. Two sets of four red LEDs (one set for each T1/E1 line) to indicate the status of the received signal:
  - Loss of signal
  - Loss of frame alignment
  - Excessive error rate
  - Receiving Alarm Indication Signal

## Microcell Components -- CCU-20

---

**Overview** The microcell supports up to two CCU-20s, each CCU-20 containing 20 Channel Elements (CEs). The CE-20s provide the channel coding and decoding function for a total of up to 40 channels. These channels consist of a mix of 38 traffic channels (18 if there is only one CCU-20 in the microcell), and 2 overhead channels (pilot/ synchronization/ access and paging).

The channel coding is carried out within ASICs, where each ASIC handles one channel (both forward and reverse directions). The CEs communicate their traffic information to the CRC for transfer to the 5ESS via the T1/E1 facility; they exchange OA&M information, such as initialization and status, with the cell site's OA&M process running on the CRC.

**Channel Elements** A CE contains the circuitry necessary to support a full duplex CDMA channel, i.e., to perform forward link and reverse link CDMA spread-spectrum processing. Each CE supports one CDMA channel. A CE is capable of performing the modulation/demodulation of one CDMA channel or, in some cases, more than one channel.

Each CE can be assigned to perform one or more of the following functions:

- Pilot Channel functions, which enable the CDMA mobile to establish communication with the microcell.
- Sync Channel functions, which are used by the mobile to acquire initial time synchronization.
- Paging Channel functions, which are used by the microcell to transmit system overhead information and pages to the mobile.
- Access Channel functions, reverse of the Paging Channel, which are used to receive various types of messages from the mobile.
- Traffic (User) Channel functions, which carry voice communication.

The pilot, sync, and access functions can be combined with other functions into a single CE. This combination defines a CE "personality".

**Structure of the CCU-20** The microcell supports two CCU-20s. These circuit packs, shown in Figure 2-3., are located inside the door of the microcell.



- **Functions**
  - Supports twenty CEs
  - Supports daisy-chaining of CCU-20
- **LED Indicators**
  - Three front panel LEDs :
  - Green: The CCU-20 is functioning and at least one CE has a software personality enabled.
  - Yellow: The CCU-20 is performing an NVM update.
  - Red: The CCU-20 has failed diagnostics.

The CCU-20 may have both red and green LEDs illuminated if only a subset of the CEs have failed.

*Figure 2-3. A CCU-20*

**Features** The features of the CCU-20 include the following:

- Supports twenty CEs
- Supports daisy-chaining of CCU-20 transmit paths

The latter feature allows transmit data from multiple CCU-20s to be combined into one transmit signal.

**Indicator LEDs** The CCU-20 has three front panel LEDs to indicate the conditions shown in :

<b>LED Color</b>	<b>Meaning</b>
Green	The CCU-20 is functioning and at least one CE has a software personality enabled.
Yellow	The CCU-20 is performing an NVM update.
Red	The CCU-20 has failed diagnostics (BLST or software diagnostics), one or more CEs have failed to initialize, or some other component on the CCU-20 has failed to initialize.

**Note** The CCU-20 may have both the red and green LEDs illuminated if only a subset of the CEs have failed.

## Microcell Components -- CBR

---

- Overview** The CBR performs the following functions:
- Baseband transmit combining and receive distribution, and provides the controller and NVM memory for the CBR.
  - Modulation and RF upconversion for the transmit path, as well as RF downconversion and demodulation for two (diversity) receive paths.

**Structure** The CBR is located against the top of the microcell door, as shown in Figure 2-4.



- **Functions**  
Performs
  - Baseband transmit combining and Receive distribution
  - Transmit Modulation and RF upconversion
  - Two diversity RF downconversion and demodulation
 Provides the controller and NVM memory for the CBR.
- **LED indicators**  
Three LEDs
  - Red indicates a failure within the CBR
  - Yellow indicates an NVM update in progress
  - Green indicates the CBR is operational and RF output is enabled (by both the front panel switch and software control).
 Note that all LEDs may be off if the unit is up without RF enabled

*Figure 2-4. The CDMA Baseband Radio*

- CBR Features** CBR features include the following:
- Tunable (under software control) to any allowed channel in the frequency band
  - Adjustable power to 30 dB of output, in 0.5 dB increments
  - Front panel RF power fine-tuning during cell setup



- Provision for RF test capabilities to assist in detecting and localizing RF failures

- Description** The CBR receives two 19.6608-MHz digital data streams from the CCU cluster which represent the following:
- If both CCU-20s are operating, the digitally combined transmit data for all CEs in both CCU-20s
  - If the first CCU-20 (i.e., the CCU adjacent to the CBR) has been bypassed, the digitally combined transmit data for all CEs in the second CCU-20.

#### **Bypass Control Mechanism**

A bypass control mechanism, which resides in the CBR, detects the status of the first CCU-20 in the CCU cluster. If the first CCU-20 should fail, the CBR will use that mechanism to bypass the failed CCU-20. This mechanism prevents the first CCU-20 from becoming a single point of failure for the CCU-20 cluster.

#### **Transmit Path**

Once within the CBR, the transmit stream is digitally filtered and converted to analog. This analog signal is then modulated onto an Intermediate Frequency (IF) carrier for further filtering, gain, and frequency upconversion.

#### **Receive Path**

In the receive direction there are two identical diversity receive units within the CBR. These units downconvert, filter, and perform Automatic Gain Control (AGC) on the two receive signals. These receive signals are passed to the CCU-20 cluster for decoding.

- Numbering Scheme** The CCU-20s are numbered according to their logical proximity to the CBR; thus, the CCU-20 connected directly to the CBR is numbered CCU-20/1, and the one connected to that is numbered CCU-20/2.

- Control of RF Power Output** The CBR has two controls on the front panel:
- A two-button switch which allows the CBR output power to be adjusted in the range +2 dB to -3 dB of nominal, in 0.1 dB increments. This is meant to allow for fine-tuning of cell output power at cell installation time.

- An AUTO/OFF switch which controls the transmit output of the CBR. Setting this switch to “OFF” results in the CBR output dropping to below -100 dBm (measured in a 30-KHz bandwidth). Setting the switch to “AUTO” will enable RF output from the CBR, although software must also enable transmission before RF power will be transmitted.

In addition to the front panel switch, the CBR turns off its RF power output whenever an RF-affecting error is detected.

If a parity error is detected on the transmit data from the CCU-20s the CBR will try to switch to the bypass input. If this still shows parity errors then the digital transmit stream will be set to zero, effectively turning off the transmitted RF power.

#### **Inventory and Diagnostic Information**

The CBR retains inventory information within its NVM.

#### **Indicator LEDs**

Front panel LED indicators give a visual indication of the status of the CBR. The CBR has the following LEDs:

- A red LED indicates a failure within the CBR.
- A yellow LED indicates an NVM update in progress.
- A green LED indicates the CBR is operational and RF output is enabled (by both the front panel switch and software control).

There is no front panel channel indicator on the CBR.

Note that all LEDs may be off if the unit is up without RF enabled.

## Microcell Components -- Transmit Amplifier

---

- Overview** The transmit path of the CDMA microcell includes an RF power amplifier. This amplifier increases the RF output power from the CBR to the output power called for by cell site specifications. The amplifier also compensates for path loss after the transmit amplifier.
- Structure** The Transmit Amplifier is located behind the duplex filter, as shown in Figure 2-5.

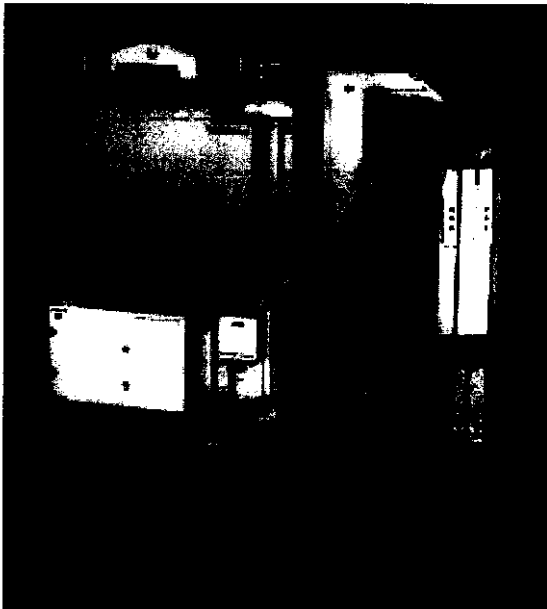

- **Function**
  - Brings CBR RF output to Microcell output specification
- **ED Indicators**

Two LEDs

  - Green indicates that DC power is present at the amplifier
  - Red indicates an amplifier failure.

*Figure 2-5. Transmit Amplifier*

- Alarm and NVM Update Interface** Transmit amplifiers communicate on the peripheral bus to transmit alarm indications and to receive NVM updates.
- Inventory and Calibration Information** The cellular transmit amplifier stores its inventory and calibration information in its internal NVM. There is no internal NVM in the PCS Transmit Amplifier.
- LED Indicators** The transmit amplifier has two LED indicators:

- A green LED which indicates that DC power is present at the amplifier
- A red LED which indicates an amplifier failure

## Microcell Components -- Bandpass Filter Assembly

---

**Overview** The microcell uses a duplex filter for the combined transmit/receive path, and a simplex receive filter for the diversity receive path.

The microcell also supports three antenna, full simplex (Tx/Rx0/Rx1) configurations.

**Structure of the Baseband Filter Assembly** The Bandpass Filter Assembly is located at the center of the microcell, as shown in Figure 2-6. The assembly includes duplex Tx/Rx0 and simplex Rx1 filters.

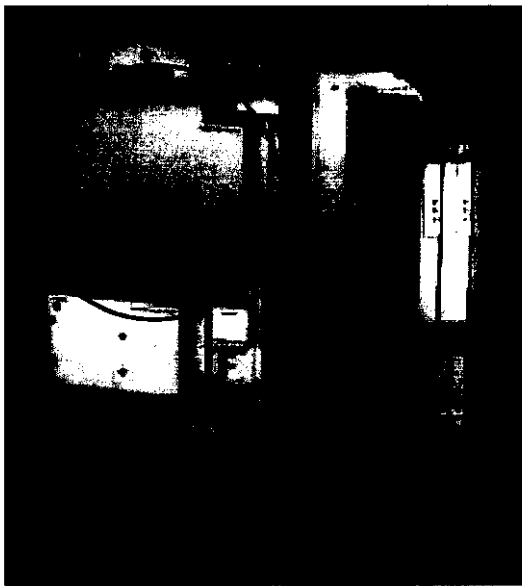

- Includes bandpass filters and bidirectional test coupler.

*Figure 2-6. Bandpass Filter Assembly*

**Description** The filter assemblies consist of bandpass filters and a bidirectional test coupler.

The duplex filter assembly has a total of two bandpass filters (one receive and one transmit), as well as a combiner and the test coupler.

The test coupler in the duplex filter assembly has a coupling loss of 30 dB in both forward (to antenna) and reflected (from antenna) directions.

## Low Noise Amplifier Module

---

**Overview** The Low Noise Amplifier Module (LNAM) is the very first stage of amplification of the received signals following the receive antennas.

The LNAM is composed of:

1. Bandpass filters for each of the Receive diversity 0 (RX0) and receive diversity 1 (RX1) paths
2. Low Noise Amplifiers (LNAs) that provide low-noise preamplification of signals received from each of the receive bandpass filters

**Structure of the LNAM** The LNAM is a stand-alone unit that is mounted on the left inside wall of the microcell enclosure, as shown in Figure 2-7.

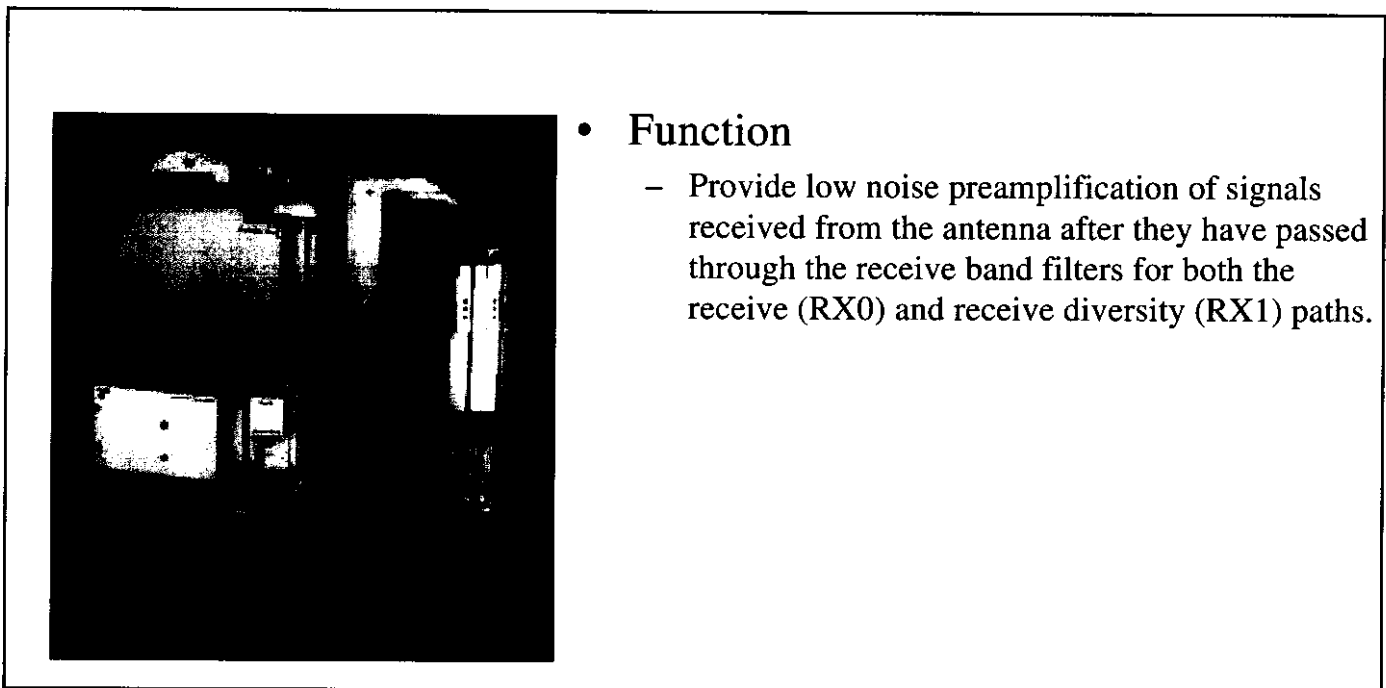

*Figure 2-7. Low Noise Amplifier Module*

**Description** On the LNAM, the LNAs and supporting circuitry are housed in a shielded metal enclosure. The external interfaces attached to the metal enclosure consist of four RF connectors and a 9-pin D-sub connector that bring power from the power supply and provide an interface connection for the current sense alarms.

## Oscillator Module

---

**Overview** The Oscillator Module (OM) provides a 15-Mhz reference to the microcell.

**Structure of the Oscillator Module** The OM is mounted inside the microcell and against its back wall as shown in Figure 2-8.

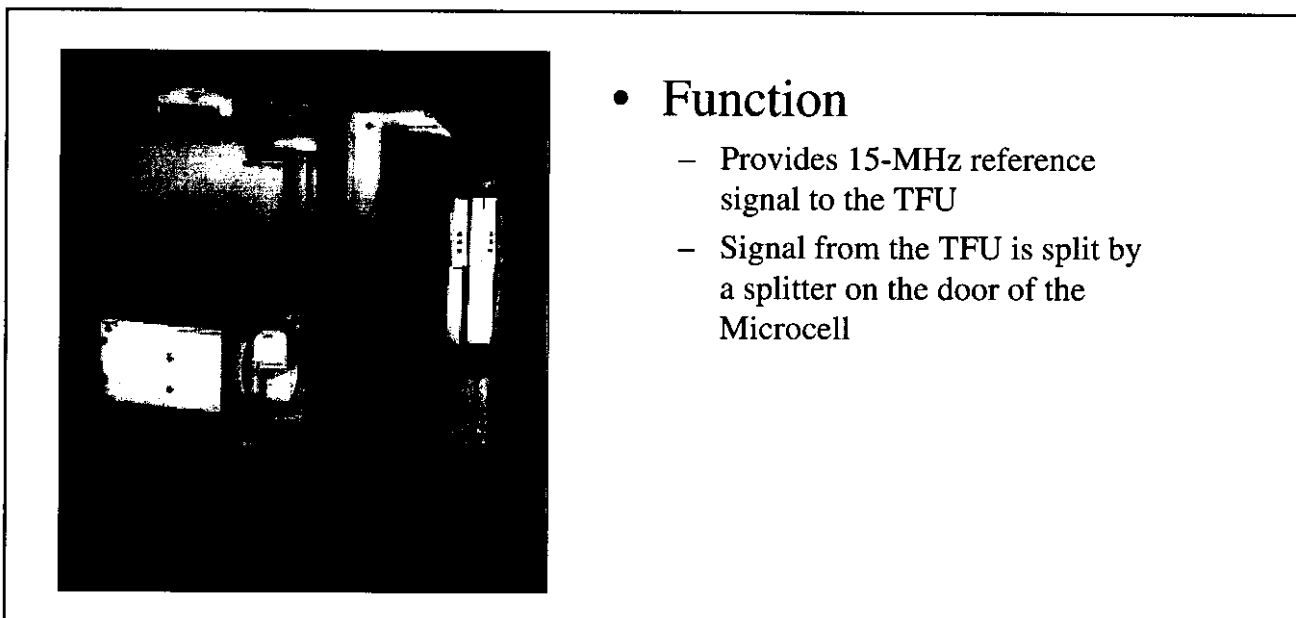

- **Function**

- Provides 15-MHz reference signal to the TFU
- Signal from the TFU is split by a splitter on the door of the Microcell

*Figure 2-8. Oscillator Module*

**Description** The OM is an ovenized crystal oscillator designed to provide a highly stable frequency reference.

The OM must operate under the following conditions:

- The OM must have a warm-up period of at least 25 minutes after it has been power cycled.
- The OM requires up to seven days of continuous operation before it can provide the stability needed for flywheeling.

As the OM ages, its frequency may drift. This is detected and corrected by the TFU. There is a finite amount of correction allowed; when this limit is exceeded the OM must be replaced.

## Input/Output Module

---

**Overview** The Input/Output Module (IOM) supports the following functions:

- Provides T1/E1 connectivity
- Provides maintenance port connections
- Protects the RF path against voltage spikes.

**Structure of the Input/  
Output Module**

The IOM is mounted in the lower right hand side of the inside the microcell on the enclosure, as shown in Figure 2-9.

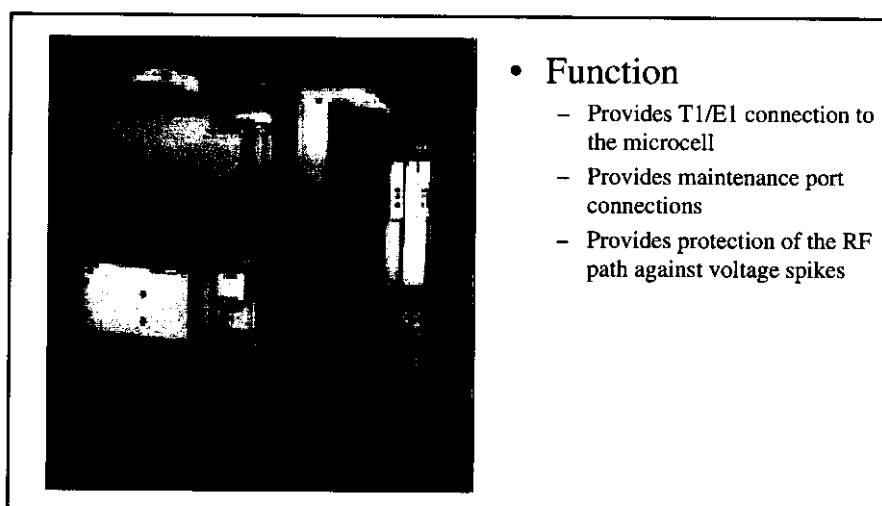

*Figure 2-9. Input/Output Module*

**Description** Connections to the IOM are made from underneath the unit. Accessing these connections requires removal of the cover that protects the backup battery.



## Microcell Component -- Antennas

---

**Overview** The microcell uses two or three RF antennas and one GPS antenna. In the two antenna configuration, one RF antenna is a duplex antenna for combination transmit and receive; the other is a simplex receive antenna for diversity reception.

**Structure of the Antennas** These antennas may be mounted externally to the cabinet or integrated with the microcell housing (integral antenna) as shown in Figure 2-10.

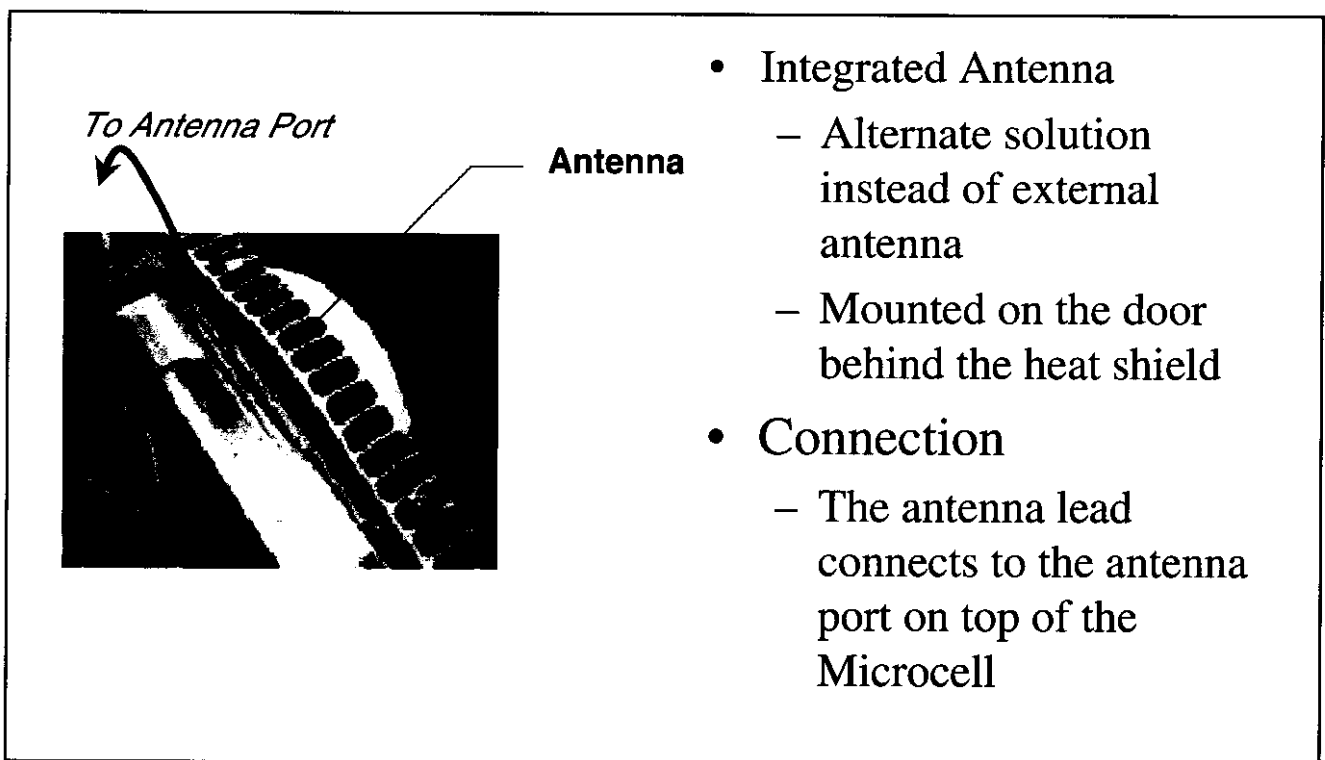

*Figure 2-10. CDMA Minicell Antennas*

**Description** The antenna leads are surge-protected to prevent damage to internal components from lightning strikes.

All antennas have a 50-Ohm impedance.

## Microcell Component -- CDMA Test Radio Module

---

**Overview** The CDMA Test Radio Module acts as a mobile station that can be controlled by the cell to test and verify cell operation.

**Structure** The CTRM is located on the bottom left of the microcell as shown in Figure 2-11.

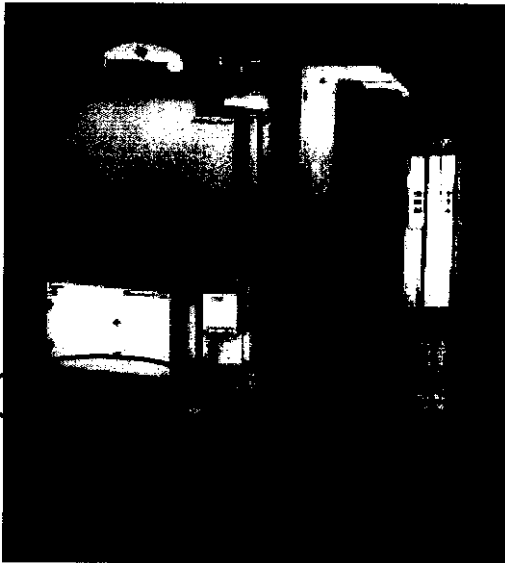

- **Function**
  - The CDMA Test Radio Module acts as a mobile station that can be controlled by the cell to test and verify cell operation
- **Operation**
  - Testing with the CTRM is accomplished by instructing the CTRM to place test calls to the Microcell.

*Figure 2-11. CDMA Test Radio Module*

**Description** Testing with the CTRM is accomplished by instructing the CTRM to place test calls to the microcell.

RF switches within the CTRM control which cell RF path the CTRM is connected to.

## Microcell Components -- Time Frequency Unit

---

**Overview** The Time Frequency Unit (TFU) is the frequency reference and CDMA timebase unit that synchronizes the microcell with the other basestations in the CDMA network.

Synchronization of the CDMA network enables the mobile stations to track several base stations at once, and to execute a soft handoff between basestations.

Synchronization is accomplished by retrieving time signals from the Navstar Global Positioning System satellites and using them to synchronize the time signals that are distributed to the CEs for use in channel coding. The TFU controls the OM and disciplines it to maintain 15-MHz signals.

**Description** The TFU is located on the upper layer inside the door of the microcell, as shown in Figure 2-12.

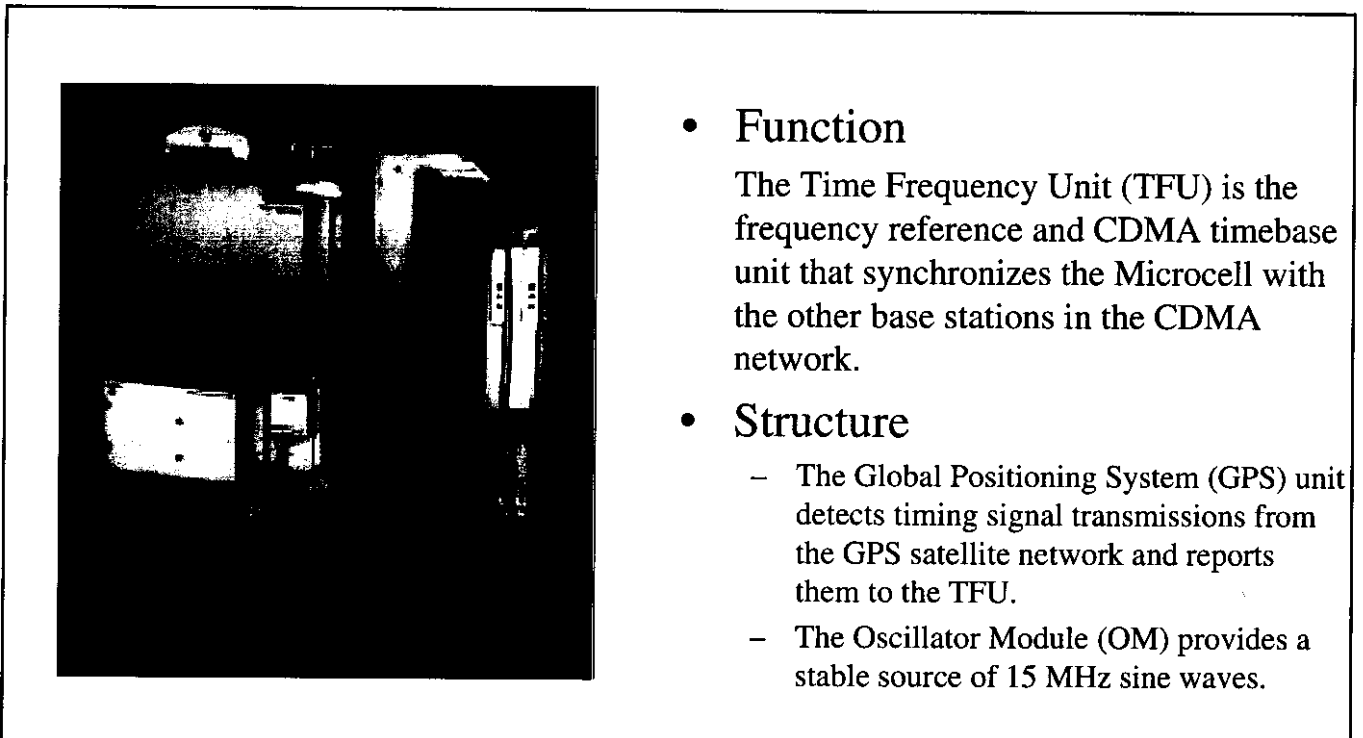

*Figure 2-12. Time Frequency Unit*

**TFU Structure** The TFU uses two reference sources:

- The Global Positioning System (GPS) unit detects timing signal transmissions from the GPS satellite network and reports them to the TFU.
- The Oscillator Module (OM) provides a stable source of 15-MHz sine waves.

**Description** The TFU provides the following signals:

- An Even Second Tick (EvenSecTic), which is a pulse every two seconds, coordinated with CDMA System Time (CST). The 19.6608-MHz signals are phase locked with this signal.
- The CST, which is an ASCII string giving the number of seconds, uncorrected for leap seconds, since January 6, 1980, 00:00:00 UTC. This time string is coordinated with the next EvenSecTic.
- A 10-MHz sine wave, phase-locked to the 15-MHz frequency reference, for phase-locking test equipment to the cell.

#### **Flywheeling**

The TFU generates highly accurate CDMA timing signals (EvenSecTic, 19.6608-MHz, 15-MHz) by disciplining its clock generation unit with time signals from the GPS unit. During periods when contact with the satellites is lost, the 15-MHz OM is stable enough to maintain the necessary synchronization with the network for up to eight hours.

The TFU is said to be flywheeling during that period. Once the GPS satellites are re-acquired, the TFU corrects any deviation from CST which the cell may have developed while flywheeling.

## Microcell Component -- Power Converter Unit

---

**Overview** The Power Converter Unit (PCU) converts supplied AC voltage to DC at several voltage levels.

**Structure** The Power Converter Unit is placed inside the backwall of the microcell, as shown in Figure 2-13.

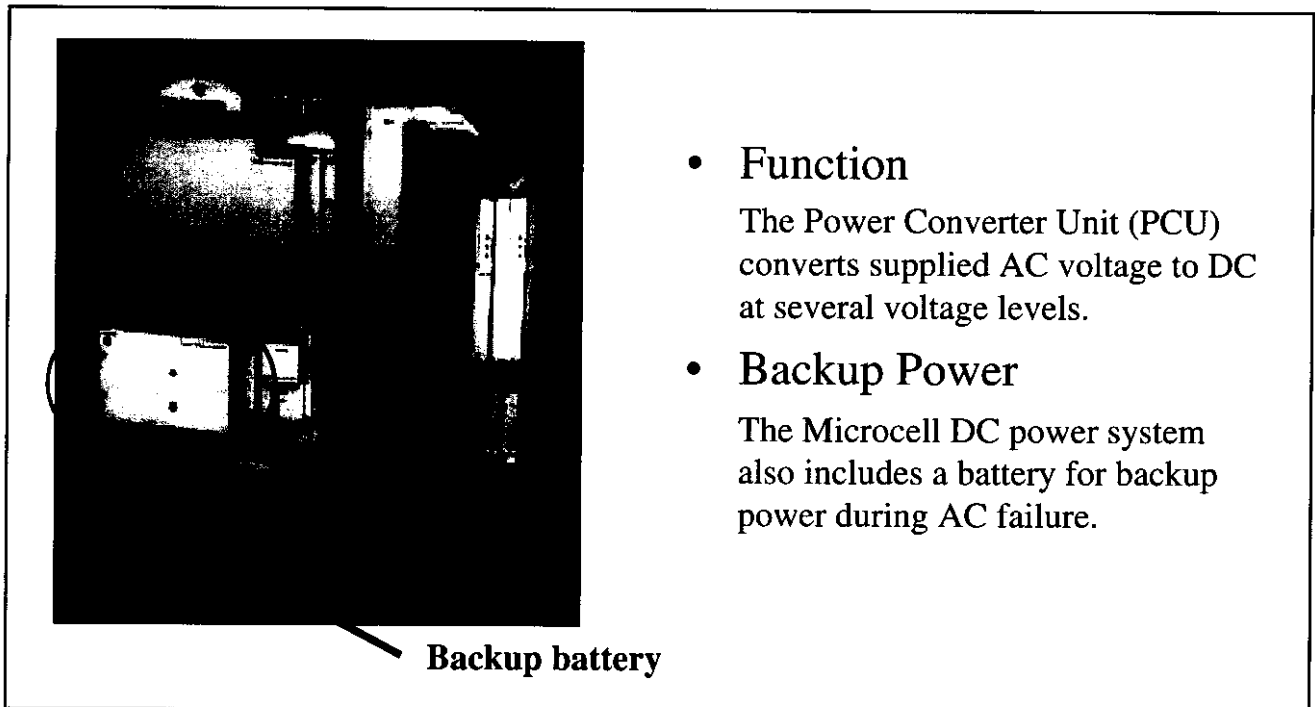

*Figure 2-13. Power Converter Unit*

**Backup Power** The microcell DC power system also includes a battery for backup power during AC failure. This battery supplies current for the low power cell for up to one minute to cover brief AC outages or voltage dips. The battery is recharged and monitored by the PCU.

# Ancillary Cell Site Components

**Overview** The microcell is essentially a stand-alone unit, but there will usually be some external equipment found at the cell site.

**Common Ancillary Equipment** Figure 2-14. shows one example of a configuration which may be at a CDMA microcell site. In this example, the microcell is supplied with DC current from a co-located DC power system.

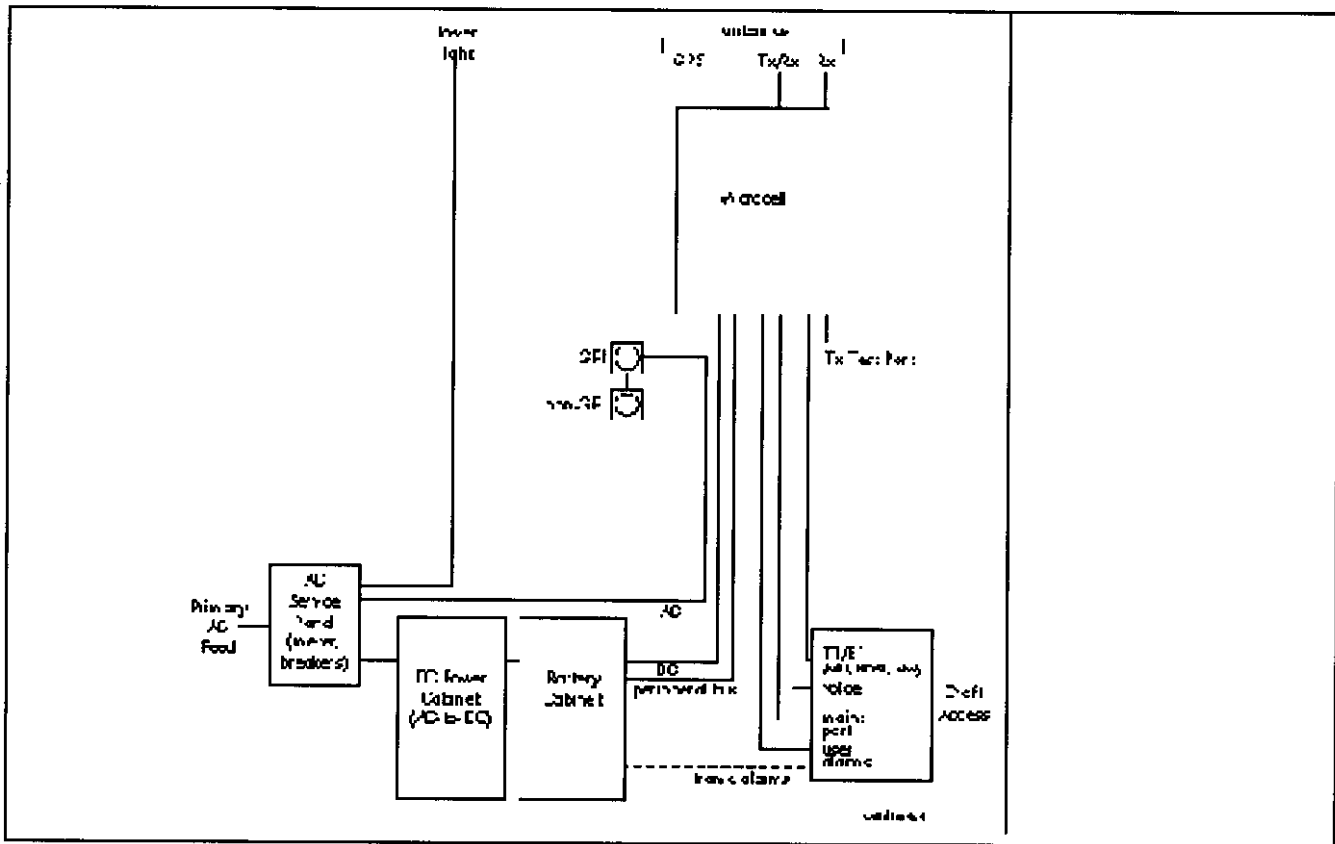

**Figure 2-14. Diagram of Ancillary Equipment**

### Antennas

The microcell will support three (four, if simplex transmit is used) antennas. These may be mounted on the microcell or mounted remote to the microcell.

The microcell is capable of operating with either a short circuit or an open circuit at the antenna port without sustaining damage.

**Craft Access Housing**

When the microcell is mounted on a pole or high on a wall, the craft access ports may be run down to a secure craft access housing at the base of the installation. Depending on configurations, this housing may provide access to the RJ48C T1/E1 lines, the RJ11 voice line jack, the RJ45 Ethernet maintenance port, and the terminal strip for the user alarms.

This housing may also contain any needed facilities interface equipment, such as Network Interface Units (NIU), HDSL modems, customer-supplied CSUs, etc. This equipment may need to draw DC power from the DC power system (the microcell PCU will not supply power to external equipment).

**DC Power System**

If the microcell is operated from a DC power source (+25 to +28 V DC), this will usually be located near the cell to minimize voltage drops. A DC power plant usually consists of a AC-to-DC power converter and a battery plant. These units report alarms via the user alarms.

When several microcells are co-located, such as when three units are clustered on a pole, the power feed to the cell (whether it is DC or AC current) may be fed by a single feeder circuit up the pole, then distributed from a junction box near the microcells.

When the cell is supplied with DC current, it still needs a minimal amount of AC to drive the convenience receptacles.

**AC Power System**

When the microcell is run from an AC power source (110 or 220 V, 50/60 Hz, single phase, 15-Amp maximum current), there may still be external equipment used at the cell site to provide backup AC power generation or Uninterrupted Power Supply (UPS).

**AC Service Panel**

Any equipment connected to the electric utility AC lines must have a local AC service panel consisting of the power meter and branch circuit breakers. Besides the microcell (or its supported DC power system), the service panel may need to have branch circuits for other equipment, such as a tower aircraft warning light.

## Optional Cooling Fan Assembly

---

**Overview** The microcell can be provided with additional cooling so that it can operate in a high temperature environment.

**Structure** The optional filter-free fan assembly provides low-maintenance conductive cooling by blowing air on the back of the microcell frame, as shown in Figure 2-15.

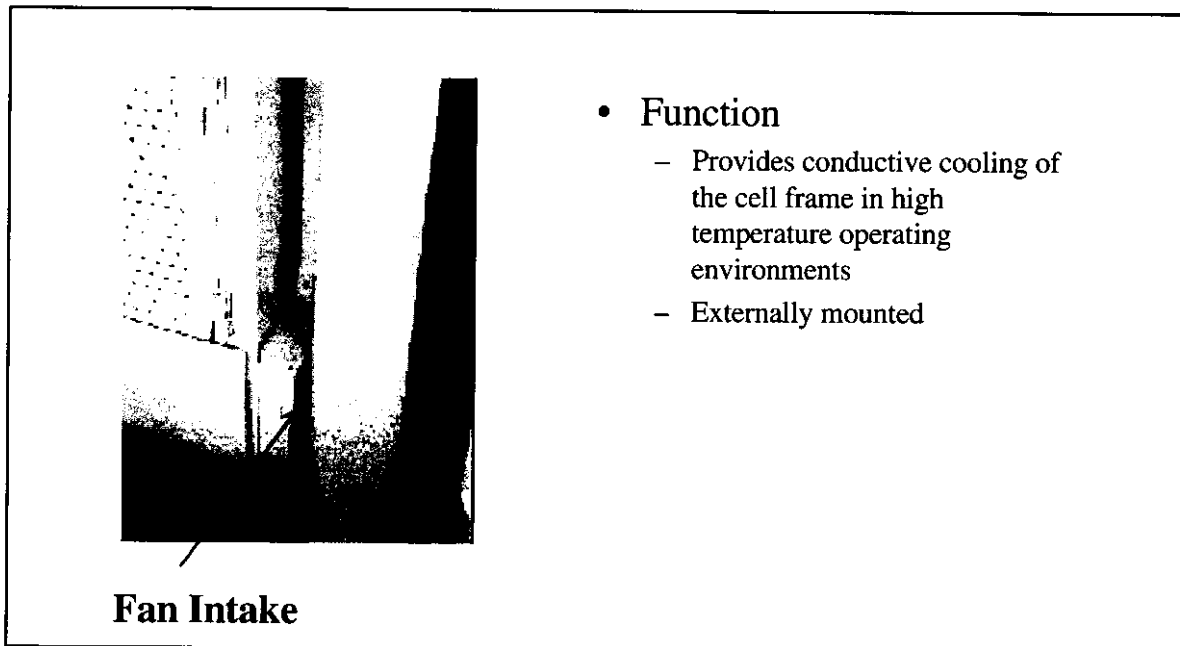

*Figure 2-15. Optional Fan Assembly*



## Optional Heating Pads

---

**Overview** The microcell can be equipped with optional heating pads so that it can operate in cold weather.

**Description** The heating pads are mounted on the microcell door frame, as shown in Figure 2-16.

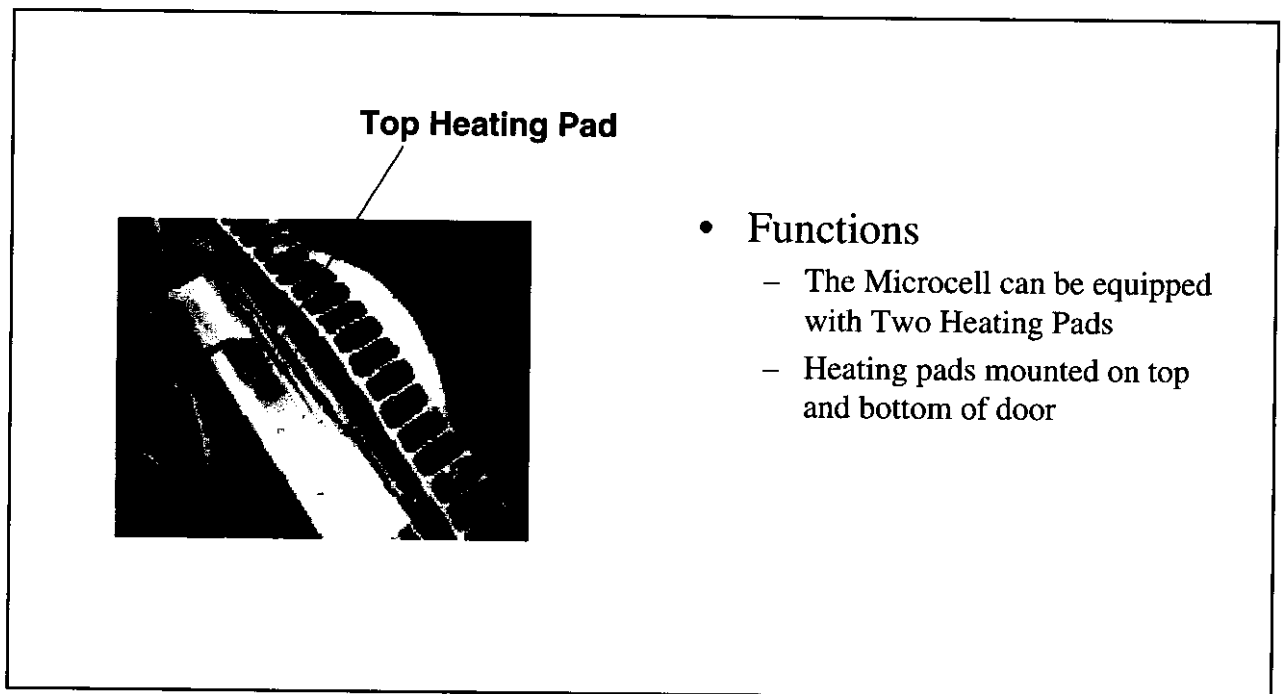

*Figure 2-16. Top Heating Pad*



# 3 Microcell Interconnections

## Introduction

**Objective of this Unit** The objective of this unit is to identify the logical and physical connections within a PCS CDMA microcell. At the end of this unit, readers should be able to do the following:

- List the functions that are performed by the microcell
- List the circuits that conduct signals between microcell components
- Identify physical connections between the microcell and its environment.

<b>Content</b>	<ul style="list-style-type: none"> <li>• Microcell Functional View</li> <li>• Microcell Software Architecture</li> <li>• Processor Functions</li> <li>• Microcell Input/Output</li> <li>• Microcell Physical Interconnections</li> <li>• Packet Bus</li> <li>• Peripheral Bus</li> <li>• Cell Site Grounding</li> <li>• Cabling Scheme</li> </ul>	<p>2</p> <p>3</p> <p>4</p> <p>6</p> <p>9</p> <p>10</p> <p>11</p> <p>13</p> <p>14</p>
----------------	---	--

# Microcell Functional View

---

## **Standard Microcell Features**

---

**Objective of this Section** This section describes the features which are common to most of the cell components and those which may be distributed through the cell. This section is designed to enable the reader to identify the functions of the components that were described in Chapter 2.

# Microcell Software Architecture

## PCS CDMA Microcell Overview

Microcell components and processors communicate through one high-peripheral (high-bit) bus and one packet (low-bit) bus, as shown in Figure 3-1.

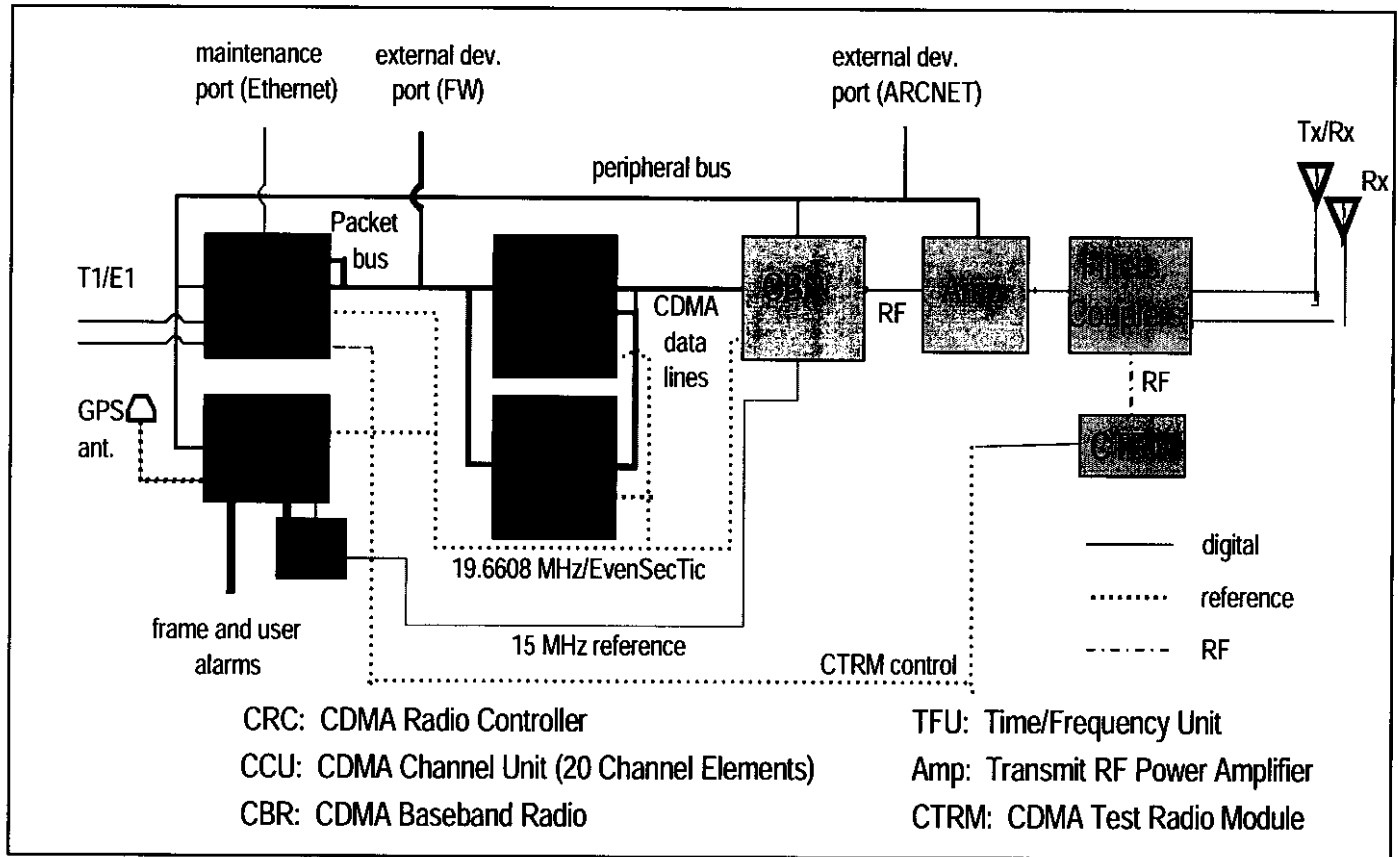

Figure 3-1. PCS CDMA Microcell Components Diagram

### Buses Functional Summary

The functions of these buses are as follows:

- The high bit-rate packet bus carries high data-rate information, such as traffic packets, between the CRC and CCU-20 components.
- The lower bit-rate serial bus, also termed the peripheral bus, supports OA&M communication with the other (non CCU-20) components of the cell.

## Processor Functions

---

### **CDMA Microcell Functional Overview**

The CDMA microcell is supported by five different processors:

- CDMA Radio Complex (CRC)
- CDMA Channel Unit (CCU)
- CDMA Baseband Radio (CBR)
- Time Frequency Unit (TFU)
- Low Noise Amplifier / Transmit Amplifier (LNA/Tx Amp)

These processors provide the following functions:

- Manage a signaling and control interface to the RCS application instance that executes on an AP (MC)
- Pass signaling and control to/from the RCS from/to other microcells connected to it in a daisy-chain
- Route packet pipe to appropriate processing modules in a microcell.
- Collect and pass alarm and status information from the microcell components to the RCS application
- Perform operations, administration and maintenance control of the microcell, under the control of an RCS instance
- Perform fault recovery of the microcell, either autonomously or coordinated from the RCS
- Perform microcell initialization, coordinated from the RCS

These functions are summarized in Table 3-1.

Table 3-1. Functions of the Microcell Processors

Unit					Function
CRC	CCU	CBR	TFU	LNA/ Tx	
X					Manage a signaling and control interface to the RCS application instance that executes on an AP
X					Pass signaling and control to/from the RCS from/to other microcells connected in a daisy-chain fashion
X					Route information content of Packet Pipe to CCUs
	X				Process information from CRC, and perform channel coding of traffic from/to the air interface for mobile user.
X					Perform the call processing functions that need to be co-located with the radio hardware
			X		Collect alarm and status from same microcell components and pass to the RCS application
X					Perform Operation, Administration, and Maintenance control of the microcell under the control of the RCS instance
X					Perform fault recovery of the microcell, either autonomously or coordinated from the RCS
X					Perform microcell initialization, coordinated from the RCS
		X			Perform RF conversion
				X	Perform signal amplification

**Processors and NVMs** Processors are provided with small non-volatile memories (NVMs) that store configuration information and operating parameters.

## Microcell Input/Output

---

- Overview** The microcell external I/Os are grouped into RF, digital, power, external equipment, and test access.
- RF I/Os** The RF I/Os include antenna ports for a duplex Tx/Rx antenna and a simplex Rx antenna. Another port is supplied for the GPS antenna. Externally mounted shunt devices protect these ports against voltage spikes caused by lightning strikes .

**Digital I/Os** The digital I/Os consist of:

- DS1 lines
- User alarms
- Maintenance port.

Digital lines coming into the microcell are protected against voltages greater than 6 V.

### DS1 Lines

The digital I/Os support two T1/E1 lines:

- The primary line is a DS1 line from the RCS/AP direction
- The secondary line is a DS1 line extending to other microcells when they are in a daisy-chain configuration.

The secondary line should be disabled when the microcell is in a stand-alone configuration to prevent the generation of line noise.

T1 transmission lines use twisted-pair cables with an impedance of 100 Ohms; E1 may use a twisted pair at 120 Ohms or coaxial cable at 75 Ohms. These lines use RJ48C connectors.

These lines may incorporate baluns to interface the external line to a common internal routing impedance. Both lines are surge protected.

### User Alarms Leads

Six pairs of user alarm leads leave the microcell to attach to external user equipment. These leads are surge-protected.

### Optional Fan Alarm Leads (for configurations that support cooling fans)

A frame alarm wire pair is passed to the optional fan unit located in the microcell skirt. One lead carries the alarm signal, the other is connected to the cell grounding.



**Maintenance Port**

The maintenance port is a 10BaseT ethernet port intended as the primary digital access port for the craftsperson.

This port uses an RJ45 connector. It enables local connection to the Remote Maintenance Terminal through a portable computer for local operation of the cell.

This port can also be used to communicate with the High Availability Operations and Maintenance Platform (HA-OMP).

This port is surge protected.

**Voice Port (Voice Interface Module)**

The microcell provides a port through a RJ11 jack to establish a voice line to the MSC. This line can also be used to connect a laptop computer to the HA-OMP for testing purposes. The traffic for this telephone is carried on a dedicated DS0 that is configured from the MSC technician screens.

Although not strictly a digital signal, the voice port comes outside of the microcell and is surge-protected.

**Power**

The microcell has two power inputs, one for DC voltage input (where available) and another for AC voltage supply to the PCU. These are both surge-protected prior to entering the microcell when the DC source is external to the microcell. If the microcell battery backup is used, the DC input is not protected.

The AC port is isolated from the DC port so that, when external DC power is supplied to the microcell, the voltage at the AC port does not exceed 1 V.

When AC power is supplied to the microcell, the service entrance (including the power meter and main circuit breaker) is external to the microcell. The microcell appears as a branch circuit on the AC line.

**External Equipment Interconnects**

The microcell supports the addition of external equipment, such as a supplementary battery plant or a backup generator.

**Test Access**

A set of test access ports is provided for cell maintenance and diagnosis. These test ports include a TX RF test point and a maintenance port.

**Tx RF test point**

This test point is used by cell maintenance personnel to verify the cell transmit power level during operation. It is accessible from outside the cell to allow measurement without disturbing the internal temperature environment. Access to this port is not intended to be run to the base of the cell tower so the port is ESD-protected only.

**Maintenance port**

This is a 10BaseT ethernet port that allows the craftsperson to connect a maintenance terminal to the microcell. The connection for this is typically in the craft access housing.

**I/O Electrical Protection**

Two modes of electrical protection for the I/Os are provided in the microcell:

- Surge protection to protect against high-voltage/high-current surges, such as from lightning strikes, is provided by externally mounted lightning protection units (primarily for power and RF connections) and circuitry within the I/O module..
- ESD protection against static charge carried by a craftsperson working on the microcell is also provided by the I/O module and by the ESD grounding strap provided within the microcell housing.

# Microcell Physical Interconnections

---

## **Overview**

---

**Purpose** This section provides additional details on microcell connections.

## Cell Site Grounding

---

### **Single Cell Site Grounding**

The microcell is provided with grounding points .

### **Multiple Cabinet Cell Sites**

When there are multiple cabinets at a cell site, all cabinet frame grounds are interconnected with a ring ground arrangement to minimize ground potential differences in the event of a lightning strike.

# RF Cable Distribution

**Overview** RF signal cables are routed through the backplane.

**Cabling Diagram** The cabling diagram for RF signals is shown in Figure 3-2.

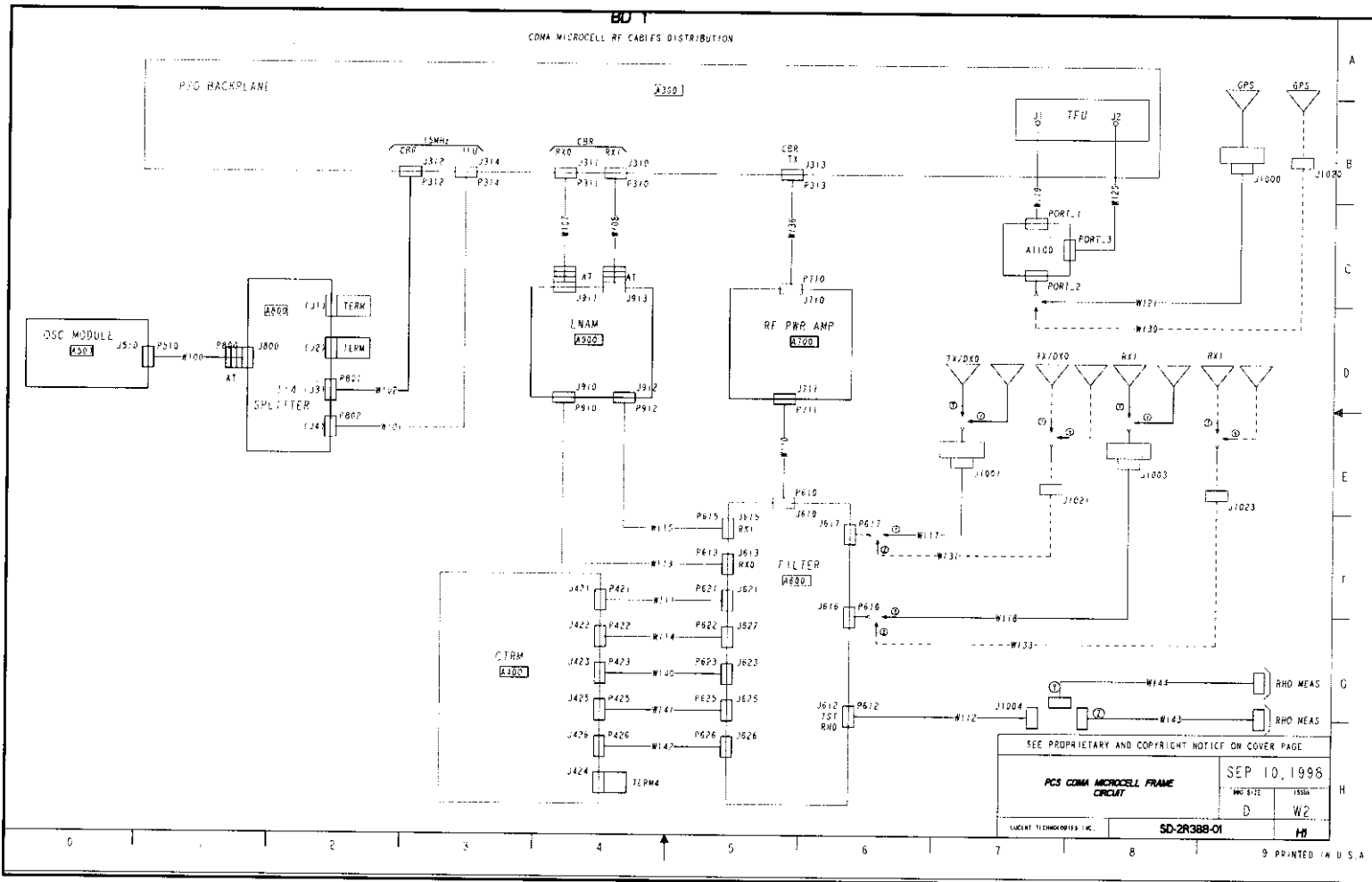

Figure 3-2. RF Signal Cabling Diagram

# Power and Signal Distribution

**Overview** The power and signal distribution cabling connects eleven components of the microcell.

**Connection Details** The connections are diagrammed in Figure 3-3.

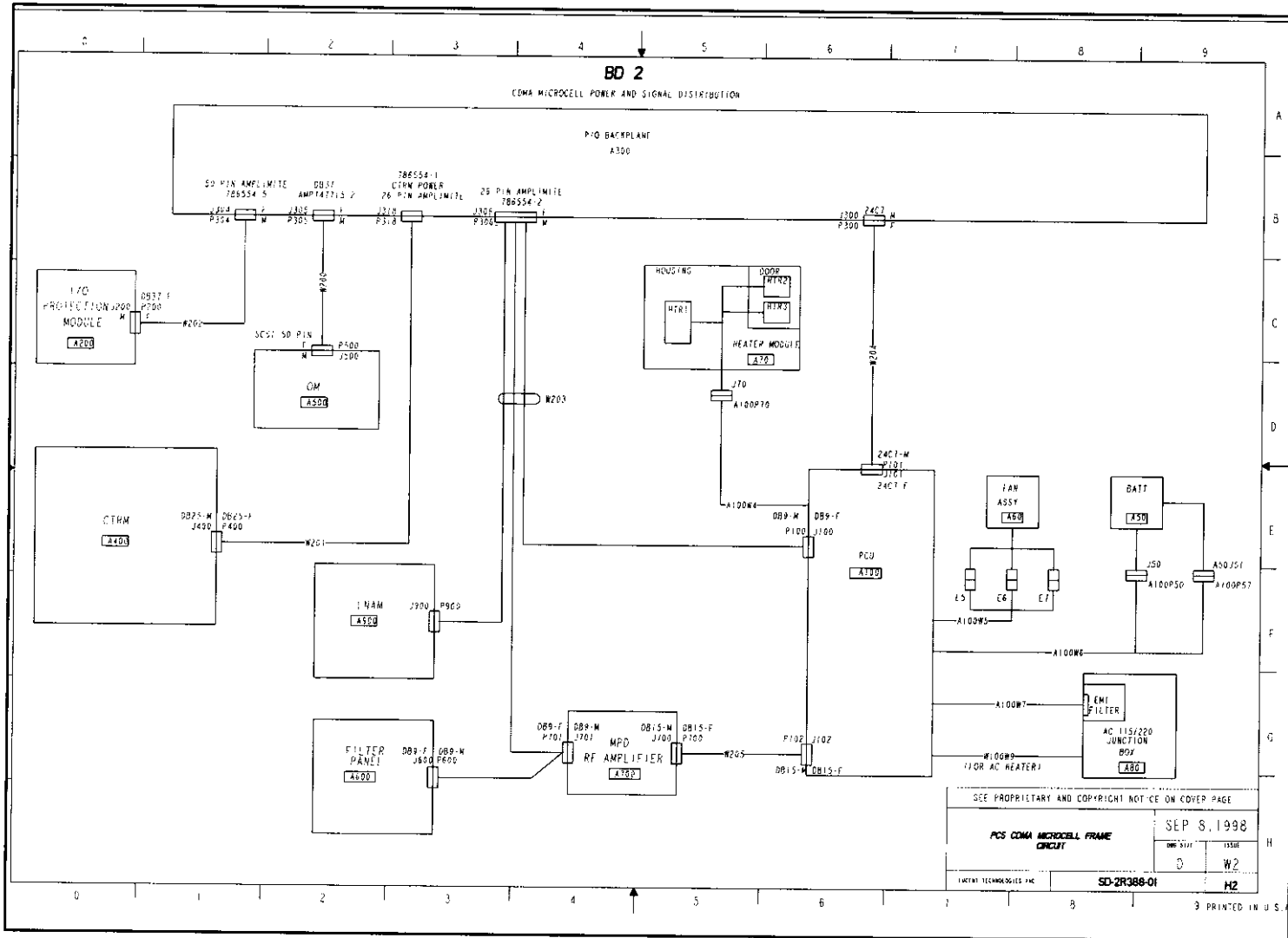
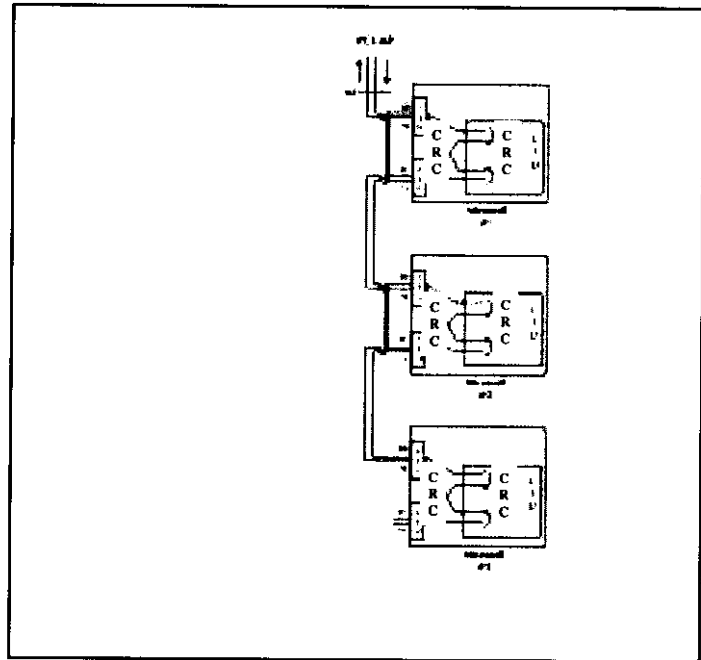

Figure 3-3. Power and Signal Distribution Diagram

## Cabling Scheme: Daisy-Chaining

**Overview** When the microcells are installed in a daisy-chained configuration, daisy-chaining is accomplished by running a full DS1 to the first microcell.

**Daisy Chain Implementation** The CRC receives the DS1, but also transmits it to the next microcell in the chain. The CRC facility supports two T1/E1 lines with one integrated CSU dedicated to each transmission line. The CSUs provide line transceiver and framer operations, as well as line monitor and test capabilities. A diagram of daisy-chaining of the T1/E1 facility is provided in Figure 3-4.



**Figure 3-4. Daisy-Chain Implementation**

**Bypass Relay** The bypass relay is designed to prevent failure in one microcell from interrupting service to other cells in the chain.

A bypass relay, installed on each microcell, shorts the primary DS1 to the secondary DS1 line. When a microcell is powered down, or its CRC fails or is removed, the bypass relay closes and provides continuity of the DS1 around the microcell. Once the CRC is operational and ready to process the DS1 line, the CRC opens the relay and reinserts the microcell into the chain.

## Special Configurations: GPS Signal Sharing

**Overview** The GPS signals may be shared by collocated microcells.

**Shared GPS Antenna** When microcells are collocated, the service provider may not want to support multiple GPS antennas. In this situation the GPS antenna lead can be split across up to six microcells, as shown in Figure 3-5.

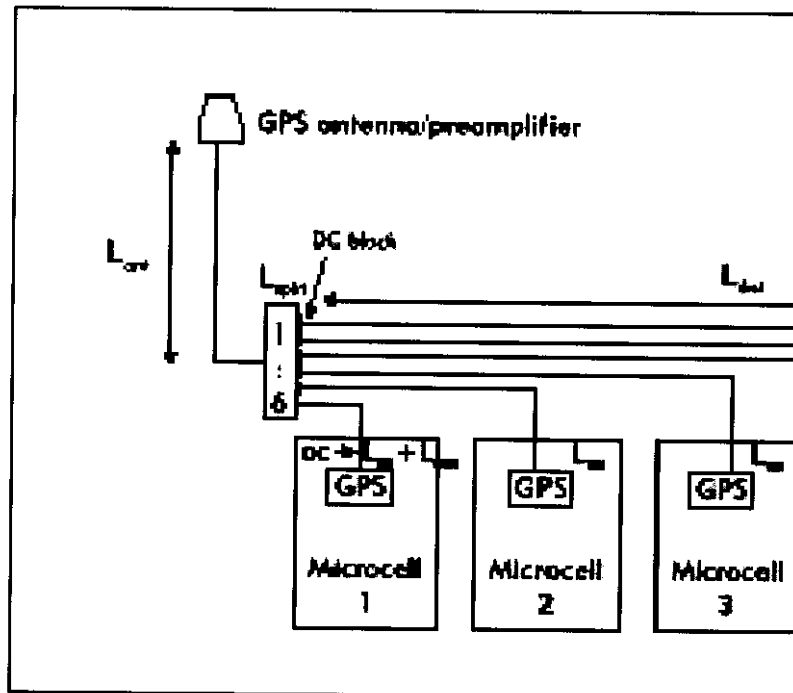

**Figure 3-5. Sharing GPS Antenna across Multiple Microcells**

### DC Power Distribution for Shared GPS Antenna Configurations

Since all GPS units supply drive current to the pre-amplifier, the splitter must incorporate DC blocks for all outputs, with the exception of the primary microcell. The primary microcell is the only cell supplying DC current to the pre-amplifier so it is the only one allowed to generate preamplifier drive current alarms. Drive current alarms from slave microcells must be disabled in translations.



# 4 Microcell User Interface

## Introduction

- Unit Objectives** Continued support of wireless services requires that the technician be able to:
- Monitor microcell operation
  - Interact with the microcell to perform routine and corrective maintenance tasks

This ability is provided through a microcell User Interface. Such an interface provides a two-way communication between the Operator and the Switch, which in turn controls the operation of the microcell.

To understand and perform operation and maintenance tasks, the Operator must be able to:

- Enter microcell commands through the appropriate user interface
- Interpret microcell responses for appropriate action, using appropriate user documentation

This unit is designed to enable the reader to identify the different types and uses of the user interfaces supporting microcell operation.

Given an installed microcell, the reader should be able to:

- Monitor its operation through the output messages generated by the Mobile Switchin Center (MSC)
- Perform maintenance tasks through the use of input commands

In addition, this unit enables the reader to make use of Lucent microcell documentation, including customer documentation on CD-ROM and schematic diagrams

<b>Contents</b>	• Microcell User Interfaces	3
	• Using the Right Interface	4
	• The Remote Maintenance Terminal Interface	6
	• RMT Operation	7
	• Status Display Pages Basics	9
	• SDP	10
	• Status Display Pages	11
	• SDP Layout	14
	• Video States of SDP Display	16
	• APX Index	19
	• SDP 2121	21
	• SDP 2131	22
	• SDP 2139	23
	• craft shellInterface and Read Only Printer Basics	24
	• craft shellCommands Syntax	25
	• Output Messages	26
	• Sample of craft shellListing	27
	• Read-Only Printer	28
	• RC/V Screens Basics	30
	• Views and Forms	31
	• 5ESS®-2000 Switch Views	32
	• Example of Switch Views	33
	• RC/V Access Manager Forms	34
	• Accessing the RC/V Form	36
	• Inserting, Reviewing, or Updating an RC/V Form	37
	• Required Fields	39
	• Required Fields -- Results	40
	• Getting Help For RC/V Screens	41
	• ceqccu Form	42
	• cell2 Form	43

- ceqcom2 Form 44
- ceqface Form 45
- Microcell Documentation 46
- Schematic Diagrams 47

# Microcell User Interfaces

---

## User Interface Overview

Several tools are available to support communication between the microcell and the MSC.

User interfaces enable technicians to interact with the microcell through commands to and messages from the MSC. This unit is designed to enable you to identify them and differentiate the conditions of their use.

### **The Different Interfaces**

Two different types of user interfaces are available to the technician:

- A Primary interface, provided by the Remote Maintenance Terminal (RMT). The RMT is a Windows-NT-based Graphical User Interface (GUI) specifically designed for use in the Flexent product line.
- An alternate interface which connects directly to the MSC through a UNIX-based user interface. That alternate interface is compatible with the interfaces to Lucent's AUTOPLEX system.

## Using the Right Interface

---

**MSC vs. RMT Control** The RMT has been specifically designed to support the microcell. However, there may be cases where direct connection to the MSC may be desirable. Each interface has advantages and limitations over the other in terms of features, capabilities, and ease of use. As a result, the choice of the right interface may be dictated by operating requirements rather than by operator's preference.

**RMT vs. Alternate Interfaces** The RMT interface supports a specific (scripted) set of commands, while the alternate interface enables both scripted and command line interactions.

### **Primary RMT Interface**

The RMT is an optional, self-contained software package that executes scripted operation and maintenance routines (macros). Its operation does not require a connection to the MSC.

The RMT provides two sets of functionalities:

- Connections to the MSC through the Application Processor Cluster (APC) to control the microcell
- MSC emulation to test microcell "health" without requiring actual connection to the MSC

### **Alternate Interface**

The craft shell interface and the SDP are two different ways of obtaining information pertinent to microcell performance, and responding to that information. Although the commands are not the same, the information that is returned is identical in scope. Craft shell results are displayed in real time, while SDP displays are updated at present intervals. Output to both interfaces is recorded on a Record Only Printer (ROP), which is a continuous listing of all system activities. The functions provided by the alternate interface are as follows

- Status Display Page (SDP): This is primarily a Graphical User Interface. SDPs are specifically designed to provide a snapshot of the status of a microcell and of its system environment.

- **Craft Shell:** The craft shell interface, also referred to as the Technican Interface (TI) is exclusively a Unix-based, line command interface. The craft shell is specifically designed for line command input and message output. A dedicated window in the SDPs supports craft shell operation.
- **Read Only Printer (ROP):** This is exclusively a running report of systems activities.

# Primary Communication Method: The Remote Maintenance Terminal Interface

---

## **Overview**

---

**General Description**     The RMT is a Windows-based application. Its Graphical User Interface (GUI) is designed for use by a technician in the field to perform tasks related to installation, diagnostics, and maintenance of the microcell.

The RMT user interface consists mainly of dialog boxes that are displayed in response to the operator selecting a function to be performed from a menu.

# RMT Operation

- RMT Components** The RMT interface consists of a main screen broken in three components:
- A task bar corresponding to the functions supported by the RMT
  - Message boxes
  - Buttons and dialog boxes for technician input for connection/disconnection,

**User Interface Description** The main screen, shown in Figure 4-1, contains a dialog box to enter microcell identification, and buttons to enable the technician to establish connectivity with the Network.

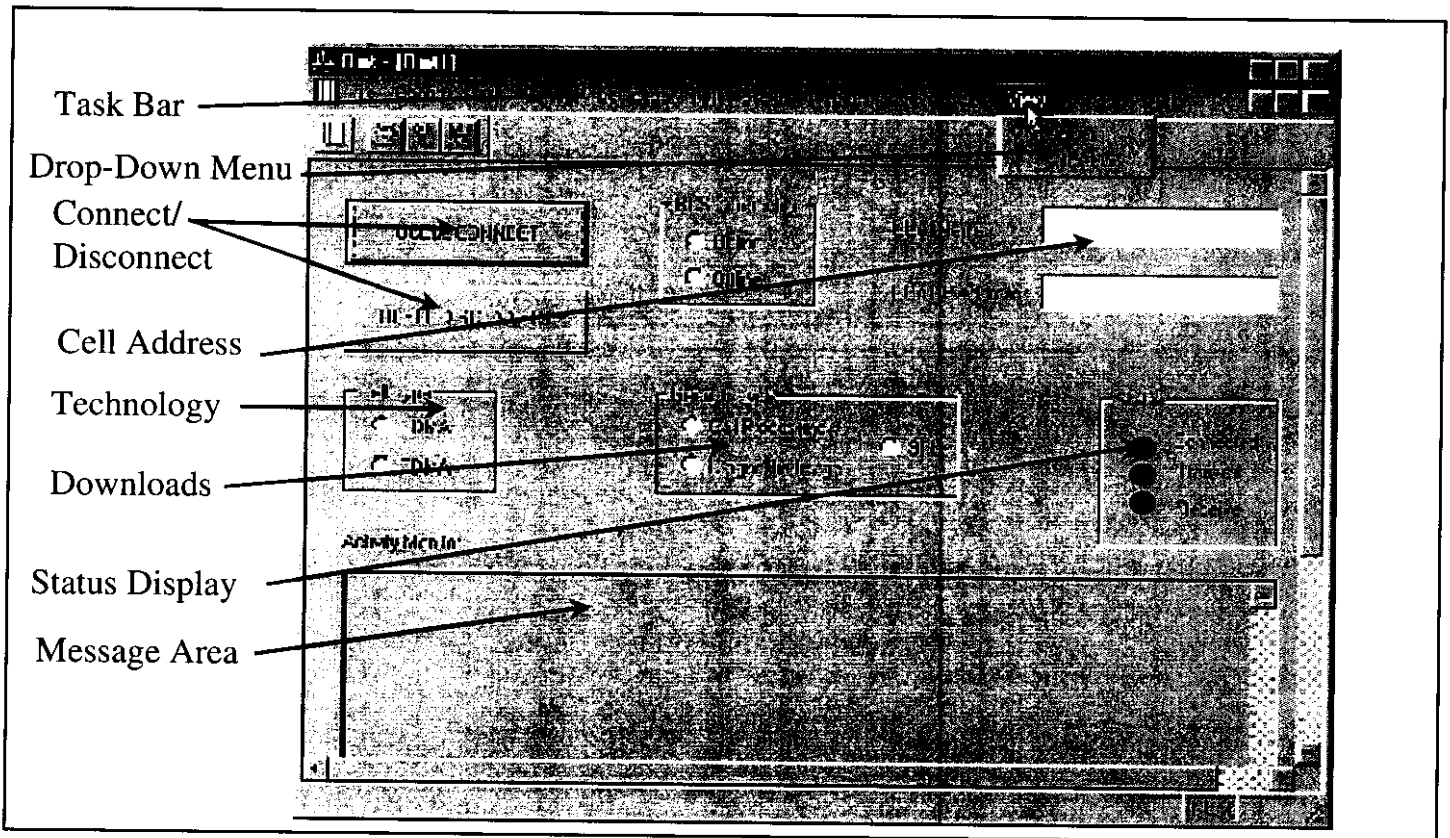

Figure 4-1. RMT Main Screen

- Functions Supported by the RMT** Functions supported by the RMT are accessible through the task bar, and include:
- Configuration of the microcell
  - Download of software



- Communication control
- Microcell equipage inventory
- Testing
- Status display
- Report generation
- Security

By clicking on any of these tasks a dropdown menu appears that enables the technician to select the element on which the task is to be performed.

# Alternate Communication Method: Direct Access to the Switch through Status Display Pages Basics

---

## **Overview**

---

**Introduction** SDPs present “canned” scenarios for accessing and/or viewing a microcell operating condition.

**Reference** More information on the SDPs can be found in 401-610-160.

# SDP

**Overview** SDPs provide a “user friendly” tool to monitor the status of a microcell, using a consistent display format.

**SDP Sample** Figure 4-2 is a sample of the 2131 SDP for a microcell.

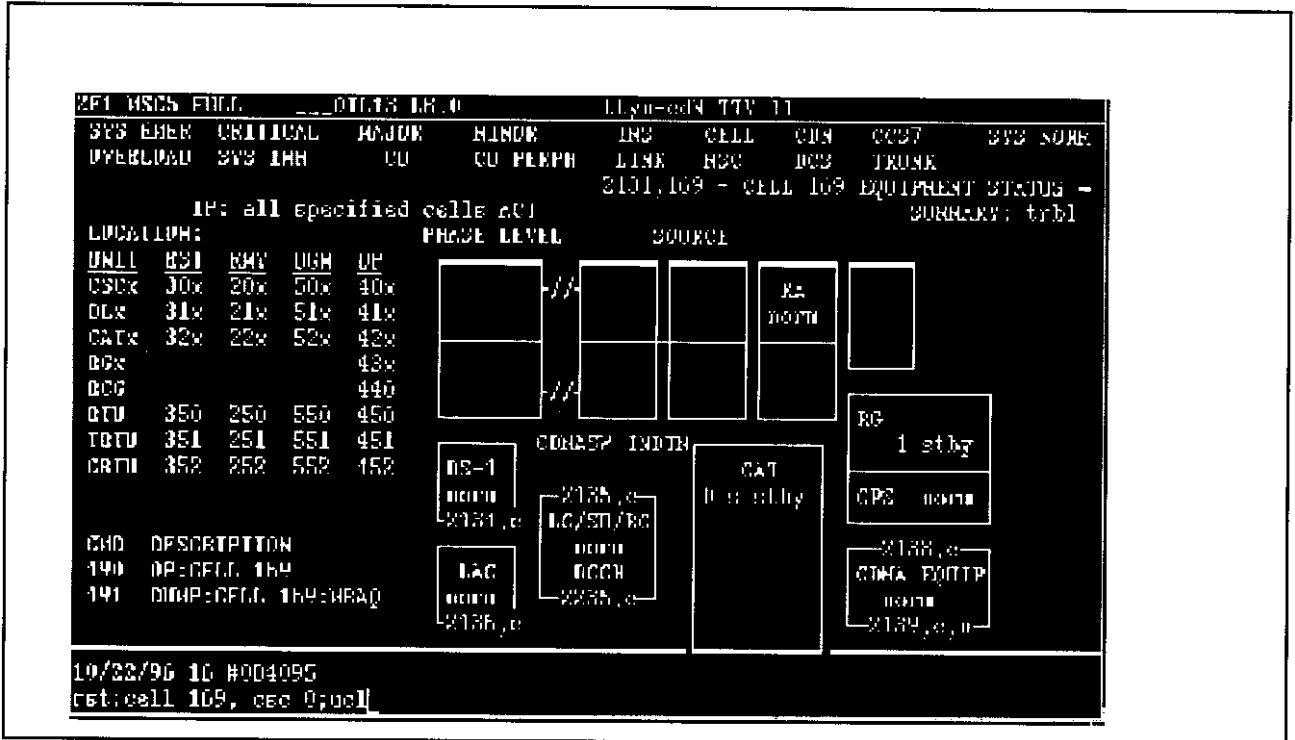

*Figure 4-2. View of an SDP Screen*

**Interaction with the Microcell through the Display**

Two modes of interaction are available to the technician:

- Scripted “poke” commands on the command line
- Calls to the craft shell in the bottom window

**System Delays**

As displays are updated at pre-set intervals, there may be a delay between completion of a command and its acknowledgment on the SDP.

**Information displayed on SDPs**

SDPs provide a “birds-eye” view of the microcell site. They enable the following functions:

- Monitoring of all major component groups
- Snapshot views of system and alarms

# Status Display Pages

## What are Status Display Pages?

Status display pages (SDPs) graphically represent the hardware and software subsystems of the microcell site and of the various components of the MSC. Status display pages are often referred to as cartoon pages.

## SDP Hierarchy

SDPs are organized according to a specific hierarchy. The hierarchy for the SDPs relevant to a microcell is shown in Figure 4-3.

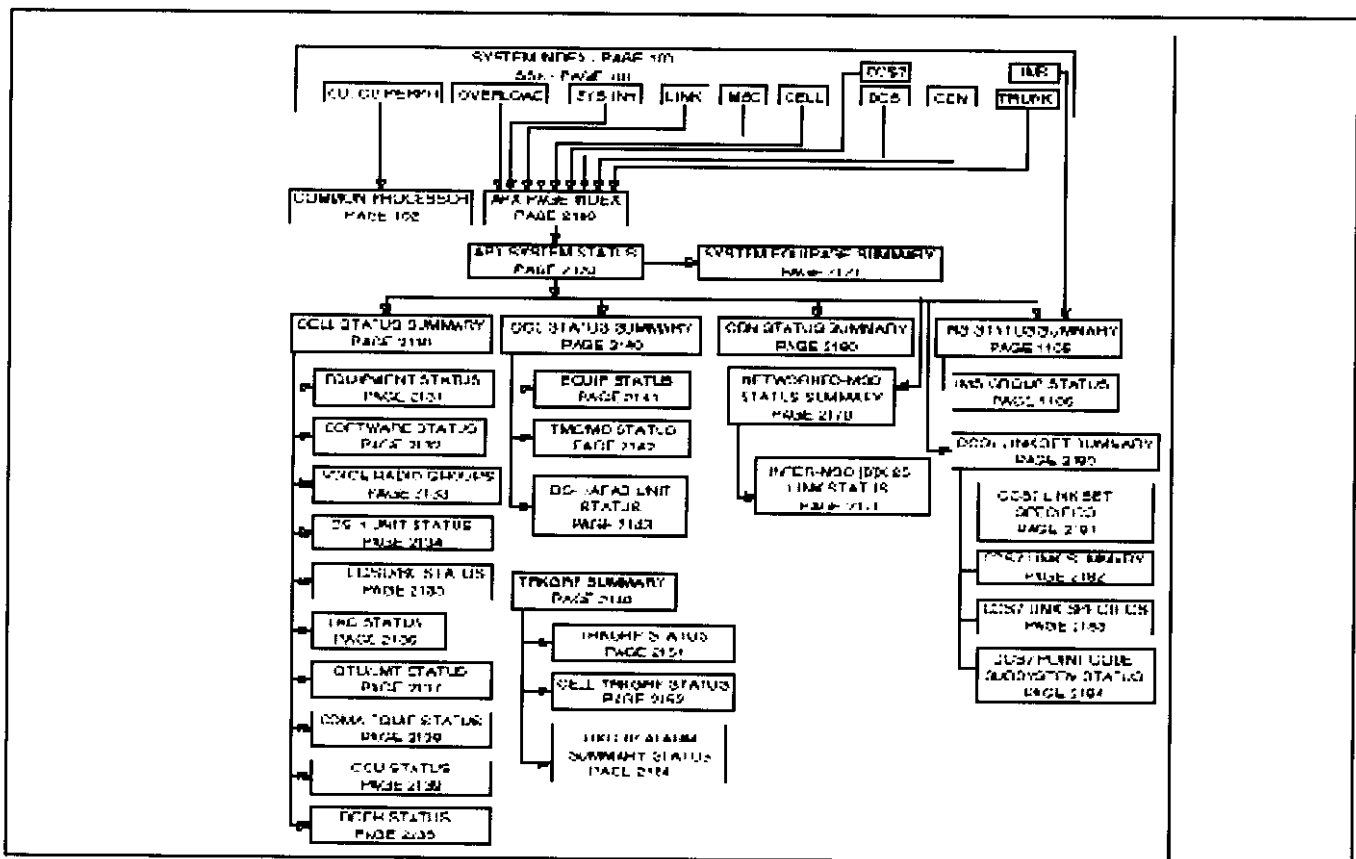
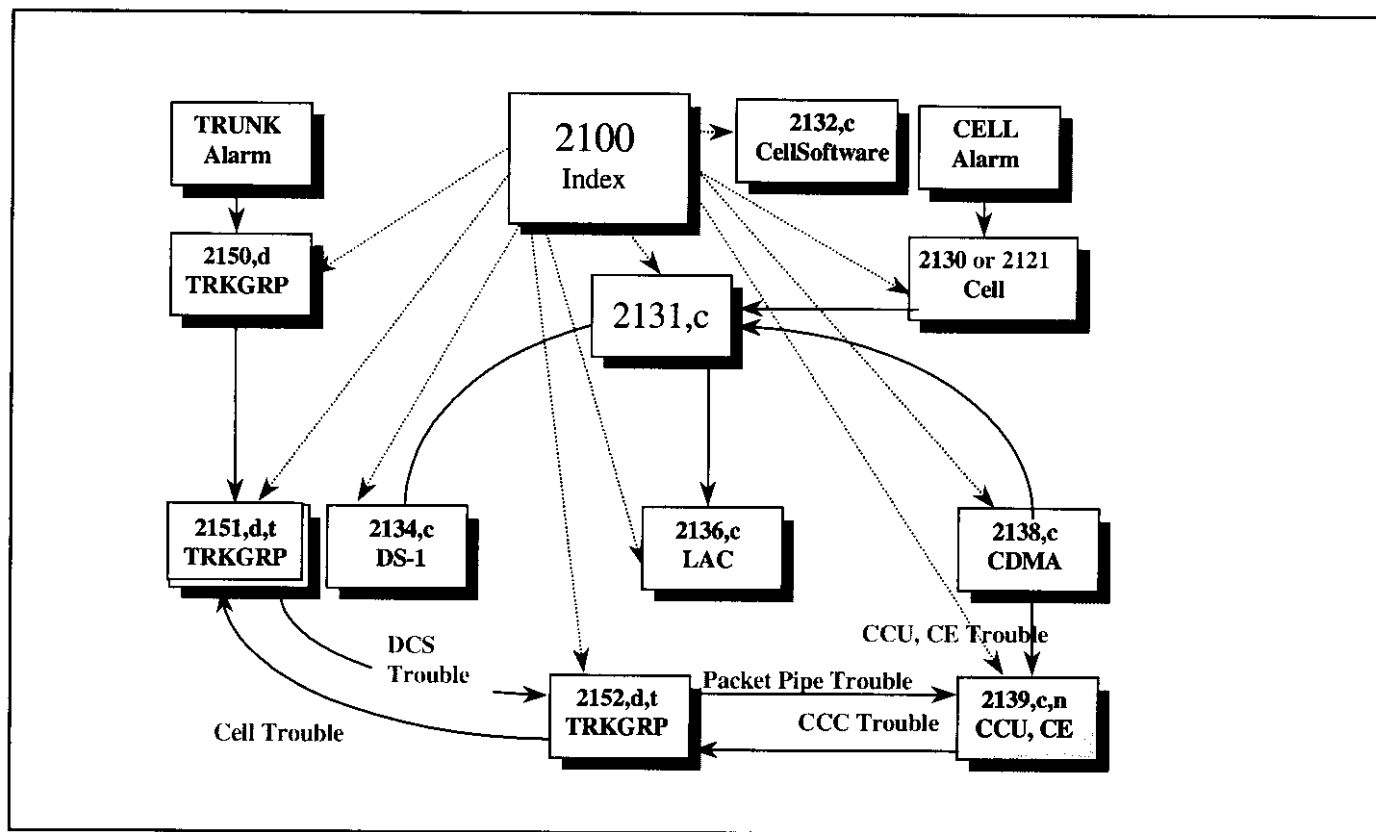

Figure 4-3. Microcell SDP Hierarchy

**SDP Links Diagram** Figure 4-4 shows the links between the more common pages and the information associations between pages.



**Figure 4-4. SDP Linkage**

**Tasks Performed with SDPs**

SDPs provide an easy method of entering maintenance commands for accomplishing the following tasks:

- Removing (deactivating) units
- Restoring (activating) units
- Diagnosing (testing) units
- Generating status output message reports on units
- Initialization
  - Phase monitoring
- Inhibiting/Allowing:
  - Audits
  - Audit/HEH output
  - Call processing
  - Forward setup channel control

- Functional tests
- Interrupts
- Routine diagnostics
- Diversity error imbalance output

**SDP Contents** SDPs are linked according to a hierarchy.

SDPs show the technician/operator the inner workings of the CDMA microcell system. The SDPs allow the technician to do the following:

- View system status
- Enter commands
- Receive system responses

The commands entered by the technician/operator offer the ability to communicate detailed and specific instructions to any of the microcell sites serving the ECP. If the ECP receives a fault from any microcell site in the network, that fault is graphically indicated, using colors to indicate levels of severity. While the fault is in progress, the technician invokes one or more SDPs to further isolate the microcell site that communicated the fault condition.

## SDP Layout

---

**General Layout** The following identifies the different areas of an SDP:

- A = Header area
  - 1st line - ECP location, generic release, terminal
  - id, date, time & time zone
  - 2nd & 3rd lines - system status
- B = Command entry line (CMD<) for “poke commands”
- C = Page contents area
- D = Scrolling area/craft shell area

**SDP Layout** Figure 4-5 shows the layout of the main screen area of an SDP.

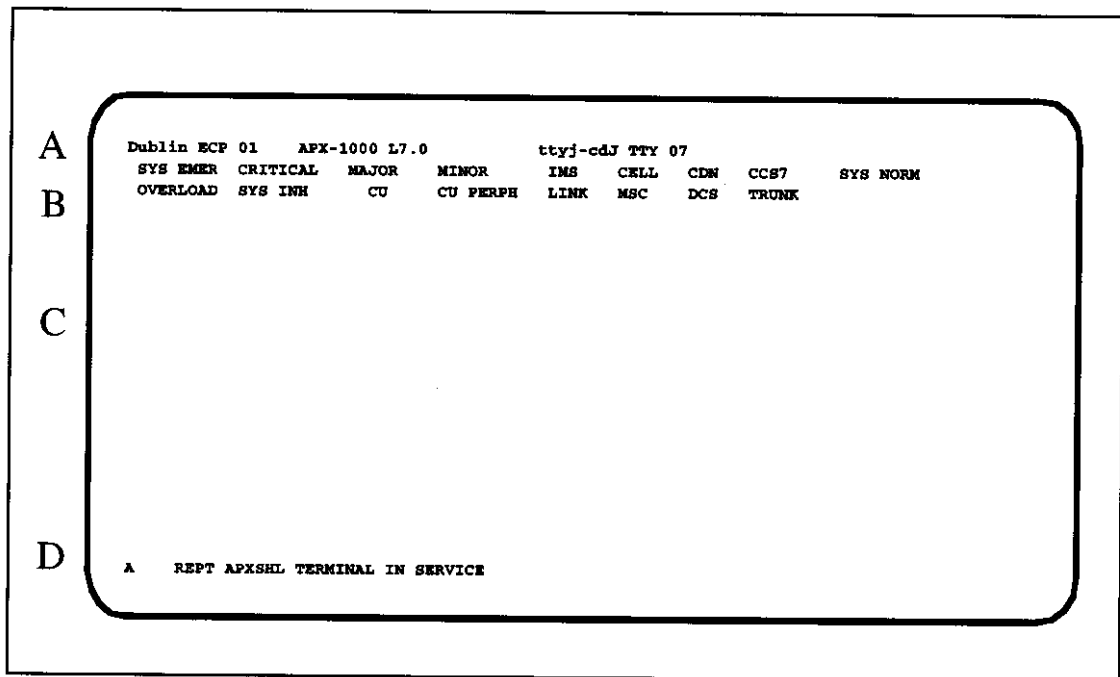

*Figure 4-5. SDP Generic Layout*

### SDPs used with the CDMA Microcell

While there are dozens of SDPs that are available at the MCRT for analyzing PCS equipment, the following are most useful in analyzing CDMA microcell performance. These SDPs are:

- 101 - System Index Page
- 2100 - APX Index Page

- 2121 - Microcell Site Status Summary
- 2131 - Microcell Equipment Status Page
- 2132 - Microcell Software Status Page
- 2134 - Microcell DS-1 Unit Status Page
- 2136 - Microcell LAC Status Page
- 2138 - Microcell CDMA Equipment Status Page
- 2139 - Microcell CCC CCU Status Page
- 2150 - TRKGRP Summary Page
- 2152 - DCS Microcell TRKGRP Status Page



# Video States of SDP Display

**Color Scheme** In the CDMA microcell, the color red on an SDP generally signifies a “non-normal condition”; the color green denotes normalcy. Other background colors are used to signify specific conditions that may or may not require attention.

**SDP Video States Table** Figure 4-6 lists the more common video states seen and their colors as shown on Status Display Pages.

• Critical: white on red	<b>critical</b>	• Standby: white on blue steady	<b>stby</b>
• Major : white on red	<b>major</b>	• O.O.S.: black on red steady	
• Minor: white on red	<b>minor</b>	• Unavail.: black on purple steady	
• Normal: black on green steady		• Alarm: white on red flashing	<b>alarm</b>
• Active: black on green steady		• Trouble: white on red steady	<b>trbl</b>

*Figure 4-6. Samples of Video State Color Coding*

**Steady or Flashing Indicators**

The table below shows the alarm types for flashing indicators.

Logical State	Text Displayed	Color Terminal
critical alarm	<none> or critical	white on red
major alarm	<none> or major	white on red
minor alarm	<none> or minor	white on red
alarm	alarm	white on red

**Steady Indicators—Black Text**

The table below shows the alarm types for steady indicators with black text.

<b>Logical State</b>	<b>Text Displayed</b>	<b>Color Terminal</b>
system normal	<none>	black on green
active	act	black on green
out-of-service	oos or <none>	black on red
unavailable	unav	black on cyan
initialization pending	Init	black on magenta
overload	ovld	black on white
diagnose	dgn	black on red
inhibit	inh	black on white
indeterminate	indt or <none>	black on yellow
busy	busy	black on green
warning	warn or <none>	black on yellow
soft fault	soft	black on yellow
DS1 alarm	ds1a	black on red
OOS limit exceeded	oos_ex	black on red
WARNING isolated	WARNING or <none>	black on yellow

**Steady Indicators—White Text**

The table below shows the alarm types for steady indicators with white text.

<b>Logical State</b>	<b>Text Displayed</b>	<b>Color Terminal</b>
unknown	<none>	white on black
standby	stby	white on blue
trouble	trbl	white on red
equipped	equip	white on black
growth	grow or <none>	white on magenta black on blue
initializing	init	white on magenta
idle	idle	white on black

Logical State	Text Displayed	Color Terminal
reverse busy	rbsy	white on red
assigned	asgn	white on magenta
transient	tran	white on red
guard	gard	white on red
periodic reset	rset	white on red
audit	aud	white on magenta
no_psa (no pilot/sync/access)	<none>	white on red
normal	norm	white on green
out-of-service isolated	OOS ISOL	white on red (ring)
out-of-service normal	OOS NORM	white on red (ring)
arr_ooS	<none>	white on red

#### Steady Indicators—Colored Text

The table below shows the alarm types for steady indicators with colored text.

Logical State	Text Displayed	Color Terminal
off-line	OFL	blue-green on red (ring)
arr_warning	<none>	blue on yellow
blocked	<none>	blue on yellow
arr_active (automatic radio reconfiguration)	<none>	green on black
unequipped	uneq or <none>	magenta on black red on yellow (ring)
OTU alarm	otu	red on yellow
camp_on	camp_on or <none>	red on green
LAC alarm	lac or <none>	red on yellow
no_page	<none>	yellow on red

# APX Index

**2100 Snapshot Description** The APX index, shown in Figure 4-7, is contained in the SDP 2100 and lists all the display pages that are accessible for the application.

```

Dublin ECP 01      APX-1000 L7.0      ttyj-cdJ TTY 07
SYS EMER CRITICAL MAJOR MINOR      IMS CELL CDN CCS7      SYS NORM
OVERLOAD SYS INH CU CU PERPH LINK MSC DCS TRUNK
CMD<
                                     2100 - APX INDEX

CMD      PAGE TITLE      CMD      PAGE TITLE
2120     - APX System Status      2140     - DCS Status Summary
2121     - System Equipage Summary 2141,d   - DCS d Equipment Status
2130     - Cell Site Status Summary 2142,d   - DCS d TMS/MC Status
2131,c   - Cell c Equipment Status  2143,d   - DCS d DS-1/AFAC Status
2132,c   - Cell c Software Status   2150,d   - DCS d TRKGRP Summary
2133,c   - SI Cell c VRG Status     2151,d,t - DCS d TRKGRP t Status
2133,c,sg,a SII Cell c VR Status   2152,d,t - DCS d Cell TRKGRP t Status
2134,c   - Cell c DS-1 Unit Status  2160     - CDN Status Summary
2135,c   - Cell c LC/SU/BC Status    2170     - Direct Networked-MSU Summary
2136,c   - Cell c LAC Status        2171,m   - MSC m [B]X.25 Link Status
2137,c   - Cell c OTU/LMT Status    2180     - CCS7 Link Set Summary
                                     2181     - CCS7 Link Set Specifics
2138,c   - Cell c CDMA Equipment Status 2182     - CCS7 Link Summary
2139,c,n - Cell c CCC n CCU Status  2183     - CCS7 Link Specifics
                                     2184     - CCS7 Point Code SS Status

A REPT APXSHL TERMINAL IN SERVICE
    
```

Figure 4-7. SDP 2100

**SDP Index Graphic** The 2100 - APX Index page is displayed as the result of a 2100 poke command. , .

**Legend** The APX INDEX gives a summary of the syntax to access a given SDP and a description of the information provided on that SDP.

Syntax	Meaning
a	Physical Antenna Face
c	Microcell Site Numbers
d	DCS Number
n	CDMA Cluster Controller Number
sg	Server Group
t	Trunk Group Number

Syntax	Meaning
VR	Voice Radio
VRG	Voice Radio Group
m	Mobile Switching Center

**SDP Access Example** To view CDMA equipment status for cell 81, enter the command:  
2131,81

# SDP 2121

**Snapshot Description** The 2121 - System Equipage Status page displays the disposition of the microcell sites.

**Sample Display** Figure 4-8 is a sample of the 2121 SDP. Each cell is shown by the cell site number using the color scheme (see p. 4-17) to indicate the cell status.

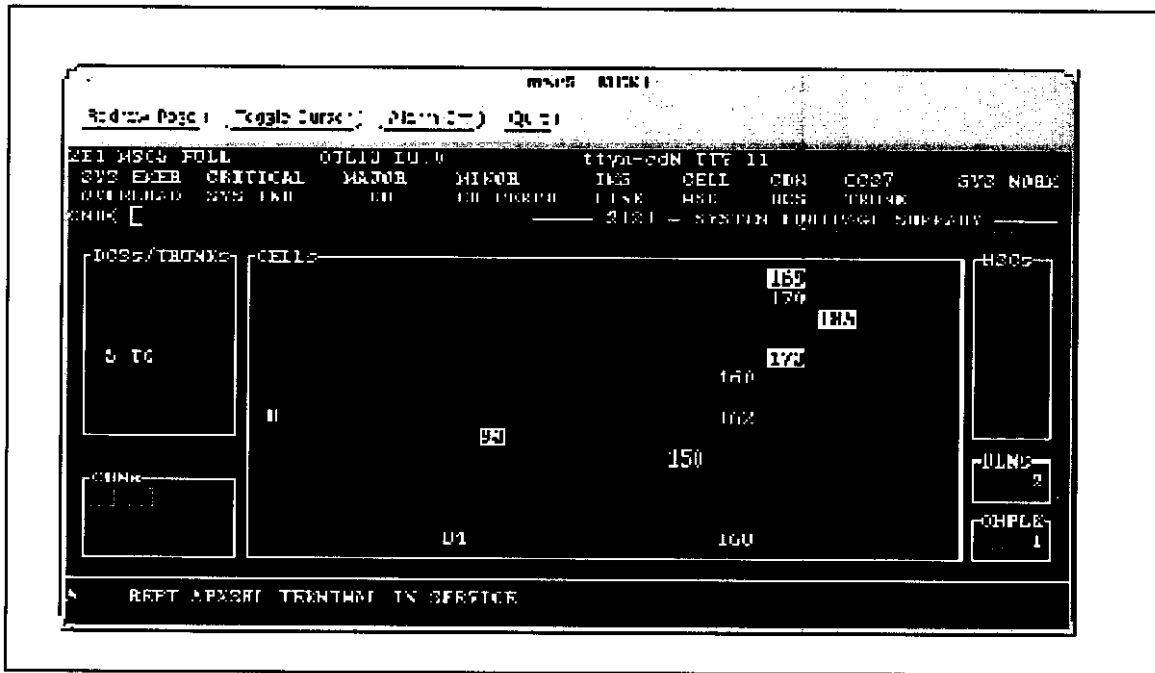

Figure 4-8. Sample of SDP 2121

# SDP 2131

## 2131 Snapshot Description

The 2131 - Microcell Equipment Status page displays the configuration of the microcell site hardware units and provides a status summary of each unit or group of units.

In addition, this page also has maintenance commands which can be used to:

- Change the microcell hardware configuration
- Generate a microcell status output message report
- Dump the microcell maintenance request administrator queue (MRAQ)

## 2131 Sample

Figure 4-9 shows the 2131 SDP. The status of various equipment groups is shown using the color code described on page 4-17.

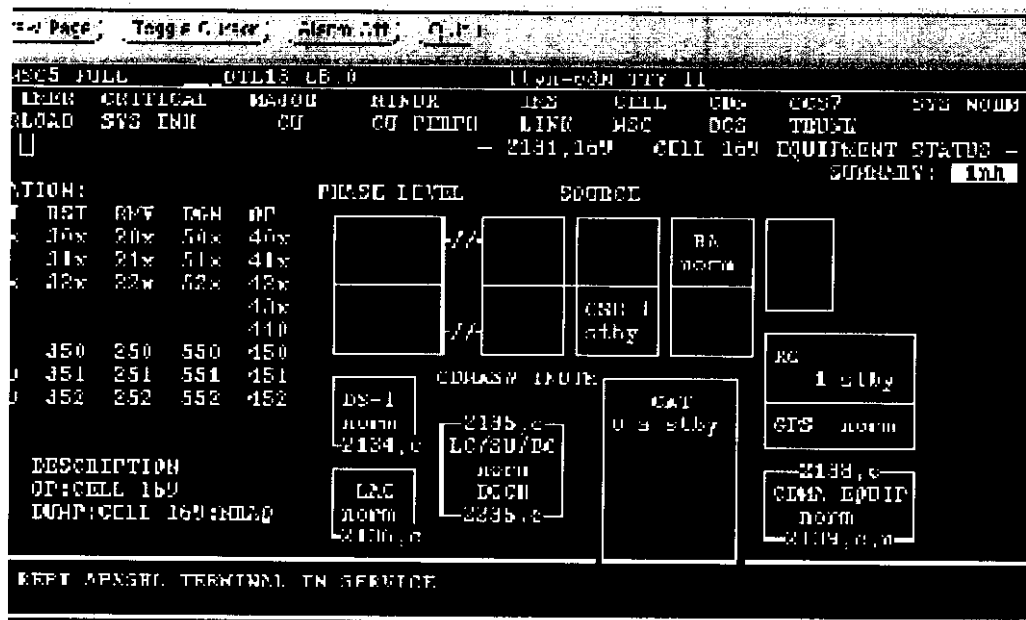

Figure 4-9. Sample of SDP 2131

# SDP 2139

**Overview** SDP 2139 is a CDMA specific page.

**Purpose of SDP 2139** SDP 2139 is used to tell which CE is equipped and its status.

**Screen** Figure 4-10 shows the 2139 Status Display Page.

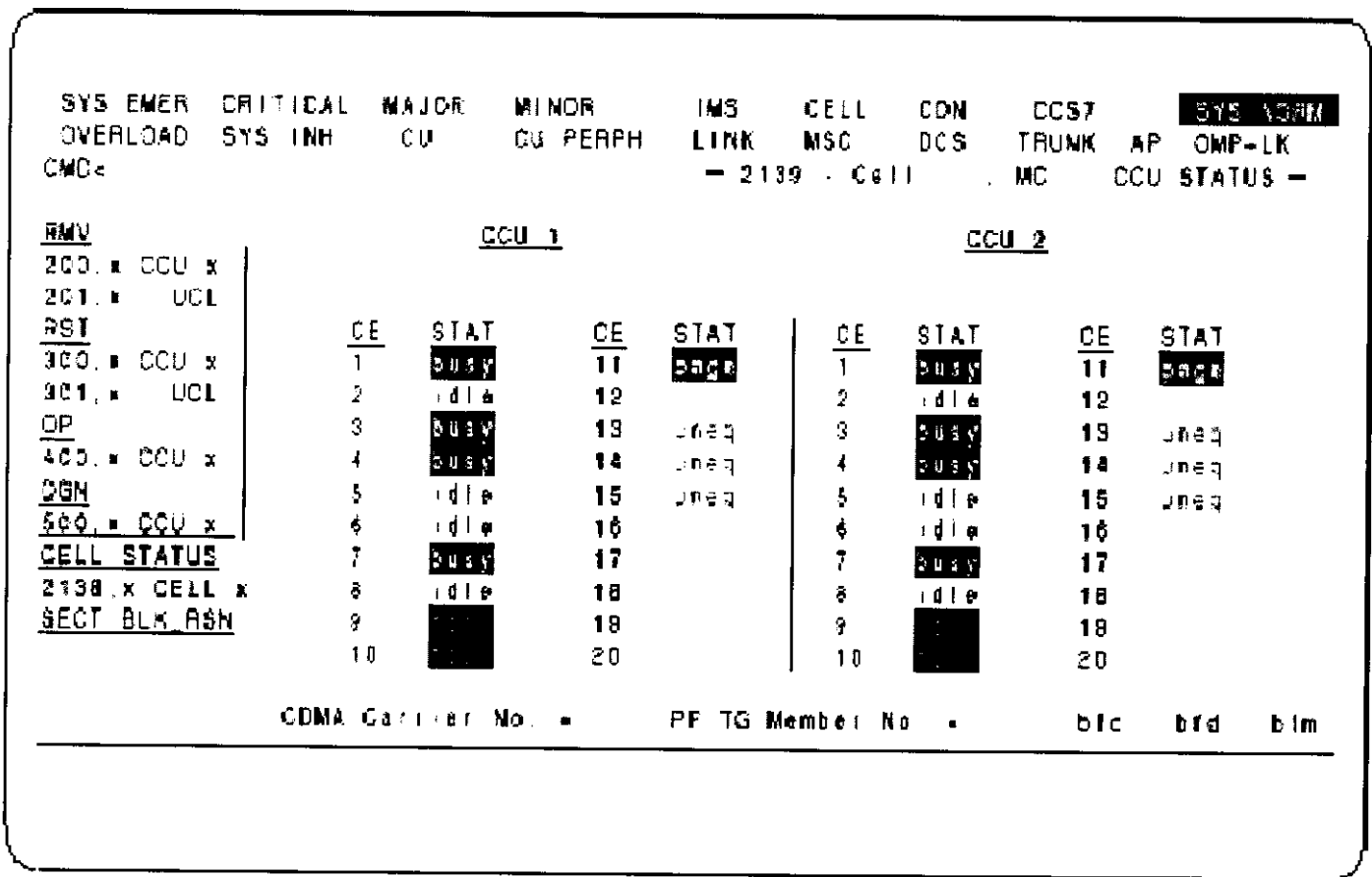

Figure 4-10. Sample of SDP 2139



# Craft Shell Interface and Read-Only Printer Basics

---

## **Overview**

---

**Introduction**     The craft shell provides the most flexible means to input commands and to retrieve output messages from a microcell.

**Standard Craft Shell**     Craft shell commands are used to:

- Identify operational status
- Remove and restore a unit from service
- Diagnose a unit
- Download Non-Volatile Memory
- Stop a command
- Initialize a site

## Craft Shell Command Syntax

---

**craft shellSyntax** Entering commands at the craft shell requires attention to precise syntax.

**Syntax Diagram** Figure 4-11 shows a sample command line and explanations of the various elements.

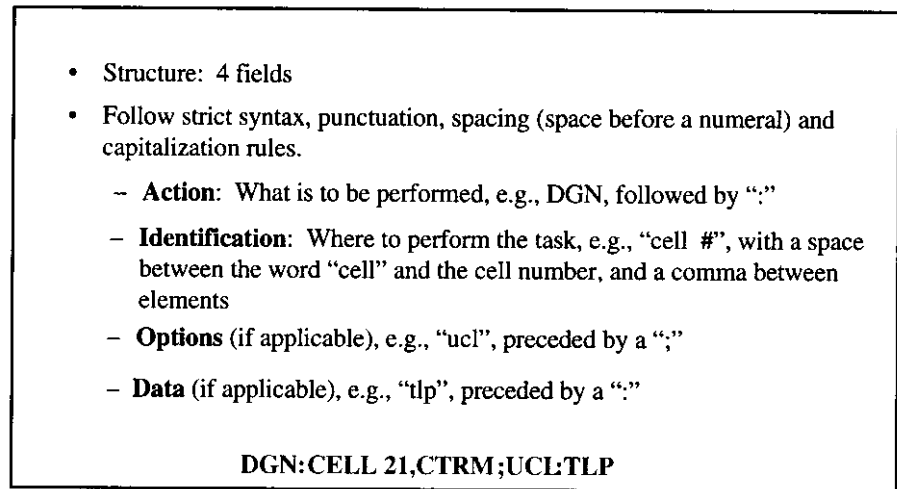

**Figure 4-11. Outline of Craft Shell Structure**

**Reference** More information on the craft shell can be found in the 401-610-107 manual.

## Output Messages

---

**Overview** Output messages are formatted system responses to technician commands or events in the system.

**Output Messages Diagram** Figure 4-12 shows an example of output from the DGN craft shell command and explanations of the fields.

- Include the following fields:
  - Priority : Alarm (\*C = Critical, \*\* = Major, \* = Minor); M = Manual, A = Automatically generated. Field is blank for informational message.
  - Abbreviated time, Message body, Date, Sequence Number

```
M 52 DGN:CELL 21 CTRM ATP
05/14/98 08:52:45 #034389
M 52 REPT:CELL 21 CTRM OOS. MANUAL. RMVD
05/14/98 08:52:45 #034390
```

*Figure 4-12.craft shellOutput Sample*

**Reference** Output messages are explained in detail in Lucent 401-610-107 documentation *AUTOPLEX® Input/Output Messages*.

## Sample of Craft Shell Listing

---

**Content** A craft shell display is a continuous listing of input commands and output messages.

**Sample Listing Graphic** Figure 4-13 shows the listing received when issuing the OP:CELL craft shell command.

```

M 47 OP:CELL 1 COMPLETE
  DEVICE - ttyd

02/17/97 47 #00181

M 47 OP:CELL 1 DL 0 CONNECT
  DEVICE - ttyd

02/17/97 47 #00181

M 47 OP:CELL 1 DL 1 CONNECT
  DEVICE - ttyd

02/17/97 47 #00181

M 47 OP:CELL 1 STATUS & CONTROL
  BOOT ALW, CP ALW, PH MON ALW, PH STATE ACTIVE, DL(S)
  FORWARD SETUP CHANNEL CONTROL NORMAL (I)
  DEVICE - ttyd

02/17/97 47 #00182
dgn:cell 1, crt

```

**Figure 4-13. Craft Shell Listing Sample**

**Craft Shell Syntax** Craft shell commands follow strict syntax, punctuation, spacing (space before numerals), and capitalization rules. The commands share a common structure of four elements:

- **command** — the command name followed by a colon (:)
- **target** — the cell affected by the command
- **object** — (if applicable) the microcell unit affected by the command
- **options** — (if applicable) options associated with the command preceded by a colon (:) or a semicolon (;)

## Read-Only Printer

---

**Description** The Read-Only Printer (ROP) is a continuous report of system activities. It can be configured to display only data related to the operation of a specific microcell, or a specific group of microcells, through the use of a "Selective Cell Site Messages" command.

**Appearance** The ROP appears as a craft shell output.

**Sample ROP Output** Figure 4-14 shows a selected portion of the ROP output as samples of the messages displayed.

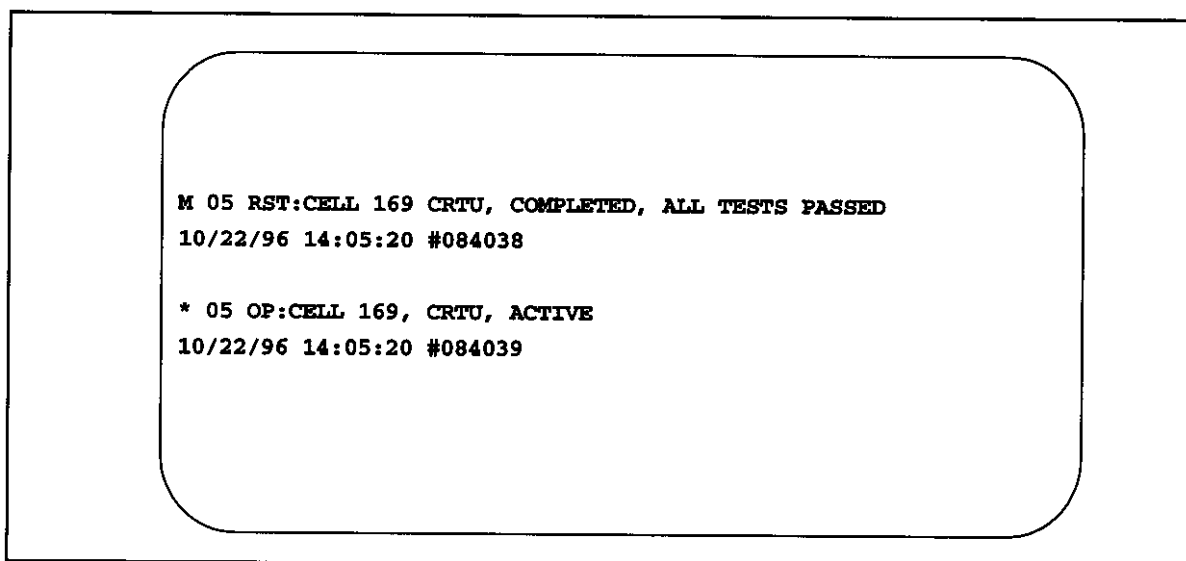

```
M 05 RST:CELL 169 CRTU, COMPLETED, ALL TESTS PASSED
10/22/96 14:05:20 #084038

* 05 OP:CELL 169, CRTU, ACTIVE
10/22/96 14:05:20 #084039
```

*Figure 4-14. ROP Display Sample*

**Report Types** There are two types of output reports: solicited and spontaneous. Solicited reports are generated in response to the commands entered by the technician. Spontaneous reports are generated without any input from the technician; they are initiated automatically by system events or conditions. An example of a spontaneous report is the reporting of a cell site hardware error and corresponding automatic recovery action.

**Report Access** The HEH and CP Fail messages are printed at the ROP and may reflect problems not displayed on the SDPs. The ROP printouts should be reviewed at least once a day for CDMA-related messages. To make this easier, tools will be provided which will allow these messages to be filtered from the normal stream of ROP messages and routed to a

CDMA log file at the HA-OMP. These tools will also analyze these messages and sort and summarize them by specific equipment unit.

**Reference** Format and meaning of ROP output are explained in the Lucent Technologies 401-610-107 *AUTOPLEX® 1000 Input/Output Messages Manual*.

## RC/V Screens Basics

---

### **Overview**

---

**Introduction**     The craft shell and SDPs do not affect a microcell's operating parameters. These parameters are stored in a database, called a translation database. To change them, one needs to interact with the database. This is done through interactive screens called Recent Change and Verify (RC/V) screens.

**Purpose of the RC/V Screens**     RC/V screens provide the user interface to a microcell database, and are used to change and check on the configuration of a cell. Some of the changes are service affecting.

All RC/V screens share the same look and feel.

## Views and Forms

---

**Introduction** Two different screen formats are used to access the 5ESS-2000 and the Access Manager:

- Switch screen views relate to the 5ESS-2000 operating parameters
- Access Manager forms relate to the microcell operating parameters.

**5ESS-2000 Switch Views** The RC/V screens are grouped into 28 classes for accessing the 5ESS-2000 switch.

**Access Manager Forms** The forms of particular interest to microcell functioning are as follows:

eCP	Executive cellular processor
cell2	Basic microcell equipage
ceqcom2	Specific microcell equipage
ceqface	Specific microcell face equipage
ceqccu	Specific microcell CDMA CCU equipage.

**Reference** See Lucent documentation 235-118-251 *Recent Change Procedures* for RC/V procedures.



# 5ESS®-2000 Switch Views

**Introduction** Switch Views define the configuration of the Switch at the MSC that controls a microcell. Given the fact that they make it possible to change an entire system configuration, access to Switch Views is highly controlled.

**Use of Switch Views** Switch Views are rarely used for cell site maintenance. One instance of access is as part of a cell update that requires reconfiguration at the switch, such as a change in packet pipe size to accommodate new CCUs.

Access to the Switch Views will normally be done under the control of a Switch technician.

**RC/V Classes in Switch View** Figure 4-15 gives a sample of the Recent Change and Verify classes for the 5ESS® Switch.

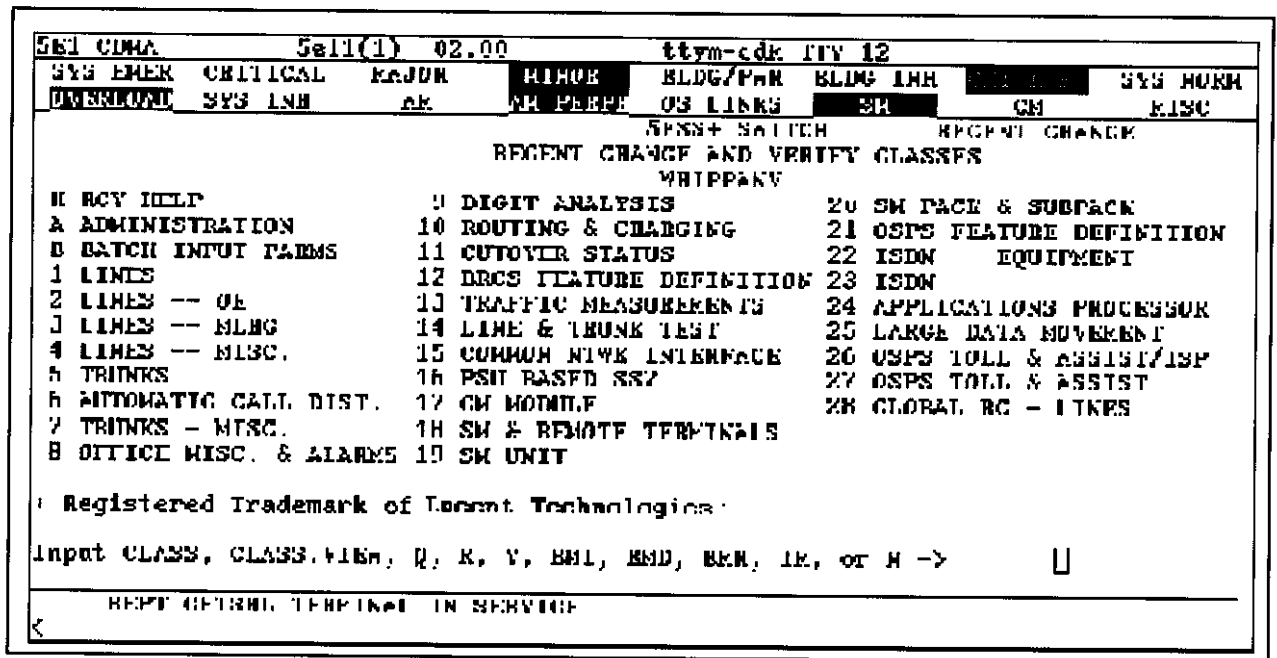

Figure 4-15. Switch View form

**Reference** For more information on the switch views see Lucent documentation 401-610-036 *Database Update*.

## Example of Switch Views

**Format** Switch Views have a header that resembles an SDP header. The body of a Switch View screen lists and displays the value of the Switch database fields that are covered by that view.

The lower part of the view is a craft shell command line.

**Switch Views Sample** Figure 4-16 is a sample of a 5ESS switch view.

```

5ESS CDMA      5c11(1) 02.00      (Lan-cdr: IT9 12
SYS ENDR CRITICAL  MASTER  PTIME  RIDG/PTN  RIDG TST  SYS NOTW
OVERCOAT  SYS INA  AM  AS PERSE  OS LINKS  SR  CH  RLOC
SCREEN 1 OF 3      5ESS SWITCH COMPANY
                    RECENT CHANGE 5.0
                    VERIFY PIPELINE CHANNEL GROUP

*1. SN      27
*2. PSD     01
*3. SHFLF   01
*4. CHL GRP 3:

PIPELINE CHANNEL GROUP CHANNEL ASSIGNMENT LIST (CHANNELS)
CH1.  TCN  WFR  SW  DT1  DFT  CH1.1  CH1.2  CH1.3  CH1.4  CH1.5  CH1.6  CH1.7  CH1.8  CH1.9
0     5B1  0006  2   0   6    09    10    11    12    ---    ---    ---    ---    8
1     5B2  0002  2   0   6    25    26    27    28    ---    ---    ---    ---    8
2     ---  ---    ---  ---  ---    ---    ---    ---    ---    ---    ---    ---    ---    0
3     ---  ---    ---  ---  ---    ---    ---    ---    ---    ---    ---    ---    ---    0

Switching Module number.  Enter 1 - 192.

REPT CTRNL TERMINAT IN SERVICE
C
    
```

Figure 4-16.RC/V Switch View Sample

# RC/V Access Manager Forms

**Form Essentials** All ECP RC/V forms share the same look and feel (see Figure 4-17).

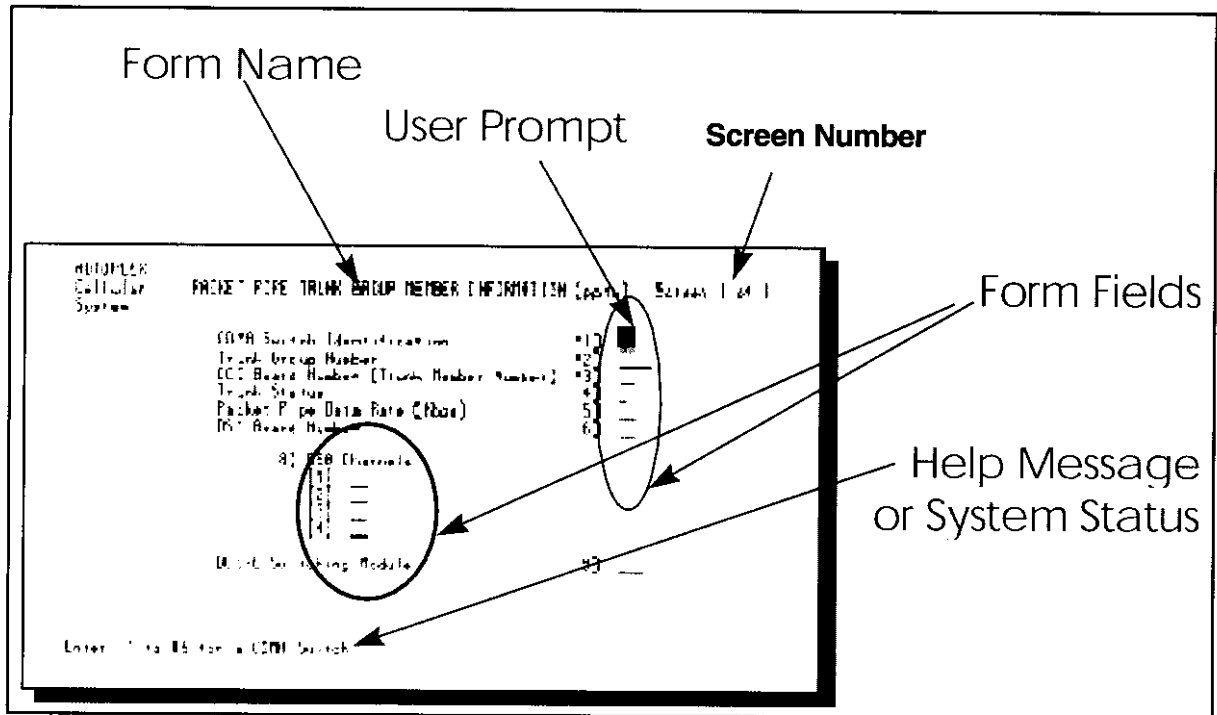

**Figure 4-17. Access Manager Forms Layout**

### Common Elements

All RC/V forms display the following three essential elements:

1. User Prompt - an AUTOPLEX system feature that points you to a field in which you may enter information.
2. RC/V Form Fields - place holders that store and display RC/V information.
3. Help Message or System Status - context-sensitive text that prompts you to enter a value in a field or provides system-level information.

### The Common Look

Access Manager RC/V forms share the same “look” and “feel” and have the following characteristics:

- Forms are arranged in screens, each of which contains a number of fields.

- Screen numbers are displayed on the top right corner.
- Fields are assigned field numbers. Their names and assigned numbers are arranged in columns on the left of the form, and corresponding data is displayed on the right.
- Position of a given field name, on a given screen or field number may change from time to time to accommodate different software releases.

**Reference** For more information on the switch views see Lucent documentation 401-610-036 *Database Update*.

## Accessing the RC/V Form

---

**Purpose of the Access Screen** This screen, shown in Figure 4-18, accepts legitimate values for RC/V screen names. Entering a question mark (?) will list all allowed values. In the access screen of any given form you must enter at least one legal value to display the next screen which is the "Required Action" screen.

```

AUTOPLEX Cellular System RC/V (ODIN) - Data Entry
=====
Enter Form Name (or ?): █
    
```

**Figure 4-18. Access Screen**

**Form Access Procedure** To access an RC/V form, do the following:

1. Type the form name at the prompt
2. Press Enter

## Inserting, Reviewing, or Updating an RC/V Form

---

### **Purpose of the Insert, Review, Update (IRU) Screen**

There are three modes of access to an RC/V screen. These are:

1. Insert - enables entries in fields of the selected form
2. Review - enables read-only display of the field values in the selected form
3. Update - enables confirmation of inserted data

### **The IRU Screen**

The IRU screen is shown in Figure 4-19.

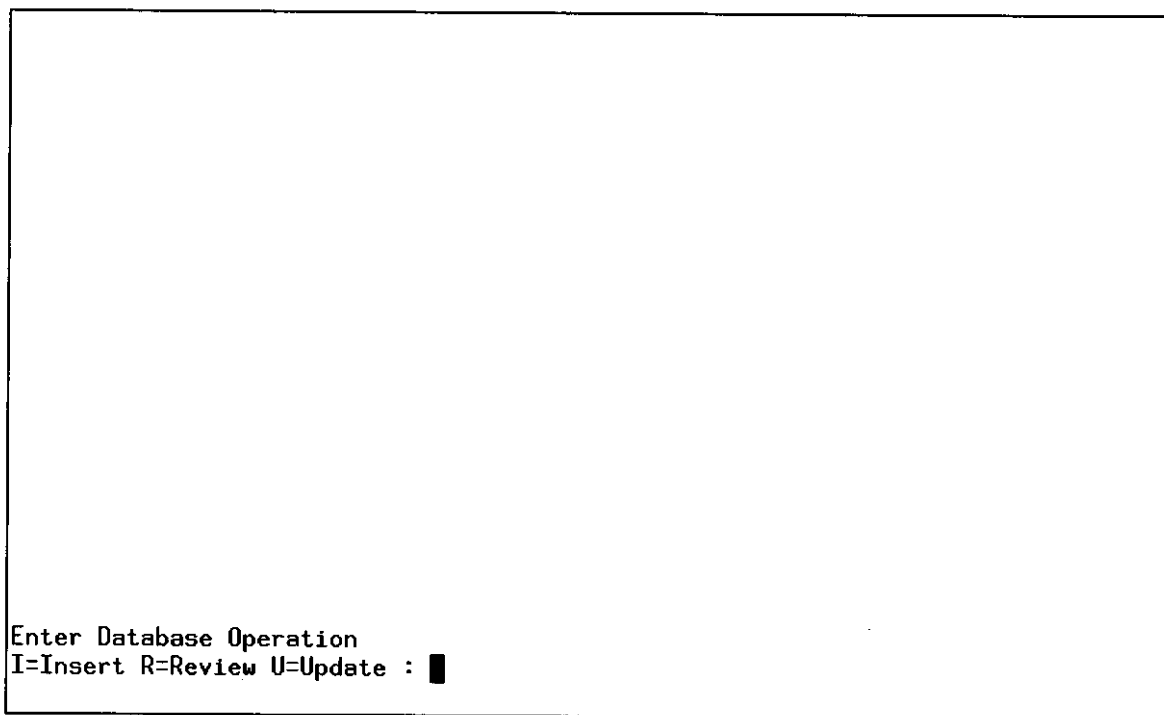

**Figure 4-19. Insert, Review or Update Screen**

### **Procedure**

To insert, review, or update data in an RC/V form, perform the following actions:

1. To access a form in the read-only mode:
  - a. access the required RC/V form by following the procedure outlined in page 437
  - b. select the *R* option in the IRU form. The requested form is displayed in a read-only mode.

2. To access a form for the purpose of changing the value of a field in a form:
  - a. access the required RC/V form by following the procedure outlined in page 437.
  - b. Select the *I* option in the IRU form. The requested form is displayed in a write-enabled mode.
  - c. Change systems parameters by filling out the appropriate field then exit that form by typing the < (Shifted comma) key. This returns the display to the IRU form.
  - d. Select the *U* option to accept the changes.

# Required Fields

**Identifying the Required Fields**

Some fields need to be populated with legal data before the form can display the contents of the microcell database. These required fields are indicated by an asterisk (\*) (see Figure 4-20).

**ECP Sample Screen**

The sample screen is the *ecp* screen 1 of 15. Only the first field is required to identify the executive cellular processor accessed.

```

AUTOPLEX
Cellular          EXECUTIVE CELLULAR PROCESSOR (ecp)          Screen 1 of 15
System

Executive Cellular Processor Identification.....*1)  _
Read Control Filler..... 2)  _
Overload Control for Mobile Originations (S2 ONLY).... 4)  _
Overload Location Request Limit..... 5)  _
Service Measurements - Level of Reports..... 6)  _
                   - Reporting Period..... 7)  _

Message Routing Scheme..... 8)  _
Max. No. of Mobile Requested Call Mode Changes (TDMA).. 9)  _
System Controlled Dynamic Power Change - Cell Site.... 10)  _
                   - Mobile..... 11)  _
Apply Busy Tone Indicator to Interworked SS7 Calls.... 12)  _
Origination Request Max Loop Count..... 13)  _
IN Trigger Maximum Loop Count..... 14)  _
SCP System Identifier..... 15)  _
SCP Switch Number..... 16)  _
Frequency of ISUP Trunk Circuit Audits (sec)..... 17)  _
Enter Review, Change-insert, Validate, screen#, or Print: █
    
```

**Figure 4-20. Required Field Exemple**

**Reference**

For more information on the switch views see Lucent documentation 401-610-036 *Database Update*.



# Required Fields -- Results

**Completed Form** Once the required fields have been populated, the remaining fields are automatically filled in and displayed on the completed form, as shown in Figure 4-21.

**ECP Sample Populated** The screen shows the *ecp* screen 1 of 15 populated with the setup information for Executive Cellular Processor Identification 1.

AUTOPLEX Cellular System	EXECUTIVE CELLULAR PROCESSOR (ecp)	Screen 1 of 15
Executive Cellular Processor Identification.....*1)		<u>1</u>
Read Control Filler..... 2)		<u>y</u>
Overload Control for Mobile Originations (S2 ONLY)..... 4)		<u>5</u>
Overload Location Request Limit..... 5)		<u>6</u>
Service Measurements - Level of Reports..... 6)		<u>1</u>
- Reporting Period..... 7)		<u>0</u>
Message Routing Scheme..... 8)		<u>a</u>
Max. No. of Mobile Requested Call Mode Changes (TDMA).. 9)		<u>2</u>
System Controlled Dynamic Power Change - Cell Site.... 10)		<u>y</u>
- Mobile..... 11)		<u>y</u>
Apply Busy Tone Indicator to Interworked SS7 Calls.... 12)		<u>y</u>
Origination Request Max Loop Count..... 13)		<u>2</u>
IN Trigger Maximum Loop Count..... 14)		<u>2</u>
SCP System Identifier..... 15)		_____
SCP Switch Number..... 16)		_____
Frequency of ISUP Trunk Circuit Audits (sec)..... 17)		<u>60</u>
Enter Review, Change-insert, Validate, screen#, or Print: █		

**Figure 4-21. Populated Screen (once the required field(s) have been filled in)**

**Reference** For more information on the switch views see Lucent documentation 401-610-036 *Database Update*.

## Getting Help For RC/V Screens

---

- Getting Help** Help is available at anytime from any RC/V form screen. The help screens are accessed by entering a question mark (?) at the prompt that is displayed at the bottom of the screen.
- Reference** For more information on the switch views see Lucent documentation 401-610-036 *Database Update*.

# ceqccu Form

**Purpose of the Form** The *ceqccu* form indicates the status of CCU equipment. This form is populated by the *ceqcom* form and is read-only.

**ceqccu Screen Sample** The screen sample, shown in Figure 4-22, is *ceqccu* screen 1 of 2 populated with the shelf equipage settings for cell 168.

```

AUTOPLEX
Cellular          SERIES 2 CELL CDMA CCU EQUIPAGE (ceqccu)      Screen 1 of 2
System           Cell Site Number *1) 168
2) CDMA Channel Unit Equipment Status List:
   CCC   CCU 1  CCU 2  CCU 3  CCU 4  CCU 5  CCU 6  CCU 7
   ID#   4)    5)    6)    7)    8)    9)   10)
[1]  1    u     u     u     u     u     u     u
[2]  2    e     e     e     e     u     u     u
[3]  3    u     u     u     u     u     u     u
[4]  4    e     e     e     e     u     u     u
[5]  5    u     u     u     u     u     u     u
[6]  6    e     e     e     e     u     u     u
[7]  7    u     u     u     u     u     u     u
[8]  8    u     u     u     u     u     u     u
[9]  9    u     u     u     u     u     u     u
[10] 10   u     u     u     u     u     u     u
[11] 11   u     u     u     u     u     u     u
[12] 12   u     u     u     u     u     u     u
[13] 13   u     u     u     u     u     u     u
[14] 14   u     u     u     u     u     u     u
[15] 15   u     u     u     u     u     u     u
Enter Review, Validate, screen#, or Print: _

```

Figure 4-22. Sample of ceqccu Form Screen

**Reference** For more information on the switch views see Lucent documentation 401-610-036 *Database Update*.

# cell2 Form

---

**Purpose of the Form** The *cell2* form is a multi-screen form used to make both hardware and call processing assignments. Screen formats change depending on the field displayed.

**cell2 Sample Screen** The screen sample, shown in Figure 4-23, shows *cell2*, screen 1 of 14 populated with the information for cell site number 8. The fields marked with a plus (fields 2, 3, and 4) are optional.

```

AUTOPLEX
Cellular          SERIES 2 CELL (cell2)          Screen 1 of 14
System

Cell Site Number..... *1) 8
ACC Location Area ID..... +2)
DCCH Virtual Mobile Location Area..... +3)
CDMA Registration Zone ID..... +4)
Cellular Geographic Service Area..... 5) 1
Switch Identification..... 6) 5
Virtual Switch Identification..... 7)
CDMA Switch Identification..... 8) 5
CDMA Virtual Switch Identification..... 9)
Cell Site Status..... 11) e
Location Equipped Antenna Faces..... 12) 0
Wait for Overhead Message..... 13) n
Frame Technology Type:
    (Controller) Frame 0..... 14) s2
    (Growth) Frame 1..... 15) c
    (Growth) Frame 2..... 16) u

Enter Review, Change-insert, Validate, screen#, or Print: █
    
```

*Figure 4-23. Sample of cell2 Form Screen*

**Reference** For more information on the switch views see Lucent documentation 401-610-036 *Database Update*.

# ceqcom2 Form

**Purpose of the Form** The RC/V *ceqcom2* form contains information concerning microcell site equipment configuration, status, and maintenance-related parameters for an individual microcell. The values on the *ceqcom2* form take precedence over the values on the *ecp* form.

**ceqcom2 Screen Sample** The screen sample, shown in Figure 4-24, shows *ceqcom2*, screen 1 of 13 populated with settings for cell site number 8.

```

AUTOPLEX
Cellular          SERIES 2 CELL EQUIPAGE COMMON (ceqcom2)   Screen 1 of 13
System

Cell Site Number.....*1) 8           Calibration Generator 13) e
Equipped Network Control Interfaces.... 2) 1       Reference Generator-1 14) e
Multiple Physical Antenna Faces..... 3) n           Status - Data Link 0. 15) e
Voice Radio Location Time Interval(sec) 4) 4         - Data Link 1. 16) e
Periodic Locate Interval (sec)..... 5) 3
TDMA Periodic Best Server Locate (sec). 6) 0
Thresholds:
- Received Signal Strength Diversity.. 7) 15
- Uncorrectable BCH Report (RSSI)..... 8) 53
- Dotting Detection - Setup Radio..... 9) 400
- Voice Radio.... 10) 750
- Radio Test Unit 11) 750
TDMA Measurement Processing Interval.. 12) 2

Enter Review, Change-insert, Validate, screen#, or Print: █

```

**Figure 4-24. Sample of ceqcom2 From Screen**

**Reference** For more information on the switch views see 401-610-036.

## ceqface Form

---

**Purpose of the Form** The *ceqface* form contains call processing parameters for an individual face.

**ceqface Screen Sample** The sample screen, shown in Figure 4-25, is *ceqface* screen 1 of 10 shown populated with settings for face 3 of cell site number 8.

AUTOPLEX Cellular System	CELL EQUIPAGE FACE (ceqface)	Screen 1 of 10
Cell Site - Number.....*1)		<u>8</u>
- Physical Antenna Face.....*2)		<u>3</u>
Voice Radio Output Power (uv)		
- Server Group 0..... 3)		<u>3423000</u>
- Server Group 1 (or Simulcast Setup Output Power)... 4)		<u>3423000</u>
Transmitter Return Loss (uv)..... 5)		<u>1300000</u>
Received - Equipment Path Loss (RSSI)..... 6)		<u>100</u>
- Return Loss (RSSI)..... 7)		<u>17</u>
AMPS Voice Radio Attenuation Level - Server Group 0..... 8)		<u>0</u>
- Server Group 1..... 9)		<u>0</u>
TDMA Voice Radio Attenuation Level - Server Group 0..... 10)		<u>0</u>
- Server Group 1..... 11)		<u>0</u>
Antenna Diagnostic Tests..... 12)		<u>n</u>
Series 2 Cell Site Information ONLY: (RSSI)		
Received Signal Strength Calibration - Diversity 0.. 13)		<u>89</u>
- Diversity 1.. 14)		<u>89</u>
Received Equipment Path Loss - Diversity 1.. 15)		<u>100</u>
Receive Path Gain (RSSI)..... 16)		<u>19</u>
Enter Review, Validate, screen#, or Print: █		

*Figure 4-25. Sample of ceqface Form Screen*

**Reference** For more information on the switch views see Lucent documentation 401-610-036 *Database Update*.

# Microcell Documentation

---

## **Overview of the FLEXENT-AUTOPLEX Documentation**

---

### **Purpose of the FLEXENT- AUTOPLEX Documentation**

The FLEXENT-AUTOPLEX Documentation provides the information support necessary for the operation and maintenance of a microcell.

The documentation is essentially composed of two document sets:

- Microcell Schematic Diagrams that depict component connectivity
- Customer documentation contained in a CD-ROM

## Schematic Diagrams

**Overview** Schematic diagrams (SDs) are multi-page (sheet) documents. They support particular applications. Of direct interest to maintenance personnel will be the SDs that relate to cabling and connections. These SDs document the circuit paths used in troubleshooting.

**Schematic Diagrams Sample** Figure 4-26 shows the diagram identification information located in the lower right corner of all schematic diagrams.

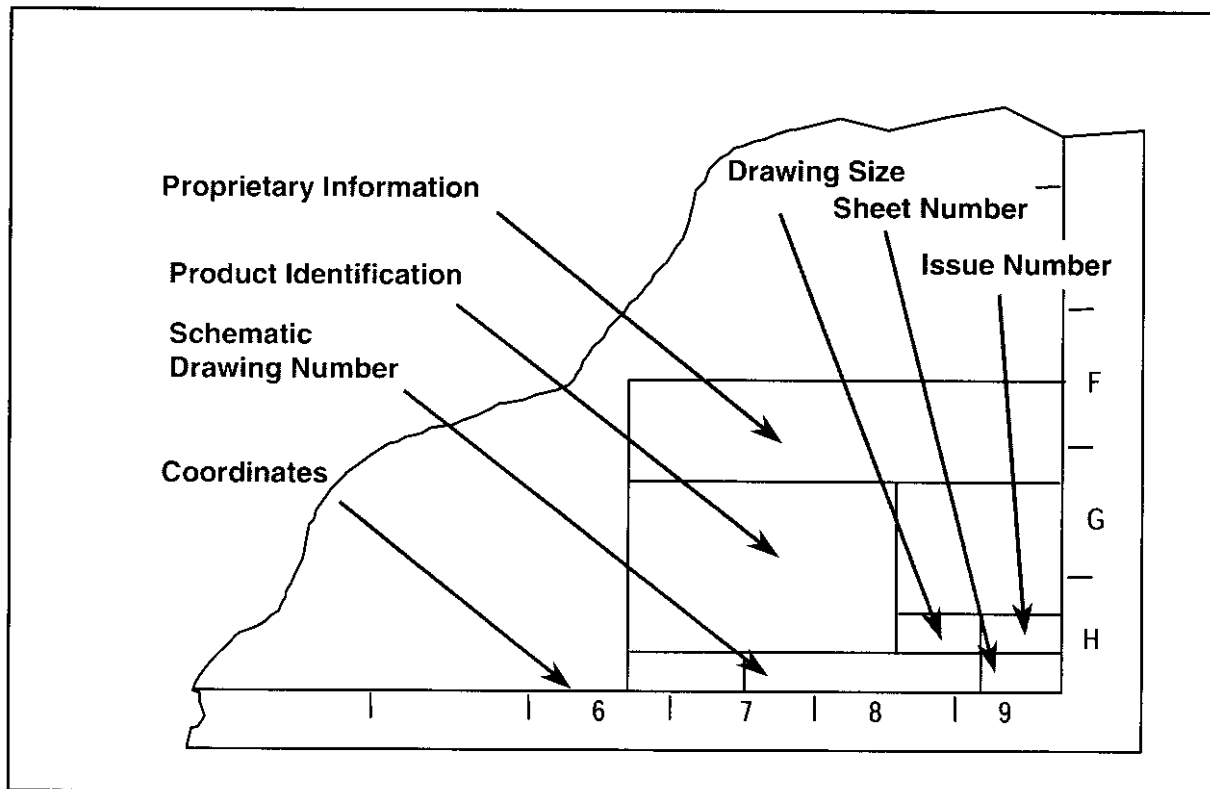

*Figure 4-26. Diagram of a SD Caption*

**Layout** All SDs provide an SD number, a sheet number, and an issue number. Coordinates to items in the SD are provided in the margin.

Additional information includes proprietary information and product name.



**SD Sheets** SD sheets are arranged alphabetically from A to H, and contained the following information:

<b>SD Sheets</b>	<b>Sheet Name</b>	<b>Sheet Contains</b>
A	Index	Issue date(s), sheet indices to all SD pages
B	FSs (Functional Schematics)	Graphic information about the circuit(s)
C	Apparatus Figures	Component specific information, such as Lucent Technologies comcodes and manufacturer numbers
D	Circuit Notes	Explanation of notes referenced within FSs
E	Circuit Description (CD)	Text description of the circuits appearing in SD-2R349 (Note that most SDs do not contain a CD)
F	Not used in this SD	Not used in this SD
G	CADs (Cabling Diagrams)	Specific interconnection cabling information
H	BDs (Block Diagrams )	High-level interconnections between major units

The SD issue number is located on the top right corner of sheet A1.

In the lower right corner, sheet A1 contains a count of the total number of SD sheets in the set.

Page designations, such as A1 or B17, are located on the lower right of each sheet.

# Technical Documentation -- FLEXENT-AUTOPLEX CD-ROM

---

## The Flexent- Autoplex Documentation

All Customer documentation is available on CD-ROM and published in the Dynatext<sup>(R)</sup> format.

## Using the Documentation

For viewing, the CD-ROM needs to be installed on the customer's PC, running under Microsoft Windows<sup>(R)</sup> 3.1 or better. Once installed, the documentation appears in a series of windows, as shown in Figure 4-27.

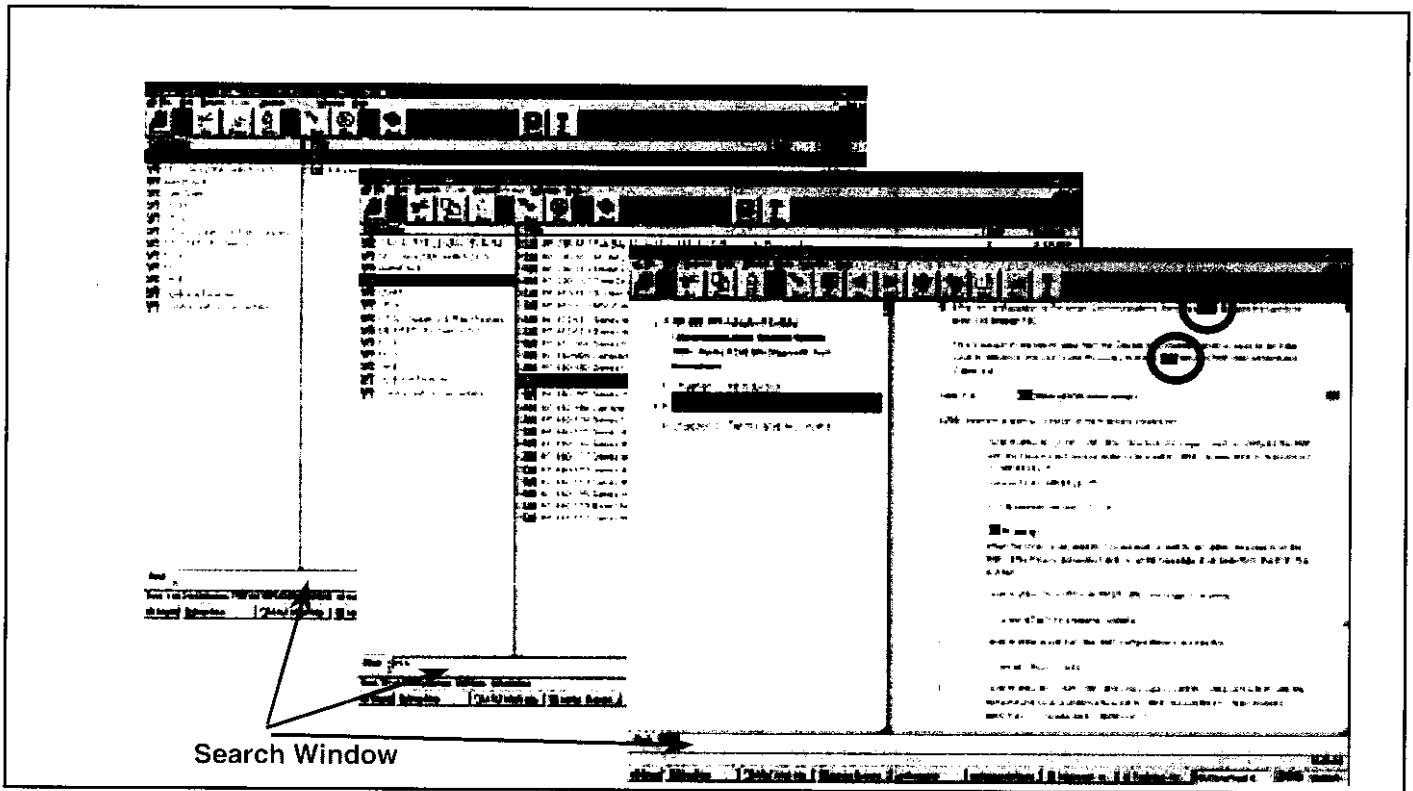

*Figure 4-27. Windows from the FLEXENT AUTOTPLEX CD-ROM documentation*

## Description of the Display

The documentation display is a double-pane layout. Access to the documentation is accomplished through a list of topics in the left-hand side pane.

Selecting a topic in that pane displays the corresponding documentation available in the right-hand side pane.

Selecting the requested documentation in the right-hand pane opens another screen corresponding to that specific documentation, with a

running table of contents in the left-hand pane, and the text in the right-hand pane.

Selecting an item in the table of contents displays the corresponding text.

A window at the bottom of the screen enables a full text search.





# 5 CDMA Microcell Maintenance

## CDMA Microcell Site Maintenance

- Introduction** Maintenance activities can be classified into one of three categories:
- Preventive (or Routine) maintenance covers the activities necessary to prevent cell malfunction.
  - Corrective maintenance covers the activities that take place to correct a cell malfunction.
  - On-demand maintenance covers optional activities, such as the upgrade of cell generic, aimed at improving cell operation in the absence of cell malfunction.

Excluding housekeeping tasks (leaf and snow removal, cleaning of filters, etc.), most of the preventive maintenance, such as routine diagnostics, can be done from the MSC.

<b>Contents</b>	<ul style="list-style-type: none"> <li>• Operation and Maintenance Overview</li> <li>• Operation vs. Maintenance</li> <li>• Reasons for Maintenance</li> <li>• The Maintenance Process</li> <li>• Maintenance Targets</li> <li>• Routine (Preventive) Maintenance</li> <li>• Preventive Maintenance Schedule</li> <li>• Corrective Maintenance</li> <li>• Levels of Corrective Maintenance</li> </ul>	<p>2</p> <p>3</p> <p>4</p> <p>5</p> <p>6</p> <p>7</p> <p>8</p> <p>9</p> <p>10</p>
-----------------	---	---

• Test Equipment Maintenance	11
• Precautionary Steps	12
• Automatic Diagnostic Tests	13
• Manual Routine Diagnostics	14
• Maintenance Records	15
• Corrective Maintenance Triggers	16
• Maintenance Actions	18
• Maintenance Units	19
• Maintenance Commands	20
• Maintenance States	21
• Conditional Remove	22
• Unconditional Remove	24
• Conditional Restore	25
• Unconditional Restore	26
• Diagnose Command	27
• Stop a Diagnostic	28
• Initialize a Site	29
• Operational Status	30
• Out-Of-Service State Qualifier	31
• Using the Remote Maintenance Terminal (RMT)	32
• Performing Maintenance with the RMT	33
• Maintenance Task Hierarchy	34
• Overall Task Hierarchy	35
• Site Operation and Maintenance Tasks	36
• Site Maintenance Tasks	37
• Site Routine Maintenance	38
• Site Corrective Maintenance	39
• On-demand Site Maintenance	40
• Cell Site Equipment Operation and Maintenance Tasks	41
• Cell Site Equipment Operation	42
• Cell Site Equipment Maintenance Tasks	43
• Equipment Routine Maintenance Tasks	44
• Cell Site Equipment Corrective Maintenance Tasks	45

- On-Demand Maintenance Tasks 46
- Required Maintenance Equipment 47

## Operation and Maintenance Overview

---

### Microcell Operation and Maintenance

- |  |   |
|--|---|
| <b>Purpose of this Section</b>               | This unit is designed to enable microcell technicians to perform the tasks necessary to ensure sustained and continued service from microcells.   |
| <b>The Operation and Maintenance Concept</b> | <p>Operation and Maintenance is defined as the set of tasks that need to be performed by individuals responsible for the continued operation of a microcell.</p> <p>Depending on the circumstances, operation and maintenance tasks may be performed:</p> <ul style="list-style-type: none"><li>• Routinely to ensure that the microcell is operating according to specifications</li><li>• Correctively to respond to a microcell malfunction</li><li>• On demand to improve upon the microcell operating condition.</li></ul> |



## Operation vs. Maintenance

---

- Perspective** While maintenance and operation involve overlapping activities with a common goal of maximizing microcell availability and performance, these functions correspond to two different perspectives:
- Operation relies on sets of procedures (e.g., Standard Operating Procedures)
  - Maintenance requires following specified processes (e.g., diagnostics)
- The distinction takes on some importance in cases of conflicting requirements, such as routine maintenance conflicting with operational staff availability.
- Management Issues** Operation essentially involves user issues, such as selection of personnel or records retention practices.
- Maintenance involves contractual issues, such as risks of loss of warranties if recommended practices are not followed.
- A successful maintenance program will optimize the operational costs of maintenance.
- Logistics Issues** One way of keeping maintenance costs down will be to optimize maintenance logistics. Examples where logistics can be optimized are:
- Balancing maintenance workload between the MSC and the microcell
  - Pooling of test equipment

## Reasons for Maintenance

---

- Purpose** The purpose of maintenance is to minimize the possibility and effects of a system failure. To support that purpose, the maintenance process must be able, in the event of a system failure, to collect information as to its cause, and to provide the tools necessary to correct the situation.
- Objectives** The objective of the maintenance process is to maximize system performance and availability at the lowest cost possible. Ways to reduce these costs include the elimination of unnecessary initializations, diagnostics, and cell site visits.

## The Maintenance Process

---

**Maintenance Activities/  
Maintenance Levels**

There are three different types of maintenance, each with specific concerns:

- Preventive (or routine) maintenance is concerned with tasks that will reduce the probability of failure. Examples of such tasks are cleaning and monitoring of performance.
- Corrective maintenance is concerned with the speedy elimination of a cause or potential source of failure. An example of corrective maintenance is the replacement of failing circuit boards.
- On-demand maintenance concerns tasks that are performed on a microcell, even though the microcell is still operating properly. An example of on-demand maintenance is the addition of capacity.

**Responsibilities**

Responsibilities for maintenance are shared between the cell site that reports and analyzes any microcell malfunction to the ECP, the ECP that attempts to correct these malfunctions through software, and the microcell technician who performs any required physical intervention.

# Maintenance Targets

---

**Introduction** CDMA microcell maintenance addresses specific targets, including site, test equipment, and frame and ancillary equipment.

## Site

Performance and scheduling of site maintenance (access roads, fences, etc.) are determined according to local practices, and may be contracted out.

For instance, maintenance and repairs to the microcell supporting post may be provided by an outside vendor, but microcell technicians would be expected to visually inspect the anchoring of the frame to that post whenever they happen to be at the cell site.

## Frame and Ancillary Equipment

Maintenance of the microcell frame and ancillary equipment involves both physical and functional inspection, either on schedule or as part of a diagnostic action to respond to an equipment failure.

## Test Equipment

In addition to cell specific maintenance tasks, it is recommended that periodic maintenance be performed on the test and other maintenance equipment. Such maintenance should be performed according to manufacturer's instructions. Of critical importance are the maintenance and calibration of reference standards, such as calibrated attenuators used to calibrate performance measurement equipment.

**Measurements** Some of the inspections may involve physical measurements outside the scope of this document. For instance, verification of the cell ground connection may require a measure of its electrical resistance.

# Routine (Preventive) Maintenance

---

## Overview

---

### **Purpose of Routine (Preventive) Maintenance**

The purpose of routine maintenance (also called preventive maintenance) is to perform activities that will reduce the risk of equipment failure. Corresponding tasks are outlined in "Overall Task Hierarchy" on page 5-33.

### **Preventive Microcell Site Maintenance**

Some of the preventive maintenance tasks performed outside a microcell are often outsourced. These tasks include:

- Visual inspection of antennas, groundings, etc., to identify and remedy potential sources of hazards.
- Maintenance of the site, such as snow removal, trimming shrubs, etc.
- Drive testing is a maintenance task performed on a periodic basis to meet regulatory requirements and to identify progressive degradation of performance. It involves measuring and comparing wireless signals to original specifications.

### **Preventive Microcell Equipment Maintenance**

Preventive microcell equipment maintenance includes:

- Inspection of frame hardware to verify its proper functioning.
- Automatic software diagnostics to identify failing units, especially for standby equipment. Such diagnostics are scheduled to minimize impact on service.

## Preventive Maintenance Schedule

---

**Overview** Preventive maintenance is done according to a schedule that reflects local operating requirements.

**Schedule** TO BE ADDED

**Sample Preventive Check** Some suggestions for preventive maintenance checks on microcells are shown in Figure 5-1.

PREVENTIVE CHECK	INTERVAL
• Site condition	Each Visit or 3 month
• Frame	Each Visit or 3 month
- Cabling	
- Weather seals	
- Alarm LEDs	
- Electrical power levels	
- Ventilation (Cooling fins and, if equipped, cooling fans)	
• FCC Measurements	12 Mo.

*Figure 5-1. Sample of Preventive Maintenance Schedules*

**Equipment Test List** TO BE ADDED

# Corrective Maintenance

---

## Corrective Maintenance Overview

**Introduction** Preventive maintenance may identify potential sources of microcell failure before they interfere with service. For instance, preventive maintenance may locate a failing board in a redundant unit, and thus allow its timely replacement.

Corrective maintenance addresses the detection of failing units while in service.

Procedures to remedy a failing unit, whether it has been diagnosed as part of preventive or corrective maintenance, are the same once the cause of failure has been identified.

## Levels of Corrective Maintenance

---

- Overview** Corrective maintenance is event driven. Corrective maintenance will usually be triggered by an alarm, or by visual observation of physical damage to the cell or the cell site.
- MSC Level** MSC level corrective maintenance covers maintenance actions that do not need technician intervention at the cell. These actions are software initiated, such as through a restore command to reset the cell after an outage.
- Microcell Level** This type of maintenance requires physical intervention at the cell site. microcell level maintenance usually corresponds to the need to replace a microcell component.
- Advanced** This level of maintenance corresponds to situations where corrective actions require expert assistance. Examples of such situations would be the replacement of components destroyed by lightning.



## Test Equipment Maintenance

---

**Overview** Test equipment needs to be maintained to ensure that its outputs are meaningful.

**Equipment Maintenance Checks** The components that need to be maintained are cables and probes, as well as calibration devices such as attenuators.

Equipment maintenance should be performed according to manufacturer's specifications, using up-to-date software.

## Precautionary Steps

---

**ESD Procedures** Proper electrostatic discharge (ESD) practices must be followed whenever handling circuit packs or working inside a microcell cabinet.

**Other Precautions** Whenever handling cables and connections:

- Avoid sharp bends
- Follow required procedures for the handling of connections, especially those requiring the use of torque wrenches.

Never disconnect a live RF cable or apply power to an RF unit that is in a transmit mode.

Make sure that the microcell is out of service before opening a cell frame if that cell is equipped with an integrated antenna.

**Handling Circuit Packs** Follow the ESD procedures listed in Lucent document 401-660-125, *Circuit Maintenance Procedures*, chapters 1 and 4. That information can also be found in the Lucent CD-ROM documentation under the term “*esd*”.

When handling equipment or working in the backplane area, a grounded antistatic wrist strap must be worn to protect the equipment from electrostatic discharge (ESD). The following guidelines should be used when handling circuit packs:

- Unless otherwise specified by the procedure, power should be turned off before inserting or removing a circuit pack.
- Carry the circuit pack in its electrostatic bag and other packing materials to the replacement site before removing it from packaging.
- Before replacing a circuit pack, check the identification code to ensure the proper board is being used.
- Identify and count circuit packs before removing packs from their antistatic packaging material.

## Diagnostic Tests

---

**Diagnostic Tests** The microcell supports two different testing and diagnostic modes:

- Primary through the microcell Test Port
- Alternate through the microcell Craft Interface port

Diagnostic tests can be run:

- Automatically
  - On schedule as part of routine maintenance
  - By software control when a fault is detected
- Under manual control from the appropriate terminal

**Automatic Fault Isolation** When using the RMT, fault isolation is launched by clicking on the Test Menu in the Task Bar, and selecting the fault isolation option. In the RMT's Message Window, the RMT returns a list of maintenance objects with their associated BLSTs and the result of the fault isolation process.

When using the alternate approach, automated tests are run in groups which address specific areas of a wireless system. Within each test group, individual tests are broken into phases that are themselves broken down into segments, enabling a top-down fault isolation process.

Results are displayed differently depending on whether primary framework diagnostics are used or not. When a test fails:

- Primary mode test displays directly indicate the probable failing unit.
- Alternate mode test displays indicate the number of the phase and segment that has failed the test. Identification of the failing unit requires an analysis of that indication. The fault isolation process for alternate mode diagnostics is discussed in detail in Chapter 6.

## Corrective Maintenance Triggers

---

<b>Sources of Errors</b>	<p>Sources of errors that will require corrective action are:</p> <ul style="list-style-type: none"> <li>• Hardware errors due to, for instance, a faulty microprocessor or a synthesizer out of lock. These errors are detected by on-board self tests.</li> <li>• Software errors due to, for instance, loss of program control.</li> <li>• Voice channel errors, such as access/failure rates.</li> <li>• Mobile errors due to, for instance, poor transmission conditions.</li> </ul>
<b>Handling of Errors</b>	<p>All the errors are analyzed by the Hardware Error Handler (HEH) at the MSC.</p> <p>Depending upon the severity of the error, HEH either takes immediate recovery action through the Maintenance Request Administrator, waits until the error has occurred a predefined number of times before taking action, or only prints an error report.</p>
<b>Immediate Action</b>	<p>For severe errors that are service-affecting, such as loss of communication between the MSC and the cell, HEH takes immediate action. For most on-board hardware errors, HEH will request a conditional restore of the suspect unit.</p> <p>The conditional restore maintenance action schedules an event or process to restore the suspect unit after the unit passes a diagnostic test. If the unit fails the diagnostic test, the conditional restore aborts. The failed unit remains in the out-of-service state.</p>
<b>All Tests Pass (ATP) Analysis</b>	<p>For an HEH-initiated conditional restore request, if the unit passes all diagnostic tests the unit is restored to service, and HEH adds a count to an ATP counter for the unit. If that count exceeds an assigned threshold within a predefined time period (typically three in 40 minutes or five in 24 hours), HEH will request a conditional remove of the unit (the diagnostic tests for the unit may not be robust enough to detect the problem, or the problem is external to the unit). This type of error analysis prevents a recovery cycle that might otherwise continue indefinitely.</p>
<b>Single Time-Period Analysis</b>	<p>This type of analysis refers to the use of error counters assigned to each hardware unit (CRC, CCU, CBR, and so on). If an error count for a unit remains below a predefined threshold for a specific period of time,</p>

HEH clears the counter. This type of error analysis is based on the theory that if a unit has remained reliable for an extended period of time, its error history should be disregarded.

**Fail/Pass Analysis** HEH performs this type of error analysis on call-processing detected errors such as voice channel confirmation failures. When the number of failures exceeds some predefined value relative to the number of successful attempts (such as 2400 failures in 4000 attempts), HEH takes recovery action.

**Leaky Bucket Analysis** This analysis refers to the decrementing of non-zero error counters for the configurable hardware units. The decrementing is done at set time intervals. This technique is more flexible than a simple analysis based on the number of errors in a single fixed period of time. That is, the count is incremented each time the error being tracked occurs on the circuit involved. If a specified number of errors have accumulated in a specific amount of time, the circuit is usually taken out-of-service. If the error has not occurred in a given amount of time, the count will be decremented. If the count reaches zero, the error block is released.

**Reference** For more information on HEH messages, see Lucent documentation 401-610-075 *System Routine Operation and Maintenance*.

## Maintenance Records

---

<b>Need for Maintenance Records</b>	Maintenance records keep a history of maintenance activities. Maintenance records are necessary to document microcell operation, and to facilitate the performance of any required corrective actions.
<b>Types of Maintenance Records</b>	Typical records would include: <ul style="list-style-type: none"><li>• Dates of maintenance visits to the microcell</li><li>• Description of maintenance tasks performed</li><li>• Repair and performance logs, such as performance measurements</li><li>• Reference documents (such as microcell installation and engineering diagrams)</li><li>• Up-to-date microcell configuration data (e.g., software release)</li></ul>
<b>Guidelines for Maintenance of Records</b>	Maintenance records should be kept at the microcell site for use by maintenance personnel and for audit purposes.  Maintenance records should be neatly organized in folders, with drawings and logs kept in a “clean” format to ensure their long term availability.

# Microcell Maintenance Principles

---

## Overview

---

### Selecting the Appropriate Maintenance Mode

The primary (RMT-based) and alternate maintenance modes represent two different implementations of the FLEXENT-AUTOPLEX maintenance strategy.

In particular, as the RMT automates the manual entry of line commands needed for the alternate mode, it performs many of the same functions.

This section describes some of these functions, and summarizes the corresponding commands that would need to be entered from the craft shell if the RMT was not available.

### Maintenance Actions

Maintenance actions are instructions that lead to a change in cell status.

#### Allowed Actions

Allowed maintenance actions depend on the hardware element.

Maintenance actions can be applied to maintenance units through commands from the ECP or by cell site software processes.

#### Conditional or Unconditional

Some maintenance requests, such as remove and restore, can be conditional or unconditional. In general, a conditional maintenance request will not result in any action that causes calls to be dropped or service to be denied to a user during the course of command execution; if executing a conditional request would violate either condition, MRA rejects the request. In contrast, an unconditional maintenance request will result in the execution of the request immediately or within 5 minutes of MRA accepting the request, with little concern as to whether calls are dropped or service is denied to a user during the course of command execution.

#### Maintenance Action Reporting and Control

All maintenance actions (remove, restore, diagnose, stop a diagnostic, switch to redundant unit, and obtain status) are reported to the ECP.

Once a maintenance action has started on a maintenance unit, MRA will reject any subsequent maintenance-action requests for that unit until the current action has completed (except for stopping a diagnostic, which it will honor immediately).

<b>Maintenance Units</b>	Maintenance units are hardware elements that report their status to the ECP.
<b>Maintenance Commands</b>	Maintenance commands initiate maintenance actions on maintenance units.

**Automatic Recovery**

The microcell periodically performs automatic self-test diagnostics. In case of the failure of a given test, it will automatically attempt to recover by the initiation of a restore command.

**Manual Intervention**

In situations where no automatic recovery action is taken or automatic recovery action fails, the technician must perform manual recovery. These procedures can be performed from the ECP, either directly at the ECP or from the cell site with commands placed to the ECP through one of the user interfaces.

When manual intervention is required, the RMT or the cell site status display pages provide easy methods for entering maintenance commands.

Maintenance commands entered through a “poke” command in the cell’s SDPs include:

- Removing (deactivating) units
- Restoring (activating) units
- Diagnosing (testing) units
- Generating status output message reports on units
- Initialization
  - Phase monitoring
- Inhibiting/Allowing
  - Audits
  - Audit/HEH output
  - Call processing
  - Forward setup channel control (normally inhibited)
  - Functional tests
  - Interrupts
  - Routine diagnostics



**Maintenance States** A maintenance state is the operating condition of a piece of equipment. During installation, each unit is assigned an equipment state of either unequipped, growth, or equipped via translations (system configuration parameter settings). Each equipped unit is further assigned a state of active, out-of-service, or standby (redundant unit only) via maintenance requests sent to the Maintenance Request Administrator (MRA) subsystem.

#### **Meanings**

The meanings of the maintenance states are as follows:

- **Active:** Unit is available for its intended use.
- **Standby:** Unit is available to be placed into the active state.
- **Out-of-service:** Unit is not available for its intended use (exact opposite of active state), but is available to be diagnosed or updated with NVM.
- **Growth state:** Unit is not available to be placed in use, but is available to be diagnosed or updated with NVM.
- **Unequipped:** Unit exists in the translations database strictly as a place holder. MRA will reject any maintenance request targeted for an unequipped unit.

Throughout the maintenance process, MRA records locally the maintenance status of the cell site equipment in the equipment status table. The maintenance status of equipment is reported to the ECP when the status changes or the ECP requests an update. The status of cell site equipment appears in the SDPs.

## Conditional Remove

---

**Definition**     **Conditional Remove** *A maintenance action that changes the state of a maintenance unit from active or standby to out-of-service. It schedules an event or process to place the specified maintenance unit to out-of-service assuming that it is NOT busy (in active state and currently performing its intended purpose), such as a CE supporting an active call.*

**Format of Remove Command**     The craft shell format of the *rmv* command format is shown on Figure 5-2.

*rmv:cell a,b*  
a: cell number, b= unit to be removed

**Figure 5-2. Remove Command Format**

**Redundant Units**     For redundant units, if the unit is in the standby state when the conditional remove action is applied, the unit is removed from service immediately. If the unit is in the active state and the mate is in the standby state when the conditional remove action is applied, MRA automatically executes a switch before removing the unit from service. If the unit is in the active state and the mate is in the out-of-service state when the conditional remove action is applied, the conditional remove aborts with no action taken.

**Removing Out-of-Service Units**     If the unit is already out-of-service when the conditional-remove action is applied, the unit is taken out-of-service again and tagged with the qualifier OOS-RMV. OOS-RMV means that the unit is out-of-service due to a remove request—as opposed to being out-of-service due to a diagnose request, for example. This statement is also true for an unconditional-remove request of an out-of-service unit. Other conditions that will cause the conditional remove to abort with no action taken are described as follows:

- A conditional remove action on a unit in the growth state is not permitted.
- If placing the unit out-of-service would result in exceeding the out-of-service threshold limit for that type of unit, the conditional remove action is not permitted.

**Out-of-Service Threshold** System considerations place threshold limits to the number of CDMA channel elements (CEs) that can be out-of-service. That number is specified in the RC/V form *cell2*.

**References** For more information on the remove maintenance action, refer to the RMV CELL commands in Lucent documentation 401-610-107 *Cell Site/DCS Input Output Messages*.

# Unconditional Remove

---

**Definition**     **Unconditional Remove** *A maintenance action that changes the state of a maintenance unit from active or standby to out-of-service.*

Unconditional remove requests may be service-affecting because of the out-of-service limits that may be exceeded.

**Unconditional Remove Format**

The craft shell format for unconditional remove is shown on Figure 5-3.

```
rmv:cell a,b;ucl  
a: cell number, b= unit to be removed
```

*Figure 5-3. Format for Unconditional Remove command*

**Conditions Keeping Unit in Service**

the unconditional remove command promptly places the specified maintenance unit in the out-of-service state unless any of the following conditions are in effect:

- The unconditional remove action is targeted for a busy CCU. The remove is deferred for up to 5 minutes. If the unit is still busy after 5 minutes, MRA drops the calls and removes the unit from service.
- The unconditional remove action is targeted for a unit in the growth state. The unconditional remove aborts with no action taken.

## Conditional Restore

---

**Definition**      **Conditional Restore** *A maintenance action that brings a unit back to service.*

**Format of the Conditional Restore Command**      The craft shell format of the conditional restore command is shown on Figure 5-4.

*rst:cell<sup>^</sup>a,b*  
a: cell number, b= unit being restored

*Figure 5-4. Format of the Conditional Restore Command*

**Use of the Command**      The restore maintenance action can be applied to units that are in the out-of-service, active, or standby states. Except for a unit that is already out-of-service or in the growth state, the first step in a conditional restore maintenance action is the automatic execution of a conditional remove. Therefore, all the restrictions associated with a conditional remove are also associated with a conditional restore.

**Restoring Out-of-Service Units**      The conditional restore maintenance action changes the state of a maintenance unit from out-of-service to active unless the command specifies a standby state. It schedules an event or process to restore the specified maintenance unit after the unit passes a diagnostic test. If the unit fails the diagnostic test, the conditional restore aborts. The failed unit remains in the out-of-service state.

**Restoring Units in a Growth State**      A conditional restore request on a unit in the growth state will diagnose and initialize the unit but will not change the state of the unit: the unit remains in the growth state. An unconditional restore of a unit in the growth state is not permitted.

**Conditional vs. Unconditional Restore**      The primary difference between a conditional and an unconditional restore is that the conditional restore runs a diagnostic first while the unconditional does not.

## Unconditional Restore

---

**Definition**     **Unconditional Restore** *Similar to the conditional restore command, except for a unit that is already out-of-service or in the growth state, the first step in an unconditional restore maintenance action is the automatic execution of an unconditional remove. Therefore, the lack of restrictions associated with an unconditional remove—unconditional remove requests may be service-affecting—are also associated with an unconditional restore.*

**Unconditional Restore Format**     The craft shell format of the unconditional restore command is shown on Figure 5-5.

```
rst:cell a,b;ucl
a: cell number, b= unit being restored
```

**Figure 5-5. Format of the Unconditional Restore Command**

**Conditions Keeping the Unit OOS**     The unconditional restore maintenance action changes the state of a maintenance unit from out-of-service to active unless the command specifies a standby state. It schedules an event or process to restore the specified maintenance unit without first running a diagnostic test on the unit.

**Conditions Applying to Restore Requests**     The technician must be aware of the following conditions pertaining to conditional and unconditional restore requests:

- For data links (DLs) a conditional restore request reverts to unconditional if there is no link currently in-service; no diagnostic test is run.
- No action is performed if an unconditional restore request is made on the currently in-service link.

**References**     For more information on the restore maintenance action, refer to the RST CELL commands in Lucent documentation 401-610-107 *Cell Site/DCS Input Output Messages*.

## Diagnose Command

---

**Definition** **Diagnose** *Diagnose is a maintenance action that can be applied to a unit in the out-of-service or growth state, to a redundant unit in the standby state, or to a redundant unit in the active state. In the latter case, MRA initiates a switch before executing the diagnose request.*

For redundant units, if the targeted unit is in the active state but the mate is out-of-service, the diagnose aborts with no action taken.

**Format of Diagnose Command** The craft shell format of the diagnostic command is shown on Figure 5-6.

```
dgn:cell_a,b[;ucl][:tlp]
```

a: cell number, b= unit being diagnosed

**Figure 5-6. Format of the Diagnose Command**

**Diagnosing a CCU** In addition, the diagnose maintenance action can be applied to a CCU in the active state. The first step in a diagnose maintenance action for an active CCU is the automatic execution of a conditional remove.

Regardless of whether a unit passes or fails diagnostics, the unit is left in the out-of-service state except for a unit in the growth state. A unit initially in the growth state remains in the growth state. The diagnostic test results (pass, fail) are reported to the ECP.

**Diagnosing a CSC** A diagnostic test can be called for the whole CSC (in which all controller circuit boards are tested), or for an individual controller circuit board (for example, CPU).

**References** For more information on the diagnose maintenance action, refer to the DGN CELL commands in Lucent documentation 401-610-107 *Cell Site/DCS Input Output Messages*.

## Stop a Diagnostic

---

**Definition**     **Stop** *Stop is a maintenance action that stops a diagnostic test on a maintenance unit. If the diagnostic test request is still in the job queue, MRA removes the request from the queue. If the diagnostic test is running, MRA aborts the test.*

MRA leaves the unit in the out-of-service or growth state. Upon terminating a diagnostic test for one of those units, MRA returns the unit to the state it was in just prior to the diagnostic request (out-of-service, growth, or active).

**Format of the Stop Command**

The craft shell format of the stop command is shown on Figure 5-7.

*stop:dgn;cell a,b*  
a: cell number, b= unit being diagnosed

**Figure 5-7. Format of the Stop Command**

**References**     For more information on the diagnostic maintenance action, refer to the STOP CELL commands in Lucent documentation 401-610-107 *Cell Site/DCS Input Output Messages*.



## Initialize a Site

---

**Purpose of the Command** The purpose of this command is to reset a cell site operating parameters to their specified values.

**Command Format** Table 5-1 shows the craft shell command formats to initialize a cell site.

**Table 5-1. Commands to Initialize a microcell site**

To request a ...	Enter...
system process purge at a specific cell site	INIT:CELL a:SPP b[ CLASS c]
specific cell site phase	INIT:CELL a:{ TCISC }[ CLASS c]
cell site memory boot	INIT:CELL a:BOOT[IE][ CLASS c]
cell site memory boot	INIT:CELL a:BOOT[IE];SW

**References** For more information on the diagnostic maintenance action, refer to the INIT: CELL commands in Lucent documentation 401-610-107 *Cell Site/DCS Input Output Messages*.

## Operational Status

---

**Definition** **Op** *The Operational Status maintenance action (OP) determines the status (state) of a maintenance unit; that is, Maintenance Request Administrator (MRA) reads the recorded status from the equipment status table and forwards the status to the Access Manager.*

In addition, MRA automatically reports the maintenance status of the equipment to the Access Manager whenever the status changes. A status display page is refreshed with new maintenance status every 15 seconds.

**Format of the Operational Status command**

The format of the operational status command is shown on Figure 5-8.

<p><i>op:cell<sub>^</sub>x</i></p> <p><i>op:cell<sub>^</sub>x,unit<sub>^</sub>y</i></p> <p><i>op:cell<sub>^</sub>x,extern</i></p> <p><i>op:cell<sub>^</sub>x:generic</i></p>
--

**Figure 5-8. Format of the Operational Status Command**

**References** For more information on the operational status maintenance action, refer to the OP CELL, OP CELL DL, OP CELL DLOPTS, OP CELL EXTERN, OP CELL GENERIC, OP CELL OVLD, OP CELL SCISM, OP CELL SG, and OP CELL VERSION commands in Lucent documentation 401-610-107 *Cell Site/DCS Input Output Messages*.

## Out-Of-Service State Qualifier

---

**Definition**    **Out-of-Service (OOS)** *The state qualifier is a message from the Maintenance Request Administrator (MRA) to indicate the reason why a particular unit is in an out-of-service state.*

**Purpose of OOS Qualifier**    A maintenance unit can be placed in the out-of-service state due to one of several reasons. To identify the reason that a unit is in the out-of-service state, MRA assigns the unit a qualifier in addition to its final state of OOS.

Both the qualifier and the final state of the unit are reported to the Access Manager. Both appear in the ROP message.

**Examples of Out-of-Service Qualifiers**

examples of out-of-service qualifiers are shown on Figure 5-9.

- OOS-DGN = successful completion of diagnose request
- OOS-FAULT = fault detected during diagnostics
- OOS-INITF = unsuccessful initialization process
- OOS-RMVD = unit went OOS due to successful completion of the remove request

*Figure 5-9. Examples of Out-Of-Service Qualifiers*

## Operation and Maintenance Task Hierarchy

---

### **Overview**

---

**Objective of the  
Operation and  
Maintenance Task  
Hierarchy**

The objective of the Operation and Maintenance Task Hierarchy is to provide the technician with a logical organization of the tasks that need to be performed to support continued microcell service.

Some of these tasks have been outlined previously. This section is intended to provide additional information on how the tasks are to be performed.

## Overall Task Hierarchy

---

**Scope** Tasks can be essentially allocated between “Site” and “Microcell Equipment”, as shown in Figure 5-10.

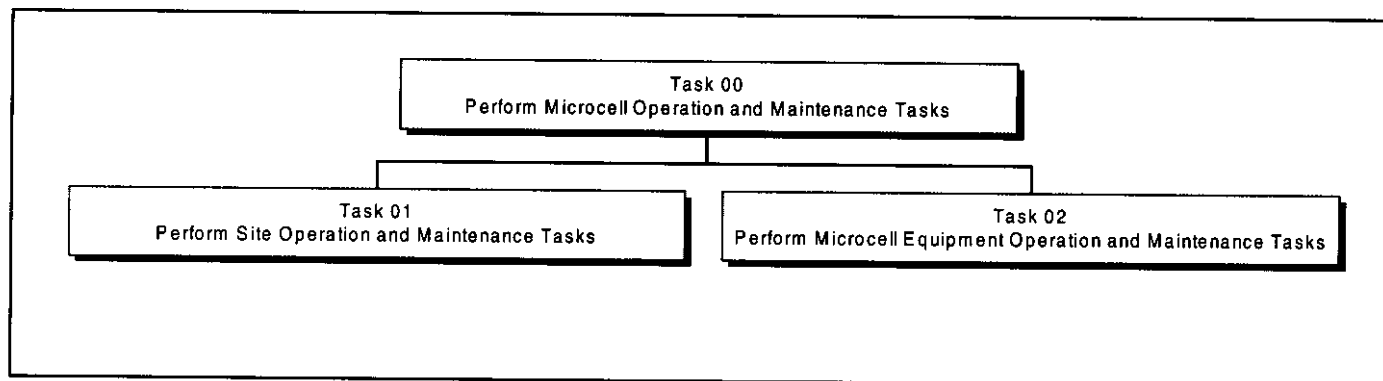
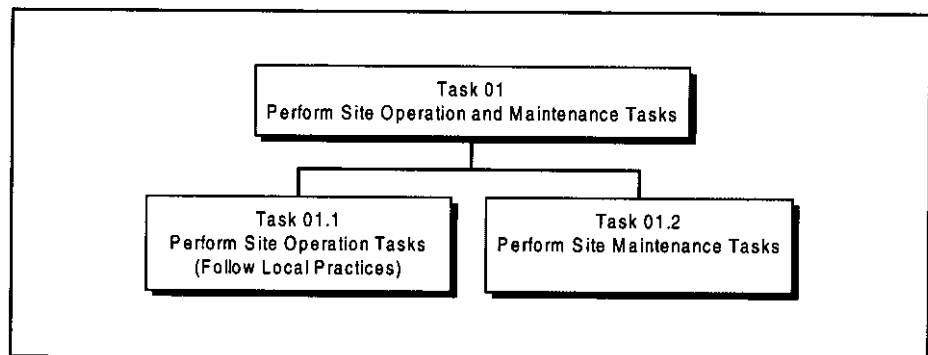

*Figure 5-10. Overall Task Hierarchy*

## Site Operation and Maintenance Tasks

---

**Scope** The hierarchy of the site tasks covered in this material is shown in Figure 5-11. These tasks are those that are directly related to microcell functioning. They exclude ancillary tasks such as ground maintenance, or tasks that are usually performed by other personnel, such as installation. Operation tasks are usually performed according to local practices, while maintenance tasks usually follow recommended procedures.

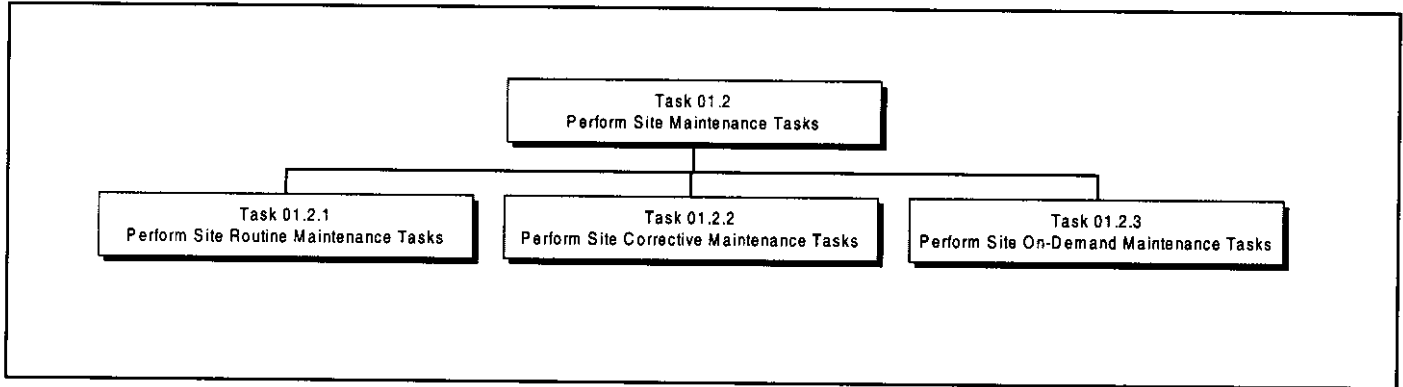

*Figure 5-11. Site Operation and Maintenance Tasks Hierarchy.*

# Site Maintenance Tasks

---

**Hierarchy** Site maintenance tasks can be allocated between routine, corrective, and on-demand , as shown in Figure 5-12.



*Figure 5-12. Site Maintenance Tasks Hierarchy*

# Site Routine Maintenance

**Definition** Site routine maintenance is defined as the group of tasks that support day-to-day service in the absence of any incident. These tasks are summarized in Figure 5-13.

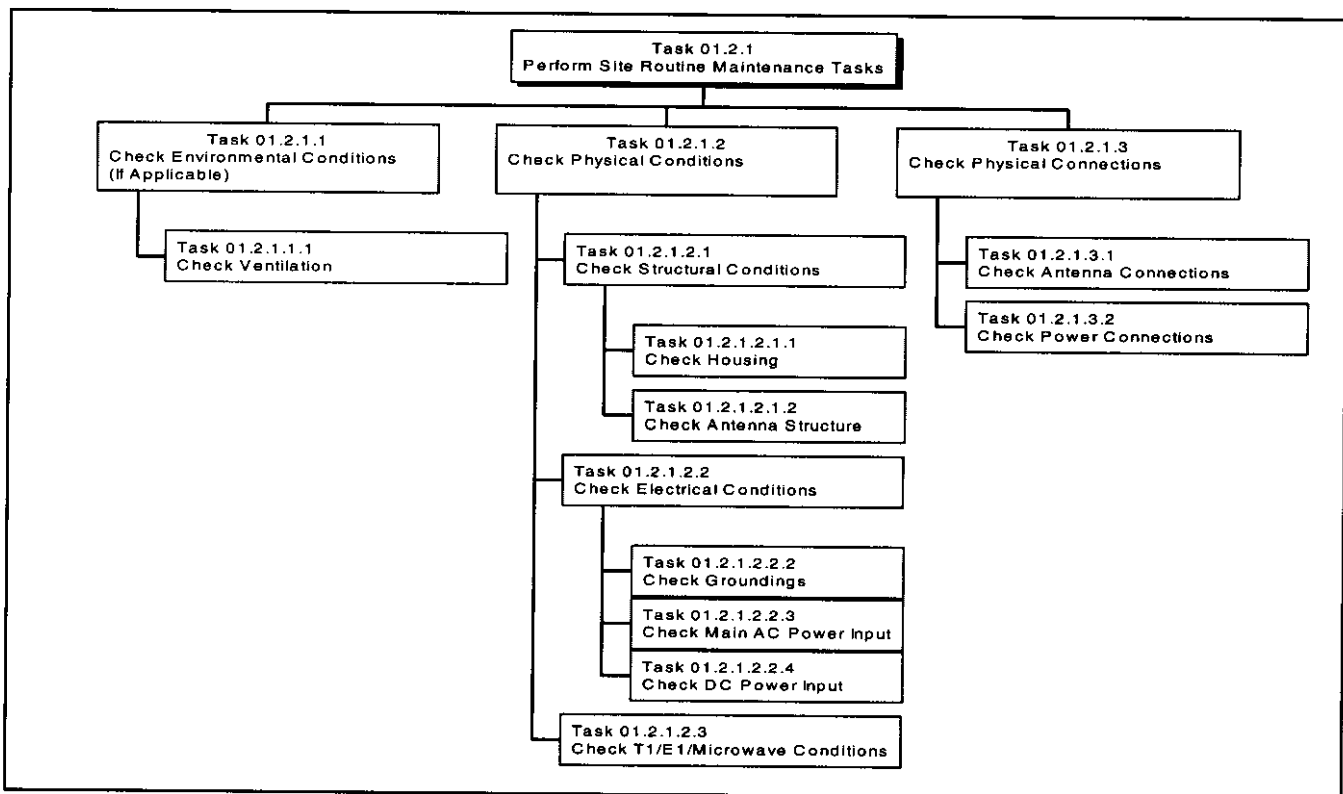

**Figure 5-13. Site Routine Maintenance Task Hierarchy.**

**Scope** Site routine maintenance tasks include:

- Checking on environmental conditions of the microcell to ensure that it is adequately protected from the elements (such as checking the integrity of seals), and that there is no obstruction to the passage of cooling air (clean cooling fins and clear fans and ventilation path for microcells equipped with cooling fans).
- Checking on the physical status of the microcell to ensure that it is in a structurally sound environment, and that external electrical connections are in good condition. An example of a structural check is to verify anchoring of the microcell to its supporting structure.



# Site Corrective Maintenance

**Scope** Site corrective maintenance tasks remedy identified deficiencies. These tasks are outlined in Figure 5-14.

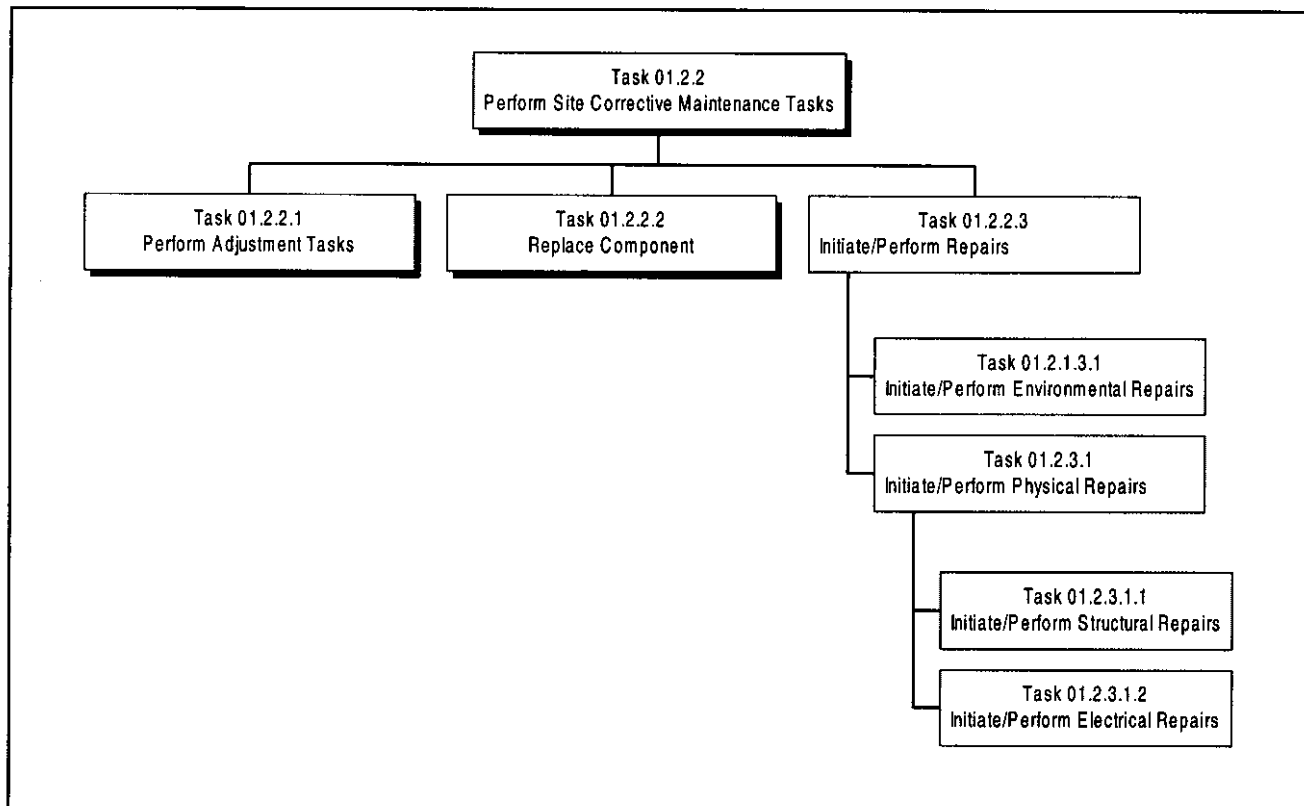

**Figure 5-14. Corrective Site Maintenance Task Hierarchy**

**Examples of Tasks**

Examples of site corrective maintenance tasks include:

- Adjusting a physical condition, such as tightening a microcell frame anchor.
- Replacing a component, such as a leaking frame seal.
- Depending on the nature of the required corrective action, performing actual repair or initiating such a repair through a third party.

## On-demand Site Maintenance

---

**Scope** On-demand site maintenance tasks correspond to activities that are not covered by either routine or corrective maintenance task procedures, but are necessary to proper functioning of a microcell. These tasks are shown in Figure 5-15.

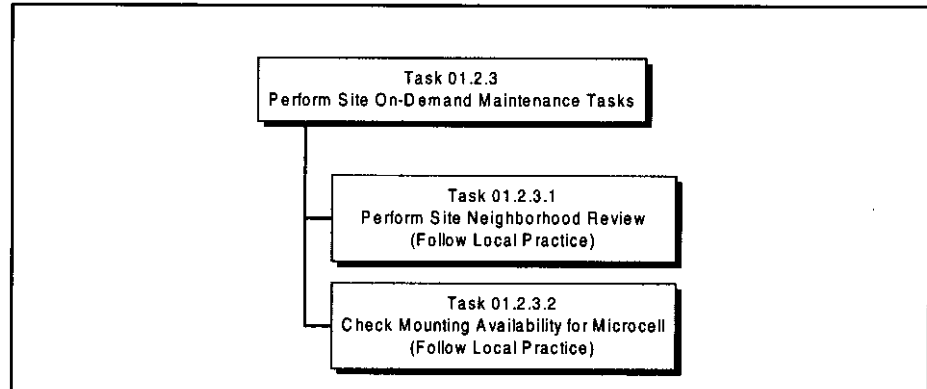

*Figure 5-15. Site On-demand Maintenance Task Hierarchy*

**Example** An example of such a task is the reporting and documentation of changes in the microcell physical environment, such as the construction of a new building that may invalidate earlier RF Engineering assumptions. Such tasks will usually be dictated by local practices.

## Cell Site Equipment Operation and Maintenance Tasks

---

**Scope** Cell site operation and maintenance tasks cover activities required to ensure actual functioning of the microcell, as shown in Figure 5-16.

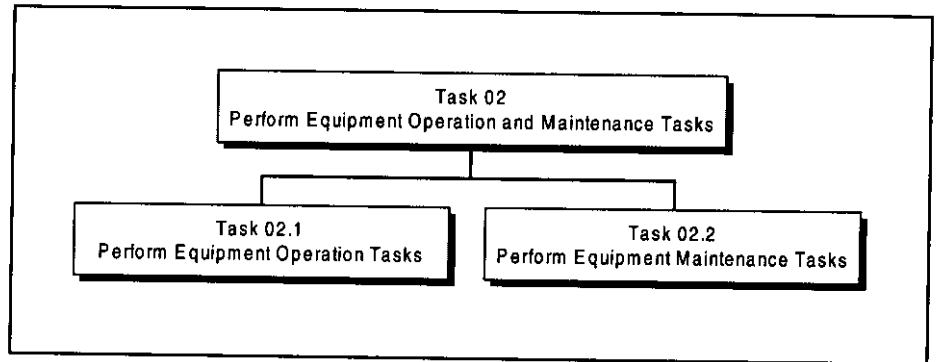

**Figure 5-16. Cell Site Equipment Operation and Maintenance Task Hierarchy**

## Cell Site Equipment Operation

**Scope** Cell site equipment operation covers the activities that support the use of the microcell, and are outlined in Figure 5-17. These activities do not relate to the actual “running” of the individual pieces of equipment.

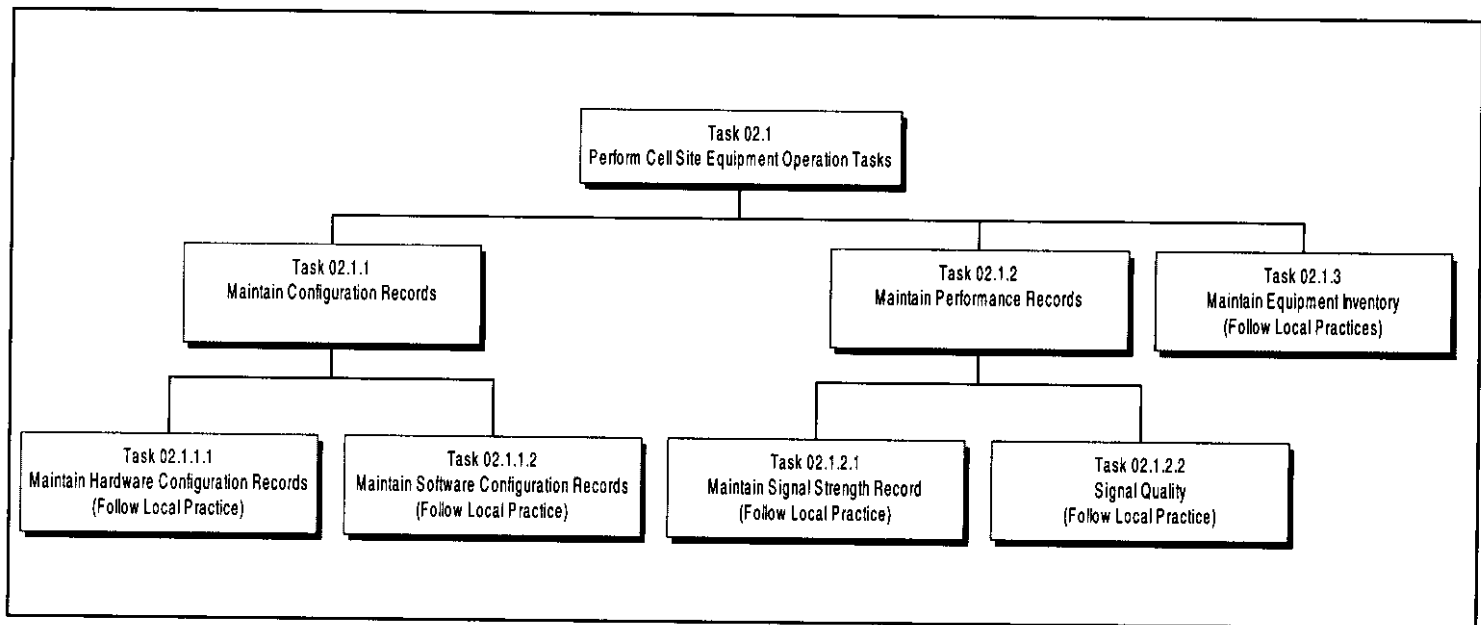

**Figure 5-17. Cell Site Equipment Operation Task Hierarchy.**

**Description** Cells site equipment operation tasks are essentially related to the maintenance of operating records for the microcell. They are to be performed according to local practices. In particular, they should follow specific procedures for collection, storage (usually at the Switch site), and retention. These tasks include:

- Maintenance of microcell configuration records, for both hardware and software. These records are useful in isolating the source of microcell malfunctions that may be caused by mismatch between software releases and installed device configuration.
- Maintenance of microcell performance records, specifically those related to signal quality and signal strength. These records may be useful in identifying a slow degradation in microcell performance.
- Maintenance of records related to equipment inventory; in particular, an audit trail of component replacements. Such records can prove useful in diagnosing repeated microcell incidents.

# Cell Site Equipment Maintenance Tasks

---

**Hierarchy** Cell site equipment maintenance tasks can be subdivided into routine (or preventive), corrective, and on-demand, as shown in Figure 5-18.

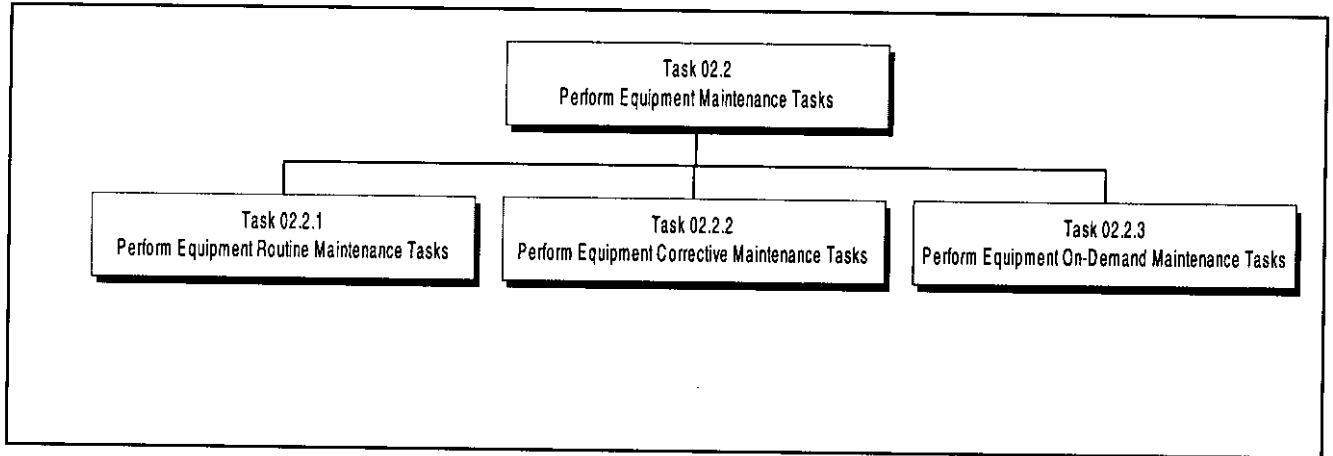

*Figure 5-18. Cell Site Equipment Maintenance Task Hierarchy*

# Equipment Routine Maintenance Tasks

**Scope** Routine maintenance tasks are diagrammed in Figure 5-19.

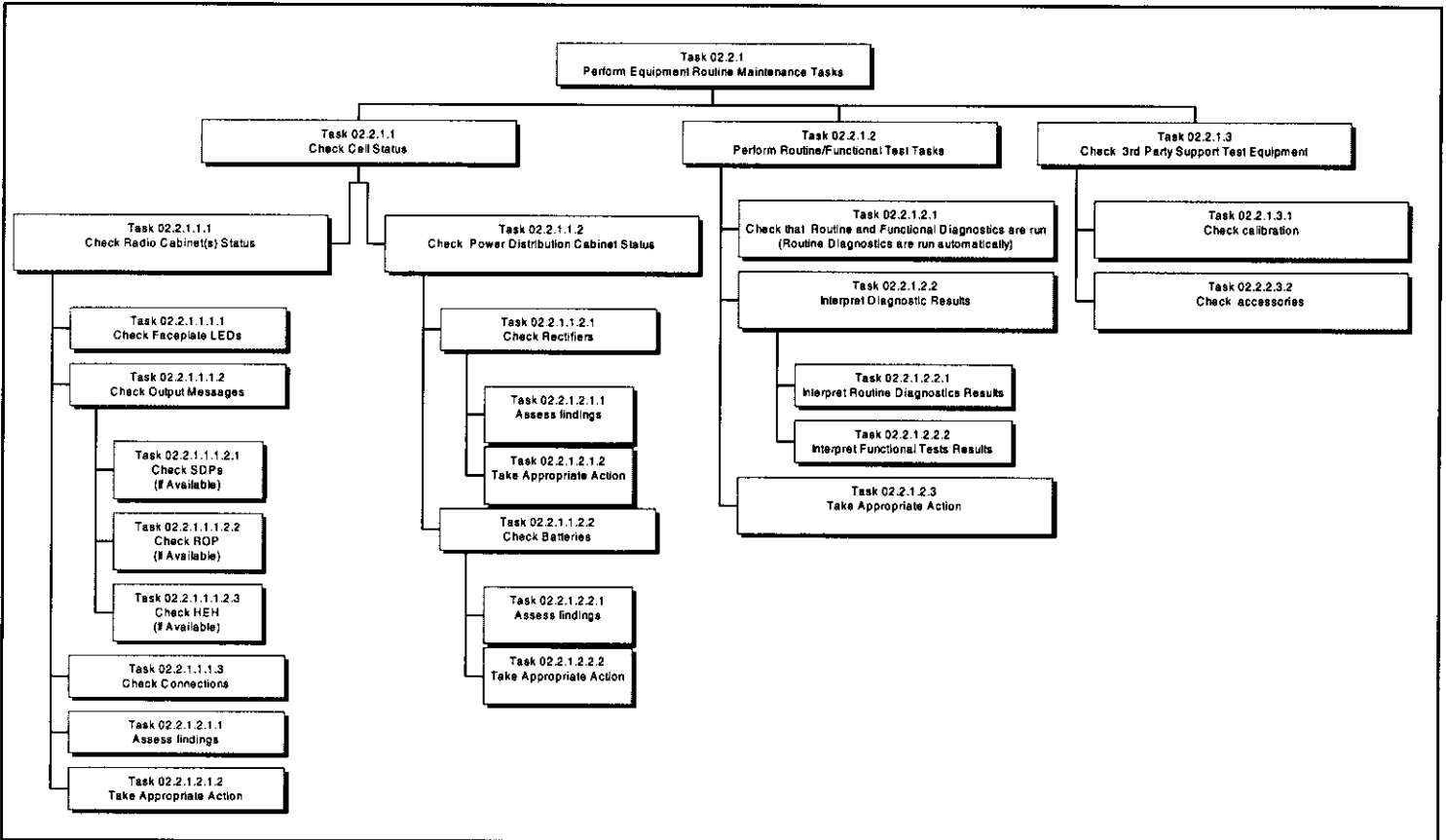

**Figure 5-19. Routine (Preventive) Maintenance Task Hierarchy.**

### Organization of Routine Maintenance Tasks

Routine maintenance tasks can be classified into three categories:

- Checking cell status
- Performing routine diagnostics
- Maintaining test equipment

# Cell Site Equipment Corrective Maintenance Tasks

**Scope** Corrective maintenance tasks are outlined in Figure 5-20.

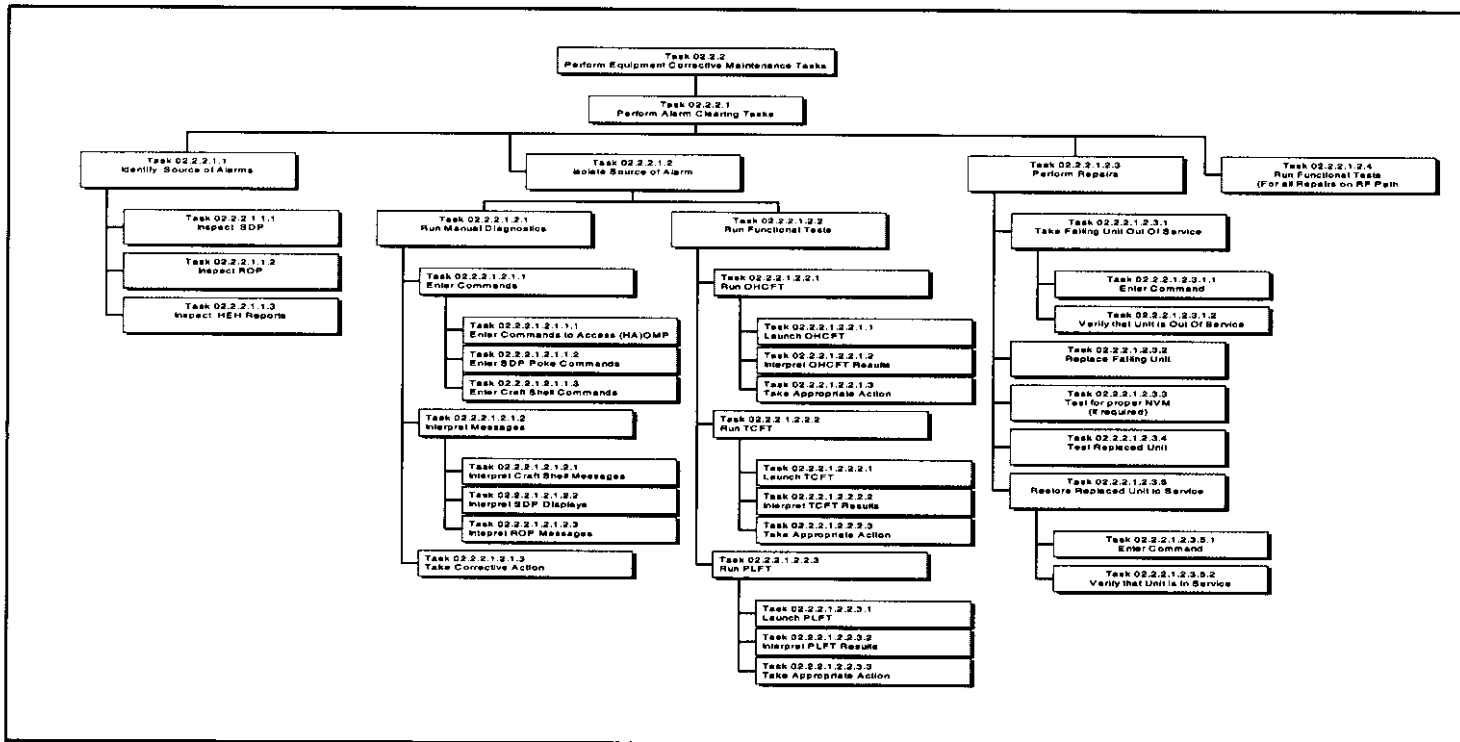

**Figure 5-20. Cell Site Equipment Corrective Maintenance Task Hierarchy.**

### Corrective Maintenance Tasks Triggers

Corrective maintenance tasks are usually triggered by some kind of alarm. Therefore, performing corrective maintenance should proceed according to the following sequence:

1. Identify the source of alarm
2. Isolate the source of alarm
3. Perform necessary repairs

These tasks are reviewed in detail in Chapter 6.

# On-Demand Maintenance Tasks

**Scope** On-demand Maintenance tasks cover activities related to improving the level of service of a microcell, as shown in Figure 5-21.

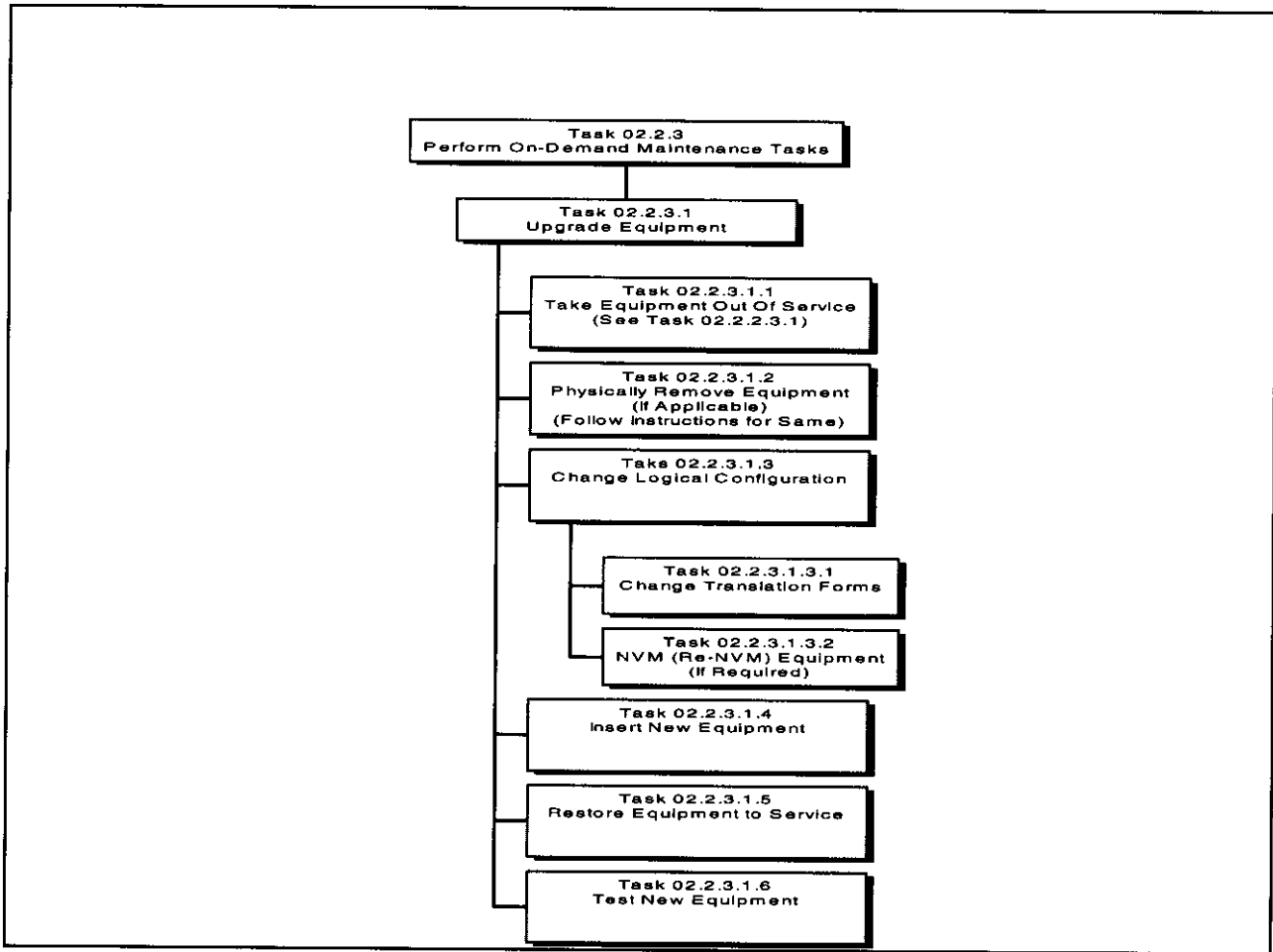

**Figure 5-21. Cell Site Equipment On-demand Maintenance Task Hierarchy.**

**Example** An example of an on-demand maintenance task is a microcell upgrade.



## Required Maintenance Equipment

---

<b>Overview</b>	Equipment required for maintenance: <ul style="list-style-type: none"><li>• Radio and control equipment</li><li>• Power measurement equipment</li><li>• Building and site maintenance equipment</li></ul>
<b>Radio and Control Equipment</b>	Radio and control equipment includes frequency generators and analyzers (test sets), and calibrated connectors and cables.
<b>Power Measurement Equipment</b>	Test sets can be used to measure and analyze RF power. In addition, equipment such as multimeters should be available to check the operation of AC and DC components.
<b>Building and Site Maintenance Equipment</b>	To maintain the microcell site, it will usually be necessary to have tools and equipment for general “handyman” work available at the site.



# 6 Diagnostics

## Introduction

**Objectives** Corrective maintenance procedures are based upon alarm indications and diagnostic test results. Alarm indications, in most instances, are generated by dedicated monitoring circuits which provide identification of trouble and indications of faulty or suspect units. Diagnostic test results are generated by software test routines run on a functional circuit block and, in most instances, identify faults to one or more suspected units within a functional area.

The objective of this unit is to provide an introduction to the principles and tools available to diagnose a cell site. At the end of this unit, the reader should be able to:

- List the steps of a corrective maintenance process
- Perform maintenance procedures

<b>Contents</b>	• Introduction	1
	• Fault Detection and Correction Mechanisms	2
	• Overview	2
	• Diagnostic Tests	4
	• Functional Tests	5
	• Software Audits	6
	• Board Level Self Test (BLST)	7
	• Software Asserts	8
	• Alarms	9

- Alarm Overview 9
- AMP Alarms 10
- Frame Alarms 11
- User Alarms 12
- Cell Site Fault Detection and Recovery Tools 13
  - Overview 13
  - Fault Detection Mechanisms For Manual Recovery 14
- OMP Read-Only Printer (ROP) Monitor 15
- RF Call Trace 16
- Configure Command 17

# Fault Detection and Correction Mechanisms

---

## Overview

---

- Purpose** This section describes the system fault detection mechanisms that are available to identify potential or actual microcell failures.
- Cell Site Housekeeping Software** Cell site fault detection is done through Cell Site Housekeeping Software. Faults such as transmitter failure, power and entry alarms, and speech path conditions are constantly monitored and are automatically reported to the Mobile Switch Center (MSC). In most cases, fault detection, diagnosis, and recovery are automatic.
- The Three Levels of Testing** The microcell is provided with a highly flexible testing and diagnostic facility. Testing and diagnostic are based on the use of a Diagnostic Image (DI), which is a set of testing and diagnostic instructions that is downloaded to the appropriate boards and stored in their respective Non-Volatile Memory (NVM).
- The DI can be downloaded to the microcell in one of two ways:
- From the MSC
  - From the Remote Maintenance Terminal (RMT).
- In the latter case, the DI would have been previously downloaded to the RMT, using either the cell connections or a direct connection to the MSC.
- This choice of download method provides the flexibility to perform on-line and off-line tests and diagnostics. It also provides the facility to download software updates and upgrades without having to necessarily remove the microcell from service.
- Testing and diagnostics for the CDMA microcell are implemented in three stages of activities.
1. The first, board level self test (BLST), is invoked from software that is resident in boot memory for each of the processing components in the CDMA microcell. These tests represent a core set of low-level hardware tests designed to verify the basic functionality of a processor module.
  2. The second stage of testing is performed by board-specific diagnostic software. Tests are downloaded to the microcell either from the MSC or from the RMT.

3. The third and final stage of testing involves functional tests oriented towards performance monitoring. This third stage also provides isolated hardware testing while equipment is on-line and operational. These test functions are controlled from either the MSC or the RMT.

**Summary of the Fault  
Detection and  
Correction  
Mechanisms**

The following mechanisms support fault detection:

- Board self-tests
- Diagnostic tests
- Functional tests
- Software audits

Most faults trigger an alarm that is displayed on the SDP, and may be confirmed on circuit pack LEDs.

## Diagnostic Tests

---

- Overview** Diagnostic tests can be performed on an automatic (error-driven), scheduled, or manual basis.
- Running Diagnostic Tests** Diagnostic tests can be initiated and controlled without operator intervention from the MSC. The cell site performs the requested diagnostic test and returns the test results to the MSC.
- Diagnostic tests can also be initiated manually, either from the MSC or from the RMT. The cell site performs the requested diagnostic test and returns the test results to either the MSC or the RMT.
- In addition to Board Self-Tests, routine diagnostic tests are run on a regularly scheduled basis to verify that the cell site hardware units are operational. Routine diagnostic tests are run once a day; the time of day at which these tests are run is specified in the cell site translations.
- When performing secondary mode or stage 2 and 3 primary mode microcell testing, the cell must be taken out-of-service.
- Using Diagnostic Test Results** Diagnostic test results provide the starting point for clearing diagnostic faults (non-alarm). It should be noted that alarm conditions (such as power, fuse, etc.) can cause diagnostic faults to appear. Therefore, alarm indications should be cleared before attempting to clear diagnostic troubles. In some instances, it may be difficult to relate an existing alarm condition to a diagnostic fault condition.

## Functional Tests

---

**Overview** Functional tests can be performed on a scheduled basis, on demand, or on a manual basis. Functional tests can be initiated and controlled from the MSC or from the RMT; the cell site performs the requested functional test and returns the results to either the MSC or the RMT.

**Running Functional Tests** Functional tests are run on equipment that is in-service. Running functional tests on a regularly scheduled basis (routine functional tests) is a way of checking the integrity of the cell site transmit and receive paths. The frequency of routine functional tests is controlled by the system software and specified in the cell site translations. Unlike routine diagnostic testing, the exact time of day cannot be specified. The test results (pass, fail) are reported to the MSC.

Functional tests can be invoked either from the RMT or from the craft shell.

**Functional Test Types** Functional tests temporarily take control of an in-service hardware unit, test it, and then free it for normal call processing traffic. These tests verify the operation of the following cell site equipment:

- Transmit Path
- Receive Path
- Access Channel
- Paging Channel
- Sync Channel
- Pilot Channel



## Software Audits

---

<b>Software Audits</b>	Software audits can be performed on a scheduled or a manual basis. The audits are initiated and controlled from the MSC; the cell site performs the requested audit and returns the results to the MSC.
<b>Running Software Audits</b>	Software audits detect faults on software that is in-service. Running software audits on a regularly scheduled basis (routine audits) is a way of detecting, confining, and correcting software data errors before the errors adversely affect system performance. When audits detect errors, they recover any lost resources and, if necessary, invoke appropriate system initializations.
<b>Software Audit Frequency</b>	The frequency of routine audits is controlled exclusively by the system software; there is no scheduling translation associated with audits. Audit test errors are reported to the MSC.
<b>Related Documents</b>	Lucent documentation 401-610-078 <i>Series II Cell Site Audits Manual</i> .

## Software Asserts

---

**Description** Asserts occur when software encounters an unusual or unexpected condition. For example, a program calls a software routine and expects three choices but is presented with four. Such errors are reported to assert-handling software on the RCS, which is responsible for formatting assert output messages and sending the messages to the MSC.

**Handling Asserts** When an assert occurs, an assert macro provides the assert-handling software on the RCS with the information it needs to process the assert failure.

Assert messages are detailed software process indications. Their analysis may require escalation to the next level of technical support.

# Microcell Primary Mode for Diagnostics and Testing

---

## Overview

---

### **Objective of Microcell Primary Diagnostics and Testing Mode**

The microcell primary diagnostics and testing mode is the preferred method for supporting the performance of maintenance tasks.

The primary mode uses the Remote Maintenance Terminal (RMT), a software suite that can launch automated testing and diagnostics routines and perform other maintenance tasks, such as generic updates.

### **Purpose of the RMT**

The RMT is an optional Windows N- based software package designed to facilitate microcell common operations and maintenance tasks through a “point-and-click” graphical interface.

The RMT is connected to the microcell through the Maintenance Test port. That port is accessible through a connector in the I/O Module.

## Primary Mode Testing and Diagnostics Framework

---

### Testing and Diagnostics

Testing and diagnostics for the microcell is implemented in three stages of activities.

1. The first, Board Level Self-Test (BLST), is invoked from software that is resident in boot memory for each of the processing components in the microcell. These tests represent a core set of low level hardware tests designed to verify the basic functionality of a processor module.
2. The second stage of testing covers tests that are not handled under the initial self-test suite. This stage is provided via a diagnostic specific software image. Tests are downloaded from either the MSC or the RMT to the CRC and from there to the other processing components for execution directly from RAM.

These tests represent a separate diagnostic software load, that is a diagnostic image which is independent of the system call processing generic. They are intrusive in nature, and require that the cell equipment is "off line."

The same download and test interface can be provided by the Remote Maintenance Terminal (RMT) which drives the test interface.

3. The third and final stage of testing involves functional tests, that test functionality which is part of the system call processing generic software.

These functional tests are oriented towards performance monitoring. They also provide isolated hardware testing while the remainder of the equipment is on-line and operational. These test functions are similar to those provided by the AUTOPLEX framework. They are controlled via interactions from the MSC, or locally via the test port interface at the CRC. The RMT communicates with the on-line CDMA microcell via messaging, and provides the environment with which to monitor microcell activity.

The goals of the Stage 3 functional tests are to monitor system performance characteristics, and to report trends or conditions that may indicate an equipment failure. They also provide a means of creating high level operating test modes, e.g., establishing a connection to a test mobile, concurrent with commercial call processing activity.

These functions are not expected to indict specific modules in the equipment, but rather to determine operational viability at a high level. A failure indication from the Stage 3 functional tests indicates the need to invoke a more intrusive diagnostic to verify a hard failure, and to localize the problem to a Field Replaceable Unit (FRU). These functions can be run from either the MSC or via the test port interface.

## Performing Maintenance with the Remote Maintenance Terminal

**General Appearance** The RMT is represented by a Graphic User Interface as shown in Figure 6-1.

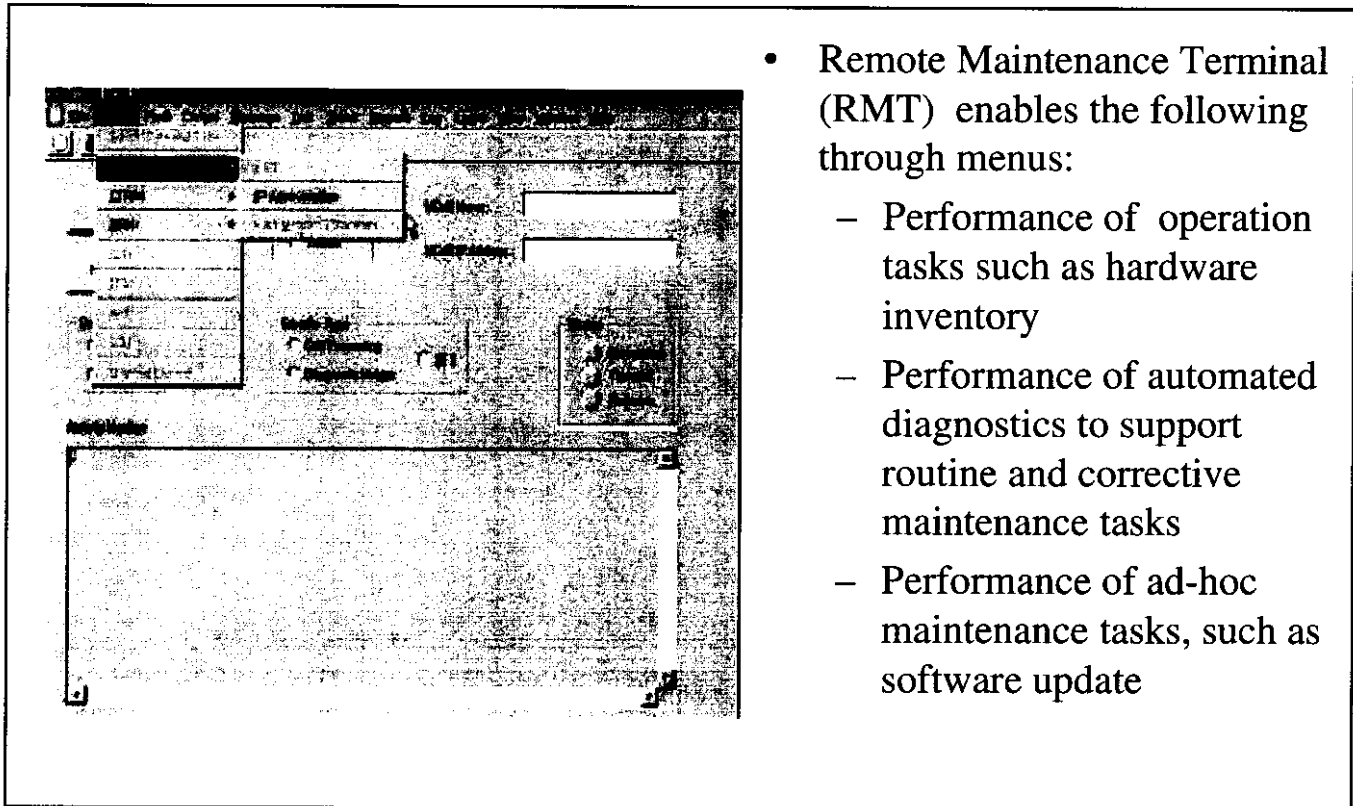

*Figure 6-1. RMT Start Up Screen*

**Using the RMT** As indicated in Unit 3, the RMT is a multipurpose device with menus that enables the following:

- The support of microcell operation by performing tasks such as configuration inventory
- The performance of maintenance tasks, including routine diagnostics and software updates

For the RMT to be operational, the RMT software needs to be installed on an NT platform (e.g., a laptop computer running under Windows NT), together with a communication software, such as Procom Plus. Connecting the RMT to the MSC involves the following operations:

1. Physically connect the RMT platform to the microcell's Craft Interface access ready jack.

2. Establish communication with the Mobile Switching Center (MSC) through a communication software installed on the laptop.
3. Launch the RMT by double-clicking on its icon on the NT desktop.
4. Enter the microcell's address as required.
5. Press Enter.

The RMT should be operative.

## Board Level Self Test (BLST)

---

**Overview** The Board Level Self Tests (BLSTs) represent a portion of the *FLEXENT* microcell diagnostic design. These tests are executed during either board power-up or board level reset. BLSTs verify as much circuit pack functionality as can be accomplished in a stand-alone environment.

**General Description** During a BLST, all the processor LEDs are on. Upon conclusion of a BLST, failures are indicated by red LEDs.

Test results from the BLSTs are available in two forms:

- The first is a real time display of the results obtained during execution. Terse information is provided as a character string output to the RMT.
- Test results are also stored and made accessible to the board's main processor during normal operation. This enables direct probing of the boards during In Circuit Test (ICT).

**Boards Tested** BLST automatically tests the following processors:

- CDMA Radio Controller (CRC)
- CDMA Channel Unit 20 (CCU-20)
- Timing Frequency Unit (TFU)
- CDMA Baseband Radio (CBR)
- Transmit Amplifier (for cellular band only)



# Manual Routine Diagnostics -- Alternate Mode

---

## **Overview**

---

### **Objective of the Alternate Mode**

The objective of the alternate diagnostics mode is to provide a backup maintenance solution in cases when an RMT is not available.

### **Comparing Alternate and Primary Diagnostics Modes**

Alternate mode diagnostics correspond to the third stage of the primary diagnostics mode. However, it should be noted that some of the RMT functions and capabilities available in the primary mode may not be available in the alternate mode.

## Outline of Alternate Mode Diagnostics

---

**Overview** Alternate mode diagnostics use *FLEXENT AUTOPLEX* commands to the MSC. These commands are entered through the HA-OMP from a laptop computer connected to the microcell's Craft Interface port.

Alternate diagnostics are performed under operator control. They check on the health of the entire microcell, circuit by circuit.

### Example of Diagnostic Command Sequence

Routine diagnostics provide an example of alternate diagnostics, and require the performance of the following tasks:

- Issuing a stable clear command to ensure that the microcell is using the proper operating parameters
- Invoking selective cell site messages (scsm) to enable the operator to limit the display of ROP messages to only those that relate to the microcell
- Launching routine diagnostics to verify that all circuits are operating properly
- Inhibiting scsm once the routine diagnostics have been run to return the microcell monitoring capabilities to their original status

### Diagnostic Sequence Description

An overview of the sequence of commands necessary to manually launch microcell routine diagnostics is shown in Figure 6-2.

• Checks that all components still function properly. Lengthy process (1 hr or more)	
– <b>init:cell#:sc</b>	Initiate Stable Clear
– <b>alw:cell#,scsm</b>	Allow Selective Cell Site Messaging
– <b>exc:cell#,rtdiag</b>	Perform Diagnostics
– <b>inh:cell#,scsm</b>	Inhibit SCSM
• Output messages: <b>ATP</b> (All Tests Passed) or <b>STF</b> (Some Test Failed, with segment/phase indication)	

*Figure 6-2. Sequence of Diagnostic Command Overview*

### Systems Response

Upon receiving an input command, the system acknowledges the command with one of the following messages:

- IP = Request has been accepted and will be sent to cell site. Output messages will follow.

- RL = Retry later ; system is unavailable.
- NG = Cell site is not equipped with the unit specified in input command.

Once the diagnostics have been completed, the test results (All Tests Passed (ATP) or Some Tests Failed (STF)) are displayed.

### **Interpreting Failing Messages**

To enter commands and interpret failing messages, consult Lucent documentation 401-660-107 *Cell Site Input/Output (I/O) Manual*. For a description of input commands and output messages of the *FLEXENT AUTOPLEX* system., consult Lucent documentation 401-660-101 *Cell Site Diagnostic Test Descriptions*.

# Alarms

---

## Alarm Overview

- Introduction to Alarms** Alarms are the first indication of cell site trouble, indicating one of the following:
- Hardware failure
  - User-defined condition
- Alarm indications can be supplemented by other signs of failures, such as BLST error messages.
- Alarm Indications** The majority of alarm conditions reported to the MSC can be visually identified at the cell site by observing equipment alarm indicators. Some alarm indications are latched (that is, they remain until they are reported). Non-latched alarms may or may not remain long enough to be read and reported.
- Alarm Severity** Alarms are also classified by level of severity/priority of required action:
1. Critical
  2. Major
  3. Minor
- Alarm Reporting** CDMA microcell alarms are reported to the RCS. In addition, some alarms activate an LED display on the appropriate equipment.
- Alarm Scanning** The alarms scanned can be classified as follows:
- Transmit and Receive Amplifier alarms
  - Frame alarms
  - User alarms.

## AMP Alarms

---

- Functional Overview** AMP (Amplifier) alarms indicate failure in the Receive or Transmit amplifiers.
- Fault on the LNAs (2 units)- A single lead from each LNA indicates whether the DC drive current is outside of the nominal window. A current lower than the window could indicate an open circuit failure within the LNA; too high of a current may indicate an input signal overdrive or a short circuit failure.
- Transmit amplifier alarms indicate a failure condition in the Tx amplifier that impacts call transmission capability.
- Alarm Details** System software will automatically block calls to the microcell if a critical alarm is received from the Transmit amplifier.

## Frame Alarms

---

**Overview** Frame alarms indicate failure of Power Converter Units (PCU) and provide intrusion indication.

- Alarm Details** There are six frame alarms which are listed below:
- Five Power Converter Unit (PCU) alarms to signal the following failures:
    - DC output failure
    - AC input failure
    - Low battery voltage
    - High battery voltage
    - PCU overtemperature
  - One door (intrusion) alarm

## User Alarms

---

- Overview** User alarms are provided for use by the service provider to report cell site alarms that are not triggered by the microcell itself.
- Alarm Description** User alarm points are external to the microcell and their lines are surge protected.
- Since they connect to external equipment, these user alarms are electrically isolated from the RFDU circuitry. They are two-lead current loops where a closed circuit indicates a normal condition and an open circuit indicates an alarm. The user alarm polarity can be inverted by software according to cell translations.
- Pin Arrangement** The user alarm points are identified by the following pins on connector J205 on the Input/Output Module (IOM).
- Pin 1 ALARM1
  - Pin 3 ALARM2
  - Pin 5 ALARM3
  - Pin 7 ALARM4
  - Pin 9 ALARM5
  - Pin 11 ALARM6
- Pins 2, 4, 6, 8, 10, and 12 are used for ground return (FRM\_GND).

# Cell Site Fault Detection and Recovery Tools

---

## Overview

---

**Purpose** This section contains descriptions of the detection and automatic recovery tools that restore the system when faults occur.

**The Fault Isolation Process Tree** The fault isolation process follows a systematic top-down path with decision points designed to identify likely causes of failure through a process of elimination.

Unlike the individual diagnostic functions that target a specific Field Replaceable Unit (FRU), the fault isolation process is performed automatically by the system or under the control of the RMT to isolate a faulty FRU.

**Diagnostic Image and Testing Capabilities** MATERIAL TO BE ADDED



## Fault Detection Mechanisms For Manual Recovery

---

**Trouble Indicators** There are various sources from which the technician can learn about the health of the microcell. Those sources include:

- Alarms
- Cell site housekeeping software
- System performance measurements
- Subscriber complaints
- Drive testing

## OMP Read-Only Printer (ROP) Monitor

---

**Description** The OMP ROP monitor contains a copy of all system communications, thereby forming a history of system operations. All entered input commands and generated system responses (including faults reported automatically by a network element such as the cell site) are stored at the OMP for up to 30 days. This same information is printed at the ROP.

The MSC technician can use the information to track and analyze cell site actions, hardware errors, and audit reports. Each entry has an associated time stamp.

**Report Types** There are two types of output reports: solicited and spontaneous. Solicited reports are generated in response to the commands entered by the technician. Spontaneous reports are generated without any input from the technician; they are initiated automatically by system events or conditions. An example of a spontaneous report is the reporting of a cell site hardware error and corresponding automatic recovery action.

## RF Call Trace

---

**Description** RF call trace (RF CALL) allows a technician to study the strength of the signal received from a selected mobile station as it travels through the cellular system. Signal strength measurements can be collected from as many as eight cell sites. A log of the measurements can be displayed showing both measurements from the serving cell site and the measurements for the strongest non-service cell site. RF call trace is available for AMPS, TDMA, and CDMA mobile stations.

**Call Trace Uses** RF call trace is useful for:

- Performing handoff studies
- Optimizing neighbor lists
- Identifying poor coverage areas
- Studying uplink-downlink balance
- Verifying subscriber complaints

Technicians can use this tool to analyze the mobile RF environment and to fine tune translations (system parameters) relating to handoffs and interference.

**Related Documents** Lucent documentation 401-612-052 *RF Call Trace Optional Feature* and 401-601-055 *CDMA RF Call Trace*.



# 7 Trouble Clearing

## Introduction

### **Objectives of the Unit**

In many instances, diagnostic test results (functional tests, diagnostic image tests, etc.) indicate that more than one unit may be at fault. This is often true in circuits involving both digital and RF functions. Some corrective action situations involve replacing suspect circuit packs. When more than one pack is suspect, the most effective corrective action is to perform the replacement one card at a time, run the diagnostic test, and repeat the process until the trouble is cleared.

The Flexent microcell is designed to minimize trouble-clearing time through the use of the RMT, which automatically runs scripted fault isolation procedures to identify failing components.

Sometimes, corrective action is not so straightforward, because diagnostic definition is lacking and/or suspect units are not easy to replace. Manual trouble isolation procedures (using craft shell commands) are designed to handle such a situation.

The objective of this unit is to describe the steps of a trouble-clearing process. At the end of this unit, the reader should be able to:

- Perform trouble clearing
- Enter the commands required for the isolation of a failing component.

### **Contents**

- Introduction 1
- Fault Isolation Strategy (For CTRM-equipped microcells) 3

• The Fault Isolation Process	4
• Trouble Clearing TFU Alarms	6
• Trouble Clearing CRC Alarms	7
• Trouble Clearing CCU Alarms	8
• Trouble Clearing the CBR	9
• Trouble Clearing Amplifier Alarms	10
• Trouble Clearing the CRTM	11
• CTRM Measurement Fundamentals	12
• Overview	12
• CTRM Function	13
• Functional Tests using MOST	14
• Testing Overhead Channels	15
• Testing Overhead Paths	17
• Testing Traffic Paths	19
• Performance Measurements	21
• System Performance Measurements	21
• Service Measurements	22
• Plant Measurements	23
• Voice Channel Selection Activity Measurements	24
• Power-Level Measurements	25
• Performance Measurements	25
• System Performance Measurements	25
• Subscriber Complaints	26
• CTRM Traffic Path Functional Test	27

# Fault Isolation Strategy (For CTRM-equipped Microcells)

---

## **Introduction**

---

**Purpose of the Fault  
Isolation Strategy**

The purpose of the Fault Isolation Strategy is to automatically isolate a faulty Field Replaceable Unit (FRU).

**Fault Isolation Methods**

Two methods are available for fault isolation:

- Primary Method, using the RMT
- Alternate, by connecting to the MSC.

## The Fault Isolation Process

---

### **Process Overview**

Fault isolation is intended to isolate a faulty Field Replaceable Unit (FRU). Fault isolation can be done automatically through the RMT or manually using the alternate diagnostic technique through the MSC.

Procedures followed for automatic fault isolation depend on the availability of a CTRM. The RMT includes an automatic selection of the isolation procedures suitable for the microcell installed configuration.

### **Outline of Approach using the RMT**

The RMT performs testing and diagnostics through a combination of Functional Tests and Diagnostic Image. Fault Isolation using Diagnostic Image can also be run from the MSC.

Testing is done through a top-down process that exercises the individual boards automatically, with the results of the tests being displayed on the RMT screen. Steps are as follows:

1. Simulate conditions that operate the hardware in a manner as close to a normal condition as possible.
2. Detect a faulty module assembly.
3. Perform internal tests designed to segment the system into smaller areas, and detect the faulty area.
4. Repeat until a single module becomes suspect.

In some instances the fault may, at best, be localized at a pair of modules (i.e., at the interface between two modules). Under this circumstance, both modules are tagged as being the location of the fault, although only one of the pair may actually be failing. Running a diagnostic of each of the modules may help in pinpointing the fault.

If the microcell is not be equipped with a CTRM, or the CTRM is unavailable, the alternate method may be used.



### Launching the Fault Isolation Process

Launching the fault isolation process is done by simply clicking on the Fault Isolation entry in the drop down menu under Tests on the RMT task bar, as shown in Figure 7-1.

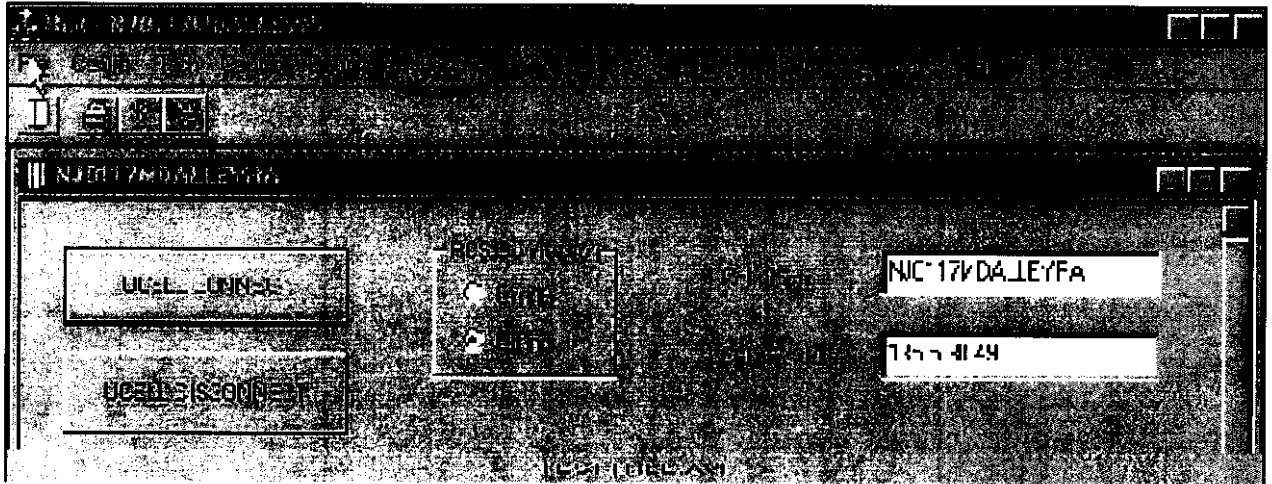

*Figure 7-1. Launching the Fault Isolation Process*

### Outline of Approach using the Alternate Method

When using the alternate method, diagnostics are performed through a combination of craft shell and Status Display Pages.

The general approach will be as follows.

1. Identify the failing area through the SDP
2. Identify the suspect unit through a `dgn:command` and following the signal path.

### Before Performing the Procedures

To expedite diagnostics, the technician should verify that the following items are readily available:

- Microcell configuration records that provide the history of installed components and software
- Microcell maintenance records that provide a history of earlier failures and corrective actions
- Required maintenance equipment, including ESD protection

The following tests assume that the microcell is equipped with a working CTRM unit.

## Trouble-Clearing TFU Alarms

---

MATERIAL TO BE ADDED

## Trouble-Clearing CRC Alarms

---

MATERIAL TO BE ADDED

## Trouble-Clearing CCU Alarms

---

MATERIAL TO BE ADDED

## Trouble-Clearing the CBR

---

MATERIAL TO BE ADDED

# Trouble-Clearing Amplifier Alarms

---

MATERIAL TO BE ADDED

## Trouble-Clearing the CRTM

---

MATERIAL TO BE ADDED

# Performance Measurement Using the RMT

---

## Overview

---

**Purpose of  
Performance  
Measurement**

**MATERIAL TO BE ADDED**



## Performance Measurement Using the Alternate Method

---

### Overview

---

**Purpose of this Section** The purpose of this section is to enable the reader to become familiar with the principles of using the CTRM to perform Performance Measurement Tasks.

**Preparation for Working at the Cell Site** It is assumed that the technician is familiar with the following or that such conditions are otherwise met:

- Wrist grounding straps must always be attached before working on any component or handling the circuit packs (CPs). This is to prevent or reduce electrostatic discharge that may damage or destroy circuit packs containing integrated circuits.
- CPs must be handled by the edges and the faceplates to avoid damaging contacts and deforming components.
- Power-down the failing unit (when required), re-seat CPs, power-up the unit, and repeat diagnostics when an initial Some Test Fail (STF) message is received to verify the corrective action.
- CP must be replaced one at a time when several are suspected, then replace the next questionable CP, and repeat the diagnostics.
- Faulty CPs are tagged with office location, mounting location, diagnostic phase and test that failed, and date removed.
- All test equipment is known to be calibrated and functioning properly.
- A replacement unit or CP is known to be in good condition.
- The technician knows how to operate the test equipment to perform the recommended tests.

## CTRM Fundamental

---

- CTRM Functions** The CTRM makes it possible to test the functionality of the RF train subsystem of a working microcell by emulating a mobile unit. To accomplish this, the CTRM runs a series of tests that enable the technician to:
- Perform fault isolation following a systematic top-down approach using a loopback method.
  - Perform microcell functional tests using a Mobile-Originated System Test (MOST) number. The present software release supports the following functional tests:
    - Overhead (Pilot/Sync/Access (P/S/A)) channel elements, to verify that the P/S/A channel elements (CEs) and paging CEs are working.
    - Traffic channel elements to verify that the microcell traffic CEs are working.
    - Pilot level functional test to check that the power level of the pilot channel (and by inference, the power of the microcell) is set at the right level.

The CTRM can be invoked either automatically (on schedule) or manually.

**Test Sequence** For fault isolation tests, the CTRM establishes loopbacks that progressively isolate portions of the signal path.

For functional tests, the following events take place, roughly in this order:

1. The CTRM tests parts of the microcell, including the RF train, using a battery of test sequences.

A MOST facility in the 5ESS-2000 Switch DCS (the procedure on page 7-15 supports the CTRM as it tests for active and idle CEs in sequence).

2. While testing, the CTRM evaluates the operational aspects of in-service channel elements and antenna sectors (if not an omni-configured microcell) or faces (if an omni configuration).
3. The status of the tests (e.g., pass/fail) may be reported by:
  - Read Only Printer (ROP)
  - Status Display Page (SDP) 2131

## Functional Tests using MOST

---

**Overview** The CDMA functional tests require that the CTRM set up test calls using the MOST feature.

The type of CDMA MOST call described in this unit is originated by the CTRM.

The MSC can distinguish a MOST call type because it has a unique Mobile Directory Number Type value designated via the RC/V subform.

**Relationship of 5ESS-2000 to PCS CDMA Microcell with CTRM**

Software at the RCS determines how the CE forced handoff will function. After the RCS triggers a MOST forced handoff, the CE currently handling the call searches forward through an ordered list of CEs until it finds an idle CE to next handle the call. The RCS then hands off to the selected CE. After executing the handoff, the RCS can either trigger another forced handoff to continue the test session or release the MOST call if all idle traffic CEs have been tested.

## Testing Overhead Channels

---

**Overview** The overhead channel functional test verifies the following channels for each antenna face, or sector, of the cell:

- pilot
- sync
- paging
- access

The testing of the microcell Overhead Channels takes approximately 30 seconds to complete, if successful.

**Test Phases** The overhead channel functional test consists of two phases, listed in the following order:

- 1 Pilot, sync, and paging channel acquisition test verifies that the overhead channel forward path (base-to-mobile path) is functioning.
- 2 Access-paging channel test verifies that the overhead-channel reverse path (mobile-to-base path) is functioning.

**Test Process** The following occurs during overhead channel functional testing:

- 1 The CTRM acquires the pilot, sync, and paging channels, known as the CDMA forward control channels. This is accomplished by locking on a particular CDMA center frequency (carrier) and pilot pseudo-noise (PN) offset.
- 2 During the final portion of the testing, the CTRM calls the CTRM-designated MOST directory number to verify access and paging operation.

**Initiating a Test** The overhead channel functional test may be initiated in one of three ways:

- Manually requested
- Timer-scheduled
- RCS-initiated

**RCS Actions in Case of Failure**

If the RCS senses a failure in an overhead channel or a failure in the CCU carrying the overhead channel, the RCS will automatically migrate the overhead channel to another CE. The RCS does this by selecting and configuring another CE as the overhead channel.

## Testing Overhead Paths

---

**Introduction** The overhead channels are tested with the execution of the FT OC test. The various aspects of the overhead channels are tested as shown in the map.

**Testing the PSA Channel** To do a pilot, sync, and paging channel acquisition test, the following actions occur:

- 1 The RCS instructs the CTRM to connect to a certain antenna path ((Rx0/Rx1) and common Tx.)
- 2 The mobile acquires the pilot, sync, and paging channels for the face
- 3 The mobile transitions to the system idle state
- 4 The RCS queries the status of the CTRM
- 5 To pass, the CTRM must return the system idle state

**Testing Access Paging Channel** To do an access paging channel test, the RCS:

- 1 Instructs the CTRM to initiate a CTRM-designated MOST call
- 2 To pass, the network must be able to set up the call.

**Testing a Forward Path (Phase 1)** To do an overhead channel functional test (forward path), the RCS takes the following actions:

- 1 Selects an antenna path to test
  - 2 Instructs the CTRM to connect to that face
- The CTRM connects to the transmit path and the diversity 0 receive

path.

.....

**3** Queries the status of the CTRM

The CTRM can only go to the system idle state if it acquires all three (pilot, sync and paging) forward control channels. If the CTRM never responds to the status query or returns a status other than system idle, the overhead channel functional test reports that it a failure and then aborts.

.....

**4** The CTRM returns the mobile idle state to the RCS, indicating that the CTRM has acquired the pilot, sync, and paging channels

**Testing a Reverse Path  
(Phase 2)**

Once it confirms that the overhead-channel forward path is functioning, the RCS tests the overhead-channel reverse path (performs the access paging channel test). The following sequence of events occurs:

.....

**1** The RCS instructs the CTRM to dial the CTRM-designated MOST directory number

.....

**2** The CTRM:dials the MOST directory number

.....

**3** The P/S/A CE for the selected microcell receives an “over the air” origination message from the CTRM and passes the message to the RCS

.....

**4** The RCS

- instructs its page CE to acknowledge the CTRM origination. The page CE sends an “over the air” acknowledgment message to the CTRM
- informs the RCS that the CTRM has originated a call

.....

**5** The RCS instructs the CTRM to release the MOST call

.....

**6** The CTRM releases the call.

## Testing Traffic Paths

---

### What is Traffic Path Testing

The traffic path functional test verifies that a CDMA traffic path can be established and maintained through every active and idle traffic CE on every antenna face, or sector, of the cell. A CE configured as a traffic channel contains the necessary circuitry to process one CDMA traffic channel. The RCS repeats the MOST call origination and handoff for each antenna face of the cell.

The testing time of one antenna face varies from less than one minute to more than three or four minutes, depending upon how many idle traffic CEs are available to the antenna face.

### Testing a Traffic Path

To do traffic path functional test, the RCS does the following:

---

**1** Selects an antenna face and then performs an overhead channel functional test on that face

---

**2** Instructs the CTRM to dial the CTRM-designated MOST directory number to test the access-paging portion of the overhead channel test

**Result** The RCS continues to Step 3 only if the overhead channel test passes

---

**3** Requests message and subscriber validation to the MSC, which:

**Result** Identifies the call as a CTRM-designated MOST call during digit analysis and terminates the test call to the MOST source at the DCS sends a traffic-channel assignment message to the RCS and also sets up the proper speech handler connections at the DCS

---

**4** Instructs a CCC to select a specific traffic CE available to the antenna path being tested to handle the CTRM origination, and also sends a channel confirmation message to the MSC, which completes the call path through the DCS ( the MOST low tone is received by the CTRM)

---

**5** Queries the status of the CTRM. The CTRM returns the traffic channel state to the RCS, verifying that the CTRM is in the talk state



- .....
- 6** Instructs the CTRM to send a certain 3-digit feature code to trigger the MOST forced handoff function. The CTRM sends the feature code, which is received by the RCS as an “over the air” flash-with-information message
- .....
- 7** Sends the message to the MSC, which sends a MOST forced handoff command to the RCS
- .....
- 8** Selects the next CE to which the call should be handed off, and performs the hand off.
- .....
- 9** If handoff succeeded...
- ...The RCS reports the results to the MSC and sends an “over the air” flash-with-information message to the CTRM and updates the global data area for the selected CE with the successful test result
- .....
- 10** If handoff failed...
- ...The RCS reports the results to the MSC and does not send an “over the air” flash-with-information message to the CTRM.

# Performance Measurements Using the Alternate Method

---

## System Performance Measurements

<b>Description</b>	The MSC needs to collect various measurements from the cell site. These measurements contain information about system performance including traffic data and subscriber (mobile) data.
<b>Need for Performance Measurements</b>	Measurements are unique in that they can be used to identify cell-site-related faults that may not be detected by the microcell and the RCS, such as call-processing coverage problems and hardware units having partial performance degradation. For example, catastrophic and severe failures will be detected by the microcell and the RCS, but less severe, service affecting failures may escape detection.
<b>Examples of Performance Degradation</b>	The following problems can cause reduced radiated power (and therefore reduced coverage) without detection: <ul style="list-style-type: none"><li>• Damaged antenna</li><li>• Partial lightning damage to antenna/cable</li><li>• Damaged feeder</li><li>• Damaged, faulty, or waterlogged connectors</li><li>• New (since the microcell installation) buildings, foliage growth, and other obstructions.</li></ul>
<b>Measurement Types</b>	There are four types of measurements collected by the RCS and reported to the MSC: <ul style="list-style-type: none"><li>• Service measurements</li><li>• Plant measurements</li><li>• Voice channel selection activity (VCSA) measurements</li><li>• Power-level measurements.</li></ul>

## Service Measurements

---

**General** Service measurements provide statistical information (cumulative counts) on call traffic, various failure events, and the usage of system resources. The data is used to troubleshoot the system, to evaluate how well the system is operating, and to engineer its growth.

**Collecting Service Measurements** Service measurements can be collected on a scheduled basis (scheduled hourly by the MSC) or manual basis. On the scheduled basis, the RCS continually gathers service measurements and reports the data hourly to the MSC.

At the MSC, the collected data is saved in a series of 24 data files, one file for every hour of the day. The files are overwritten with new data beginning at the start of a new day.

**Related Documents**

- Service Measurements (401-610-135)
- Special Studies Measurements (CIB 117-8A).

## Plant Measurements

---

**General** Plant measurements provide information on the performance of cell site equipment including failure occurrences, failure durations (out-of-service time), audit failures, diagnostic failures, and initializations. The data can be used to evaluate cell site hardware deficiencies and their impact on subscriber service.

The number of failures is the number of times a hardware unit is taken out-of-service automatically. That count does not include manual removals.

**Collecting Plant Measurements** Plant measurements can be collected on a scheduled basis or manual basis. Scheduling of plant measurements is controlled exclusively by the RCS, which automatically reports the data to the MSC every day at the set time.

**Related Documents** MSC Plant Measurements System (254-341-116).

## Voice Channel Selection Activity Measurements

---

**General** Voice channel selection activity (VCSA) measurements provide detailed information about traffic movement within a cellular system by recording the occurrences of a set of predefined call-processing events at specified cell sites. VCSA can also be run in a special mode to collect data only for a single specified mobile. Each record indicates what type of event occurred, the time it occurred, the telephone number of the involved mobile station, and other data. Off-line processing of this data by the AutoPACE system provides information about voice channel selection and handoffs during call processing.

**Collecting VCSA Measurements** VCSA measurements can be collected only if a VCSA study is requested (manual basis). For the time period specified by the user, the RCS gathers VCSA measurements and reports the data to the MSC during and after the measurements are made.

**Related Documents** Performance Analysis and Cellular Engineering User's Guide (401-660-108).

## Power-Level Measurements

---

- General** Power-level measurements (PLMs) provide detailed information about the distribution of power levels detected at a specified cell site. This study can also collect the distribution of noise detected by traffic channels. The data is used by the AutoPACE system to investigate system troubles, add or alter radio frequencies, fine-tune a system, and plan growth.
- Collecting Power-Level Measurements** Power-level measurements can be collected only if a PLM study is requested (manual basis). For the time period specified by the user, the RCS gathers the PLMs and reports the data to the MSC after the study is completed.
- Related Documents** Performance Analysis and Cellular Engineering User's Guide (401-660-108).

## Subscriber Complaints

---

**Description** Subscriber (customer) complaints can be used to help identify problems of poor or reduced coverage, assuming that the problems are repeatable and not due to operator error. There can be a number of reasons why a customer reports less than satisfactory service, including:

- The mobile station or installation is faulty.
- The customer has incorrectly operated the mobile equipment.
- The customer is outside the normal coverage area.
- A cell site fault is evident.
- The customer attempted calls during the down time of the system/cell.

**Drive Testing** Drive testing, which equates to driving a motor vehicle (complete with mobile transceiver) in a specific area of coverage while attempting to complete or monitor mobile calls, is a performance analysis activity that may be used to find service-affecting problems. Drive testing an entire cellular system to find problems is very effective at directly assessing system performance; however, it is very time consuming and expensive. Therefore, system-level drive testing is not normally performed except after a re-tune or major configuration change.

Drive testing may be performed using a normal mobile or a test mobile. The test mobile is virtually identical to a normal mobile but has incorporated an automatic answer and the ability to loop back the line to the cell site. It can also check RF propagation, because the test receiver measures the cell site RF off-air.

**Trouble Isolation** For a system fault involving the cell site, it is important to diagnose whether the fault is from the DCS, the transmission link, the site controller, or the RF. The test mobile is an important tool to differentiate between these categories.

## CTRM Traffic Path Functional Test

---

**Purpose of the Procedure**     If a CTRM is not equipped, skip the procedures in this subsection.

### Procedure 7-1. Procedure

---

- 1     Verify the CTRM is in service.  
.....
- 2     Run the CTRM traffic path functional test. The test should pass on each channel element.

End of procedure

---





# Acronyms and Glossary

## Acronyms

---

- A**
- AC** *Alternating Current*
  - AGC** *Automatic Gain Control*
  - AMI** *Alternate Mark Inversion*
  - AP** *Application Processor*
  - ARCNET** *Attached Resource Computer Network*
  - ASCII** *American Standard Code for Information Interchange*
  - ASIC** *Application Specific Integrated Circuits*
  - ATM** *Asynchronous Transfer Mode*
- B**
- B8ZS** *Bipolar 8-Zero Suppression*
  - BCI** *Bar Code Identifier*
  - BLST** *Board Level Self Test*

- C** **CAS** *Channel Associated Signaling*
- CBR** *CDMA Baseband Radio*
- CCC** *CDMA Cluster Controller*
- CCS** *Common Channel Signaling*
- CCMS** *Common Channel Message Set*
- CCU-20** *CDMA Channel Unit, 20 Channel Elements*
- CDMA** *Code Division Multiple Access*
- CE** *Channel Element*
- CI** *Customer Installation*
- CLEI** *Common Language Equipment Identifier*
- CMD** *Cell Memory Device*
- COGS** *Cost of Goods*
- CRC** *Cyclic Redundancy Check*
- CRFU** *CDMA RF Unit*
- CSR** *Control Status Register*
- CST** *CDMA System Time*
- CSU** *Channel Service Unit*
- CTRM** *CDMA Test Radio Module*

- D**    **dB**   *Decibel*
- dBc**   *Decibel, referenced to the carrier*
- dBm**   *Decibel, referenced to 1 milliWatt*
- DC**   *Direct Current*
- DCS**   *Digital Cellular Switch*
- DLCI**   *Data Link Channel Identifier*
- 
- E**    **ECP**   *Executive Cellular Processor*
- EEPROM**   *Electrically Erasable Programmable Read-Only Memory*
- ESD**   *Electrostatic Discharge*
- ESF**   *Extended SuperFrame*
- EVRC**   *Enhanced Variable Rate Coder*
- 
- F**    **FDL**   *Facility Data Link*
- FPGA**   *Field Programmable Gate Array*
- FRU**   *Field Replaceable Unit*
- 
- G**    **GFCI**   *Ground Fault Circuit Interrupter*
- GPS**   *Global Positioning System*

- H**    **HDB3** *High Density Bipolar-3*
- HDLC** *High Level Data Link Control*
- HDSL** *High Data Rate Subscriber Line*
- 
- I**    **IA** *Intelligent Antenna*
- IF** *Intermediate Frequency*
- I/O** *Input/Output*
- 
- K**    **KHz** *Kilohertz*
- 
- 
- L**    **LBO** *Line Build Out*
- LEC** *Local Exchange Carrier*
- LED** *Light Emitting Diode*
- LIU** *Line Interface Unit*
- LNA** *Low Noise Amplifier*

- M**    **mA** *Milliampere*
- Mbps** *Megabit per second*
- MCC** *Main Cluster Controller*
- MCLA** *Multi-Carrier Linear Amplifier*
- MHz** *Megahertz*
- MS** *Mobile Station*
- MSC** *Mobile Switching Center*
- mW** *Milliwatt*
- 
- N**    **NCTE** *Network Channel Terminating Equipment*
- NI** *Network Interface*
- NIU** *Network Interface Unit*
- NVM** *Non-Volatile Memory*
- 
- O**    **OA&M** *Operations, Administration, and Maintenance*
- OM** *Oscillator Module*
- OMP** *Operations and Maintenance Platform*
- 
- P**    **PAF** *Physical Antenna Face*
- PCU** *Power Converter Unit*
- PN** *Pseudo-Noise*
- POTS** *Plain Old Telephone Service*

- R**    **RAM** *Random Access Memory*
- RCS** *Radio Cluster Server*
- RF** *Radio Frequency*
- RDFU** *RF Diagnostic Unit*
- RFB** *RF Board*
- RIB** *Radio Interface Board*
- ROM** *Read-Only Memory*
- RSSI** *Received Signal Strength Indication*
- RSP** *Radio test unit Switch Panel*
- RTR** *Remote Transmit Request*
- Rx** *Receive*
  
- S**    **SAKI** *Sanity and Control Interface*
- SAW** *Surface Acoustic Wave*
- SCT** *Synchronous Clock and Tone*
- SRAM** *Static RAM*

**T** **TCP/IP** *Transmission Control Protocol/Internet Protocol*

**TDM** *Time Division Multiplexed*

**TFU** *Time/Frequency Unit*

**TSI** *Time Slot Interchange*

**TTL** *Transistor-Transistor Logic*

**Tx** *Transmit*

**U** **UPS** *Uninterruptible Power Supply*

**UTC** *Universal Coordinated Time*

**V** **V** *Volts*

**VIM** *Voice Interface Module*

**Z** **ZCS** *Zero Code Suppression*

## Glossary

---

<b>TERM</b>	<b>MEANING/USAGE</b>
AMI	Alternate Mark Inversion line-coding codes the transmitted marks (1s) as alternating positive and negative voltages on the T1/E1 transmission line; that is, the first mark will be transmitted as a positive voltage, the next mark as a negative voltage. Spaces (0s) are transmitted as 0 voltage. AMI prevents the generation of DC currents on the transmission line. Reception of two consecutive marks of the same polarity is a line error, termed a bipolar violation.
B8ZS	Bipolar 8 Zero Suppression is used to prevent long strings of 0s on the T1/E1 transmission line which could lead to receiver clock regeneration problems. B8ZS replaces strings of eight 0s with a special code containing bipolar violations. The receiver detects this code and reinserts the eight 0s.
CE	The channel element is an ASIC which performs CDMA channel coding and decoding for both transmit and receive directions of a traffic channel, or, alternatively, for one of the overhead channels (pilot/synch/access or paging).
Component	Refers to a circuit pack or other distinct unit within the microcell.
CST	CDMA System Time is an ASCII string representing the current timestamp retrieved by the TFU from the GPS satellite network. CST is synonymous with GPS time, and is the number of seconds elapsed since January 6, 1980, 00:00:00 UTC (uncorrected for leap seconds).



<b>TERM</b>	<b>MEANING/USAGE</b>
CSU	<p>The Channel Service Unit supports two major functions: it serves as an interface between the network and the customer premises equipment (CPE), and it provides an additional set of manufacturer-specific features. The network interface includes:</p> <ul style="list-style-type: none"><li>• DC isolation between the network and the CPE,</li><li>• Optional DC loop-through to CPE for span-provided power of CSU</li><li>• Loopback of the network signal (with regeneration) back to the network</li><li>• Selectable attenuation (Line Build Out) of the signal transmitted towards the network</li><li>• Surge protection on the network side</li><li>• Resistive termination for transmit and receive signal paths</li></ul> <p>Other CSU features differ from one manufacturer to the next, but most include:</p> <ul style="list-style-type: none"><li>• Support for SF (D4) or ESF framing, including a facilities data link interface</li><li>• support for various line coding techniques</li><li>• Detection and reporting (via the facilities data link) of bipolar violations</li></ul>
DS0	<p>A timeslot in the DS0 with a gross transmission rate of 64 Kbps. Robbed bit signaling may reduce the usable data rate to 56 Kbps.</p>
DS1	<p>Refers to the digital facilities used to carry traffic and signaling between the microcell and the RCS/AP. In Release 1 this may be either a T1 (1.544 Mbps) or E1 (2.048 Mbps) transmission line (An E-1 transmission line technically uses a CEPT-1 line rate.)</p>
Flywheel	<p>The TFU relies on the GPS unit to discipline the 15 MHz signal from the OM, and to provide the 1 pulse/second and UTC time signals. If the GPS unit loses lock on the GPS satellites, it relies on the OM to provide a timebase until satellite lock can be reacquired. This reliance on the OM is referred to as flywheeling.</p>

<b>TERM</b>	<b>MEANING/USAGE</b>
HDLC	HDLC processing monitors the received bit stream until a flag character (a string of six ones) is read. It then interprets the following bits as a LAPD frame until a trailing flag character is received. Bit destuffing is performed when indicated, and a CRC check is done on the received frame. The converse is performed in the transmit direction.
LEC	The Local Exchange Carrier provides transmission services to the service provider to allow the RCS/AP to be connected to the remote microcell.
LBO	Line Build Out is a T1 attenuation-level setting within the CSU used to adjust the transmit signal level from the microcell. This prevents overdriving the network repeater or creating crosstalk interference with other circuits within the transmission facility.
NCTE	Network Channel Terminating Equipment terminates the DS1 line at the cell site. This may be the CSU in the Microcell, or if the network provider requires one, a separate piece of line termination, commonly referred to as a Smart Jack.
Network Interface	The demarcation between the LEC infrastructure and the customer premises equipment (CPE). The demarcation may be provided by the CSU, or the LEC may provide a SmartJack (also referred to as an NIU or NCTE). Equipment located at this point is intended to allow the LEC to determine whether transmission problems are within the network itself or the CPE. This equipment therefore usually supports remote-enabled loopback and the automatic transmission of line error reports via the facilities data link.
Packet bus	A high speed (100 Mbps) serial bus used to carry traffic packets and control messages between the MC/LIU and the CCU-16s. Uses IEEE 1394 (Firewire) protocol.
Peripheral bus	A low speed (312 Kbps) serial bus used to carry control messages between the LIU/MC and the cell components. Intended primarily for communicating with non-CCU16 components (CBRs, RFDUs, etc.)

<b>TERM</b>	<b>MEANING/USAGE</b>
Service provider	The entity which purchases the microcell and operates it to provide cellular service to its subscribers (the end users).
ZCS	Zero Code Suppression is an alternative to B8ZS which prevents zero bytes from being transmitted by inverting the 2nd LSB (bit 7) of the byte. This corrupts data, but is acceptable for PCM speech because the bit change is undetected by the listener.

