

OK'd by JX  
6/10/98 - 1:00pm

# CHAIN-DRIVE GARAGE DOOR OPERATORS

With DoorSentry® Infrared Safety Beam

Models XX325, XX333 & XX350

## Assembly and Installation Instructions

THIS OWNER'S MANUAL CONTAINS COMPLETE INSTRUCTIONS FOR THE INSTALLATION AND MAINTENANCE OF THIS GARAGE DOOR OPERATOR SYSTEM. IT SHOULD BE MOUNTED NEAR THE INSTALLATION IN A PROMINENT POSITION

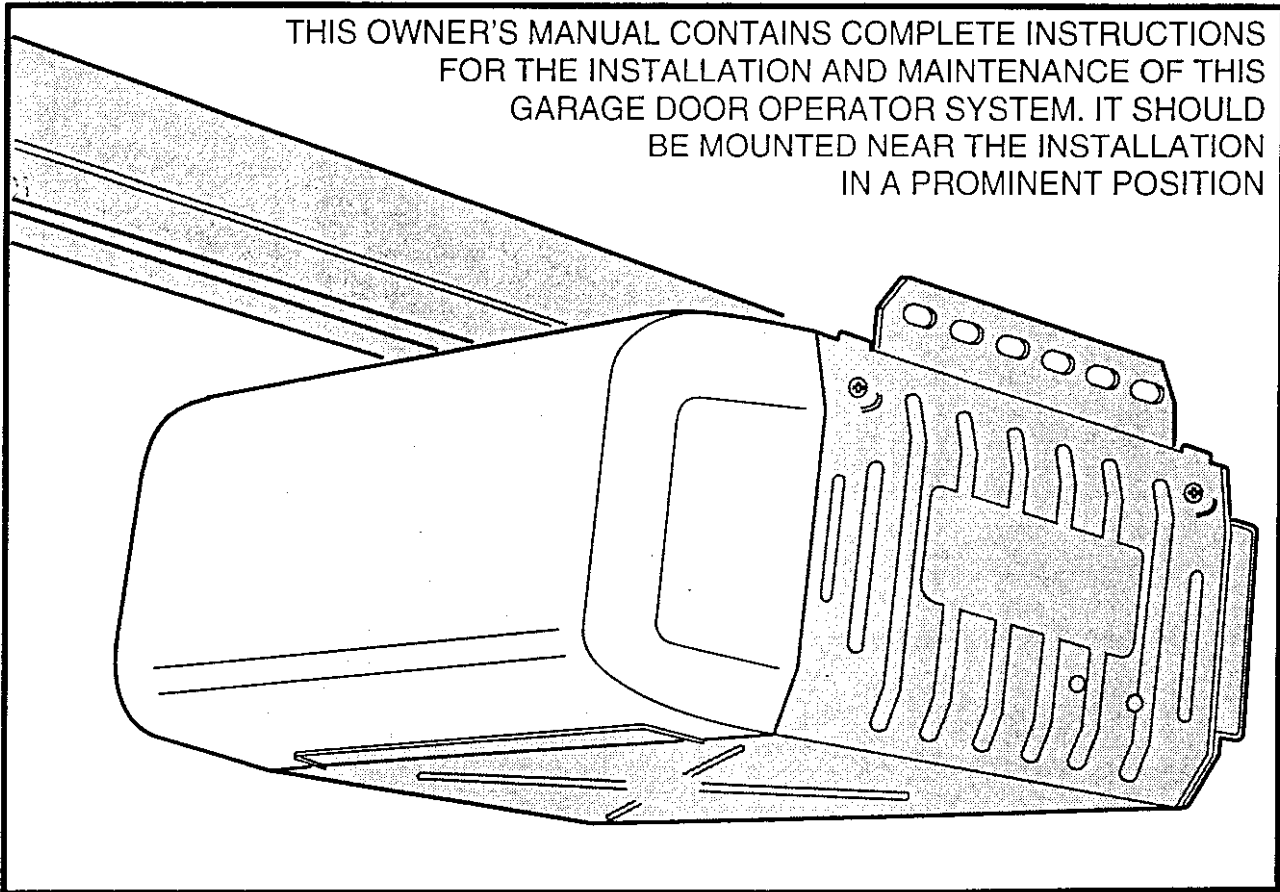

**! WARNING !**

To reduce the risk of injury to persons, install this operator on:  
**SECTIONAL DOOR** if channel box is labeled "XSX" or XST.  
**ONE PIECE JAMB DOOR** if channel box is labeled "XJX" or XJT.

**! CAUTION !**

This door operator will require constant pressure on the wall button to close the door unless the infrared emitter and detector are installed and properly aligned.

# MOORE O MATIC

Quality Garage Door Operators with Linear Radios

(800) 421-1587

# GARAGE DOOR TYPES

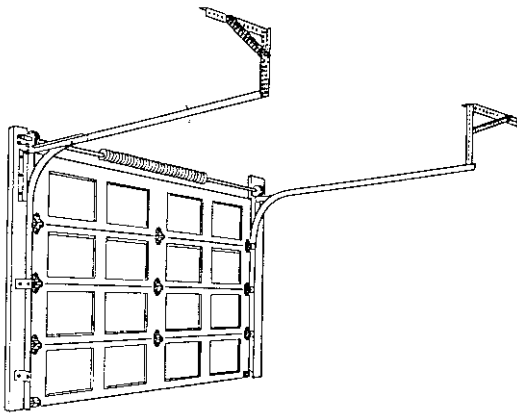

SECTIONAL DOOR

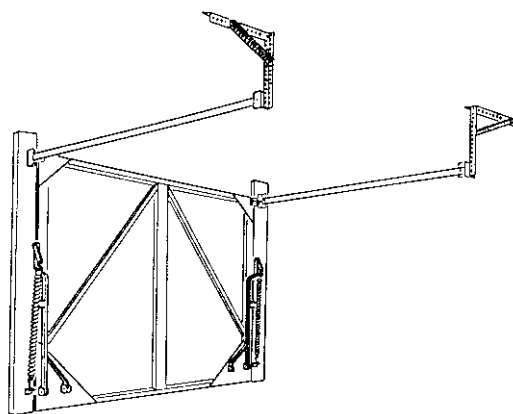

ONE PIECE DOOR WITH TRACK

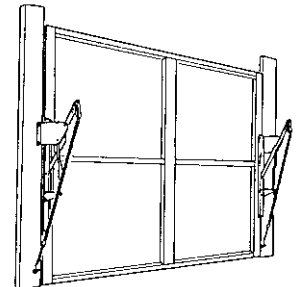

JAMB DOOR

## CHECK DOOR BALANCE

For any electric garage door operator to perform safely, it must be installed on a properly balanced garage door. The weight of the garage door is counterbalanced by the garage door spring(s). The springs must be correctly adjusted and the door hardware must be lubricated and in good working order. **Prior to testing, disable lock assembly and remove all ropes.** Before installing the garage door operator, test the operation of the garage door as follows:

- ☞ Raise the garage door about halfway up. Release your hold on the door and see if the door balances. It shouldn't go up or down on its own.
- ☞ Slowly open the door all the way, then close it all the way. Notice if there is any binding, sticking or rubbing caused by the garage door hardware, track wheels or door frame. The door should travel smoothly.

If the garage door is unbalanced or if the door travel isn't smooth, have a qualified garage door installation professional adjust or repair the door.

### WARNING!

The garage door operator must not be installed and used on an unbalanced door. The operator's internal door pressure sensor will not function properly on an unbalanced door. Risk of serious injury or death may result.

### WARNING!

Garage door hardware (springs, cables, brackets, pulleys, etc.) are under extreme pressure and tension. **DO NOT ATTEMPT TO LOOSEN, TIGHTEN OR ADJUST ANY DOOR HARDWARE UNLESS YOU ARE A QUALIFIED GARAGE DOOR INSTALLATION PROFESSIONAL!**

## HARDWARE IDENTIFICATION

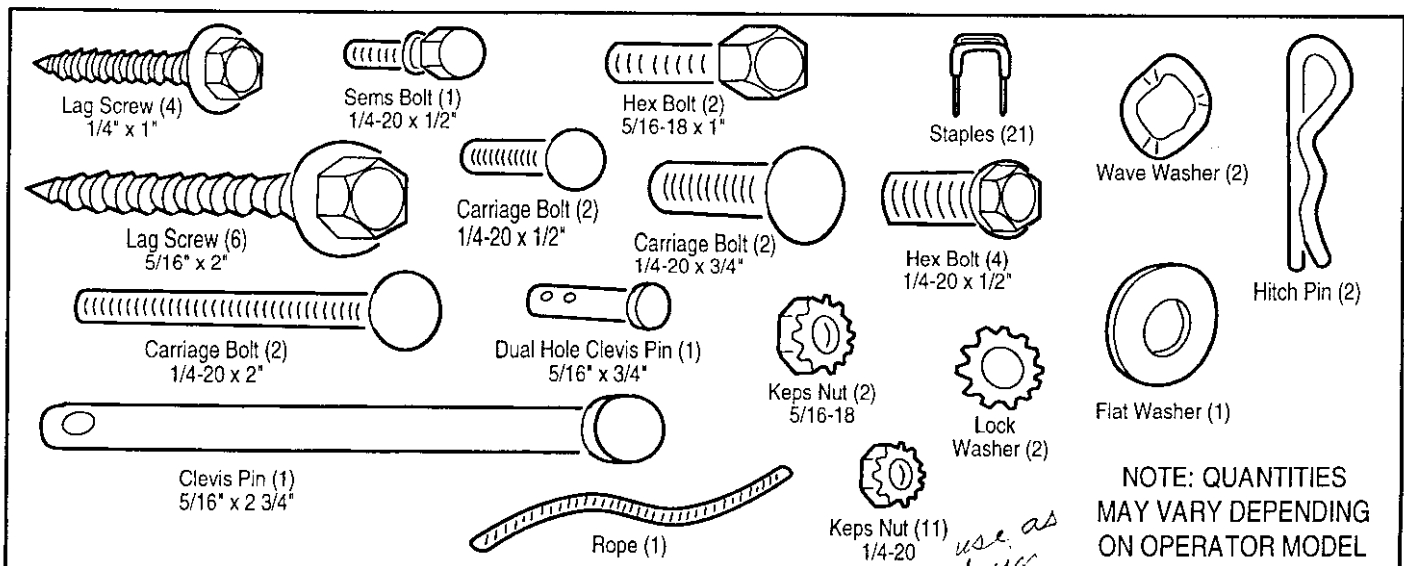

NOTE: QUANTITIES MAY VARY DEPENDING ON OPERATOR MODEL

*use as chain tension gauge*

# OPERATOR PARTS IDENTIFICATION

When you unpack the operator, check to ensure it has not been damaged. Make sure all parts have been received before beginning installation. Read all instructions before starting assembly and installation.

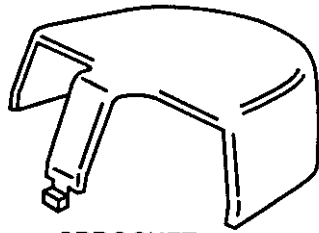

SPROCKET COVER

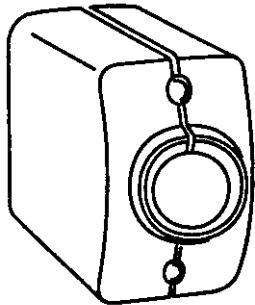

DOORSENTRY DETECTOR

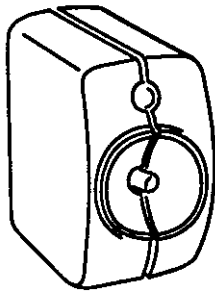

DOORSENTRY EMITTER



2-CONDUCTOR WIRE

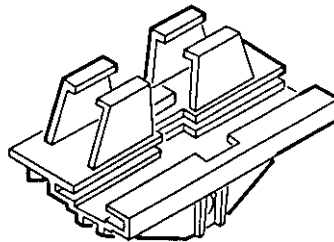

TROLLEY

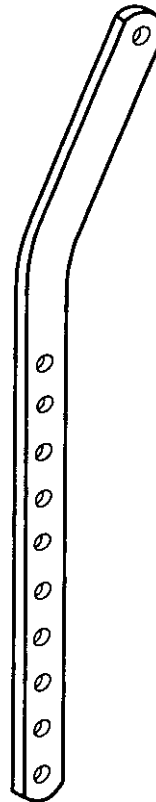

CURVED DOOR ARM



17" STRAIGHT DOOR ARM (SECTIONAL)



PUSHBUTTON

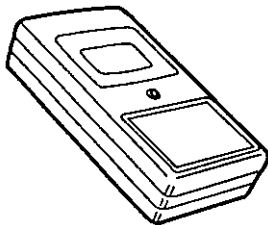

DELTA-3 OR MEGACODE TRANSMITTER

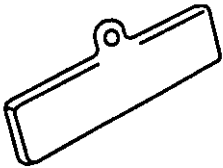

TROLLEY RELEASE HANDLE



2-CONDUCTOR WIRE

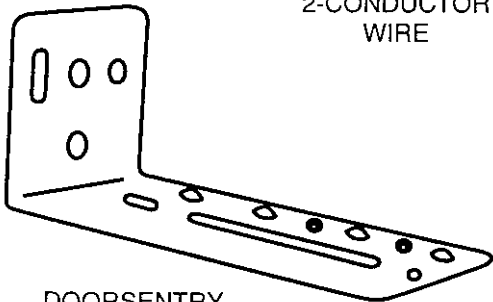

DOORSENTRY MOUNTING BRACKET (4)

PACKED IN CHANNEL CARTON

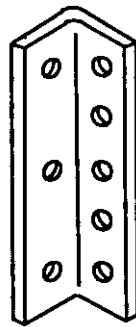

SECTIONAL DOOR BRACKET

OR

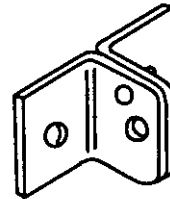

JAMB DOOR BRACKET

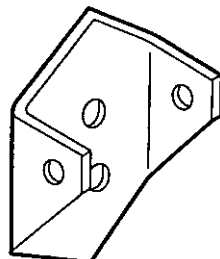

HEADER BRACKET

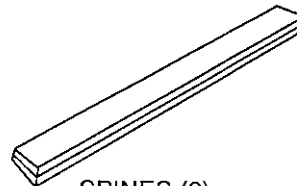

SPINES (2)

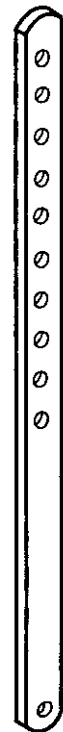

25" STRAIGHT DOOR ARM (JAMB ONLY)

# INSTALLATION STEP 12

## Connecting Operator to Power Source

### **WARNING**

To prevent electrocution or fire, installation and wiring must be in compliance with local electrical and building codes.

#### **Cord and Outlet Connection**

The operator should be connected to a grounded receptacle on the ceiling or near the operator head. If none is available which will accept the grounded operator plug, one should be installed by a qualified electrician. **Do not use an extension cord.**

### **WARNING**

To reduce the risk of electric shock, this operator has a grounding type plug, with a third grounding pin. This plug will only fit into a grounding type outlet. If the plug doesn't fit into the outlet, contact a qualified electrician to install the proper outlet. **Do not change the plug in any way.**

- Plug operator into grounded receptacle.
- When operator is plugged in, a click should sound in the operator and the light should turn on. If light does not turn on, check the power source and light bulb.

#### **Permanent Wiring**

SOME LOCAL ELECTRICAL CODES REQUIRE PERMANENT WIRING TO THE POWER SOURCE THROUGH CONDUIT. FOLLOW THESE STEPS ONLY IF PERMANENT WIRING IS REQUIRED.

- Be sure power cord is disconnected.
- Cut the power cord about 1" from the strain relief bushing on the operator.
- Remove the four side screws and bottom cover of operator.
- Use pliers to remove the strain relief bushing. Discard bushing.
- Remove the outer insulation from the power cord and strip the white, black and green wire insulation back about 1/4".
- Pull white (neutral), black (hot) and green (ground) wires through conduit.
- Connect the conduit to the operator with the appropriate termination.
- Use wire nuts (not supplied) to connect the wires to the matching color wires inside operator head.

**NOTE:** Be sure the wires inside of the operator are clear of the gears and all moving parts.

- Replace the operator cover and four side screws.
- Connect conduit wires to power source at junction box.
- When power is applied to the operator, a click should sound and the light should turn on. If light does not turn on, check the power source, wiring and light bulb.

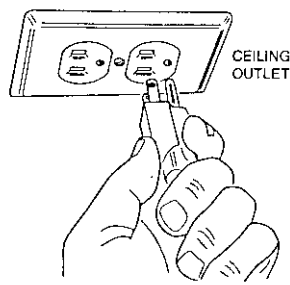

RIGHT

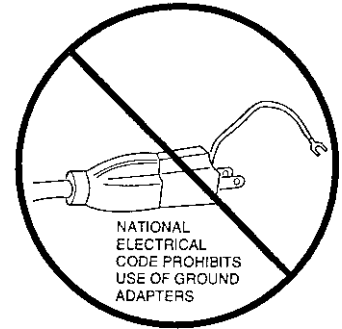

WRONG!

### FOR PERMANENT WIRING ONLY!!!

**BE SURE CORD IS UNPLUGGED!**

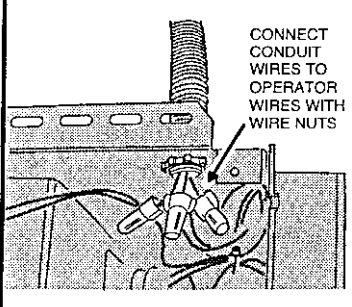
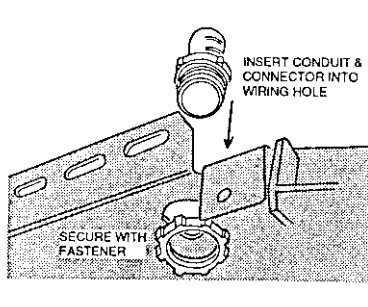
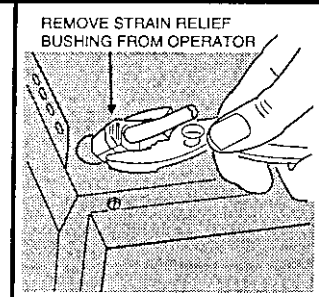
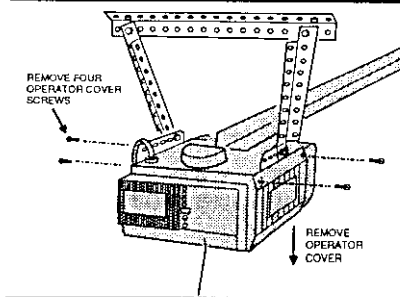
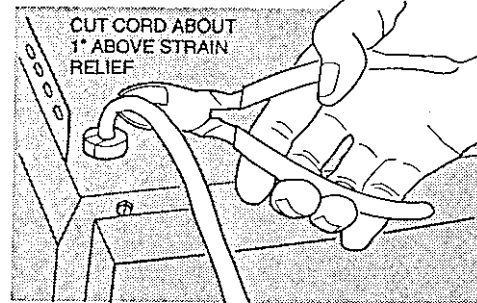

## ADJUSTMENT STEP 2

### Testing the Radio Remote Control



## WARNING



Children operating or playing with a garage door operator can injure themselves or others. The garage door could cause serious injury or death. Do not allow children to operate the radio remote control(s) or the wall station.

A moving garage door could injure or kill someone under it. Activate the operator only when the door is clearly visible, free of obstructions and adjusted properly.

The radio receiver is located in the rear bulkhead of the operator. The small white wire serves as an antenna for the receiver.

More transmitters can be purchased for additional users of the door operator. Before purchasing, check to see if your operator is equipped with MegaCode or Delta-3 radio remote controls.

#### Delta-3 Radio Controls

If the operator is equipped with Delta-3 Radio Controls, the eight position switch on all transmitters must be set to the same code. Only one code can be learned into the receiver. The code should be changed from the factory setting prior to use.

#### MegaCode Radio Controls

MegaCode transmitters are permanently factory coded. Up to 10 MegaCode transmitters can be stored in the receiver's memory.

Programming the receiver.

- Momentarily press the receiver's program learn. The receiver's red programming light will glow if there's room in the receiver's memory for more transmitters. The red light will stay on for about 5 seconds. **A transmitter must be entered while the red light is still on.** Press the transmitter button. The red light will flicker and the operator light will flash once indicating that the receiver has accepted the transmitter.

To remove a transmitter:

- Press and hold the receiver's learn button for 5 seconds or more. **This will erase all of the transmitters stored in the receiver's memory.** The receiver's red programming light will blink, counting the transmitters in memory then blink once as the memory is erased.
- Follow the previous step to re-program all needed transmitters.
- For programming multi-channel transmitters, refer to the instructions supplied with the equipment.

#### Testing

- Before testing the radio control, straighten out the antenna wire so it points down toward the floor.
- Stand clear of the door, press the transmitter button and verify that the operator starts.

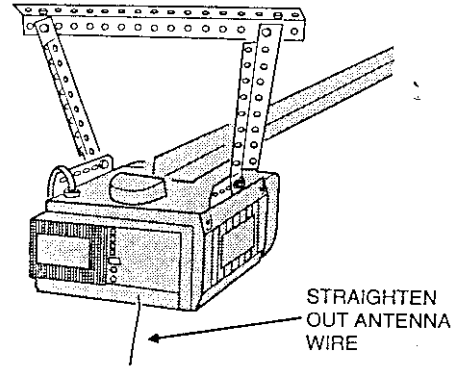

DELTA-3 TRANSMITTER

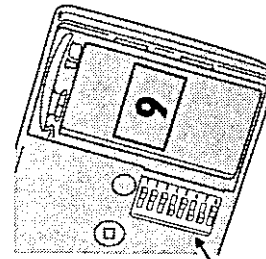

SWITCHES IN ALL TRANSMITTERS MUST BE SET THE SAME

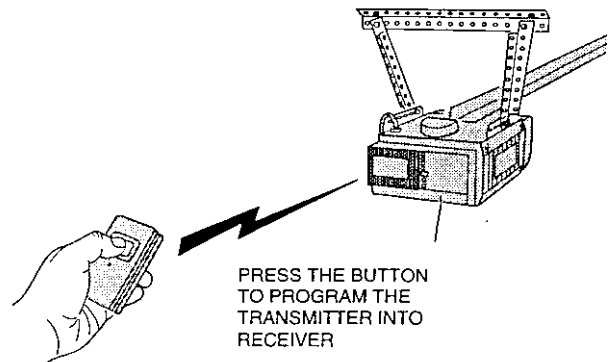
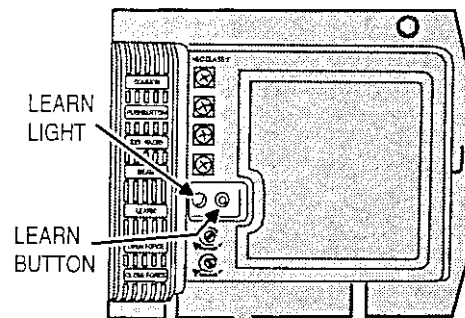

# OPERATOR ACCESSORIES

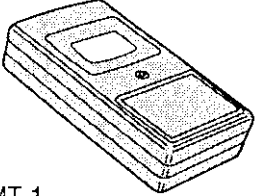
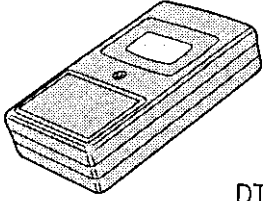
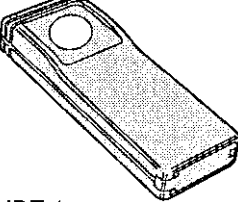
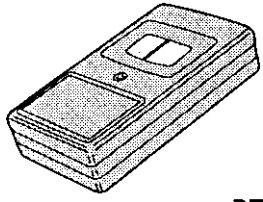
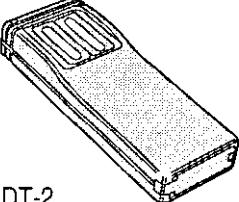
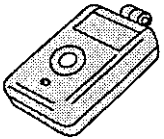
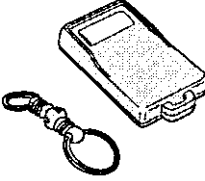
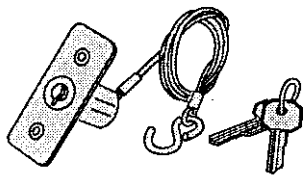
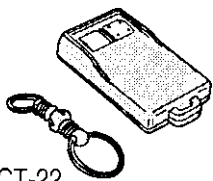
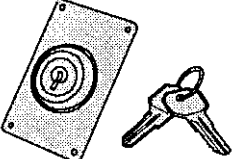
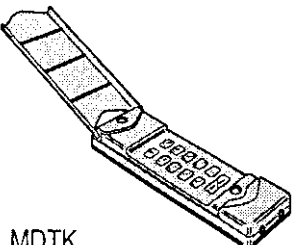
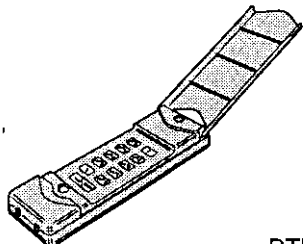
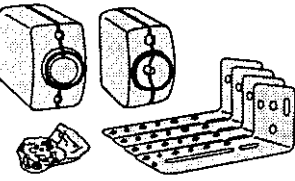
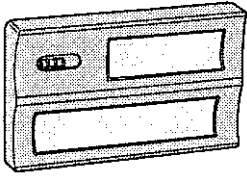
 <p><b>MT-1</b></p>	<p>1-Channel Standard MegaCode Transmitter</p> <p>Controls single garage door operator. 318 MHz</p>	<p>1-Channel Delta-3 Transmitter</p> <p>Controls single garage door operator. 310 MHz</p>  <p><b>DT</b></p>
 <p><b>MDT-1</b></p>	<p>1-Channel Deluxe MegaCode Transmitter</p> <p>Controls single garage door operator MegaCode 318 MHz DX 433 MHz</p>	<p>2-Channel Delta-3 Transmitter</p> <p>Controls two devices. 310 MHz</p>  <p><b>DT-2A</b></p>
 <p><b>MDT-2</b></p>	<p>2-Channel Deluxe MegaCode Transmitter</p> <p>Controls two devices. The top button can be used to control a third device. MegaCode 318 MHz DX 433 MHz</p>	<p>MiniTransmitter</p> <p>Designed to be used with a keychain. Activates one device. 310 MHz</p>  <p><b>MIN-T</b></p>
 <p><b>ACT-21</b></p>	<p>Act-21 Mini Transmitter</p> <p>Designed to be used with the keychain provided. Activates one device. 318 MHz</p>	<p>Vault Door Cable Release</p> <p>For garage doors with no service door. Release operator from outside.</p>  <p><b>VDCR</b></p>
 <p><b>ACT-22</b></p>	<p>Act-22 Mini Transmitter (Two Button)</p> <p>Designed to be used with the keychain provided. Activates two devices. 318 MHz</p>	<p>Key Lock Switch</p> <p>A wired control station outside a garage. Secure from anyone without a key.</p>  <p><b>KLS</b></p>
 <p><b>MDTK</b></p>	<p>MegaCode Wireless Keypad</p> <p>Designed for use with MegaCode radios. Keypad has weather-proof construction, easy to read numbers and is backlit for use at night. 1,000,000 possible codes.</p>	<p>Delta-3 Wireless Keypad</p> <p>Designed for use with Delta-3 radios. Keypad has weather-proof construction, easy to read numbers and is backlit for use at night. 256 possible codes.</p>  <p><b>DTKP</b></p>
 <p><b>SB-3</b></p>	<p>DoorSentry Kit</p> <p>The DoorSentry emitter constantly sends a narrow infrared beam to the detector which will detect an obstacle in the path of the door. The operator will then stop and reverse the direction of travel of the door.</p>	<p>Wall Station</p> <p>Independently controls garage door operator and lights. Vacation switch disables radio for added security. 3 function - 2 wire XX Operator Only!</p>  <p><b>XX-WS</b></p>

# LIMITED WARRANTY

*THE WARRANTOR WARRANTS THAT: The motor on this operator is warranted to the consumer against defects in material and workmanship for Ten years from the date of purchase. The drive train will be free from defects in materials and/or workmanship for a period of:*

**MODEL XX325** - One year

**MODEL XX350** - Five years

**MODEL XX333** - Three years

*All other parts will be free of defects in materials and workmanship for a period of One year from date of purchase. This warranty applies to first retail buyers of new devices. The product must be used in complete accordance with Moore-O-Matic's instructions for installation, operation and care.*

*Warrantor will repair, or at its option, replace, any device it finds that requires service. The device must be sent to the warrantor, at the consumer's expense.*

## **RETURNED FOR REPAIR PRODUCTS:**

*All returns, not going through your local dealer, must be sent prepaid freight with a pre-authorized Return Product Authorization Number (RPA#). This authorization number can be obtained by calling the Technical Services Group at 1-800-421-1587. This number should be clearly written on the outside of the box to speed the processing of your return. Returned product without an RPA# may be refused. Repaired products will be returned via prepaid freight.*

*The consumer must contact the warrantor at the phone number listed above to obtain shipping instructions prior to shipping the device to the warrantor. The warrantor will return the repaired or replaced device to the consumer at the warrantor's cost.*

*Remedies provided by this warranty are exclusive. Implied warranties under state law are limited to a period of one year from the date of purchase by the consumer. This limitation is not valid in jurisdictions which do not allow limitations of incidental or consequential damages.*

*To obtain service under this warranty, the consumer must present a copy of proof of purchase of the device when submitting a device for service.*

*This warranty gives you specific legal rights, and you may also have other rights which vary from state to state.*

## **IMPORTANT !!!**

*Linear radio controls provide a reliable communications link and fill an important need in portable wireless signalling. However, there are some limitations which must be observed.*

- \* *For U.S. installations only: The radios are required to comply with FCC Rules and Regulations as Part 15 devices. As such, they have limited transmitter power and therefore limited range.*
- \* *A receiver cannot respond to more than one transmitted signal at a time and may be blocked by radio signals that occur on or near their operating frequencies, regardless of code settings.*
- \* *Changes or modifications to the device may void FCC compliance.*
- \* *Infrequently used radio links should be tested regularly to protect against undetected interference or fault.*
- \* *A general knowledge of radio and its vagaries should be gained prior to acting as a wholesale distributor or dealer, and these facts should be communicated to the ultimate users.*

# **MOORE O MATIC**

Quality Garage Door Operators with Linear Radios